

2011~2012



PADS AND DISCS
PLAQUETTES ET DISQUES
PASTILLAS Y DISCOS
PASTILAS E DISCOS
PASTIGLIE E DISCHI
REMBLOKKEN EN REMSCHIJVEN
BREMSBELÄGE UND
BREMSSCHEIBEN
KLOCKI I TARCZE
BRZDOVÉ DESTIČKY
A KOTOUČE
FÉKBETÉTEK ÉS
FÉKTÁRCSÁK
BALATALARI VE DISKLERI
Колодки и диски
Δισκόφρενα &
Δισκόπλακες



www.valeoservice.com

*La technologie automobile, naturellement

























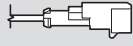













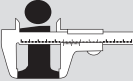





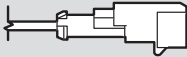

valeo added

Automotive technology, naturally



	EN	FR	SP	PT	IT	NL	DE
	Vehicle	Véhicule	Vehículo	Veículo	Veicolo	Voertuig	Fahrzeug
	Date of vehicle	Période de fabrication	Periodo de fabricación	Data de fabrico	Data di fabbricazione	Bouwjaar	Baujahr
	Page number	N° de page	Número de pagina	Numero da pagina	N° di pagina	Pagina	Seitennummer
	Cancel	Supression	Cancelación	Anulação	Annullamento	Verwijderen	Nicht mehr lieferbar
	Technical information	Caractéristiques techniques	Información técnica	Informação tecnica	Informazioni tecniche	Technische informatie	Technischer hinweis
	Manufacturer reference	Equipementier	Referencia constructor	Referência fabricante	Riferimenti costruttore	Origineel productnummer	IAM-Nummer
	Caliper	Etrier	Pinza	Estribo	Pinza	Remklauw	Bremssattel
	Thickness	Epaisseur	Espesor	Espessura	Spessore	Dikte schijf	Stärke
	Wear indicator	Témoin d'usure (T.U)	Indicador de desgaste	Indicador de desgaste	Indicatore d'usura	Slijtage indicator	Verschleissanzeige
	Sedan	Berline	Berlina	Berlina	Berlina	Sedan	Limousine
	Station wagon	Break	Break	Break	Station wagon	Break	Kombi
	Convertible	Cabriolet	Descapotable	Descapotavel	Cabriolet	Cabrio	Cabrio
	2 doors	Coupé	Coupé	Coupé	Coupé	Coupé	Coupe
	4 X 4	4 X 4	4 X 4	4 X 4	4 X 4	4 X 4	4 X 4
	Solid disc	Disque plein	Disco macizo	Disco maciço	Disco pieno	Massieve schijf	Volle Bremsscheibe
	Ventilated disc	Disque ventilé	Disco freno ventilado	Disco ventilado	Disco ventilato	Geventileerde schijf	Belüftete Bremsscheibe
	Fixing holes number	Ecrou de roue au nombre de	Número de taladros	Numero de pernes	Numero bulloni per ruota	Aantal boutgaten	Anzahl der Befestigungslöcher
	Wheel diameter	Roue d'un diamètre de	Diametro de rueda	Diametro da roda	Diametro della ruota	Wieldiameter	Raddurchmesser
	New part number	Référence nouvelle	Nueva referencia	Nova referência	Nuovo riferimento	Nieuw productnummer	Neue artikelnr.
	Product soon available	Référence bientôt disponible	Referencia proximamente disponible	Referencia previamente disponível	Riferimento disponibile a breve	Product binnenkort beschikbaar	Bald vorhanden
	Available until exhaustion of stocks	Disponible jusqu'à épuisement des stocks	Producto disponible hasta agotar existencias	Produto disponível até final de stock	Riferimento ad esaurimento stock	Zolang de voorraad strekt	Artikel lieferbar solange vorrat reicht
	With	Avec	Con	Com	Con	met	Mit
	Except	Sauf	Excepto	Excepto	Senza	zonder	Ohne
4 WD	4 wheels drive	4 roues motrices	4 ruedas motrices	4 rodas motrices	4 ruote motrici	4 Wiel aangedreven	Vierradantrieb
	Front brake pads	Frein avant	Freno delantero	Travão dianteiro	Freno anteriore	Voorrem	Vorderradbremse
	Rear brake pads	Frein arrière	Freno trasero	Travão traseiro	Freno posteriore	Achterrem	Hinterradbremse
	Handbrake	Frein de parking	Freno de mano	Travão de parque	Freno a mano	Handrem	Handbremse
All engines	All engines	Tous moteurs	Todos los motores	Todos os motores	Tutti i motori	Iedere motorisering	alle Motortypen

	PL	CZ	TU	RU	GR	CN	اللغة العربية
	Marka / Pojazd	Vozidlo	Arac	Автомобиль	Οχημα	车型	آلية ثقيلة أو شاحنة
	Okres produkcji	Datum vozidla	Uretim Tarihi	Выпуск	Ημερομηνία κατασκευής	出厂年份	تاريخ الصنع
	Numer strony	Číslo stránky	Sayfa Numarası	Номер страницы	Αριθμός σελίδας	页数	رقم الصفحة
	Anulowana	Zrušit	İptal	Аннулирован	Καταργήθηκε	取消	إلغاء
	Charakterystyki techniczne	Technické informace	Teknik Bilgiler	Техническая информация	Τεχνικές πληροφορίες	技术信息	معلومات تقنية
	Referencia producenta	Výrobní číslo	Uretici Numarası	Поставщик - производитель запасной части	Κωδικός κατασκευαστή	供应商编号	رقم المصنّع
	Typ zacisku	Třmen	Kaliper	Скоба	Δαγκάνα	刹车钳	سيلندر فرامل
	Grubość	Tloušťka	Kalınlık	Толщина диска	Πάχος	刹厚	السماكة
	Wskaźnik zużycia	Indikátor opotřebení	Fren İkaz Kablosu	Датчик расхода	Δείκτης φθοράς	磨损指示	شريط كولييه
	Sedan	Sedan	Sedan	Седан	Τετράθυρο	四门轿车	سيارة بأربعة أبواب
	Kombi	Kombi	Station Wagon	Универсал	Station wagon	旅行车	سيارة ستايشن
	Kabriolet	Kabriolet	Kabrio	Καбриолет	Cabrio	敞篷车	سيارة رياضية
	Coupe	2 dveře	2 Kapı	Купе	Coupé	运动型双门轿跑车	سيارة ببابين
	4 X 4	4 X 4	4 x 4	4 X 4	4 X 4	越野车	سيارة رباعية الدفع
	Tarcza pełna	Plný kotouč	Fren Diski - Sogutmasız	Диски сплошные	Συμπαγήδης δισκόπλακα	普通刹车盘	ديسك فرامل دون تهوية
	Tarcza wentylowana	Větráný kotouč	Fren Diski - İ Sogutmal	Диски вентилируемые	Αεριζόμενη δισκόπλακα	通风刹车盘	ديسك فرامل مع تهوية
	Ilość otworów	Opravní díry číslo	Bijon Sayısı	Количество болтов крепления колеса	Αριθμός μπουλονιών τροχού	螺栓孔数目	عدد فتحات التثبيت
	Średnica koła	Průměr kola	Lastik Capı	Диаметр колеса	Διάμετρος τροχού	轮径	قطر العجلة
	Nowa referencja	Nová položka	Yeni Parca Numarası	Новая референция	Νέος κωδικός	新产品编号	أرقام جديدة
	Referencja dostępna wkrótce	Produkt brzo skladem	Yakında Ticari Olacak Referans	Доступен в ближайшее время	Σύντομα διαθέσιμο	即将面世产品编号	منتج سيتوفر قريباً
	Dostępna do wyczerpania zapasów	Do vyčerpání zásob	Referans Stok Bitimine Kadar Ticaridir	Доступен до окончания на складе	Διαθέσιμο μέχρι εξαντλήσεως των αποθεμάτων	直到库存枯竭	متوفر حتى نفاذ الكمية
	Z	S	Berber	С	Με	和	مع
	Oprócz	Bez	Harıç	Без	Εκτός	除了	ماعدا
	Pojazd z napędem na dwie osie	Náhon na 4 kola	4 Ceker	4 X 4	Τετρακίνητο	四轮驱动	سيارة رباعية الدفع
	Klocki hamulcowe przednie	Přední brzdové destičky	Ön Fren Balatası	Передние тормозные колодки	Μπροστινά δισκόφρενα	前刹车片	فرامل أمامية
	Klocki hamulcowe tylne	Zadní brzdové destičky	Arka Fren Balatası	Задние тормозные колодки	Πίσω δισκόφρενα	后刹车片	فرامل خلفية
	Hamulec ręczny	Ruční brzda	El Freni	Стояночный тормоз	Χειρόφρενο	手刹	فرامل يد
	Wszystkie silniki	Všechny motory	Tüm Motorlar	Все двигатели	Όλοι οι κινητήρες	所有发动机	كل المحركات

1 ₁	 >   3
1 ₂	 >   25
2 ₁	   >  29
2 ₂	   >    43
3 ₁	 >    395
3 ₂	 >    445
3 ₃	 >    489
4 ₁	   >  497
4 ₂	   >  897
4 ₃	   >  939
5 ₁	    >  947
5 ₂	    >  1079

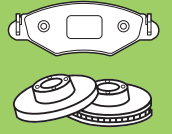

Pads and Discs

Plaquettes et Disques

Pastillas y Discos

Pastilas e Discos

Pastiglie e Dischi

Blokjes en Schijven

Bremsbeläge und Bremsscheiben

Klocki i Tarcze

Balatalari ve Diskleri

Колодки и диски

Δισκόφρενα & Δισκόπλακες



















刹车片和刹车盘























بطانات و قرص



Valeo	
598887	HONDA FR-V (2004>2007) FR-V (2007>2010) Legend (96>2006) Stream (2001>2005)
598888	LEXUS GS 300 (2005>) GS 430 (2005>) GS 450 (2006>) IS 220D (2005>) IS 250 (2005>)
598889	NISSAN D22 King Cab (98>)
598890	TOYOTA Camry (2006>)
598891	CITROËN Jumper II (2006>) Relay II (2006>) FIAT Ducato (2006>) PEUGEOT Boxer II (2006>)
598892	CITROËN Jumper II (2006>) Relay II (2006>) FIAT Ducato (2006>) PEUGEOT Boxer II (2006>)
598893	MITSUBISHI L200 (K84T) (2006>)
598894	TOYOTA Hilux (2005>)
598895	SUBARU Forester (97>2002) Impreza (2000>2005) Legacy (98>2003) Legacy (2003>)
598896	TOYOTA Yaris Made in Japan (2005>)
598897	TOYOTA 4 Runner (130) (89>95) Hilux (83>98) Hilux (2001>) Land Cruiser (BJ70) (84>2001) Land Cruiser (KZ/VZ9) (96>2002) VOLKSWAGEN Taro (89>97)
598898	BMW Series 3 (E90/91/92/93) (2005>) Series 3 (E90/91/93) (2007>) Z4 (E89) (2009>) BMW X1 (2009>)

Valeo	
598899	CITROËN Dispatch (2007>) Jumpy (2007>) FIAT Scudo (2007>) PEUGEOT Expert II (2007>)
598901	HONDA CR-V (2006>)
598902	DAEWOO Evanda (2002>2005) Leganza (97>2003) Nubira (97>)
598903	MG MG F (95>2002) MG TF (2002>2005) ROVER 800 (91>99)
598904	CHRYSLER Stratus (94>)
598905	CHRYSLER Sebring (2000>2007)
598906	FORD Explorer (90>)
598907	HONDA Civic (EP) (2001>2006) Civic (FK/FD) (2006>) S2000 (99>2004)
598908	HYUNDAI Plaza (98>) Satellite (98>2007) Starex (98>) HYUNDAI H1 (97>)
598910	KIA Carens (99>2002) Mentor (2001>2004) Shuma (2001>2004)
598911	HONDA Accord Aerodeck (90>93) Legend (85>90) Prelude (91>96)
598912	NISSAN Maxima QX (CA33) (2000>2006)
598913	FIAT Albea (2002>) Idea (2003>2007) Idea (2007>) Panda (2003>) LANCIA Musa (2004>2007) Musa (2007>)
598914	MITSUBISHI Lancer Evolution (98>) NISSAN 350Z (Z33) (2003>) SUBARU Impreza (2000>2005) Impreza (2005>2007)

















Valeo	  
598915	SUBARU  Impreza (93>2000) Legacy (94>98) Legacy (98>2003)
598916	SUBARU  Impreza (2000>2005) Impreza (2005>2007)
598917	TOYOTA  Corolla (120) (2001>2007) Corolla Verso (2001>2003) Prius (2003>2009)
598919	MITSUBISHI  Lancer Evolution (98>)
	SUBARU  Impreza (2000>2005) Impreza (2005>2007)
598920	JEEP  Commander (2005>) Grand Cherokee (2005>)
598921	TOYOTA  4 Runner (60) (84>89) Hilux (78>84) Hilux (83>98) Land Cruiser (BJ40) (80>84) Land Cruiser (BJ60) (80>90) Land Cruiser (BJ70) (84>2001)
598924	JEEP  Wrangler (2006>)
598925	MINI  MINI (R50/52/53) (2001>) MINI (R56/57) (2006>) MINI (R56/57) (2009>) MINI Clubman (2007>) MINI Clubman (2009>)
598926	OPEL  Astra G (98>2005) Zafira A (98>2003) Zafira A (2003>2005)
	VAUXHALL  Astra MK IV (98>2005) Zafira I (99>2003) Zafira I (2003>2005)
598927	PEUGEOT  308 (2007>) 3008 (2009>)
598928	FORD  Galaxy (2006>) S-Max (2006>)
	VOLVO  V70 (2007>) S80 (2006>)
	VOLVO  XC 60 (2008>) XC 70 (2007>)
598929	SUBARU  Legacy (2003>)



Valeo	  	
598932	HYUNDAI  Santa Fé (2006>)	
598933	TOYOTA  Auris Made in Japan (2006>) Auris Made in UK (2007>) Auris FL (UKP150) (2010>) Corolla (150) (2006>) IQ (2009>) Urban Cruiser Yaris Made in Japan (2005>)	
	598934	KIA  Carens (2006>)
	598935	FORD  Focus II (2007>) Galaxy (2006>) Kuga (2008>) Mondeo (2007>) S-Max (2006>)
		LAND ROVER  Freelander 2 (2006>)
		598936
598937		HYUNDAI  Santa Fé (2006>)
598939	CITROËN  C6 (2005>)	
598940	VOLKSWAGEN  Touareg I (2002>2006) Touareg II (2006>2010)	
598941	CHEVROLET  Captiva (2006>)	
	OPEL  Antara (2006>)	
	VAUXHALL  Antara (2006>)	
598942	CHEVROLET  Captiva (2006>)	
	OPEL  Antara (2006>)	
	VAUXHALL  Antara (2006>)	
598943	TOYOTA  Auris Made in Japan (2006>) Corolla (150) (2006>) Urban Cruiser	
598944	LEXUS  RX 300 (2000>2003) RX 350 (2006>)	
598945	KIA  Carens (2006>)	
598946	VOLKSWAGEN  Transporter (7J/7H) (2003>2009)	
598947	TOYOTA  Dyna 100 (85>2001) Hiace (82>89) Hiace (89>95) Hiace (95>)	



Valeo	
598982	VOLKSWAGEN Golf III (91>99) Vento (91>97)
598983	TOYOTA MR 2 (84>89) MR 2 (89>99) MR 2 (99>2005)
598984	TOYOTA Corolla (80) (83>87) Corolla (90) (87>92) Corolla (110) (97>99)
598985	ALFA ROMEO 155 (91>97) GTV (95>2003) Spider (95>2003)
	FIAT Coupe (93>2000) Croma (91>96) Tipo (93>95)
	LANCIA Dedra (89>94) Dedra (94>99) Delta (86>93) Delta (93>99) Kappa (94>2001) Thema (84>88) Thema (88>92) Thema (92>94)
598986	SUZUKI Swift Made in Japan (89>96)
598987	FIAT 500 Nuova (2007>)
	FORD Ka (2008>)
598988	ALFA ROMEO 147 (2000>2004) 156 (97>2003) 156 (2003>2007) GTV (95>2003) GTV (2003>2006) Spider (95>2003) Spider (2003>2006)
	FIAT Coupe (93>2000)
598989	KIA Leo (96>) Mentor (94>2001) Sephia (93>98) Sephia (98>2001) Shuma (98>2002)

Valeo			
598990	ALFA ROMEO 145 (94>2001) 146 (94>2001) 147 (2000>2004) 147 (2004>) 156 (2003>2007) GT (2003>)		
	FIAT Bravo (95>2002) Marea (96>2002) Punto II (2003>)		
	LANCIA Lybra (99>2006)		
	598991		
598991	SUBARU Justy (95>2003)		
	SUZUKI Swift Made in Hungary (96>2005)		
598992	AUDI A4 (99>2001) A6 (97>2001) A6 (2001>2005) A6 Allroad (2000>2005) S4 (99>2001) S6 (99>2001) S6 (2001>2005)		
	VOLKSWAGEN Phaeton (2002>2007)		
598993	RENAULT Scenic II (2003>) Grand Scenic II (2003>)		
598994	AUDI TT RS (2009>)		
	VOLKSWAGEN Touareg I (2002>2006) Touareg II (2006>2010) Touareg II (2010>)		
598995	MERCEDES Class CL (W216) (2006>) Class CLS (W219) (2004>2008) Class CLS (W219) (2008>) Class E (W211) (2006>2009) Class S (W221) (2004>) Class SL (230) (2001>2008) Class SL (230) (2008>)		
	598996	AUDI A4 (2007>) A5 (2007>) A5 Cabriolet (2009>)	
		598997	CITROËN C4 Picasso (2006>)
			PEUGEOT 5008 (2009>)
	CITROËN Berlingo (2008>)		
	PEUGEOT Partner (2008>)		
598998	CITROËN C4 Picasso (2006>)		
	PEUGEOT 5008 (2009>)		

Valeo		
598999	DAIHATSU  Sirion II (2005>)	
	FORD  Fiesta (2008>)	
	MAZDA  2 (2007>)	
601000	RENAULT  Mégane III (2008>) Scenic III (2009>)	
601001	LANCIA  Thesis (2002>)	
601002	NISSAN  Patrol GR (Y61) (97>2004) Patrol GR (Y61) (2004>)	
601003	FIAT  Punto II (99>2003) Punto II (2003>)	
601004	AUDI  A6 (2004>2008) A6 (2008>) A6 Allroad (2006>2008) A6 Allroad (2008>) A8 (2002>2009) RS6 Quattro (2002>2004) S4 (2003>2004) S4 (2004>2008) S4 Cabriolet (2004>2005) S4 Cabriolet II (2006>2009) S6 (2006>2008) S6 (2008>) S8 (2006>2007)	
	VOLKSWAGEN  Transporter (7J/7H) (2003>2009) Transporter (7E/7F) (2009>)	
	601005	FORD  Focus C-Max (2003>2007)
		MAZDA  3 (2003>2006)
		VOLVO  S40 (2004>) V50 (2004>)
	601006	SAAB  9-5 (2005>)
	601007	FORD  Galaxy (2006>) Mondeo (2007>) S-Max (2006>)
		VOLVO  V70 (2007>) S80 (2006>)
		VOLVO  XC 70 (2007>)
		601008

Valeo		
601009	INFINITI  EX (2008>) FX (2008>)	
	NISSAN  Cube (2010>) Qashqai (2007>2010) Qashqai (2010>) Tiida (C11X) (2007>)	
	NISSAN  X-Trail (T31) (2007>)	
	RENAULT  Koleos (2008>)	
601010	RENAULT  Kangoo (2007>)	
601011	RENAULT  Kangoo (2007>)	
601012	RENAULT  Clio III (2005>) Clio III (2009>) Laguna III (2007>) Mégane II (2002>) Scenic II (2003>) Twingo III (2007>) Wind (2010>)	
	601013	NISSAN  Tiida (C11X) (2007>)
	601014	LANCIA  Delta (2008>)
	601015	FIAT  500 Nuova (2007>)
		FORD  Ka (2008>)
601016	SKODA  100-135	
601017	DACIA  Logan (2004>)	
601018	MAZDA  Demio (98>2003)	
601019	FIAT  Palio (96>2001) Siena (97>2001)	
	601020	MITSUBISHI  Challenger (98>) Lancer Evolution (98>) Space Gear (94>98) Space Wagon (N8) (98>2004)
MITSUBISHI  Montero Sport (K9) (98>2009) Outlander (CU) (2003>2008) Pajero Sport (K9) (98>2009) Space Runner (91>)		
MITSUBISHI  L400 (PA/PB/PD)		
601021		FIAT  Cinquecento (92>98)
601022		LEXUS  GS 300 (93>97)
	TOYOTA  Supra (93>)	















































Valeo	
601023	LEXUS GS 300 (93>97) GS 300 (97>2004) GS 430 (2000>2004) IS I (99>2005) IS 300 (99>2005) SC430 (2001>) <hr/> TOYOTA Supra (93>)
601024	DAIHATSU Cuore (90>94) Cuore (94>98) Domino (90>94) Domino (94>98) Mira (92>94) Mira (94>98)
601025	LEXUS GS 300 (97>2004) GS 430 (2000>2004) IS I (99>2005) IS 300 (99>2005) SC430 (2001>)
601026	TOYOTA Yaris Made in France (2005>)
601027	BMW Series 3 (E90/91/92/93) (2005>) Series 3 (E90/91/93) (2007>) <hr/> BMW X1 (2009>)
601028	TOYOTA Yaris Made in France (2005>)
601029	ALFA ROMEO 159 (2005>) Brera (2006>) Spider II (2006>) <hr/> LANCIA Delta (2008>) Thesis (2002>)
601030	VOLVO XC 90 (2002>)
601031	LANCIA Y Ipsilon (2003>)
601032	CHRYSLER 300C (2004>)
601033	CHRYSLER 300C (2004>)
601034	MERCEDES Class C (W203) (2004>) Class CLC (W203) (2008>) Class SLK (171) (2008>)
601035	LEXUS IS 220D (2005>) IS 250 (2005>)
601036	VOLKSWAGEN Tiguan (2007>)
601037	TOYOTA RAV4 (2005>)

Valeo	
601038	HONDA CR-V (2006>)
601039	CITROËN Dispatch (2007>) Jumpy (2007>) <hr/> FIAT Scudo (2007>) <hr/> PEUGEOT Expert II (2007>)
601040	TOYOTA Auris Made in Japan (2006>) Auris Made in UK (2007>) Corolla (150) (2006>)
601041	MINI MINI (R56/57) (2006>) MINI (R56/57) (2009>) MINI Clubman (2007>) MINI Clubman (2009>)
601042	PEUGEOT 308 (2007>) <hr/> CITROËN Berlingo (2008>) <hr/> PEUGEOT Partner (2008>)
601043	HONDA FR-V (2004>2007) FR-V (2007>2010) <hr/> HONDA CR-V (2002>2006)
601044	FORD Focus (2004>) Focus II (2007>) Focus C-Max (2003>2007) <hr/> MAZDA 5 (2005>) <hr/> VOLVO C30 (2006>) S40 (2004>) V50 (2004>) C70 CC (2006>)
601045	DACIA Duster (2010>) <hr/> RENAULT Fluence (2009>) Mégane III (2008>) Scenic III (2009>)
601046	OPEL Insignia (2009>) <hr/> VAUXHALL Insignia (2009>)
601047	OPEL Insignia (2009>) <hr/> VAUXHALL Insignia (2009>)
601048	OPEL Insignia (2009>) <hr/> VAUXHALL Insignia (2009>)
601049	OPEL Insignia (2009>) <hr/> VAUXHALL Insignia (2009>)

	
601050	RENAULT  Mégane III (2008>) Scenic III (2009>)
601051	MERCEDES  Class C (W204) (2007>) Class E (207-212) (2009>)
	MERCEDES  Class GLK (2008>)
601052	TOYOTA  Yaris Made in Japan (2005>)

Valeo	
186893	RENAULT  Espace IV (2002>2006) Espace IV (2006>) Vel Satis (2002>2005) Vel Satis (2005>)
186894	RENAULT  Vel Satis (2002>2005)
187061	RENAULT  Master Propulsion I (99>2004) Master Propulsion II (2004>)
	RVI  Mascott (99>)
187130	IVECO  Daily (99>)
187141	MERCEDES  Sprinter II (2006>)
	VOLKSWAGEN  Crafter (2006>)
187146	MERCEDES  Sprinter II (2006>)
187147	IVECO  Daily (99>)
187148	IVECO  Daily (99>)
187149	IVECO  Daily (99>)
187152	FORD  Transit (2006>)
197001	NISSAN  Primastar (2002>2006) Primastar (2006>)
	OPEL  Vivaro (2001>2006) Vivaro (2006>)
	RENAULT  Trafic II (2001>2006) Trafic II (2006>)
	VAUXHALL  Vivaro (2001>2006) Vivaro (2006>)
197002	CITROËN  C3 (2009>) C3 Picasso (2009>) C4 (2004>) DS3 (2010>)
	PEUGEOT  207 (2006>) 307 (2005>)
197003	RENAULT  Vel Satis (2002>2005)
197004	OPEL  Sintra (96>99)
	VAUXHALL  Sintra (96>99)
197008	ABARTH  Grande Punto (2007>) Punto Evo (2010>)
	FIAT  Grande Punto (2005>) Punto Evo (2009>)



















Valeo	
197009	SAAB  9-5 (97>2001) 9-5 (2001>2005) 9-5 (2005>)
197010	PEUGEOT  407 (2004>)
197011	AUDI  A3 (96>2000) A3 (2000>2003) TT (98>2006)
	SKODA  Octavia (96>2000) Octavia (2000>)
	VOLKSWAGEN  Bora (98>2005) Golf IV (97>2006)
197013	FORD  Tourneo Connect (2002>2006) Tourneo Connect (2006>) Transit Connect (2002>2006) Transit Connect (2006>)
197014	HONDA  Civic (EP) (2001>2006)
197015	HONDA  Accord VI (98>2003)
197016	MG  MG ZT (2001>2005)
	ROVER  75 (99>2005)
197017	LAND ROVER  Range Rover (2002>)
197018	TOYOTA  Avensis Verso (2001>2005) Picnic (2001>2005) Previa (2000>)
197019	TOYOTA  Corolla (120) (2001>2007)
197020	MAZDA  323 (BJ) (2000>2003)
197021	MAZDA  3 (2003>2006) 3 (2006>) 3 (2008>)
197022	CHRYSLER  Voyager IV (2001>) Voyager V (2004>) Grand Voyager (2001>2004) Grand Voyager (2004>2008)
	JEEP  Cherokee (2004>) Wrangler (96>2006)
197023	CITROËN  Jumper II (2006>) Relay II (2006>)
	FIAT  Ducato (2006>)
	PEUGEOT  Boxer II (2006>)

























Valeo	
197027	<p>HYUNDAI Trajet (2000>2004) Trajet (2004>)</p> <hr/> <p>HYUNDAI Santa Fé (2000>2006) Tucson (2004>)</p> <hr/> <p>KIA Sportage (2004>)</p> <hr/> <p>HYUNDAI Highway Van (2000>2004)</p>
197028	<p>FIAT Grande Punto (2005>)</p> <hr/> <p>OPEL Corsa D (2006>)</p> <hr/> <p>VAUXHALL Corsa MK III (2006>)</p>
197029	<p>HYUNDAI Accent TR (2005>) Getz (2002>2005) Getz (2005>) i20 (2008>)</p> <hr/> <p>KIA Rio (2005>2008)</p>
197030	<p>MERCEDES Sprinter II (2006>)</p> <hr/> <p>VOLKSWAGEN Crafter (2006>)</p>
197031	<p>AUDI A3 (2003>2008) A3 (2008>) A3 Cabriolet (2008>) S3 (98>2003)</p> <hr/> <p>SEAT Alhambra (2010>) Altea (2004>) Leon (2005>)</p> <hr/> <p>SKODA Octavia (2004>2008) Octavia (2008>) Superb (2008>)</p> <hr/> <p>VOLKSWAGEN Eos (2006>) Golf V (2003>) Golf VI (2008>) Golf Plus (2009>) Jetta III (2005>) Passat VII (2005>) Passat CC (2008>) Scirocco (2008>) Sharan (2010>) Touran I (2003>2006) Touran II (2006>2010)</p> <hr/> <p>SKODA Yeti (2009>)</p> <hr/> <p>VOLKSWAGEN Tiguan (2007>)</p>
197032	<p>AUDI A6 (97>2001) A6 (2001>2005) A6 Allroad (2000>2005)</p>

Valeo	
197033	<p>MERCEDES Sprinter (95>2006)</p> <hr/> <p>VOLKSWAGEN LT II (96>2003) LT III (2003>2006)</p>
197035	<p>MERCEDES Class E (W211) (2002>2006) Class E (W211) (2006>2009) Class E (207-212) (2009>)</p>
197036	<p>MERCEDES Class A (W169) (2004>2008) Class A (W169) (2008>) Class B (W245) (2005>2008) Class B (W245) (2008>)</p>
197038	<p>AUDI A4 (2004>2008) A4 Cabriolet II (2006>2009)</p> <hr/> <p>SEAT Exeo (2008>)</p>
197043	<p>CITROËN Jumper II (2006>) Relay II (2006>)</p> <hr/> <p>FIAT Ducato (2006>)</p> <hr/> <p>PEUGEOT Boxer II (2006>)</p>
197044	<p>FIAT Grande Punto (2005>) Punto Evo (2009>)</p> <hr/> <p>OPEL Corsa D (2006>)</p> <hr/> <p>VAUXHALL Corsa MK III (2006>)</p>
197045	<p>FIAT Grande Punto (2005>) Punto Evo (2009>)</p> <hr/> <p>OPEL Corsa D (2006>)</p> <hr/> <p>VAUXHALL Corsa MK III (2006>)</p>
197046	<p>CITROËN C6 (2005>)</p> <hr/> <p>PEUGEOT 407 (2004>) 607 (2004>)</p>
197047	<p>CITROËN C1 (2005>)</p> <hr/> <p>PEUGEOT 107 (2005>)</p> <hr/> <p>TOYOTA Aygo (2005>)</p>
197049	<p>BMW Series 1 (E87) (2004>) Series 1 (E81/82/88) (2007>) Series 3 (E90/91/92/93) (2005>) Series 3 (E90/91/93) (2007>)</p>
197050	<p>SAAB 9-5 (2001>2005) 9-5 (2005>)</p>
197051	<p>AUDI Q7 (2006>)</p> <hr/> <p>PORSCHE Cayenne (2003>)</p>























Valeo		
197052	AUDI  A6 (2004>2008) A6 (2008>)	
197054	FORD  Transit (2006>)	
197055	FORD  Galaxy (2006>) Mondeo (2007>) S-Max (2006>)	
	VOLVO  V70 (2007>) S80 (2006>)	
	LAND ROVER  Freelander 2 (2006>)	
	VOLVO  XC 70 (2007>)	
197056	VOLVO  C70 (97>2005) S70 (96>2000) V70 (96>2000)	
	VOLVO  XC 70 (97>99)	
197057	VOLVO  XC 90 (2002>)	
197059	MERCEDES  Sprinter (95>2006)	
	VOLKSWAGEN  LT II (96>2003) LT III (2003>2006)	
197060	MERCEDES  Vaneo (2001>)	
197062	LAND ROVER  Discovery (98>2004)	
197063	MAZDA  MX5 (90>98) MX5 (98>2000) MX5 (2000>2005)	
	SUZUKI  Ignis (2000>2003)	
	SUZUKI  Grand Vitara (98>2005)	
197066	OPEL  Agila (2007>)	
	SUZUKI  Splash (2008>) Swift Made in Hungary (2005>)	
	VAUXHALL  Agila (2007>)	
197067	MITSUBISHI  Pajero Pinin (H7) (99>) Shogun Pinin (99>)	
197069	CHRYSLER  Voyager IV (2001>) Voyager V (2004>) Grand Voyager (2001>2004) Grand Voyager (2004>2008)	
	197070	TOYOTA  Corolla Verso (2004>2009)
	197071	TOYOTA  Land Cruiser (KD/GR) (2002>)





















Valeo		
197072	TOYOTA  Avensis (2003>2008)	
197073	BMW  Series 1 (E87) (2004>) Series 1 (E81/82/88) (2007>) Series 3 (E90/91/92/93) (2005>) Series 3 (E90/91/93) (2007>)	
	BMW  X1 (2009>)	
197074	MINI  MINI (R56/57) (2006>) MINI (R56/57) (2009>) MINI Clubman (2007>) MINI Clubman (2009>)	
	197079	RENAULT  Espace IV (2002>2006) Espace IV (2006>)
	197081	RENAULT  Mégane Scenic (99>2003)
197083	BMW  X3 (2003>2006) X3 (2006>)	
197084	BMW  Series 5 (E60/61) (2003>) Series 6 (E63/64) (2003>)	
197086	VOLKSWAGEN  Lupo (98>2005) Polo V (94>99) Polo VI (99>2001)	
	197087	PORSCHE  Cayenne (2003>)
		VOLKSWAGEN  Touareg I (2002>2006) Touareg II (2006>2010) Touareg II (2010>)
197088		AUDI  TT (98>2006)
	SEAT  Leon (99>2006)	
	SKODA  Octavia (2000>)	
	VOLKSWAGEN  Bora (98>2005) Golf IV (97>2006) New Beetle (98>2001) New Beetle (2001>2005)	
	197089	AUDI  A6 (97>2001) A6 (2001>2005) S6 (99>2001) S6 (2001>2005)
VOLKSWAGEN  Passat VI (2000>2005)		



















Valeo	  	
197090	AUDI  Q7 (2006>)	
	PORSCHE  Cayenne (2003>)	
	VOLKSWAGEN  Touareg I (2002>2006) Touareg II (2006>2010) Touareg II (2010>)	
197091	MERCEDES  Class A (W169) (2004>2008) Class A (W169) (2008>) Class B (W245) (2005>2008) Class B (W245) (2008>)	
	MERCEDES  Class R (W251) (2005>)	
		MERCEDES  Class ML (164) (2005>2008) Class ML (164) (2008>)
	197093	MERCEDES  Class E (W211) (2002>2006) Class E (W211) (2006>2009)
197094		MERCEDES  Class E (W124) (93>98) Class E (W210) (95>2003) Class SL (129) (89>2001)
	197096	HYUNDAI  i10 (2007>)
		KIA  Picanto (2004>2007) Picanto (2007>)
197097	CITROËN  Jumper II (2006>) Relay II (2006>)	
	FIAT  Ducato (2006>)	
	PEUGEOT  Boxer II (2006>)	
	197098	ALFA ROMEO  159 (2005>) Brera (2006>) Giulietta (2010>) Spider II (2006>)
197099		CITROËN  Dispatch (2007>) Jumpy (2007>)
		FIAT  Scudo (2007>)
		PEUGEOT  Expert II (2007>)
197100	PEUGEOT  308 (2007>)	
197101	FORD  Focus II (2007>) Galaxy (2006>) Kuga (2008>) Mondeo (2007>) S-Max (2006>)	
	197102	HONDA  CR-V (2002>2006)

























Valeo	  		
197103	HONDA  Civic (EP) (2001>2006)		
197104	HONDA  Civic (EP) (2001>2006)		
197105	CITROËN  Jumper II (2006>) Relay II (2006>)		
	FIAT  Ducato (2006>)		
	PEUGEOT  Boxer II (2006>)		
197106	NISSAN  Qashqai (2007>2010) Qashqai (2010>)		
197107	LAND ROVER  Freelander 2 (2006>)		
197108	DAIHATSU  Cuore (98>2003) Cuore (2003>2005) Domino (98>2000) Trevis (2006>)		
	197109	TOYOTA  Auris Made in Japan (2006>) Auris Made in UK (2007>) Auris FL (UKP150) (2010>) Corolla (150) (2006>)	
		197110	TOYOTA  Auris Made in Japan (2006>) Corolla (150) (2006>)
			197111
197112		TOYOTA  RAV4 (2000>2005)	
197113	TOYOTA  IQ (2009>) Yaris Made in Japan (2005>)		
	197114	SUZUKI  Alto (80>94) Swift Made in Japan (83>89)	
SUZUKI  Super Carry (SK4*)			
197116	CITROËN  C Crosser		
	MITSUBISHI  Outlander (CW) (2006>)		
	PEUGEOT  4007 (2007>)		
197117	CITROËN  C4 Picasso (2006>)		
	PEUGEOT  308 (2007>) 3008 (2009>) 5008 (2009>)		
		CITROËN  Berlingo (2008>)	
		PEUGEOT  Partner (2008>)	























Valeo	
197120	HYUNDAI  Coupe (95>2001) Elantra (95>2000) Elantra (2000>2007) Lantra (95>2000)
197121	HYUNDAI  Sonata (2005>) XG (99>2002) XG (2002>) KIA  Magentis (2006>) HYUNDAI  Tucson (2004>) KIA  Sportage (2004>)
197122	DAEWOO  Korando KJ (99>) Musso (99>) SSANGYONG  Rexton (2002>) Rexton (2004>)
197123	HYUNDAI  i30 (2007>) KIA  Ceed (2006>)
197124	AUDI  A6 (97>2001) A6 (2001>2005)
197125	AUDI  A6 (2004>2008) A6 (2008>)
197126	AUDI  A4 (2007>) A5 (2007>) A5 Cabriolet (2009>) A7 (2010>) AUDI  Q5 (2008>)
197127	MERCEDES  Class C (W204) (2007>) Class E (207-212) (2009>)
197128	MERCEDES  Class C (W204) (2007>)
197129	MITSUBISHI  Colt (2004>) SMART MCC  Forfour (2004>)
197130	ALFA ROMEO  159 (2005>) Brera (2006>) Giulietta (2010>) Spider II (2006>)
197131	CITROËN  Jumper II (2006>) Relay II (2006>) FIAT  Ducato (2006>) PEUGEOT  Boxer II (2006>)

















Valeo	
197132	ALFA ROMEO  159 (2005>) Brera (2006>)
197133	PEUGEOT  407 (2004>) CITROËN  Dispatch (2007>) Jumpy (2007>) FIAT  Scudo (2007>) PEUGEOT  Expert II (2007>)
197134	ALFA ROMEO  159 (2005>) Brera (2006>) Spider II (2006>)
197135	SUZUKI  SX4 (2006>2009) SX4 (2009>) FIAT  Sedici (2006>2009) Sedici (2009>)
197136	ALFA ROMEO  147 (2000>2004) 147 (2004>) 156 (2003>2007) GT (2003>)
197137	LANCIA  Thesis (2002>)
197138	LANCIA  Thesis (2002>)
197139	AUDI  A3 (2003>2008) A3 (2008>) S3 (2006>) SKODA  Superb (2008>) VOLKSWAGEN  Eos (2006>) Golf V (2003>) Passat VII (2005>) Passat CC (2008>)
197140	AUDI  A6 (2004>2008) A6 (2008>)
197141	VOLKSWAGEN  Passat VI (2000>2005)
197142	AUDI  A6 (2004>2008) A6 (2008>) A6 Allroad (2006>2008) A6 Allroad (2008>)
197143	FORD  Focus (2004>) Focus II (2007>) VOLVO  S40 (2004>) V50 (2004>) C70 CC (2006>)

























Valeo	  
197144	HONDA  Civic (EP) (2001>2006)
197145	HONDA  Accord VII (2003>2008)
197146	HONDA  Logo (98>2001)
197147	TOYOTA  Yaris Made in Japan (2005>)
197148	TOYOTA  Carina E (92>97)
197149	OPEL  Corsa D (2006>) VAUXHALL  Corsa MK III (2006>)
197150	OPEL  Astra H (2004>) Zafira B (2005>2008) Zafira B (2008>) VAUXHALL  Astra MK V (2004>) Zafira II (2005>2009) Zafira II (2009>)
197151	TOYOTA  RAV4 (2005>)
197152	TOYOTA  RAV4 (2005>)
197153	HONDA  Accord VII (2003>2008)
197154	HONDA  Accord VI (98>2003)
197155	LAND ROVER  Discovery (2004>) Range Rover Sport (2005>)
197156	LAND ROVER  Discovery (2004>) Range Rover Sport (2005>)
197157	DAIHATSU  Cuore (90>94) Domino (90>94) Mira (92>94)
197158	BMW  Series 1 (E87) (2004>) Series 1 (E81/82/88) (2007>) Series 3 (E90/91/92/93) (2005>) Series 3 (E90/91/93) (2007>) BMW  X1 (2009>)
197159	BMW  Series 3 (E90/91/92/93) (2005>) Series 3 (E90/91/93) (2007>) BMW  X1 (2009>)
197160	MINI  MINI (R56/57) (2006>) MINI (R56/57) (2009>) MINI Clubman (2007>) MINI Clubman (2009>)





















Valeo	  
197161	MAZDA  323 (BJ) (98>2000) 323 (BJ) (2000>2003)
197162	SUZUKI  Grand Vitara (98>2005) Grand Vitara XL7 (2001>2006)
197163	SUZUKI  Wagon R (97>)
197164	NISSAN  Qashqai (2007>2010) Qashqai (2010>) NISSAN  X-Trail (T31) (2007>)
197165	MITSUBISHI  L300 (L030)
197166	TOYOTA  Avensis Verso (2001>2005) Camry (91>96) Camry (96>2001) Picnic (2001>2005) Previa (2000>)
197167	TOYOTA  Camry (91>96) Picnic (96>2001)
197168	TOYOTA  Camry (2001>2006)
197169	TOYOTA  Carina E (92>97)
197170	TOYOTA  Celica (99>2005)
197171	TOYOTA  Corolla (120) (2001>2007)
197172	HYUNDAI  Trajet (2000>2004) Trajet (2004>) HYUNDAI  Highway Van (2000>2004)
197173	HYUNDAI  Accent (99>2003) Accent (2003>)
197174	HYUNDAI  i30 (2007>) i30 (CZ) (2008>)
197175	BMW  Series 3 (E90/91/92/93) (2005>) Series 3 (E90/91/93) (2007>) BMW  X1 (2009>)
197176	BMW  Series 3 (E90/91/92/93) (2005>) Series 3 (E90/91/93) (2007>) BMW  X1 (2009>)
197177	BMW  X5 (2006>)
197178	BMW  X5 (2006>) X6 (2008>)













Valeo	
197179	BMW  X5 (2006>) X6 (2008>)
197180	BMW  X5 (2006>) X6 (2008>)
197181	BMW  Series 1 (E81/82/88) (2007>)
197182	TOYOTA  Yaris Made in Japan (2005>)
197183	TOYOTA  Auris Made in Japan (2006>) Corolla (150) (2006>)
197184	TOYOTA  Yaris Made in France (2005>)
197185	TOYOTA  Auris Made in Japan (2006>) Auris Made in UK (2007>) Auris FL (UKP150) (2010>) Corolla (150) (2006>)
197186	HONDA  CR-V (2006>)
197187	TOYOTA  Auris Made in Japan (2006>) Auris Made in UK (2007>) Auris FL (UKP150) (2010>) Avenis (2008>) Corolla (150) (2006>) Corolla Verso (2009>) Verso (2009>)
197188	CITROËN  Dispatch (2007>) Jumpy (2007>)
	FIAT  Scudo (2007>)
	PEUGEOT  Expert II (2007>)
197190	CHEVROLET  Captiva (2006>)
	OPEL  Antara (2006>)
	VAUXHALL  Antara (2006>)
197191	CHEVROLET  Captiva (2006>)
	OPEL  Antara (2006>)
	VAUXHALL  Antara (2006>)
197192	DACIA  Duster (2010>)
	RENAULT  Fluence (2009>) Laguna III (2007>) Mégane III (2008>) Scenic III (2009>)
197193	BMW  Series 5 (E60/61) (2003>) Series 6 (E63/64) (2003>)















Valeo	
197194	LEXUS  GS 300 (97>2004) GS 430 (2000>2004) IS I (99>2005) IS 300 (99>2005) LS400 (89>94) SC430 (2001>)
197195	DAEWOO  Korando KJ (99>) Musso (99>)
	SSANGYONG  Rexton (2002>)
197196	AUDI  A4 (2007>) A5 (2007>) A5 Cabriolet (2009>)
	AUDI  Q5 (2008>)
197197	AUDI  A3 (2003>2008) A3 (2008>) S3 (2006>)
	SEAT  Leon (2005>)
	SKODA  Superb (2008>)
	VOLKSWAGEN  Eos (2006>) Golf V (2003>) Golf VI (2008>) Passat VII (2005>) Passat CC (2008>) Scirocco (2008>)
197198	AUDI  A4 (99>2001) A4 (2004>2008) A4 Cabriolet II (2006>2009) A6 (97>2001) A6 (2001>2005) A6 Allroad (2000>2005) S4 (97>99) S4 (99>2001)
	SEAT  Exeo (2008>)
197199	AUDI  A6 (2004>2008) A6 (2008>) A6 Allroad (2006>2008) A6 Allroad (2008>) A8 (2002>2009)
197200	MERCEDES  Class SLK (171) (2004>2007)
197201	MERCEDES  Class C (W204) (2007>)
197202	MERCEDES  Class C (W204) (2007>) Class E (207-212) (2009>)



Valeo	  
197203	MERCEDES  Class C (W204) (2007>)
197204	KIA  Sorento (2006>)
197205	HYUNDAI  i30 (2007>)
	KIA  Ceed (2006>)
197206	KIA  Carnival (99>2002)
	Sedona (99>2002)
197207	KIA  Retona (99>)
	Spoptage (93>2002)
197208	KIA  Sephia (98>2001)
	Shuma (98>2002)
197209	KIA  Sorento (2002>2006)
197210	KIA  Sorento (2002>2006)
197211	KIA  Carnival (2002>2006)
	Sedona (2002>)
197212	AUDI  A6 Allroad (2006>2008)
	A6 Allroad (2008>)
	S6 (2006>2008)
	S6 (2008>)
197213	AUDI  A4 (2007>)
	A5 (2007>)
	A5 Cabriolet (2009>)
197214	MITSUBISHI  Colt (2004>)
	SMART MCC  Forfour (2004>)
197215	RENAULT  Scenic II (2003>)
	Grand Scenic II (2003>)
197216	PEUGEOT  308 (2007>)
	3008 (2009>)
	5008 (2009>)
197217	CITROËN  Jumper (94>2001)
	Relay (94>2001)
	FIAT  Ducato (94>2001)
	PEUGEOT  Boxer I (94>2001)
197218	VOLKSWAGEN  Transporter (F70) (90>96)

Valeo	  
197219	CITROËN  C8 (2002>)
	FIAT  Ulysse (2002>)
	LANCIA  Phedra (2002>)
	PEUGEOT  807 (2002>)
	CITROËN  Dispatch (2004>2006)
	Jumpy (2004>2006)
	PEUGEOT  Expert I (2004>2006)
197220	CITROËN  C5 (2001>2008)
	Xantia (93>97)
	Xantia (97>2002)
197221	RENAULT  Laguna II (2001>2005)
	Laguna II (2005>2007)
197222	AUDI  100 (90>94)
	A4 (94>98)
	A4 (99>2001)
	A4 (2000>2004)
	A4 (2004>2008)
	A6 (94>97)
	A6 (97>2001)
A6 (2001>2005)	
SEAT  Exeo (2008>)	
SKODA  Superb (2001>2008)	
VOLKSWAGEN  Passat V (96>2000)	Passat VI (2000>2005)
197223	ISUZU  Trooper (81>97)
	Trooper (98>)
OPEL  Frontera A (91>98)	Frontera B (98>2005)
	Monterey (91>99)
	VAUXHALL  Frontera A (91>98)
Monterey A (94>99)	
Monterey B (98>99)	
197224	LAND ROVER  Range Rover (94>2002)
197225	OPEL  Omega A (86>94)
	Omega B (94>2003)
	Senator B (87>93)
	VAUXHALL  Carlton (86>94)
Senator B (87>93)	

Valeo		
	  	
197226	OPEL 	Calibra (89>97) Vectra B (95>99) Vectra B (99>2003)
	SAAB 	9-3 (98>2003) 9-5 (97>2001) 9-5 (2001>2005) 9-5 (2005>) 900 (93>98)
	VAUXHALL 	Calibra (90>97) Vectra (95>2002)
197227	BMW 	Series 7 (E38) (94>2001)
197228	CITROËN 	Jumper (94>2001) Jumper (2002>2006) Relay (94>2001) Relay (2002>2006)
	FIAT 	Ducato (94>2001) Ducato (2002>2006) Ducato RU (2008>)
	PEUGEOT 	Boxer I (94>2001) Boxer I (2002>2006)
197229	ALFA ROMEO 	166 (98>2003) 166 (2003>2007)
	LANCIA 	Kappa (94>2001)



Valeo		
	  	
197230	AUDI 	A1 (2010>) A3 (96>2000) A3 (2000>2003)
	SEAT 	Cordoba (2002>) Ibiza (2001>) Ibiza (2008>) Leon (99>2006) Toledo (98>2004)
	SKODA 	Fabia (99>2004) Fabia (2004>2007) Fabia (2006>) Octavia (96>2000) Octavia (2000>) Roomster (2006>)
197231	VOLKSWAGEN 	Bora (98>2005) Golf IV (97>2006) New Beetle (98>2001) New Beetle (2001>2005) New Beetle (2005>) Polo VII (2001>) Polo VIII (2005>) Polo IX (2009>)
	PEUGEOT 	406 (95>2004)
	197232	CITROËN 
PEUGEOT 		207 (2006>) 307 (2001>2005) 307 (2005>)
197233	CHRYSLER 	Voyager IV (2001>) Voyager V (2004>) Grand Voyager (96>2001) Grand Voyager (2001>2004) Grand Voyager (2004>2008)
197234	BMW 	Series 1 (E87) (2004>) Series 1 (E81/82/88) (2007>) Series 3 (E90/91/92/93) (2005>) Series 3 (E90/91/93) (2007>) Z4 (E89) (2009>)
197236	FORD 	Galaxy (95>2000) Galaxy (2000>2006)
	SEAT 	Alhambra (96>2000) Alhambra (2000>2003)
	VOLKSWAGEN 	Sharan (95>2000) Sharan (2000>2003)



































Valeo		
197238	JEEP Grand Cherokee (2000>2003) Grand Cherokee (2003>2005)	
197239	FORD Galaxy (2000>2006)	
	SEAT Alhambra (2000>2003)	
	VOLKSWAGEN Sharan (2000>2003) Sharan (2003>2010)	
	VOLKSWAGEN Transporter (F7D) (96>2003)	
197240	RENAULT Avantime (2001>2003) Espace III (2000>2002)	
197241	RENAULT Scenic II (2003>) Grand Scenic II (2003>)	
197242	AUDI A3 (2003>2008) A3 (2008>) A3 Cabriolet (2008>) S3 (98>2003) TT (2006>)	
	SEAT Alhambra (2010>) Altea (2004>) Leon (2005>)	
	SKODA Octavia (2004>2008) Octavia (2008>) Superb (2001>2008) Superb (2008>)	
	VOLKSWAGEN Eos (2006>) Golf V (2003>) Golf VI (2008>) Jetta III (2005>) Passat VII (2005>) Passat CC (2008>) Scirocco (2008>) Sharan (2010>) Touran I (2003>2006) Touran II (2006>2010) Touran III (2010>)	
	SKODA Yeti (2009>)	
	VOLKSWAGEN Tiguan (2007>)	
	VOLKSWAGEN Caddy III (2004>)	
	197243	VOLKSWAGEN Touareg I (2002>2006) Touareg II (2006>2010)
		VOLKSWAGEN Transporter (7J/7H) (2003>2009)

Valeo		
197244	OPEL Astra G (98>2005) Astra H (2004>) Corsa D (2006>) Meriva (2003>) Meriva (2010>) Zafira A (98>2003) Zafira A (2003>2005) Zafira B (2005>2008) Zafira B (2008>)	
	SAAB 9-5 (97>2001) 9-5 (2001>2005) 9-5 (2005>)	
	VAUXHALL Astra MK IV (98>2005) Astra MK V (2004>) Corsa MK III (2006>) Meriva (2003>) Meriva (2010>) Vectra (95>2002) Zafira I (99>2003) Zafira I (2003>2005) Zafira II (2005>2009) Zafira II (2009>)	
	197245	MAZDA 6 (2002>2007)
	197246	AUDI A3 (2000>2003) TT (98>2006)
		SEAT Ibiza (2001>) Ibiza (2008>) Leon (99>2006)
		SKODA Octavia (2000>)
		VOLKSWAGEN Bora (98>2005) Golf IV (97>2006) New Beetle (98>2001) Polo VIII (2005>)
	197247	ALFA ROMEO 159 (2005>) Brera (2006>) Giulietta (2010>) Spider II (2006>)
	197248	CITROËN Jumper II (2006>) Relay II (2006>)
FIAT Ducato (2006>)		
PEUGEOT Boxer II (2006>)		
197249	FORD Transit (2006>)	

		
197251	BMW 	X3 (2003>2006) X3 (2006>)
197252	JEEP 	Cherokee (2001>) Cherokee (2004>)

Valeo		  
186968	CITROËN 	C2 (2003>2010) C3 (2005>) C3 (2009>) C3 Picasso (2009>) C4 (2004>) DS3 (2010>) Xsara (2000>2005) Xsara Picasso (99>)
	CITROËN 	Berlingo (2002>) Berlingo (96>2002)
	PEUGEOT 	1007 (2005>) 206 (98>) 207 (2006>) 307 (2001>2005) 307 (2005>)
	PEUGEOT 	Partner (2002>) Partner (96>2002) Ranch (2002>) Ranch (96>2002)
186969	RENAULT 	Mégane II (2002>) Scenic II (2003>)
	RENAULT 	Kangoo (2003>) Kangoo (97>2003)
186970	PEUGEOT 	206 (98>) 206+ (2009>)
186971	CITROËN 	Xsara (97>2000)
	PEUGEOT 	206 (98>) 206+ (2009>)
186972	CITROËN 	C3 (2005>) C4 (2004>) Xsara (2000>2005) Xsara Picasso (99>)
	CITROËN 	Berlingo (2002>)
	PEUGEOT 	1007 (2005>) 206 (98>) 207 (2006>) 307 (2001>2005) 307 (2005>)
	PEUGEOT 	Partner (2002>) Ranch (2002>)

Valeo		  	
186973	AUDI 	A2 (2000>2005) A3 (2000>2003)	
	SEAT 	Ibiza (2008>)	
	SKODA 	Fabia (99>2004) Roomster (2006>)	
	VOLKSWAGEN 	Bora (98>2005) Golf IV (97>2006) Polo VII (2001>) Polo VIII (2005>)	
186974	AUDI 	A3 (2003>2008) A3 (2008>) A3 Cabriolet (2008>)	
	SEAT 	Altea (2004>) Leon (2005>) Toledo (2004>)	
	SKODA 	Octavia (2004>2008) Octavia (2008>)	
	SKODA 	Yeti (2009>)	
	VOLKSWAGEN 	Golf Plus (2005>) Golf Plus (2009>) Golf V (2003>) Golf VI (2008>) Jetta III (2005>)	
	VOLKSWAGEN 	Caddy III (2004>)	
186975	RENAULT 	Clio II (2001>) Clio II (98>2001) Laguna I (98>2000) Laguna I Nevada (98>2000) Mégane (98>2003) Mégane Classic (99>2002) Mégane Scenic (96>99) Mégane Scenic (99>2003)	
	186976	RENAULT 	Mégane Classic (99>2002)
	186977	NISSAN 	Kubistar (2003>)
		RENAULT 	Kangoo (2003>) Kangoo (97>2003)



Valeo		
186978	CITROËN Xsara (97>2000)	
	CITROËN Berlingo (96>2002)	
	PEUGEOT 306 (97>2002)	
	PEUGEOT Partner (96>2002) Ranch (96>2002)	
	RENAULT Laguna II (2001>2005) Laguna II (2005>2007)	
186980	DACIA Logan (2004>)	
	NISSAN Micra (K12E) (2003>2005) Micra (K12E) (2005>) Note (E11E) (2005>2007) Note (E11E) (2008>)	
	RENAULT Clio III (2005>) Clio III (2009>) Modus (2004>2008) Modus (2008>)	
186981	CITROËN C2 (2003>2010) C3 (2002>2005) C3 (2005>)	
186982	NISSAN Kubistar (2003>)	
	RENAULT Kangoo (2003>) Kangoo (97>2003)	
186983	AUDI A1 (2010>) A3 (96>2000)	
	SEAT Cordoba (2002>) Ibiza (2001>) Ibiza (2008>) Toledo (98>2004)	
	SKODA Fabia (2004>2007) Fabia (2006>) Fabia (99>2004) Octavia (2000>) Octavia (96>2000) Roomster (2006>)	
	VOLKSWAGEN Bora (98>2005) Fox (2004>) Golf IV (97>2006) Polo IX (2009>) Polo VII (2001>) Polo VIII (2005>)	

Valeo	
186984	CITROËN C8 (2002>)
	CITROËN Dispatch (2004>2006) Jumpy (2004>2006)
	FIAT Ulysse (2002>)
	LANCIA Phedra (2002>)
	PEUGEOT 807 (2002>)
	PEUGEOT Expert I (2004>2006)
186985	BMW Series 3 (E36) (90>2001) Series 3 (E46) (98>2006) Z3 (E36) (96>2002) Z4 (E85/86) (2002>2009)
	186986
	PEUGEOT 106 (91>96) 106 (96>2003) 306 (97>2002)
186987	NISSAN Primastar (2002>2006) Primastar (2006>)
	OPEL Vivaro (2001>2006) Vivaro (2006>)
	RENAULT Trafic II (2001>2006) Trafic II (2006>)
	VAUXHALL Vivaro (2001>2006) Vivaro (2006>)

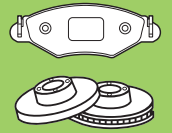
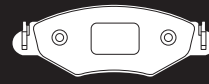

Pads and Discs

Plaquettes et Disques

Pastillas y Discos

Pastilas e Discos

Pastiglie e Dischi

Blokjes en Schijven

Bremsbeläge und Bremsscheiben

Klocki i Tarcze

Balatalari ve Diskleri

Колодки и диски

Δισκόφρενα & Δισκόπλακες

刹车片和刹车盘



بطانات و قرص

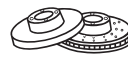

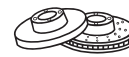

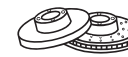
 →	Valeo
	
* 186102	
* 186103	
* 186109	
* 186110	
* 186111	
* 186115	
* 186116	
* 186121	
* 186122	
* 186127	
* 186131	
* 186137	
* 186138	
* 186140	
* 186147	
* 186148	
* 186150	
* 186152	
* 186156	
* 186161	
* 186166	
* 186167	
* 186168	
* 186169	
* 186174	
* 186179	
* 186180	
* 186181	
* 186190	
* 186192	
* 186193	
* 186197	
* 186201	
* 186203	
* 186209	
* 186212	
* 186215	
* 186232	
* 186235	
* 186237	
* 186239	
* 186240	
* 186242	
* 186250	
* 186257	
* 186260	
* 186263	
* 186271	
* 186272	
* 186273	
* 186284	
* 186287	
* 186289	
* 186293	
* 186299	
* 186302	
* 186310	



 →	Valeo
	
* 186312	
* 186314	
* 186405	
* 186407	
* 186409	
* 186412	
* 186414	
* 186417	
* 186419	
* 186422	
* 186424	
* 186429	
* 186430	
* 186431	
* 186432	
* 186434	
* 186436	
* 186437	
* 186441	
* 186443	
* 186444	
* 186445	
* 186447	
* 186448	
* 186449	
* 186450	
* 186451	
* 186452	
* 186453	
* 186455	
* 186456	
* 186458	
* 186459	
* 186460	
* 186461	
* 186463	
* 186464	
* 186465	
* 186466	
* 186468	
* 186478	
* 186480	
* 186481	
* 186483	
* 186486	
* 186489	
* 186491	
* 186492	
* 186494	
* 186497	
* 186498	
* 186499	
* 186501	
* 186503	
* 186506	
* 186507	
* 186508	



 →	Valeo
	
* 186509	
* 186510	
* 186512	
* 186514	
* 186520	
* 186524	
* 186527	
* 186535	
* 186537	
* 186538	
* 186542	
* 186547	
* 186553	
* 186555	
* 186563	
* 186564	
* 186566	
* 186572	
* 186578	
* 186584	
* 186601	
* 186602	
* 186607	
* 186611	
* 186612	
* 186613	
* 186614	
* 186616	
* 186625	
* 186627	
* 186630	
* 186631	
* 186635	
* 186637	
* 186638	
* 186639	
* 186640	
* 186641	
* 186641	
* 186642	
* 186643	
* 186644	
* 186645	
* 186649	
* 186652	
* 186653	
* 186654	
* 186664	
* 186665	
* 186683	
* 186689	
* 186690	
* 186691	
* 186692	
* 186699	
* 186700	
* 186701	



 →	Valeo
	
* 186704	
* 186716	
* 186721	186655
* 186722	197079
* 186723	
* 186733	197069
* 186737	
* 186739	
* 186749	
* 186752	
* 186767	
* 186769	
* 186770	
* 186771	
* 186774	
* 186776	
* 186779	
* 186782	
* 186806	
* 186820	186879
* 186837	197046
* 186862	
* 186867	186822
* 186870	
* 186873	
* 186887	
* 186906	
* 186934	
* 186936	
* 186939	
* 186941	
* 186944	
* 186951	
* 186952	
* 186956	
* 186961	
* 186962	
* 186963	
* 197041	
* 197042	
* 197048	
* 197053	
* 197068	
* 197075	
* 197076	
* 197077	
* 197082	
* 197095	



 →	Valeo
	
* 540148	
* 540731	
* 540887	
* 598003	
* 598008	
* 598042	598212
* 598049	598483
* 598079	598077
* 598107	
* 598111	
* 598117	
* 598130	
* 598145	
* 598146	
* 598163	
* 598164	598338
* 598176	
* 598186	
* 598208	
* 598225	598315
* 598242	
* 598269	
* 598286	
* 598287	598156
* 598297	598880
* 598298	598332
* 598302	598488
* 598304	598982
* 598324	598461
* 598325	598461
* 598333	
* 598346	598396
* 598363	
* 598371	
* 598375	
* 598390	
* 598391	
* 598401	598483
* 598404	598461
* 598455	598926
* 598469	598063
* 598485	598474
* 598487	598332
* 598525	598474
* 598529	598051
* 598555	598018
* 598559	598474
* 598576	598606
* 598603	
* 598604	598555
* 598612	
* 598683	
* 598684	
* 598685	
* 598686	
* 598687	
* 598688	

 →	Valeo
	
* 598689	
* 598690	
* 598691	
* 598692	
* 598694	
* 598695	
* 598749	598860

 →	Valeo
	

 →	Valeo
	



Pads and Discs

Plaquettes et Disques

Pastillas y Discos

Pastilas e Discos

Pastiglie e Dischi

Blokjes en Schijven

Bremsbeläge und Bremsscheiben

Klocki i Tarcze





Balatalari ve Diskleri



Κολοдки и диски







Δισκόφρενα & Δισκόπλακες





刹车片和刹车盘





بطانات و قرص





	
ABARTH 	
Grande Punto (2007>)	44
500 Nuova (2008>)	44
Punto Evo (2010>)	44
ALFA ROMEO 	
33 (83>89)	44
33 (89>94)	44
75 (85>93)	45
90 (84>88)	45
145 (94>2001)	45
146 (94>2001)	46
147 (2000>2004)	46
147 (2004>)	47
155 (91>97)	47
156 (97>2003)	47
156 (2003>2007)	48
159 (2005>)	48
164 (87>92)	49
164 (92>98)	49
166 (98>2003)	49
166 (2003>2007)	49
1750	49
2000	49
Alfa 6 (79>87)	50
Alfasud Sprint (79>89)	50
Alfetta (72>85)	50
Arna (83>87)	50
Brera (2006>)	50
Giulia (64>79)	50
Giulietta (76>86)	51
Giulietta (2010>)	51
GT (2003>)	51
GTV (80>87)	51
GTV (95>2003)	52
GTV (2003>2006)	52
MiTo (2008>)	52
Montreal (70>75)	53
RZ (92>93)	53
Spider (71>93)	53
Spider (95>2003)	53
Spider (2003>2006)	54
Spider II (2006>)	54
SZ (89>91)	54
ALFA ROMEO 	
AR8 (80>86)	54
ARO 	
10 (80>)	54







	
AUDI 	
50 (74>78)	55
80 (72>81)	55
80 (81>86)	55
80 (86>91)	55
80 (91>95)	56
Cabriolet (91>2000)	56
90 (84>87)	57
90 (87>91)	57
100 (68>72)	57
100 (71>82)	57
100 (82>90)	58
100 (90>94)	58
200 (79>90)	59
4000	59
A1 (2010>)	59
A2 (2000>2005)	59
A3 (96>2000)	59
A3 (2000>2003)	60
A3 (2003>2008)	60
A3 (2008>)	60
A3 Cabriolet (2008>)	61
A4 (94>98)	61
A4 (99>2001)	61
A4 (2000>2004)	62
A4 (2004>2008)	62
A4 (2007>)	63
A4 Cabriolet (2002>2005)	63
A4 Cabriolet II (2006>2009)	63
A5 (2007>)	63
A5 Cabriolet (2009>)	63
A6 (94>97)	64
A6 (97>2001)	64
A6 (2001>2005)	64
A6 (2004>2008)	65
A6 (2008>)	65
A6 Allroad (2000>2005)	66
A6 Allroad (2006>2008)	66
A6 Allroad (2008>)	66
A7 (2010>)	66
A8 (94>2002)	66
A8 (2002>2009)	67
Coupé (80>88)	67
Coupé (88>96)	68
Quattro (80>91)	68
RS2 (94>95)	68
RS4 Quattro (2000>2001)	69
RS4 Quattro (2005>2008)	69
RS4 Quattro Cabriolet (2006>2008)	69
RS6 Quattro (2002>2004)	69





	
AUDI (.../...) 	
RS6 (2008>)	69
S3 (98>2003)	69
S3 (2006>)	69
S4 (97>99)	69
S4 (99>2001)	69
S4 (2003>2004)	70
S4 (2004>2008)	70
S4 (2008>)	70
S4 Cabriolet (2004>2005)	70
S4 Cabriolet II (2006>2009)	70
S5 (2007>)	70
S5 Cabriolet (2009>)	70
S6 (94>97)	70
S6 Plus Quattro (96>97)	71
S6 (99>2001)	71
S6 (2001>2005)	71
S6 (2006>2008)	71
S6 (2008>)	71
S8 (96>98)	71
S8 (99>2002)	71
S8 (2006>2007)	71
S8 (2007>)	71
TT (98>2006)	72
TT (2006>)	72
TT RS (2009>)	72
V8 (88>93)	72
AUDI 	
Q5 (2008>)	54
Q7 (2006>)	55
AUTOBIANCHI 	
A111 (69>74)	72
A112 (69>85)	72
Primula (65>71)	73
Y10 (85>95)	73
AUVERLAND 	
A3	73
BEDFORD 	
Brava (88>90)	73
Novavan (82>88)	73
BMW 	
1500 / 2002	74
2500 / 3300	75
Series 1 (E87) (2004>)	75
Series 1 (E81/82/88) (2007>)	75
Series 3 (E21) (75>83)	76
Series 3 (E31) (82>93)	76
Series 3 (E36) (90>2001)	77





	
BMW (.../...) 	
Series 3 (E46) (98>2006)	77
Series 3 (E90/91/92/93) (2005>)	78
Series 3 (E90/91/93) (2007>)	79
Series 5 (E12) (72>81)	80
Series 5 (E28) (81>88)	80
Series 5 (E34) (88>96)	80
Series 5 (E39) (95>2004)	80
Series 5 (E60/61) (2003>)	81
Series 6 (E24) (76>89)	82
Series 6 (E63/64) (2003>)	82
Series 7 (E23) (77>86)	83
Series 7 (E32) (86>94)	83
Series 7 (E38) (94>2001)	83
Series 7 (E65) (2001>2008)	83
Series 7 (E66) (2002>2008)	84
Series 7 (F01/F02/F04) (2008>)	84
Series 8 (E31) (89>2000)	84
M3 (E30) (86>91)	84
M3 (E36) (92>2000)	84
M3 (E46) (2000>2006)	84
M3 (E90/92/93) (2007>)	85
M5 (E12) (80>81)	85
M5 (E28) (84>88)	85
M5 (E34) (88>95)	85
M5 (E39) (99>2003)	85
M5 (E60) (2004>)	85
M5 (E61) (2007>)	85
M6 (E63/64) (2007>)	86
Z1 (E30) (89>92)	86
Z3 (E36) (96>2002)	86
Z4 (E85/86) (2002>2009)	86
Z4 (E89) (2009>)	87
Z8 (E52) (2000>2003)	87
BMW 	
X1 (2009>)	73
X3 (2003>2006)	73
X3 (2006>)	73
X5 (2000>2006)	74
X5 (2006>)	74
X6 (2008>)	74
CADILLAC 	
BLS (2005>)	87
CTS (2002>)	87
CHEVROLET 	
Aveo (2005>2008)	87
Captiva (2006>)	87
Épica (2006>)	87
Evanda (2005>)	88



	
CHEVROLET (.../...) 	
Kalos (2005>)	88
Lacetti (2005>)	88
Matiz (2005>)	88
Nubira (2005>)	88
Rezzo (2005>2008)	88
Spark (2005>)	88
Tacuma (2005>2008)	88
CHRYSLER 	
300C (2004>)	88
300M (98>2003)	88
Crossfire (2003>)	89
Le Baron (81>96)	89
Neon (93>)	89
PT Cruiser (2000>2009)	89
Saratoga (88>90)	89
Sebring (2000>2007)	89
Stratus (94>)	89
Vision (92>98)	89
Voyager II (91>95)	90
Voyager III (96>2001)	90
Voyager IV (2001>)	90
Voyager V (2004>)	90
Grand Voyager (92>95)	90
Grand Voyager (96>2001)	90
Grand Voyager (2001>2004)	90
Grand Voyager (2004>2008)	90
CITROËN 	
2 CV	91
Ami 8	91
AX (86>91)	91
AX (91>98)	92
Axel (84>90)	92
BX (82>94)	92
C1 (2005>)	92
C2 (2003>2010)	92
C3 (2002>2005)	92
C3 (2005>)	93
C3 (2009>)	93
C3 Pluriel (2003>)	93
C3 Picasso (2009>)	93
C4 (2004>)	93
C4 Picasso (2006>)	94
C5 (2001>2008)	94
C5 (2008>)	95
C6 (2005>)	95
C8 (2002>)	95
CX (74>91)	95
DS3 (2010>)	96





	
CITROËN (.../...) 	
Dyane (67>83)	96
Evasion (94>98)	96
Evasion (98>2002)	96
Fukang (93>)	96
GS (70>80)	97
GSA (79>86)	97
LN/LNA (76>86)	97
Mehari (68>87)	97
Saxo (96>99)	97
Saxo (99>2005)	97
Synergie (95>98)	98
Synergie (98>2002)	98
Visa (78>88)	98
Xantia (93>97)	98
Xantia (97>2002)	99
XM (89>94)	99
XM (94>2001)	99
Xsara (97>2000)	100
Xsara (2000>2005)	100
Xsara Picasso (99>)	100
ZX (91>98)	101
CITROËN 	
C Crosser	91
CITROËN 	
Acadiane (78>87)	101
Berlingo (96>2002)	101
Berlingo (2002>)	101
Berlingo (2008>)	102
C15 (84>2005)	102
C25 (81>90)	102
C25 (90>94)	102
C32 (73>79)	102
C35 (73>91)	102
Dispatch (95>2003)	102
Dispatch (2004>2006)	103
Dispatch (2007>)	103
Jumper (94>2001)	103
Jumper (2002>2006)	103
Jumper II (2006>)	103
Jumpy (95>2003)	104
Jumpy (2004>2006)	104
Jumpy (2007>)	104
Nemo (2007>)	104
Relay (94>2001)	104
Relay (2002>2006)	104
Relay II (2006>)	104
DACIA 	
1210 (85>2004)	105





	
DACIA (.../...) 	
1310 (85>2004)	105
1410 (85>2004)	105
Duster (84>99)	105
Duster (2010>)	105
Logan (2004>)	105
SuperNova (2000>2003)	106
Sandero (2008>)	106
Solenza (2003>2005)	106
DAEWOO 	
Aranos (95>)	106
Espero (93>99)	106
Evanda (2002>2005)	106
Kalos (2002>)	107
Lacetti (2003>2004)	107
Lanos (97>)	107
Leganza (97>2003)	107
Matiz (98>2005)	107
Nexia (95>)	107
Nubira (97>)	107
Rezzo (2000>)	107
Tacuma (2000>)	107
DAEWOO 	
Korando KJ (99>)	106
Musso (99>)	106
DAEWOO 	
Lublin (97>)	108
DAF 	
400 (86>96)	108
DAIHATSU 	
Applause (89>)	108
Charade (93>2001)	108
Copen (2003>2006)	109
Copen (2006>)	109
Cuore (90>94)	109
Cuore (94>98)	109
Cuore (98>2003)	109
Cuore (2003>2005)	109
Cuore (2005>2007)	109
Cuore (2007>)	109
Domino (90>94)	109
Domino (94>98)	109
Domino (98>2000)	109
Gran Move (96>)	109
Materia (2006>)	110
Mira (92>94)	110
Mira (94>98)	110
Move (97>99)	110





	
DAIHATSU (.../...) 	
Move (99>2002)	110
Sirion (98>2005)	110
Sirion II (2005>)	110
Terios (97>2006)	110
Terios II (2006>)	110
Trevis (2006>)	110
Valera (94>)	110
YRV (2000>)	110
DAIHATSU 	
Feroza (88>97)	108
Fourtrak (85>93)	108
Rocky (84>93)	108
Rocky (93>)	108
Sportrak (89>97)	108
DODGE 	
Caliber (2006>)	111
FIAT 	
124 (66>77)	111
125 (67>73)	111
127/128 (66>86)	111
131/132 (72>85)	111
500 Nuova (2007>)	112
900 (76>87)	112
Albea (2002>)	112
Argenta (81>86)	112
Barchetta (95>2003)	112
Barchetta (2003>)	112
Brava (95>2002)	112
Bravo (95>2002)	113
Bravo II (2007>)	113
Cinquecento (92>98)	113
Coupe (93>2000)	113
Croma (85>90)	114
Croma (91>96)	114
Croma II (2005>2007)	115
Croma II (2007>)	115
Idea (2003>2007)	115
Idea (2007>)	115
Linea (2007>)	115
Marea (96>2002)	116
Marengo (159) (89>95)	116
Marengo (185) (95>)	116
Multipla (98>2003)	116
Multipla (2004>)	116
Palio (96>2001)	117
Palio (2001>)	117
Palio Week End (97>2001)	117
Palio Week End (2001>2002)	117





	
FIAT (.../...) 	
Panda (80>86)	117
Panda (86>2003)	118
Panda (2003>)	118
Punto (93>99)	118
Punto II (99>2003)	119
Punto II (2003>)	119
Grande Punto (2005>)	119
Punto Evo (2009>)	120
Qubo (2008>)	120
Regata (83>90)	120
Ritmo (78>82)	120
Ritmo (82>88)	120
Seicento (98>2005)	120
Siena (97>2001)	121
Siena (2002>)	121
Spider (82>85)	121
Stilo (2001>2003)	121
Stilo (2004>)	121
Strada (85>88)	122
Tempra (89>93)	122
Tempra (93>96)	122
Tipo (88>93)	123
Tipo (93>95)	123
Ulysse (94>98)	123
Ulysse (98>2002)	123
Ulysse (2002>)	124
Uno (83>89)	124
Uno (89>95)	124
Uno CS (87>)	125
Uno Mondo (98>)	125
X1/9 (69>89)	125
FIAT 	
Sedici (2006>2009)	111
Sedici (2009>)	111
FIAT 	
242 (73>85)	125
Doblo (2000>2003)	125
Doblo (2004>2005)	125
Doblo II (2006>)	125
Doblo III (2010>)	125
Doblo Cargo (2000>2003)	125
Doblo Cargo (2004>2005)	125
Doblo Cargo II (2006>)	125
Doblo Cargo III (2010>)	126
Ducato (81>85)	126
Ducato (85>90)	126
Ducato (90>94)	126
Ducato (94>2001)	126





	
FIAT (.../...) 	
Ducato (2002>2006)	127
Ducato (2006>)	127
Ducato RU (2008>)	127
Duna (87>91)	128
Fiorino (127) (78>87)	128
Fiorino (147) (81>89)	128
Fiorino (146) (88>93)	128
Fiorino (146) (93>2000)	128
Fiorino (2007>)	128
Scudo (95>2003)	128
Scudo (2004>2006)	128
Scudo (2007>)	128
Strada Pick Up (99>2003)	128
Strada Pick up (2003>2006)	129
Strada II Pick-up (2006>)	129
Talento (88>94)	129
FORD 	
Capri (68>87)	129
Cortina (76>82)	130
Cougar (98>2001)	130
Escort (67>74)	130
Escort (74>80)	130
Escort (80>86)	130
Escort (86>90)	130
Escort (90>94)	130
Escort (95>2001)	131
Fiesta (76>83)	131
Fiesta (83>89)	131
Fiesta (89>95)	132
Fiesta (95>99)	132
Fiesta (99>2002)	132
Fiesta (2002>2005)	132
Fiesta (2005>2008)	133
Fiesta (2008>)	133
Focus (98>2001)	133
Focus (2001>2004)	133
Focus (2004>)	133
Focus II (2007>)	134
Focus C-Max (2003>2007)	134
Focus C-Max (2007>)	134
Focus Coupé Cabriolet (2006>)	135
Fusion (2002>2005)	135
Fusion (2005>)	135
Galaxy (95>2000)	135
Galaxy (2000>2006)	135
Galaxy (2006>)	135
Granada (77>82)	136
Granada (85>91)	136
Granada (92>95)	136









	
FORD (.../...) 	
Ka (96>2008)	136
Ka (2008>)	137
Kuga (2008>)	137
Mondeo (93>96)	137
Mondeo (96>2000)	137
Mondeo (2000>2003)	137
Mondeo (2003>2005)	138
Mondeo (2005>2007)	138
Mondeo (2007>)	138
Orion (83>90)	138
Orion (90>93)	138
Probe (92>97)	138
Puma (97>2001)	139
Scorpio (85>92)	139
Scorpio (92>94)	139
Scorpio (94>98)	139
Sierra (82>86)	140
Sierra (87>93)	140
S-Max (2006>)	141
StreetKa (2002>2005)	142
Taurus (76>82)	142
FORD 	
Explorer (90>)	129
Maverick (93>98)	129
Maverick (2000>2006)	129
Ranger II (2002>2007)	129
FORD 	
Courier (91>96)	142
Courier Courier (96>2002)	142
P100 Pick-up (82>87)	142
P100 Pick-up (88>93)	142
Tourneo Connect (2002>2006)	142
Tourneo Connect (2006>)	142
Transit (78>85)	143
Transit (85>91)	143
Transit (91>94)	143
Transit (94>99)	143
Transit (2000>2006)	143
Transit (2006>)	143
Transit Connect (2002>2006)	144
Transit Connect (2006>)	144
FSO POLSKI 	
125 (71>92)	144
Atou (95>97)	144
Caro (91>99)	145
Celina (95>98)	145
Polonez (78>92)	145







	
FSO POLSKI 	
Truck (92>)	145
GALLOPER 	
Galopper (98>)	145
Santamo (98>)	145
HONDA 	
Accord I (76>83)	146
Accord II (83>85)	146
Accord III (85>89)	146
Accord IV (89>93)	146
Accord V (93>95)	146
Accord V (95>98)	147
Accord VI (98>2003)	147
Accord VII (2003>2008)	147
Accord Aerodeck (85>89)	147
Accord Aerodeck (90>93)	147
Accord Aerodeck (93>97)	148
Accord coupe (91>93)	148
Accord coupe (93>97)	148
Accord coupe (97>2002)	148
Ballade (80>83)	148
Ballade (83>90)	148
Civic I (72>83)	148
Civic II (83>87)	148
Civic III (87>91)	149
Civic IV (91>95)	149
Civic V (MA/MB) (95>2001)	149
Civic V (EJ*) (96>2000)	149
Civic V (EJ/EK) (95>2001)	150
Civic (EP) (2001>2006)	150
Civic (FK/FD) (2006>)	150
Civic Aerodeck (97>2001)	151
Civic Shuttle (83>87)	151
Civic Shuttle (87>92)	151
Concerto (89>96)	151
CRX (83>88)	151
CRX (87>92)	151
CRX (92>98)	152
FR-V (2004>2007)	152
FR-V (2007>2010)	152
HR-V (98>2005)	152
Insight (2000>2006)	152
Integra (85>89)	152
Integra (97>2001)	152
Jazz II (J) (2002>2008)	152
Legend (85>90)	153
Legend (90>96)	153
Legend (96>2006)	153
Logo (98>2001)	153





	
HONDA (.../...) 	
NSX (89>2001)	153
NSX (2001>2005)	153
Odyssey (97>)	153
Prelude (79>82)	154
Prelude (82>87)	154
Prelude (87>91)	154
Prelude (91>96)	154
Prelude (96>2001)	154
Quintet (80>84)	155
S2000 (99>2004)	155
S2000 (2004>2009)	155
Shuttle (94>2000)	155
Stream (2001>2005)	155
HONDA 	
CR-V (97>2002)	145
CR-V (2002>2006)	145
CR-V (2006>)	145
HYUNDAI 	
Accent (94>99)	156
Accent (99>2003)	156
Accent (2003>)	156
Accent TR (2005>)	156
Amica (2000>2001)	156
Amica (2001>2003)	157
Atos/Atoz (98>2001)	157
Atos (2001>2004)	157
Atos (2004>)	157
Atos Prime (99>2001)	157
Atos Prime (2001>2004)	157
Atos Prime (2004>)	157
Coupe (95>2001)	157
Coupe (2002>2006)	157
Elantra (90>95)	157
Elantra (95>2000)	158
Elantra (2000>2007)	158
Excel (86>89)	158
Excel (89>94)	158
Excel (94>99)	158
Getz (2002>2005)	158
Getz (2005>)	158
Grandeur Azera (2005>)	159
i10 (2007>)	159
i20 (2008>)	159
i30 (2007>)	159
i30 (CZ) (2008>)	159
Lantra (90>95)	159
Lantra (95>2000)	160
Matrix (2001>2008)	160





	
HYUNDAI (.../...) 	
Matrix (2008>)	160
Plaza (98>)	160
Pony (82>94)	160
Pony (94>99)	160
Satellite (98>2007)	160
Scoupe (90>96)	161
Sonata (88>93)	161
Sonata (93>98)	161
Sonata (98>2001)	161
Sonata (2001>2005)	161
Sonata (2005>)	161
Sonica (98>2001)	161
Starex (98>)	162
Stellar (83>92)	162
Tiburon (2002>)	162
Trajet (2000>2004)	162
Trajet (2004>)	162
XG (99>2002)	162
XG (2002>)	162
HYUNDAI 	
Galloper (97>2002)	155
Santa Fé (2000>2006)	155
Santa Fé (2006>)	155
Santamo (98>2001)	156
Terracan (2001>2002)	156
Terracan (2002>2007)	156
Tucson (2004>)	156
HYUNDAI 	
H1 (97>)	162
H100 (93>)	163
Highway Van (2000>2004)	163
Jobs (98>)	163
INFINITI 	
EX (2008>)	163
FX (2003>)	163
FX (2008>)	163
INNOCENTI 	
Elba (91>97)	163
Koral (90>)	163
Mini (74>84)	163
Mini tre (82>93)	163
ISUZU 	
Trooper (81>97)	164
Trooper (98>)	164
IVECO 	
Daily (78>89)	164







	
IVECO (.../...) 	
Daily (89>96)	165
Daily (96>99)	165
Daily (99>)	165
Daily (2006>)	166
JAGUAR 	
S-Type (98>2003)	166
S-Type (2004>)	167
Sovereign (94>)	167
Sovereign (2002>)	167
XJ (73>86)	167
XJ (86>94)	167
XJ (94>2002)	167
XJ (2002>)	167
XJR (88>94)	168
XJR (94>)	168
XK (2004>)	168
XK8 (96>2004)	168
XK8 (2004>)	168
X-Type (2001>2008)	168
JEEP 	
Cherokee (77>)	168
Cherokee (2001>)	169
Cherokee (2004>)	169
Commander (2005>)	169
Compass (2006>)	169
Grand Cherokee (93>2000)	169
Grand Cherokee (2000>2003)	169
Grand Cherokee (2003>2005)	169
Grand Cherokee (2005>)	169
Wrangler (96>2006)	170
Wrangler (2006>)	170
KIA 	
Carens (99>2002)	171
Carens (2002>2006)	171
Carens (2006>)	171
Carnival (99>2002)	171
Carnival (2002>2006)	171
Carnival (2006>)	171
Ceed (2006>)	171
Cerato (2004>)	171
Clarus (95>2001)	171
Credos (97>)	172
Joice (99>)	172
Leo (96>)	172
Magentis (2001>2005)	172
Magentis (2006>)	172
Mentor (94>2001)	172
Mentor (2001>2004)	172





 	
KIA (.../...) 	
Picanto (2004>2007)	172
Picanto (2007>)	172
Pride (87>2000)	173
Pride Wagon (98>2000)	173
Rio (2000>2005)	173
Rio (2005>2008)	173
Sedona (99>2002)	173
Sedona (2002>)	173
Sephia (93>98)	173
Sephia (98>2001)	173
Shuma (98>2002)	173
Shuma (2001>2004)	174
Venga (2009>)	174
KIA 	
Retona (99>)	170
Sorento (2002>2006)	170
Sorento (2006>)	170
Sportage (93>2002)	170
Sportage (2004>)	170
KIA 	
Besta (86>99)	174
Pregio (95>2005)	174
LADA 	
110 (95>)	174
111 (95>)	174
112 (95>)	174
1200/1300/1500/1600/ Classica	174
Kalinka (95>98)	175
Natacha (93>)	175
Sagona (91>)	175
Samara (86>)	175
Vega	175
LADA 	
Niva (76>)	174
LANCIA 	
Beta (72>85)	175
Dedra (89>94)	175
Dedra (94>99)	175
Delta (79>86)	176
Delta (86>93)	176
Delta (93>99)	176
Delta (2008>)	177
Kappa (94>2001)	177
Lybra (99>2006)	178
Musa (2004>2007)	178
Musa (2007>)	178
Phedra (2002>)	179





 	
LANCIA (.../...) 	
Prisma (83>86)	179
Prisma (86>89)	179
Thema (84>88)	179
Thema (88>92)	180
Thema (92>94)	180
Thesis (2002>)	180
Trevi (80>85)	180
Y Ipsilon (95>2000)	181
Y Ipsilon (2000>2003)	181
Y Ipsilon (2003>)	181
Y10 (89>95)	181
Zeta (94>2002)	181
LAND ROVER 	
Defender (90>2007)	181
Defender II (2007>)	182
Discovery (89>94)	182
Discovery (94>98)	182
Discovery (98>2004)	182
Discovery (2004>)	183
Freelander (97>2003)	183
Freelander (2003>2006)	183
Freelander 2 (2006>)	183
Land 90	183
Land 110	183
Range Rover (81>86)	183
Range Rover (86>94)	184
Range Rover (94>2002)	184
Range Rover (2002>)	184
Range Rover Sport (2005>)	184
LDV 	
Maxus (2005>)	185
Sherpa II (82>89)	185
LEXUS 	
GS 300 (93>97)	185
GS 300 (97>2004)	185
GS 300 (2005>)	186
GS 430 (2000>2004)	186
GS 430 (2005>)	186
GS 450 (2006>)	186
IS I (99>2005)	186
IS 220D (2005>)	186
IS 250 (2005>)	186
IS 300 (99>2005)	186
LS400 (89>94)	187
LS400 (94>2000)	187
LS430 (2000>2008)	187
LS460 (2006>)	187
SC430 (2001>)	187





 	
LEXUS 	
LX 470 (2002>2007)	185
RX 300 (2000>2003)	185
RX 300 (2003>2006)	185
RX 350 (2006>)	185
RX 400 (2005>)	185
MARUTI 	
800	187
MAZDA 	
2 (2003>2008)	188
2 (2007>)	188
3 (2003>2006)	188
3 (2006>)	188
3 (2008>)	189
5 (2005>)	189
6 (2002>2007)	189
6 (2007>)	189
121 (88>90)	190
121 (90>96)	190
121 (96>)	190
323 (BD) (80>85)	190
323 (BF) (85>89)	190
323 (BG) (89>94)	190
323 (BA) (94>98)	190
323 (BJ) (98>2000)	191
323 (BJ) (2000>2003)	191
323 Wagon (BW) (86>93)	191
616 (SN) (73>78)	191
626 (GC) (82>87)	191
626 (GD) (87>92)	191
626 (GE) (91>97)	192
626 (GF) (97>2002)	192
626 Wagon (GV) (88>92)	192
626 Wagon (GV) (92>97)	192
626 Wagon (GW) (97>99)	192
626 Wagon (GW) (99>2002)	193
Demio (98>2003)	193
MPV (95>99)	193
MPV (99>2002)	193
MPV (2002>2006)	193
MX3 (91>98)	193
MX5 (90>98)	193
MX5 (98>2000)	193
MX5 (2000>2005)	194
MX5 (2005>)	194
MX6 (91>97)	194
Premacy (99>2001)	194
Premacy (2001>2005)	194
RX7 (85>91)	194





	
MAZDA (.../...) 	
RX7 (92>)	194
RX8 (2003>)	195
Xedos 6 (91>99)	195
MAZDA 	
B Pick-up (89>99)	187
B Pick-up (99>)	188
BT50 (2006>)	188
CX-7 (2007>)	188
MERCEDES 	
190 (201) (82>93)	196
200/300 (W123) (76>85)	197
200/300 (W124) (84>93)	197
Class A (W168) (97>2004)	199
Class A (W169) (2004>2008)	199
Class A (W169) (2008>)	199
Class B (W245) (2005>2008)	199
Class B (W245) (2008>)	200
Class C (W202) (93>2001)	200
Class C (W203) (2000>2003)	201
Class C (W203) (2004>)	201
Class C (W204) (2007>)	202
Class CL (W215) (99>2006)	202
Class CL (W216) (2006>)	203
Class CLC (W203) (2008>)	203
Class CLK (W208) (97>2003)	203
Class CLK (W209) (2002>2009)	204
Class CLS (W219) (2004>2008)	204
Class CLS (W219) (2008>)	205
Class E (W124) (93>98)	205
Class E (W210) (95>2003)	206
Class E (W211) (2002>2006)	207
Class E (W211) (2006>2009)	207
Class E (207-212) (2009>)	208
Class R (W251) (2005>)	208
Class S (W116) (72>80)	209
Class S (W126) (79>91)	209
Class S (W140) (91>93)	209
Class S (W140) (93>99)	209
Class S (W220) (98>2004)	210
Class S (W221) (2004>)	210
Class SL (C107) (71>81)	211
Class SL (R107) (71>89)	211
Class SL (129) (89>2001)	211
Class SL (230) (2001>2008)	212
Class SL (230) (2008>)	212
Class SLK (170) (96>2003)	212
Class SLK (171) (2004>2007)	213
Class SLK (171) (2008>)	213





	
MERCEDES (.../...) 	
Class V (96>2002)	213
Vaneo (2001>)	214
MERCEDES 	
Class G (M460) (79>89)	195
Class G (M461/3) (89>)	195
Class GL (164) (2006>)	195
Class GLK (2008>)	195
Class ML (163) (97>2005)	195
Class ML (164) (2005>2008)	196
Class ML (164) (2008>)	196
MERCEDES 	
MB100	214
Sprinter (95>2006)	214
Sprinter II (2006>)	215
Transporter 207-410 (77>96)	215
Viano (2003>)	215
Vito (96>2003)	215
Vito (2003>)	215
MG 	
Midget (62>80)	216
MG F (95>2002)	216
MG TF (2002>2005)	216
MG ZR (2001>2005)	216
MG ZS (2001>2005)	216
MG ZT (2001>2005)	216
MINI 	
MINI (R50/52/53) (2001>)	217
MINI (R56/57) (2006>)	217
MINI (R56/57) (2009>)	217
MINI Clubman (2007>)	217
MINI Clubman (2009>)	218
MINI Countryman (2010>)	218
MITSUBISHI 	
3000 GT (90>2000)	221
Carisma (95>99)	222
Carisma (99>2003)	222
Challenger (98>)	222
Colt (78>84)	222
Colt (84>89)	222
Colt (88>92)	222
Colt (91>96)	223
Colt (95>2003)	223
Colt (2004>)	223
Cordia (81>85)	223
Galant (80>84)	223
Galant (84>87)	224
Galant (87>92)	224







	
MITSUBISHI (.../...) 	
Galant (92>96)	224
Galant (96>2003)	225
Galant (2006>)	225
Grandis (2004>)	225
Lancer (A17) (79>83)	225
Lancer (CB/CD4) (92>)	225
Lancer (CK1/CP) (95>)	225
Lancer F (C1) (84>88)	225
Lancer F (CV) (85>92)	226
Lancer F (C6/7) (88>95)	226
Lancer F (CB/CD) (91>96)	226
Lancer (CS/CT) (2003>)	227
Lancer Evolution (98>)	227
Lancer (CY) (2007>)	227
Lancer Sportback (CX) (2008>)	228
Sigma (90>94)	228
Space Gear (94>98)	228
Space Star (98>)	228
Space Wagon (D0) (83>91)	228
Space Wagon (N3) (91>2000)	228
Space Wagon (N8) (98>2004)	228
MITSUBISHI 	
L200 (K1/2/3) (86>2001)	218
L200 (K6/7) (96>2007)	218
L200 (K84T) (2006>)	219
Montero (V2/4) (93>2006)	219
Montero Sport (K9) (98>2009)	219
Outlander (CU) (2003>2008)	219
Outlander (CW) (2006>)	219
Pajero (L0/1) (83>91)	219
Pajero (V2/4) (90>2001)	219
Pajero (VD/VF) (2000>2006)	220
Pajero (2006>)	220
Pajero Sport (K9) (98>2009)	220
Pajero Pinin (H7) (99>)	220
Sapporo (76>90)	220
Shogun (L0/1) (83>91)	220
Shogun (V2/4) (90>2001)	220
Shogun (V6/7) (2000>2006)	221
Shogun (2006>)	221
Shogun Pinin (99>)	221
Space Runner (91>)	221
MITSUBISHI 	
Canter	229
L300 (P0/1/2/3)	229
L300 (L030)	229
L 300 (Truck) (94>2000)	229
L400 (PA/PB/PD)	229



 	
NISSAN 	
100 NX (B13) (90>94)	232
200 SX (S13) (88>94)	232
200 SX (S14) (94>)	232
300 ZX (Z31) (84>89)	232
350Z (Z33) (2003>)	233
Almera (N15) (95>2000)	233
Almera (N16E) (2000>2003)	233
Almera (N16E) (2003>2006)	233
Almera Tino (V10M) (2000>2003)	234
Almera Tino (V10B) (2003>2005)	234
Bluebird (910) (80>84)	234
Bluebird (T12) (85>90)	234
Bluebird (T72) (85>90)	234
Bluebird (U11) (83>90)	234
Cedric (Y30) (83>88)	235
Cherry (N12) (82>87)	235
Cube (2010>)	235
Laurel (C31) (81>84)	235
Laurel (C32) (85>90)	235
Maxima (J30) (88>94)	235
Maxima QX (A32) (88>94)	236
Maxima QX (CA33) (2000>2006)	236
Micra (K10) (82>92)	236
Micra (K11E) (92>2000)	236
Micra (K11E) (2000>2002)	236
Micra (K12E) (2003>2005)	236
Micra (K12E) (2005>)	236
Note (E11E) (2005>2007)	236
Note (E11E) (2008>)	236
Pixo (2009>)	237
Prairie (M10) (82>88)	237
Prairie (M11) (88>94)	237
Primera (P10/W10) (90>98)	237
Primera (P11/W11) (96>2002)	237
Primera (P12/W12) (2001>)	237
Qashqai (2007>2010)	238
Qashqai (2010>)	238
Serena (C23M) (92>2001)	238
Silvia (S12) (83>88)	238
Stanza (T11) (81>85)	238
Sunny (B11) (81>86)	238
Sunny (B12) (86>90)	238
Sunny (N13) (86>90)	239
Sunny (N14) (90>95)	239
Sunny (Y10) (90>2000)	239
Tiida (C11X) (2007>)	239
NISSAN 	
720 Pick-up (79>85)	229
D21 Pick-up (85>98)	229







 	
NISSAN (.../...) 	
D22 King Cab (98>)	230
Murano (Z50) (2005>)	230
Navara (D40M) (2005>)	230
Pathfinder (D21) (86>98)	230
Pathfinder (R50) (97>2003)	230
Pathfinder (R51M) (2005>)	230
Patrol 160 Made in Japan (80>85)	230
Patrol 160 Made in Spain (79>85)	231
Patrol 260 (84>96)	231
Patrol GR (Y60) (88>97)	231
Patrol GR (Y61) (97>2004)	231
Patrol GR (Y61) (2004>)	231
Terrano (WD21) (87>95)	231
Terrano (R20) (93>2004)	231
Terrano (R20) (2004>2006)	231
X-Trail (T30) (2001>2003)	231
X-Trail (T30) (2003>2007)	232
X-Trail (T31) (2007>)	232
NISSAN 	
Cabstar (98>2006)	240
Cabstar (2006>)	240
Interstar (2002>2006)	240
Interstar (2006>)	240
Kubistar (2003>)	240
Primastar (2002>2006)	240
Primastar (2006>)	240
Trade (84>)	240
Urvan (E24) (87>97)	241
Vanette (C120) Made in Japan (81>86)	241
Vanette (C120) Made in Spain (86>94)	241
Vanette (C220) Made in Spain (86>94)	241
Vanette (C23M) (92>2001)	241
Vanette (GC22) (86>93)	241
OPEL 	
Agila (2000>2007)	242
Agila (2007>)	242
Ascona A (70>75)	242
Ascona B (75>81)	242
Ascona C (81>88)	243
Astra F (91>2001)	243
Astra Classic (98>2002)	243
Astra G (98>2005)	244
Astra H (2004>)	244
Astra J (2009>)	245
Calibra (89>97)	245
Commodore (78>82)	245
Corsa A (82>93)	245
Corsa B (93>2000)	246









 	
OPEL (.../...) 	
Corsa C (2000>2003)	246
Corsa C (2003>2006)	246
Corsa D (2006>)	246
Insignia (2009>)	247
Kadett C (73>79)	247
Kadett D (79>84)	247
Kadett E (84>91)	247
Manta A (70>75)	248
Manta B (75>88)	248
Meriva (2003>)	248
Meriva (2010>)	249
Monza (78>86)	249
Omega A (86>94)	249
Omega B (94>2003)	250
Rekord D (72>77)	250
Rekord E (77>86)	250
Senator A (78>87)	250
Senator B (87>93)	251
Signum A (2003>2005)	251
Signum B (2005>2008)	251
Sintra (96>99)	251
Speedster (2000>2005)	252
Tigra (94>2001)	252
Tigra Twintop (2004>2008)	252
Vectra A (88>95)	252
Vectra B (95>99)	253
Vectra B (99>2003)	253
Vectra C (2002>2005)	253
Vectra C (2005>2009)	254
Zafira A (98>2003)	254
Zafira A (2003>2005)	254
Zafira B (2005>2008)	255
Zafira B (2008>)	255
OPEL 	
Antara (2006>)	241
Frontera A (91>98)	241
Frontera B (98>2005)	242
Monterey (91>99)	242
OPEL 	
Arena (98>2001)	255
Campo (88>96)	255
Campo (96>)	255
Combo (85>93)	255
Combo (93>2001)	256
Combo/Combo Tour (2001>)	256
Movano (98>2003)	256
Movano (2003>2006)	256
Movano (2006>)	256









	
OPEL (.../...) 	
Movano (2010>)	257
Vivaro (2001>2006)	257
Vivaro (2006>)	257
PEUGEOT 	
104 (72>88)	257
106 (91>96)	257
106 (96>2003)	258
107 (2005>)	258
1007 (2005>)	258
204 (65>77)	258
205 (83>87)	258
205 (87>98)	259
206 (98>)	259
206+ (2009>)	261
207 (2006>)	261
304 (69>80)	262
305 (77>82)	262
305 (82>90)	262
306 (93>97)	262
306 (97>2002)	262
307 (2001>2005)	263
307 (2005>)	263
308 (2007>)	264
3008 (2009>)	264
309 (85>89)	264
309 (89>94)	264
405 (87>92)	265
405 (92>96)	265
406 (95>2004)	265
407 (2004>)	266
504 (68>2000)	266
505 (79>90)	266
5008 (2009>)	267
604 (76>86)	267
605 (89>94)	267
605 (94>99)	268
607 (2000>2004)	268
607 (2004>)	268
806 (94>98)	268
806 (98>2002)	268
807 (2002>)	268
RCZ (2010>)	269
PEUGEOT 	
4007 (2007>)	257
PEUGEOT 	
Bipper (2007>)	269
Boxer I (94>2001)	269
Boxer I (2002>2006)	269







	
PEUGEOT (.../...) 	
Boxer II (2006>)	270
Expert I (95>2003)	270
Expert I (2004>2006)	270
Expert II (2007>)	270
J5 (81>90)	270
J5 (90>94)	270
J7 (65>80)	271
J9 (80>91)	271
P4 (86>)	271
Partner (96>2002)	271
Partner (2002>)	271
Partner (2008>)	271
Ranch (96>2002)	271
Ranch (2002>)	272
PORSCHE 	
911 (70>83)	272
911 (996) (97>2005)	273
Boxster (96>2002)	273
Boxster (2002>2004)	273
Boxster (2004>)	273
Cayman (2005>)	273
PORSCHE 	
Cayenne (2003>)	272
PROTON 	
300 (96>)	273
400 (93>)	273
RELIANT 	
Scimitar (68>92)	274
RENAULT 	
R4 (62>92)	274
R5 (72>85)	274
Super 5 (84>96)	275
R6 (68>80)	275
R9 (81>88)	275
R11 (82>89)	275
R12 (69>80)	276
R14 (76>84)	276
R15 (71>80)	276
R16 (65>80)	276
R17 (71>80)	276
R18 (77>86)	276
R19 (88>92)	277
R19 (92>95)	277
R20 (75>84)	277
R21 (86>94)	278
R21 Nevada Savanna (86>95)	278
R25 (83>92)	279





	
RENAULT (.../...) 	
R30 (75>84)	279
Alpine A310	279
Alpine A610	279
Alpine GT D500	279
Avantime (2001>2003)	279
Clio I (90>96)	280
Clio I (96>98)	280
Clio II (98>2001)	280
Clio II (2001>)	280
Clio III (2005>)	281
Clio III (2009>)	281
Clio Campus Evolution (2009>)	282
Espace I (84>91)	282
Espace II (91>96)	282
Espace III (96>2000)	282
Espace III (2000>2002)	283
Espace IV (2002>2006)	283
Espace IV (2006>)	283
Fluence (2009>)	283
Fuego (79>85)	283
Laguna I (94>98)	284
Laguna I (98>2000)	284
Laguna I Nevada (95>98)	285
Laguna I Nevada (98>2000)	285
Laguna II (2001>2005)	286
Laguna II (2005>2007)	286
Laguna III (2007>)	287
Lutecia (Japan) (94>98)	287
Mégane (95>99)	287
Mégane (98>2003)	287
Mégane Classic (96>99)	288
Mégane Classic (99>2002)	288
Mégane II (2002>)	289
Mégane III (2008>)	290
Mégane Scenic (96>99)	290
Mégane Scenic (99>2003)	291
Modus (2004>2008)	291
Modus (2008>)	291
Rodeo (70>86)	291
Safrane (92>96)	291
Safrane (96>2000)	292
Scenic II (2003>)	292
Grand Scenic II (2003>)	293
Scenic III (2009>)	293
Spider (96>99)	293
Thalia (2001>)	293
Twingo I (93>98)	294
Twingo II (98>2007)	294
Twingo III (2007>)	294



 	
RENAULT (.../...) 	
Vel Satis (2002>2005)	294
Vel Satis (2005>)	294
Wind (2010>)	294
RENAULT 	
Cherokee	274
Jeep	274
Koleos (2008>)	274
RENAULT 	
Express (85>91)	295
Express (91>2003)	295
Extra (85>91)	295
Extra (91>97)	295
Kangoo (97>2003)	295
Kangoo (2003>)	296
Kangoo (2007>)	296
Master (80>89)	296
Master (89>94)	296
Master (94>97)	296
Master (97>2003)	296
Master (2003>2006)	296
Master (2006>)	296
Master (2010>)	297
Master Propulsion I (99>2004)	297
Master Propulsion II (2004>)	297
Rapid (85>91)	297
Rapid (91>98)	297
Trafic (80>89)	297
Trafic (89>94)	297
Trafic (94>97)	297
Trafic (97>2001)	298
Trafic II (2001>2006)	298
Trafic II (2006>)	298
ROVER 	
25 (99>2005)	298
45 (2000>2005)	298
75 (99>2005)	298
100 (90>98)	299
200 (84>90)	299
200 (89>96)	299
200 (95>99)	299
200 Coupé/Cabriolet (96>99)	299
400 (90>95)	299
400 (95>2000)	300
600 (93>2000)	300
800 (86>91)	300
800 (91>99)	300
Acclaim (81>84)	301
Maestro (83>95)	301





 	
ROVER (.../...) 	
Metro (80>90)	301
Metro UK (90>95)	301
Mini (59>80)	301
Mini (80>90)	301
Mini (90>99)	301
Montego (84>94)	301
SD1 (76>87)	301
Spitfire (70>80)	302
Streetwise (2000>2005)	302
TR7 (74>81)	302
RVI 	
Mascott (99>)	302
SAAB 	
9-3 (98>2003)	302
9-3 (2002>)	302
9-5 (97>2001)	303
9-5 (2001>2005)	303
9-5 (2005>)	303
99 (67>85)	303
900 (80>93)	304
900 (93>98)	304
9000 (84>98)	304
SAAB 	
9-7X (2005>)	302
SANTANA 	
Land Rover	304
Samurai	304
Vitara	305
SEAT 	
124	305
127	305
128	305
131	305
132	305
133	305
850	305
1430	305
Alhambra (96>2000)	305
Alhambra (2000>2003)	306
Alhambra (2003>2010)	306
Alhambra (2010>)	306
Altea (2004>)	306
Arosa (97>2004)	307
Cordoba (93>96)	307
Cordoba (96>99)	307
Cordoba (99>2002)	308
Cordoba (2002>)	308





 	
SEAT (.../...) 	
Exeo (2008>)	308
Fura (82>86)	309
Ibiza (84>93)	309
Ibiza (93>96)	309
Ibiza (96>99)	309
Ibiza (99>2001)	310
Ibiza (2001>)	310
Ibiza (2008>)	311
Leon (99>2006)	311
Leon (2005>)	311
Malaga (85>93)	312
Marbella (86>98)	312
Panda (80>86)	312
Ronda (82>87)	312
Toledo (91>98)	312
Toledo (98>2004)	313
Toledo (2004>)	313
SEAT 	
Inca (95>2003)	313
Terra (87>96)	313
SKODA 	
100-135	314
Fabia (99>2004)	314
Fabia (2004>2007)	314
Fabia (2006>)	315
Favorit (88>95)	315
Felicia (94>2001)	315
Forman (90>95)	315
Octavia (96>2000)	315
Octavia (2000>)	316
Octavia (2004>2008)	316
Octavia (2008>)	316
Roomster (2006>)	317
Superb (2001>2008)	317
Superb (2008>)	317
SKODA 	
Yeti (2009>)	313
SMART MCC 	
Crossblade (2002>)	318
Forfour (2004>)	318
Fortwo (98>2006)	318
Fortwo (2007>)	318
Roadster (2003>2005)	318
SSANGYONG 	
Kyron (2005>2007)	318
Musso (93>)	318
Rexton (2002>)	318





	
SSANGYONG (.../...) 	
Rexton (2004>)	318
Rodius (2005>)	319
SUBARU 	
E10/E12 (KJ) (84>94)	319
E12 (FA) (93>)	319
Fiori (89>92)	319
Forester (97>2002)	319
Forester (2002>2005)	319
Forester (2005>2007)	319
Impreza (93>2000)	319
Impreza (2000>2005)	320
Impreza (2005>2007)	320
Justy (86>95)	320
Justy (95>2003)	321
Justy G3X (2003>)	321
Legacy (89>94)	321
Legacy (94>98)	321
Legacy (98>2003)	321
Legacy (2003>)	321
SVX (91>97)	322
SUBARU 	
Sumo (87>94)	322
SUZUKI 	
Alto (80>94)	323
Alto (94>2002)	323
Alto (2002>2006)	323
Alto (2009>)	323
Baleno (95>)	323
Cappuccino (91>98)	323
Ignis (2000>2003)	324
Ignis (2003>)	324
Liana (2001>)	324
Splash (2008>)	324
Swift Made in Japan (83>89)	324
Swift Made in Japan (89>96)	324
Swift Made in Hungary (95>96)	324
Swift Made in Hungary (96>2005)	325
Swift Made in Hungary (2005>)	325
SX4 (2006>2009)	325
SX4 (2009>)	325
Wagon R (97>)	325
Wagon R+ (2000>)	325
SUZUKI 	
Jimny (98>)	322
S410/S413	322
Samurai (92>)	322
Grand Vitara (98>2005)	322





	
SUZUKI (.../...) 	
Grand Vitara XL7 (2001>2006)	322
Grand Vitara (2006>)	323
Vitara (88>98)	323
X90 (95>)	323
SUZUKI 	
Carry (GA4*)	325
Super Carry (SK4*)	325
TALBOT 	
1000 (66>78)	325
1100 (67>81)	326
1200S (69>71)	326
1301-1501 (63>76)	326
1307/8/9 (75>79)	326
1510 (79>82)	326
160 (70>80)	326
Alpine (81>85)	326
Avenger (70>81)	326
Bagheera (77>80)	326
Horizon (78>86)	327
Murena (81>83)	327
Rancho (77>86)	327
Samba (81>85)	327
Solara (80>85)	327
Tagora (80>84)	327
TOYOTA 	
Auris Made in Japan (2006>)	330
Auris Made in UK (2007>)	330
Auris FL (UKP150) (2010>)	331
Avensis (97>2000)	331
Avensis (2000>2003)	331
Avensis (2003>2008)	332
Avensis (2008>)	332
Avensis Verso (2001>2005)	332
Aygo (2005>)	332
Camry (82>86)	332
Camry (86>91)	332
Camry (91>96)	332
Camry (96>2001)	333
Camry (2001>2006)	333
Camry (2006>)	333
Carina II (83>87)	333
Carina II (87>92)	333
Carina E (92>97)	333
Celica (85>89)	333
Celica (89>93)	334
Celica (93>99)	334
Celica (99>2005)	334
Corolla (80) (83>87)	334



	
TOYOTA (.../...) 	
Corolla (90) (87>92)	335
Corolla (100) (92>97)	335
Corolla (110) (97>99)	335
Corolla (110) (99>2001)	335
Corolla (120) (2001>2007)	336
Corolla (150) (2006>)	336
Corolla Verso (2001>2003)	336
Corolla Verso (2004>2009)	336
Corolla Verso (2009>)	337
IQ (2009>)	337
MR 2 (84>89)	337
MR 2 (89>99)	337
MR 2 (99>2005)	337
Paseo (95>99)	337
Picnic (96>2001)	337
Picnic (2001>2005)	337
Previa (90>2000)	338
Previa (2000>)	338
Prius (2000>2003)	338
Prius (2003>2009)	338
Prius (2009>)	338
Starlet (89>95)	338
Starlet (96>99)	339
Supra (93>)	339
Tercel (82>88)	339
Urban Cruiser	339
Verso (2009>)	339
Yaris Made in Japan (99>2005)	339
Yaris Made in France (2001>2005)	340
Yaris Made in Japan (2005>)	340
Yaris Made in France (2005>)	340
Yaris Verso (99>)	340
TOYOTA 	
4 Runner (60) (84>89)	328
4 Runner (130) (89>95)	328
4 Runner (180) (95>2002)	328
Hilux (78>84)	328
Hilux (83>98)	328
Hilux (2001>)	328
Hilux (2005>)	328
Land Cruiser (BJ40) (80>84)	329
Land Cruiser (BJ60) (80>90)	329
Land Cruiser (BJ70) (84>2001)	329
Land Cruiser (BJ80) (90>98)	329
Land Cruiser (HD/UZ10) (98>2007)	329
Land Cruiser (KZ/VZ9) (96>2002)	329
Land Cruiser (KD/GR) (2002>)	329
Land Cruiser Prado (2009>)	329
Model F (82>90)	330



	
TOYOTA (.../...) 	
RAV4 (94>2000)	330
RAV4 (2000>2005)	330
RAV4 (2005>)	330
TOYOTA 	
Dyna (84>87)	340
Dyna 100 (85>2001)	340
Dyna 150 (85>98)	340
Dyna 200 (88>95)	340
Hiace (77>83)	340
Hiace (82>89)	341
Hiace (89>95)	341
Hiace (95>)	341
Liteace (79>95)	341
U.M.M. 	
Alter 4x4	341
VAUXHALL 	
Agila (2000>2007)	342
Agila (2007>)	343
Astra MK I (80>84)	343
Astra MK II (84>91)	343
Astra Belmont (86>91)	343
Astra MK III (91>2001)	343
Astra MK IV (98>2005)	344
Astra MK V (2004>)	344
Astra MK VI (2009>)	345
Calibra (90>97)	345
Carlton (78>86)	346
Carlton (86>94)	346
Cavalier (75>81)	347
Cavalier (81>88)	347
Cavalier (88>95)	347
Corsa MK I (93>2000)	348
Corsa MK II (2000>2003)	348
Corsa MK II (2003>2006)	348
Corsa MK III (2006>)	348
Insignia (2009>)	349
Meriva (2003>)	349
Meriva (2010>)	349
Nova (83>93)	350
Omega (94>)	350
Royale (78>82)	350
Senator B (87>93)	351
Signum A (2003>2005)	351
Signum B (2005>2008)	351
Sintra (96>99)	351
Tigra (94>2001)	351
Tigra Twintop (2004>2008)	351
Vectra (95>2002)	352

	
VAUXHALL (.../...) 	
Vectra (2002>2005)	352
Vectra (2005>2009)	352
Viceroy (80>81)	353
VX 220 (2000>)	353
Zafira I (99>2003)	353
Zafira I (2003>2005)	353
Zafira II (2005>2009)	353
Zafira II (2009>)	354
VAUXHALL 	
Antara (2006>)	342
Frontera A (91>98)	342
Frontera B (98>2005)	342
Monterey A (94>99)	342
Monterey B (98>99)	342
VAUXHALL 	
Arena (98>2001)	354
Astramax (91>98)	354
Brava (88>96)	354
Brava (96>)	354
Combo (93>2001)	354
Combo (2001>)	354
Movano (98>2003)	355
Movano (2003>2006)	355
Movano (2006>)	355
Movano (2010>)	355
Vivaro (2001>2006)	355
Vivaro (2006>)	355
VOLKSWAGEN 	
412 (68>74)	357
Bora (98>2005)	357
Coccinelle/Beetle (47>83)	359
Corrado (88>95)	359
Dasher (75>80)	360
Derby (77>81)	360
Derby (81>84)	360
Eos (2006>)	360
Fox (2004>)	360
Golf I (74>83)	360
Golf I Cabriolet (79>93)	360
Golf II (83>92)	360
Golf II Cabriolet (93>98)	361
Golf III (91>99)	361
Golf III Cabriolet (98>2002)	366
Golf IV (97>2006)	366
Golf V (2003>)	367
Golf VI (2008>)	368
Golf Plus (2005>)	368
Golf Plus (2009>)	369

	
VOLKSWAGEN (.../...) 	
Jetta I (78>84)	369
Jetta II (83>92)	369
Jetta III (2005>)	369
Lupo (98>2005)	370
New Beetle (98>2001)	370
New Beetle (2001>2005)	370
New Beetle (2005>)	371
Passat I (73>81)	371
Passat II (81>88)	371
Passat III (88>93)	371
Passat IV (93>97)	372
Passat V (96>2000)	372
Passat VI (2000>2005)	373
Passat VII (2005>)	373
Passat CC (2008>)	373
Phaeton (2002>2007)	374
Phaeton (2007>)	374
Polo I (74>81)	374
Polo II (81>86)	374
Polo III (86>90)	374
Polo IV (90>94)	374
Polo V (94>99)	375
Polo VI (99>2001)	375
Polo VII (2001>)	376
Polo VIII (2005>)	376
Polo IX (2009>)	376
Quantum (81>88)	377
Santana (81>84)	377
Scirocco (74>90)	377
Scirocco (2008>)	377
Sharan (95>2000)	377
Sharan (2000>2003)	378
Sharan (2003>2010)	378
Sharan (2010>)	378
Touran I (2003>2006)	378
Touran II (2006>2010)	378
Touran III (2010>)	379
Vento (91>97)	379
VOLKSWAGEN 	
Tiguan (2007>)	356
Touareg I (2002>2006)	356
Touareg II (2006>2010)	357
Touareg II (2006>)	357
Touareg II (2010>)	357
VOLKSWAGEN 	
Caddy I (82>92)	379
Caddy II (95>2004)	380
Caddy III (2004>)	380

 	
VOLKSWAGEN (.../...) 	
Crafter (2006>)	380
LT I (75>96)	380
LT II (96>2003)	380
LT III (2003>2006)	381
Taro (89>97)	381
Transporter (67>79)	381
Transporter (F24) (79>92)	381
Transporter (F70) (90>96)	381
Transporter (F7D) (96>2003)	382
Transporter (7J/7H) (2003>2009)	383
Transporter (7E/7F) (2009>)	383
VOLVO 	
240 (82>93)	385
242 (74>84)	385
244 (79>82)	385
245 (79>82)	385
262 (78>80)	385
264 (78>82)	385
265 (78>85)	386
340 (82>91)	386
343 (76>82)	386
345 (79>82)	386
360 (82>89)	386
440 (88>97)	386
460 (90>97)	386
480 (86>95)	386
740 (84>92)	387
760 (82>90)	387
780 (85>91)	388
850 (91>96)	388
940 (90>98)	388
960 (90>97)	389
C30 (2006>)	389
S40 (95>2004)	389
S40 (2004>)	389
V40 (95>2004)	390
V50 (2004>)	390
S60 (2000>)	390
C70 (97>2005)	391
C70 CC (2006>)	391
S70 (96>2000)	391
V70 (96>2000)	392
V70 (2000>2007)	392
V70 (2007>)	393
S80 (98>2006)	393
S80 (2006>)	393
S90 (96>98)	393
V90 (96>98)	394

 	
VOLVO 	
XC 60 (2008>)	384
XC 70 (97>99)	384
XC 70 (2000>2007)	384
XC 70 (2007>)	384
XC 90 (2002>)	384
YUGO/ZASTAVA 	
101	394
124	394
128	394
132	394
1100	394
1300	394
Florida	394
Sana	394
Tempo	394
Yugo	394

 	
---	--

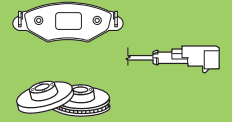

Pads and Discs

Plaquettes et Disques

Pastillas y Discos

Pastilas e Discos

Pastiglie e Dischi

Blokjes en Schijven

Bremsbeläge und Bremsscheiben

Klocki i Tarcze

Balatalari ve Diskleri







































Колодки и диски













































Δισκόφρενα & Δισκόπλακες













































刹车片和刹车盘













































بطانات و قرص

ABARTH									
Grande Punto (2007>)									
1.4	F	09/07→							
	R	09/07→	BOS 24349	598722	0	264x10 (8)	●	197008	
500 Nuova (2008>)									
1.4TB	F	08/08→	BOS 23349	598721	1	284,5x22 (20,2)		186266	
	R	08/08→	LUC 23661	598425	0	240,5x10,9 (9,2)		186155	
Punto Evo (2010>)									
1.4TB	F	05/10→							
	R	05/10→				264x10 (8)	●	197008	
ALFA ROMEO									
33 (83>89)									
1.2, 1.3AS, 1.3DC, 1.5AS, 1.5i, 1.8TD	F	08/83→07/89	BDX 20775	598126	2	239x12,6			
1.3AS, 1.3DC, 1.5AS, 1.5i, 1.8TD	F	08/85→07/89	ATE 20944	* 598130	2	239x12,6			
1.7ie	F	07/88→07/89	ATE 21165	598289	2	239x12,6			
	F	08/87→07/89	BDX 20775	598126	2	239x22 (20,2)	*	186102	
	F	08/87→07/89	ATE 20944	* 598130	2	239x22 (20,2)	*	186102	
	F	09/86→07/89	ATE 21165	598289	2	239x22 (20,2)	*	186102	
33 (89>94)									
1.2, 1.3, 1.3ie, 1.5, 1.5ie, 1.7i 1.7ie	ABS(-)	F	08/89→09/94	BDX 21272	598005	2	239x12,6		
1.3ie, 1.5ie, 1.7i	ABS(+)	F	08/89→09/94	BDX 21272	598005	2	239x12,6		
	ABS(+)	F	08/89→09/94	ATE 21165	* 598008	2	239x12,6		
1.3ie, 1.5ie, 1.7i, 1.7ie	ABS(+)	F	08/89→09/94	BDX 21272	598005	2	239x22 (20,2)	*	186102
	ABS(+)	F	08/89→09/94	ATE 21165	* 598008	2	239x22 (20,2)	*	186102
1.8TD		F	08/89→09/94			239x12,6			
1.7i, 1.7ie	ABS(+)	R	08/89→09/94	LUC 21103	598142	0	239x11		
	ABS(+)	R	08/89→09/94	LUC 21103	598142	0	240x10,9 (9,2)		186406















































			R P F		2+2		WVA		Valeo		Valeo		Valeo		
ALFA ROMEO  (.../...)															
75 (85>93)															
1.6, 1.8i, 2.0TD	F	05/85→08/88	ATE 20911		598113	1		250x12,7 (10,7)	* 186110						
2.0, 2.4TD	F	05/85→1993	ATE 20998		598115	1		261x12,6							
1.8 Turbo, 1.8 Turbo E	F	02/86→08/88	ATE 20911		598113	1		269x22 (20)	* 186103						
2.0i Twin Spark, 2.5i V6, 3.0i V6	F	05/85→08/88	ATE 20998		598115	1		269x22 (20)	* 186103						
2.0i Twin Spark	CU(+)	F 09/88→1993	ATE 20437		* 598107	0		269x22 (20)	* 186103						
1.6, 1.6ie, 1.8 Turbo, 1.8i, 1.8ie, 2.0 2.0TD, 2.0i Twin Spark, 3.0i V6	R	05/85→1993	ATE 20387		598351	0		250,5x10							
1.8 Turbo, 1.8 Turbo E, 2.4TD, 2.5i V6 3.0i V6	R	05/85→1993	ATE 20387		598351	0		250,5x10							
90 (84>88)															
1.8i, 2, 2.0i, 2.0i V6, 2.4TD, 2i, 2i V6	F	09/84→1988	ATE 20998		598115	1		261x12,6							
2.5i V6	F	09/84→1988	ATE 20998		598115	1		269x22 (20)	* 186103						
1.8i, 2, 2.0i, 2.0i V6, 2i, 2i V6	R	09/84→1988	ATE 20387		598351	0		250,5x10							
2.4TD, 2.5i V6	R	09/84→1988	ATE 20387		598351	0		250,5x10							
145 (94>2001)															
1.3i, 1.6i, 1.9TD	F	09/94→12/96	LUC 20838		598219	4		257,5x11,9(10,2)	186154						
1.4i Twin Spark, 1.6i Twin Spark, 1.9TD	F	12/96→06/01	ATE 21930		598040	1		257,4x20 (18,2)	186153						
1.7i	F	09/94→12/96	LUC 20838		598219	4		257,4x20 (18,2)	186153						
1.8i Twin Spark (eng AR67199) 103KW	EuroNorme	F 12/96→06/01	ATE 21636		598308	2		257x22 (20,5)	186590						
1.8i Twin Spark (eng AR67106) 103KW	US83	F 12/96→06/01	ATE 21636		598308	2		284x22 (20,2)	186297						
1.8i Twin Spark AGV (eng AR32201) 106KW	EuroNorme	F 06/98→04/99	ATE 21636		598308	2		284x22 (20,2)	186297						
1.9JTD	F	03/99→06/01						257,4x20 (18,2)	186153						
2.0i (Elegant)	F	11/95→01/00	ATE 21636		598308	2		257x22 (20,5)	186590						
	F	01/00→06/01	ATE 21637		● 598990	1		257x22 (20,5)	186590						
2.0i, 2.0i AGV (Sportiva, quadrifoglio)	F	11/95→01/00	ATE 21636		598308	2		284x22 (20,2)	186297						
	F	01/00→06/01	ATE 21637		● 598990	1		284x22 (20,2)	186297						

																	
ALFA ROMEO  (.../...)																	
145 (94>2001) (.../...)																	
1.3i, 1.4i Twin Spark, 1.6i 1.6i Twin Spark, 1.7i 1.8i Twin Spark 1.8i Twin Spark AGV, 1.9JTD, 1.9TD 2.0i, 2.0i AGV	ABS(+)	R	09/94→06/01	LUC 21103		598142	0		240,5x10,9 (9,2)	186155							
2.0i		R	11/95→06/01						240x10,9 (9,2)	186406							
146 (94>2001)																	
1.3i, 1.6i, 1.9TDs		F	12/94→12/96	LUC 20838		598219	4		257,5x11,9(10,2)	186154							
1.4i Twin Spark, 1.6i Twin Spark, 1.9TDs		F	07/96→06/01	ATE 21930		598040	1		257,4x20 (18,2)	186153							
1.7i		F	12/94→12/96	LUC 20838		598219	4		257,4x20 (18,2)	186153							
1.9JTD		F	03/99→06/01						257,4x20 (18,2)	186153							
1.8i Twin Spark		F	12/96→06/01	ATE 21636		598065	2		284x22 (20,2)	186297							
1.8i Twin Spark, 1.8i Twin Spark AGV, 2.0i 2.0i Twin Spark AGV		F	10/95→06/01	ATE 21636		598308	2		284x22 (20,2)	186297							
1.8i Twin Spark AGV, 2.0i Twin Spark AGV		F	01/00→06/01	ATE 21637		● 598990	1		284x22 (20,2)	186297							
1.8i Twin Spark, 2.0i		R	10/95→06/01	LUC 23177		598331	0		240,5x10,9 (9,2)	186155							
1.3i, 1.4i Twin Spark, 1.6i 1.6i Twin Spark, 1.7i 1.8i Twin Spark 1.8i Twin Spark AGV, 1.9JTD 1.9TDs, 2.0i, 2.0i Twin Spark AGV	ABS(+)	R	12/94→06/01	LUC 21103		598142	0		240,5x10,9 (9,2)	186155							
147 (2000>2004)																	
1.6i Twin Spark eng AR37203 77KW	 3021489	F	10/00→						281x15 (13,2)	186605							
	 3021490	F	→09/04	ATE 21637		● 598990	1		284,5x22 (20,2)	186265							
1.6i Twin Spark eng AR32104 88KW		F	10/00→09/04	ATE 21637		● 598990	1		284,5x22 (20,2)	186265							
1.9JTD, 2.0i Twin Spark		F	10/00→09/04	ATE 21637		● 598990	1		284,5x22 (20,2)	186265							
3.2i V6		F	02/03→10/03	BBO 21381		● 598988	2		305x28								
		F	10/03→09/04	BBO 21381		● 598988	2		330x32 (30)	● 197136							
1.6i Twin Spark, 1.9JTD, 2.0i Twin Spark		R	10/00→09/04	LUC 23661		598407	0		251,5x10 (9)	186290							

			 		  		  	
ALFA ROMEO  (.../...)								
147 (2000>2004) (.../...)								
3.2i V6	R	02/03→09/04	LUC 23661 	598407	0	 276x10 (9)	186797	
147 (2004>)								
1.6i Twin Spark, 1.9JTD, 1.9JTDM 2.0i Twin Spark	F	10/04→	ATE 21637 	598990	1	 284,5x22 (20,2)	186265	
3.2i V6	F	10/04→	BBO 23092 	598772	2	 330x32 (30)	197136	
1.6i Twin Spark, 1.9JTD, 1.9JTDM 2.0i Twin Spark	R	10/04→	LUC 23661 	598407	0	 251,5x10 (9)	186290	
3.2i V6	R	10/04→	LUC 23661 	598407	0	 276x10 (9)	186797	
155 (91>97)								
1.9TD	F	04/96→08/97	LUC 20838 	598219	4	 257,5x11,9(10,2)	186154	
1.6i Twin Spark, 1.7i Twin Spark 1.8i Twin Spark	F	11/91→08/97	LUC 20838 	598219	4	 257,4x20 (18,2)	186153	
2.0i Twin Spark (eng AR67202 AR67201) 104...105KW	F	11/91→03/95	LUC 20838 	598219	4	 257,4x20 (18,2)	186153	
2.0i Twin Spark 16V	F	03/95→08/97	LUC 21147 	598985	2	 257x22 (20,5)	186590	
	F	03/95→08/97	ATE 21636 	598065	2	 257x22 (20,5)	186590	
	F	03/95→08/97	LUC 21147 	598985	2	 284x22 (20,2)	186297	
	F	03/95→08/97	ATE 21636 	598065	2	 284x22 (20,2)	186297	
2.0i Turbo, 2.5TD, 2.5i V6	F	11/91→08/97	LUC 21227 	598010	2(C)	 284,5x22 (20,2)	186266	
1.6i Twin Spark, 1.7i Twin Spark 1.8i Twin Spark, 1.9TD, 2.0i Turbo 2.0i Twin Spark, 2.5TD	R	11/91→08/97	LUC 21103 	598142	0	 240x10,9 (9,2)	186406	
1.8i Twin Spark, 2.0i Turbo, 2.0i Twin Spark 2.5TD	R	11/91→08/97	LUC 21103 	598142	0	 240,5x10,9 (9,2)	186155	
2.5i V6	R	11/91→03/95	LUC 21103 	598142	0	 240x10,9 (9,2)	186406	
	R	03/95→08/97	LUC 23177 	598331	0	 240,5x10,9 (9,2)	186155	
156 (97>2003)								
1.6i Twin Spark, 1.8i Twin Spark	JA(-)	F	09/97→03/03	ATE 21636 	598065	2	 281x15 (13,2)	186605

										
ALFA ROMEO  (.../...)										
156 (97>2003) (.../...)										
1.6i Twin Spark, 1.8i Twin Spark 1.9JTD	JA(+)	F	09/97→03/03	ATE 23140 	598880	2		284,5x22 (20,2)	186265	
2.0i Twin Spark, 2.0JTS 2.4JTD	 125457JA(-)	F	09/97→	ATE 21636 	598065	2		284,5x22 (20,2)	186265	
		F	→03/03	ATE 21636 	598308	2		284,5x22 (20,2)	186265	
2.5i V6		F	09/97→12/01	ATE 21636 	598065	2		284,5x22 (20,2)	186265	
		F	01/02→03/03	ATE 21636 	598308	2				
3.2i V6		F	02/02→03/03	BBO 21381 	● 598988	2		305x28		
1.6i Twin Spark, 1.8i Twin Spark, 1.9JTD 2.0i Twin Spark, 2.4JTD, 2.5i V6		R	09/97→03/03	LUC 21606 	598581	0		251,5x10 (9)	186290	
1.6i Twin Spark, 1.8i Twin spark 1.9JTD, 2.0JTS, 2.0JTS TwinSpark 2.0i Twin Spark, 2.4JTD, 2.5i V6 3.2i V6	Sport(+)	R	04/00→03/03	LUC 23661 	598407	0		276x10 (9)	186797	
156 (2003>2007)										
1.6i Twin Spark, 1.8i Twin Spark, 1.9JTD 2.0JTS, 2.0JTS TwinSpark, 2.4JTD, 2.5i V6		F	04/03→11/06	ATE 21637 	● 598990	1		284,5x22 (20,2)	186265	
1.9JTD	4WD(+)	F	09/04→01/07					330x32 (30)	● 197136	
3.2i V6		F	04/03→11/03	BBO 21381 	● 598988	2		305x28		
		F	11/03→02/06	BBO 23092 	598772	2		330x32 (30)	● 197136	
1.6i Twin Spark, 1.8i Twin spark, 1.9JTD 2.0JTS, 2.0JTS TwinSpark, 2.4JTD, 2.5i V6 3.2i V6		R	04/03→01/07	LUC 23661 	598407	0		276x10 (9)	186797	
159 (2005>)										
1.8MPi, 1.9JTDM, 1.9JTS, 2.2JTS		F	07/05→	ATE 23587 	598729	2		305x28 (26)	● 197247	
2.4JTDM, 3.2JTS V6		F	07/05→	BBO 23092 	598772	2		330x28 (26)	● 197130	
1.8MPi, 1.9JTDM, 1.9JTS, 2.2JTS		R		LUC 23760 	● 601029	0		278x12 (10)	● 197098	
2.4JTDM, 3.2JTS V6	 7026206	R	07/05→	LUC 23760 	● 601029	0		292x22 (20)	● 197132	

ALFA ROMEO (.../...)		
159 (2005>) (.../...)		
2.4JTDM, 3.2JTS V6 (...)	7026206	R LUC 23760 ● 601029 0 292x22 (20) ● 197134
164 (87>92)		
2.0i Twin Spark	6142574	F 07/87→ LUC 21156 * 598003 2 257,5x20 (18,2) 186149
	6142574	F -09/92 LUC 21185 598135 2(B) 257,5x22 (20,2) * 186148
2.0 Turbo, 2.0 V6 Turbo, 2.5TD, 3.0i V6		F 07/87→09/92 LUC 21227 598006 2(A) 284,5x22 (20,2) 186265
2.0i Twin Spark		R 07/87→09/92 LUC 20668 598125 0 251,5x10 (9) 186146
2.0 Turbo, 2.0 V6 Turbo, 2.0i Twin Spark 2.5TD, 3.0i V6		R 07/87→09/92 LUC 20668 598125 0 251,5x10 (9) 186290
164 (92>98)		
2.0i Twin Spark		F 09/92→09/98 LUC 21185 598135 2(B) 257,5x22 (20,2) * 186148
2.0 V6 Turbo, 2.5TD, 3.0i, 3.0i V6		F 09/92→09/98 LUC 21227 598006 2(A) 281x26 (24,2) * 186405
2.0 V6 Turbo, 2.0i Twin Spark, 2.5TD, 3.0i V6		R 09/92→09/98 LUC 20668 598125 0 251,5x10 (9) 186290
3.0i, 3.0i V6	4WD(+)	R 09/92→09/98 LUC 21606 598581 0 251,5x10 (9) 186146
166 (98>2003)		
2.0i Twin Spark, 2.4JTD		F 10/98→09/03 ATE 21636 598308 2 281x26 (24,2) * 186443
2.0i V6 Turbo, 2.5i V6, 3.0i V6		F 10/98→09/03 BBO 23092 598772 2 310x28 (26) ● 197229
2.0i Twin Spark, 2.0i V6 Turbo, 2.4JTD 2.5i V6, 3.0i V6		R 10/98→09/03 LUC 21606 598581 0 276x10
166 (2003>2007)		
2.0i Twin Spark, 2.4JTD 10V		F 10/03→04/06 ATE 21636 598308 2 281x26 (24,2) * 186443
2.4JTD 20V, 2.5i V6, 3.0i V6, 3.2i V6		F 10/03→12/07 BBO 23092 598772 2 310x28 (26) ● 197229
2.0i Twin Spark, 2.4JTD, 2.5i V6, 3.0i V6 3.2i V6		R 10/03→12/07 LUC 21606 598581 0 276x10
1750		
1.8	F 01/68→08/71	ATE 20011 * 598111 0
	R 01/68→08/71	ATE 20009 598187 0 267x9
2000		
2.0	F 09/71→09/77	ATE 20011 * 598111 0

																	
ALFA ROMEO  (.../...)																	
2000 (.../...)																	
2.0 (...)	R	09/71→09/77	ATE 20009		598187	0		267x9									
Alfa 6 (79>87)																	
2.0i V6, 2.5TD, 2.5i V6	F	04/79→1987	ATE 20437		* 598107	0											
	R	04/79→1987	ATE 20437		* 598107	0		260x10,9									
Alfasud Sprint (79>89)																	
1.35	F	04/88→1989	BDX 20775		598126	2		239x12,6									
	F	01/80→1989	ATE 20944		* 598130	2		258x9,9									
1.35, 1.7ie 77KW	F	04/88→1989	ATE 20944		* 598130	2		239x12,6									
1.7i 84KW	F	04/88→1989	ATE 21165		598289	2		239x22 (20,2)	* 186102								
Alfetta (72>85)																	
1.6, 1.8, 2.0TD	F	05/72→1985	ATE 20228		598099	0		261x10,9									
1.6, 1.8, 2, 2.0i, 2.0ie, 2.4TD, 2i	F	1978→1985	ATE 20911		598113	1		261x12,6									
2.0	F	07/78→06/81	ATE 20228		598099	0		261x12,6									
1.6, 1.8, 2.0, 2.0i, 2.0ie, 2.4TD, 2i	R	1978→1985	ATE 20387		598351	0		250,5x10									
Arna (83>87)																	
1.2, 1.3, 1.5	F	09/83→1987	ATE 20944		* 598130	2											
	F	09/83→1987	BDX 20775		598160	0											
Brera (2006>)																	
2.2JTS	F	01/06→	ATE 23587		598729	2		305x28 (26)	● 197247								
2.4JTDM, 3.2JTS V6	F	01/06→	BBO 23092		598772	2		330x28 (26)	● 197130								
2.2JTS	R	01/06→	LUC 23760		● 601029	0		278x12 (10)	● 197098								
2.4JTDM, 3.2JTS V6	R	01/06→03/06	LUC 23760		● 601029	0		292x22 (20)	● 197132								
	R	03/06→	LUC 23760		● 601029	0		292x22 (20)	● 197134								
Giulia (64>79)																	
1.3, 1.6, 1.7D	F	07/64→1979	ATE 20228		598099	0		267x11									
	R	07/64→1979	ATE 20009		598187	0		267x9									



ALFA ROMEO (…/…)

Giulietta (76>86)

1.3	F	1978→1980	ATE 20228		598099	0		250x12,7 (10,7)	* 186110
1.6, 1.8	F	1983→1986	ATE 20911		598113	1		250x12,7 (10,7)	* 186110
2.0TD	F	1983→1986	ATE 20998		598115	1		250x12,7 (10,7)	* 186110
2i	F	1983→1986	ATE 20911		598113	1		261x12,6	
2.0 Turbo	F	1981→1986						269x22 (20)	* 186103
1.3, 1.6, 1.8, 2.0 Turbo, 2.0i, 2i	R	1981→1986	ATE 20387		598351	0		250,5x10	

Giulietta (2010>)

1.4TB 120, 1.6JTDM 105	F	06/10→							
1.4TB 170, 2.0JTDM 170	F	06/10→						305x28 (26)	● 197247
1.8TB 235	F	06/10→						330x28 (26)	● 197130
1.4TB 120, 1.4TB 170	R	06/10→							
1.6JTDM 105	R	06/10→							
1.8TB 235	R	06/10→						278x12 (10)	● 197098
2.0JTDM 170	R	06/10→							

























































GT (2003>)

1.8i Twinspark, 1.9JTD 2.0JTS		F	09/03→	ATE 21637		● 598990	1			
		F		ATE 21637		● 598990	1		284,5x22 (20,2)	186265
3.2 V6		F	09/03→01/08						330x32 (30)	● 197136
1.8i Twinspark, 1.9JTD, 2.0JTS, 3.2 V6		R	09/03→	LUC 23661		598407	0		276x10 (9)	186797



















GTV (80>87)































































2.0, 2.0i	F	12/80→1986	ATE 20228		598099	0		261x12,6	
2.0	F	03/86→09/87	ATE 20998		598115	1		261x12,6	
2.5i V6	F	12/80→1986	ATE 20588		598108	0		269x22 (20)	* 186103
	F	03/86→09/87	ATE 20998		598115	1		261x12,6	
	F	07/86→09/87	ATE 20998		598115	1		269x22 (20)	* 186103



















ALFA ROMEO (.../...)											
GTV (80>87) (.../...)											
2.0i, 2.0i, 2.5i V6	R	12/80→1986						250,5x10			
	R	03/86→09/87	ATE 20387		598351	0		250,5x10			
GTV (95>2003)											
2.0i Twin Spark	F	03/95→11/95	LUC 21147		● 598985	2		284x22 (20,2) * 186643			
	F	12/95→08/00	ATE 21636		598065	2		284x22 (20,2) * 186643			
	F	08/00→05/02	BBO 21381		● 598988	2		284x22 (20,2) * 186643			
1.8i Twin Spark 2.0 Twin Spark AGV			6063379	F	05/98→	ATE 21636		598308	2		284x22 (20,2) * 186643
			6063380	F	→02/03	ATE 21636		598065	2		284x22 (20,2) * 186643
2.0 V6 Turbo	F	03/95→07/95	LUC 21147		● 598985	2		284,5x22 (20,2) 186265			
	F	08/95→04/98	ATE 21636		598065	2		284,5x22 (20,2) 186265			
			6063379	F	05/98→	ATE 21636		598308	2		284,5x22 (20,2) 186265
			6063380	F	→02/03	ATE 21636		598065	2		284,5x22 (20,2) 186265
3.0i V6	F	02/97→02/03	BBO 21381		● 598988	2		305x28			
2.0 V6 Turbo, 2.0i Twin Spark	R	03/95→01/98	LUC 21103		598142	0		240x11			
1.8i Twin Spark, 2.0 Twin Spark AGV 2.0 V6 Turbo, 2.0i Twin Spark, 3.0i V6	R	02/97→02/03	LUC 23177		598331	0		240x11			
GTV (2003>2006)											
2.0JTS, 2.0i Twin Spark	F	03/03→02/06	ATE 21636		598065	2		284x22 (20,2) * 186643			
3.2i V6	F	03/03→02/06	BBO 21381		● 598988	2		305x28			
2.0JTS, 2.0i Twin Spark, 3.2i V6	R	03/03→02/06	LUC 23177		598331	0		240x11			
MiTo (2008>)											
1.3MJTD	F	12/08→						281x26 (24,2) 186745			
1.4MPI	F	04/08→	BOS 23705		598426	1		257x22 (20,5) 186590			
1.4TB	F	04/08→									
1.6MJTD	F	04/08→	BOS 23711		598428	1		281x26 (24,2) 186745			

















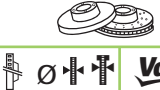







































														
			RPF		WVA			Valeo		Valeo		Valeo		
ALFA ROMEO  (.../...)														
MiTo (2008>) (.../...)														
1.3MJTD, 1.4MPI, 1.4TB, 1.6MJTD			R	04/08→	BOS 23714		598633	0						
Montreal (70>75)														
2.6 V8			F	03/70→1975	ATE 20011		* 598111	0						
			R	03/70→1975	ATE 20009		598187	0						
RZ (92>93)														
3.0i V6			F	09/92→12/93	ATE 20998		598115	1						
			R	09/92→12/93	ATE 20387		598351	0		250x20				
Spider (71>93)														
1.6			F	06/80→12/89	ATE 20228		598099	0						
1.6, 2.0, 2.0i			F	07/74→1993	ATE 20011		* 598111	0						
			R	07/74→1993	ATE 20009		598187	0		267x9				
Spider (916) (95>2003)														
2.0i Twin Spark				F	02/95→07/95	LUC 20838		598219	4		257x20 (18,2)	* 186644		
				F	07/95→05/98	ATE 21636		598065	2		284x22 (20,2)	* 186643		
				F	05/98→	ATE 21636		598308	2		284x22 (20,2)	* 186643		
				F	→02/03	ATE 21636		598065	2		284x22 (20,2)	* 186643		
2.0i V6 Turbo				F	05/98→	ATE 21636		598308	2		284,5x22 (20,2)	186265		
				F	→02/03	ATE 21636		598065	2		284,5x22 (20,2)	186265		
1.8i Twin Spark				F	02/95→	ATE 21636		598308	2		284x22 (20,2)	* 186643		
				F	→02/03	ATE 21636		598065	2		284x22 (20,2)	* 186643		
3.0i V6				F	02/95→07/95	LUC 21147		● 598985	2		284,5x22 (20,2)	186265		
				F	07/95→06/97	ATE 21636		598065	2		284,5x22 (20,2)	186265		
				F	07/97→	ATE 21636		598308	2		284,5x22 (20,2)	186265		
				F	→02/03	ATE 21636		598065	2		284,5x22 (20,2)	186265		
3.0i V6 24V			F	01/99→02/03	BBO 21381		● 598988	2		305x28				
2.0i Twin Spark			R	02/95→05/98	LUC 21103		598142	0		240x11				





































ALFA ROMEO (.../...)										
Spider (95>2003) (.../...)										
2.0i Twin Spark (...)	R	05/98-02/03	LUC 23177		598331	0		240x11		
1.8i Twin Spark, 2.0i V6 Turbo, 3.0i V6 3.0i V6 24V	R	02/95-02/03	LUC 23177		598331	0		240x11		
Spider (2003>2006)										
2.0JTS, 2.0i Twin Spark	F	03/03-02/06	ATE 21636		598065	2		284x22 (20,2)	* 186643	
3.2i V6	F	03/03-02/06	BBO 21381		● 598988	2		305x28		
2.0JTS, 2.0i Twin Spark, 3.2i V6	R	03/03-02/06	LUC 23177		598331	0		240x11		
Spider II (2006>)										
2.2JTS Twin Spark	F	03/06→	ATE 23587		598729	2		305x28 (26)	● 197247	
2.4JTDM, 3.2i V6	F	03/06→	BBO 23092		598772	2		330x28 (26)	● 197130	
2.2JTS Twin Spark	R	03/06→	LUC 23760		● 601029	0		278x12 (10)	● 197098	
2.4JTDM, 3.2i V6	R	03/06→	LUC 23760		● 601029	0		292x22 (20)	● 197134	
SZ (89>91)										
3.0i	F	03/89-12/91	ATE 20998		598115	1		284x24		
	R	03/89-12/91	ATE 20387		598351	0		250x20		
ALFA ROMEO										
AR8 (80>86)										
2.4D, 30AR8, 32AR8, 35AR8, 40AR8	⊙ 14"	F	09/83-08/86	AP 20359		598129	4(B)		267x14,2 (12,8)	* 186614
	⊙ 16"	F	09/83-08/86	AP 20359		598129	4(B)		267x14,3 (12,8)	186170
	⊙ 14"	F	09/83-08/86	BBO 21049		598007	4(B)		267x14,2 (12,8)	* 186614
	⊙ 16"	F	09/83-08/86	BBO 21049		598007	4(B)		267x14,3 (12,8)	186170
ARO										
10 (80>)										
1.3, 1.4, 1.6D, 1.9D, 1.9TD	F	04/80→	BDX 20347		598085	2		228x10 (9)	186226	
AUDI										
Q5 (2008>)										
2.0TDI, 2.0TFSI, 3.0TDI V6	F	11/08→						320x30 (28)	● 197196	

															
AUDI  (.../...)															
Q5 (2008>) (.../...)															
3.0TDI V6, 3.2FSI V6			F	11/08→							345x29,5				
2.0TDI, 2.0TFSI, 3.0TDI V6			R	11/08→							300x12 (10)	●	197126		
3.0TDI V6, 3.2FSI V6			R	11/08→							330x22				
Q7 (2006>)															
3.0TDI V6, 3.0TDI V6 DPF, 3.6FSI V6 4.2FSI V8, 4.2TDI V8, 6.0TDI V12			F	03/06→	BBO 23693		598656	0			350x34				
	⊙ 18"	R	03/06→	BBO 23694		598770	0			358x28 (26)	●	197051			
	⊙ 17"	R	03/06→	BBO 23694		598770	0			330x28 (26)	●	197090			
AUDI 															
50 (74>78)															
1.1, 1.3			F	08/74→07/78	ATE 20228		598099	0							
80 (72>81)															
1.3, 1.5			F	03/73→07/81	ATE 20228		598099	0			239x9,9 (8)		186249		
1.6, 1.6i			F	09/73→07/80	ATE 20228		598099	0			239x11,9 (10)		186245		
1.6, 1.6i, 1.7i			F	07/78→07/81	LUC 20574		598205	0			239x11,9 (10)		186245		
2.2i			F	10/80→07/81	LUC 20574		598205	0			239x11,9 (10)		186245		
80 (81) (81>86)															
1.3, 1.6, 1.6D, 1.6TD, 1.6i, 1.7i, 1.9, 2.0i 2.2i			F	08/81→03/87	LUC 20574		598205	0			239x11,9 (10)		186245		
1.8, 1.8i, 2.0i, 2.2, 2.2i			F	08/82→08/86	LUC 20901		598004	0			256x19,9 (18)	*	186273		
1.8, 1.8i, 2.0i			F	08/81→03/87	LUC 20574		598214	0			239x19,9 (18)		186246		
1.8, 1.8i, 2.0i, 2.2, 2.2i			R	08/82→08/86	LUC 20668		598125	0			245x10 (8)		186292		
80 (89-8A) (86>91)															
1.4, 1.6, 1.6D, 1.6TD, 1.6i, 1.8, 1.8i, 1.9D 1.9i			F	08/86→08/91	LUC 20901		598017	2			257x12,9 (11)		186113		
1.8i, 1.9i, 2.0i			F	09/86→09/91	LUC 20901		598017	2			256x22 (20)		186112		
1.8, 1.8i, 1.9i, 2.0i			R	09/86→09/91	LUC 20668		598125	0			245x10 (8)		186292		

















































															
AUDI (.../...)															
80 (86>91) (.../...)															
1.8i, 1.9i, 2.0i	R	08/86-08/91	LUC 20668		598125	0		245x9,9 (8)	186114						
80 (8C) (91>95)															
1.6i, 1.9TD, 1.9TDi, 2.0S 	F	09/91-07/92	LUC 20901		598017	2		256x13 (11)	186268						
1.6i, 1.9TD, 1.9TDi, 2.0E, 2.0S  	F	08/92-07/95	LUC 20901		598017	2		280x13 (11)	186269						
1.6i, 2.0E, 2.0S, 2.0i, 2.3E, 2.6E V6 	F	09/91-08/92	LUC 20901		598017	2		256x22 (20)	186267						
2.0i 	F	09/91-07/92						256x22 (20)	186267						
	F	09/91-07/92	LUC 20901		598017	2		276x24,9							
2.0E, 2.3E, 2.6E V6  	F	08/92-06/95	LUC 20901		598017	2		276x24,9							
2.0E, 2.0i, 2.2i Turbo, 2.3E, 2.6E V6 2.8i V6  	F	09/91-06/95						276x24,9							
1.6i, 1.9TD, 1.9TDi, 2.0E, 2.0S, 2.3E 2.6E V6  	F	08/92-07/95	LUC 20901		598017	2		280x22 (20)	186291						
2.0E, 2.3E, 2.6E V6  	F	08/92-06/95						280x22 (20)	186291						
1.6i, 1.9TD, 1.9TDi, 2.0E, 2.0S 2.0i, 2.3E, 2.6E V6, 2.8i V6  	4WD(-) R	09/91-07/95	LUC 20668		598125	0		245x9,9 (8)	186114						
2.0E, 2.0i, 2.2i Turbo, 2.3E 2.6E V6, 2.8i V6  	4WD(+) R	09/91-06/95	LUC 20668		598125	0		245x10 (8)	186807						
2.0E, 2.0i, 2.3E, 2.6E V6 2.8i V6  	4WD(+) R	09/91-06/95	LUC 20668		598125	0		245x10 (8)	186292						
Cabriolet (8G) (91>2000)															
2.3E	F	06/91-08/92	LUC 20901		598017	2		256x22 (20)	186267						
2.3E, 2.6E V6	F	10/91-08/00	LUC 20901		598017	2		280x22 (20)	186291						
1.8E, 1.9TDi, 2.0E, 2.6E V6	F	01/93-08/00	LUC 20901		598017	2		280x22 (20)	186291						
2.8i V6	F	11/92-08/00						276x24,9							
	F	07/94-08/00	LUC 20901		598017	2		276x24,9							
1.8E, 1.9TDi, 2.0E, 2.3E 2.6E V6, 2.8i V6	 P-005 333 R	06/91-08/00	LUC 20668		598125	0		245x9,9 (8)	186114						

















































																		
AUDI  (.../...)																		
Cabriolet (8G) (91>2000) (.../...)																		
1.8E, 1.9TDI, 2.3E, 2.6E V6, 2.8i V6	R	10/91→08/00	ATE 21911		598355	0		245x9,9 (8)	186114									
90 (84>87)																		
1.8i, 2.0i, 2.2i	F	06/84→03/87	LUC 20901		598004	0		256x19,9 (18)	* 186273									
2.2i	F	06/84→03/87	LUC 20901		598016	2		256x19,9 (18)	* 186273									
	R	08/84→03/87	LUC 20668		598125	0		245x10 (8)	186292									
	R	06/84→03/87	LUC 20668		598125	0		245x9,9 (8)	186114									
90 (87>91)																		
1.6TD	F	04/89→12/91	LUC 20901		598017	2		257x12,9 (11)	186113									
1.8i, 2.0i, 2.2i, 2.3i	F	04/87→12/91	LUC 20901		598017	2		256x22 (20)	186112									
2.3i	F	06/88→12/91						276x25										
	F	08/88→07/89						256x13 (11)	186268									
1.8i, 2.0i, 2.2i, 2.3i	R	04/87→09/91	LUC 20668		598125	0		245x10 (8)	186292									
	R	04/87→12/91	LUC 20668		598125	0		245x9,9 (8)	186114									
100 (68>72)																		
1.8, 1.9	F	07/68→09/71	ATE 20228		598099	0												
1.9	F	09/68→09/71																
	F	07/70→07/71																
100 (43) (71>82)																		
1.8, 1.9 	F	08/71→07/74						279x10,5										
1.6, 1.8, 1.9 	F	08/74→05/76	ATE 20913		* 598375	2(A)		279x10,5										
1.6 	F	08/76→07/80						257x12,9 (11)	186113									
1.6 	F	08/76→07/80	ATE 20913		* 598375	2(A)		257x12,9 (11)	186113									
1.6, 2.1, 2.2 	F	10/76→07/81	LUC 20574		598205	0		257x12,9 (11)	186113									
1.6, 1.9, 2.0, 2.0D, 2.2 	F	06/76→07/82	LUC 20574		598205	0		257x12,9 (11)	186113									
2.2 	F	08/81→07/82	LUC 20574		598205	0		256x22 (20)	186112									
1.9, 2.0D, 2.0TD, 2.2, 2.2i 	F	08/76→07/82	LUC 20901		598017	2		256x22 (20)	186112									



































															
AUDI (…/…)															
100 (44) (82>90)															
1.8, 1.8i, 1.9, 2.2, 2.2i 	F	08/82-12/90	LUC 20901 	598017	2		257x12,9 (11)	186113							
1.9, 2.2, 2.2i 	F	08/82-12/90	LUC 20574 	598205	0		257x12,9 (11)	186113							
1.8, 1.8i, 1.9, 2.0D, 2.0TD, 2.0i, 2.2, 2.2i 2.4D 	F	08/82-12/90	LUC 20901 	598017	2		256x22 (20)	186112							
1.9, 2.2, 2.2i 	F	08/82-12/90	LUC 20574 	598205	0		256x22 (20)	186112							
2.3i 	F	01/88-12/90	LUC 20901 	598017	2		276x25 (23)	* 186272							
2.2 Turbo, 2.2i, 2.2i Turbo, 2.3i 2.5TDi 	F	12/85-12/90	LUC 21138 	598230	2		276x25 (23)	* 186272							
2.2 Turbo, 2.2i, 2.3i, 2.5TDi 	F	01/88-12/90					276x25 (23)	* 186272							
2.2, 2.2i, 2.2i Turbo 	F	08/82-12/85	LUC 20901 	598017	2		280x22								
1.8, 2.2, 2.2 Turbo, 2.2i 2.2i Turbo, 2.3i 	⊙ 14"	R	08/82-12/90	LUC 20668 	598125	0		245x9,9 (8)	186114						
2.2, 2.2 Turbo, 2.2i, 2.3i 2.5TDi 	⊙ 15"	R	08/82-12/90	ATE 21911 	598355	0		245x9,9							
2.2, 2.2 Turbo, 2.2i, 2.2i Turbo 2.3i, 2.5TDi 	⊙ 15"	R	08/82-12/90	LUC 20668 	598125	0		245x9,9							
2.2i 	⊙ 15"	R	08/82-12/90	LUC 20668 	598125	0		245x9,9							
2.2, 2.2 Turbo, 2.2i, 2.3i 2.5TDi 	⊙ 14"	R	01/88-12/90	LUC 20668 	598125	0		245x9,9							
2.2, 2.2 Turbo, 2.2i, 2.3i 		R	10/84-12/90	LUC 20668 	598125	0		245x10							
1.8, 2.2, 2.2 Turbo, 2.2i, 2.3i 		R	10/84-12/90	LUC 20668 	598125	0		269x20							
100 (4A) (90>94)															
1.6, 1.6i, 2.0, 2.0i, 2.3i, 2.4D, 2.5TDi	F	12/90-07/94					288x15 (13)	186270							
2.6 V6, 2.6i V6, 2.8i V6	F	12/90-07/94					288x24,9 (23)	● 197222							
2.2i Turbo	F	08/91-06/93					310x25								
2.2i Turbo, 4.2i V8	F	10/92-07/94					314x30								

			RPF		WVA		Valeo		Valeo		Valeo	
			RPF		WVA		Valeo		Valeo		Valeo	
AUDI (.../...)												
100 (4A) (90>94) (.../...)												
1.6, 1.6i, 2.0, 2.0i, 2.3i, 2.4D, 2.5TDi 2.6 V6, 2.6i V6, 2.8i V6	R	12/90→07/94	LUC 20668		598125	0		245x9,9 (8)	186294			
2.2i Turbo, 2.8i V6, 4.2i V8	R	08/91→07/94	LUC 20668		598125	0		269x20				
2.3i 	R	12/90→07/94	LUC 20668		598125	0		269x20				
200 (43) (79>90)												
2.1	F	10/79→07/83	LUC 20901		598017	2		280x22				
2.1, 2.1 Turbo, 2.2, 2.2 Turbo	F	08/83→12/85	LUC 20901		598017	2		280x22				
2.1 Turbo, 2.2 Turbo, 2.3 Turbo	F	01/86→12/90	LUC 21138		598230	2		276x25 (23)	* 186272			
2.2 Turbo, 2.3 Turbo	F	02/88→12/90						276x25 (23)	* 186272			
2.3 Turbo	F	03/89→11/90						310x25				
2.1, 2.1 Turbo, 2.2, 2.2 Turbo, 2.3 Turbo	R	10/79→12/90	LUC 20668		598125	0		245x9,9				
2.1 Turbo, 2.2 Turbo	R	10/84→11/90	LUC 20668		598125	0		245x10				
2.1 Turbo, 2.2 Turbo, 2.3 Turbo	R	10/84→11/90	LUC 20668		598125	0		269x20				
4000												
1.8, 2.2, 2.2i	F	10/84→12/87						239x19,9 (18)	186246			
A1 (2010>)												
1.2TFSi, 1.6TDi	F	05/10→	ATE 21974		598332	0		256x21,9 (19)	186603	●186983		
1.4TFSi	F	05/10→	ATE 23587		598635	1		288x24,9 (22)	● 197230			
1.2TFSi, 1.4TFSi, 1.6TDi	R	05/10→	LUC 20960		598463	0(D)		232x9 (7)	186597			
A2 (AU24) (2000>2005)												
1.4TDi, 1.4i, 1.6FSi	F	06/00→08/05	ATE 21974		598408	1		256x21,9 (19)	186603	●186973		
1.2TDi	F	03/01→08/05	KH 23395		598734	1		239x14,9 (13)	186788			
1.4TDi, 1.4i, 1.6FSi	R	06/00→08/05	LUC 20960		598463	0(D)		232x9 (7)	186597			
A3 (AU34) (96>2000)												
1.6i	F	09/96→08/00	ATE 21974		598332	0		256x21,9 (19)	186603	●186983		
1.8i, 1.9TDi	F	09/96→08/00	ATE 21974		598332	0		280x22 (19)	186604			









































AUDI (.../...)															
A3 (AU34) (96>2000) (.../...)															
1.8i Turbo, 1.9TDi	F	12/96-08/00	ATE 21911		598303	0		288x24,9 (22)	●	197230					
1.9TDi	F	05/00-08/00	ATE 21974		598332	0		288x24,9 (22)	●	197230					
1.6i, 1.8i, 1.8i Turbo, 1.9TDi	R	09/96-08/00	LUC 20960		598180	0(D)		232x9 (7)		186597					
1.8i Turbo, 1.9TDi	R	08/97-08/00	LUC 20960		598180	0(D)		239x8,9 (7)	●	197011					
A3 (AU34) (2000>2003)															
1.6i, 1.9TDi	F	09/00-06/03	ATE 21974		598408	1		256x21,9 (19)		186603	●	186973			
1.8i, 1.9TDi	F	09/00-06/03	ATE 21974		598408	1		280x22 (19)		186604					
1.8i Turbo, 1.9TDi	F	09/00-06/03	ATE 21911		598486	1		288x24,9 (22)	●	197230					
1.8i Turbo	F	09/00-06/03	ATE 21911		598486	1		312x25 (23)	●	197246					
1.6i, 1.8i, 1.8i Turbo, 1.9TDi	R	09/00-06/03	LUC 20960		598180	0(D)									
	R	09/00-06/03	LUC 20960		598463	0(D)									
	R	09/00-06/03						232x9 (7)		186597					
1.8i Turbo, 1.9TDi	R	09/00-06/03						239x8,9 (7)	●	197011					
A3 (2003>2008)															
1.4TFSi, 1.6FSi, 1.6i, 1.9TDi	F	05/03-06/08	ATE 21974		598408	1		280x22 (19)		186754	●	186974			
1.8TFSi, 2.0FSi, 2.0TDi	F	05/03-06/08	ATE 23587		598635	1		288x25 (22)		186755					
2.0TDi, 2.0TFSi	F	09/04-06/08	ATE 23587		598635	1		312x25 (22)	●	197242					
3.2i V6	F	07/03-06/08	ATE 23801		598863	1		345x30 (27)	●	197197					
1.4TFSi, 1.6FSi, 1.6i, 1.9TDi	R	05/03-06/08	LUC 20960		598463	0(D)		255x10 (8)		186857					
1.8TFSi, 2.0FSi, 2.0TDi	R	05/03-06/08	LUC 23914		598752	0		260x12 (10)		186833					
2.0TDi, 2.0TFSi	R	09/04-06/08	LUC 23914		598752	0		286x12 (10)	●	197031					
3.2i V6	R	07/03-06/08	LUC 23914		598752	0		310x22 (20)	●	197139					
A3 (2008>)															
1.8TFSi, 2.0TDi	F	07/08-	ATE 23587		598635	1		288x25 (22)		186755					
2.0TDi, 2.0TFSi	F	07/08-	ATE 23587		598635	1		312x25 (22)	●	197242					





































			 		  		  	
AUDI  (.../...)								
A3 (2008>) (.../...)								
3.2i V6	F	07/08→05/09	ATE 23801 	598863	1	 345x30 (27)	● 197197	
1.4TFSi, 1.6TDi, 1.6TDie, 1.6i, 1.9TDi 1.9TDie	F	07/08→	ATE 21974 	598408	1	 280x22 (19)	186754	● 186974
1.4TFSi, 1.6TDi, 1.6TDie, 1.6i, 1.8TFSi 1.9TDi, 1.9TDie, 2.0TDi	R	07/08→	LUC 20960 	598463	0(D)	 255x10 (8)	186857	
1.8TFSi, 2.0TDi, 2.0TFSi, 3.2i V6	R	07/08→	LUC 23914 	598752	0	 286x12 (10)	● 197031	
3.2i V6	R	07/08→05/09	LUC 23914 	598752	0	 310x22 (20)	● 197139	
A3 Cabriolet (2008>)								
1.8TFSi, 2.0TDi	F	04/08→	ATE 23587 	598635	1	 288x25 (22)	186755	
1.9TDi	F	04/08→	ATE 21974 	598408	1	 280x22 (19)	186754	● 186974
2.0TFSi	F	04/08→	ATE 23587 	598635	1	 312x25 (22)	● 197242	
1.8TFSi, 1.9TDi, 2.0TDi	R	04/08→	LUC 20960 	598463	0(D)	 255x10 (8)	186857	
2.0TFSi	R	04/08→	LUC 23914 	598752	0	 286x12 (10)	● 197031	
A4 (94>98)								
1.6i, 1.9TDi	F	11/94→07/97	LUC 20901 	598017	2	 280x13 (11)	186408	
1.8i 	F	11/94→10/96	ATE 21911 	598355	0	 288x15 (13)	186270	
1.6i, 1.8i, 1.9TDi	F	10/96→12/98	LUC 20901 	598017	2	 280x22 (20)	186582	
1.8i, 1.8i Turbo, 1.9TDi 	F	08/97→12/98	ATE 21911 	598355	0	 280x22 (20)	186582	
1.8i, 1.8i Turbo, 1.9TDi, 2.4i V6, 2.5TDi V6 2.6i V6, 2.8i V6	F	11/94→12/98	ATE 21911 	598355	0	 288x24,9 (23)	● 197222	
1.6i, 1.8i, 1.8i Turbo, 1.9TDi, 2.4i V6 2.5TDi V6, 2.6i V6, 2.8i V6	R	11/94→12/98	LUC 20668 	598125	0	 245x10 (8)	186773	
	R	08/96→12/98	LUC 20960 	598463	0(D)	 245x10 (8)	186773	
A4 (99>2001)								
1.6i, 1.8i, 1.8i Turbo, 1.9TDi	F	01/99→11/00	LUC 21366 	598484	2	 280x22 (20)	186582	
1.9TDi	F	01/99→11/00	ATE 20676 	598483	2(A)	 280x22 (20)	186582	







































									
AUDI (.../...)									
A4 (99>2001) (.../...)									
1.8i Turbo, 1.9TDi, 2.4i V6, 2.5TDi V6 2.8i V6	F	01/99→09/01	ATE 20676 	598483	2(A)		288x24,9 (23)	● 197222	
1.9TDi 	F	01/99→11/00	LUC 21366 	598484	2		288x24,9 (23)	● 197222	
2.7i V6 	F	02/99→10/00	LUC 23118	● 598992	2		320x30 (28)	● 197198	
1.6i, 1.8i, 1.8i Turbo, 1.9TDi, 2.4i V6 2.5TDi V6, 2.7i V6, 2.8i V6	R	01/99→09/01	LUC 20960 	598463	0(D)				
1.8i, 1.8i Turbo, 1.9TDi, 2.4i V6, 2.5TDi V6 2.8i V6	R	02/99→11/00	LUC 20668 	598125	0				
1.6i, 1.8i, 1.8i Turbo, 1.9TDi, 2.4i V6 2.5TDi V6, 2.8i V6	R	01/99→09/01					245x10 (8)	186773	
2.7i V6 	R	02/99→10/00					256x22		
A4 (2000>2004)									
1.6i, 1.8i Turbo, 1.9TDi, 2.0FSI, 2.0i	F	12/00→12/04	LUC 21366 	598484	2		280x22 (20)	186582	
2.4i V6, 2.5TDi, 2.5TDi V6	F	12/00→12/04	ATE 20676 	598483	2(A)		288x24,9 (23)	● 197222	
3.0i, 3.0i V6	F	12/00→12/04	ATE 20676 	598483	2(A)		312x25 (23)	186758	
1.6i, 1.9TDi, 2.0FSI, 2.0i	R	12/00→12/04	LUC 20960 	598463	0(D)		245x10 (8)	186807	
1.8i Turbo, 2.4i V6, 2.5TDi, 2.5TDi V6, 3.0i 3.0i V6	R	12/00→12/04	LUC 20960 	598463	0(D)		255x11,9 (10)	186856	
A4 (2004>2008)									
1.6i, 1.9TDi	F	11/04→06/08	LUC 21366 	598484	2		280x22 (20)	186582	
1.8i Turbo, 2.0TDi, 2.0TFSI, 2.0i	F	11/04→06/08	ATE 20676 	598751	2(A)		288x24,9 (23)	● 197222	
2.5TDi V6, 2.7TDi V6, 3.0TDi V6, 3.0i	F	11/04→06/08	ATE 20676 	598751	2(A)		312x25 (23)	186758	
3.2FSi V6	F	01/05→06/08	ATE 23762 	598779	2		320x30 (28)	● 197198	
3.2FSi V6 	F	01/05→06/08	ATE 20676 	598751	2(A)		320x30 (28)	● 197198	
3.2FSi V6	F	01/05→06/08	ATE 23762 	598779	2		320x30		
3.2FSi V6 	F	01/05→06/08	ATE 20676 	598751	2(A)		320x30		
1.6i, 1.9TDi	R	11/04→06/08	LUC 20960 	598463	0(D)		245x10 (8)	186807	











































			RPF		WVA		Valeo		Valeo		Valeo	
			RPF		WVA		Valeo		Valeo		Valeo	
AUDI (.../...)												
A4 (2004>2008) (.../...)												
1.8i Turbo, 2.0TDi, 2.0TFSi, 2.0i	R	11/04→06/08	LUC 20960		598463	0(D)		255x11,9 (10)	186856			
2.5TDi V6 	R	11/04→05/06	LUC 23914		598752	0		255x11,9 (10)	186856			
2.5TDi V6, 2.7TDi V6, 3.0TDi V6, 3.0i 3.2FSi V6	R	11/04→06/08	LUC 23914		598752	0		255x12 (10)	197038			
A4 (2007>)												
1.8TFSi, 2.0TDi, 2.0TFSi, 2.7TDi V6	F	11/07→	ATE 24705		598996	1		314x25 (23)	197213			
3.0TDi V6, 3.2FSi V6	F	11/07→						320x30 (28)	197196			
1.8TFSi, 2.0TDi, 2.0TFSi, 2.7TDi V6 3.0TDi V6, 3.2FSi V6	R	11/07→						300x12 (10)	197126			
A4 Cabriolet (2002>2005)												
1.8i Turbo, 2.0i, 2.4i V6, 2.5TDi V6, 3.0i V6	F	04/02→12/05	ATE 20676		598751	2(A)		312x25 (23)	186758			
	R	04/02→12/05	LUC 20960		598463	0(D)		245x10 (8)	186807			
A4 Cabriolet II (2006>2009)												
1.8i Turbo, 2.0TDi, 2.7TDi V6	F	01/06→03/09	ATE 20676		598751	2(A)		312x25 (23)	186758			
2.0TFSi, 3.0TDi V6, 3.2FSi V6	F	01/06→03/09	ATE 23762		598779	2		320x30 (28)	197198			
1.8i Turbo	R	01/06→05/07	LUC 20960		598463	0(D)		245x10 (8)	186807			
	R	06/07→03/09	LUC 20960		598474	0(D+C)		245x10 (8)	186807			
2.0TDi, 2.0TFSi	R	01/06→05/07	LUC 20960		598463	0(D)		255x11,9 (10)	186856			
	R	06/07→03/09	LUC 20960		598474	0(D+C)		255x11,9 (10)	186856			
2.7TDi V6, 3.0TDi V6, 3.2FSi V6	R	01/06→03/09	LUC 23914		598752	0		255x12 (10)	197038			
A5 (2007>)												
1.8TFSi, 2.0TDi, 2.0TFSi, 2.7TDi V6	F	07/07→	ATE 24705		598996	1		314x25 (23)	197213			
2.0TFSi, 3.0TDi V6, 3.2FSi V6	F	06/07→						320x30 (28)	197196			
1.8TFSi, 2.0TDi, 2.0TFSi, 2.7TDi V6 3.0TDi V6, 3.2FSi V6	R	06/07→						300x12 (10)	197126			
A5 Cabriolet (2009>)												
2.0TDi DPF, 2.0TFSi, 2.7TDi DPF	F	03/09→	ATE 24705		598996	1		314x25 (23)	197213			





































AUDI (.../...)										
A5 Cabriolet (2009>) (.../...)										
2.0TFSI, 3.0TDI, 3.2FSI	F	03/09→						320x30 (28)	● 197196	
2.0TDI DPF, 2.0TFSI, 2.7TDI DPF, 3.0TDI 3.2FSI	R	03/09→						300x12 (10)	● 197126	
A6 (94>97)										
1.8E, 1.8i, 1.9TDi, 2.0E, 2.0i, 2.3E, 2.3i 2.5TDi	F	07/94→09/97						288x15 (13)	186270	
2.4i V6, 2.5TDi, 2.6E V6, 2.8E V6, 2.8i V6	F	07/94→09/97						288x24,9 (23)	● 197222	
1.8E, 1.8i, 1.9TDi, 2.0E, 2.0i, 2.3E, 2.3i 2.4i V6, 2.5TDi, 2.6E V6, 2.8E V6, 2.8i V6	R	07/94→09/97	LUC 20668		598125	0		245x9,9 (8)	186294	
2.0i, 2.3i, 2.6E V6, 2.8i V6	4WD(+)	R	07/94→09/97	LUC 20668		598125	0		269x20	
A6 (97>2001)										
1.8i, 1.8i Turbo, 1.9TDi	F	04/97→05/01	ATE 20676		598483	2(A)		288x24,9 (23)	● 197222	
2.4i V6, 2.5TDi V6	F	04/97→05/01	ATE 20676		598483	2(A)		312x25 (23)	186758	
2.7i V6 Bi turbo, 2.8i V6	F	04/97→12/98	ATE 20676		598483	2(A)		320x30 (28)	● 197198	
	F	11/98→05/01	LUC 23118		● 598992	2		320x30 (28)	● 197198	
4.2i V8	F	04/99→05/01	LUC 23118		● 598992	2		321x30		
1.8i, 1.8i Turbo, 1.9TDi, 2.4i V6, 2.5TDi V6 2.7i V6 Bi Turbo, 2.8i V6	R	04/97→05/01	LUC 20960		598463	0(D)		245x9,9 (8)	186294	
1.8i Turbo, 2.4i V6, 2.5TDi V6 2.7i V6 Bi Turbo, 2.8i V6	4WD(+)	R	04/97→05/01	LUC 20960		598463	0(D)		255x9,9 (8)	● 197124
	4WD(+)	R	04/97→05/01	LUC 20960		598463	0(D)		255x9,9 (8)	● 197032
4.2i V8	4WD(+)	R	04/99→05/01	LUC 20960		598463	0(D)		269x22 (20)	● 197089
A6 (2001>2005)										
1.8i Turbo, 1.9TDi, 2.0i, 2.4i V6, 2.5TDi V6 3.0i V6	F	06/01→04/05	ATE 20676		598483	2(A)		288x24,9 (23)	● 197222	
2.5TDi V6, 3.0i V6	F	06/01→04/05	ATE 20676		598751	2(A)		288x24,9 (23)	● 197222	
1.8i Turbo, 1.9TDi, 2.0i, 2.4i V6, 2.5TDi V6 2.7i V6 Bi Turbo, 3.0i V6	F	06/01→04/05	ATE 20676		598483	2(A)		312x25 (23)	186758	







































			R P F		WVA		Valeo		Valeo		Valeo	
AUDI  (.../...)												
A6 (2001>2005) (.../...)												
2.5TDi V6, 2.7i V6 Bi Turbo, 3.0i V6	F	06/01→04/05	ATE 20676		598751	2(A)		312x25 (23)	186758			
2.7i V6 Bi Turbo	F	06/01→06/02	ATE 23762		598750	2		320x30 (28)	● 197198			
	F	06/01→06/02	LUC 23118		● 598992	2		320x30 (28)	● 197198			
4.2i V8	F	06/01→04/05	LUC 23118		● 598992	2		321x30				
1.8i Turbo, 1.9TDi, 2.0i, 2.4i V6, 2.5TDi V6 3.0i V6	R	06/01→04/05	LUC 20960		598463	0(D)		245x9,9 (8)	186294			
1.8i Turbo, 2.4i V6, 2.5TDi V6 2.7i V6 Bi Turbo, 3.0i V6	VOEL(+)	R	06/01→04/05	LUC 20960		598463	0(D)		255x9,9 (8)	● 197032		
	VOEL(-)	R	06/01→04/05	LUC 20960		598463	0(D)		255x9,9 (8)	● 197124		
4.2i V8	R	06/01→04/05	LUC 20960		598463	0(D)		269x22 (20)	● 197089			
	R	06/01→04/05	LUC 20960		598463	0(D)		269x22				
A6 (2004>2008)												
2.0TDi, 2.0TFSi	F	07/04→09/08	ATE 20676		598751	2(A)		314x25 (23)	● 197052			
2.4i V6, 2.7TDi V6, 2.8FSi V6, 3.0 V6 3.0TDi V6, 3.2FSi V6	F	04/04→09/08	ATE 23762		598779	2		321x30 (28)	● 197199			
	F	01/06→09/08	ATE 23762		598779	2		347x30 (28)	● 197142			
2.0TDi, 2.0TFSi, 2.4i V6, 2.7TDi V6 2.8FSi V6, 3.0 V6, 3.0TDi V6, 3.2FSi V6	R	04/04→09/08	LUC 23914		598752	0		302x11,7 (10)	● 197125			
3.0TDi V6 	R	06/06→09/08	LUC 20960		598463	0(D)		302x11,7 (10)	● 197125			
4.2FSi V8	R	04/04→09/08	LUC 23326		● 601004	0		330x22 (20)	● 197140			
A6 (2008>)												
2.0TDi, 2.0TDi e, 2.0TFSi	F	10/08→	ATE 20676		598483	2(A)		314x25 (23)	● 197052			
2.7TDi V6, 2.8FSi V6, 3.0TDi V6, 3.0TFSi V6	F	10/08→	ATE 23762		598779	2		321x30 (28)	● 197199			
4.2FSi V8	F	10/08→	ATE 23762		598779	2		347x30 (28)	● 197142			
2.0TDi, 2.0TDi e, 2.0TFSi, 2.7TDi V6 2.8FSi V6, 3.0TDi V6, 3.0TFSi V6	R	10/08→	LUC 23914		598752	0		302x11,7 (10)	● 197125			
	R	10/08→	LUC 23326		● 601004	0		330x22 (20)	● 197140			





















										
			WVA	Valeo	Valeo			Valeo	Valeo	
AUDI (…/…)										
A6 Allroad (2000>2005)										
2.5TDi V6, 2.7i V6 Turbo	F	05/00-08/05	ATE 23762 	598750	2		320x30 (28)	● 197198		
4.2FSi V8	F	09/02-08/05	LUC 23118	● 598992	2		320x30 (28)	● 197198		
2.5TDi V6, 2.7i V6 Turbo	R	05/00-08/05	LUC 20960 	598463	0(D)		255x9,9 (8)	● 197032		
4.2FSi V8	R	09/02-08/05	LUC 20960 	598463	0(D)		269x22			
A6 Allroad (2006>2008)										
2.7TDi V6, 3.0TDi V6, 3.2FSi V6	F	05/06-10/08	ATE 23762 	598779	2		321x30 (28)	● 197199		
4.2FSi V8	F	05/06-10/08	ATE 23762 	598779	2		347x30 (28)	● 197142		
2.7TDi V6, 3.0TDi V6, 3.2FSi V6	R	05/06-10/08	LUC 23914 	598752	0		302x12			
4.2FSi V8	R	05/06-10/08	LUC 23326 	● 601004	0		330x22 (20)	● 197212		
A6 Allroad (2008>)										
2.7TDi V6, 3.0TDi V6, 3.0TFSi V6	F	10/08→	ATE 23762 	598779	2		321x30 (28)	● 197199		
4.2FSi V8	F	10/08→	ATE 23762 	598779	2		347x30 (28)	● 197142		
2.7TDi V6, 3.0TDi V6, 3.0TFSi V6	R	10/08→	LUC 23914 	598752	0		302x12			
4.2FSi V8	R	10/08→	LUC 23326 	● 601004	0		330x22 (20)	● 197212		
A7 (2010>)										
3.0TDI	F	07/10→					345x30			
3.0TFSI	F	07/10→					356x34			
3.0TDI	R	07/10→					300x12 (10)	● 197126		
3.0TFSI	R	07/10→					330x22			
A8 (94>2002)										
2.5TDi V6, 2.8E V6, 2.8i V6, 3.7i V8, 4.2i V8	F	06/94-12/98					314x30			
2.5TDi V6, 2.8E V6, 3.3TDi V8, 3.7i V8	F	12/98-09/02					323x30			
4.2i V8	F	10/98-09/02					345x30			
6.0i W12	F	03/01-09/02	ATE 21484 	598712	1		360x32			
2.5TDi V6, 2.8E V6, 2.8i V6, 3.3TDi V8 3.7i V8, 4.2i V8, 6.0i W12	F	06/94-09/02								









































			 		  		   	
AUDI  (.../...)								
A8 (94>2002) (.../...)								
2.5TDi V6, 2.8E V6, 2.8i V6, 3.7i V8, 4.2i V8	R	06/94→12/98	LUC 20668		598125	0		
2.5TDi V6, 2.8E V6, 3.3TDi V8, 3.7i V8 4.2i V8, 6.0i W12	R	10/98→09/02	LUC 20960		598463	0(D)		
2.5TDi V6, 3.3TDi V8	R	06/94→09/02					 245x10	
2.8E V6, 3.7i V8, 4.2i V8	R	06/94→09/02					 269x20	
6.0i W12	R	03/01→09/02					 280x22 (20)	186582
A8 (2002>2009)								
2.8FSi V6, 3.0TDi V6, 3.0i V6, 3.2FSi V6	F	07/03→	ATE 23762		598779	2	 321x30 (28)	● 197199
3.0i V6	F	07/03→05/04	ATE 23762		598779	2	 323x30	
4.2FSi V8, 4.2TDi V8, 4.2i V8	F	07/05→	ATE 23885		598845	2	 360x34	
6.0i W12	F	02/04→	ATE 23885		598845	2	 385x36	
	F	09/07→					 385x36	
3.0TDi V6, 3.0i V6, 3.2FSi V6, 3.7i V8 4.0TDi V8, 4.2TDi V8, 4.2i V8, 6.0i W12	R	11/02→10/07	LUC 23326		● 601004	0		
2.8FSi V6, 3.0TDi V6, 3.2FSi V6, 4.2FSi V8 4.2TDi V8, 6.0i W12	R	09/07→						
3.7i V8, 4.0TDi V8, 4.2FSi V8, 4.2TDi V8 4.2i V8, 6.0i W12	R	11/02→					 888x88	
2.8FSi V6, 3.0TDi V6, 3.0i V6, 3.2FSi V6	R	07/03→					 280x22 (20)	186582
3.7i V8, 4.0TDi V8, 4.2FSi V8, 4.2TDi V8 4.2i V8, 6.0i W12	R	11/02→						
Coupé (80>88)								
1.6, 1.8, 1.9, 2.0i, 2.2i	F	10/80→07/84	LUC 20574		598205	0	 239x11,9 (10)	186245
2.0i	F	08/83→07/84	LUC 20901		598004	0	 239x11,9 (10)	186245
1.8	F	07/86→07/88	LUC 20901		598004	0	 239x19,9 (18)	186246
2.0i	F	08/84→07/86	LUC 20574		598205	0	 239x19,9 (18)	186246
2.0i, 2.2, 2.2i, 2.3i	F	08/84→07/88	LUC 20901		598004	0	 256x19,9 (18)	* 186273

































																			
AUDI (…/…)																			
Coupé (85) (80>88) (…/…)																			
1.8, 1.8i, 2.2i	F	08/81→07/88	LUC 20574		598214	0		239x19,9 (18)	186246										
2.2i	F	08/84→07/88	LUC 20901		598004	0		256x22 (20)	186267										
1.8i, 2.2, 2.2i, 2.3i	R	08/81→07/88	LUC 20668		598125	0		245x9,9 (8)	186114										
2.2i, 2.3E	R	12/84→12/87	LUC 20668		598125	0		245x10 (8)	186292										
Coupé (8B) (88>96)																			
1.8E, 2.0E, 2.0i, 2.2i, 2.3E	F	11/88→07/92	LUC 20901		598017	2		256x22 (20)	186267										
2.0E, 2.3E, 2.6E V6	F	07/92→01/96	LUC 20901		598017	2		280x22 (20)	186291										
2.0E, 2.2i Turbo, 2.3 Turbo, 2.3E, 2.3i 2.8i V6	F	11/88→05/95						276x24,9											
2.0E, 2.3E, 2.6E V6	F	07/92→01/96						280x22 (20)	186291										
1.8E, 2.0E, 2.0i, 2.2i, 2.3E, 2.3i, 2.6E V6 2.8i V6	R	11/88→01/96	LUC 20668		598125	0		245x9,9 (8)	186114										
2.0E, 2.2i, 2.2i Turbo, 2.3 Turbo, 2.3E, 2.3i 2.6E V6, 2.8i V6	R	11/88→05/95	LUC 20668		598125	0		245x10 (8)	186292										
	R	11/88→05/95	LUC 20668		598125	0		245x10 (8)	186807										
Quattro (85) (80>91)																			
2.2i Turbo	F	08/80→07/86	LUC 20901		598017	2		280x22											
2.2i Turbo, 2.3i Turbo	F	08/86→07/89	LUC 21138		598230	2		276x25 (23)	* 186272										
2.3i Turbo	F	08/89→07/91						276x25 (23)	* 186272										
2.2i Turbo sport 221 KW	F	05/84→07/87						295x											
2.2i Turbo, 2.3i Turbo	R	07/80→07/89	LUC 20668		598125	0		245x9,9											
2.3i Turbo	R	08/89→07/91	LUC 20668		598125	0		269x20											
2.2i Turbo sport 221 KW	R	05/84→07/87	LUC 20668		598125	0		295x											
RS2 (94>95)																			
2.2 Turbo	F	03/94→06/95						304x32											
	R	03/94→06/95						299x24											

		 		  		  		 	
AUDI  (.../...)									
RS4 Quattro (2000>2001)									
2.7i V6 Bi Turbo	F	06/00→09/01	ATE 21484 	598712	1		360x32		
	R	06/00→09/01					312x22		
RS4 Quattro (2005>2008)									
4.2i V8	F	11/05→06/08					365x34		
	R	11/05→06/08					324x22		
RS4 Quattro Cabriolet (2006>2008)									
4.2i V8	F	05/06→10/08					365x34		
	R	05/06→10/08					324x22		
RS6 Quattro (2002>2004)									
4.2i V8	F	07/02→09/04					365x34		
	R	07/02→09/04	LUC 23326 	● 601004	0		335x22		
RS6 (2008>)									
5.0TFSI V10	F	04/08→					390x36		
	R	04/08→					356x28		
S3 (98>2003)									
1.8i Turbo	F	11/98→06/03	ATE 23587 	598635	1		312x25 (22)	● 197242	
	R	11/98→06/03	LUC 23914 	598752	0		286x12 (10)	● 197031	
S3 (2006>)									
2.0TFSI	F	10/06→					345x30 (27)	● 197197	
	R	10/06→	LUC 23914 	598752	0		310x22 (20)	● 197139	
S4 (97>99)									
2.7i V6 Bi Turbo	F	10/97→01/99					320x30 (28)	● 197198	
	R	10/97→01/99	LUC 20668 	598125	0		245x10 (8)	186773	
S4 (99>2001)									
2.7i V6	F	02/99→09/01	LUC 23118	● 598992	2		320x30 (28)	● 197198	
	R	02/99→09/01	LUC 20960 	598463	0(D)		256x22		

















									
AUDI (…/…)									
S4 (2003>2004)									
4.2i V8	F	03/03→12/04	ATE 23762 	598779	2		345x30		
	R	03/03→12/04	LUC 23326 	● 601004	0		300x22		
S4 (2004>2008)									
4.2i V8	F	11/04→06/08	ATE 23762 	598779	2		345x30		
	R	11/04→06/08	LUC 23326 	● 601004	0				
	R	11/04→06/08	LUC 20960 	598463	0(D)				
	R	11/04→06/08					300x22		
	R	11/04→06/08					312x25 (23)	186758	
S4 (2008>)									
3.0TFSI V6	F	11/08→					345x29,5		
	R	11/08→					330x22		
S4 Cabriolet (2004>2005)									
4.2i V8	F	02/04→12/05	ATE 23762 	598779	2		345x30		
	R	02/04→12/05	LUC 23326 	● 601004	0		300x22		
S4 Cabriolet II (2006>2009)									
4.2i V8	F	01/06→03/09	ATE 23762 	598779	2		345x30		
	R	01/06→03/09	LUC 23326 	● 601004	0		300x22		
S5 (2007>)									
3.0TFSI V6 	F	01/10→					345x29,5		
4.2FSI V8 	F	06/07→					345x29,5		
3.0TFSI V6, 4.2FSI V8  	R	06/07→					330x22		
S5 Cabriolet (2009>)									
3.0TFSI	F	06/09→					345x29,5		
	R	06/09→					330x22		
S6 (94>97)									
2.2i Turbo, 4.2i V8	F	07/94→10/97					314x30		
	R	07/94→10/97	LUC 20668 	598125	0		269x20		























































															
AUDI  (.../...)															
S6 Plus Quattro (96>97)															
4.2i V8	F	06/96→10/97													
	R	06/96→10/97	LUC 20668 	598125	0										
S6 (99>2001)															
4.2i V8	F	09/99→05/01	LUC 23118	● 598992	2										
	R	09/99→05/01	LUC 20960 	598463	0(D)										● 197089
S6 (2001>2005)															
4.2i V8	F	06/01→01/05	LUC 23118	● 598992	2										
	R	06/01→01/05	LUC 20960 	598463	0(D)										● 197089
S6 (2006>2008)															
5.2FSi V10	F	06/06→09/08	ATE 23885 	598845	2										
	R	06/06→09/08	LUC 23326 	● 601004	0										● 197212
S6 (2008>)															
5.2FSi V10	F	10/08→	ATE 23885 	598845	2										
	R	10/08→	LUC 23326 	● 601004	0										● 197212
S8 (96>98)															
4.2i V8	F	09/96→12/98													
	R	09/96→12/98	LUC 20668 	598125	0										
S8 (99>2002)															
4.2i V8	F	05/99→09/02													
	R	05/99→09/02	LUC 20960 	598463	0(D)										
S8 (2006>2007)															
5.2FSi V10	F	06/06→10/07	ATE 23885 	598845	2										
	R	06/06→10/07	LUC 23326 	● 601004	0										
S8 (2007>)															
5.2FSi V10	F	09/07→	ATE 23885 	598845	2										
	R	09/07→													















































																		
AUDI  (.../...)																		
TT (98>2006)																		
1.8i Turbo	F	10/98-06/06	ATE 21911		598486	1		312x25 (23)	● 197246									
	F	10/98-06/06	ATE 21911		598303	0		312x25 (23)	● 197246									
3.2i V6	F	07/03-06/06	ATE 21484		598712	1		334x32										
1.8i Turbo	R	10/98-06/06	LUC 20960		598180	0(D)												
	R	04/04-10/04	LUC 20960		598463	0(D)												
	R	10/98-06/06						232x9 (7)	186597									
	R	10/98-06/06						239x8,9 (7)	● 197011									
3.2i V6	R	07/03-06/06						256x22 (20)	● 197088									
TT (2006>)																		
2.0TFSi	F	08/06→	ATE 23587		598635	1		312x25 (22)	● 197242									
2.0TFSi, 3.2i V6	F	08/06→						340x30										
2.0TFSi	R	08/06→	LUC 23914		598752	0		286x12										
3.2i V6	R	08/06→	LUC 23914		598752	0		300x22										
TT RS (2009>)																		
2.5TFSi	F	07/09→	BBO 24098		● 598994	0		370x35										
	R	07/09→	LUC 23914		598752	0		310x22										
V8 (88>93)																		
3.6i V8	F	10/88-07/90						310x25										
3.6i V8, 4.2i V8	F	08/90-07/93						310x25										
	R	10/88-07/93	LUC 20668		598125	0		269x20										
AUTOBIANCHI 																		
A111 (69>74)																		
1.4	F	10/69-1974	BDX 20647		* 598603	0		227,5x10,8 (9)	186151									
A112 (69>85)																		
0.9, 1.05	F	10/69-07/85	BDX 20647		* 598603	0		227,5x10,8 (9)	186151									







































		
AUTOBIANCHI  (.../...)		
Primula (65>71)		
1.2, 1.4	F	02/65→1969
	F	1969→1971
		BDX 20647  * 598603 0
Y10 (85>95)		
1, 1.05, 1.0ie, 1.1ie	F	07/85→10/95
		BDX 20775  598091 2  227,5x10,8 (9) 186151 186904
1.05 Turbo, 1.1ie, 1.3	F	07/85→10/95
		LUC 20838  598219 4  240,5x12 (10,8) 186157
AUVERLAND 		
A3		
1.6, 1.9D, 2.1	F	
	F	
		LUC 20741  598153 2
		LUC 21206  598138 2
BEDFORD 		
Brava (88>90)		
2.2D, 2.3, 2.5D	F	10/88→06/90
		AKE 21543  598020 4  257x22 (20,6) 186488
Novavan (82>88)		
1.2	F	07/82→07/88
		20867  598182 0  236x9 (7) 186186 186947
BMW 		
X1 (2009>)		
2.0d 105KW 130KW	F	10/09→
		ATE 23313  ● 601027 0  312x23,9 (22,4) ● 197159
2.0d 150KW	F	10/09→
		ATE 23794  598640 0  330x24 (22,4) ● 197073
3.0i	F	10/09→
		ATE 23347  ● 598898 0  348x30 (28,4) ● 197176
2.0d	R	10/09→
		ATE 23926  598703 0  300x20 (18,4) ● 197158
3.0i	R	10/09→
		ATE 23550  598885 0  336x22 (20,4) ● 197175
X3 (E83) (2003>2006)		
2.0d, 2.0i, 2.5i, 3.0d, 3.0i	F	10/03→07/06
	R	10/03→07/06
		ATE 23183  598811 0  325x25 (23,4) ● 197083
		ATE 21487  598580 0  320x22 (20,4) ● 197251
2.0d, 2.5i, 3.0d, 3.0i	P	10/03→07/06
		562805
X3 (E83) (2006>)		
2.0d, 2.0i, 2.5si, 3.0d, 3.0si	F	08/06→
		ATE 23183  598811 0  325x25 (23,4) ● 197083















































																		
BMW  (.../...)																		
X3 (E83) (2006>) (.../...)																		
3.0sd	F	08/06→	ATE 23449		598412	0		332x30 (28,4)	186808									
2.0d, 2.0i, 2.5si, 3.0d, 3.0sd, 3.0si	R	08/06→	ATE 21487		598580	0		320x22 (20,4)	● 197251									
X5 (E53) (2000>2006)																		
3.0d, 3.0i, 4.4i	F	01/00→11/06	ATE 23449		598412	0		332x30 (28,4)	186808									
4.6is, 4.8is	F	09/01→11/06						356x36										
3.0d, 3.0i, 4.4i	R	01/00→11/06	ATE 21487		598580	0		324x12 (10,4)	186809									
4.4i, 4.6is, 4.8is	R	09/01→11/06	ATE 21487		598580	0		324x20										
3.0d, 3.0i, 4.4i, 4.6is, 4.8is	P	01/00→11/06			562805													
X5 (E70) (2006>)																		
3.0si	F	12/06→						332x29,9 (28,4)	● 197177									
3.0d	F	12/06→						348x29,9 (28,4)	● 197178									
3.0sd, 4.8si V8	F	01/07→						365x36										
3.0d, 3.0si	R	12/06→						320x19,9 (18,4)	● 197179									
3.0sd, 4.8si V8	R	01/07→	ATE 23730		598820	0		345x24 (22,4)	● 197180									
X6 (E71) (2008>)																		
3.0d	F	05/08→						348x29,9 (28,4)	● 197178									
3.0d, 3.0i	F	05/08→						365x36										
4.4i V8	F	05/08→						385x36										
3.0d	R	05/08→						320x19,9 (18,4)	● 197179									
3.0d, 3.0i	R	05/08→	ATE 23730		598820	0		345x24 (22,4)	● 197180									
4.4i V8	R	05/08→						385x24										
BMW 																		
1500 / 2002																		
1502 1.6, 1600, 1600-2, 1602, 1800, 1802 2000, 2002	F	07/64→07/77	ATE 20913		* 598375	2(A)		240x10										
1502 1.6, 1600, 1600-2, 1602, 1800, 1802 2002	F	07/64→07/77	ATE 20228		598099	0		240x10										















































															
BMW  (.../...)															
1500 / 2002 (.../...)															
2002	F	03/71→05/75	ATE 20913		* 598375	2(A)		256x12,7							
	F	03/71→05/75	ATE 20228		598099	0		256x12,7							
2500 / 3300															
2.5, 2.8, 3.0, 2500, 2800	F	08/68→02/77						272x12,7							
2.5, 2.8, 3.0, 3.3, 2500, 2800	R	05/71→02/77	ATE 20009		598187	0									
Series 1 (E87) (2004>)															
116i, 118d, 118i 	F	09/04→12/06	LUC 23915		598699	0		284x22 (20,4)	186816						
130i 	F	07/05→12/06						284x22 (20,4)	186816						
116i 	F	03/07→	LUC 23915		598699	0		284x22 (20,4)	186816						
120d, 120i 	F	09/04→12/06	ATE 23935		598700	0		292x22 (20,4)	186817						
118d, 118i 	F	03/07→	LUC 23915		598699	0		292x22 (20,4)	186817						
120d, 120i 	F	03/07→						300x24 (22,4)	197234						
123d, 130i 	F	07/05→						330x24 (22,4)	197073						
116i, 118d, 118i, 120i 	R	09/04→	LUC 23623		598701	0		x10							
118d, 120d, 123d, 130i 	R	09/04→	ATE 23926		598703	0									
118d, 120d 	R	09/04→						300x20 (18,4)	197049						
123d, 130i 	R	07/05→						300x20 (18,4)	197158						
116i, 118d, 118i, 120d, 120i	P	09/04→12/06			562808										
Series 1 (E81/82/88) (2007>)															
116i 	F	09/07→03/09	LUC 23915		598699	0		284x22 (20,4)	186816						
123d 	F	01/07→						284x22 (20,4)	186816						
118d, 118i 	F	03/07→	LUC 23915		598699	0		292x22 (20,4)	186817						
120d, 120i, 125i 	F	03/07→						300x24 (22,4)	197234						
123d, 130i 	F	01/07→						330x24 (22,4)	197073						
135i 	F	10/07→						338x26							

									
BMW  (.../...)									
Series 1 (E81/82/88) (2007>) (.../...)									
116i 	R	09/07→03/09	LUC 23623 	598701	0		280x10		
123d 	R	01/07→	ATE 23926 	598703	0		280x10		
118i, 120i 	R	03/07→	LUC 23623 	598701	0		296x10		
118d, 120d 	R	03/07→	ATE 23926 	598703	0		300x20 (18,4)	● 197049	
130i 	R	01/07→09/09	ATE 23926 	598703	0		300x20 (18,4)	● 197158	
123d 	R	10/07→	ATE 23926 	598703	0		300x20		
118i, 120d, 120i, 125i 	R	10/07→	ATE 23926 	598703	0		300x20 (18,4)	● 197181	
135i 	R	10/07→					324x22		
Series 3 (E21) (75>83)									
315, 316, 318, 318i, 320/4, 320/6	F	06/75→12/83	ATE 20588 	598108	0		255x12,6 (11,1)	* 186115	
320i, 323i	F	10/75→10/82	ATE 20588 	598108	0		255x21,9 (20,4)	* 186116	
323i	R	01/78→10/82					258x9,9 (8,4)	186117	
Series 3 (E31) (82>93)									
316, 316i, 318i, 320i, 324d 	ABS(-)	F	09/82→01/93					260x12,6 (11,1)	186118
316, 316i, 316i Touring, 318i 318i Touring, 318iS, 320i 320i Touring, 320iS, 323i, 324d 324td, 324td Touring, 325e, 325i 325i Touring, 325iX 325iX Touring 	ABS(+)	F	09/82→09/93					260x21,9 (20,4)	186119
316, 316i, 316i Touring, 318i 318i Touring, 318iS, 320i 320i Touring, 320iS, 323i, 324d 324td, 324td Touring, 325e, 325i 325i Touring 	ABS(+)	R	09/82→09/93	ATE 20675 	598103	431823		258x9,9 (8,4)	186117
318i 		R	10/90→04/93	ATE 20675 	598103	431823		284x9,9	
325iX 		R	09/86→09/93	ATE 20675 	598103	431823		258x10	
325iX Touring 		R	09/86→09/93	ATE 20675 	598103	431823		258x19	











































															
BMW (.../...)															
Series 3 (E36) (90>2001)															
316i, 318i, 318tds, 318ti 	F	12/90-04/01	ATE 21292 	598018	431822		286x11,9 (10,4)	186274							
316i, 318i, 318iS, 318tds, 320i, 323i, 323ti 325i, 325td, 325tds, 328i 	F	12/90-04/01	ATE 21292 	598018	431822		286x21,9 (20,4)	186275	●186985						
316i, 318iS, 318tds, 318ti, 320i, 323i, 323ti 325i, 325td, 325tds, 328i 	R	12/90-04/01	ATE 20180 	598386	431827										
316i, 318i, 318iS, 318tds, 318ti 320i, 323i, 325i, 325td, 325tds 328i 	ABS(+)	R	12/90-02/00	ATE 21934 	598753	431827									
316i, 318tds, 318ti, 323ti 	ABS(+)	R	02/94-04/01				272x9,9 (8,4)	186839							
316i, 318i, 318iS, 318tds, 320i 323i, 325i, 325td, 325tds 328i 	ABS(+)	R	12/90-02/00				280x9,9 (8,4)	186295							
323i, 328i 		R	01/95-02/00				276x18,9 (17,4)	186559							
Series 3 (E46) (98>2006)															
316Ci, 316i, 316ti, 318Ci, 318d, 318i, 318ti 320d 	F	03/98-08/05	ATE 21292 	598018	431822		286x21,9 (20,4)	186275	●186985						
318d, 318i, 320Ci, 320i, 323Ci 323i 	CU(+)	F	03/98-05/06	ATE 21292 	598018	431822		286x21,9 (20,4)	186275	●186985					
318d, 318i 	CU(+)	F	09/01-08/05	ATE 21292 	598018	431822		300x22 (20,4)	186815						
318d, 318i, 320Cd, 320Ci, 320d 320i, 323Ci, 323i, 325Ci, 325i 325ti, 325xi, 328Ci, 328i 	CU(+)	F	03/98-07/06	ATE 21292 	598018	431822		300x22 (20,4)	186815						
325i, 325xi 	CU(+)	F	09/01-02/05	ATE 23183 	598811	0		300x22 (20,4)	186815						
	CU(+)	F	09/01-02/05	ATE 21292 	598018	431822		325x25 (23)	186731						
325i, 325xi, 330Cd, 330Ci, 330d 330i, 330xd, 330xi 	CU(+)	F	09/99-08/06	ATE 23183 	598811	0		325x25 (23)	186731						
316Ci, 316i, 316ti, 318Ci, 318d 318i, 318ti, 320Cd, 320Ci, 320d 320i, 323Ci, 323i, 325Ci, 325i 325ti, 325xi, 328Ci, 328i 	CU(+)	R	03/98-07/06	ATE 21934 	598753	431827									

															
BMW  (.../...)															
Series 3 (E46) (98>2006) (.../...)															
325i, 325xi, 330Cd, 330Ci, 330d 330i, 330xd, 330xi 	CU(+)	R	09/99→08/06	ATE 21487 	598580	0									
316Ci, 316i, 316ti, 318Ci, 318i 		R	03/98→02/05									280x9,9 (8,4)	186295		
316i, 318Ci, 318d, 318i, 318ti 320Ci, 320d, 320i, 323Ci 323i 	CU(+)	R	03/98→05/06									276x18,9 (17,4)	186559		
318d, 318i, 320Cd, 320Ci, 320d 320i, 323Ci, 323i, 325Ci, 325i 325ti, 328Ci, 328i 	CU(+)	R	03/98→07/06									294x18,9 (17,4)	186861		
325xi 		R	09/01→08/05									294x19			
325xi, 330Cd, 330Ci, 330d, 330i 330xd, 330xi 	CU(+)	R	09/99→08/06									320x21,8 (20,4)	186883		
316i, 316ti, 318Ci, 318d, 318i, 318ti, 320Cd 320Ci, 320d, 320i, 323Ci, 323i, 325Ci, 325i 325ti, 328Ci, 328i 		P	03/98→07/06		562808										
Series 3 (E90/91/92/93) (2005>)															
316i, 318d, 320i 		F	03/05→08/07	ATE 23935 	598700	0						292x22 (20,4)	186817		
318d, 320i 	CU(+)	F	03/05→08/07	ATE 23794 	598640	0						292x22 (20,4)	186817		
320d, 320i, 325i, 325xi 		F	01/07→	ATE 23313 	601027	0						312x23,9 (22,4)	197159		
320d, 325i, 325xi 	CU(+)	F	09/07→09/08	ATE 23794 	598640	0						312x23,9 (22,4)	197159		
318d, 320d, 320i, 320si, 325i 325xi, 330xi 	CU(+)	F	03/05→09/08	ATE 23794 	598640	0						300x24 (22,4)	197234		
316i, 318d, 318i, 320i 		F	09/05→									300x24 (22,4)	197234		
320d 		F	03/07→	ATE 23313 	601027	0						300x24 (22,4)	197234		
318d, 320i 	CU(+)	F	03/05→08/07	ATE 23935 	598700	0						300x24 (22,4)	197234		
320d, 325d, 325i, 325xi, 330d, 330i 330xd, 330xi 	CU(+)	F	03/05→	ATE 23794 	598640	0						330x24 (22,4)	197073		
320d, 325i, 325xi 	CU(+)	F	09/07→09/08	ATE 23313 	601027	0						330x24 (22,4)	197073		
330xd, 330xi 		F	09/05→09/08	LUC 23915 	598699	0						330x24 (22,4)	197073		

						
BMW  (.../...)						
Series 3 (E90/91/92/93) (2005>) (.../...)						
330xi 	F	09/07→08/08	ATE 23347 	● 598898	0	 330x24 (22,4) ● 197073
330d, 330i, 330xd, 335d, 335i, 335xi 	F	06/06→	ATE 23347 	● 598898	0	 348x30 (28,4) ● 197176
320d, 320i, 325d, 325i, 325xi, 330d 330i, 330xd, 330xi, 335d, 335i 335xi 	CU(+)	R	03/05→	ATE 23550 	598885	0
318d, 318i, 320d, 320i, 320si, 325i 325xi 	CU(+)	R	03/05→	ATE 23926 	598703	0
316i, 318d, 320i 	R	03/05→09/08	LUC 23623 	598701	0	 296x10
318d, 318i, 320d, 320i, 325i 330xi 	CU(+)	R	03/05→			 300x20 (18,4) ● 197049
320d, 320i, 320si, 325i, 325xi 	R	03/05→				 300x20 (18,4) ● 197158
320d, 325d, 325i, 325xi, 330d, 330i 330xd, 330xi, 335d, 335i 335xi 	CU(+)	R	03/05→			 336x22 (20,4) ● 197175
318d, 318i, 320d, 320i, 325i 	P	03/05→08/07		562808		
Series 3 (E90/91/93) (2007>)						
316i, 318d, 318i 	F	09/08→				 300x24 (22,4) ● 197234
318i, 320i 	F	09/08→	ATE 23313 	● 601027	0	 300x24 (22,4) ● 197234
318d, 320d, 320d xDrive, 320i, 325i 325i xDrive 	F	09/08→	ATE 23313 	● 601027	0	 312x23,9 (22,4) ● 197159
325d, 325i xDrive, 330i xDrive 	F	09/08→	ATE 23794 	598640	0	 330x24 (22,4) ● 197073
330d, 330d xDrive, 330i, 330i xDrive, 335d 335i, 335i xDrive 	F	09/08→	ATE 23347 	● 598898	0	 348x30 (28,4) ● 197176
316i 	R	09/08→	LUC 23623 	598701	0	 296x10
318d, 318i, 320d, 320i, 325i 	R	09/08→	ATE 23926 	598703	0	 300x20 (18,4) ● 197049
316i, 318d, 318i, 320d, 320d xDrive, 320i 325i, 325i xDrive 	R	09/08→	ATE 23926 	598703	0	 300x20 (18,4) ● 197158
325d, 325i xDrive, 330d, 330d xDrive, 330i 330i xDrive, 335d, 335i, 335i xDrive 	R	09/08→	ATE 23550 	598885	0	 336x22 (20,4) ● 197175

																			
BMW  (.../...)																			
Series 5 (E12) (72>81)																			
518, 518i, 520/4, 520/6, 520i, 525, 528, 528i	F	06/72→06/81	ATE 20437		* 598107	431830													
518	F	09/74→11/75	ATE 20437		* 598107	431830		272x12,7											
518, 518i, 520/4, 520/6, 520i, 525	F	08/76→06/81	ATE 20437		* 598107	431830		280x12,7											
518, 528, 528i	F	06/74→05/81	ATE 20437		* 598107	431830		280x21,9											
525, 528, 528i	R	10/73→06/81	ATE 20009		598187	0		272x9,5											
Series 5 (E28) (81>88)																			
518, 518i, 520i	F	04/81→08/88	ATE 20629		598104	431823		284x11,9											
518, 518i, 520i, 524d, 524td, 525e 525i	ABS(+)	F	04/81→08/88	ATE 20629		598104	431823		284x21,9										
535i	F	01/85→08/88	ATE 20629		598104	431823		282x25											
518, 518i, 520i, 524d, 524td, 525e 525i, 528i, 535i	ABS(+)	R	04/81→08/88	ATE 20675		598103	0		284x9,9										
Series 5 (E34) (88>96)																			
518i, 520i, 524td, 525td, 525tds 	F	01/88→09/96	ATE 21064		598231	431832		302x11,8 (10,4)	186124										
525iX 	F	07/91→03/96	ATE 21064		598231	431832		296x28											
520i, 525i, 525td, 525tds, 530i 535i 	CU(+)	F	01/88→09/96	ATE 21064		598231	431848		302x22										
540i 	F	09/92→09/96	ATE 21064		598231	431832		302x28											
518i, 520i, 524td, 525i, 525iX 525td, 525tds, 530i, 535i 540i 	ABS(+)	R	01/88→09/96	ATE 20996		598259	431823												
540i 	R	09/92→09/95	ATE 20675		598103	431823													
540i 	R	06/93→09/96																	
518i, 520i, 524td, 525i, 525td 525tds, 530i, 535i 	ABS(+)	R	01/88→09/96					300x9,9 (8,4)	186125										
525iX, 540i 	R	07/91→09/96						300x											
Series 5 (E39) (95>2004)																			
520i, 523i, 535i 	F	09/95→09/97																	









			R P F		WVA		Valeo		Valeo		Valeo	
BMW (.../...)												
Series 5 (E39) (95>2004) (.../...)												
520i	F	07/96→04/03	ATE 21677		598310	431831		296x22 (20,4)	186697			
520d, 520i, 523i, 525i, 525tds, 528i	F	01/97→04/04	ATE 21064		598409	0		296x22 (20,4)	186697			
525Tds, 525d, 528i, 530d	F	09/98→04/04	ATE 21064		598409	0		296x22 (20,4)	186697			
520d, 520i, 525d, 525i	F	01/00→04/04	ATE 23449		598412	0		296x22 (20,4)	186697			
520d, 520i, 525i, 525d	F	01/00→04/04	ATE 21064		598409	0		324x30 (28,4)	186884			
520d, 520i, 525d, 525i, 530d, 530i	F	01/00→04/04	ATE 23449		598412	0		324x30 (28,4)	186884			
535i, 540i	F	07/96→03/00						324x30				
520i, 523i, 525Td, 525Tds, 528i, 535i	F	09/95→04/03	ATE 21677		598310	431831						
520d, 520i, 523i, 525Td, 525Tds 525d, 525i, 528i, 530d, 530i, 535i 540i	CU(+) R	09/95→04/04	ATE 21691		598311	431847		298x20 (18,4)	186860			
520d, 520i, 523i, 525Td, 525Tds	R	09/95→04/03	ATE 21691		598311	431838		298x9,9 (8,4)	186568			
Series 5 (E60/61) (2003>)												
520d, 520i, 523i, 525d, 525i	F	05/03→	ATE 23794		598640	0		310x24 (22,4)	186732			
	F	05/03→	ATE 23312		598410	0		310x24 (22,4)	186732			
	F	05/03→	ATE 23794		598640	0		324x30 (28,4)	197193			
520d, 520i, 523i, 525d, 525i, 525xd, 525xi 530d, 530i, 530xd, 530xi	F	05/03→	ATE 23312		598410	0		324x30 (28,4)	197193			
525d, 525i, 530d, 530i, 540i, 545i, 550i	F	05/03→	ATE 23312		598410	0		348x30				
540i	F	01/07→						348x30				
550i	F	09/05→12/06						348x30				
540i, 550i	F	01/07→	ATE 23312		598410	0		348x36				
535d, 540i, 550i	F	01/07→						348x36				
550i	F	09/05→12/06	ATE 23312		598410	0		348x38				
535d, 550i	F	09/04→12/06						348x38				

																				
BMW  (.../...)																				
Series 5 (E60/61) (2003>) (.../...)																				
520d, 520i, 523i, 525d, 525i, 525xd, 525xi 530d, 530i, 530xd, 530xi			R	05/03→	ATE 21732 	598754	0													
525d, 525i, 530d, 530i, 535d, 540i, 545i 550i			R	05/03→	ATE 23730 	598820	0													
520d, 520i, 523i, 525d, 525i, 530d, 530i			R	05/03→					320x20 (18,4)	● 197084										
525d, 525i, 525xd, 525xi, 530d, 530i, 530xd 530xi, 535d, 540i, 545i, 550i			R	05/03→					345x24											
520i, 523i, 525d, 525i, 525xi, 530d, 530i 530xi, 535d, 545i 			P	05/03→12/06		562805														
Series 6 (E24) (76>89)																				
628, 630, 633, 635			F	02/76→05/82	ATE 20437 	* 598107	431830		280x21,9											
628			F	05/82→09/88	ATE 20437 	* 598107	431830		282x25											
635			F	05/82→04/89	ATE 20629 	598104	431830		282x25											
M635			F	04/84→04/89	ATE 20437 	* 598107	431830		300x30											
628, 630, 633, 635			R	09/79→05/82	ATE 20009 	598187	0		272x19											
628, 635			R	06/82→08/88	ATE 20675 	598103	0		272x19											
628, 630, 633, 635			R	06/82→04/89	ATE 20675 	598103	0		284x9,9											
M635			R	04/84→04/89	ATE 20675 	598103	0		284x9,9											
Series 6 (E63/64) (2003>)																				
630i			F	09/04→08/07	ATE 23312 	598410	0		324x30 (28,4)	● 197193										
630i, 645Ci			F	09/03→	ATE 23312 	598410	0		348x30											
635d			F	09/07→					348x36											
650i			F	03/05→08/07	ATE 23312 	598410	0		348x36											
650i			F	09/07→	ATE 23312 	598410	0		348x36											
630i			R	09/04→08/07	ATE 21732 	598754	0		320x20 (18,4)	● 197084										
630i, 635d, 645Ci, 650i			R	09/03→	ATE 23730 	598820	0		345x24											
630i, 645Ci			P	09/03→08/07		562805														













BMW (../...)











Series 7 (E23) (77>86)

728, 728i, 730, 732i, 733i	F	03/77→09/82	ATE 20437 	* 598107	431830		280x21,9		
728i, 728iS, 732i, 735i, 745i	F	01/80→05/86	ATE 20437 	* 598107	431830		280x25		
728i, 728iS, 732i, 733i, 735i, 745i	R	07/81→05/86	ATE 20675 	598103	431830				
728, 728i, 730, 732i, 733i, 735i, 745i	R	03/77→09/81	ATE 20009 	598187	0		280x10		
728, 728i, 728iS, 730, 732i, 733i, 735i, 745i	R	03/77→05/86					284x10		









Series 7 (E32) (86>94)





































730i	F	08/88→05/94	ATE 21064 	598231	431824		302x22		
730i, 735i, 740i, 750i	F	09/86→05/94	ATE 21064 	598231	431824		302x28		
750i	F	01/90→05/94					324x30		
730i, 735i, 740i, 750i	R	09/86→05/94	ATE 20996 	598259	431839		300x10		
750i	R	11/86→12/89					300x20		
740i, 750i	R	01/90→05/94	ATE 20675 	598103	0		300x20		















































Series 7 (E38) (94>2001)





























































725Tds, 728i, 730d, 730i, 735i	F	06/94→08/01					316x28 (26,4)	● 197227	
740d	F	03/99→08/01	ATE 21484 	598712	1		316x28 (26,4)	● 197227	
740i	F	06/94→08/01	ATE 23449 	598412	0		324x30		
750i	F	06/94→08/01	ATE 21484 	598712	1		334x32		
725Tds, 728i, 730d, 730i, 735i, 740i	R	06/94→08/01	ATE 21487 	598580	0		324x12		
740d, 750i	R	06/94→08/01	ATE 21487 	598580	0		328x20		































Series 7 (E65) (2001>2008)

730d, 730i, 735i	F	09/01→10/08	ATE 23312 	598410	0		324x30		
730d, 740d, 740i, 745i, 750i, 760i	F	09/01→10/08	ATE 23312 	598410	0		348x30		
750i	F	03/05→10/08					348x36		
745d, 760i	F	03/05→10/08					374x36		
730d, 730i, 735i	R	09/01→10/08	ATE 21282 	598411	0		324x20		











































									
BMW  (.../...)									
Series 7 (E65) (2001>2008) (.../...)									
730d, 740d, 740i, 745d, 745i, 750i, 760i	R	09/01→10/08	ATE 23730 	598820	0				
730d, 730i, 735i, 740d, 740i, 745d, 745i 750i, 760i	P	09/01→10/08		562805					
Series 7 (E66) (2002>2008)									
730Li, 735Li	F	03/02→10/08	ATE 23312 	598410	0	 324x30			
730Ld, 740Li, 745Li, 750Li, 760Li	F	03/02→10/08	ATE 23312 	598410	0	 348x30			
750Li	F	03/05→10/08				 348x36			
760Li	F	03/05→10/08				 374x36			
730Li, 735Li	R	03/02→10/08	ATE 21282 	598411	0	 324x20			
730Ld, 740Li, 745Li, 750Li, 760Li	R	03/02→10/08	ATE 23730 	598820	0				
730Li, 735Li, 740Li, 745Li, 750Li, 760Li	P	03/02→10/08		562805					
Series 7 (F01/F02/F04) (2008>)									
730d, 740Li, 740i, 750Li, 750i	F	11/08→				 x36			
	R	11/08→				 x24			
Series 8 (E31) (89>2000)									
840, 850	F	09/89→2000				 324x30			
	F	09/92→2000				 324x30			
	R	09/89→2000	ATE 20675 	598103	0	 324x12			
850	R	09/92→07/96				 328x20			
M3 (E30) (86>91)									
2.3i, 2.5i 	F	09/86→06/91	ATE 20629 	598104	0	 280x25			
	R	09/86→06/91	ATE 20996 	598259	0	 282x12			
M3 (E36) (92>2000)									
3.0i, 3.2i 	F	06/92→06/00	ATE 21064 	598231	431850	 315x28			
	R	06/92→06/00	ATE 20996 	598259	0	 312x20			
M3 (E46) (2000>2006)									
3.2i	R	07/00→09/06	ATE 21487 	598580	0	 328x20			

























										
						WVA				
										
										
BMW (.../...)										
M3 (E46) (2000>2006) (.../...)										
3.2i 	P	09/01→09/06				562805				
M3 (E90/92/93) (2007>)										
4.0i V8	F	09/07→	ATE 23312 	598410	0	 360x30				
	R	09/07→	ATE 23730 	598820	0	 350x24				
M5 (E12) (80>81)										
3.5i	F	04/80→05/81	ATE 20437 	* 598107	0	 280x21,9				
	F	04/80→05/81	ATE 20437 	* 598107	0	 280x25				
	R	04/80→05/81	ATE 20009 	598187	0	 272x9,5				
M5 (E28) (84>88)										
3.4i	F	12/84→08/88	ATE 20629 	598104	431823	 282x25				
3.5i	F	10/84→08/88	ATE 20437 	* 598107	431823	 300x30				
3.4i, 3.5i	R	10/84→08/88	ATE 20675 	598103	0	 284x9,9				
M5 (E34) (88>95)										
3.6i, 3.8i 	F	07/88→05/94	ATE 21064 	598231	431832					
3.8i 	F	05/94→09/95								
3.6i 	R	07/88→12/91	ATE 20996 	598259	431823					
	R	07/88→10/89	ATE 20996 	598259	431823	 300x9,9 (8,4)			186125	
3.6i, 3.8i 	R	10/89→09/95				 x20				
M5 (E39) (99>2003)										
5.0i	F	07/99→06/03	ATE 23449 	598412	0	 345x32				
	R	07/99→06/03	ATE 21487 	598580	0	 328x20				
	P	07/99→06/03		562805						
M5 (E60) (2004>)										
5.0i V10 	F	12/04→02/05				 374x36				
	R	12/04→02/05	ATE 23730 	598820	0	 370x24				
M5 (E61) (2007>)										
5.0i V10 	F	01/07→				 374x36				















			 WVA			 Valeo		 Valeo		 Valeo		 Valeo	
BMW (.../...)													
M5 (E61) (2007>) (.../...)													
5.0i V10  (...)	R	01/07→	ATE 23730 	598820	0		370x24						
M6 (E63/64) (2007>)													
5.0i	F	03/05→					374x36						
	R	03/05→	ATE 23730 	598820	0		370x24						
Z1 (E30) (89>92)													
2.5i	F	03/89→1992					260x21,9 (20,4)	186119					
	R	09/90→1992	ATE 21934 	598753	431827		282x10						
	R	03/89→09/90	ATE 20675 	598103	0		282x10						
	R	09/90→1992	ATE 20180 	598386	431827		282x10						
Z3 (E36) (96>2002)													
1.8i, 1.9i 	F	01/96→06/02	ATE 21292 	598018	431822		286x11,9 (10,4)	186274					
2.0i, 2.2i, 2.8i 	F	03/96→06/02	ATE 21292 	598018	431822		286x21,9 (20,4)	186275	●186985				
3.0i 	F	06/00→06/02	ATE 21292 	598018	431822		300x22 (20,4)	186815					
3.2i 	F	06/96→05/02	ATE 21064 	598231	0		315x28						
1.8i, 1.9i, 2.0i, 2.2i, 2.8i, 3.0i 	R	01/96→06/02	ATE 20180 	598386	431827		272x10						
3.2i 	R	06/96→05/02	ATE 20996 	598259	431823		312x20						
Z4 (E85/86) (2002>2009)													
2.0i, 2.2i, 2.5i 	F	03/04→08/08	ATE 21292 	598018	431822		286x21,9 (20,4)	186275	●186985				
2.5i 	F	09/02→01/06	ATE 21292 	598018	431822		286x21,9 (20,4)	186275	●186985				
2.5si 	F	02/06→08/08	ATE 21292 	598018	431822		300x22 (20,4)	186815					
3.0si 	F	02/06→08/08	ATE 23183 	598811	0		325x25 (23)	186731					
3.2i 	F	02/06→08/08					345x28						
2.0i, 2.2i, 2.5i 	R	09/02→08/08	ATE 21934 	598753	431827		280x9,9 (8,4)	186295					
2.0i, 2.2i, 2.5i, 2.5si, 3.0i, 3.0si 	R	09/02→08/08	ATE 21934 	598753	431827		294x19						
3.2i 	R	02/06→08/08	ATE 21487 	598580	0		328x20						
2.0i, 2.2i, 2.5i, 3.0i 	P	09/02→		562808									



			R P F		WVA		Valeo		Valeo		Valeo	
BMW  (.../...)												
Z4 (E89) (2009>)												
2.5i	150 KW	F	03/09→	ATE 23794 	598640	0		300x24 (22,4)	● 197234			
3.0i	190 KW	F	03/09→	ATE 23794 	598640	0		330x24				
	225 KW	F	03/09→	ATE 23347 	● 598898	0		348x30				
2.5i, 3.0i		R	03/09→					x20				
Z8 (E52) (2000>2003)												
5.0i V8		F	03/00→07/03	ATE 21484 	598712	1		334x32				
		R	03/00→07/03	ATE 21487 	598580	0		328x20				
CADILLAC 												
BLS (2005>)												
1.9Tid, 2.0T		F	03/05→	ATE 23402 	598678	0		302x28 (25)	186880			
		F	03/05→	ATE 23402 	598678	0		285x24,9 (22,2)	186881			
2.8 V6		F	03/05→	ATE 20224 	598808	0		314x28				
1.9Tid, 2.0T, 2.8 V6	 62999999	R	03/05→	ATE 24137 	598783	0						
	 72000001	R		ATE 23482 	598472	0						
CTS (2002>)												
2.6i V6, 2.8i V6, 3.2i V6, 3.6i V6		F	03/02→									
		R	03/02→									
CHEVROLET 												
Aveo (2005>2008)												
1.4i		F	01/05→	AKE 23974 	598644	0						
Captiva (2006>)												
2.0VCDi, 3.2V6		F	09/06→	MDO 24510 	● 598942	2		296x29 (27,5)	● 197190			
		R	09/06→	AKE 24498 	● 598941	2		303x20 (18,4)	● 197191			
Epica (2006>)												
2.0VCDi, 2.0i V6		F	05/06→	AKE 23235 	598361	2						
		R	05/06→									

																	
CHEVROLET  (.../...)																	
Evanda (2005>)																	
2.0i, 2.0i GPL		F	01/05→	AKE 23235		598361	2										
		R	01/05→														257,6x12
Kalos (2005>)																	
1.2i, 1.4i		F	01/05→	AKE 23974		598644	0										
Lacetti (2005>)																	
1.4i, 1.6i, 1.8i		F	01/05→														
		R	01/05→	SUM 24071		598874	0										257,8x10,5
Matiz (2005>)																	
0.8, 1.0		F	01/05→	AKE 23241		598316	0										236x12,6 (9,7) 186742
Nubira (2005>)																	
1.6i, 1.6i GPL, 1.8i, 1.8i GPL		F	01/05→														
		R	01/05→	SUM 24071		598874	0										257,8x10,5
Rezzo (2005>2008)																	
1.6i, 1.6i GPL, 2.0i, 2.0i GPL		F	01/05→06/08	AKE 23235		598361	2										
Spark (2005>)																	
0.8i, 1.0i		F	05/05→	AKE 23241		598316	0										236x12,6 (9,7) 186742
Tacuma (2005>2008)																	
1.6i, 2.0i		F	01/05→06/08	AKE 23235		598361	2										
CHRYSLER 																	
300C (2004>)																	
2.7i V6, 3.0CRD V6, 3.5i V6, 5.7i V8		F	06/04→12/05	BOS 23590		● 601032	8										
2.7i V6, 3.0CRD V6, 3.5i V6, 5.7i V8 6.1SRT-8 V8		F	01/06→														
		R	06/04→	KH		● 601033	8										
300M (98>2003)																	
2.7i V6, 3.5i V6		F	01/98→12/00														
		F	01/01→04/03	KH 23043		598556	0										
		R	01/98→04/03	KH 23561		598544	0										270x12

		
CHRYSLER  (.../...)		
Crossfire (2003>)		
3.2i V6	F 07/03→	ATE 21670  598636 431 828  300x28
	R 07/03→	ATE 21919  598444 0  278x9 (7,3) 186470
Le Baron (81>96)		
2.2 Turbo, 2.5, 2.5 Turbo, 3.0	F 09/86→1996	KH 21815  598600 0  282x24
	R 09/86→1996	 598600 0  270x12
Neon (93>)		
2.0i	F 10/93→12/94	KH 21815  598600 0  257x20
	F 01/95→12/98	KH 23043  598556 0  257x20
1.6i, 2.0i	F 01/99→	 598556 0  257x20
2.0i	R 10/93→12/98	KH 23561  598965 0  270x9
1.6i, 2.0i	R 01/99→	 598965 0  270x9
PT Cruiser (2000>2009)		
1.6i, 2.0i, 2.2CRD, 2.4i, 2.4i Turbo 	F 06/00→11/07	LUC 23532  598543 0  280x23 (21,4) 186734
	R 06/00→11/07	KH 23561  598544 0  270x9
Saratoga (88>90)		
2.5 Turbo, 3.0	F 09/88→12/90	KH 21815  598600 0  260,5x24
	R 09/88→12/90	 598600 0  270x12
Sebring (2000>2007)		
2.0i, 2.7i V6	F 03/00→03/07	ATE 23951  ● 598905 0  282x23
	R 03/00→03/07	 598905 0  270x9
Stratus (94>)		
2.0i, 2.4i, 2.5i V6	F 01/94→	BDX 23320  ● 598904 4  282x23
	R 01/94→12/98	KH 23561  598965 0  270x9
	R 01/99→	 598965 0  270x9
Vision (92>98)		
3.5 V6	F 10/92→12/94	 598556 0  282x23
	F 01/95→09/98	KH 23043  598556 0  270x9

																	
CHRYSLER  (.../...)																	
Vision (92>98) (.../...)																	
3.5 V6 (...)	R	10/92-12/94															
	R	01/95-09/98	KH 23561		598965	0											
Voyager II (91>95)																	
2.5TD, 2.5i, 3.3i	⊙ 14"	F	03/91-10/95														
	⊙ 15"	F	03/91-10/95	KH 21815		598600	0										186570
Voyager III (96>2001)																	
2.0i, 2.4i, 2.5TD, 2.5i, 3.3i, 3.8i	F	01/96-03/01	KH 23043		598556	0											186730
Voyager IV (2001>)																	
2.4i, 2.5CRD, 3.3i V6, 3.8i	ABS(-)	F	03/01-06/04	ATE 23640		598415	2										197069
	ABS(+)	F	03/01-06/04	ATE 23807		598756											197233
		R	03/01-06/04	KH 24036		598755											197022
Voyager V (2004>)																	
2.4i, 2.5CRD, 2.8CRD, 3.3i V6	ABS(-)	F	07/04→														197069
	ABS(+)	F	07/04→	ATE 23807		598756											197233
		R	07/04→	KH 24036		598755											197022
Grand Voyager (92>95)																	
2.5TD, 3.3i	⊙ 14"	F	04/92-10/95	KH 21815		598600	0										
	⊙ 15"	F	04/92-10/95	KH 21815		598600	0										186570
Grand Voyager (96>2001)																	
2.5TD, 3.3i V6, 3.8i V6	F	01/96-12/99	KH 23043		598556	0											186730
	F	01/00-03/01	KH 23043		598556	0											197233
Grand Voyager (2001>2004)																	
2.4i, 2.5CRD, 3.3i V6	ABS(-)	F	03/01-06/04	ATE 23640		598415	2										197069
	ABS(+)	F	03/01-06/04	ATE 23807		598756											197233
		R	03/01-06/04	KH 24036		598755											197022
Grand Voyager (2004>2008)																	
2.4i, 2.5CRD, 2.8CRD, 3.3i V6	ABS(-)	F	07/04-01/08														197069









														
			 WVA											
CHRYSLER  (.../...)														
Grand Voyager (2004>2008) (.../...)														
2.4i, 2.5CRD, 2.8CRD, 3.3i V6 (...)	ABS(+)	F	07/04→01/08	ATE 23807		598756					302x28 (26,5)	● 197233		
		R	07/04→01/08	KH 24036		598755					290x12,5 (11,3)	● 197022		
CITROËN 														
C Crosser														
2.2HDI, 2.4i		F	07/07→											
		R	07/07→	AKE 24014		598852	2				302x10 (8,4)	● 197116		
CITROËN 														
2 CV														
0.6		F	1981→08/90	CIT 20207		598144	0				244x7 (5)	● 186128		
		P	09/76→08/90	CIT 20285		598362	0							
Ami 8														
0.6		F	09/69→07/78	CIT 20207		598144	0				244x7 (5)	● 186128		
		P	03/69→07/78	CIT 20285		598362	0							
1.0		F	12/72→06/76	CIT 20288		* 598145	4				269x9			
		P	12/72→06/76	CIT 20307		* 598363	0							
AX (86>91)														
1.0, 1.1, 1.1i, 1.4D	CRF(-)	F	09/86→10/90	ATE 21145		598156	4				238x8 (6)	● 186130		
	CRF(+)	F	09/86→10/90	ATE 21145		598030	4				238x8 (6)	● 186130	● 186908	
		F	10/90→04/91	ATE 21145		598030	4				238x8 (6)	● 186130	● 186908	
1.4, 1.4i (44...59KW)	CRF(-)	F	09/86→10/90	ATE 21145		598156	4				238x8 (6)	● 186130		
	CRF(+)	F	09/86→10/90	ATE 21145		598030	4				238x8 (6)	● 186130	● 186908	
		F	10/90→04/91	ATE 21145		598030	4				238x8 (6)	● 186130	● 186908	
1.4, 1.4i (63KW)		F	09/87→06/89	ATE 21145		598030	4				238x10			
		F	07/89→04/91	ATE 21145		598030	4				258x10 (9)	* 186131		
1.3 (70KW)		F	04/87→01/88	ATE 21145		598030	4				238x10			
		F	01/88→04/91	ATE 21145		598030	4				258x10 (9)	* 186131		

																		
CITROËN  (.../...)																		
AX (91>98)																		
1.0, 1.0i, 1.1, 1.1i	F	05/91→07/98	ATE 21145		598030	4		238x8 (6)	186130	186908								
1.1 4x4, 1.4, 1.4 4x4, 1.4D, 1.4i, 1.4i 4x4 1.5D	F	05/91→07/96	BDX 21061		598155	4		247x10 (9)	186276	186930								
1.4i GTI (66...74KW)	F	05/91→12/96	LUC 20989		598714	4		247x20,5 (18,5)	186194									
Electrique	F	07/94→07/98	ATE 21145		598360	0		283x22 (20)	186296									
Axel (84>90)																		
1.1, 1.3	F	06/84→1990	CIT 20690		598149	4												
	R	06/84→1990	CIT 20297		* 598146	0		208x7										
	P	06/84→1990	CIT 20307		* 598363	0												
BX (82>94)																		
1.1, 1.4, 1.4 GPL, 1.4i, 1.6, 1.6 GPL, 1.6i 1.7D, 1.7TD, 1.9, 1.9D, 1.9i 	F	09/82→12/94	BDX 20635		598151	4		266x10 (8)	186134	186906								
1.9i 16S 	F	07/87→12/94	BDX 20635		598151	4		266x20,5 (18,6)	186198									
1.1, 1.4, 1.4 GPL, 1.4i, 1.6, 1.6 GPL, 1.6i 1.7D, 1.7TD, 1.9, 1.9D, 1.9i, 1.9i 16S 	R	09/82→12/94	CIT 20575		598148	0		224x7 (5)	186135									
C1 (2005>)																		
1.0i, 1.4HDi	F	06/05→	BOS 23959		598718	0		247x20 (18)	● 197047									
C2 (2003>2010)																		
1.1i, 1.4HDi, 1.4i	F	09/03→01/10	LUC 23407		598500	0		266x13 (11)	186599	●186981								
	F	09/03→01/10	LUC 23409		598501	0		266x13 (11)	186599									
1.4HDi, 1.6i	F	09/03→01/10	LUC 23409		598501	0		266x22 (20,4)	186695									
1.6HDi, 1.6i	F	07/04→01/10	BOS 23599		598464	0		266x22 (20,4)	186695	●186968								
1.4HDi, 1.4i, 1.6HDi, 1.6i	R	09/03→01/10	LUC 20960		598463	0(D)		247x9 (7)	186694									
C3 (2002>2005)																		
1.1i, 1.4HDi, 1.4i, 1.4i GNV	F	04/02→10/05	LUC 23407		598500	0		266x13 (11)	186599	●186981								
1.4HDi, 1.4i, 1.6HDi, 1.6i	F	04/02→10/05	LUC 23409		598501	0		266x22 (20,4)	186695									
1.4HDi, 1.6i	ESP(+)	R	04/02→10/05	LUC 20960		598463	0(D)		247x9 (7)	186694								







CITROËN (.../...)





C3 (2005>)

1.1i, 1.1i GPL, 1.4HDi, 1.4i, 1.4i GNV		F	11/05→	LUC 23407 	598500	0	 266x13 (11)	186599	● 186981
1.4i, 1.6HDi, 1.6i	⊙ 15"	F	11/05→10/09	LUC 23409 	598501	0	 266x22 (20,4)	186695	
	⊙ 16"	F	11/05→10/09	BOS 23599 	598464	0	 266x22 (20,4)	186695	● 186968
1.6HDi, 1.6i		F	11/05→10/09	BOS 23600 	598465	0	 283x26 (24)	186693	● 186972
		R	11/05→10/09				 247x9 (7)	186694	





C3 (2009>)

1.1i, 1.4HDi 70, 1.4VTi 95, 1.4i, 1.6HDi 90		F	10/09→	BOS 23599 	598464	0	 266x22 (20,4)	186695	● 186968
1.6VTi 120		F	10/09→				 283x26 (24)	186693	
	Bearing Roulement (+)	R	10/09→	LUC 20960 	598474	0(D+C)	 249x9 (7)		● 197002













C3 Pluriel (2003>)



















































1.4HDi, 1.4i, 1.6i		F	05/03→	LUC 23409 	598501	0	 266x22 (20,4)	186695	
1.6i		R	05/03→	LUC 20960 	598463	0(D)	 247x9 (7)	186694	





































C3 Picasso (2009>)



























1.4VTi 95, 1.6HDi 90		F	02/09→	BOS 23599 	598464	0	 266x22 (20,4)	186695	● 186968
1.6HDi 110, 1.6VTi 120		F	02/09→				 283x26 (24)	186693	
1.4VTi 95 1.6HDi 110 1.6HDi 90 1.6VTi 120	Bearing Roulement (+)	R	02/09→	LUC 20960 	598474	0(D+C)	 249x9 (7)		● 197002











































C4 (2004>)

























































1.4i, 1.6HDi, 1.6i	ESP(-)	F	11/04→	BOS 23599 	598464	0	 266x22 (20,4)	186695	● 186968
	ESP(+)	F	11/04→09/05	BOS 23600 	598465	0	 283x26 (24)	186693	● 186972
	ESP(+)	F	09/05→	BOS 23599 	598464	0	 266x22 (20,4)	186695	● 186968
1.6THP, 1.6VTi, 2.0i (101/102KW)		F	11/04→	BOS 23600 	598465	0	 283x26 (24)	186693	● 186972
2.0HDi (4 Doors)		F	02/07→10/09	BOS 23600 	598465	0	 283x26 (24)	186693	● 186972
		F	10/09→						
2.0HDi (3/5 Doors), 2.0i (130KW)		F	11/04→05/08	ATE 23589 	598715	0	 302x26 (24)		● 197232



										
CITROËN  (.../...)										
C4 (2004>) (.../...)										
2.0Hdi (3/5 Doors), 2.0i (130KW) (...)	F	11/04→	ATE 23589 	598715	0		302x26			
1.4i 1.6Hdi 1.6i 2.0Hdi 2.0i	R	11/04→01/06	Ø25 bearing, Bearing Roulement (-) 	598702	0		249x9 (8)	186840		
Ø25 bearing, Bearing Roulement (+) 			598702	0		249x9 (8)	186899			
Ø30 bearing, Bearing Roulement (+) 			598702	0		249x9 (7)	197002			
	R	11/04→01/06	Ø25 bearing, Bearing Roulement (-) 	598463	0(D)		249x9 (8)	186840		
	R	01/06→	Ø25 bearing, Bearing Roulement (+) 	598463	0(D)		249x9 (8)	186899		
	R	01/06→	Ø30 bearing, Bearing Roulement (+) 	598463	0(D)		249x9 (7)	197002		
1.6THP 1.6Vti	R	07/08→	Ø25 bearing, Bearing Roulement (-) 	598463	0(D)		249x9 (8)	186840		
Ø25 bearing, Bearing Roulement (+) 			598463	0(D)		249x9 (8)	186899			
Ø30 bearing, Bearing Roulement (+) 			598463	0(D)		249x9 (7)	197002			
1.6Hdi, 1.6i (4 Doors)	R	04/08→	LUC 20960 	598463	0(D)		247x9 (7)	186694		
2.0Hdi (4 Doors)	R	02/07→09/07	LUC 20960 	598463	0(D)		247x9 (7)	186694		
	R	09/07→					247x9 (7)	186694		
C4 Picasso (2006>)										
1.6Hdi, 1.6i THP, 1.8i	F	09/06→	ATE 24538 	598997	0		283x26 (24)	186693		
1.6i THP, 2.0Hdi, 2.0i	F	09/06→	ATE 24557 	598998	0		302x26 (24)	197232		
1.6Hdi, 1.6i THP 1.8i, 2.0Hdi, 2.0i	R	09/06→	LUC 24540 	598936	0		267x12	197117		
C5 (2001>2008)										
1.8i 	F	02/01→03/08	BOS 23276 	598417	4		266x22 (20,4)	186695		
1.6Hdi, 1.8i, 2.0Hdi, 2.0HPi, 2.0i 	F	02/01→03/08	BOS 23277 	598419	4		283x26 (24)	186693		
2.0Hdi, 2.2Hdi, 3.0i V6 	F	02/01→06/08	BOS 23273 	598416	4		288x28 (26)	197220		

























































															
CITROËN  (.../...)															
C5 (2001>2008) (.../...)															
1.6HDI, 1.8i, 2.0HDI, 2.0HPI, 2.0i, 2.2HDI 3.0i V6 		R	02/01→06/08	CIT 23305		598418	0		275x14 (12)	186736					
C5 (2008>)															
1.6HDI, 1.6THP-155, 1.8i, 2.0HDI, 2.0HDI-160 2.0i		F	03/08→												
2.2HDI, 2.7HDI V6, 3.0i V6		F	03/08→06/09	LUC 24133		598663	2								
3.0HDI V6		F	07/09→												
1.6HDI, 1.8i, 2.0HDI, 2.0i		R	03/08→	LUC 24135		598664	0		290x12 (10)	186747					
1.6THP-155, 2.0HDI, 2.0HDI-160, 2.0i, 2.2HDI 2.7HDI V6, 3.0HDI V6, 3.0i V6		R	03/08→	ATE 24137		598783	0		290x12 (10)	186747					
C6 (2005>)															
2.2HDI, 2.7HDI V6, 3.0i V6		F	12/05→07/07	LUC 24133		598663	2		330x30 (28)	197046					
3.0HDI V6		F	12/05→						340x30						
2.2HDI, 2.7HDI V6, 3.0HDI V6, 3.0i V6		R	12/05→	LUC 24462		598939	1		320x22						
C8 (2002>)															
2.0HDI, 2.0i, 2.2HDI, 2.2i		F	06/02→	LUC 20261		598553	2(A)		285,2x28 (26)	197219	186984				
2.2HDI		F	12/07→						310x32						
3.0i V6		F	06/02→09/05	BBO 23092		598468	4		310x32						
2.0HDI, 2.0i, 2.2HDI, 2.2i, 3.0i V6		R	06/02→	LUC 20960		598463	0(D)		272x12 (10)	186724					
CX (74>91)															
2.0, 2.2, 2.2 GPL, 2.2D, 2.3, 2.3i 2.3i Injection, 2.5D, 2.5D Turbo 2.5D Turbo 2, 2.5i, 2.5i Turbo 2.5i Turbo 2 		R	07/74→1989	CIT 20575		598292	0								
2.0, 2.2, 2.2 GPL, 2.2D, 2.3, 2.3i 2.3i Injection, 2.5D, 2.5D Turbo 2.5D Turbo 2, 2.5i, 2.5i Turbo 2.5i Turbo 2 		R	12/75→1991	CIT 20575		598292	0		224x7 (6,3)	* 186140					
2.0, 2.2, 2.2D, 2.3, 2.3i, 2.3i Injection 		R	07/74→07/80	CIT 20575		598292	0		233,5x9						







																	
CITROËN  (.../...)																	
CX (74>91) (.../...)																	
2.0, 2.2, 2.2D, 2.3, 2.3i, 2.5D, 2.5D Turbo 2.5D Turbo 2, 2.5i 		R	12/75→1991	CIT 20389		598207	0										
2.0, 2.2, 2.2 GPL, 2.2D, 2.3, 2.3i 2.3i Injection, 2.5D, 2.5D Turbo 2.5D Turbo 2, 2.5i, 2.5i Turbo 2.5i Turbo 2  		P	07/74→1991	CIT 20371		598364	0										
DS3 (2010>)																	
1.4VTi 95, 1.6HDi 90		F	03/10→	BOS 23599		598464	0										
1.6HDI 110, 1.6THP 150, 1.6VTi 120		F	03/10→														
Bearing Roulement (+)		R	03/10→	LUC 20960		598474	O(D+C)										
Dyane (67>83)																	
0.6		F	09/68→02/70														
		F	07/77→07/83	CIT 20207		598144	0										
		P	02/72→07/83	CIT 20285		598362	0										
Evasion (94>98)																	
1.8i		F	07/96→09/98	BDX 23042		598073	2										
1.9TD, 2.0i, 2.0i Turbo CT, 2.1TD		F	07/94→09/98	LUC 21801		598064	4										
1.8i, 1.9TD, 2.0i, 2.0i Turbo CT 2.1TD		ABS(+)	R	07/94→09/98	ATE 21275		598502	0									
		ABS(+)	P	07/94→09/98			562739										
Evasion (98>2002)																	
1.8i		F	10/98→05/02	BDX 23042		598073	2										
1.9TD, 2.0HDI, 2.0i, 2.0i Turbo CT, 2.1TD		F	10/98→05/02	LUC 21801		598064	4										
1.8i, 1.9TD, 2.0i, 2.0i Turbo CT, 2.1TD			R	10/98→05/02	ATE 21275		598502	0									
			P	10/98→05/02			562739										
Fukang (93>)																	
1.4			F	07/93→	BDX 21061		598155	4									
1.6i		ABS(-)	F	07/96→	BDX 21061		598155	4									

																		
CITROËN  (.../...)																		
Fukang (93>) (.../...)																		
1.6i (...)	ABS(+)	F	07/96→	LUC 20772		598154	4(A)		247x20,5 (18,5)	186194	186909							
GS (70>80)																		
1.0, 1.2		F	09/70→02/73						269x9									
1.0, 1.1, 1.2, 1.3		F	09/72→06/80	CIT 20288		* 598145	4		269x9									
		R	09/70→06/80	CIT 20297		* 598146	0		178x7									
1.0, 1.2		P	09/70→02/73	CIT 20285		598362	0											
1.0, 1.1, 1.2, 1.3		P	09/72→06/80	CIT 20307		* 598363	0											
GSA (79>86)																		
1.1, 1.3		F	09/79→06/80	CIT 20288		* 598145	4											
		F	09/79→1986	CIT 20690		598149	4		269x9									
		R	09/79→1986	CIT 20297		* 598146	0		178x7									
		P	09/79→1986	CIT 20307		* 598363	0											
LN/LNA (76>86)																		
0.6, 0.7		F	09/76→1986	BDX 20347		598085	2		241x10 (9)	186142								
0.7, 1.0, 1.1		F	10/81→1986	CIT 20594		598150	4		244,5x8,9 (7)	186143								
Mehari (68>87)																		
0.6		F	07/77→07/87	CIT 20207		598144	0		244x7 (5)	186128								
		R	10/79→07/83	CIT 20297		* 598146	0		178x7									
		P	10/79→07/83	CIT 20285		598362	0											
Saxo (96>99)																		
1.0i, 1.1i, 1.1i GPL	⊗3	F	03/96→08/99	ATE 21145		598360	0		238x8 (6)	186130								
1.0i, 1.1i, 1.1i GPL, 1.4i, 1.5D Electrique	⊗4	F	03/96→08/99	BDX 21061		598075	0		247,3x10 (8)	186200								
1.6i		F	03/96→08/99	ATE 21430		598074	0		247x20,5 (18,5)	186194	●186986							
		R	03/96→08/99	BDX 20635		598396	0		247x8 (6)	186416								
Saxo (99>2005)																		
1.0i	⊗3	F	09/99→12/03	ATE 21145		598360	0		238x8 (6)	186130								

									
CITROËN  (.../...)									
Saxo (99>2005) (.../...)									
1.1i, 1.1i GPL, 1.4i, 1.4i GPL, 1.5D Electrique	F	09/99→05/05	BDX 21061 	598075	0	 247,3x10 (8)	186200		
1.4i	F	09/99→12/03	ATE 21430 	598074	0	 247,3x10 (8)	186200		
	F	09/99→12/03	BDX 21061 	598075	0	 247x20,5 (18,5)	186194		
1.4i, 1.6i	F	09/99→12/03	ATE 21430 	598074	0	 247x20,5 (18,5)	186194	●186986	
1.6i	R	09/99→12/03	BDX 20635 	598396	0	 247x8 (6)	186416		
Synergie (95>98)									
1.8i	F	07/96→09/98	BDX 23042 	598073	2	 257x20 (18,2)	186589	186931	
1.9TD, 2.0i	F	10/95→09/98	LUC 21801 	598064	4	 281x26 (24,2)	186420		
1.8i, 1.9TD, 2.0i	ABS(+)	R	10/95→09/98	ATE 21275 	598502	0	 295x10 (8)	186421	
	ABS(+)	P	10/95→09/98		562739				
Synergie (98>2002)									
1.9TD, 2.0HDi, 2.0i	F	10/98→05/02	LUC 21801 	598064	4	 281x26 (24,2)	186420		
1.9TD, 2.0i	ABS(+)	R	10/98→05/02	ATE 21275 	598502	0	 295x10 (8)	186421	
	ABS(+)	P	10/98→05/02		562739				
Visa (78>88)									
0.7, 1.0, 1.1, 1.2, 1.4, 1.4i 	F	07/80→1988	CIT 20594 	598150	4	 244,5x8,9 (7)	186143		
0.7, 1.1 	F	10/78→07/83	BDX 20347 	598085	2	 241x10 (9)	186142		
1.4 	F	03/81→1987	ATE 20913 	* 598375	2(A)	 241x10 (9)	186142		
1.8D 	F	03/84→1988	LUC 20989 	598119	4	 247,3x10 (8)	186200	186907	
1.6i 	F	10/84→1988	LUC 20989 	598119	4	 247x20,4 (18,5)	186195		
Xantia (93>97)									
1.6i, 1.8i, 1.8i GPL, 1.9D, 1.9SD, 1.9TD 2.0i 	F	03/93→12/97	BDX 21631 	598031	4	 266x20,5 (18,6)	186198	186928	
2.0i 	F	08/93→12/97	BDX 21632 	598383	4	 266x20,5 (18,6)	186198		
1.8i, 1.9SD, 1.9TD, 2.0i 	ABS(+)	F	03/93→12/97	BDX 21632 	598383	4	 283x22 (20)	186296	
2.0i Turbo CT, 2.1TD 	F	07/95→12/97	BDX 23129 	598385	4	 283x26 (24)	186533		



															
CITROËN  (.../...)															
Xantia (93>97) (.../...)															
3.0i V6 	F	11/96→12/97	BOS 23134 	598420	4		288x28 (26)	●	197220						
1.6i, 1.8i, 1.8i GPL, 1.9D, 1.9SD, 1.9TD 2.0i, 2.0i Turbo CT, 2.1TD, 3.0i V6 	R	03/93→12/97	CIT 20575 	598292	0		224x7 (7)		186586						
1.8i, 1.9SD, 1.9TD, 2.0i, 2.0i Turbo CT 2.1TD 	R	03/93→12/97	CIT 20389 	598207	0		251x12 (10,8)		186569						
Xantia (97>2002)															
1.6i, 1.8i, 1.8i GPL, 1.9SD, 1.9TD 2.0HDi  	F	12/97→05/02	BDX 21631 	598031	4		266x20,5 (18,6)		186198	186928					
1.9SD, 1.9TD, 2.0HDi, 2.0i  	F	12/97→05/02	BDX 21632 	598383	4		283x22 (20)		186296						
2.0i, 2.0i Turbo CT, 2.1TD  	F	12/97→10/98	BDX 23129 	598385	4		283x26 (24)		186533						
1.9TD, 2.0HDi, 2.0i, 2.0i Turbo CT, 2.1TD 3.0i V6  	F	12/97→05/02	BOS 23134 	598420	4		288x28 (26)	●	197220						
1.6i, 1.8i, 1.8i GPL, 1.9SD, 1.9TD, 2.0HDi 2.0i, 2.0i Turbo CT, 2.1TD, 3.0i V6 	R	12/97→05/02	CIT 20575 	598292	0		224x7 (7)		186586						
1.8i, 1.8i GPL, 1.9SD, 1.9TD, 2.0HDi, 2.0i 2.0i Turbo CT, 2.1TD, 3.0i V6 	R	12/97→05/02	CIT 20389 	598207	0		251x12 (10,8)		186569						
XM (89>94)															
2.0, 2.0i, 2.1D D12, 2.1TD Turbo D12 3.0i V6 	F	05/89→03/91	BDX 21295 	598029	4		276x22 (20)		186145						
2.0, 2.0i, 2.0i Turbo CT, 2.1D D12 2.1TD Turbo D12, 3.0i V6  	F	03/91→06/94	BDX 21507 	598028	4		283x26 (24)		186303						
2.0, 2.0i, 2.0i Turbo CT, 2.1D D12 2.1TD Turbo D12, 3.0i V6 	R	05/89→06/94	CIT 20575 	598292	0		224x9 (7)		186144						
2.0i, 2.0i Turbo CT, 2.1D D12 2.1TD Turbo D12, 3.0i V6 	R	09/91→06/94	CIT 20389 	598207	0		250x12 (10,8)		186621						
XM (94>2001)															
2.0i, 2.0i Turbo CT, 2.1D D12 2.1TD Turbo D12, 2.5TD Turbo D, 3.0i V6  	F	07/94→07/01	BDX 21507 	598028	4		283x26 (24)		186303						
2.5TD Turbo D, 3.0i V6  	F	04/97→07/01	BOS 23134 	598420	4		288x28								





























													
CITROËN  (.../...)													
XM (94>2001) (.../...)													
2.0i, 2.0i Turbo CT, 2.1D D12		R	07/94→07/01	CIT 20575		598292	0		224x9 (7)	186144			
2.1TD Turbo D12, 2.5TD Turbo D, 3.0i V6 													
2.0i, 2.0i Turbo CT, 2.1D D12		R	07/94→03/00	CIT 20389		598207	0		250x12 (10,8)	186621			
2.1TD Turbo D12, 2.5TD Turbo D, 3.0i V6 													
Xsara (97>2000)													
1.4i, 1.4i GPL, 1.5D 		ABS(-)	F	07/97→08/00	BOS 21980		598461	0(A)		247x13 (11)	186598	●186971	
1.4i, 1.4i GPL, 1.5D, 1.6i, 1.8D, 1.8i, 1.9D			F	07/97→08/00	ATE 21430		598074	0		247x20,5 (18,5)	186194	●186986	
1.9TD 													
1.8i 			F	05/98→08/00	LUC 23124		598326	4		247x20,5 (18,5)	186194		
			F	05/98→08/00	BOS 23396		598462	0		247x20,5 (18,5)	186194		
			F	05/98→08/00	ATE 21430		598074	0		266x20,5 (18,6)	186198		
1.4i, 1.4i GPL, 1.5D, 1.6i, 1.8D		ABS(+)	F	07/97→08/00	LUC 23124		598326	4		266x20,5 (18,6)	186198	●186978	
1.8i, 1.8i GPL, 1.9D, 1.9SD, 1.9TD													
2.0HDi, 2.0i 													
1.8i, 1.8i GPL, 2.0HDi, 2.0i 			F	07/97→08/00	BOS 23396		598462	0		266x20,5 (18,6)	186198		
2.0i 			F	06/98→08/00	LUC 21674		598069	4		266x20,5 (18,6)	186198		
2.0i 			F	01/98→08/00	LUC 21674		598069	4		283x22 (20)	186296		
1.8i, 1.8i GPL, 2.0HDi, 2.0i 			R	07/97→08/00	BDX 20635		598396	0		247x8 (6)	186416		
Xsara (2000>2005)													
1.4HDi, 1.4i, 1.6i, 1.9D, 2.0HDi			F	09/00→08/05	BOS 23599		598464	0		266x22 (20,4)	186695	●186968	
2.0HDi, 2.0i			F	09/00→09/01	LUC 21674		598069	4		283x22 (20)	186296		
			F	09/01→08/05	BOS 23600		598465	0		283x26 (24)	186693	●186972	
2.0i			R	09/00→08/05	LUC 23409		598501	0		247x8 (6)	186416		
1.6i, 2.0HDi, 2.0i			R	09/00→08/05	BDX 20635		598396	0		247x8 (6)	186416		
Xsara Picasso (99>)													
1.6i, 1.8i, 2.0HDi			F	12/99→11/01	LUC 23124		598398	0		266x20,5 (18,6)	186198		
1.6HDi, 1.6i, 1.8i, 2.0HDi		ESP(-)	F	12/99→	BOS 23599		598464	0		266x22 (20,4)	186695	●186968	













			R P F		WVA		Valeo		Valeo		Valeo	
CITROËN  (.../...)												
Xsara Picasso (99>) (.../...)												
1.6Hdi, 1.6i, 1.8i, 2.0Hdi, 2.0i	ESP(+)	F	11/02→	BOS 23600		598465	0		283x26 (24)	186693	● 186972	
	ESP(+)	R	11/02→	LUC 20960		598463	0(D)		247x9 (7)	186694		
ZX (91>98)												
1.1, 1.1i, 1.4, 1.4D, 1.4i, 1.5D, 1.8D 1.9D 		F	03/91→07/98	BDX 21061		598155	4		247,3x10 (8)	186200	186910	
1.8D, 1.9D 		F	09/92→06/93	LUC 20989		598714	4		247,3x10 (8)	186200	186926	
1.6i, 1.8i, 1.9D, 1.9TD, 1.9i, 2.0i 		F	03/91→07/98	LUC 20772		598154	4(A)		247x20,5 (18,5)	186194	186909	
2.0i 16V (114KW) 		F	10/92→07/98	LUC 21209		598353	4		266x20,5 (18,6)	186198		
2.0i 16V (123KW) 		F	07/95→07/98	LUC 21674		598069	4		283x22 (20)	186296		
1.6i, 1.8i, 1.9TD, 1.9i, 2.0i 2.0i 16V 	ABS(+)	R	03/91→07/98	BDX 20635		598396	0		247x8 (6)	186416		
CITROËN 												
Acadiane (78>87)												
0.6		F	02/78→06/87	CIT 20207		598144	0		244x7 (5)	186128		
		P	02/78→06/87	CIT 20285		598362	0					
Berlingo (96>2002)												
1.1i, 1.1i GPL, 1.4, 1.4i, 1.4i GPL, 1.6i 1.8D, 1.8i, 1.9D, 2.0Hdi, Electrique		F	07/96→12/02	LUC 23124		598326	4		266x13 (11)	186599		
1.8D, 1.8i, 1.9D		F	07/96→09/98	LUC 23124		598326	4		266x20,5 (18,6)	186198	● 186978	
1.6i, 1.8D, 1.8i, 1.9D, 2.0Hdi, Electrique		F	07/96→12/02	LUC 23124		598398	0		266x20,5 (18,6)	186198		
		F	07/96→12/02	BOS 23599		598464	0		266x20,5 (18,6)	186198		
		F	07/96→12/02	LUC 23124		598398	0		266x22 (20,4)	186695		
		F	07/96→12/02	BOS 23599		598464	0		266x22 (20,4)	186695	● 186968	
Berlingo (2002>)												
1.1i, 1.4i, 1.4i GNV, 1.4i GPL 1.6Hdi, 1.6i, 1.9D, 2.0Hdi Electrique 	ESP(-)	F	12/02→	BOS 23599		598464	0		266x22 (20,4)	186695	● 186968	
1.6Hdi, 1.6i, 2.0Hdi 	ESP(+)	F	12/02→05/08	BOS 23600		598465	0		283x26 (24)	186693	● 186972	















																		
CITROËN  (.../...)																		
Berlingo (2002>) (.../...)																		
1.6HDi, 1.6i, 2.0HDi  (...)			ESP(+)	R	12/02→05/08	LUC 20960		598463	0(D)		247x9 (7)	186694						
Berlingo (2008>)																		
1.6HDi, 1.6VTi, 1.6i  				F	05/08→	ATE 24538		598997	0		283x26 (24)	186693						
Bearing Roulement (+)				R	05/08→	LUC 24765		601042	0		267x12	197117						
C15 (84>2005)																		
1.0, 1.1, 1.4, 1.4i 				F	10/84→05/88	CIT 20594		598150	4		244,5x8,9 (7)	186143						
1.0, 1.1, 1.1i, 1.3, 1.4, 1.4i, 1.7D  				F	10/84→02/01	LUC 20989		598119	4		247,3x10 (8)	186200	186907					
1.9D 				F	09/01→12/05	BDX 21061		598155	4		247,3x10 (8)	186200	186910					
C25 (81>90)																		
1.8, 2.0, 2.5D				F	11/81→1990	LUC 20741		598153	2		256x13 (11)	186205						
1.8, 1.9D, 2.0, 2.5D, 2.5TD				F	07/83→1990	LUC 20741		598153	2		256x16 (13,5)	186206						
1.8, 2.5D				F	07/83→1990	LUC 20741		598153	2		290x16 (14,8)	186136						
2.5TD				F	07/87→1990	LUC 21206		598138	2		290x16 (14,8)	186136						
C25 (90>94)																		
1.8, 1.9D, 2.0, 2.5D				F	09/90→02/94	LUC 20741		598153	2		256x16 (13,5)	186206						
1.9TD				F	09/90→02/94	LUC 21206		598138	2		256x16 (13,5)	186206						
2.0, 2.5D, 2.5TD				F	09/90→02/94	LUC 21206		598138	2		290x16 (14,8)	186136						
C32 (73>79)																		
2.2D				F	11/73→12/79	CIT 20655		598591	4		285x20 (18)	* 186137						
				R	11/73→12/79	CIT 20288		* 598145	4		279x8,9							
C35 (73>91)																		
2.0, 2.2D, 2.5D				F	11/73→12/91	CIT 20655		598591	4		285x20 (18)	* 186137						
				R	11/73→12/91	CIT 20288		* 598145	4		279x8,9							
Dispatch (95>2003)																		
1.6i, 1.9D, 1.9TD, 2.0HDi				F	09/95→12/03	BDX 23042		598073	2		257x20 (18,2)	186589	186931					
1.9TD, 2.0HDi				F	07/98→12/03	LUC 21801		598064	4		281x26 (24,2)	186420						









CITROËN (.../...)									
Dispatch (2004>2006)									
1.9D	F	01/04→12/06	BDX 23042	598073	2		257x20 (18,2)	186589	186931
2.0Hdi	F	01/04→12/06	LUC 20261	598553	2(A)		285,2x28 (26)	● 197219	● 186984
Dispatch (2007>)									
1.6Hdi 1.0T	F	01/07→	LUC 24595	● 598899	1		280x28 (26)	● 197188	
1.6Hdi 1.2T, 2.0Hdi, 2.0i	F	01/07→	LUC 24595	● 598899	1		304x28 (26)	● 197133	
	R	01/07→	LUC 24578	● 601039	0		290x14 (12)	● 197099	
Jumper (94>2001)									
1.9D, 1.9TD, 2.0, 2.0i, 2.5D	10Q, 14Q	F	02/94→12/01	LUC 21797	598070	2(B)		280x18 (15,9)	● 197217
	10Q, 14Q	F	02/94→12/01	LUC 21797	598429	1(A)		280x18 (15,9)	● 197217
2.0Hdi, 2.5TD, 2.5TDi, 2.8D 2.8Hdi, 2.8TD	10Q, 14Q	F	02/94→12/01	LUC 21797	598070	2(B)		280x24 (21,9)	186418
	10Q, 14Q	F	02/94→12/01	LUC 21797	598429	1(A)		280x24 (21,9)	186418
2.0, 2.0i, 2.5D, 2.5TD, 2.5TDi 2.8Hdi	18Q	F	02/94→12/01	LUC 21799	598800	2(A)		300x24 (21,9)	● 197228
	18Q	F	02/94→12/01	LUC 21799	598430	1(B)		300x24 (21,9)	● 197228
Jumper (2002>2006)									
2.0Hdi, 2.0i, 2.2Hdi, 2.8Hdi	11Q, 15Q	F	01/02→06/06	BBO 23918	598568	1		280x24 (21,9)	186418
2.0i, 2.2Hdi, 2.8Hdi	18Q	F	01/02→06/06	BBO 23919	598569	1		300x24 (21,9)	● 197228
2.8Hdi	11Q, 15Q	R	01/02→06/06	BBO 23921	598570	0		280x16	
2.0i, 2.2Hdi, 2.8Hdi	18Q	R	01/02→06/06	BBO 23921	598570	0		280x16 (14,2)	186708
Jumper II (2006>)									
2.2Hdi, 3.0Hdi	330, 333	F	07/06→	BBO 24468	● 598891	1		280x24 (21,9)	● 197043
	335	F	07/06→	BBO 24468	● 598891	1		280x28 (25,9)	● 197248
3.0Hdi	335, 1700Kg	F	07/06→					300x24 (21,9)	● 197131
	335, 2000Kg	F	07/06→					300x32	
2.2Hdi, 3.0Hdi	330, 333, 335	R	07/06→	BOS 24465	● 598892	0		280x16 (14,2)	● 197023
3.0Hdi	335, 1700Kg	R	07/06→					280x16 (14,2)	● 197097









































													
CITROËN  (.../...)													
Jumper II (2006>) (.../...)													
3.0Hdi (...)	335, 2000Kg	R	07/06→								300x16 (14,2)	● 197105	
Jumpy (95>2003)													
1.6i, 1.9D, 1.9TD, 2.0Hdi, 2.0i		F	09/95→12/03	BDX 23042		598073	2		257x20 (18,2)		186589	186931	
		F	09/95→12/03	LUC 21801		598064	4		281x26 (24,2)		186420		
Jumpy (2004>2006)													
1.9D		F	01/04→12/06	BDX 23042		598073	2		257x20 (18,2)		186589	186931	
2.0Hdi, 2.0i		F	01/04→12/06	LUC 20261		598553	2(A)		285,2x28 (26)		● 197219	● 186984	
Jumpy (2007>)													
1.6Hdi 1.0T		F	01/07→	LUC 24595		● 598899	1		280x28 (26)		● 197188		
1.6Hdi 1.2T, 2.0Hdi, 2.0i		F	01/07→	LUC 24595		● 598899	1		304x28 (26)		● 197133		
		R	01/07→	LUC 24578		● 601039	0		290x14 (12)		● 197099		
Nemo (2007>)													
1.4Hdi, 1.4i		F	12/07→	BOS 23705		598426	1		257x22 (20,5)		186590		
Relay (94>2001)													
1.9D, 1.9TD, 2.0i, 2.5D	10Q, 14Q	F	02/94→12/01	LUC 21797		598070	2(B)		280x18 (15,9)		● 197217		
	10Q, 14Q	F	02/94→12/01	LUC 21797		598429	1(A)		280x18 (15,9)		● 197217		
2.0Hdi, 2.5TD, 2.5TDi, 2.8Hdi	10Q, 14Q	F	02/94→12/01	LUC 21797		598070	2(B)		280x24 (21,9)		186418		
	10Q, 14Q	F	02/94→12/01	LUC 21797		598429	1(A)		280x24 (21,9)		186418		
2.0i, 2.5D, 2.5TD, 2.5TDi, 2.8Hdi	18Q	F	02/94→12/01	LUC 21799		598800	2(A)		300x24 (21,9)		● 197228		
	18Q	F	02/94→12/01	LUC 21799		598430	1(B)		300x24 (21,9)		● 197228		
Relay (2002>2006)													
2.0Hdi, 2.0i, 2.2Hdi, 2.8Hdi	11Q, 15Q	F	01/02→06/06	BBO 23918		598568	1		280x24 (21,9)		186418		
2.2Hdi, 2.8Hdi	18Q	F	01/02→06/06	BBO 23919		598569	1		300x24 (21,9)		● 197228		
	18Q	R	01/02→06/06	BBO 23921		598570	0		280x16 (14,2)		186708		
2.8Hdi	15Q	R	01/02→06/06						280x16				
Relay II (2006>)													
2.2Hdi, 3.0Hdi	330, 333	F	07/06→	BBO 24468		● 598891	1		280x24 (21,9)		● 197043		













															
CITROËN  (.../...)															
Relay II (2006>) (.../...)															
2.2HdI, 3.0HdI (...)	335	F	07/06→	BBO 24468		● 598891	1		280x28 (25,9)	● 197248					
3.0HdI	335, 1700Kg	F	07/06→						300x24 (21,9)	● 197131					
	335, 2000Kg	F	07/06→						300x32						
2.2HdI, 3.0HdI	330, 333, 335	R	07/06→	BOS 24465		● 598892	0		280x16 (14,2)	● 197023					
3.0HdI	335, 1700Kg	R	07/06→						280x16 (14,2)	● 197097					
	335, 2000Kg	R	07/06→						300x16 (14,2)	● 197105					
DACIA 															
1210 (85>2004)															
1.2, 1.6TD Turbo D		F	12/85→08/88						228x10 (9)	186226					
		F	09/88→09/04						238x11,9 (10,5)	186230					
1310 (85>2004)															
1.3		F	12/85→08/88						228x10 (9)	186226					
		F	09/88→09/04						238x11,9 (10,5)	186230					
1410 (85>2004)															
1.4		F	12/85→08/88						228x10 (9)	186226					
		F	09/88→09/04						238x11,9 (10,5)	186230					
Duster (84>99)															
1.4		F	04/84→08/88						228x10 (9)	186226					
1.4, 1.6D		F	09/88→01/99						238x11,9 (10,5)	186230					
Duster (2010>)															
1.5dCi 110, 1.5dCi 85, 1.6i	ABS(-) 4WD(-)	F	03/10→	LUC 23973		598641	0								
	ABS(+)	F	03/10→	ATE 24914		● 601045	0		280x24 (21,8)	● 197192					
Logan (2004>)															
1.4MPI, 1.5dCi, 1.6MPI 	ABS(-)	F	09/04→	LUC 20772		598002	2(B)		238x12 (10,5)	186803					
	ABS(+)	F	09/04→	LUC 20772		598002	2(B)		259x12 (10,6)	186802					
1.4MPI, 1.5dCi, 1.6MPI, 1.6MPI GPL 1.6i 		F	10/06→	LUC 20772		598002	2(B)		259x20,6 (17,7)	186208	186957				

															
DACIA  (.../...)															
Logan (2004>) (.../...)															
1.5dCi 65, 1.5dCi 70, 1.5dCi 85, 1.6MPI		F	10/06→	LUC 23973		598641	0		260x22 (19,8)	186764	●186980				
1.6MPI GPL, 1.6i, 1.6i 90 		F	10/06→11/08	ATE 24673		● 601017	0		260x22 (19,8)	186764					
SuperNova (2000>2003)															
1.4i		F	07/00→03/03						235x20 (19)	186727					
Sandero (2008>)															
1.0i		F	02/09→	LUC 20772		598002	2(B)		238x12 (10,5)	186803					
1.0i, 1.2i, 1.4MPI, 1.4MPI 75 GPL, 1.5dCi		F	06/08→	LUC 20772		598002	2(B)		259x12 (10,6)	186802					
1.5dCi 65															
1.2i, 1.4MPI, 1.4MPI 75 GPL, 1.5dCi		F	06/08→	LUC 20772		598002	2(B)		259x20,6 (17,7)	186208	186957				
1.5dCi 65, 1.6MPI 90															
Solenza (2003>2005)															
1.4i, 1.9D		F	04/03→03/05						235x20 (19)	186727					
DAEWOO 															
Korando KJ (99>)															
2.0i, 2.3TD, 2.3i, 2.9TD, 3.2i		F	02/99→						278x23,8 (22)	● 197195					
		R	02/99→	LUC 23242		598854	2		299x10,4 (8,5)	● 197122					
Musso (99>)															
2.3TD, 2.3i, 2.9D, 2.9TD, 3.2i		F	01/99→						278x23,8 (22)	● 197195					
		R	01/99→	LUC 23242		598854	2		299x10,4 (8,5)	● 197122					
DAEWOO 															
Aranos (95>)															
1.5i, 1.8i, 2.0i		F	02/95→	ATE 21201		598184	0		256x23,9 (21)	186189	186932				
Espero (93>99)															
1.5i, 1.8i, 2.0i		F	09/93→05/99	ATE 21201		598184	0		256x23,9 (21)	186189	186932				
Evanda (2002>2005)															
2.0i, 2.0i GPL		F	08/02→05/05	AKE 23235		598361	2		256x24						
		R	08/02→	LUC 23237		● 598902	0		257,6x12						



















































	
DAEWOO  (.../...)	
Kalos (2002>)	
1.2i, 1.4i, 1.4i GPL	F 09/02→ AKE 23974  598644 0
Lacetti (2003>2004)	
1.4i, 1.6i, 1.6i GPL, 1.8i, 1.8i GPL	F 10/03→12/04
	R 10/03→12/04 SUM 24071  598874 0
Lanos (97>)	
1.3i, 1.5i	F 09/97→ ATE 21353  598039 0
1.6i	F 09/97→ ATE 21201  598184 0
Leganza (97>2003)	
2.0i, 2.2i	F 09/97→01/03 AKE 23235  598361 2
	R 09/97→01/03 LUC 23237  ● 598902 0
Matiz (98>2005)	
0.8i, 1.0i	F 07/98→01/05 AKE 23241  598316 0
Nexia (95>)	
1.5	F 03/95→ ATE 21353  598039 0
	F 03/95→ ATE 21201  598184 0
Nubira (97>)	
1.6i, 1.6i GPL, 1.8i, 1.8i GPL, 2.0i	F 09/97→
	R 09/97→ LUC 23237  ● 598902 0
Rezzo (2000>)	
1.6i, 1.6i GPL, 1.8i, 2.0i 2.0i GPL	●  826908 F 04/00→
1.6i, 1.6i GPL, 2.0i, 2.0i GPL	●  826909 F AKE 23235  598361 2
1.6i, 1.6i GPL	F 02/02→
1.6i, 1.6i GPL, 1.8i, 2.0i, 2.0i GPL	F
Tacuma (2000>)	
1.6i, 1.8i, 2.0i	●  826908 F 06/00→
	●  826909 F AKE 23235  598361 2





























	
DAEWOO 	
Lublin (97>)	
2.4D, 2.4TD	F 04/97→ LUC 20916  598061 2
DAF 	
400 (86>96)	
2.0, 2.5D, 2.5TD	F 10/88→04/96
3.5	→  816133 F 10/88→ AP 20359  598129 4(B) 276x14,3  816134 F →04/96 275x24
DAIHATSU 	
Feroza (88>97)	
1.6, 1.6i	F 10/88→12/97 277x12,5
1.6i	F 05/92→12/97 277x18
Fourtrak (85>93)	
2.0, 2.8D	F 10/85→06/93 277x12,5
2.8TD	F 10/90→06/93 277x18
Rocky (84>93)	
2.0, 2.2, 2.8D	F 04/84→04/93 277x12,5
2.8TD	F 09/84→09/85 277x18
Rocky (93>)	
2.2, 2.8D, 2.8TD	F 05/93→ 277x18
Sportrak (89>97)	
1.6, 1.6i	F 07/90→12/97 277x12,5
DAIHATSU 	
Applause (89>)	
1.6, 1.6i	F 06/89→ 234x18
	R 06/89→09/97 SUM 20031  598624 0 236x10
Charade (93>2001)	
1.0, 1.3i	F 03/93→08/96 AKE 21952  598850 2 234x11
1.3i, 1.6i	ABS(+) F 03/93→08/96 AKE 21952  598850 2 234x18











































											
DAIHATSU  (.../...)											
Charade (93>2001) (.../...)											
1.3i	F	08/96→03/01	AKE 21952		598850	2		234x18			
1.3i, 1.5i, 1.6i	R	03/93→03/01									
Copen (2003>2006)											
0.7i Turbo	F	06/03→02/06	AKE 23507		598733	1		246x17			
Copen (2006>)											
1.3i	F	03/06→	AKE 23507		598733	1		246x17			
Cuore (90>94)											
0.8	F	08/90→08/94	SUM 21969		● 601024	0		211x16 (15)	● 197157		
Cuore (94>98)											
0.8	F	08/94→08/98	SUM 21969		● 601024	0		211x10			
Cuore (98>2003)											
1.0i	F	10/98→03/03	SUM 23494		598883	2		211x11 (10)	● 197108		
Cuore (2003>2005)											
1.0i	F	04/03→08/05	AKE 24229		598873	2		211x11 (10)	● 197108		
Cuore (2005>2007)											
1.0WT	F	09/05→08/07						234x16			
Cuore (2007>)											
1.0i	⊙ 13"	F	04/07→					234x16			
	⊙ 14"	F	04/07→					246x17			
Domino (90>94)											
0.8	F	06/90→08/94	SUM 21969		● 601024	0		211x16 (15)	● 197157		
Domino (94>98)											
0.8	F	08/94→09/98	SUM 21969		● 601024	0		211x10			
Domino (98>2000)											
1.0i	F	10/98→06/00	SUM 23494		598883	2		211x11 (10)	● 197108		
Gran Move (96>)											
1.5i	F	08/96→06/98	AKE 21952		598850	2		234x18			
1.6i	F	06/98→	AKE 21952		598850	2		250x18			
1.5i, 1.6i	ABS(+)	R	08/96→					231x9			























































																		
DAIHATSU  (.../...)																		
Materia (2006>)																		
1.3WT, 1.5WT		F	09/06→															
Mira (92>94)																		
0.8		F	08/92→08/94	SUM 21969		● 601024	0											
Mira (94>98)																		
0.8		F	08/94→08/98	SUM 21969		● 601024	0											
Move (97>99)																		
0.8i		F	01/97→03/99															
Move (99>2002)																		
1.0i		F	04/99→09/02	AKE 23497		598856	0											
Sirion (98>2005)																		
1.0i, 1.3i		F	04/98→01/05	AKE 23497		598856	0											
Sirion II (2005>)																		
1.0i, 1.3i, 1.5i WT	ABS(-)	F	02/05→	LUC 24283		● 598999	1											
1.0i, 1.3i		F	02/05→	AKE 23507		598733	1											
		F	02/05→															
1.5i WT		F	06/07→	LUC 24283		● 598999	1											
Terios (97>2006)																		
1.3i		F	03/97→04/06															
Terios II (2006>)																		
1.3WT, 1.5WT		F	05/06→															
		F	05/06→															
Trevis (2006>)																		
1.0i		F	09/06→	AKE 24229		598873	2											
Valera (94>)																		
1.5i		F	08/94→	AKE 21952		598850	2											
	ABS(+)	R	08/94→															
YRV (2000>)																		
1.0i, 1.3i		F	08/00→08/03	AKE 23497		598856	0											

DAIHATSU (.../...)									
YRV (2000>) (.../...)									
1.0i, 1.3i (...)	F	09/03→						234x16	
1.3i Turbo	F	07/02→	AKE 23507	598733	1			246x17	
DODGE									
Caliber (2006>)									
1.8VWT, 2.0CRD, 2.0WT	F	09/06→						294x26	
	R	09/06→	AKE 24014	598852	2			262x10	
FIAT									
Sedici (2006>2009)									
1.6i, 1.9JTD Multijet	F	04/06→06/09	LUC 24391	598804	1			280x22 (20) ● 197135	
Sedici (2009>)									
1.6i, 2.0MJT	F	07/09→	LUC 24391	598804	1			280x22 (20) ● 197135	
	R	07/09→							
FIAT									
124 (66>77)									
1.2, 1.4, 1.6, 1.8	F	03/66→1977	BDX 20647	598090	2			227,5x10,8 (9) 186151	
	R	03/66→1977	BDX 20647	598088	0			227,5x10,8 (9) 186151	
125 (67>73)									
1.6	F	08/67→1973	BDX 20647	598090	2			227,5x10,8 (9) 186151	
	R	08/67→1973	BDX 20647	598088	0			227,5x10,8 (9) 186151	
127/128 (66>86)									
0.9, 1.05, 1.1, 1.3	F	03/69→12/86	BDX 20647	598090	2			227,5x10,8 (9) 186151	
1.05	F	1986→12/86	ATE 20375	* 598371	0			227,5x10,8 (9) 186151	
1.3D	F	02/81→02/85							
131/132 (72>85)									
1.3, 1.3TC, 1.4, 1.4TC, 1.6, 1.6TC, 1.8, 2	F	10/72→1985	BDX 20647	598090	2			227,5x10,8 (9) 186151	
2.5D, 2D									
1.6, 2, 2.5D, 2i	F	04/77→08/81	BDX 20647	598090	2			251,5x11 (9,5) * 186501	

																										
FIAT  (.../...)																										
131/132 (72>85) (.../...)																										
1.6, 1.8 			R	10/72→03/77	BDX 20647 	598088	0		227,5x10,8 (9)	186151																
500 Nuova (2007>)																										
1.2MPi			F	07/07→	BOS 21436 	598987	1		240,5x10,9 (9,2)	186155																
1.3MJTD			F	07/07→	BOS 24764 	601015	1		240,5x20 (18,2)	186744																
1.4MPi			F	07/07→	BOS 23705 	598426	1		257x22 (20,5)	186590																
1.4TB			F	08/08→					284,5x22 (20,2)	186266																
1.4MPi, 1.4TB			R	07/07→	LUC 23661 	598425	0		240,5x10,9 (9,2)	186155																
900 (76>87)																										
0.9			F	1978→1987	BDX 20775 	598091	2		227,5x10,8 (9)	186151	186904															
Albea (2002>)																										
1.2i, 1.3JTD, 1.6i			F	04/02→	BOS 23705 	598913	0		257,4x20 (18,2)	186153																
Argenta (132) (81>86)																										
1.6, 1.8, 2, 2.5D, 2.5TD, 2i			F	04/81→1986	LUC 20838 	598219	4		257x12 (10,8) *	186152																
2, 2i			R	04/81→1986	BDX 20647 	598088	0		227,5x10,8 (9)	186151																
Barchetta (95>2003)																										
1.8i			F	05/95→03/97	LUC 20838 	598219	4		257,4x20 (18,2)	186153																
			F	04/97→06/03	ATE 21927 	598041	2(A+B)		257,4x20 (18,2)	186153																
			R	05/95→06/03	LUC 21103 	598142	0		240,5x10,9 (9,2)	186155																
			R	06/97→06/03	LUC 23177 	598331	0		240,5x10,9 (9,2)	186155																
Barchetta (2003>)																										
1.8i			F	07/03→	ATE 21927 	598041	2(A+B)		257,4x20 (18,2)	186153																
			R	07/03→	LUC 23177 	598331	0		240,5x10,9 (9,2)	186155																
Brava (182) (95>2002)																										
1.2i, 1.4i, 1.6i, 1.9D, 1.9TD			F	06/95→03/02	ATE 21930 	598040	1		257,5x11,9(10,2)	186154																
1.6i			F	10/98→03/02	ATE 21927 	598041	2(A+B)		257,5x11,9(10,2)	186154																
1.6i, 1.8i, 1.9JTD, 1.9TD			F	06/95→03/02	ATE 21927 	598041	2(A+B)		257,4x20 (18,2)	186153																
1.6i, 1.9TD			F	10/98→03/02	ATE 21930 	598040	1		257,4x20 (18,2)	186153																



























































																
FIAT (…/…)																
Bravo (182) (95>2002)																
1.2i, 1.4i, 1.6i, 1.9D, 1.9TD	F	06/95→03/02	ATE 21930		598040	1		257,5x11,9(10,2)	186154							
1.6i, 1.8i, 1.9JTD, 1.9TD	F	06/95→03/02	ATE 21927		598041	2(A+B)		257,4x20 (18,2)	186153							
2.0i	F	06/95→05/99	ATE 21636		598308	2		284,5x22 (20,2)	186266							
	 4993952	F	06/99→	ATE 21636		598065	2		284,5x22 (20,2)	186266						
	 4993953	F	→03/02	ATE 21637		● 598990	1		284,5x22 (20,2)	186266						
	R	06/95→04/97	LUC 21103		598142	0		240,5x10,9 (9,2)	186155							
	R	04/97→03/02	LUC 23177		598331	0		240,5x10,9 (9,2)	186155							
Bravo II (198) (2007>)																
1.4MPI	F	02/07→	BOS 23705		598426	1		257x22 (20,5)	186590							
1.4Tjet	88 KW	F	07/07→	BOS 23708		598427	1(A)		281x26 (24,2)	186745						
1.4Tjet, 1.9MJTD	110 KW	F	02/07→	BOS 23711		598428	1		281x26 (24,2)	186745						
1.6MJTD, 1.9MJTD		F	02/07→	BOS 23708		598427	1(A)		284,5x22 (20,2)	186266						
1.4MPI, 1.4Tjet, 1.6MJTD, 1.9MJTD		R	02/07→	BOS 23714		598633	0		251,5x10 (9)	186146						
Cinquecento (170) (92>98)																
0.7, 0.7i, 0.9, 0.9i, 1.1i	 1066590	F	01/92→	BOS 21365		● 601021	0		240,5x10,9 (9,2)	186155						
	 1066591	F	→02/98	BDX 21365		598012	0		240,5x10,9 (9,2)	186155						
Coupe (PC/PX) (93>2000)																
1.8i	F	11/93→09/96	ATE 21636		598065	2		284x22 (20,2)	186297							
	F	07/96→03/99	ATE 21636		598308	2		284x22 (20,2)	186297							
	F	04/99→09/00	ATE 21636		598065	2		284x22 (20,2)	186297							
2.0i	F	11/93→06/95	LUC 21147		● 598985	2		284x22 (20,2)	186297							
	F	07/95→09/96	ATE 21636		598065	2		284x22 (20,2)	186297							
	F	07/96→03/99	ATE 21636		598308	2		284x22 (20,2)	186297							
	F	04/99→09/00	ATE 21636		598065	2		284x22 (20,2)	186297							
2.0i Turbo	F	07/95→09/96	LUC 21147		● 598985	2		284,5x22 (20,2)	186266							































































																		
FIAT  (.../...)																		
Coupe (93>2000) (.../...)																		
2.0i Turbo (...)	F	07/95→09/96	ATE 21636		598065	2		284,5x22 (20,2)	186266									
	F	07/96→09/98	BBO 21381		● 598988	2		305x28										
	F	10/98→09/00	BBO 21381		● 598988	2		305x28										
1.8i	R	11/93→09/00	LUC 21103		598142	0		240,5x10,9 (9,2)	186155									
2.0i, 2.0i Turbo	R	11/93→06/98	LUC 21103		598142	0		240,5x10,9 (9,2)	186155									
	R	07/98→09/00	LUC 23177		598331	0		240,5x10,9 (9,2)	186155									
Croma (154) (85>90)																		
1.6, 2.0CHT, 2.5D, 2ie	ABS(+)	F	10/85→06/88	LUC 20838		598134	2		257,5x12 (10,8)	* 186150								
1.6, 2.0TDiD		F	07/88→12/90	LUC 21185		598135	2(B)		257,5x14 (12,8)	* 186147								
2.0ie Turbo		F	05/86→12/90	LUC 21185		598135	2(B)		257,5x20 (18,2)	186149								
2.0ie Turbo, 2.5TD, 2ie	ABS(+)	F	10/85→06/88	LUC 20838		598134	2		257,5x20 (18,2)	186149								
2.0TDiD, 2.0ie Turbo	ABS(+)	F	05/86→12/90	LUC 21185		598135	2(B)		284,5x22 (20,2)	186266								
1.6, 2.0CHT, 2.0ie Turbo, 2.5D, 2.5TD, 2ie		R	10/85→12/90	BDX 20775		598141	0		251,5x10 (9)	186146								
1.6, 2.0CHT, 2.0TDiD, 2.0ie Turbo, 2.5D, 2.5TD, 2ie		R	10/85→12/90	LUC 20668		598125	0		251,5x10 (9)	186146								
Croma (154) (91>96)																		
2.0CHT, 2.0TDiD, 2.0ie		F	01/91→12/92	LUC 21185		598135	2(B)		257,5x14 (12,8)	* 186147								
2.0CHT, 2.0TDiD, 2.0ie 2.0ie Turbo, 2.5TD	ABS(+)	F	01/91→12/96	LUC 21185		598135	2(B)		257,5x22 (20,2)	* 186148								
2.0ie		F	01/91→12/92	LUC 21147		● 598985	2		284,5x22 (20,2)	186265								
2.0ie Turbo, 2.5 V6		F	11/92→08/96	LUC 21147		● 598985	2		284,5x22 (20,2)	186266								
2.0CHT, 2.0TDiD, 2.0ie, 2.5TD		R	01/91→08/96	BDX 20775		598141	0		251,5x10 (9)	186146								
2.0TDiD, 2.0ie, 2.5 V6, 2.5TD	ABS(+)	R	01/91→12/96	LUC 20668		598125	0		251,5x10 (9)	186146								
2.0ie, 2.0ie Turbo		R	01/91→08/96	LUC 20668		598125	0		251,5x10 (9)	186290								
		R	01/91→12/92	BDX 20775		598141	0		251,5x10 (9)	186290								











































													
			R P F		WVA			Valeo		Valeo		Valeo	
FIAT  (.../...)													
Croma II (2005>2007)													
1.9JTD, 1.9JTD Multijet	 2060168	F	06/05→	LUC 20261		598793	2(B)		285x24,9 (22,2)	186881			
	 2060169	F	→10/07	ATE 23402		598678	0		305x28				
1.8i, 2.2i		F	06/05→10/07	ATE 23402		598678	0		285x24,9 (22,2)	186881			
2.4JTD Multijet		F	06/05→10/07	LUC 20261		598793	2(B)		305x28				
1.9JTD	84/88 KW	R	06/05→10/07	LUC 24348		598727	0		278x12				
1.9JTD	 2060168100/110 KW	R	06/05→	LUC 24348		598727	0		292x19,9 (18)	186882			
1.9JTD Multijet													
	 2060169100/110 KW	R	→10/07	LUC 24348		598727	0		278x11,9 (10)	186854			
1.8i, 2.2i		R	06/05→10/07	LUC 24348		598727	0		278x12				
2.4JTD Multijet		R	06/05→10/07	LUC 24348		598727	0		292x19,9 (18)	186882			
Croma II (2007>)													
1.8MPI, 1.9JTD, 2.2MPI		F	10/07→	ATE 23402		598678	0		285x24,9 (22,2)	186881			
2.4JTD		F	10/07→	LUC 20261		598793	2(B)		305x28				
1.9JTD	88 KW	R	10/07→	LUC 24348		598727	0		278x12				
	110 KW	R	10/07→	LUC 24348		598727	0		278x11,9 (10)	186854			
1.8MPI, 2.2MPI		R	10/07→	LUC 24348		598727	0		278x12				
2.4JTD		R	10/07→	LUC 24348		598727	0		292x19,9 (18)	186882			
Idea (2003>2007)													
1.2i, 1.3JTD Multijet 51 KW, 1.4i		F	10/03→06/07	BOS 23705		598913	0		257x22 (20,5)	186590			
1.3JTD Multijet 66KW, 1.9JTD		F	10/03→06/07	BOS 23708		598698	0		284,5x22 (20,2)	186266			
Idea (2007>)													
1.2i, 1.3MJTD 51 KW, 1.4i		F	06/07→	BOS 23705		598913	0		257x22 (20,5)	186590			
1.3MJTD 66KW, 1.9JTD		F	06/07→	BOS 23708		598427	1(A)		284,5x22 (20,2)	186266			
Linea (2007>)													
1.3MJTD, 1.4i	 3051322	F	07/07→	BOS 23705		598426	1		257x22 (20,5)	186590			
	 3051322	F		BOS 23705		598670	2		257x22 (20,5)	186590			

													
FIAT  (.../...)													
Linea (2007>) (.../...)													
1.4TJET, 1.6MJTD		F	07/07→								284,5x22 (20,2)	186266	
		R	07/07→	LUC 23661		598407	0				251,5x10 (9)	186146	
Marea (185) (96>2002)													
1.2i, 1.4i, 1.6i, 1.9TD		F	07/96→09/02	ATE 21930		598040	1				257,5x11,9(10,2)	186154	
1.6i 		F	02/99→09/02	ATE 21927		598041	2(A+B)				257,5x11,9(10,2)	186154	
1.2i, 1.6i, 1.6i Bipower, 1.8i, 1.9JTD, 1.9TD		F	07/96→09/02	ATE 21927		598041	2(A+B)				257,4x20 (18,2)	186153	
1.4i 		F	07/96→01/99	ATE 21930		598040	1				257,4x20 (18,2)	186153	
2.0i, 2.4JTD, 2.4TD				 0249007	F	07/96→01/99	ATE 21636		598308	2		284,5x22 (20,2)	186266
2.0i, 2.4JTD				 0249008	F	02/99→09/02	ATE 21636		598065	2		284,5x22 (20,2)	186266
2.0i		F	02/99→09/02	ATE 21637		598990	1				284,5x22 (20,2)	186266	
2.0i, 2.4JTD, 2.4TD		R	05/97→09/02	LUC 23177		598331	0				240,5x10,9 (9,2)	186155	
2.0i, 2.4TD		R	07/96→04/97	LUC 21103		598142	0				240,5x10,9 (9,2)	186155	
Marengo (159) (89>95)													
1.9D		F	11/89→01/95	LUC 20838		598219	4				257,5x11,9(10,2)	186154	
1.9TD, 1.9Tds		F	11/89→01/95	LUC 20838		598219	4				257,4x20 (18,2)	186153	
1.9D, 1.9TD, 1.9Tds				ABS(+)	R	11/89→01/95	LUC 21103		598142	0		240,5x10,9 (9,2)	186155
Marengo (185) (95>)													
1.9TD		F	01/95→	ATE 21930		598040	1				257,5x11,9(10,2)	186154	
1.9JTD, 1.9TD		F	05/98→	ATE 21927		598041	2(A+B)				257,4x20 (18,2)	186153	
Multipla (186) (98>2003)													
1.6i, 1.6i Bipower, 1.6i Blupower, 1.9JTD		F	11/98→06/04	ATE 21636		598065	2				284x22 (20,2)	186297	
				ESP(+)	R	11/98→06/04	BOS 23714		598633	0		251,5x10 (9)	186146
Multipla (2004>)													
1.6i, 1.6i Bi Power, 1.6i Bi Power GPL 1.9JTD		F	07/04→	ATE 21636		598065	2				284x22 (20,2)	186297	
				ESP(+)	R	07/04→	BOS 23714		598633	0		251,5x10 (9)	186146

			RPF		WVA		Valeo		Valeo		Valeo	
FIAT (.../...)												
Palio (96>2001)												
1.1, 1.2i, 1.4i, 1.6i 78 KW, 1.7D	F	09/98→02/01	ATE 21193		598423	2(B)		240x20 (18,2)	186571			
1.6i 74 KW	F	06/99→11/99	ATE 23776		601019	2		240x20 (18,2)	186571			
	F	12/99→02/01	ATE 21193		598423	2(B)		240x20 (18,2)	186571			
Palio (2001>)												
1.2i Eng 178D	F	03/01→						240x20 (18,2)	186571			
1.2i Eng 178C 188A4 188A5, 1.6i	F	03/01→	ATE 21193		598423	2(B)		240x20 (18,2)	186571			
1.6i	F	03/01→	ATE 20907		598424	2		257,4x20 (18,2)	186153			
Palio Week End (97>2001)												
1.2i 44 KW	F	09/97→02/01	ATE 20907		598422	0		257,4x20 (18,2)	186153			
1.2i 55 KW	F	09/97→12/98						240x20 (18,2)	186571			
	F	12/98→02/01						257,4x20 (18,2)	186153			
1.6i 1581cc Eng 178B3 74 KW	F	09/97→02/01	ATE 20907		598424	2		257,4x20 (18,2)	186153			
1.6i 1596cc Eng 182B6 76 KW	F	09/97→11/99	ATE 20907		598424	2		257,4x20 (18,2)	186153			
	F	11/99→02/01	ATE 20907		598422	0		257,4x20 (18,2)	186153			
1.6i 1580cc Eng 178D2 78 KW	F	06/99→11/99	ATE 20907		598424	2		257,4x20 (18,2)	186153			
	F	11/99→02/01	ATE 20907		598422	0		257,4x20 (18,2)	186153			
1.7TD 47 KW	F	09/97→02/01	ATE 20907		598422	0		257,4x20 (18,2)	186153			
1.7TD 52 KW	F	09/97→02/01						240x20 (18,2)	186571			
1.9D	F	09/97→02/01	ATE 20907		598422	0		257,4x20 (18,2)	186153			
Palio Week End (2001>2002)												
1.2i, 1.6i, 1.9JTD	F	03/01→09/02	ATE 20907		598424	2		257,4x20 (18,2)	186153			
1.6i	F	03/01→09/02						240x20 (18,2)	186571			
1.7TD	F	08/01→12/01	ATE 20907		598422	0		257,4x20 (18,2)	186153			
Panda (80>86)												
0.6, 0.8, 0.9		06166304	F	07/80→	BDX 20647		598090	2		227,5x10,8 (9)	186151	
		06166305	F	→02/86	BDX 20775		598091	2		227,5x10,8 (9)	186151	186904

																	
FIAT  (.../...)																	
Panda (80>86) (.../...)																	
1.0	F	06/83→02/86	BDX 20775		598091	2		227,5x10,8 (9)	186151	186904							
Panda (86>2003)																	
0.7, 0.9, 0.9ie, 1, 1.1ie, 1.3D, 1ie 	F	03/86→08/03	BDX 20775		598091	2		227,5x10,8 (9)	186151	186904							
1 Selecta, 1.1ie Selecta 	F	1990→08/03	LUC 20838		598219	4		240,5x12 (10,8)	186157								
Panda (2003>)																	
1.1i	F	09/03→	BDX 21365		598012	0		240,5x10,9 (9,2)	186155								
1.2i, 1.2i GNW, 1.3JTD Multijet	F	09/03→	BOS 24072		598696	0		240,5x20 (18,2)	186744								
1.4		 971810	F	09/03→	BOS 23705		● 598913	0		257x22 (20,5)	186590						
		 971811	F							257x22 (20,5)	186590						
1.3JTD Multijet, 1.4	R	09/03→	LUC 23661		598425	0		240,5x10,9 (9,2)	186155								
Punto (176) (93>99)																	
1.1i	F	07/93→04/97	LUC 20838		598219	4		240,5x10,9 (9,2)	186155								
	F	07/93→04/97	BDX 21365		598011	1		240,5x10,9 (9,2)	186155								
	F	07/96→09/99	BDX 21365		598012	0		240,5x10,9 (9,2)	186155								
	F	07/93→06/96	LUC 20838		598219	4		257,5x11,9(10,2)	186154								
	F	07/93→06/96	BDX 21365		598011	1		257,5x11,9(10,2)	186154								
1.2i	F	07/93→09/99	LUC 20838		598219	4		240,5x10,9 (9,2)	186155								
	F	07/93→04/97	BDX 21365		598011	1		240,5x10,9 (9,2)	186155								
	F	07/96→09/99	BDX 21365		598012	0		240,5x10,9 (9,2)	186155								
	F	07/93→09/99	LUC 20838		598219	4		257,5x11,9(10,2)	186154								
	F	07/93→04/97	BDX 21365		598011	1		257,5x11,9(10,2)	186154								
	F	07/96→09/99	BDX 21365		598012	0		257,5x11,9(10,2)	186154								
1.6i 	F	11/93→04/97	LUC 20838		598219	4		257,5x11,9(10,2)	186154								
1.6i 	F	03/94→06/96	LUC 20838		598219	4		240,5x10,9 (9,2)	186155								
1.7D	F	10/94→04/97	BDX 21365		598012	0		240,5x10,9 (9,2)	186155								









															
FIAT  (.../...)															
Punto (176) (93>99) (.../...)															
1.7TD	F	06/95→09/99	BDX 21365		598012	0		240,5x10,9 (9,2)	186155						
	F	10/94→09/99	LUC 20838		598219	4		240,5x10,9 (9,2)	186155						
	F	06/95→09/99	BDX 21365		598012	0		257,5x11,9(10,2)	186154						
	F	07/93→09/99	LUC 20838		598219	4		257,5x11,9(10,2)	186154						
1.4i Turbo	F	07/93→05/96	LUC 20838		598219	4		257,4x20 (18,2)	186153						
	F	06/96→09/99	ATE 21927		598041	2(A+B)		257,4x20 (18,2)	186153						
1.4i Turbo 100 KW	R	07/93→07/95	LUC 21103		598142	0		240,5x10,9 (9,2)	186155						
	R	07/95→04/97						240,5x10,9 (9,2)	186155						
1.4i Turbo 96 KW	R	06/96→09/99	LUC 21103		598142	0		240,5x10,9 (9,2)	186155						
Punto II (99>2003)															
1.2i 44 KW 	F	07/99→06/03	BDX 21365		598012	0		240,5x10,9 (9,2)	186155						
1.2i 16V 59 KW 	F	07/99→06/03	ATE 21930		598605	0		257,5x11,9(10,2)	186154						
1.2i CVT, 1.9D 	F	07/99→06/03	ATE 21930		598607	0		257,5x11,9(10,2)	186154						
1.8i 	F	07/99→06/03	ATE 20907		598424	2		257x22 (20,5)	186590						
1.9D 	F	07/99→06/03	ATE 21927		● 601003	0		257,5x11,9(10,2)	186154						
1.9JTD 	F	07/99→06/03	ATE 21927		● 601003	0		257,4x20 (18,2)	186153						
1.8i 	R	07/99→06/03	LUC 23661		598425	0		240,5x10,9 (9,2)	186155						
Punto II (2003>)															
1.2i, 1.2i Bipower 38/44 KW 	F	07/03→	BDX 21365		598012	0		240,5x10,9 (9,2)	186155						
1.2i 16V 59 KW 	F	07/03→	ATE 21930		598605	0		257,5x11,9(10,2)	186154						
1.3JTD, 1.4i, 1.9JTD (63 KW) 	F	07/03→	ATE 21927		● 601003	0		257,4x20 (18,2)	186153						
1.8i, 1.9JTD (74 KW) 	F	07/03→	ATE 21637		● 598990	1		284x22 (20,2)	186297						
	R	07/03→	LUC 23661		598425	0		240,5x10,9 (9,2)	186155						
Grande Punto (2005>)															
1.2i 	F	10/05→	BOS 23705		598426	1		257x22 (20)	● 197044						















																		
FIAT  (.../...)																		
Grande Punto (2005>) (.../...)																		
1.2i (...)	 1182184	 2030285	F		BOS 23705		598426	1		257x12 (10)	● 197028							
		 2030285	F							257x12 (10)	● 197028							
1.3MJTD 55KW, 1.4 55/57/70KW			F	10/05→	BOS 23705		598426	1		257x22 (20)	● 197044							
1.3MJTD 66KW, 1.4 88KW, 1.9JTD			F	10/05→	BOS 23349		598721	1		284x22 (20)	● 197045							
1.4 70/88KW, 1.9JTD			R	10/05→	BOS 24349		598722	0		264x10 (8)	● 197008							
Punto Evo (2009>)																		
1.2i 65, 1.3MJT 75, 1.4i 105, 1.4i 77 1.4i Bipower, 1.4i GPL			F	10/09→						257x22 (20)	● 197044							
1.3MJT 90, 1.3MJT 95, 1.4TB 135, 1.6TD 120			F	10/09→						284x22 (20)	● 197045							
1.4TB 135, 1.4i 105, 1.4i Bipower, 1.6TD 120			R	10/09→						264x10 (8)	● 197008							
Qubo (2008>)																		
1.3MJTD, 1.4i			F	05/08→	BOS 23705		598426	1		257x22 (20,5)	● 186590							
Regata (138) (83>90)																		
1.1, 1.3, 1.3 GPL, 1.5, 1.5ie, 1.6, 1.6 GPL 1.7D			F	09/83→1990	BDX 20775		598091	2		227,5x10,8 (9)	● 186151	● 186904						
1.3, 1.5, 1.6, 1.7D, 1.9D, 1.9TD			F	09/83→1990	LUC 20838		598219	4		257x12 (10,8)	* 186152							
1.6			F	01/87→07/89	LUC 20838		598219	4		227,5x10,8 (9)	● 186151							
Ritmo (138) (78>82)																		
1.0, 1.1, 1.3, 1.5, 1.7D			F	05/78→10/82	BDX 20647		598090	2		227,5x10,8 (9)	● 186151							
1.6			F	03/82→10/82	BDX 20647		598090	2		251,5x11 (9,5)	* 186501							
2.0			F	10/81→10/82	BDX 20347		598085	2		243x20								
Ritmo (138) (82>88)																		
1.0, 1.1, 1.3, 1.5, 1.6, 1.7D 			F	11/82→1988	BDX 20775		598091	2		227,5x10,8 (9)	● 186151	● 186904						
1.6, 1.9TD Turbo			F	11/82→1988	LUC 20838		598219	4		257x12 (10,8)	* 186152							
2.0			F	11/82→1988						243x20								
Seicento (187) (98>2005)																		
0.9i, 1.1i			F	09/00→08/05	BDX 21365		598012	0		240,5x10,9 (9,2)	● 186155							





































FIAT (.../...)									
Seicento (187) (98>2005) (.../...)									
CVT Elettra	F	09/98→08/05	LUC 20838	598219	4		240,5x10,9 (9,2)	186155	
Siena (178) (97>2001)									
1.2i, 1.7D, 1.7TD	F	09/98→12/01	ATE 21193	598423	2(B)		240x20 (18,2)	186571	
1.4i	F	11/97→03/98							
	F	03/98→12/01	ATE 21193	598423	2(B)				
		0582135	F	11/97→			240,5x12 (10,8)	186157	
		0582135	F	→12/01			240x20 (18,2)	186571	
1.6i (eng. 178B3)	F	11/97→03/98					240x20 (18,2)	186571	
	F	03/98→12/01	ATE 23776	601019	2		240x20 (18,2)	186571	
1.6i (eng. 178C7 178D2)	F	09/98→12/01	ATE 21193	598423	2(B)		240x20 (18,2)	186571	
Siena (2002>)									
1.2i (eng. 178C4 178D7)	F	01/02→					240x20 (18,2)	186571	
1.5i	F	01/02→	ATE 20907	598424	2		257,4x20 (18,2)	186153	
1.6i, 1.9DS	F	01/02→					240x20 (18,2)	186571	
Spider (124) (82>85)									
2.0	F	05/82→09/85	BDX 20647	598090	2		227,5x10,8 (9)	186151	
	R	05/82→09/85	BDX 20647	598088	0		227,5x10,8 (9)	186151	
Stilo (2001>2003)									
1.2i, 1.6i	F	09/01→12/03	BOS 23705	598426	1		257x22 (20,5)	186590	
1.6i	F	01/03→12/03	BOS 23708	598427	1(A)		284,5x22 (20,2)	186266	
1.8i, 1.9JTD	F	09/01→12/03	BOS 23708	598427	1(A)		284,5x22 (20,2)	186266	
2.4i	F	09/01→12/03	BOS 23711	598428	1		281x26 (24,2)	186745	
1.2i, 1.6i, 1.8i, 1.9JTD, 2.4i	R	09/01→12/03	BOS 23714	598633	0		251,5x10 (9)	186146	
	R	09/01→12/03	BOS 23714	598633	0		251x10		
Stilo (2004>)									
1.4i, 1.6i	F	01/04→	BOS 23705	598426	1		257x22 (20,5)	186590	







































															
FIAT  (.../...)															
Stilo (2004>) (.../...)															
1.4i, 1.6i 	F	01/04→	BOS 23708 	598427	1 (A)		284,5x22 (20,2)	186266							
1.8, 1.8i 	F	01/04→	BOS 23708 	598427	1 (A)		284,5x22 (20,2)	186266							
1.9JTD (59...88KW) 	F	01/04→	BOS 23708 	598427	1 (A)		284,5x22 (20,2)	186266							
1.9JTD, 1.9JTD Multijet (93...110KW) 	F	01/04→	BOS 23711 	598428	1		281x26 (24,2)	186745							
2.4i 	F	01/04→	BOS 23711 	598428	1		281x26 (24,2)	186745							
1.4i, 1.6i, 1.8, 1.8i, 1.9JTD 1.9JTD Multijet, 2.4i 	R	01/04→	BOS 23714 	598633	0		251,5x10 (9)	186146							
Strada (85>88)															
1.1, 1.3, 1.5	F	04/85→1988	BDX 20775 	598091	2		227,5x10,8 (9)	186151	186904						
2.0	F	04/85→1988					243x20								
Tempra (160) (89>93)															
1.4, 1.4ie, 1.6, 1.6ie 	ABS(-)	F	11/89→02/93	LUC 21105 	598095	1		240,5x10,9 (9,2)	186155	186942					
1.4, 1.4ie, 1.6, 1.6ie, 1.8ie, 1.9D 1.9TDs 	F	11/89→02/93	LUC 20838 	598219	4		257,5x11,9(10,2)	186154							
1.8ie, 1.9TDs, 2.0ie 	F	11/89→02/93	LUC 20838 	598219	4		257,4x20 (18,2)	186153							
1.4, 1.4ie, 1.6, 1.6ie, 1.8ie 1.9D, 1.9TDs, 2.0ie 	ABS(+)	R	11/89→02/93	LUC 21103 	598142	0		240,5x10,9 (9,2)	186155						
2.0ie 	ABS(-)	R	11/89→02/93	BDX 20775 	598141	0		240,5x10,9 (9,2)	186155						
Tempra (160) (93>96)															
1.4ie, 1.6, 1.6ie, 1.9D 	ABS(-)	F	03/93→1996	LUC 20838 	598219	4		240,5x10,9 (9,2)	186155						
	ABS(+)	F	03/93→1996	LUC 20838 	598219	4		257,5x11,9(10,2)	186154						
1.4ie, 1.6, 1.6ie, 1.9D 	F	03/93→1996	LUC 20838 	598219	4		257,5x11,9(10,2)	186154							
1.8ie, 1.9TD 	F	03/93→1996	LUC 20838 	598219	4		257,5x11,9(10,2)	186154							
1.8ie, 1.9TD 	F	03/93→1996	LUC 20838 	598219	4		257,4x20 (18,2)	186153							
2.0ie 	F	03/93→1996	LUC 20838 	598219	4		257,4x20 (18,2)	186153							
1.4ie, 1.6, 1.6ie, 1.8ie, 1.9D, 1.9TD 	R	03/93→1996	LUC 21103 	598142	0		240,5x10,9 (9,2)	186155							
2.0ie 			 6073158,7490101	R	03/93→	BDX 20775 	598141	0		240,5x10,9 (9,2)	186155				

			R P F		WVA		Valeo		Valeo		Valeo	
FIAT (.../...)												
Tempra (160) (93>96) (.../...)												
2.0ie    6073159,7490102 •  6073158,7490101	R	-1996	LUC 21103		598142	0	 240,5x10,9 (9,2)	186155				
Tipo (160) (88>93)												
1.1, 1.4, 1.4ie, 1.6, 1.6ie, 1.7D 1.9D, 1.9TDs	ABS(-)	F	01/88→02/93	LUC 21105 	598095	1	 240,5x10,9 (9,2)	186155	186942			
	ABS(+)	F	01/88→02/93	LUC 20838 	598219	4	 257,5x11,9(10,2)	186154				
1.8ie (79...80KW) Eng 159A4		F	04/89→02/93	LUC 20838 	598219	4	 257,5x11,9(10,2)	186154				
1.8ie (102KW) Eng 160A5		F	11/89→02/93	LUC 20838 	598219	4	 257,4x20 (18,2)	186153				
2.0ie (80...85KW) Eng 159A4		F	06/90→02/93	LUC 20838 	598219	4	 257,4x20 (18,2)	186153				
2.0ie (109KW) Eng 160A8		F	03/91→02/93	LUC 20838 	598219	4	 284x22 (20,2)	186297				
1.4, 1.4ie, 1.6, 1.6ie, 1.7D, 1.8ie, 1.9D 1.9TDs, 2.0ie		R	01/88→02/93	LUC 21103 	598142	0	 240,5x10,9 (9,2)	186155				
Tipo (160) (93>95)												
1.4, 1.4ie, 1.6, 1.6ie, 1.7D, 1.9D	ABS(-)	F	03/93→10/95	LUC 20838 	598219	4	 240,5x10,9 (9,2)	186155				
1.4, 1.4ie, 1.6, 1.6ie, 1.7D 1.8ie, 1.9D, 1.9TD	ABS(+)	F	03/93→10/95	LUC 20838 	598219	4	 257,5x11,9(10,2)	186154				
2.0ie 85KW		F	03/93→10/95	LUC 20838 	598219	4	 257,4x20 (18,2)	186153				
2.0ie 103...104KW		F	03/93→10/95	LUC 21147 	598985	2	 284x22 (20,2)	186297				
1.4, 1.4ie, 1.6, 1.6ie, 1.7D 1.8ie, 1.9D, 1.9TD, 2.0ie	ABS(+)	R	03/93→10/95	LUC 21103 	598142	0	 240,5x10,9 (9,2)	186155				
Ulysse (U6) (94>98)												
1.8ie		F	03/96→09/98	BDX 23042 	598073	2	 257x20 (18,2)	186589	186931			
1.9TD, 2.0ie, 2.0ie Turbo, 2.1TD		F	06/94→09/98	LUC 21801 	598064	4	 281x26 (24,2)	186420				
1.8ie, 1.9TD, 2.0ie, 2.0ie Turbo 2.1TD	ABS(+)	R	06/94→09/98	ATE 21275 	598502	0	 295x10 (8)	186421				
Ulysse (U6) (98>2002)												
1.8ie		F	10/98→08/02	BDX 23042 	598073	2	 257x20 (18,2)	186589	186931			
1.9TD, 2.0JTD, 2.0ie, 2.0ie Turbo, 2.1TD		F	10/98→08/02	LUC 21801 	598064	4	 281x26 (24,2)	186420				

























								
FIAT  (.../...)								
Ulysse (U6) (98>2002) (.../...)								
1.8ie, 1.9TD, 2.0JTD, 2.0ie 2.0ie Turbo, 2.1TD	ABS(+) R	10/98→08/02	ATE 21275 	598502	0	 295x10 (8)	186421	
Ulysse (2002>)								
2.0JTD, 2.0i, 2.2JTD (94KW)	F	09/02→	LUC 20261 	598553	2(A)	 285,2x28 (26)	● 197219	● 186984
2.2JTD (125KW)	F	01/08→				 310x32		
3.0i V6	F	09/02→09/05	BBO 23092 	598468	4	 310x32		
2.0JTD, 2.0i, 2.2JTD, 3.0i V6	R	09/02→	LUC 20960 	598463	0(D)	 272x12 (10)	186724	
Uno (146) (83>89)								
0.9, 1.0, 1.1, 1.1 GPL, 1.3, 1.3D, 1.5	F	01/83→10/89	BDX 20775 	598091	2	 227,5x10,8 (9)	186151	186904
1.1, 1.4TD, 1.7D	F	10/85→1989	LUC 21105 	598095	1	 240,5x12 (10,8)	186157	
1.3 Turbo ie	F	03/85→1989	LUC 21105 	598095	1	 240x19,9 (18,2)	* 186156	
	F	03/85→1989	LUC 20838 	598219	4	 240x19,9 (18,2)	* 186156	
	R	03/85→1989	LUC 21103 	598142	0	 227,5x10,8 (9)	186151	
Uno (89>95)								
0.9ie, 1.0, 1.1ie, 1.3D, 1.4, 1.4i	F	10/89→12/93	BDX 20775 	598091	2	 227,5x10,8 (9)	186151	186904
1.7D, 1.9D	F	10/89→08/95	LUC 21105 	598095	1	 240,5x12 (10,8)	186157	
1.1 5 speed C513	F	10/89→12/92	BDX 20775 	598091	2	 227,5x10,8 (9)	186151	186904
1.1 CVT Selecta	F	07/90→12/92	LUC 21105 	598095	1	 240,5x12 (10,8)	186157	
1.4ie 5 speed C510	F	10/89→12/93	BDX 20775 	598091	2	 227,5x10,8 (9)	186151	186904
1.4ie CVT Selecta	F	10/89→12/93	LUC 21105 	598095	1	 240,5x12 (10,8)	186157	
1.5ie 5 speed C514	F	10/89→12/93	BDX 20775 	598091	2	 240,5x12 (10,8)	186157	
1.5ie CVT Selecta	F	10/89→12/93	LUC 21105 	598095	1	 240,5x12 (10,8)	186157	
1.4TD	F	10/89→06/90	LUC 20838 	598219	4	 240,5x12 (10,8)	186157	
	F	07/90→07/93	LUC 21105 	598095	1	 240,5x12 (10,8)	186157	
1.3ie Turbo, 1.4ie Turbo	F	10/89→09/93	LUC 20838 	598219	4	 240x19,9 (18,2)	* 186156	
	R	10/89→09/93	LUC 21103 	598142	0	 227,5x10,8 (9)	186151	

			RPF		WVA		Valeo		Valeo		Valeo	
FIAT  (.../...)												
Uno CS (146) (87>)												
1.1, 1.7D	F	10/87→12/95	ATE 21193		598271	2(A)		240,5x12 (10,8)	186157			
Uno Mondo (98>)												
1.0i, 1.4	F	01/98→	BDX 20775		598091	2		240,5x12 (10,8)	186157			
1.1	F	01/98→	BDX 20775		598091	2		227,5x10,8 (9)	186151	186904		
1.7D	F	01/98→	LUC 20838		598219	4		240,5x12 (10,8)	186157			
	F	01/98→						240,5x12 (10,8)	186157			
	F	01/98→	LUC 20838		598219	4						
X1/9 (69>89)												
1.3, 1.5	F	03/69→1989	BDX 20647		598090	2		227,5x10,8 (9)	186151			
	R	03/69→1989	BDX 20647		598088	0		227,5x10,8 (9)	186151			
FIAT 												
242 (73>85)												
1.6, 2.0, 2.2D, 2.5D	F	06/73→1985						285x20 (18)	* 186137			
	R	06/73→1985						279x8,9				
Doblo (223) (2000>2003)												
1.2i, 1.6i, 1.9DS, 1.9JTD	F	10/00→12/03	ATE 20907		598422	0		257,4x20 (18,2)	186153			
Doblo (2004>2005)												
1.2i, 1.3MTJ, 1.6i, 1.6i GNV, 1.9DS, 1.9JTD	F	01/04→12/05	ATE 20907		598422	0		257,4x20 (18,2)	186153			
Doblo II (2006>)												
1.3MJTD, 1.4i, 1.6i GNV, 1.9MJTD	F	01/06→	BOS 23708		598698	0		284,5x22 (20,2)	186266			
Doblo III (2010>)												
1.3MJTD 90, 1.4i 95, 1.6MJTD 105, 2.0MJTD 135	F	01/10→						284,5x22 (20,2)	186265			
Doblo Cargo (2000>2003)												
1.2i, 1.6i, 1.9DS, 1.9JTD	F	10/00→12/03	ATE 20907		598422	0		257,4x20 (18,2)	186153			
Doblo Cargo (2004>2005)												
1.2i, 1.3MTJ, 1.6i GNV, 1.9DS, 1.9JTD	F	01/04→12/05	ATE 20907		598422	0		257,4x20 (18,2)	186153			
Doblo Cargo II (2006>)												
1.3MJTD, 1.4i, 1.6i GNV, 1.9MJTD	F	01/06→	BOS 23705		598426	1		257x22 (20,5)	186590			





















































																		
FIAT  (.../...)																		
Doblo Cargo III (2010>)																		
1.3MJTD 90, 1.4i 95, 1.6MJTD 105, 2.0MJTD 135			F	01/10→														
Ducato (280) (81>85)																		
1.8, 2.0, 2.5D			10Q, 14Q	F	11/81→05/84	LUC 20741		598153	2									
			10Q, 14Q	F	06/84→05/85	LUC 20741		598153	2									
Ducato (280) (85>90)																		
1.8, 1.9D, 1.9TD, 2.0, 2.5D 2.5TD			10Q, 14Q	F	06/85→06/90	LUC 20741		598153	2									
2.0, 2.5TD			18Q	F	06/86→06/90	LUC 21206		598138	2									
Ducato (280) (90>94)																		
1.9D, 1.9TD, 2.0, 2.5D 2.5TD			10Q, 12Q, 14Q	F	07/90→01/94	LUC 20741		598153	2									
2.0			18Q	F	07/90→01/94	LUC 21206		598138	2									
Ducato (230) (94>2001)																		
1.9D, 1.9TD 2.0JTD-EGR			 578269110Q, 14Q	F	02/94→	LUC 21797		598070	2(B)									
			 578269210Q, 14Q	F	→11/01	LUC 21797		598429	1(A)									
			 578269210Q, 14Q	F	→11/01	LUC 21799		598430	1(B)									
			10Q, 14Q	F	11/01→12/01	BBO 23918		598568	1									
2.0, 2.0i, 2.5D 2.5TD, 2.8D 2.8JTD, 2.8TDi			 578269110Q, 14Q, 15Q	F	02/94→	LUC 21797		598070	2(B)									
			 578269210Q, 14Q, 15Q	F	→11/01	LUC 21797		598429	1(A)									
			 578269210Q, 14Q, 15Q	F	→11/01	LUC 21799		598430	1(B)									
			10Q, 14Q, 15Q	F	11/01→12/01	BBO 23918		598568	1									
			 578844118Q	F	02/94→	LUC 21799		598800	2(A)									
			 578844218Q	F	→11/01	LUC 21797		598429	1(A)									
			 578844218Q	F	→11/01	LUC 21799		598430	1(B)									
			18Q	F	11/01→12/01	BBO 23919		598569	1									

			 		  			    		 	
FIAT  (.../...)											
Ducato (244) (2002>2006)											
2.0, 2.0JTD, 2.0i, 2.0i GPL	11Q, 15Q	F	01/02→06/06	BBO 23918		598568	1		280x24 (21,9)	186418	
2.3JTD, 2.8JTD, 2.8TD											
	11Q, 15Q, JA(+)	F	01/02→06/06	BBO 23918		598568	1				
2.0i, 2.0i GPL, 2.3JTD, 2.8JTD, 2.8TD	18Q	F	01/02→06/06	BBO 23919		598569	1		300x24 (21,9)	197228	
	18Q, JA(+)	F	01/02→06/06	BBO 23919		598569	1				
	18Q	R	01/02→06/06						280x16 (14,2)	186708	
	18Q, JA(+)	R	01/02→06/06								
2.8JTD, 2.8TD	11Q, 15Q	R	01/02→06/06								
	11Q, 15Q, JA(+)	R	01/02→06/06								
Ducato (250-251) (2006>)											
2.2MJTD, 2.3MJTD, 3.0MJTD	30, 33	F	07/06→01/09	BBO 24468		598891	1		280x24 (21,9)	197043	
	30, 33	F	01/09→	BBO 24468		598891	1				
	35	F	07/06→01/09	BBO 24468		598891	1		280x28 (25,9)	197248	
	35	F	01/09→	BBO 24468		598891	1				
3.0MJTD	35, 1700Kg	F	07/06→01/09						300x24 (21,9)	197131	
	35, 1700Kg	F	01/09→								
	35, 2000Kg	F	07/06→								
2.2MJTD, 2.3MJTD	30, 33, 35	R	07/06→01/09	BOS 24465		598892	0		280x16 (14,2)	197023	
	30, 33, 35	R	01/09→	BOS 24465		598892	0				
3.0MJTD	30, 33, 35	R	07/06→	BOS 24465		598892	0		280x16 (14,2)	197023	
	35, 1700Kg	R	07/06→01/09	BOS 24465		598892	0		280x16 (14,2)	197097	
	35, 1700Kg	R	01/09→	BOS 24465		598892	0				
	35, 2000Kg	R	07/06→	BOS 24465		598892	0		300x16 (14,2)	197105	
Ducato RU (2008>)											
2.3JTD	11Q, 15Q	F	01/08→	BBO 23918		598568	1		280x24 (21,9)	186418	



















































																			
FIAT  (.../...)																			
Ducato RU (2008>) (.../...)																			
2.3JTD (...)	18Q	F	01/08→	BBO 23919		598569	1		300x24 (21,9)	● 197228									
	11Q, 15Q, 18Q, JA(+)	F	01/08→						x24										
	18Q	R	01/08→	BBO 23921		598570	0		280x16 (14,2)	186708									
	18Q, JA(+)	R	01/08→						280x16										
Duna (146) (87>91)																			
1.1, 1.3, 1.7D		F	03/87→12/91	ATE 21193		598271	2(A)		240,5x12 (10,8)	186157									
Fiorino (127) (78>87)																			
0.9, 1.05, 1.3D		F	09/78→1987	BDX 20647		598090	2		227,5x10,8 (9)	186151									
Fiorino (147) (81>89)																			
1.05, 1.3D		F	02/81→1989	ATE 20375		* 598371	0		227,5x10,8 (9)	186151									
Fiorino (146) (88>93)																			
1.1, 1.3, 1.3D, 1.5ie, 1.7D		F	03/88→06/93	ATE 21193		598271	2(A)		240,5x12 (10,8)	186157									
Fiorino (146) (93>2000)																			
1.3, 1.4ie, 1.6i, 1.6ie, 1.7D, 1.7TDS		F	08/93→09/00	ATE 21193		598271	2(A)		240,5x12 (10,8)	186157									
Fiorino (2007>)																			
1.3MJTD, 1.4i		F	12/07→	BOS 23705		598426	1		257x22 (20,5)	186590									
Scudo (220) (95>2003)																			
1.6i, 1.9D, 1.9TD, 2.0JTD, 2.0i		F	07/95→12/03	LUC 21801		598064	4		281x26 (24,2)	186420									
		F	07/95→12/03	BDX 23042		598073	2		257x20 (18,2)	186589	186931								
Scudo (2004>2006)																			
1.9D		F	01/04→12/06	BDX 23042		598073	2		257x20 (18,2)	186589	186931								
2.0, 2.0JTD		F	01/04→12/06	LUC 20261		598553	2(A)		281x26 (24,2)	186420									
Scudo (22X) (2007>)																			
1.6Mj (1.0T)		F	01/07→	LUC 24595		● 598899	1		280x28 (26)	● 197188									
1.6Mj (1.2T), 2.0Mj		F	01/07→	LUC 24595		● 598899	1		304x28 (26)	● 197133									
1.6Mj, 2.0Mj		R	01/07→	LUC 24578		● 601039	0		290x14 (12)	● 197099									
Strada Pick Up (99>2003)																			
1.2i, 1.7TDS, 1.9Ds		F	03/99→03/03	ATE 20907		598424	2		257,4x20 (18,2)	186153									







































			R P F		WVA Valeo Valeo			Valeo Valeo	
FIAT 									
Strada Pick up (2003>2006)									
1.2i, 1.9Ds, 1.9JTD	F	03/03→05/06	ATE 20907		598424	2		257,4x20 (18,2)	186153
Strada II Pick-up (2006>)									
1.3MJTD	F	06/06→	ATE 20907		598424	2		257,4x20 (18,2)	186153
Talento (290) (88>94)									
1.9D, 2.0	F	03/88→1994	LUC 20741		598153	2		256x16 (13,5)	186206
FORD 									
Explorer (90>)									
4.0i	F	01/90→11/94	23472		● 598906	2		276x22	
	F	11/94→						286x26	
	F	01/90→11/94						276x22	
	F	11/94→						286x26	
	R	01/90→						285x12	
Maverick (93>98)									
2.4i, 2.7TD, 2.7TDi	F	02/93→03/98	LUC 21481		598602	0		277x26	
Maverick (2000>2006)									
2.0i, 2.3i, 3.0i V6	F	12/00→12/03						278x24	
	F	12/03→05/06						278x24	
	R	12/00→12/03							
	R	12/03→05/06							
Ranger II (2002>2007)									
2.5TD	F	01/02→09/06	KH 23540		598784	1		256x24	
2.5TD 4WD	F	01/02→09/06	KH 23540		598784	1		294x24,3	
FORD 									
Capri (68>87)									
1.3 V4, 1.5 V4, 1.7 V4, 2.0 V6	F	12/68→08/72							
1.3, 1.6, 2.0, 2.0 V6, 2.3, 2.8i, 3.0	F	10/70→04/87	LUC 20491		598168	2			

















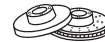































FORD (.../...)									
Cortina (76>82)									
1.3, 1.6	F	11/76→1979						247,6x12,7	
2.0, 2.3	F	1979→10/82	LUC 20491		598168	2		247,6x12,7	
Cougar (98>2001)									
2.0i	F	09/98→02/01	ATE 21394		598034	0		260x24,1 (22,2)	186277 186938
2.5i V6	F	09/98→02/01	ATE 21394		598033	2		278x24 (22,2)	186401
2.0i	R	09/98→02/01						253x20 (18)	186426
2.5i V6	R	09/98→02/01	BDX 21586		598035	2		253x20 (18)	186426
Escort (67>74)									
1.3	F	09/69→12/74	ATE 20088		598338	0		219x9,5	
1.1, 1.3, 1.6	F	10/67→12/74						244x12,7	
Escort (74>80)									
1.3 1V, 1.3 2V	F	12/74→08/80	LUC 20491		598168	2		247,6x12,7	
2	F	06/76→08/80	LUC 20491		598168	2		244x12,7	
Escort (80>86)									
1.1, 1.3, 1.6, 1.6 Turbo, 1.6D, 1.6i 	F	08/80→02/86	ATE 20783		598212	0		239,7x10 (8,7)	186158
1.1, 1.3, 1.6, 1.6D	F	08/80→02/86	ATE 20783		598334	2		239,7x10 (8,7)	186158
1.1, 1.3, 1.6, 1.6 Turbo, 1.6D 1.6i	ABS(+) F	08/80→02/86	ATE 20783		598166	2		239,7x24,1(22,2)	186159
Escort (86>90)									
1.1, 1.3, 1.6D	F	01/86→09/90	ATE 20783		598212	0		239,7x10 (8,7)	186158
1.1, 1.3, 1.4, 1.4i, 1.6, 1.6D, 1.6i 1.8D	F	01/86→09/90	ATE 20783		598212	0		239,7x24,1(22,2)	186159 186934
1.6i XR3i	F	01/86→09/90	ATE 20783		598166	2		239,7x24,1(22,2)	186159
1.6 RS Turbo	F	01/86→09/90	ATE 20908		598335	0		260,2x24,2(22,8) * 186166	
Escort (90>94)									
1.1, 1.3, 1.3i	ABS(-) F	09/90→12/94	BDX 23300		598172	0		239,7x10 (8)	186162 186935
1.3, 1.3i	ABS(+) F	09/90→12/94	BDX 23300		598399	0		239,7x10 (8)	186162

























			R P F		WVA		Valeo		Valeo		Valeo	
FORD (.../...)												
Escort (90>94) (.../...)												
1.1, 1.3, 1.3i, 1.4, 1.4i, 1.6, 1.6i, 1.8D 1.8TD, 1.8i 	F	09/90→12/94	BDX 23300 	598172	0		239,7x20 (18)	186163	186903			
1.3, 1.3i, 1.4, 1.4i, 1.6, 1.6i, 1.8D, 1.8TD 1.8i 	F	09/90→12/94	BDX 23300 	598399	0		239,7x20 (18)	186163				
1.8i XR3i, 2.0i RS 	F	02/91→12/94	ATE 20908 	598335	0		260x24,2 (22,2)	186427				
2.0i Cosworth 	F	03/92→12/94	ATE 21910 	598619	0		278x24					
1.8i XR3i, 2.0i RS 	R	02/91→12/94					270x10 (8,6)	186428				
2.0i Cosworth 	R	03/92→12/94	LUC 20981 	598240	0		273x20					
Escort (95>2001)												
1.4i, 1.6i, 1.8D, 1.8TD, 1.8i 	F	01/95→09/01	BDX 23300 	598172	0		239,7x20 (18)	186163	186903			
	F	01/95→09/01	BDX 23300 	598399	0		239,7x20 (18)	186163				
1.6i 4x4 	F	03/95→08/96	ATE 20908 	598335	0		239,7x20 (18)	186163				
1.8i XR3i 	F	01/95→09/95	ATE 20908 	598335	0		260x24,2 (22,2)	186427				
	F	01/95→09/95	ATE 20907 	598120	2		260x24,2 (22,2)	186427				
1.8i XR3i, 2.0i RS 	F	01/95→08/96	BDX 23300 	598172	0		260x24,2 (22,2)	186427				
2.0i Cosworth 	F	08/95→12/95	BDX 23300 	598172	0		278x24					
1.4i, 1.6i, 1.6i 4x4, 1.8D, 1.8TD, 1.8i 1.8i XR3i, 2.0i RS 	R	01/95→09/01					270x10 (8,6)	186428				
2.0i Cosworth 	R	08/95→12/95					273x20					
Fiesta (76>83)												
0.9, 1.1, 1.3	F	06/76→08/83	BDX 20422 	598165	0		221x10 (8,7)	186160				
1.6 XR2	F	10/81→08/83	ATE 20783 	598212	0		239,7x20 (18)	186163	186941			
	F	10/81→08/83	ATE 20783 	598212	0		239,5x20					
Fiesta (83>89)												
0.9, 1.1, 1.3, 1.4, 1.6D	F	08/83→1989	ATE 20857 	598167	0		221x10 (8,7)	186160				
1.6 XR2	F	02/84→1989	ATE 20783 	598212	0		239,7x20 (18)	186163	186941			
	F	02/84→07/87	ATE 20783 	598212	0		239,5x20					































																		
FORD  (.../...)																		
Fiesta (83>89) (.../...)																		
1.6 XR2 (...)	F	08/87→1989	ATE 20783		598212	0		221x10 (8,7)	186160									
Fiesta (89>95)																		
1.3i	F	02/89→01/94	ATE 21203		598043	0		239,7x10 (8)	186162									
1.0, 1.1, 1.1i, 1.3, 1.3i, 1.4, 1.4i, 1.8D 1.8TD	F	02/89→07/95	ATE 21203		598171	0		239,7x10 (8)	186162	186901								
1.1, 1.1i, 1.3, 1.3i, 1.4, 1.4i 1.8D, 1.8TD	ABS(+)	F	02/89→07/95	ATE 20783		598212	0		239,7x10 (8)	186162								
1.3i	ABS(+)	F	02/89→01/94	ATE 21203		598043	0		239,7x20 (18)	186163								
1.1, 1.1i, 1.3, 1.3i, 1.4, 1.4i 1.8D, 1.8TD	ABS(+)	F	02/89→07/95	ATE 21203		598171	0		239,7x20 (18)	186163								
1.1, 1.1i, 1.3, 1.3i, 1.4, 1.4i 1.6, 1.6i, 1.6i Turbo, 1.8D, 1.8TD 1.8i	ABS(+)	F	02/89→07/95	ATE 20783		598212	0		239,7x20 (18)	186163	186941							
Fiesta (95>99)																		
1.0i, 1.1i, 1.2i, 1.3i, 1.8D	F	08/95→09/99	ATE 21203		598043	0		239,7x12 (10)	186529	186940								
1.0i, 1.1i	F	08/95→08/99	ATE 21203		598171	0		239,7x12 (10)	186529									
1.8D	ABS(+)	F	08/95→08/99	ATE 20783		598212	0		239,7x12 (10)	186529								
1.0i, 1.2i, 1.4i, 1.8D	ABS(+)	F	08/95→08/99	ATE 20783		598212	0		239,7x20 (18)	186163								
Fiesta (99>2002)																		
1.2i, 1.3i, 1.4i, 1.6i, 1.8D	F	09/99→02/00	ATE 20783		598212	0		239,7x20 (18)	186163	186941								
1.2i, 1.3i, 1.4i, 1.6i, 1.8D 1.8TDdi	ABS(-)	F	02/00→03/02	ATE 23200		598563	0		239,7x20 (18)	186163								
	ABS(+)	F	02/00→03/02	ATE 23202		598564	0		239,7x20 (18)	186163								
	ABS(+)	F	02/00→03/02	ATE 23202		598564	0		258x22 (20)	186560								
Fiesta (2002>2005)																		
1.2i, 1.3i, 1.4TDCi, 1.4i, 1.6TDCi, 1.6i	F	03/02→09/05	ATE 23202		598564	0		258x22 (20)	186560									
2.0i	F	01/05→09/05	ATE 23440		598639	0												
	R	01/05→09/05	LUC 23353		598431	1		253x10 (8,9)	186425									











































															
FORD (…/…)															
Fiesta (2005>2008)															
1.2i, 1.3i, 1.4TDCi, 1.4i, 1.6TDCi, 1.6i	F	10/05→11/08	ATE 23202 	598564	0		258x22 (20)	186560							
2.0i	F	10/05→11/08	ATE 23440 	598639	0										
	R	10/05→11/08	LUC 23353 	598431	1		253x10 (8,9)	186425							
Fiesta (2008>)															
1.25i 60, 1.25i 82, 1.4TDCi 68, 1.4i, 1.6TDCi 1.6TDCi 95, 1.6Ti-VCT	F	10/08→	LUC 24283 	● 598999	1		258x23								
Focus (98>2001)															
1.4i, 1.6i, 1.8TDCi, 1.8TDi, 1.8i, 2.0i	F	10/98→10/01	ATE 23154 	598317	0		258x22 (20)	186560							
	ABS(+)	R	10/98→10/01	LUC 23353 	598431	1		253x10 (8,9)	186425						
Focus (2001>2004)															
1.4i, 1.6i, 1.8TDCi, 1.8TDdi, 1.8i, 2.0i 	F	11/01→08/04	ATE 23154 	598317	0		258x22 (20)	186560							
2.0i ST 170 	F	11/01→08/04	ATE 23440 	598639	0		300x22								
2.0i Turbo RS 	F	09/02→08/04					324x28								
1.4i, 1.6i, 1.8TDCi, 1.8TDdi, 1.8i 2.0i 	ABS(+)	R	11/01→08/04	LUC 23353 	598431	1		253x10 (8,9)	186425						
2.0i ST 170, 2.0i Turbo RS 	R	11/01→08/04	LUC 23353 	598431	1		280x10								
Focus (2004>)															
1.4i, 1.6TDCi, 1.6Ti-VCT, 1.6i, 1.8TDCi 1.8i CNG, 1.8i Flexfuel, 2.0TDCi, 2.0i 	F	09/04→	ATE 23723 	598649	0		278x25 (23)	186819							
2.0TDCi, 2.0i 	F	09/04→	ATE 23723 	598649	0		300x25 (23)	186863							
2.5i 	F	10/05→	ATE 23762 	598822	0		320x25 (23)	● 197143							
1.4i, 1.6TDCi, 1.6Ti-VCT, 1.6i, 1.8TDCi 1.8i CNG, 1.8i Flexfuel, 2.5i 	R	09/04→	ATE 23482 	598472	0		265x11 (9)	186842							
		R	09/04→	TVS 23483 	● 601044	0		265x11 (9)	186842						
2.0TDCi, 2.0i, 2.5i 	R	09/04→	ATE 23482 	598472	0		280x10,9 (9)	186843							
		R	09/04→	TVS 23483 	● 601044	0		280x10,9 (9)	186843						















































	
FORD (…/…)	
Focus II (2007>)	
1.4, 1.6, 1.6TDCi, 1.6TDCi 110, 1.6TDCi 90 1.6Ti-VCT, 1.8 	F 12/07→ ATE 23723  598649 0  278x25 (23) 186819
1.8TDCi, 2.0, 2.0TDCi 	F 12/07→ ATE 23723  598649 0  300x25 (23) 186863
2.5T 	F 12/07→ ATE 23762  598822 0  320x25 (23) ● 197143
1.4, 1.6, 1.6TDCi, 1.6TDCi 110, 1.6TDCi 90 1.6Ti-VCT, 1.8, 1.8TDCi, 2.0, 2.0TDCi 2.5T 	R 12/07→ ATE 23482  598472 0
	R 12/07→ TVS 23483  ● 601044 0
2.5T 	R 01/09→ LUC 24537  ● 598935 0  302x10,9 (9) ● 197101
Focus C-Max (2003>2007)	
1.6TDCi, 1.6TDCi DPF, 1.6Ti-VCT, 1.8TDCi 1.8i, 1.8i CNG, 1.8i Flexifuel, 2.0TDCi 2.0TDCi DPF, 2.0i	F 06/03→02/07 ATE 23723  598649 0  278x25 (23) 186819
1.6TDCi, 1.6TDCi DPF, 1.8TDCi, 1.8i, 2.0TDCi 2.0TDCi DPF, 2.0i	F 06/03→02/07 ATE 23723  598649 0  300x25 (23) 186863
1.6TDCi, 1.6TDCi DPF, 1.6Ti-VCT, 1.6i 1.8TDCi, 1.8i, 1.8i CNG, 1.8i Flexifuel 2.0TDCi, 2.0TDCi DPF, 2.0i	R 06/03→02/07 TVS 23483  ● 601044 0  265x11 (9) 186842
	R 06/03→02/07 ATE 23482  598472 0  265x11 (9) 186842
1.6TDCi, 1.6i, 1.8i, 2.0TDCi	R 10/03→ ATE 23723  ● 601005 0  265x11 (9) 186842
1.6TDCi, 1.6TDCi DPF, 1.6Ti-VCT, 1.6i 1.8TDCi, 1.8i, 1.8i CNG, 1.8i Flexifuel 2.0TDCi, 2.0TDCi DPF, 2.0i	R 06/03→02/07 TVS 23483  ● 601044 0  280x10,9 (9) 186843
	R 06/03→02/07 ATE 23482  598472 0  280x10,9 (9) 186843
1.6TDCi, 1.6i, 1.8i, 2.0TDCi	R 10/03→ ATE 23723  ● 601005 0  280x10,9 (9) 186843
Focus C-Max (2007>)	
1.6TDCi, 1.6TDCi DPF, 1.6i, 1.8i	F 03/07→ ATE 23723  598649 0  278x25 (23) 186819
1.8TDCi, 2.0TDCi, 2.0TDCi DPF, 2.0i	F 02/07→ ATE 23723  598649 0  300x25 (23) 186863
1.6TDCi, 1.6TDCi DPF, 1.6i, 1.8i	R 03/07→ ATE 23482  598472 0  265x11 (9) 186842

















































































																		
FORD  (.../...)																		
Focus C-Max (2007>) (.../...)																		
1.8TDCi, 2.0TDCi, 2.0TDCi DPF, 2.0i			R	02/07→	ATE 23482		598472	0		280x10,9 (9)	186843							
Focus Coupé Cabriolet (2006>)																		
1.6i			F	07/06→	ATE 23723		598649	0		278x25 (23)	186819							
2.0TDCi, 2.0i			F	07/06→	ATE 23723		598649	0		300x25 (23)	186863							
1.6i			R	07/06→	ATE 23482		598472	0		265x11 (9)	186842							
2.0TDCi, 2.0i			R	07/06→	ATE 23482		598472	0		280x10,9 (9)	186843							
Fusion (2002>2005)																		
1.25i, 1.4TDCi, 1.4i, 1.6TDCi, 1.6i			F	06/02→09/05	ATE 23202		598564	0		258x22 (20)	186560							
Fusion (2005>)																		
1.2i, 1.4TDCi, 1.4i, 1.6TDCi, 1.6i			F	10/05→	ATE 23202		598564	0		258x22 (20)	186560							
Galaxy (95>2000)																		
1.9TDi, 2.0i, 2.3i, 2.8i VR6			F	05/95→03/00	ATE 20676		598067	0		288x25 (21)	197236							
			R	05/95→03/00	LUC 20960		598463	0(D)		268x10 (8)	186624							
Galaxy (2000>2006)																		
1.9TDi			⊙ 15"	F	04/00→04/01	ATE 20676		598489	1(A)		288x25 (21)	197236						
2.0i, 2.3i			⊙ 15"	F	04/00→04/01	ATE 20676		598067	0		288x25 (21)	197236						
1.9TDi			⊙ 16"	F	05/01→04/06	ATE 23034	598801	2		300x26 (22)	197239							
2.0i, 2.3i			⊙ 16"	F	05/01→04/06	ATE 20676		598489	1(A)		300x26 (22)	197239						
2.8i V6				F	04/00→04/06	ATE 23269		598565	2		313x25,9 (22)	186800						
1.9TDi				R	04/00→04/06	LUC 20960		598681	1(A+D)		268x10 (8)	186624						
2.0i, 2.3i				R	04/00→04/06	LUC 20960		598463	0(D)		268x10 (8)	186624						
2.8i V6				R	04/00→04/06	LUC 20960		598681	1(A+D)		294x13,6 (11,5)	186801						
Galaxy (CA1) (2006>)																		
1.8TDCi, 2.0TDCi, 2.0i			F	04/06→	ATE 24123		598879	0		300x28 (26)	197055							
2.3i			F	03/07→	ATE 24123		598879	0		300x28 (26)	197055							
2.2TDCi			F	07/08→	ATE 24123		598879	0		316x28								























































																	
FORD  (.../...)																	
Galaxy (CA1) (2006>) (.../...)																	
2.5i	F	04/06→	ATE 24142		● 601007	0											
1.8TDCi, 2.0TDCi, 2.0i	Handbrake mechanic	R	04/06→	LUC 24537		● 598935	0										
2.2TDCi, 2.3i, 2.5i																	
	Handbrake electric	R	04/06→	LUC 24496		● 598928	0										
Granada (MK2) (77>82)																	
1.6	F	07/81→08/82	ATE 20907		598120	2											
1.7, 2, 2.1D, 2.3	F	09/77→08/82	LUC 20491		598168	2											
2.8, 2.8i	F	09/77→08/81															
2.5D, 2.8	F	08/81→08/82	LUC 20491		598168	2											
Granada (85) (85>91)																	
1.8, 2.0, 2.0i, 2.4i, 2.5D, 2.5TD, 2.8i, 2.9i	F	05/85→12/91	ATE 20907		598120	2											
	R	05/85→12/91	LUC 20981		598121	2											
	R	05/85→12/91	LUC 20981		598240	0											
Granada (92) (92>95)																	
2.0i, 2.5TD, 2.9i 	F	01/92→08/92	ATE 20907		598120	2											
	F	01/92→08/92	ATE 20908		598335	0											
2.0i, 2.5TD, 2.5TDi, 2.9i 	F	08/92→10/94	ATE 21394		598033	2											
	F	10/94→01/95	ATE 21394		598034	0											
	R	01/92→10/94	LUC 20981		598240	0											
2.0i, 2.5TD, 2.5TDi, 2.9i 	R	10/94→01/95	LUC 20981		598240	0											
2.0i, 2.5TDi, 2.9i 	R	10/94→01/95	LUC 20981		598240	0											
Ka (96>2008)																	
1.3i	F	09/96→01/00	ATE 21203		598043	0											
	F	07/98→01/00	ATE 21203		598171	0											
	F	02/00→11/08	ATE 23200		598563	0											
1.6i SportKa	F	02/03→11/08	ATE 23202		598564	0											











			 		 		 			
FORD  (.../...)										
Ka (2008>)										
1.2i	F	12/08→	BOS 21436 	● 598987	1	 240,5x10,9 (9,2)	186155			
1.3TDCi	F	12/08→	BOS 24764 	● 601015	1	 240,5x20 (18,2)	186744			
Kuga (2008>)										
2.0TDCi, 2.5T	F	04/08→	ATE 23723 	598649	0	 300x25 (23)	186863			
	R	04/08→	LUC 24537 	● 598935	0	 302x10,9 (9)	● 197101			
Mondeo (93>96)										
1.6i, 1.8TD, 1.8i, 2.0i	F	01/93→08/96	ATE 21394 	598034	0	 260x24,1 (22,2)	186277	186938		
	F	01/93→08/96	ATE 21394 	598033	2	 260x24,1 (22,2)	186277	186937		
2.5i V6 24V	F	07/94→08/96	ATE 21910 	598619	0	 278x24 (22,2)	186401			
1.8i 4x4, 2.0i 4x4, 2.5i V6 24V	F	07/94→08/96	ATE 21910 	598630	2	 278x24 (22,2)	186401			
1.6i, 1.8TD, 1.8i, 1.8i 4x4, 2.0i, 2.0i 4x4 2.5i V6 24V	R	01/93→08/96	BDX 21586 	598035	2	 253x20 (18)	186426			
Mondeo (96>2000)										
1.6i, 1.6i Clipper, 1.8TD, 1.8TD Clipper 1.8i, 2.0i, 2.0i Clipper	F	08/96→08/00	ATE 21394 	598034	0	 260x24,1 (22,2)	186277	186938		
	F	08/96→08/00	ATE 21394 	598033	2	 260x24,1 (22,2)	186277	186937		
1.8i Clipper, 2.0i Clipper, 2.5i V6 2.5i Clipper V6	F	08/96→09/00	ATE 21394 	598034	0	 278x24 (22,2)	186401			
	F	08/96→09/00	ATE 21394 	598033	2	 278x24 (22,2)	186401			
1.6i, 1.6i Clipper, 1.8TD, 1.8TD Clipper 1.8i, 1.8i Clipper, 2.0i, 2.0i Clipper 2.5i V6, 2.5i Clipper V6	R	08/96→09/00	BDX 21586 	598035	2	 253x20 (18)	186426			
Mondeo (2000>2003)										
1.8i, 2.0Di, 2.0TDCi, 2.0TDDi, 2.0i, 2.5i V6 3.0i V6, 3.0i V6 ST220 	F	10/00→05/03	BOS 23279 	598433	0	 300x24 (22)	186750			
	R	10/00→05/03	BOS 23557 	598434	0	 280x12 (10)	186834			
3.0i V6 ST220 	R	03/02→05/03	LUC 20960 	598681	1(A+D)	 280x12 (10)	186834			

																		
FORD  (.../...)																		
Mondeo (2003>2005)																		
1.8SCi, 1.8i, 2.0TDCi, 2.0TDDi, 2.0i, 2.2TDCi 2.5i V6, 3.0i V6	F	06/03→04/05	BOS 23279 	598433	0		300x24 (22)	186750										
1.8SCi, 1.8i, 2.0TDCi, 2.0TDDi, 2.0i, 2.5i V6	R	06/03→09/04	BOS 23557 	598434	0		280x12 (10)	186834										
1.8SCi, 1.8i, 2.0TDCi, 2.0TDDi, 2.0i, 2.2TDCi 2.5i V6, 3.0i V6	R	09/04→04/05	BOS 24260 	598740	0		280x12 (10)	186834										
Mondeo (2005>2007)																		
1.8SCi, 1.8i, 2.0TDCi, 2.0i, 2.2TDCi, 3.0i V6	F	05/05→06/07	BOS 23279 	598433	0		300x24 (22)	186750										
	R	05/05→06/07	BOS 24260 	598740	0		280x12 (10)	186834										
Mondeo (2007>)																		
1.6Ti-VCT, 1.8TDCi, 2.0, 2.0TDCi, 2.3, 2.5	F	06/07→	ATE 24123 	598879	0		300x28 (26)	197055										
2.2TDCi	F	07/08→	ATE 24142 	601007	0		300x28 (26)	197055										
1.6Ti-VCT, 1.8TDCi, 2.0, 2.0TDCi, 2.2TDCi 2.3, 2.5	R	06/07→	LUC 24537 	598935	0		302x10,9 (9)	197101										
Orion (83>90)																		
1.3, 1.6D	F	09/83→02/86	ATE 20783 	598166	2		239,7x10 (8,7)	186158	186936									
	F	09/83→08/90	ATE 20783 	598212	0		239,7x10 (8,7)	186158										
1.6, 1.6i	F	09/83→02/86	ATE 20783 	598166	2		239,7x24,1(22,2)	186159										
1.3, 1.4, 1.4i, 1.6, 1.6D, 1.6i, 1.8D	F	09/83→08/90	ATE 20783 	598212	0		239,7x24,1(22,2)	186159	186934									
Orion (90>93)																		
1.3, 1.3i	ABS(-)	F	09/90→09/93	BDX 23300 	598172	0		239,7x10 (8)	186162	186935								
1.3, 1.3i, 1.4, 1.4i, 1.6, 1.6i 1.8D, 1.8TD, 1.8i	ABS(+)	F	09/90→09/93	BDX 23300 	598172	0		239,7x20 (18)	186163	186903								
1.3i, 1.4, 1.4i, 1.6, 1.6i, 1.8D 1.8TD, 1.8i	ABS(+)	F	09/90→09/93	BDX 23300 	598399	0		239,7x20 (18)	186163									
1.8i 96 KW	F	01/92→09/93	ATE 20908 	598335	0		239,7x20 (18)	186163										
	R	01/92→09/93					270x10											
Probe (92>97)																		
2.5i V6	F	10/92→09/93	SUM 21378 	598250	2		258x24 (22)	186457										









































			R P F		WVA		Valeo		Valeo		Valeo	
FORD  (.../...)												
Probe (92>97) (.../...)												
2.0i, 2.5i V6	F	10/93→12/97	SUM 21754		598629	2		258x24 (22)	186457			
2.5i V6	R	10/92→09/93	SUM 21558		598846	0		261x9,8 (8)	* 186458			
2.0i, 2.5i V6	R	10/93→12/97	SUM 21766		598290	0		261x9,8 (8)	* 186458			
Puma (97>2001)												
1.4i, 1.7i	F	05/97→02/00	ATE 20783		598212	0		239,7x20 (18)	186163	186941		
1.4i, 1.6i, 1.7i	F	02/00→12/01	ATE 23202		598564	0		258x22 (20)	186560			
Scorpio (85>92)												
1.8, 2.4i, 2.5D, 2.5TD, 2.8i, 2.9i	F	03/85→01/92	ATE 20908		598335	0		260x24 (22,2)	186165			
	F	03/85→01/92	ATE 20907		598120	2		260x24 (22,2)	186165			
2.9 Cosworth	F	05/91→01/92						273x20				
1.8, 2.4i, 2.5D, 2.5TD, 2.8i, 2.9i	R	03/85→01/92	LUC 20981		598121	2		253x10,1 (8,9)	* 186424			
	R	03/85→01/92	LUC 20981		598240	0		253x10,1 (8,9)	* 186424			
2.9 Cosworth	R	05/91→01/92	LUC 20981		598121	2		273x20				
Scorpio (92>94)												
2.0, 2.0i, 2.4i, 2.5TD, 2.9i	F	02/92→10/94	ATE 20908		598335	0		260x24 (22,2)	186165			
	F	08/92→10/94	ATE 21394		598034	0		260x24 (22,2)	186165			
	F	08/92→10/94	ATE 21394		598033	2		260x24 (22,2)	186165			
	F	02/92→10/94	ATE 20907		598120	2		260x24 (22,2)	186165			
2.9i Cosworth	F	02/92→10/94	AP 20359		598129	4(B)		278x24				
	F	08/92→10/94	ATE 21910		598630	2		278x24				
2.0, 2.0i, 2.4i, 2.5TD, 2.9i	R	02/92→10/94	LUC 21729		598312	2		253x10,1 (8,9)	* 186424			
	R	02/92→10/94	LUC 20981		598240	0		253x10,1 (8,9)	* 186424			
2.9i Cosworth	R	02/92→10/94	LUC 21729		598312	2		273x20				
Scorpio (94>98)												
2.0i, 2.0i 16V, 2.3i 16V, 2.5TD, 2.9i 	F	10/94→07/98	ATE 21394		598034	0		260x24,1 (22,2)	186277	186938		
2.9i 24V 	F	10/94→07/98	ATE 21910		598619	0		278x24 (22,2)	186401			







																	
FORD  (.../...)																	
Scorpio (94>98) (.../...)																	
2.0i, 2.0i 16V, 2.3i 16V, 2.5TD, 2.9i 	R	10/94→07/98	LUC 20981 	598240	0		253x10 (8,9)	186425									
2.0i, 2.0i 16V, 2.3i 16V, 2.5TD, 2.9i 	R	10/94→07/98	LUC 20981 	598240	0		253x20 (18)	186426									
2.9i 24V  	R	10/94→07/98	LUC 20981 	598240	0		273x20										
Sierra (82>86)																	
1.3, 1.6  	F	08/82→12/86	LUC 20862 	598217	0		239,5x12,7										
1.6 	F	10/84→1986	ATE 20783 	598212	0		239,5x12,7										
1.3, 1.6 	F	08/82→12/86	LUC 20862 	598169	2		239,5x12,7										
1.6 	F	10/84→1986	ATE 20783 	598166	2		239,5x12,7										
1.6, 1.8, 2.0, 2.3, 2.3D  	F	08/82→12/86	ATE 20783 	598212	0		239,7x24,1(22,2)	186159	186934								
	F	08/82→12/86	ATE 20783 	598166	2		239,7x24,1(22,2)	186159									
1.8  	ABS(+)	F	08/82→12/86	ATE 20908 	598335	0		239,7x24,1(22,2)	186159								
1.8, 2.0i  	ABS(+)	F	08/82→12/86	ATE 20783 	598212	0		260,2x24,2(22,8)	* 186166								
	ABS(+)	F	08/82→12/86	ATE 20783 	598166	2		260,2x24,2(22,8)	* 186166								
2.8 4x4, 2.8i 4x4  	ABS(+)	F	08/82→1986	ATE 20908 	598335	0		260,2x24,2(22,8)	* 186166								
2.8 4x4 	F	02/85→12/86	ATE 20908 	598335	0		260x24,2										
2.0 RS Cosworth 	F	01/86→1987	ATE 20783 	598212	0		283x24										
	F	01/86→1987	ATE 20783 	598166	2		283x24										
	F	08/86→1987	ATE 20908 	598335	0		283x24										
	R	01/86→1987	LUC 20981 	598240	0		273x10,3										
Sierra (87>93)																	
1.6, 1.6i, 1.8, 1.8TD, 2.0, 2.0i 2.3D  	ABS(-)	F	01/87→01/93	ATE 20783 	598212	0		239,7x24,1(22,2)	186159	186934							
2.0i 4x4  	ABS(-)	F	01/90→01/93	ATE 20783 	598212	0		239,7x24,1(22,2)	186159	186934							
1.8, 2.0, 2.0i, 2.3D  	ABS(-)	F	01/87→01/93	ATE 20783 	598166	2		239,7x24,1(22,2)	186159								
1.6, 1.6i, 2.0, 2.0i  	ABS(+)	F	01/87→01/93	ATE 20908 	598335	0		239,7x24,1(22,2)	186159								















































			 R P F		 WVA	 Valeo	 Valeo	 Valeo	 Valeo	 Valeo
FORD  (.../...)										
Sierra (87>93) (.../...)										
1.8, 1.8TD, 2.0, 2.0i, 2.3D 	ABS(+)	F	01/87→01/93	ATE 20783 	598212	0		260,2x24,2(22,8)	* 186166	
1.8i 	ABS(+)	F	04/92→01/93	ATE 20783 	598212	0		260,2x24,2(22,8)	* 186166	
1.8, 2.0, 2.0i, 2.3D 	ABS(+)	F	01/87→01/93	ATE 20783 	598166	2		260,2x24,2(22,8)	* 186166	
1.8, 1.8TD, 2.0, 2.0i, 2.3D 	ABS(+)	F	01/87→01/93	ATE 20908 	598335	0		260,2x24,2(22,8)	* 186166	
1.8i 		F	04/92→01/93	ATE 20908 	598335	0		260,2x24,2(22,8)	* 186166	
2.8i, 2.9i 		F	06/88→01/93	ATE 20907 	598120	2		260,2x24,2(22,8)	* 186166	
		F	06/88→01/93	ATE 20908 	598335	0		260,2x24,2(22,8)	* 186166	
2.8i 4x4 		F	01/87→01/93					260,2x24,2(22,8)	* 186166	
2.0i 4x4 	ABS(+)	F	01/90→01/93	ATE 20783 	598212	0		260x24,2		
2.0i 4x4, 2.8i, 2.9i 	ABS(+)	F	01/87→01/93	ATE 20908 	598335	0		260x24,2		
2.8i 4x4, 2.9i 4x4 		F	01/87→01/93					260x24,2		
2.0i Cosworth 		F	11/87→02/90					283x24		
2.0i 4x4 Cosworth 		F	02/90→01/93					278x24		
1.6, 1.6i, 1.8, 1.8TD, 2.0, 2.0i, 2.3D, 2.8i 2.9i 		R	01/87→01/93	LUC 20981 	598240	0		253x10 (8,9)	186425	
2.0i Cosworth 		R	11/87→02/90	LUC 20981 	598240	0		273x10		
2.0i 4x4 Cosworth, 2.8i 4x4, 2.9i 4x4 		R	01/87→01/93	LUC 20981 	598240	0		273x20		
S-Max (2006>)										
1.8TDCi, 2.0TDCi, 2.0i, 2.3i Turbo		F	04/06→	ATE 24123 	598879	0		300x28 (26)	● 197055	
2.2TDCi		F	07/08→	ATE 24123 	598879	0		316x28		
2.5i Turbo		F	04/06→	ATE 24142 	● 601007	0		316x28		
1.8TDCi, 2.0TDCi, 2.0i 2.2TDCi, 2.3i Turbo 2.5i Turbo	Handbrake mechanic	R	04/06→	LUC 24537 	● 598935	0		302x10,9 (9)	● 197101	
	Handbrake electric	R	04/06→	LUC 24496 	● 598928	0		302x10,9 (9)	● 197101	



















































																										
FORD  (.../...)																										
StreetKa (2002>2005)																										
1.6i			F	11/02-12/05	ATE 23202		598564	0		258x22 (20)	186560															
Taurus (76>82)																										
1.3, 1.6, 2, 2.3			F	02/76-07/82	LUC 20491		598168	2		247,6x12,7																
FORD 																										
Courrier (91>96)																										
1.3, 1.3i, 1.8D			F	08/91-09/96	ATE 20783		598212	0		239,7x20 (18)	186163	186941														
Courier Courier (96>2002)																										
1.3i, 1.6i, 1.8D			F	10/96-02/00	ATE 20783		598212	0		239,7x20 (18)	186163	186941														
			ABS(-)	F	02/00-09/02	ATE 23200		598563	0		239,7x20 (18)	186163														
			ABS(+)	F	02/00-09/02	ATE 23200		598563	0		258x22 (20)	186560														
P100 Pick-up (82>87)																										
1.6			F	04/82-10/87						239,7x24,1(22,2)	186159															
P100 Pick-up (88>93)																										
1.8TD, 2.0			F	01/88-05/93	ATE 20783		598212	0		239,7x24,1(22,2)	186159	186934														
Tourneo Connect (2002>2006)																										
1.8TDCi, 1.8TDdi, 1.8i			F	05/02-06/06	ATE 23440		598639	0		278x24 (22)	186748															
			JAT(+)	R	05/02-06/06	ATE 23482		598472	0		278x10,9 (9)	● 197013														
			JAT(+)	R	05/02-06/06	ATE 24137		598783	0		278x10,9 (9)	● 197013														
			JA(+)	R	05/02-06/06	ATE 24137		598783	0		278x11 (9)	186844														
			JA(+)	R	05/02-06/06	ATE 23482		598472	0		278x11 (9)	186844														
Tourneo Connect (2006>)																										
1.8TDCi			F	06/06→	ATE 23440		598639	0		278x24 (22)	186748															
			R	06/06→	ATE 23482		598472	0		278x10,9 (9)	● 197013															
			R	06/06→	ATE 24137		598783	0		278x10,9 (9)	● 197013															
			R	06/06→	ATE 23482		598472	0		278x11 (9)	186844															
			R	06/06→	ATE 24137		598783	0		278x11 (9)	186844															

































FORD (.../...)										
Transit (78>85)										
1.6, 2.0, 2.4D	FT100, FT100L, FT120	F	01/78→12/85	AP 20894		* 598391	2		270x14,3 (12,9)	* 186169
2.0, 2.4D	FT130, FT160, FT190	F	01/78→12/85	AP 20359		598129	4(B)		270x24	
Transit (85>91)										
1.6, 1.6 100, 1.6 80, 2.0 100, 2.0 120 2.5D 100, 2.5D 120, 2.5D 80, 2.9i 100 V6		F	10/85→12/91	BDX 21141		598032	0		254x14,3 (12,9)	* 186168
2.0 100L, 2.0 130, 2.0 160, 2.0 190 2.0i 100L, 2.5D 100L, 2.5D 130, 2.5D 160 2.5D 190, 2.9i 150 V6, 2.9i 160 V6 2.9i 190 V6		F	10/85→12/91	AP 20359		598129	4(B)		270x14,3 (12,9)	* 186169
2.9i 150 V6, 2.9i 160 V6, 2.9i 190 V6		F	04/89→12/91						270x14,3 (12,9)	* 186169
Transit (91>94)										
2.0, 2.0i, 2.5D, 2.5TD	☉ 14"	F	06/91→08/94	BDX 21470		598036	0		254x24,5 (22,2)	186278 186939
2.0, 2.5D, 2.5TD, 2.9i V6	☉ 15"	F	08/91→08/94	BDX 21469		598037	0		270x24 (22,2)	* 186537
Transit (94>99)										
2.0i, 2.0i GPL, 2.5D, 2.5TD	☉ 14"	F	09/94→12/99	BDX 21470		598036	0		254x24,5 (22,2)	186278 186939
	☉ 15"	F	09/94→12/99	BDX 21469		598037	0		270x24 (22,2)	* 186537
Transit (2000>2006)										
2.0TDci, 2.0TDdi		F	08/00→12/06	BOS 23577		598547	0		276x24 (22,1)	186709
2.3i, 2.3i GPL, 2.4TDCi, 2.4TDi, 2.4TDdi		F	01/00→12/06	BOS 23577		598432	2		294x24 (22,1)	186710
Transit (2006>)										
2.2TDCi, 2.2TDCi 110 2.2TDCi 130, 2.2TDCi 85	260, 280, 300	F	04/06→	BOS 29818		598818	0		280x28 (25)	● 197249
2.2TDCi, 2.2TDCi 110 2.2TDCi 130, 2.3i, 3.2TDCi	330, 350	F	04/06→	BOS 29816		598816	0		300x28 (25)	● 197054
2.4TDCi 100 eng PHFA 2.4TDCi 115 eng JXFA 2.4TDCi 140 eng HPFB	330, 350	F	04/06→	BOS 29816		598816	0		300x28 (25)	● 197054
2.4TDCi 100 eng PHFB 2.4TDCi 120 eng JXFB 2.4TDCi 140 eng H9FC	330, 350	F	04/06→	BOS 29816		598816	0			





















































																				
FORD  (.../...)																				
Transit (2006>) (.../...)																				
2.2TDCi	260, 280, 300, 330, 350	R	04/06→	BOS 24486		541736	2													
2.2TDCi 110																				
2.2TDCi 130																				
2.2TDCi 85																				
2.3i, 2.4TDCi 100 eng PHFA	330, 350	R	04/06→	BOS 24486		541736	2		280x16	(15)	●	187152								
2.4TDCi 115 eng JXFA																				
2.4TDCi 140 eng HPFB, 3.2TDCi																				
2.4TDCi 100 eng PHFB	260, 280, 300, 330, 350	R	04/06→	BOS 24486		541736	2													
2.4TDCi 120 eng JXFB																				
2.4TDCi 140 eng H9FC																				
Transit Connect (2002>2006)																				
1.8TDCi, 1.8TDdi, 1.8i		F	05/02→06/06	ATE 23440		598639	0		278x24	(22)		186748								
		JAT(+)	R	05/02→06/06	ATE 23482		598472	0		278x10,9	(9)	●	197013							
		JAT(+)	R	05/02→06/06	ATE 24137		598783	0		278x10,9	(9)	●	197013							
		JA(+)	R	05/02→06/06	ATE 23482		598472	0		278x11	(9)		186844							
		JA(+)	R	05/02→06/06	ATE 24137		598783	0		278x11	(9)		186844							
Transit Connect (2006>)																				
1.8TDCi		F	06/06→	ATE 23440		598639	0		278x24	(22)		186748								
		ABS(+)	JAT(+)	R	06/06→	ATE 23482		598472	0		278x10,9	(9)	●	197013						
		ABS(+)	JAT(+)	R	06/06→	ATE 24137		598783	0		278x10,9	(9)	●	197013						
		ABS(+)	JA(+)	R	06/06→	ATE 23482		598472	0		278x11	(9)		186844						
		ABS(+)	JA(+)	R	06/06→	ATE 24137		598783	0		278x11	(9)		186844						
FSO POLSKI 																				
125 (71>92)																				
1.3, 1.5		F	1971→1992	BDX 20647		* 598603	0		227,5x10,8	(9)		186151								
		R	1971→1992	BDX 20647		598088	0		227,5x10,8	(9)		186151								
Atou (95>97)																				
1.4i, 1.6i		F	10/95→12/97	LUC 21105		598095	1		227,5x10,8	(9)		186151								





























































			R P F		WVA		Valeo		Valeo		Valeo	
FSO POLSKI  (.../...)												
Caro (91>99)												
1.4i, 1.5, 1.5i, 1.6, 1.6i, 1.9D	F	07/91→12/99	BDX 20647		* 598603	0		227,5x10,8 (9)	186151			
	F	07/91→12/99	LUC 21105		598095	1		227,5x10,8 (9)	186151			
Celina (95>98)												
1.6i	F	10/95→06/98	LUC 21105		598095	1		227,5x10,8 (9)	186151			
Polonez (78>92)												
1.3, 1.5, 1.6	F	11/78→1992	BDX 20647		* 598603	0		227,5x10,8 (9)	186151			
	R	11/78→1992	BDX 20647		598088	0		227,5x10,8 (9)	186151			
FSO POLSKI 												
Truck (92>)												
1.6, 1.6i, 1.9D	F	07/92→	BDX 20647		* 598603	0		227,5x10,8 (9)	186151			
GALLOPER 												
Galopper (98>)												
2.5TDi, 3.0i V6	ABS(-)	F	02/98→	SUM 23518		598504	2		277x22 (20,4)	* 186653		
	ABS(+)	F	02/98→	SUM 23518		598504	2		277x22			
Santamo (98>)												
2.0i		F	11/98→	SUM 21647		598625	0		256x24 (22,4)	186648		
	ABS(+)	R	11/98→	AKE 21706		598834	2		262x10			
HONDA 												
CR-V (97>2002)												
2.0i	F	01/97→02/02	AKE 21651		598627	0		282x23 (21)	186778			
CR-V (2002>2006)												
2.0i VTEC, 2.2iCTDi	F	03/02→12/06	AKE 23868		598757	2		282x23				
2.0i VTEC	R	03/02→12/04	AKE 21719		598682	2		281,6x9				
	R	01/05→12/06	AKE 21719		598682	2		304,5x9 (7,5)	● 197102			
2.2iCTDi	R	03/05→12/06	AKE 23736		● 601043	2		304,5x9 (7,5)	● 197102			
CR-V (2006>)												
2.0i-VTEC, 2.2i-CTDi	F	12/06→	BOS 29901		● 598901	2		293x28 (26)	● 197186			
												

















															
HONDA  (.../...)															
CR-V (2006>) (.../...)															
2.0i-VTEC, 2.2i-CTDi (...)		R	12/06→	BOS 24635		● 601038	2				304,4x9				
HONDA 															
Accord I (SJ/SY) (76>83)															
1.6 		F	05/76→09/81								231x12				
		F	08/79→09/81	SUM 20895		598131	2				231x12				
1.6 		F	09/81→09/83								231x17				
		F	09/81→09/83	SUM 20895		598131	2				231x17				
Accord II (AC/AD) (83>85)															
1.6, 1.8 		F	09/83→09/85	AKE 21012		598052	2				242x19				
1.8 		ABS(+)	R	09/83→09/85							239x10				
Accord III (85>89)															
1.6 		F	10/85→08/89								242x19				
2.0, 2.0i 		F	10/85→06/88								242x19				
		F	07/88→08/89	AKE 21880		598056	2				262x21				
2.0i 		R	10/85→08/89								238,5x10 (8)			186435	
Accord IV (89>93)															
1.8, 2.0, 2.0i		F	09/89→1993								260x23 (21)			* 186436	
		F	09/89→1993	AKE 21497		598788	2				260x23 (21)			* 186436	
2.2i		F	09/89→1993								282x23 (21)			186439	
2.0, 2.0i, 2.2i		ABS(+)	R	09/89→1993	AKE 21719		598682	2			260x10				
Accord V (CC) (93>95)															
1.8i, 2.0i		F	03/93→06/95								260x23 (21)			* 186436	
		F	03/93→06/95	AKE 21880		598056	2				260x23 (21)			* 186436	
2.0i, 2.3i		F	03/93→06/95								282x23 (21)			186439	
		F	03/93→06/95	AKE 21651		598627	0				282x23 (21)			186439	
1.8i, 2.0i, 2.3i		R	03/93→06/95	AKE 21719		598682	2				260x10				

															
HONDA  (.../...)															
Accord V (CE/CF) (95>98)															
1.8i, 2.0i, 2.2i	F	07/95→08/98								282x23 (21)	186439				
	F	07/95→08/98	AKE 21651		598627	0				282x23 (21)	186439				
1.8i, 2.0TDi, 2.0i	F	07/95→08/98								260x23 (21)	* 186436				
	F	07/95→08/98	AKE 21880		598056	2				260x23 (21)	* 186436				
1.8i, 2.0TDi, 2.0i, 2.2i	R	07/95→08/98	AKE 21719		598682	2				260x10					
Accord VI (CCG/CH) (98>2003)															
1.6i	F	09/98→01/03	LUC 23097		598435	0				260x23 (21)	* 186699				
1.8i, 2.0TD, 2.0i	F	09/98→01/03	LUC 23095		598436	2				282x25 (23)	186780				
2.3i	F	11/00→01/03	LUC 23095		598436	2				282x25 (23)	● 197154				
2.2i Type R	F	09/98→01/03	AKE 21651		598627	0				300x28					
1.8i, 2.0TD, 2.0i	R	09/98→01/03	LUC 23527		598758	2				260x10 (8)	● 197015				
2.2i Type R, 2.3i	R	09/98→01/03	LUC 23527		598758	2				260x10					
Accord VII (CL/CM) (2003>2008)															
2.0i, 2.4i 	F	02/03→05/08	ATE 23719		598824	2				280x25 (23)	● 197153				
2.0i, 2.2i-CDTi, 2.4i 	F	02/03→05/08	ATE 23719		598824	2				300x25 (23)	● 197145				
2.0i, 2.2i-CDTi, 2.4i 	R		AKE 21719		598682	2				260x10					
2.0i, 2.2i-CDTi, 2.4i 	R														
Accord Aerodeck (CA) (85>89)															
2.0, 2.0i	F	10/85→06/87								242x19					
	F	07/87→06/88								262x21 (19)	186234				
	F	07/88→08/89	AKE 21880		598056	2				262x21 (19)	186234				
2.0i	R	10/85→08/89								238,5x10 (8)	186435				
Accord Aerodeck (CB) (90>93)															
2.0i, 2.2i	F	07/90→08/93	AKE 21651		598627	0				282x23 (21)	186439				
2.2i	R	07/90→06/91	AKE 21719		598682	2				260x10					
2.0i, 2.2i	R	07/91→08/93	AKE 21719		● 598911	2				260x10					









































															
HONDA  (.../...)															
Accord Aerodeck (CE) (93>97)															
2.0i, 2.2i	F	09/93-12/97	AKE 21651		598627	0		282x23 (21)	186439						
	R	09/93-12/97	AKE 21719		598682	2		260x10							
Accord coupe (CC1) (91>93)															
2.0i	F	07/91-08/93	AKE 21497		598788	2		260x23 (21)	* 186436						
	R	07/91-08/93	AKE 21719		598682	2		260x10							
Accord coupe (CD) (93>97)															
2.2i EX	F	06/95-09/97	AKE 21497		598788	2		260x23 (21)	* 186436						
2.0i, 2.2i, ES, LS	F	09/93-09/97	AKE 21651		598627	0		282x23 (21)	186439						
2.0i, 2.2i, ES, EX, LS	R	09/93-09/97	AKE 21719		598682	2		260x10							
Accord coupe (CCG) (97>2002)															
2.3i VTI	F	10/97-06/99						260x23							
2.0i	F	06/98-06/02	AKE 21651		598627	0		281,5x28							
3.0i V6	F	10/97-06/02	AKE 21651		598627	0		282x28							
2.0i, 2.3i VTI	R	10/97-06/02	AKE 21719		598682	2		260x9							
3.0i V6	R	10/97-06/02	AKE 21719		598682	2		281,5x9							
Ballade (80>83)															
1.3 CVCC, 1.5 CVCC	F	1980-1983	SUM 20731		598185	0		215x11							
Ballade (83>90)															
1.3, 1.5	F	1983-1986	SUM 20895		598131	2		231x12 (10)	* 186232						
1.5	F	03/86-1990	SUM 20895		598131	2		231x17							
Civic I (SL/SS/SP/NC) (72>83)															
1.5 CVCC 	F	01/72-08/79						226,5x9							
1.2, 	F	09/75-07/79						226,5x9							
1.3 	F	08/79-08/83	SUM 20731		598185	0		215x11							
1.3 	F	08/79-08/83						231x12							
Civic II (AJ/AH/AK) (83>87)															
1.2, 1.3	F	09/83-08/87	AKE 20959		598047	2		231x12 (10)	* 186232						













































			R P F		2+2		WVA		Valeo		Valeo		Valeo		
HONDA  (.../...)															
Civic II (AJ/AH/AK) (83>87) (.../...)															
1.2, 1.3, 1.5	F	09/83→08/87	SUM 20895		598131	2		231x12 (10)	* 186232						
1.5i GT	F	09/83→08/87	SUM 20895		598131	2		231x17							
Civic III (EC/ED/EE) (87>91)															
1.2, 1.3	F	09/87→1991	AKE 20959		598047	2		231x12 (10)	* 186232						
1.4	F	09/87→1991	AKE 20959		598047	2		231x17							
1.2, 1.4, 1.5i	F	09/87→08/91						242x19 (17)	* 186431						
1.5i, 1.6i 4WD 16V	F	09/87→08/91	AKE 21322		598248	2		242x19 (17)	* 186431						
1.6i 16V	F	09/87→1991	AKE 21322		598248	2		242x19 (17)	* 186431						
1.6i 16V VTEC	F	08/89→1991	AKE 20959		598047	2		262x21 (19)	186438						
1.5i, 1.6i 16V	R	09/87→08/91	AKE 21312		598053	2		238,5x10 (8)	186435						
1.6i 16V, 1.6i 16V VTEC	R	09/87→08/91						238,5x10 (8)	186435						
Civic IV (EG/EH/EJ) (91>95)															
1.3 	F	09/91→09/95	AKE 20959		598047	2		231x17							
1.3, 1.5i, 1.6i 	F	09/91→09/95	SUM 21697		598495	2		240x21 (19)	186433						
1.6i, 1.6i 16V, 1.6i 4WD, EX, RTSi, VTI 	F	09/91→09/95	SUM 21694		598494	0		262x21 (19)	186438						
1.6i, 1.6i 16V, ESI, EX, VTI  ABS(+)	R	09/91→09/95						238,5x9 (8)	* 186432						
Civic V (MA/MB) (95>2001)															
1.4i, 1.5i, 1.6i 	F	01/95→03/01	LUC 21515		598022	2		262x21 (19)	186438						
2.0TDi 	F	07/96→03/01	LUC 21515		598022	2									
1.8i 	F	07/96→03/01	AKE 21651		598627	0		261x22							
1.4i, 1.5i, 1.6i, 2.0TDi 	R	01/95→03/01	AKE 21312		598053	2		238,5x10 (8)	186435						
1.8i 	R	07/96→03/01	AKE 21719		598682	2		260x10							
Civic V (EJ*) (96>2000)															
1.6i (eng 77KW) D16Y7 	F	03/96→03/00	SUM 21694		598494	0		240x21 (19)	186433						
1.6i (eng 84KW) D16Y6 	F	03/96→03/00						240x21 (19)	186433						
1.6i (eng 92KW) D16Y8 	F	03/96→03/00	SUM 21694		598494	0		262x21 (19)	186438						

									
HONDA (../...)									
Civic V (EJ/EK) (95>2001)									
1.4i 	F	10/95→03/01	SUM 21697 	598495	2		240x21 (19)	186433	
1.5i, 1.6i 	F	10/95→03/01	SUM 21694 	598494	0		262x21 (19)	186438	
1.6i 	R	10/95→09/97	AKE 21738 	598437	2		238,5x9 (8)	* 186432	
	R	09/97→03/01					238,5x9 (8)	* 186432	
Civic (EP) (2001>2006)									
1.7CTDi 	F	04/02→06/06					260x23		
1.3i, 1.4i (4 doors) 	F	07/03→06/05					262x21 (19)	186438	
1.4i, 1.4i Sport, 1.6i VTEC 	F	04/01→06/06	SUM 21694 	598494	0		262x21 (19)	186438	
	F	04/01→06/06	LUC 21515 	598022	2		262x21 (19)	186438	
1.7i, 1.7i VTEC 	F	04/01→06/06	SUM 21694 	598494	0		262x21 (19)	186438	
	F	04/01→06/06					262x21 (19)	186438	
2.0i VTEC S (118KW) 	F	09/03→06/06					282x23		
2.0i VTEC Type-R (147KW) 	F	09/01→06/06	AKE 29907 	● 598907	2		300x25 (23)	● 197144	
	F	01/03→06/06					300x25 (23)	● 197144	
1.3i, 1.4i (4 doors) 	R	07/03→06/05	AKE 21651 	598627	0		260x9 (8)	● 197014	
1.7i, 1.7i VTEC 	R	04/01→06/06	AKE 21719 	598682	2		260x9 (8)	● 197014	
1.4i, 1.4i Sport (3/5 doors) 	R	04/01→06/06	AKE 21719 	598682	2		260x10 (8)	● 197103	
1.7CTDi 	R	04/02→06/06	AKE 21719 	598682	2		260x10 (8)	● 197103	
1.6i VTEC 	R	04/01→06/06	AKE 21719 	598682	2		260x10 (8)	● 197103	
2.0i VTEC S (118KW) 	R	09/03→06/06					260x10 (8)	● 197104	
2.0i VTEC Type-R (147KW) 	R	09/01→06/06	AKE 21719 	598682	2				
	R	01/03→06/06					260x10 (8)	● 197104	
Civic (FK/FD) (2006>)									
1.3i-VTEC IMA	F	01/06→06/09	SUM 21694 	598494	0		262x21		
1.4i, 1.8i, 1.8i-VTEC, 2.2i-CTDi, 2.2iCDTi	F	01/06→	SUM 24087	598803	2		282x23		











































																				
HONDA  (.../...)																				
Civic (FK/FD) (2006>) (.../...)																				
1.6i-VTEC	F	01/06→06/09																		
2.0i-VTEC	F	01/07→	AKE 29907		● 598907	2														
1.3i-VTEC IMA, 1.6i-VTEC	R	01/06→06/09	AKE 21719		598682	2														
1.4i, 2.2i-CTDi, 2.2iCDTi	R	01/06→	LUC 24086		598849	2														
1.8i, 1.8i-VTEC, 2.0i-VTEC	R	01/06→	LUC 24086		598849	2														
Civic Aerodeck (MB/MC) (97>2001)																				
1.4i, 1.5i VTEC, 1.6i	F	09/97→03/01	LUC 21515		598022	2														
1.8i	F	09/97→03/01	AKE 21651		598627	0														
1.4i, 1.5i VTEC, 1.6i	ABS(+)	R	09/97→03/01	AKE 21312		598053	2													
1.8i	R	09/97→03/01	AKE 21719		598682	2														
Civic Shuttle (83>87)																				
1.5	F	09/83→08/87																		
Civic Shuttle (EE)(87>92)																				
1.4	F	11/87→09/91																		
1.5i, 1.6i	F	09/87→1992	AKE 21322		598248	2														
Concerto (89>96)																				
1.4, 1.5i, 1.6, 1.6i	F	10/89→09/95	LUC 21515		598022	2														
1.6, 1.6i	R	10/89→09/94	AKE 21312		598053	2														
CRX (83>88)																				
1.5i	F	09/83→08/87	SUM 20895		598131	2														
1.6i	F	03/86→07/88																		
CRX (EE/ED) (87>92)																				
1.4	F	09/89→02/92	AKE 21322		598248	2														
1.6i (eng 82KW 96KW)	F	09/87→02/92	AKE 21322		598248	2														
1.6i (eng 109KW)	F	08/89→02/92	AKE 20959		598047	2														
1.4	R	09/89→02/92	AKE 21312		598053	2														











































															
HONDA (.../...)															
CRX (87>92) (.../...)															
1.6i (eng 82KW 96KW)	R	09/87→02/92	AKE 21312		598053	2		238,5x10 (8)	186435						
1.6i (eng 109KW)	R	08/89→02/92						238,5x10 (8)	186435						
CRX (EG/EH) (92>98)															
1.6i 	F	03/92→12/98	SUM 21694		598494	0		262x21 (19)	186438						
	R	03/92→12/98	AKE 21738		598437	2		238,5x9 (8)	* 186432						
FR-V (2004>2007)															
1.7i VTEC, 2.0i VTEC	F	10/04→01/07	SUM 23722		● 598887	2		282x23							
2.2i-CDTi	F	07/05→01/07	SUM 23722		● 598887	2		281x25							
1.7i VTEC, 2.0i VTEC, 2.2i-CDTi	R	10/04→01/07	AKE 23736		● 601043	2		281,5x12							
FR-V (2007>2010)															
1.8i-VTEC	F	02/07→04/10	SUM 23722		● 598887	2		282x23							
2.2i-CDTi	F	02/07→04/10	SUM 23722		● 598887	2		281x25							
1.8i-VTEC, 2.2i-CDTi	R	02/07→04/10	AKE 23736		● 601043	2		281,5x12							
HR-V (GH) (98>2005)															
1.6i, 1.6i VTEC	F	10/98→09/05	AKE 21651		598627	0		282x23 (21)	186778						
Insight (2000>2006)															
1.0i VTEC	F	03/00→05/06						231x17							
Integra (DA) (85>89)															
1.5, 1.6i 	F	03/85→11/89						242x19 (17)	* 186431						
1.6i 	R	03/85→07/87	AKE 21312		598053	2		238,5x10 (8)	186435						
	R	08/87→11/89						238,5x10 (8)	186435						
Integra (DC) (97>2001)															
1.8i 	F	11/97→08/01	AKE 21651		598627	0		282x23 (21)	186778						
	R	11/97→08/01	AKE 21719		598682	2		282x21							
Jazz II (J) (2002>2008)															
1.2i, 1.4i	F	01/02→10/08	SUM 21697		598760	2(B)		240x21 (19)	186866						











































											
HONDA  (.../...)											
Legend (HA3/4) (85>90)											
2.5 	F	11/85→09/87	LUC 21245 	598227	1		285x21 (19)	* 186235			
2.7 	F	09/87→09/90					285x21 (19)	* 186235			
2.7 	F	09/87→09/90					282x21				
2.5 	R	11/85→09/87					260x10				
2.7 	R	09/87→09/88					260x10				
	R	09/88→09/90	AKE 21719 	● 598911	2		260x10				
2.7 	R	09/87→09/90	AKE 21719 	● 598911	2		260x10				
Legend (KD7/8) (90>96)											
3.2i 	F	10/90→02/96	AKE 21651 	598627	0		282x23 (21)	186778			
	R	10/90→02/96	AKE 21719 	598682	2		282x9				
Legend (KA9) (96>2006)											
3.5i V6	F	03/96→09/98	AKE 21651 	598627	0		282x23 (21)	186778			
	F	09/98→08/06	SUM 23722 	● 598887	2		282x23 (21)	186778			
	F	09/99→08/06						282x23 (21)	186778		
	R	03/96→08/06	AKE 21719 	598682	2		282x				
Logo (GA) (98>2001)											
1.3i	F	12/98→04/01	SUM 21697 	598760	2(B)		240x21 (19)	● 197146			
NSX (NA) (89>2001)											
3.0 V6	F	03/89→06/96	AKE 21651 	598627	0		282x23				
3.0 V6, 3.2 V6	F	06/94→06/01					282x23				
	R	03/89→06/01					281x21				
NSX (2001>2005)											
3.0 V6, 3.2 V6	F	07/01→12/05									
	R	07/01→12/05									
Odyssey (RA) (97>)											
2.2i	F	07/97→	AKE 21651 	598627	0		282x23 (21)	186778			

																	
HONDA  (.../...)																	
Odyssey (RA) (97>) (.../...)																	
2.2i (...)		R	07/97→	AKE 21719 	598682	2		282x9									
		P	07/97→		564016												
Prelude (SN) (79>82)																	
1.6			0C1999999	F 08/79→	SUM 20735 	* 598208	0		231x12								
			0C200001	F →10/82	SUM 20735 	* 598208	0		231x17								
Prelude (AB/BA) (82>87)																	
1.8		F	11/82→09/87	AKE 20959 	598047	2											
2.0i		F	09/85→09/87						262x21 (19)	186234							
1.8, 2.0i		R	11/82→09/87	AKE 21312 	598053	2		239x10									
Prelude (BA) (87>91)																	
2.0, 2.0i		F	09/87→09/91	AKE 21880 	598056	2		242x19									
		F	09/87→09/91	AKE 21322 	598248	2		242x19									
		F	09/87→09/91	AKE 21880 	598056	2		262x21 (19)	186234								
		F	09/87→09/91	AKE 21322 	598248	2		262x21 (19)	186234								
2.0i		F	09/87→1988						262x21 (19)	186234							
2.0, 2.0i		R	09/87→09/91						238,5x10 (8)	186435							
2.0i		R	09/87→1988						239x10								
Prelude (BB*) (91>96)																	
2.0i		F	10/91→09/96	AKE 21880 	598056	2		260x23 (21)	* 186699								
2.2i, 2.3i		F	10/91→09/96	AKE 21651 	598627	0		282x23									
2.0i, 2.2i, 2.3i		R	10/91→09/96	AKE 21719 	● 598911	2		260x10									
Prelude (BB*) (96>2001)																	
2.0i, 2.2i		F	10/96→09/01	AKE 21880 	598056	2		260x23 (21)	* 186699								
2.2i VTEC		F	10/96→03/01	AKE 21651 	598627	0		282x23 (21)	186778								
2.0i, 2.2i		R	10/96→09/01	AKE 21719 	598682	2		260x9									
2.2i VTEC		R	10/96→03/01	AKE 21719 	598682	2		272x16									

																		
HONDA  (.../...)																		
Quintet (SU) 80>84																		
1.6	F	01/80→1984	SUM 20735		* 598208	0		231x12										
S2000 (AP) (99>2004)																		
2.0i VTEC	F	04/99→02/04	AKE 29907		● 598907	2		300x25										
	R	04/99→02/04	AKE 21719		598682	2		282x12										
S2000 (2004>2009)																		
2.0i VTEC	F	03/04→06/09						300x25										
	R	03/04→06/09	AKE 21719		598682	2		282x12										
Shuttle (RA) (94>2000)																		
2.2i, 2.3i	F	12/94→10/00	AKE 21651		598627	0		282x23 (21)	186778									
	R	12/94→10/00	AKE 21719		598682	2		282x9										
	P	12/94→10/00			564016													
Stream (2001>2005)																		
1.7i VTEC, 2.0i VTEC	F	03/01→09/05	SUM 23722		● 598887	2		282x23										
1.7i VTEC	R	03/01→09/05	AKE 21719		598682	2		282x12										
2.0i VTEC	R	03/01→09/05	AKE 21719		598682	2		281,5x12										
HYUNDAI 																		
Gallopier (97>2002)																		
2.5TCi, 2.5TD, 2.5TDi, 3.0i V6	ABS(-)	F	10/97→06/02	SUM 23518		598504	2		277x22 (20,4)	* 186653								
2.5TCi, 2.5TD, 3.0i V6	ABS(+)	F	10/97→06/02	SUM 23518		598504	2		277x22									
Santa Fé (2000>2006)																		
2.0CRDi 16V, 2.0i 16V, 2.4i 16V	F	08/00→02/06	AKE 23569		598505	2												
2.0CRDi 4x4 16V, 2.4i 4x4 16V 2.7i 4x4 V6 24V	F	08/00→02/06	AKE 23569		598505	2		294x26 (24,4)	186824									
2.0CRDi 16V, 2.0CRDi 4x4 16V, 2.0i 16V 2.4i 16V, 2.4i 4x4 16V, 2.7i 4x4 V6 24V	R	08/00→02/06	MDO 23543		598748	2		284x10 (8,4)	● 197027									
Santa Fé (2006>)																		
2.2CRDi, 2.7i V6	F	03/06→	MDO 24351		● 598937	2		320,5x27,5										
	R	03/06→	MDO 24464		● 598932	2		302x11										

																	
HYUNDAI  (.../...)																	
Santamo (98>2001)																	
2.0i	F	07/98-12/01	SUM 21647		598625	0		256x24 (22,4)	186648								
	R	07/98-12/01	AKE 21706		598834	2		262x10									
Terracan (2001>2002)																	
2.5TD, 2.9CRDi, 3.5i V6	F	05/01-02/02	LUC 20789		598506	0		280x27									
	R	05/01-02/02						315x20									
Terracan (2002>2007)																	
2.9CRDi, 3.5i V6	F	03/02-12/03	LUC 20789		598506	0		280x27									
	F	12/03-07/07	LUC 20789		598506	0		303x28									
	R	03/02-07/07						315x20									
Tucson (2004>)																	
2.0CRDi 16V, 2.0CRDi 2WD 16V, 2.0CRDi 4WD 16V 2.0i 2WD 16V, 2.0i 4WD 16V, 2.7i 4WD V6 24V	F	07/04→	MDO 23891		598744	2		280x26									
	R	07/04→	MDO 23543		598748	2		262x10 (8,4)	● 197121								
	R	07/04→	MDO 23543		598748	2		284x10 (8,4)	● 197027								
HYUNDAI 																	
Accent (94>99)																	
1.3i, 1.5i	F	07/94-09/99	AKE 21012		598052	2		242x19,1 (17,7)	* 186441								
Accent (99>2003)																	
1.3i, 1.5CRDi, 1.5i	F	10/99-01/03	AKE 21012		598052	2		241x19 (17)	● 197173								
Accent (2003>)																	
1.3i, 1.5CRDi, 1.6i	F	02/03→	AKE 21012		598052	2		241x19 (17)	● 197173								
Accent TR (2005>)																	
1.4i, 1.5CRDi, 1.6i	F	12/05→	MDO 24317		598868	2		256x22									
	R	12/05→	MDO 24320		598867	2		262x10 (8,4)	● 197029								
Amica (2000>2001)																	
1.0i	F	02/00-06/01	AKE 23238		598575	2		230x11									
	F	02/00-07/01	MDO 24277		598708	2		230x11									















































			 		 WVA		 Valeo		 Valeo		 Valeo		 Valeo	
HYUNDAI  (.../...)														
Amica (2001>2003)														
1.0i	F	07/01→12/03	MDO 24277		598708	2		230x11						
Atos/Atoz (98>2001)														
1.0i	F	01/98→06/01	AKE 23238		598575	2		230x11 (9,4)	186777					
	F	05/98→06/01	MDO 24277		598708	2		230x11 (9,4)	186777					
	F	12/98→06/01	MDO 24277		598708	2		230x11						
Atos (2001>2004)														
1.0i	F	07/01→06/04	MDO 24277		598708	2		230x11						
Atos (2004>)														
1.1i	F	07/04→	AKE 23238		598575	2		234x18						
Atos Prime (99>2001)														
1.0i	F	12/99→06/01	AKE 23238		598575	2		230x11						
	F	12/99→06/01	MDO 24277		598708	2		230x11						
Atos Prime (2001>2004)														
1.0i	F	07/01→06/04	MDO 24277		598708	2		230x11						
Atos Prime (2004>)														
1.1i	F	07/04→	AKE 23238		598575	2		234x18						
Coupe (95>2001)														
1.6i, 2.0i	F	05/96→08/98	AKE 21727		598574	2		257x22 (20)	186617					
	F	08/98→12/01	AKE 21727		598574	2		257x24 (22,4)	186823					
	R	05/96→12/01	SUM 21553		598817	2		258x10 (8)	197120					
Coupe (2002>2006)														
1.6i, 2.0i, 2.7i V6	F	01/02→12/06	MDO 23891		598744	2		280x26						
	R	01/02→12/06	SUM 21553		598817	2		258x10						
Elantra (90>95)														
1.5	F	12/90→05/95	AKE 21012		598052	2		242x19						
1.6, 1.8	F	12/90→05/95	AKE 21725		598051	2		257x22 (20)	186617					
1.5, 1.6, 1.8	R	12/90→05/95						258x10						































								
HYUNDAI  (.../...)								
Elantra (95>2000)								
1.6i	F	05/95→03/97	AKE 21725 	598051	2	 257x22 (20)	186617	
	F	03/97→04/98	AKE 21727 	598574	2	 257x22 (20)	186617	
	F	04/98→05/00	AKE 21727 	598574	2	 257x24 (22,4)	186823	
1.8i, 2.0i	F	05/95→04/98	AKE 21727 	598574	2	 257x22 (20)	186617	
	F	04/98→05/00	AKE 21727 	598574	2	 257x24 (22,4)	186823	
1.6i, 1.8i, 2.0i	R	05/95→05/00	SUM 21553 	598817	2	 258x10 (8)	● 197120	
Elantra (2000>2007)								
1.6i, 2.0CRDi, 2.0i	F	06/00→09/01	AKE 21727 	598574	2	 257x24 (22,4)	186825	
	F	06/00→06/03	MDO 24031 	598781	2	 257x24 (22,4)	186825	
	ABS(-)	F	06/03→01/07	MDO 24031 	598781	2	 280x26 (24,4)	186829
	ABS(+)	F	06/03→01/07	MDO 24369 	598739	2	 280x26 (24,4)	186829
1.8i	F	06/00→06/03	MDO 24031 	598781	2	 257x24 (22,4)	186825	
	F	06/03→08/06	MDO 24031 	598781	2	 280x26 (24,4)	186829	
1.6i, 1.8i, 2.0CRDi, 2.0i	ABS(+)	R	06/00→01/07	SUM 21553 	598817	2	 258x10 (8)	● 197120
Excel (86>89)								
1.3, 1.5	F	1986→10/89	AKE 21012 	598052	2	 242x19,1 (17,7)	* 186441	
Excel (89>94)								
1.3, 1.3i, 1.5, 1.5i	F	08/89→10/94	AKE 21012 	598052	2	 242x19,1 (17,7)	* 186441	
Excel (94>99)								
1.3, 1.5	F	07/94→09/99	AKE 21012 	598052	2	 242x19,1 (17,7)	* 186441	
Getz (2002>2005)								
1.1i, 1.3i, 1.5CRDi, 1.6i	ABS(-)	F	09/02→08/05	AKE 21012 	598052	2	 241x19 (17)	186879
	ABS(+)	F	09/02→08/05	AKE 21012 	598052	2	 256x19 (17)	186878
1.5CRDi	ABS(+)	R	03/03→08/05	MDO 23543 	598748	2	 262x10 (8,4)	● 197029
Getz (2005>)								
1.1i, 1.4i, 1.5CRDi, 1.6i	F	09/05→	AKE 21012 	598052	2	 241x19 (17)	186879	





























HYUNDAI (.../...)						
Getz (2005>) (.../...)						
1.4i, 1.5CRDi, 1.6i	ABS(+)	R 09/05→	MDO 23543	598748	2	262x10 (8,4) ● 197029
Grandeur Azera (2005>)						
2.2CRDi, 3.3 V6		F 04/05→				
		R 04/05→	MDO 23543	598748	2	
i10 (2007>)						
1.1i		F 12/07→	MDO 24275	598707	2	241x18 (16) ● 197096
1.1CRDi, 1.2		F 12/07→	MDO 24275	598707	2	252x18
1.1CRDi, 1.1i, 1.2		R 12/07→	MDO 24276	598706	2	234x10
i20 (2008>)						
1.2i		F 10/08→				256x18
		F 10/08→				256x22
1.4CRDi 75, 1.4CRDi 90, 1.4CRDi VGT 75 1.4CVT, 1.6CRDi 128, 1.6CVT		F 10/08→	MDO 24317	598868	2	256x18
		F 10/08→	MDO 24317	598868	2	256x22
		R 10/08→				262x10 (8,4) ● 197029
i30 (2007>)						
1.4i, 1.6CVT, 2.0CVT	☉ 15"	F 03/07→	MDO 23966	598842	2	280x26 (24,4) ● 197205
1.4i, 1.6CRDi, 1.6CVT, 2.0CRDi 2.0CVT	☉ 16"	F 03/07→	MDO 23966	598842	2	300x28 (26,4) ● 197174
		R 03/07→				262x10 (8) ● 197123
i30 (CZ) (2008>)						
1.4i, 1.6CRDi, 1.6CVT, 2.0CRDi 2.0CVT	☉ 15"	F 11/08→	MDO 23966	598842	2	280x26
	☉ 16"	F 11/08→	MDO 23966	598842	2	300x28 (26,4) ● 197174
		R 11/08→				
Lantra (90>95)						
1.5		F 12/90→05/95	AKE 21012	598052	2	242x19
1.6, 1.8		F 12/90→05/95	AKE 21725	598051	2	257x22 (20) ● 186617

										
HYUNDAI  (.../...)										
Lantra (90>95) (.../...)										
1.5, 1.6, 1.8	ABS(+)	R	05/93-05/95					 258x10		
Lantra (95>2000)										
1.5i  	ABS(-)	F	09/96-07/00	AKE 21012 	598052	2	 242x19			
1.5i, 1.6i, 1.8i  		F	05/95-07/00	AKE 21725 	598051	2	 242x19			
1.5i, 1.6i, 1.8i, 1.9D, 2.0i  	ABS(+)	F	05/95-04/98	AKE 21727 	598574	2	 257x22 (20)	186617		
	ABS(+)	F	04/98-07/00	AKE 21727 	598574	2	 257x24 (22,4)	186823		
	ABS(+)	R	05/95-07/00	SUM 21553 	598817	2	 258x10 (8)	197120		
Matrix (2001>2008)										
1.5CRDi, 1.6i, 1.8i		F	05/01-03/02	AKE 21727 	598574	2	 257x24 (22,4)	186825		
		F	05/01-08/08	MDO 24031 	598781	2	 257x24 (22,4)	186825		
		R	05/01-08/08	MDO 23543 	598748	2	 260x12			
Matrix (2008>)										
1.5CRDi, 1.6i, 1.8i		F	08/08-	MDO 24031 	598781	2	 257x24 (22,4)	186825		
		R	08/08-	MDO 23543 	598748	2	 260x12			
Plaza (98>)										
2.5TD		F	01/98-	MDO 23536 	598908	2				
Pony (82>94)										
1.2, 1.3, 1.3i, 1.4, 1.5, 1.5i		F	1982-10/94	AKE 21012 	598052	2	 242x19,1 (17,7)	* 186441		
Pony (94>99)										
1.3i, 1.5i		F	07/94-12/99	AKE 21012 	598052	2	 242x19,1 (17,7)	* 186441		
Satellite (98>2007)										
2.4i, 2.5TD		F	01/98-10/02	MDO 23536 	598908	2	 254x24			
		F	10/02-12/07	MDO 23536 	598908	2	 274x26			
2.5CRDi		F	02/02-10/02	AKE 23569 	598505	2	 254x24			
		F	10/02-12/03	AKE 23569 	598505	2	 274x26			
		F	12/03-12/07				 274x26			

HYUNDAI (.../...)								
Scoupe (90>96)								
1.5, 1.5i, 1.5i Turbo	F	03/90→05/96	AKE 21012	598052	2		242x19,1 (17,7)	* 186441
1.5, 1.5i	F	01/91→06/92					242x19,1 (17,7)	* 186441
1.5i, 1.5i Turbo	F	06/92→05/96	AKE 21012	598052	2		242x19,1 (17,7)	* 186441
Sonata (88>93)								
1.8, 2.0, 2.4i, 3.0i V6	F	10/88→03/91	AKE 21725	598051	2		257x22 (20)	186440
1.8, 2.0, 2.0i, 3.0i V6	F	03/91→06/93	AKE 21727	598574	2		257x22 (20)	186440
2.0i, 3.0i V6	R	09/90→06/93					263x12	
Sonata (93>98)								
1.8, 2.0, 3.0	F	07/93→10/95	AKE 21725	598051	2		257x22 (20)	186440
	F	10/95→07/98	AKE 21727	598574	2		257x22 (20)	186440
	R	07/93→07/98	AKE 21725	598051	2		263x12	
Sonata (98>2001)								
2.0i, 2.4i, 2.5i V6	F	08/98→06/01	AKE 21727	598574	2		257x24 (22,4)	186823
	R	08/98→06/01	MDO 23543	598748	2		260x12	
Sonata (2001>2005)								
2.0i, 2.7i V6	F	07/01→02/05	MDO 23891	598744	2		280x26 (24,4)	186829
	R	07/01→02/05	MDO 23543	598748	2		260x12	
Sonata (2005>)								
2.4i	F	03/05→12/05	MDO 23891	598744	2			
	F	12/05→01/08						
3.3i V6	F	03/05→01/08						
2.4i	R	03/05→01/08	MDO 23543	598748	2		262x10 (8,4)	● 197121
3.3i V6	R	03/05→01/08	MDO 23543	598748	2		284x10	
Sonica (98>2001)								
2.0i, 2.5i	F	09/98→06/01	AKE 21727	598574	2		257x24 (22,4)	186823
	R	09/98→06/01	MDO 23543	598748	2		260x12	

									
HYUNDAI  (.../...)									
Starex (98>)									
2.4i, 2.5D, 2.5TD	F	01/98→07/01	MDO 23536		● 598908	2		254x24	
	F	07/01→12/07	MDO 23536		● 598908	2		274x26	
2.5CRDi	F	02/02→12/03	AKE 23569		598505	2		274x26	
	F	12/03→12/07						274x26	
Stellar (83>92)									
1.4, 1.6, 2	F	12/83→01/87	LUC 20491		598168	2		247,5x12,7	
1.6, 2	F	01/87→01/92	AKE 21012		598052	2		247,5x12,7	
Tiburon (2002>)									
1.6i, 2.0i, 2.7i V6	F	01/02→	MDO 23891		598744	2		280x26	
	R	01/02→	SUM 21553		598817	2		258x10	
Trajjet (2000>2004)									
2.0CRDi, 2.0i, 2.7i V6	F	01/00→02/04	23569		598759			276x26 (24)	● 197172
	R	01/00→02/04	MDO 23543		598748	2		284x10 (8,4)	● 197027
Trajjet (2004>)									
2.0CRDi, 2.0i, 2.7i V6	F	03/04→	23569		598759			276x26 (24)	● 197172
	R	03/04→	MDO 23543		598748	2		284x10 (8,4)	● 197027
XG (99>2002)									
2.5i V6, 3.0i V6	F	01/99→08/02						271x26	
	R	01/99→08/02	MDO 23543		598748	2		262x10 (8,4)	● 197121
XG (2002>)									
2.5i V6, 3.0i V6, 3.5i V6	F	09/02→	AKE 23569		598505	2		271x26	
	R	09/02→	MDO 23543		598748	2		262x10 (8,4)	● 197121
HYUNDAI 									
H1 (97>)									
2.4i, 2.5TD	F	10/97→02/00	MDO 23536		● 598908	2		254x24	
2.5CRDi, 2.5TD	F	10/01→10/02	MDO 23536		● 598908	2		254x24	
	F	10/02→	AKE 23569		598505	2		274x26	













			 R P F		 WVA			 Valeo		 Valeo		 Valeo		 Valeo		
HYUNDAI  (.../...)																
H100 (93>)																
2.4, 2.5D	F	07/93→	LUC 23081		598634	2		253x20 (18,4)	* 186572							
Highway Van (2000>2004)																
2.0i, 2.7i V6	F	03/00→02/04	23569		598759			276x26 (24)	● 197172							
	R	03/00→02/04	MDO 23543		598748	2		284x10 (8,4)	● 197027							
Jobs (98>)																
2.5TD	F	10/98→	LUC 23081		598634	2		253x20 (18,4)	* 186572							
INFINITI 																
EX (2008>)																
3.5i V6	F	04/08→														
	R	04/08→	AKE 24632		● 601009	1										
3.7i V6	F	04/08→														
	R	04/08→														
FX (2003>)																
3.5i V6, 4.5 V8	F	01/03→	TOK 23834		598918	1										
FX (2008>)																
3.5i V6	F	07/08→	AKE 29738		598738	1										
3.7i V6, 5.0i V8	F	07/08→														
3.5i V6	R	07/08→	AKE 24632		● 601009	1										
3.7i V6, 5.0i V8	R	07/08→														
INNOCENTI 																
Elba (91>97)																
1.3, 1.4ie, 1.5ie, 1.6ie, 1.7D	F	04/91→1997	ATE 21193		598271	2(A)		240,5x12 (10,8)	186157							
Koral (90>)																
0.9, 1.1	F	1990→	BDX 20647		598090	2		227,5x10,8 (9)	186151							
Mini (74>84)																
1, 1.3	F	10/74→12/84	AP 20038		598392	0		213x9,4 (8,6)	186495							
Mini tre (82>93)																
0.5, 0.6 Turbo, 0.9, 0.9 Turbo, 0.9D	F	04/82→01/93	AP 20038		598392	0		213x9,5								

																			
ISUZU 																			
Trooper (81>97)																			
2		F	02/81→12/83																
			01/84→12/86	AKE 20880		598615	0												
2, 2.3, 2.6i, 2.8D, 2.8TD 2.8TDId Intercooler, 2.8i		F	06/87→1992	AKE 21543		598020	4											186488	
3.1TD, 3.2i V6		F	01/92→12/97	AKE 21845		598460	1												
			ABS(+)	01/92→12/97	AKE 21845		598460	1											197223
2.8TD, 2.8TDId Intercooler		R	06/87→1992																
3.1TD, 3.2i V6		R	01/92→12/97	SUM 21875		598507	2											186685	
Trooper (98>)																			
3.0DTI, 3.1TD, 3.2i V6, 3.5i V6		F	01/98→	ABS(-)	AKE 21845		598460	1										197223	
				ABS(+)	AKE 21845		598460	1											
					SUM 21875		598507	2											
IVECO 																			
Daily (78>89)																			
2.4D (2800, 3200)	30-8	F	1978→12/89	AP 20359		598132	2(A)											186614	
			1978→	AP 20359		598129	4(B)											186614	
2.4D	35-8	F	07/83→12/89	AP 20359		598380	2(A)											186170	
2.4D (2800, 3200, 3600)	⊙ 16"35-8, 40-8	F	1978→12/89	BBO 21049		598007	4(B)											186170	
2.4D, 2.4TD (2800, 3200, 3600, 3950)	35-8, 35-10, 40-8	F	1978→12/89	BBO 21049		598596	2(A)											186170	
			1978→12/89	BBO 21049		598139	2(C)											186170	
			1978→12/89	AP 20359		598132	2(A)											186170	
			1978→	AP 20359		598129	4(B)											186170	
2.4TD 4x4, 2.5TD 4x4 (2800, 3200, 3220)	40-10	F	1985→12/89	PER 20784		598369	2												
2.4TD (3200, 3600, 3950)	49-10	F	1985→12/89	PER 20784		598369	2											187029	













IVECO (.../...)





Daily (89>96)



































2.5D	30-8	F	1989→03/96	BBO 29037 	598598	2	 267x14,2 (12,8) * 186614	
2.5D, 2.5TD	⊙ 16"35-8, 35-10, 40-8	F	1989→03/96	AP 20359 	598380	2(A)	 267x14,3 (12,8) 186170	
		F	1989→03/96	BBO 21049 	598596	2(A)	 267x14,3 (12,8) 186170	
2.5TD	49-10	F	1989→03/96	PER 29012	540436	2	 267x14,3 (12,8) 186170	
	35-12, 45-10, 49-10, 49-12	F	1989→03/96	PER 29012	540436	2	 280x16 (14,5) 187029	
2.5TD 4x4	40-10	F	1989→03/96	PER 20784 	598369	2		
2.5TD	49-12	F	1989→03/96	PER 29012	540436	2	 280x22	
	59-12	F	03/90→03/96	PER 29001 	541641	4	 290x25	































Daily (96>99)



























2.5D, 2.8D	30-8	F	04/96→05/99	BBO 21049 	598585	2(D)	 267x14,2 (12,8) * 186614	
		F	04/96→05/99	BBO 29139 	598586	2	 267x14,2 (12,8) * 186614	
2.8TD	30-10	F	04/96→05/99	BBO 29037 	598598	2	 267x14,2 (12,8) * 186614	
2.5D 2.5TD 2.8D 2.8TD	35-8, 35-10, 35-12, 49-10, 49-12	F	04/96→05/99	BBO 29121 	541662	2	 290x22 (20) 187058	
2.8TD 4x4	40-10	F	04/96→05/99	PER 29012	540436	2		
2.5D 2.5TD 2.8D 2.8TD	35-8, 35-10, 35-12, 49-10, 49-12	R	04/96→05/99	BBO 29121 	541662	2	 289x22 (19) 187040	











































Daily (99>)







































2.3TD 2.8D 2.8TD	29L9, 29L10, 29L11, 29L12, 35S9 35S10, 35S11, 35S12, 35S13, 35S15	F	05/99→	BBO 29121 	541717	2	 276x22 (19) ● 187147	
	35C9, 35C10, 35C11, 35C12, 35C13 35C15, 50C11, 50C13, 50C15	F	05/99→	BBO 29121 	541662	2	 290x22 (20) 187058	
2.8TD	65C15	F	05/01→	BBO 29160	541663	2		

																			
IVECO  (.../...)																			
Daily (99>) (.../...)																			
2.3TD	29L9, 29L10, 29L11, 29L12, 35S9	R	05/99→	BBO 29123		541705	2		276x16 (13)	●	187148								
2.8D	35S10, 35S11, 35S12, 35S13																		
2.8TD																			
2.8TD	35S15	R	06/02→	BBO 29123		541705	2		276x16 (13)	●	187149								
2.3TD	35C9, 35C10, 35C11, 35C12, 35C13	R	05/99→	BBO 29121		541662	2		289x22 (19)		187040								
2.8D	35C15, 50C11, 50C13, 50C15																		
2.8TD																			
2.8TD	65C15	R	05/01→	BBO 29121		541662	2		306x22 (19)	●	187130								
Daily (2006>)																			
2.3TD 116	29L12, 35S10, 35S12, 35S14	F	04/06→	BBO 29229		541734	0		300x28 (25)		187154								
2.3TD 136																			
2.3TD 96																			
2.3TD 116	35C10, 35C12, 35C15, 35C18	F	04/06→	BBO 29229		541734	0		290x28 (25)		187155								
2.3TD 96																			
3.0TD 146																			
3.0TD 176																			
2.3TD 116	29L12, 35S10, 35S12, 35S14	R	04/06→	BBO 29123		541705	2		296x16										
2.3TD 136																			
2.3TD 96																			
2.3TD 116	35C10, 35C12, 35C15, 35C18	R	04/06→	BBO 29232		541735	0		296x16										
2.3TD 96																			
3.0TD 146																			
3.0TD 176																			
JAGUAR 																			
S-Type (98>2003)																			
3.0i V6, 4.0i V8		F	10/98→01/02	LUC 23423		598439	0		300x30										
2.5i V6, 3.0i V6, 4.2i V8		F	01/02→12/03	LUC 23423		598439	0		320x30										
4.2i V8 R		F	01/02→12/03						355x32										
2.5i V6, 3.0i V6, 4.0i V8, 4.2i V8		R	10/98→12/03	LUC 23424		598438	0		288x20										
4.2i V8 R		R	01/02→12/03																

		R P F		WVA		Valeo		Valeo		Valeo	
JAGUAR  (.../...)											
S-Type (2004>)											
2.5i V6, 2.7D V6, 3.0i V6, 4.2i V8	F	01/04→	LUC 23423 	598439	0		300x20				
	R	01/04→	LUC 23424 	598438	0		288x20				
4.2i V8 R	F	01/04→									
	R	01/04→					288x20				
Sovereign (94>)											
3.2, 4.0	F	09/94→	ATE 21064 	598440	0		291x28,5				
	R	09/94→	ATE 21353 	598039	0		305x20				
Sovereign (2002>)											
3.0, 3.5 V8, 4.2	F	10/02→	LUC 23423 	598439	0		320x30				
	R	10/02→	LUC 23424 	598438	0		288x20				
XJ (73>86)											
3.4, 4.2i	F	10/73→09/86	LUC 20380 	598374	1		284x24,2				
	R	10/73→09/86					264x13				
XJ (86>94)											
2.9	F	10/86→09/87					295x23				
2.9, 3.2, 4.0	F	09/89→09/94	ATE 21064 	598440	0		291x28				
6.0	F	02/93→09/94					284x24,2				
2.9, 3.2, 3.6, 4.0, 6.0	R	10/86→09/89					278x10				
	R	09/89→09/94					294,5x10				
XJ (94>2002)											
3.2, 4.0, 6.0	F	09/94→10/02	ATE 21064 	598440	0		291x28,5				
	R	09/94→10/02	ATE 21353 	598039	0		305x20				
XJ (2002>)											
3.0 V6, 3.5 V8, 4.2 V8	F	10/02→	LUC 23423 	598439	0						
4.2 Super V8	F	10/02→									
3.0 V6, 3.5 V8, 4.2 V8	R	10/02→	LUC 23424 	598438	0		288x20				

																										
JAGUAR  (.../...)																										
XJ (2002>) (.../...)																										
4.2 Super V8			R	10/02→																						
XJR (88>94)																										
3.6, 4.0				▶  594575			F	11/88→																		
				▶  594576			F	→08/94			ATE 21064		598440	0												
				▶  594575			R	11/88→																		
				▶  594576			R	→08/94																		
XJR (94>)																										
4.0				F			09/94→			ATE 21064		598440	0													
				R			09/94→			ATE 21353		598039	0													
XK (2004>)																										
4.2 V8				F			02/04→10/05			ATE 21064		598440	0													
				R			02/04→10/05																			
XK8 (96>2004)																										
4.0 V8				F			10/96→02/04			ATE 21064		598440	0													
				R			10/96→02/04																			
XK8 (2004>)																										
4.2 V8				F			02/04→06/06			ATE 21064		598440	0													
				R			02/04→06/06																			
X-Type (2001>2008)																										
2.0D, 2.0i V6, 2.5i V6, 3.0i V6				F			02/01→02/08			BOS 23279		598433	0													
				R			02/01→02/08			BOS 23557		598434	0													
JEEP 																										
Cherokee (77>)																										
2.1TD, 2.5i, 4.0i				F			01/88→10/99			KH 21822		598491	0													
4.0i				▶  358321			R	01/93→																		
				▶  358321			R	→10/99			KH 23425		598509	2												



															
JEEP  (.../...)															
Cherokee (2001>)															
2.4i, 2.5CRD, 3.7i V6	F	01/01→	LUC 23638		598414	2		288x28 (26)	●	197252					
Cherokee (2004>)															
2.8CRD, 3.7i V6	F	11/04→						288x28 (26)	●	197252					
	R	11/04→	KH 24036		598755			290x12,5 (11,3)	●	197022					
Commander (2005>)															
3.0CRD Turbo V6, 3.7 V6, 4.7i V8, 5.7i V8	F	09/05→	AKE 24250		598872	2		328x30							
	R	09/05→	KH 24111		● 598920	2		320x14							
Compass (2006>)															
2.0CRD Turbo, 2.4i	F	09/06→						294x26							
	R	09/06→						302x10							
Grand Cherokee (93>2000)															
4.0i, 5.2i	F	01/93→07/00	KH 21822		598491	0		280x25							
		R	01/93→					285x10,9							
		R	→07/00	KH 23425		598509	2		285x10,9						
Grand Cherokee (2000>2003)															
2.7CRD, 4.0i, 4.7i V8	F	08/00→04/03	KH 23631		598510	4		305x26 (24,5)	●	197238					
	F	08/00→04/03	LUC 23638		598414	2		305x26 (24,5)	●	197238					
	F	08/00→04/03	AKE 24083		598833	0		305x26 (24,5)	●	197238					
	R	08/00→04/03	ATE 23339		598677	0		305x10							
Grand Cherokee (2003>2005)															
2.7CRD, 4.0i, 4.7i V8	F	05/03→05/05	AKE 24083		598833	0		305x26 (24,5)	●	197238					
	R	05/03→05/05	ATE 23339		598677	0		305x10							
Grand Cherokee (2005>)															
3.0CRD, 3.7 V6, 4.7i V8, 5.7i V8	F	06/05→	AKE 24250		598872	2		328x30							
6.1i V8	F	06/06→													
3.0CRD, 3.7 V6, 4.7i V8, 5.7i V8	R	06/05→	KH 24111		● 598920	2		320x14							
6.1i V8	R	06/06→													

															
JEEP  (.../...)															
Wrangler (96>2006)															
2.4i Power Tech I-4, 2.5i, 4.0i		F	08/96→08/06									 280x24,5			
2.5i, 4.0i		F	08/96→12/99									 280x25			
2.4i Power Tech I-4, 2.5i, 4.0i		R	08/96→08/06									 290x12,5 (11,3)	● 197022		
Wrangler (2006>)															
2.8CRD, 3.8i V6		F	09/06→	LUC 29924		● 598924	2					 302x28			
		R	09/06→									 316x12			
KIA 															
Retona (99>)															
2.0TCi, 2.0i		F	09/99→	MDO 23442		● 598511	2					 284,5x24 (22,4)	● 197207		
Sorento (2002>2006)															
2.5CRDi		F	04/02→05/06	AKE 24092		● 598654	2					 302x28 (26)	● 197210		
2.4i, 3.5i V6		F	04/02→05/06	AKE 24092		● 598654	2								
2.4i, 2.5CRDi, 3.5i V6		R	04/02→06/05	SUM 23993		● 598823	2					 315x20 (18,4)	● 197209		
		R	06/05→05/06									 315x20 (18,4)	● 197209		
Sorento (2006>)															
2.5CRDi, 3.3i V6		F	06/06→	AKE 24092		● 598654	2					 302x28 (26,4)	● 197204		
		R	06/06→	SUM 23993		● 598823	2					 315x20			
Sportage (93>2002)															
2.0TD, 2.0i, 2.2D		F	07/93→09/02	KH 21892		● 598838	2					 284,5x24 (22,4)	● 197207		
2.0TD, 2.0i		F	10/00→09/02	MDO 23442		● 598511	2					 284,5x24 (22,4)	● 197207		
Sportage (2004>)															
2.0CRDi, 2.0i, 2.7i V6		F	12/04→04/05	MDO 23891		● 598744	2					 280x26			
		F	04/05→									 280x26			
2.0CRDi 4x2, 2.0i 4x2 16V, 2.7i Auto 4x2		R	12/04→	MDO 23543		● 598748	2					 262x10 (8,4)	● 197121		
2.0CRDi 4x4, 2.0i 4x4 16V, 2.7i Auto 4x4		R	12/04→	MDO 23543		● 598748	2					 284x10 (8,4)	● 197027		





KIA

Carens (99>2002)

1.8i	F	12/99→07/02	SUM 23873 	● 598910	2	 258x24		
	R	12/99→07/02	SUM 23455 	598841	2	 261x10		





Carens (2002>2006)

1.6i, 1.8i, 2.0CRDi, 2.0CVT	F	07/02→	MDO 23966 	598842	2	 280x26,3		
	R	07/02→	SUM 23455 	598841	2	 260x10		



Carens (2006>)

2.0CRDi, 2.0CVT	F	06/06→	MDO 24501 	● 598934	1	 280x26,3		
	R	06/06→	MDO 24491 	● 598945	1	 260x10		

Carnival (99>2002)

2.5i V6, 2.9CRDi	F	01/99→05/00	KH 21822 	598491	0	 274x24 (22) ● 197206		
	F	05/00→01/02	SUM 23649 	598821	2	 274x26		





Carnival (2002>2006)

2.5i V6, 2.9CRDi	F	02/02→12/03	SUM 23649 	598821	2	 274x26		
	F	12/03→02/06	SUM 23649 	598821	2	 274x28,3 (26) ● 197211		

Carnival (2006>)

2.7CVT V6, 2.9CRDi	F	03/06→				 300x28		
	R	03/06→				 324x12		



Ceed (2006>)

1.4CVT, 1.6CRDi VGT, 1.6CVT, 2.0CRDi VGT 2.0CVT	F	08/06→	MDO 23966 	598842	2	 280x26 (24,4) ● 197205		
	R	08/06→	MDO 24320 	598867	2	 262x10 (8) ● 197123		

Cerato (2004>)







































1.5CRDi, 1.6CRDi, 1.6i, 2.0CRDi, 2.0CVT	F	01/04→	MDO 24218 	598705	2	 275x24		
	R	01/04→	SUM 21553 	598817	2	 258x10		















Clarus (95>2001)



1.8i, 2.0i	F	05/95→07/01				 258x24		
	R	05/95→07/01	SUM 23455 	598841	2	 261x10		

										
KIA (…/…)										
Credos (97>)										
1.8i	F	01/97→								
	R	01/97→	SUM 23455 	598841	2		261x10			
Joice (99>)										
2.0i	F	09/99→	AKE 21727 	598574	2		256x24 (22,4)	186648		
	R	09/99→	MDO 23608 	598866	2		262x10			
Leo (96>)										
1.5i, 1.8i	F	08/96→	ATE 23266 	● 598989	2		243x20			
Magentis (2001>2005)										
2.0i, 2.5i V6	F	02/01→12/05	AKE 21727 	598574	2		257x24,5			
	ABS(+)	R	02/01→12/05	MDO 23543 	598748	2		260x12		
Magentis (2006>)										
2.0CRDi, 2.0i, 2.7i V6	F	01/06→	MDO 23891 	598744	2					
	R	01/06→	MDO 23543 	598748	2		262x10 (8,4)	● 197121		
Mentor (94>2001)										
1.5i	F	06/96→06/01	ATE 23266 	● 598989	2		243x20			
1.6i	F	05/94→01/97					243x20			
Mentor (2001>2004)										
1.6i	F	06/01→02/04	SUM 23873 	● 598910	2		258x24			
	ABS(+)	R	06/01→02/04	SUM 23455 	598841	2		262x10		
Picanto (2004>2007)										
1.0, 1.1	F	01/04→12/07	MDO 24275 	598707	2		241x18 (16)	● 197096		
1.1CRDi	F	11/05→12/07	MDO 24275 	598707	2		252x18			
1.0, 1.1, 1.1CRDi	ABS(+)	R	01/04→12/07	MDO 24276 	598706	2		234x10		
Picanto (2007>)										
1.0, 1.1	F	12/07→	MDO 24275 	598707	2		241x18 (16)	● 197096		
1.1CRDi	F	12/07→	MDO 24275 	598707	2		252x18			
1.0, 1.1, 1.1CRDi	R	12/07→	MDO 24276 	598706	2		234x10			

KIA (…/…)		
Pride (87>2000)		
1.1, 1.3, 1.3i	F	10/87→07/00 SUM 21355 598268 4 219x13 (11) 186454
Pride Wagon (98>2000)		
1.3i	F	08/98→07/00 SUM 21355 598268 4 219x13 (11) 186454
Rio (2000>2005)		
1.3i, 1.5i	F	07/00→05/05 SUM 21654 598274 2 235x22
Rio (2005>2008)		
1.4i, 1.5CRDi, 1.6i	F	06/05→04/08 MDO 24317 598868 2 256x22
	ABS(+) R	06/05→04/08 MDO 24320 598867 2 262x10 (8,4) ● 197029
Sedona (99>2002)		
2.5i V6, 2.9CrDi	F	09/99→05/00 SUM 23649 598821 2 274x24 (22) ● 197206
	F	05/00→01/02 SUM 23649 598821 2 274x26
Sedona (2002>)		
2.5i V6, 2.9CrDi	F	02/02→12/03 SUM 23649 598821 2 274x26
	F	12/03→ SUM 23649 598821 2 274x28,3 (26) ● 197211
Sephia (93>98)		
1.6i	F	01/93→07/95 243x20
1.5i, 1.6i, 1.8i	F	08/95→08/98 ATE 23266 ● 598989 2 243x20
	ABS(+) R	01/96→08/98 270x10
Sephia (98>2001)		
1.5i (5 doors)	F	09/98→05/01 ATE 23266 ● 598989 2 242x20 (18) ● 197208
1.5i (4 doors)	F	09/98→05/01 ATE 23266 ● 598989 2 242x20
1.5i (4/5 doors)	R	09/98→05/01 SUM 23455 598841 2 262x10
Shuma (98>2002)		
1.5i, 1.8i (5 doors)	F	09/98→02/01 ATE 23266 ● 598989 2 242x20 (18) ● 197208
1.5i (4 doors)	F	04/99→09/02 ATE 23266 ● 598989 2 242x20
1.5i, 1.8i (4/5 doors)	ABS(+) R	09/98→09/02 SUM 23455 598841 2 262x10

																	
KIA  (.../...)																	
Shuma (2001>2004)																	
1.6i, 1.8i	F	02/01→08/04	SUM 23873		● 598910	2		258x24									
	ABS(+)	R	02/01→08/04	SUM 23455		598841	2		262x10								
Venga (2009>)																	
1.4CRDi, 1.4CVT, 1.6CRDi, 1.6CVT	F	12/09→						280x26									
	R	12/09→						257x10									
KIA 																	
Besta (86>99)																	
2.2D	F	03/86→07/99						284x24									
2.2D 4WD	F	03/86→07/99						256x20,2									
Pregio (95>2005)																	
2.7D	F	11/95→01/99															
LADA 																	
Niva (76>)																	
1.6, 1.7i, 1.9D	F	03/76→	BDX 20660		598389	0		272x11 (9,9)	186172								
LADA 																	
110 (95>)																	
1.5 	F	01/95→						239x12 (10,8)	186173								
1.5, 1.5i 	F	01/95→						239x20 (18)	186781								
1.5i 16V 	F	01/95→						260x20									
1.5 	F	01/95→						239x12 (10,8)	186173								
1.5i 16V 	F	01/95→						260x20									
111 (95>)																	
1.5 	F	01/95→						239x12 (10,8)	186173								
112 (95>)																	
1.5i 16V 	F	01/95→						260x20									
1200/1300/1500/1600/ Classica																	
1.2, 1.3, 1.5, 1.6	F	1973→12/86	BDX 20166		598405	0		252x10,5 (9,2)	186171								



















			 R P F		 WVA	 Valeo	 Valeo	 Valeo	 Valeo
LADA  (.../...)									
Kalinka (95>98)									
1.5		F	10/95→1996					 239x12 (10,8)	186173
1.7i		F	10/96→1998	BDX 20166 	598405	0		 252x10,5 (9,2)	186171
Natacha (93>)									
1.1, 1.5		F	05/93→1997	LUC 21170 	598406	0		 239x12 (10,8)	186173
Sagona (91>)									
1.5, 1.5D		F	09/91→1999	LUC 21170 	598406	0		 239x12 (10,8)	186173
1.5i		F	07/94→1999					 239x20 (18)	186781
Samara (86>)									
1.1, 1.3, 1.5, 1.5D		F	07/86→1999	LUC 21170 	598406	0		 239x12 (10,8)	186173
1.5i		F	07/94→1999					 239x20 (18)	186781
Vega									
1.5i		F		LUC 21170 	598660	1		 239x20 (18)	186781
LANCIA 									
Beta (828) (72>85)									
1.3, 1.4, 1.6, 1.8, 2, 2i		F	1972→1985	BDX 20647 	598090	2		 251x12,7	
		R	1972→1985	BDX 20347 	598094	0		 251x10	
Dedra (835) (89>94)									
1.6ie	ABS(-)	F	03/89→06/94	LUC 21105 	598095	1		 240,5x10,9 (9,2)	186155 186942
	ABS(+)	F	03/89→06/94	LUC 21105 	598095	1		 257,5x11,9 (10,2)	186154
1.6ie, 1.8ie, 1.9TDs	ABS(+)	F	03/89→06/94	LUC 20838 	598219	4		 257,5x11,9 (10,2)	186154
2.0ie		F	03/89→06/94	LUC 20838 	598219	4		 257,4x20 (18,2)	186153
2.0ie Turbo		F	12/90→06/94	LUC 21147 	598985	2		 284x22 (20,2)	186297
1.8ie, 1.9TDs, 2.0ie	ABS(-)	R	03/89→06/94	BDX 20775 	598141	0		 240,5x10,9 (9,2)	186155
1.6ie, 1.8ie, 1.9TDs, 2.0ie 2.0ie Turbo	ABS(+)	R	03/89→06/94	LUC 21103 	598142	0		 240,5x10,9 (9,2)	186155
Dedra (835) (94>99)									
1.6ie 		F	07/94→11/97	LUC 20838 	598219	4		 257,5x11,9 (10,2)	186154

															
LANCIA  (.../...)															
Dedra (835) (94>99) (.../...)															
1.6ie, 1.8ie 	F	03/96-09/99	ATE 21927 	598041	2(A+B)		257,4x20 (18,2)	186153							
1.6ie, 1.8ie, 1.9TDs, 2.0ie 	F	07/94-09/99	LUC 20838 	598219	4		257,4x20 (18,2)	186153							
1.8ie, 2.0ie (eng 97 / 102KW) 	F	07/94-09/99					257x22 (20,5)	186590							
2.0ie Integrale 16V 	F	09/94-05/95	LUC 21147 	598985	2		284x22 (20,2)	186297							
	F	06/95-1996	ATE 21636 	598065	2		284x22 (20,2)	186297							
1.6ie 	R	12/97-09/99	LUC 23177 	598331	0		240,5x10,9 (9,2)	186155							
1.6ie, 1.8ie, 1.9TDs, 2.0ie 2.0ie Integrale 16V 	ABS(+) R	07/94-09/99	LUC 21103 	598142	0		240,5x10,9 (9,2)	186155							
Delta (831) (79>86)															
1.3, 1.5	F	09/79-04/86	LUC 20708 	598093	2		227,5x10,8 (9)	186151							
1.6, 1.6 Turbo	F	10/82-04/86	BDX 20775 	598141	0		257x12 (10,8)	* 186152							
	F	10/82-04/86	LUC 20838 	598219	4		257x12 (10,8)	* 186152							
	R	10/82-04/86	BDX 20775 	598141	0		227,5x10,8 (9)	186151							
Delta (831) (R86) (86>93)															
1.1i, 1.3, 1.5	F	04/86-1993	LUC 20708 	598093	2		227,5x10,8 (9)	186151							
1.6ie, 1.9TD	F	04/86-1993	LUC 20708 	598093	2		257x12 (10,8)	* 186152							
1.6ie Turbo	F	07/90-1993	LUC 20708 	598093	2		257,5x20 (18,2)	186149							
1.6 Turbo	F	05/86-03/87	LUC 20838 	598219	4		257,5x20 (18,2)	186149							
2.0i Turbo	F	04/86-09/87	LUC 20838 	598219	4		257,5x20 (18,2)	186149							
	F	09/87-07/88	LUC 20838 	598219	4		284,5x22 (20,2)	186266							
	F	08/88-1993	LUC 21147 	598985	2		284,5x22 (20,2)	186266							
	F	07/90-1994	BBO 21381 	598859	1		281x26								
1.6 Turbo, 1.6ie, 1.6ie Turbo, 2.0i Turbo	R	04/86-1993	BDX 20775 	598141	0		227,5x10,8 (9)	186151							
2.0i Turbo	R	07/90-1994	LUC 20960 	598180	0(D)		251,5x10 (9)	186290							
Delta (836) (MQ93) (93>99)															
1.4ie	F	07/95-08/99	LUC 20838 	598219	4		240,5x10,9 (9,2)	186155							



















LANCIA (.../...)



Delta (836) (MQ93) (93>99) (.../...)





















































1.6ie 16V	F	07/95→08/99	ATE 21930 	598040	1	 257,5x11,9(10,2)	186154
1.6ie, 1.8ie, 1.9TD	F	12/94→08/99	LUC 20838 	598219	4	 257,5x11,9(10,2)	186154
1.8ie	F	03/93→12/94	LUC 20838 	598219	4	 257,5x11,9(10,2)	186154
1.8ie 16V (eng 83KW)	F	07/95→08/99	ATE 21927 	598041	2(A+B)	 257,4x20 (18,2)	186153
1.8ie 16V (eng 97KW)	F	05/96→08/99	ATE 21636 	598065	2	 284x22 (20,2)	186297
1.9TD	F	04/95→08/99	LUC 20838 	598219	4	 284,5x22 (20,2)	186266
2.0i 16V, 2.0i Turbo 16V	F	03/93→05/95	LUC 21147 	● 598985	2	 284,5x22 (20,2)	186266
	F	06/95→08/99	ATE 21636 	598065	2	 284,5x22 (20,2)	186266
1.6ie 16V, 1.8ie, 1.8ie 16V, 1.9TD, 2.0i 16V 2.0i Turbo 16V	R	03/93→08/99	LUC 21103 	598142	0	 240,5x10,9 (9,2)	186155



























Delta (2008>)

1.4TJet (88KW)	F	06/08→05/09	BOS 23708 	598427	1(A)	 284,5x22 (20,2)	186266
	F	05/09→				 281x26 (24,2)	186745
1.4TJet (110KW)	F	06/08→05/09	BOS 23711 	598428	1	 281x26 (24,2)	186745
	F	05/09→				 281x26 (24,2)	186745
1.6MJTD	F	06/08→05/09	BOS 23708 	598427	1(A)	 284,5x22 (20,2)	186266
	F	05/09→				 281x26 (24,2)	186745
1.9MJTD, 2.0MJTD	F	07/08→	ATE 24272 	● 601014	1	 305x28	
1.8T Jet	F	04/09→				 330x28	
1.4TJet, 1.6MJTD	R	06/08→	BOS 23714 	598633	0	 251,5x10 (9)	186146
1.9MJTD, 2.0MJTD	R	06/08→	BOS 23714 	598633	0		
1.8T Jet	R	04/09→11/09	LUC 23760 	● 601029	0		
	R	11/09→					

Kappa (838) (94>2001)









































2.0ie 	F	10/94→10/01	LUC 21147 	● 598985	2	 281x22 (20,2)	186442

															
LANCIA  (.../...)															
Kappa (838) (94>2001) (.../...)															
2.0ie  		 2091154	F	10/94→	ATE 21636 	598308	2		281x22 (20,2)	186442					
2.0ie, 2.4JTD, 2.4TDs, 2.4ie   	F	10/94→10/01	ATE 21636 	598308	2		281x26 (24,2)	* 186443							
	F	10/94→10/01	ATE 21636 	598308	2		281x26								
2.0ie, 2.0ie Turbo, 2.4JTD, 2.4TDs, 2.4ie 3.0ie V6   	F	10/94→10/01	LUC 21147 	● 598985	2		281x26 (24,2)	* 186443							
	F	10/94→10/01	LUC 21147 	● 598985	2		281x26								
3.0ie V6  	F	10/94→10/01	BBO 23092 	598772	2		281x26 (24,2)	* 186443							
	F	10/94→10/01	BBO 23092 	598772	2		281x26								
2.0ie Turbo 	F	05/98→10/01	BBO 23092 	598772	2		310x28 (26)	● 197229							
3.0ie V6   	F	10/94→10/01	BBO 23092 	598772	2		310x28 (26)	● 197229							
2.0ie, 2.0ie Turbo, 2.4JTD, 2.4TDs, 2.4ie 3.0ie V6   	R	10/94→10/01	LUC 21606 	598581	0		276x10								
Lybra (839) (99>2006)															
1.6i	F	09/99→03/00	ATE 23140 	598880	2		281x15								
1.6i, 1.8i	F	09/99→12/06					281x15								
1.8i, 2.0i	F	09/99→12/06					284,5x22 (20,2)	186266							
1.8i, 1.9JTD, 2.0i, 2.4JTD	F	09/99→04/00	ATE 21636 	598308	2		284,5x22 (20,2)	186266							
	F	09/99→12/06	ATE 21637 	● 598990	1		284,5x22 (20,2)	186266							
1.6i, 1.8i, 1.9JTD, 2.0i, 2.4JTD	R	09/99→12/06	LUC 23661 	598407	0		251,5x10 (9)	186146							
Musa (2004>2007)															
1.3JTD Multijet, 1.4MPI, 1.4i	F	07/04→09/07	BOS 23705 	● 598913	0		257x22 (20,5)	186590							
	F	07/04→09/07	BOS 23705 	598670	2		257x22 (20,5)	186590							
1.3JTD Multijet, 1.9JTD	F	07/04→09/07	BOS 23708 	598698	0		284,5x22 (20,2)	186266							
Musa (2007>)															
1.3MJTD, 1.4MPI, 1.4i	F	10/07→	BOS 23705 	● 598913	0		257x22 (20,5)	186590							
1.3MJTD, 1.6MJTD, 1.9JTD	F	10/07→	BOS 23708 	598427	1(A)		284,5x22 (20,2)	186266							

		R P F		2+2		WVA		Valeo	
						Valeo		Valeo	
LANCIA  (.../...)									
Musa (2007>) (.../...)									
1.6MJTD		R	06/08→	LUC 23661		598425	0	240,5x10,9 (9,2)	186155
Phedra (2002>)									
2.0JTD, 2.0i, 2.2JTD (eng 94KW)		F	09/02→	LUC 20261		598553	2(A)	285,2x28 (26)	● 197219 ● 186984
2.2JTD (eng 125KW)		F	12/07→					310x32	
3.0i V6		F	09/02→09/05	BBO 23092		598468	4	310x32	
2.0JTD, 2.0i, 2.2JTD (eng 94KW) 2.2JTD (eng 125KW), 3.0i V6		R	09/02→	LUC 20960		598463	0(D)	272x12 (10)	186724
Prisma (83>86)									
1.6		F	04/83→	LUC 20838		598133	2	257x12 (10,8)	* 186152
		F	-05/86	LUC 20838		598219	4	257x12 (10,8)	* 186152
1.3, 1.5, 1.9D		F	01/83→05/86	LUC 20708		598093	2	227,5x10,8 (9)	186151
1.9TD		F	05/85→05/86	LUC 20708		598093	2	257x12 (10,8)	* 186152
1.6		R	04/83→	LUC 20838		598133	2	227,5x10,8 (9)	186151
		R	-05/86	BDX 20775		598141	0	227,5x10,8 (9)	186151
Prisma (R86) (86>89)									
1.3, 1.5		F	06/86→04/89	LUC 20708		598093	2	227,5x10,8 (9)	186151
1.6, 1.6ie		F	04/86→04/89	BDX 20775		598141	0	257x12 (10,8)	* 186152
1.9D, 1.9TD		F	06/86→04/89	LUC 20708		598093	2	257x12 (10,8)	* 186152
2ie		F	04/86→04/89	LUC 20838		598134	2	257x12 (10,8)	* 186152
1.6, 1.6ie		R	04/86→04/89					227,5x10,8 (9)	186151
2ie		R	04/86→04/89	LUC 20838		598134	2	227,5x10,8 (9)	186151
Thema (834) (84>88)									
2ie 	ABS(-)	F	10/84→09/88	LUC 20838		598134	2	257,5x12 (10,8)	* 186150
	ABS(-)	F	10/84→09/88	LUC 21185		598135	2(B)	257,5x12 (10,8)	* 186150
2.4TD, 2.8, 2ie, 2ie Turbo 	ABS(+)	F	10/84→09/88	LUC 20838		598134	2	257,5x20 (18,2)	186149
2.8, 2ie, 2ie Turbo 	ABS(+)	F	10/84→09/88	LUC 21185		598135	2(B)	257,5x20 (18,2)	186149





























															
LANCIA  (.../...)															
Thema (834) (84>88) (.../...)															
3.0i V8 	F	04/86→09/88	LUC 21147 	● 598985	2		284,5x22 (20,2)	186265							
2.4TD, 2.8, 2ie, 2ie Turbo 	R	10/84→09/88	LUC 20668 	598125	0		251,5x10 (9)	186146							
	R	10/84→09/88	LUC 20668 	598125	0		251x10								
3.0i V8 	R	04/86→09/88	LUC 20668 	598125	0		251,5x10 (9)	186290							
Thema (834) (RL88) (88>92)															
2ie  ABS(-)	F	10/88→08/92	LUC 21185 	598135	2(B)		257,5x14 (12,8)	* 186147							
2.5TD, 2.8, 2ie  ABS(+)	F	10/88→08/92	LUC 21185 	598135	2(B)		257,5x22 (20,2)	* 186148							
2.8, 2ie 	F	10/88→08/92	LUC 21147 	● 598985	2		257,5x22 (20,2)	* 186148							
2ie Turbo 	F	10/88→08/92	LUC 21147 	● 598985	2		284,5x22 (20,2)	186266							
3.0 	F	10/88→1991	LUC 21147 	● 598985	2		284,5x22 (20,2)	186265							
2.5TD, 2.8, 2ie, 2ie Turbo, 3.0 	R	10/88→08/92	LUC 20668 	598125	0		251,5x10 (9)	186146							
	R	10/88→08/92	LUC 20668 	598125	0		251x10								
Thema (834) (FC92) (92>94)															
2.0i, 2.5TDs 	F	09/92→11/94	LUC 21185 	598135	2(B)		257,5x22 (20,2)	* 186148							
2.0i Turbo, 3.0 V6 	F	09/92→11/94	LUC 21147 	● 598985	2		284,5x22 (20,2)	186266							
3.0 V6 	F	09/92→11/94	LUC 21147 	● 598985	2		284,5x22 (20,2)	186265							
2.0i, 2.0i Turbo, 2.5TDs, 3.0 V6 	R	09/92→11/94	LUC 20668 	598125	0		251x10								
	R	09/92→11/94	LUC 20668 	598125	0		251,5x10 (9)	186146							
3.0 V6 	R	09/92→11/94	LUC 20668 	598125	0		251,5x10 (9)	186290							
Thesis (2002>)															
2.0i Turbo, 2.4JTD, 2.4i, 3.0i V6	F	09/02→	LUC 23761 	● 601001	2		305,5x28 (26)	● 197137							
3.0i V6	F	09/02→03/05	LUC 23761 	● 601001	2										
2.0i Turbo, 2.4JTD, 2.4i, 3.0i V6	R	09/02→	LUC 23760 	● 601029	0		281x22 (20,2)	● 197138							
3.0i V6	R	09/02→03/05	LUC 23760 	● 601029	0										
Trevi (828) (80>85)															
1.3, 1.6, 2, 2i	F	10/80→1985	BDX 20647 	598090	2		251x12,7								

































													
													
LANCIA  (.../...)													
Trevi (828) (80>85) (.../...)													
1.3, 1.6, 2, 2i (...)	R	10/80→1985	BDX 20347		598094	0		251x10					
Y Ipsilon (95>2000)													
1.1i, 1.2i	ABS(-)	F	11/95→08/00	BDX 21365		598012	0		240,5x10,9 (9,2)	186155			
1.1i, 1.2i, 1.4i		F	11/95→08/00	LUC 20838		598219	4		257,5x11,9(10,2)	186154			
Y Ipsilon (2000>2003)													
1.2i	ABS(-)	F	09/00→09/03	BDX 21365		598012	0		240,5x10,9 (9,2)	186155			
	ABS(+)	F	09/00→09/03	ATE 21930		598605	0		257,5x11,9(10,2)	186154			
Y Ipsilon (2003>)													
1.2i, 1.4i		F	10/03→	ATE 24073		601031	1		257,5x11,9(10,2)	186154			
1.2i, 1.3MJTD, 1.4i		F	10/03→08/06	LUC 27073		598761			257x22 (20,5)	186590			
1.3MJTD		F	08/06→	ATE 24073		601031	1		257x22 (20,5)	186590			
1.3MJTD, 1.4i		R	01/07→	LUC 23661		598425	0		240,5x10,9 (9,2)	186155			
Y10 (156) (89>95)													
1.0, 1.0ie, 1.1ie		F	01/89→10/95	BDX 20775		598091	2		227,5x10,8 (9)	186151	186904		
1.1ie, 1.3ie		F	01/89→10/95	LUC 20838		598219	4		240,5x12 (10,8)	186157			
Zeta (U60) (94>2002)													
2.0JTD, 2.0ie, 2.0ie Turbo, 2.1TD		F	10/94→08/02	LUC 21801		598064	4		281x26 (24,2)	186420			
	ABS(+)	R	10/94→08/02	ATE 21275		598502	0		295x10 (8)	186421			
	ABS(-)	P	10/94→08/02			562739							
LAND ROVER 													
Defender (90>2007)													
2.5, 2.5D, 2.5TDi, 3.5 V8	 HA701009	F	10/90→	AP 20359		598129	4(B)		298,5x14 (13)	186283			
2.5, 2.5D, 3.5 V8	 HA701010	F	-02/94	AP 21519		598623	0		298,5x14 (13)	186283			
2.5, 2.5D, 2.5TDi, 2.5Td5, 3.5 V8, 4.0i V8		F	10/90→04/07						298,5x14 (13)	186283			
2.5, 2.5D, 2.5TDi, 3.5 V8	 HA701009	F	10/90→	AP 20359		598129	4(B)		298x24 (22)	* 186284			
	 HA701010	F	-09/94	AP 21519		598623	0		298x24 (22)	* 186284			































													
LAND ROVER  (.../...)													
Defender (90>2007) (.../...)													
2.5TDi, 2.5Td5, 3.5 V8		F	10/90→04/07								298x24 (22)	* 186284	
2.5, 2.5D, 2.5TDi		R	10/90→1993	AP 20359		598129	4(B)				291x12,7 (11,7)	* 186310	
2.5, 2.5D, 2.5TDi, 2.5Td5 3.5 V8	 KA930546	R	→04/07	AP 23471		598762					291x12,7 (11,7)	* 186310	
		R	→04/07								291x12,7 (11,7)	* 186310	
2.5, 2.5D, 2.5TDi, 2.5Td5 3.5 V8, 4.0i V8	 KA930455	R	→04/07	AP 21237		598497	1				291x12,7 (11,7)	* 186310	
2.5, 2.5D, 2.5TDi, 3.5 V8	 2A6364524WD	P	10/90→			564014							
2.5, 2.5D, 2.5TDi, 2.5Td5 3.5 V8, 4.0i V8	 2A6364534WD	P	→04/07			562736							
Defender II (2007>)													
2.4TDCI		F	03/07→								298,5x14 (13)	186283	
		F	03/07→								298x24 (22)	* 186284	
		R	03/07→								291x12,7 (11,7)	* 186310	
		R	03/07→		AP 21237		598497	1				291x12,7 (11,7)	* 186310
Discovery (89>94)													
2.0i, 2.5TDi, 3.5 V8, 3.5i V8, 3.9i V8		F	09/89→03/94	AP 21897		598498	1				298,5x14 (13)	186283	
2.5TDi, 3.5 V8, 3.5i V8, 3.9i V8		F	09/89→03/94	AP 21897		598498	1				298x24 (22)	* 186284	
2.0i, 2.5TDi, 3.5 V8, 3.5i V8, 3.9i V8		R	09/89→03/94	AP 21237		598497	1				291x12,7 (11,7)	* 186310	
		P	09/89→03/94										
Discovery (94>98)													
2.0i, 2.5TDi, 3.9i V8		F	03/94→11/98	AP 21897		598498	1				298x24 (22)	* 186284	
		R	03/94→11/98	AP 21237		598497	1				291x12,7 (11,7)	* 186310	
Discovery (98>2004)													
2.5Td5, 4.0i V8	 2A999999	F	11/98→	LUC 23452		598441	0				297,5x25 (22)	● 197062	
		F	→11/04								297,5x25 (22)	● 197062	
		R	11/98→11/04	LUC 20344		598499	0				304x12,6 (11,7)	* 186642	

















LAND ROVER (.../...)		
Discovery (98>2004) (.../...)		
2.5Td5, 4.0i V8 (...)	2A768332	P 11/98→11/04 562736
	2A768331	P 11/98→ 564014
Discovery (2004>)		
2.7Td6, 4.0i V6	F 11/04→ LUC 24191	598741 317x30 (27) ● 197155
4.4i V8	F 11/04→ LUC 24191	598741 337,5x30
2.7Td6, 4.0i V6	R LUC 24192	598742 325x20 (17) ● 197156
4.4i V8	R LUC 24192	598742 350x20
Freelander (97>2003)		
1.8i, 2.0D	F 10/97→09/00 LUC 21515	598512 0 262x14 (11) 186687
1.8i, 2.0Td4, 2.5i V6	F 09/00→09/03 LUC 23615	598514 0 277x20,9 (18) 186871
Freelander (2003>2006)		
1.8i, 2.0Td4, 2.5i V6	F 09/03→09/06 LUC 23615	598514 0 277x20,9 (18) 186871
Freelander 2 (2006>)		
2.2TD4	F 02/06→ ATE 24123	598879 0 300x28 (26) ● 197055
3.2i V6	F 02/06→09/06	316x28
2.2TD4	R 02/06→ LUC 24537	● 598935 0 302x12 (10) ● 197107
3.2i V6	R 02/06→09/06 LUC 24537	● 598935 0
Land 90		
2.3, 2.5, 2.5D, 2.5TD, 3.5 V8	F 06/84→09/90	298,5x14 (13) 186283
	P 06/84→09/90	562736
Land 110		
2.3, 2.3D, 2.5, 2.5D, 2.5TD 3.5 V8	21L18648B F 10/83→	298,5x14 (13) 186283
	21L18648B F →09/90 AP 21519	598623 0 298,5x14 (13) 186283
	P 10/83→09/90	562736
Range Rover (81>86)		
3.5 V8	F 07/81→09/86 AP 20359	598129 4(B) 298,5x14 (13) 186283























































																	
LAND ROVER  (.../...)																	
Range Rover (81>86) (.../...)																	
3.5 V8 (...)	R	07/81→09/86	AP 21237		598497	1		291x12,7 (11,7)	* 186310								
	P	07/85→09/86			562736												
Range Rover (86>94)																	
2.4TD	F	04/86→07/89	AP 21897		598498	1		298,5x14 (13)	186283								
3.5 V8, 3.5i V8	F	08/86→10/89						298,5x14 (13)	186283								
2.4TD, 2.5TD, 2.5TDi, 3.5 V8, 3.5i V8 3.9i V8, 4.2i V8	F	07/89→09/94	AP 21897		598498	1		298x24 (22)	* 186284								
	R	04/86→09/94	AP 21237		598497	1		291x12,7 (11,7)	* 186310								
	P	04/86→1994			562736												
2.5TDi, 3.9i V8, 4.2i V8	P	1994→09/94			564014												
Range Rover (94>2002)																	
2.5TD, 4.0 V8, 4.6 V8	F	09/94→02/02	LUC 23452		598441	0		297x25 (22)	● 197224								
	R	09/94→02/02	LUC 20344		598499	0		304x12,6 (11,7)	* 186642								
	P	09/94→02/02			564014												
Range Rover (2002>)																	
2.9Td6, 3.6TDV8, 4.2i V8, 4.4i V8	F	03/02→	ATE 23399		598658	0		297x25									
2.9Td6, 4.4i V8	R	03/02→	ATE 21487		598580	0		304x12,6 (11,7)	* 186642								
2.9Td6, 3.6TDV8, 4.2i V8 4.4i V8	R		ATE 21487		598580	0		354x11,9 (10,4)	● 197017								
Range Rover Sport (2005>)																	
2.7TDV6	F	06/05→	LUC 24191		598741			317x30 (27)	● 197155								
3.6TDV8	F	04/07→						360x30									
4.2i V8, 4.4i V8	F	06/05→						360x30									
2.7TDV6	R	06/05→	LUC 24192		598742			325x20 (17)	● 197156								
3.6TDV8, 4.2i V8, 4.4i V8	R	06/05→	LUC 24192		598742			350x20									































																	
LDV 																	
Maxus (2005>)																	
2.5CRD	⌀ 15"	F	04/07→														
	⌀ 16"	F	04/07→														
Sherpa II (82>89)																	
1.7, 2.0		F	1984→12/89														
3.5	 816133	F	1984→	AP 20359		598129	4(B)										
	 816134	F	-12/89														
LEXUS 																	
LX 470 (2002>2007)																	
4.7i V8		F	08/02→08/07	SUM 23524		598535	2		313x32								
		R	08/02→08/07	AKE 23539		598865	0		330x18								
RX 300 (2000>2003)																	
3.0i V6		F	07/00→02/03	AKE 23703		598944	2										
RX 300 (2003>2006)																	
3.0i V6		F	02/03→01/06														
		R	02/03→01/06														
RX 350 (2006>)																	
3.5VtI V6		F	01/06→						319x28								
		R	01/06→	AKE 23703		598944	2		288x10								
RX 400 (2005>)																	
3.3i V6		F	03/05→						319x28								
		R	03/05→						288x10								
LEXUS 																	
GS 300 (93>97)																	
3.0i		F	08/93→08/97	SUM 21490		601023	2		296x32								
		R	08/93→08/97	SUM 23429		601022	4		307x16								
GS 300 (97>2004)																	
3.0i		F	09/97→11/01	SUM 21490		601023	2		296x32 (30)	197194							















































																	
LEXUS  (.../...)																	
GS 300 (97>2004) (.../...)																	
3.0i (...)	F	11/01→12/02	SUM 21490		● 601023	2											
	F	12/02→12/04															
	R	09/97→12/04	SUM 23429		● 601025	2		308x12									
GS 300 (2005>)																	
3.0i	F	01/05→															
	R	01/05→	AKE 24323		● 598888	2											
GS 430 (2000>2004)																	
4.3i V8	F	07/00→11/01	SUM 21490		● 601023	2		296x32 (30)	● 197194								
	F	11/01→12/04	SUM 21490		● 601023	2											
	R	07/00→12/04	SUM 23429		● 601025	2		308x12									
GS 430 (2005>)																	
4.3i V8	F	01/05→09/07															
	R	01/05→09/07	AKE 24323		● 598888	2											
GS 450 (2006>)																	
3.5i V6	F	02/06→07/07															
	R	02/06→07/07	AKE 24323		● 598888	2											
IS I (99>2005)																	
2.0i 	F	03/99→07/05	SUM 21490		● 601023	2		296x32 (30)	● 197194								
	R	03/99→07/05	SUM 23429		● 601025	2		308x12									
IS 220D (2005>)																	
2.2D4-D	F	11/05→08/08	SUM 23983		● 601035	0											
	R	11/05→08/08	AKE 24323		● 598888	2											
IS 250 (2005>)																	
2.5i V6	F	08/05→08/08	SUM 23983		● 601035	0											
	R	08/05→08/08	AKE 24323		● 598888	2											
IS 300 (99>2005)																	
3.0i	F	09/01→07/05	SUM 21490		● 601023	2		296x32 (30)	● 197194								

		 		  		  			
LEXUS  (.../...)									
IS 300 (99>2005) (.../...)									
3.0i (...)	R	09/01→07/05	SUM 23429 	● 601025	2		308x12		
LS400 (89>94)									
4.0i V8	F	12/89→08/92					275x28		
	F	08/92→11/92					296x32 (30)	● 197194	
	F	11/92→10/94					296x32		
	R	12/89→08/92					291x16		
	R	08/92→10/94					307x16		
	P	12/89→10/94			564015				
LS400 (94>2000)									
4.0i V8	F	10/94→07/97					315x28		
	F	07/97→08/00					315x28		
	R	10/94→08/00					307x16		
LS430 (2000>2008)									
4.3i V8	F	08/00→08/06							
	R	08/00→08/06					307x16		
LS460 (2006>)									
4.6VTTi V8, 4.6VTTiE V8	F	08/06→09/08							
	R	08/06→09/08							
SC430 (2001>)									
4.3i V8	F	05/01→08/05	SUM 21490 	● 601023	2		296x32 (30)	● 197194	
	R	05/01→08/05	SUM 23429 	● 601025	2		308x12		
MARUTI 									
800									
0.8, 0.8i	F	10/87→	SUM 20731 	598185	0		215x10		
MAZDA 									
B Pick-up (89>99)									
1.6, 2.0, 2.2D, 2.2i	F	11/89→01/99					255,6x20 (18)	* 186665	





















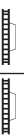

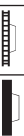











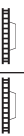

																			
MAZDA  (.../...)																			
B Pick-up (89>99) (.../...)																			
2.6i	F	11/89→01/99																	
2.5D 2WD	F	03/98→01/99																	
2.5D 4WD	F	03/98→01/99																	
B Pick-up (99>)																			
2.2i, 2.5D, 2.5TD	4WD(-)	F	02/99→	KH 23540		598784	1												
	4WD(+)	F	02/99→	KH 23540		598784	1												
BT50 (2006>)																			
2.5	4WD(-)	F	08/06→	KH 23540		598784	1												
	4WD(+)	F	08/06→																
CX-7 (2007>)																			
2.3i Turbo	F	05/07→																	
	R	05/07→																	
MAZDA 																			
2 (2003>2008)																			
1.25i, 1.4MZ-CD, 1.4i, 1.6i	F	03/03→01/08	ATE 23202		598564	0													
2 (2007>)																			
1.3i, 1.4 CD, 1.5MZR, 1.6 MZ-CD	F	06/07→	LUC 24283		● 598999	1													
3 (2003>2006)																			
1.4i, 1.6DE, 1.6i	F	06/03→02/06	ATE 23723		598649	0													
2.0i	F	06/03→02/06	ATE 23723		598649	0													
1.4i, 1.6DE, 1.6i	R	06/03→02/06	ATE 23723		● 601005	0													
2.0i	R	06/03→02/06	ATE 23723		● 601005	0													
3 (2006>)																			
1.4i, 1.6MZ-CD, 1.6i	F	03/06→	ATE 23723		598649	0													
2.0MZ-CD, 2.0i	F	03/06→	ATE 23723		598649	0													
2.3i Turbo	F	07/06→	ATE 23723		598649	0													
1.4i, 1.6MZ-CD, 1.6i	R	03/06→	AKE 23723		● 601008	0													

			 R P F		 WVA	 Valeo	 Valeo	 Valeo	 Valeo	
MAZDA  (.../...)										
3 (2006>) (.../...)										
2.0i		R	03/06→	AKE 23723 	● 601008	0		276x11		
2.0MZ-CD, 2.0i, 2.3i Turbo		R	07/06→	AKE 23723 	● 601008	0		280x9		
3 (2008>)										
1.6CDVi, 1.6i, 2.2CDVi 150 2.2CDVi 185	⊙ 15"	F	12/08→	ATE 23723 	598649	0		278x25 (23)	186872	
2.0i, 2.2CDVi 150 2.2CDVi 185	⊙ 16", 17"	F	01/09→	ATE 23723 	598649	0		300x25		
1.6CDVi, 1.6i		R	12/08→	AKE 23723 	● 601008	0		265x11 (9)	● 197021	
2.0i, 2.2CDVi 150, 2.2CDVi 185		R	01/09→	AKE 23723 	● 601008	0		280x11		
5 (2005>)										
1.8i, 2.0CD, 2.0i	⊙ 15"	F	02/05→	ATE 23723 	598649	0		278x25 (23)	186872	
	⊙ 16"	F	02/05→12/07	ATE 23723 	598649	0		300x25		
1.8i, 2.0CD, 2.0i, 2.0i Auto	⊙ 16", 17"	F	09/07→	ATE 23723 	598649	0		300x25		
1.8i, 2.0CD, 2.0i	⊙ 15"	R	02/05→12/07	TVS 23483 	● 601044	0		276x11		
	⊙ 16"	R	02/05→12/07	TVS 23483 	● 601044	0		302x11		
	⊙ 15"	R	09/07→	AKE 23723 	● 601008	0		280x11		
	⊙ 17"	R	09/07→	AKE 23723 	● 601008	0		302x11		
6 (2002>2007)										
1.8i 		F	06/02→08/07	SUM 21755 	598647	2		273x24		
1.8i, 2.0DiTD, 2.0i, 2.3i 		F	06/02→08/07	AKE 24046 	598648	2		283x25 (23)	● 197245	
2.0DiTD, 2.0i, 2.3i 		F	04/02→02/05					283x25 (23)	● 197245	
2.0DiTD, 2.0i, 2.3i  		F	03/05→08/07					283x25 (23)	● 197245	
2.3DISI Turbo, 2.3i  		F	03/05→08/07					320x25		
1.8i, 2.0DiTD, 2.0i, 2.3i  		R	04/02→	AKE 24045 	598780	0		280x10 (8)	186851	
2.3DISI Turbo, 2.3i  		R	03/05→08/07	AKE 24045 	598780	0		313x11		
6 (2007>)										
1.8MZR, 2.0MZR, 2.0MZR-CD, 2.5MZR 		F	08/07→					299x25		



























												
MAZDA  (.../...)												
6 (2007>) (.../...)												
1.8MZR, 2.0MZR, 2.0MZR-CD, 2.5MZR 	F	11/07→							299x25			
1.8MZR, 2.0MZR, 2.0MZR-CD, 2.5MZR  	R	08/07→							280x10 (8)	186851		
121 (DA) (88>90)												
1.1, 1.3, 1.3i	F	01/88→10/90	SUM 21355 	598268	4				219x13 (11)	186454		
121 (DB) (90>96)												
1.1, 1.3, 1.3i	F	11/90→02/96	SUM 21654 	598274	2				235x12 (10)	* 186453		
1.3, 1.3i	F	11/90→02/96	SUM 21654 	598274	2				235x18 (16)	* 186449		
121 (JA/JB) (96>)												
1.2, 1.3, 1.8D	ABS(-)	F	03/96→						239,7x12 (10)	186529		
1.2		F	03/96→	ATE 20783 	598212	0			239,7x20 (18)	186163	186941	
1.2, 1.8D	ABS(+)	F	03/96→						239,7x20 (18)	186163		
323 (BD) (80>85)												
1.1, 1.3, 1.5	F	08/80→08/84	SUM 20760 	* 598612	0				239x12			
323 (BF) (85>89)												
1.1, 1.3, 1.5, 1.6, 1.6i 4WD Turbo, 1.7D	F	01/85→1989	SUM 21277 	598293	2				238x18			
1.6i Turbo	F	01/86→1989	SUM 21277 	598293	2				260x18			
1.6, 1.6i Turbo	R	07/85→1989							222x10			
323 (BG) (89>94)												
1.3, 1.6, 1.7D	F	06/89→05/94	SUM 21654 	598274	2				235x18 (16)	* 186449		
1.3, 1.6, 1.8	F	06/89→05/94	SUM 21654 	598274	2				235x22			
1.8i	F	08/89→05/94	SUM 21539 	598646	2				257x22 (20)	* 186451		
1.8i 4WD Turbo, 1.8i 4x4	F	09/90→05/94	SUM 21654 	598274	2				274x24			
1.3, 1.6, 1.8	R	06/89→05/94	SUM 20031 	598624	0				231x9			
1.8i, 1.8i 4WD Turbo, 1.8i 4x4	R	08/89→05/94	SUM 20031 	598624	0				251x9 (8)	* 186452		
323 (BA) (94>98)												
1.3i	F	06/94→06/98	SUM 21654 	598274	2				235x18 (16)	* 186449		
1.5i	F	06/94→06/98	SUM 21654 	598274	2				235x22			















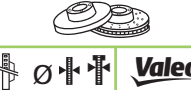

































			 		  		  	
MAZDA  (.../...)								
323 (BA) (94>98) (.../...)								
1.6i, 1.7TD, 1.8i, 2.0D	F	08/94→06/98	SUM 21539 	598646	2	 257x22 (20) * 186451		
2.0i V6	F	10/94→09/96				 274x22		
1.8i, 2.0i V6	R	08/94→09/96				 251x9		
323 (BJ) (98>2000)								
1.3i, 1.5i	F	08/98→09/00	SUM 23490 	598548	2	 235x22 (20) ● 197161		
1.8i, 2.0Di, 2.0DiTD	F	08/98→09/00	SUM 21754 	598629	2	 258x24 (22) 186810		
1.3i, 1.5i, 1.8i, 2.0Di, 2.0DiTD	R	08/98→09/00	AKE 24045 	598780	0	 260x10		
323 (BJ) (2000>2003)								
1.3i	F	10/00→10/03	SUM 23490 	598548	2	 235x22 (20) ● 197161		
	Sport(+)	F	10/00→10/03	SUM 21755 	598647	2	 235x22 (20) ● 197161	
1.6i, 2.0DiTD, 2.0i	F	10/00→10/03	SUM 21754 	598629	2	 258x24 (22) 186810		
	Sport(+)	F	10/00→10/03	SUM 21755 	598647	2	 258x24 (22) 186810	
2.0i	F	10/00→10/03	SUM 21754 	598629	2	 273x24		
	Sport(+)	F	10/00→10/03	SUM 21755 	598647	2	 273x24	
1.3i, 1.6i, 2.0DiTD, 2.0i	R	10/00→10/03	AKE 24045 	598780	0	 261x10 (8) ● 197020		
	Sport(+)	R	10/00→10/03	AKE 24045 	598780	0	 280x10 (8) 186851	
323 Wagon (BW) (86>93)								
1.3, 1.5, 1.6, 1.6i, 1.7D	F	01/86→08/93	SUM 21277 	598293	2	 238x18		
1.6	R	10/89→08/93				 222x10		
616 (SN) (73>78)								
1.6	F	09/73→07/78	BDX 20347 	598077	0	 230x12		
626 (GC) (82>87)								
1.6, 2, 2D, 2i	F	11/82→1987	AKE 21041 	598239	0			
626 (GD) (87>92)								
1.6, 1.8, 2.0D 	F	10/87→01/92	SUM 21378 	598250	2	 242x20 (18) 186446		
2.0, 2.0i, 2.2i 	F	10/87→01/92	SUM 21378 	598250	2	 264x24 (22) * 186455		

















































			WVA	Valeo	Valeo	Valeo	Valeo	
MAZDA (././.)								
626 (GD) (87>92) (././.)								
2.0, 2.0i	R	10/87→01/92	SUM 21558	598846	0			
2.2i	R	08/89→01/92	AKE 24045	598780	0			
626 (GE) (91>97)								
1.8i 16V, 2.0D, 2.0i 16V, 2.0i 4WD 16V, 2.5i 2.5i 4WS	F	08/91→05/97	SUM 21754	598629	2	258x24 (22)	186457	
1.8i 16V, 2.0D, 2.0i 16V, 2.5i, 2.5i 4WS	R	08/91→05/97	SUM 21766	598290	0	261x9,8 (8)	* 186458	
2.0i 4WD 16V	R	09/91→05/97	SUM 20031	598624	0	261x9,8 (8)	* 186458	
	R	09/91→05/94	AKE 24045	598780	0	261x9,8 (8)	* 186458	
	R	06/94→05/97			0	261x9,8 (8)	* 186458	
626 (GF) (97>2002)								
1.8i, 2.0DiTD, 2.0i	F	06/97→05/02	SUM 21754	598629	2	258x24 (22)	186457	
	R	06/97→05/02	AKE 24045	598780	0	261x9,8 (8)	* 186458	
626 Wagon (GV) (88>92)								
1.8, 2, 2.2i, 2D, 2i	F	10/88→02/92	SUM 21378	598250	2	264x24 (22)	* 186455	
	R	10/88→02/92	SUM 21558	598846	0	258,5x10		
2.2i	R	09/90→02/92	AKE 24045	598780	0	259x10,2		
626 Wagon (GV) (92>97)								
2.0D, 2.0D Complex, 2.0i, 2.0i 16V, 2.2i 2.2i 4WD	F	03/92→10/97	SUM 21378	598250	2	264x24 (22)	* 186455	
	R	03/92→10/97	SUM 21558	598846	0	258,5x10		
2.2i 4WD		312888 R	03/92→			261x10		
		312889 R	→10/97			261x10		
626 Wagon (GW) (97>99)								
1.8i, 2.0i	F	11/97→09/99	SUM 21754	598629	2	258x24 (22)	186457	
2.0DiTD	F	07/98→09/99	SUM 21755	598647	2	273x24		
1.8i, 2.0i	R	11/97→09/99	AKE 24045	598780	0	261x9,8 (8)	* 186458	
2.0DiTD	R	07/98→09/99	AKE 24045	598780	0	280x10 (8)	186851	













































































													
													
MAZDA  (.../...)													
626 Wagon (GW) (99>2002)													
1.8i, 2.0i	F	10/99→05/02	SUM 21754		598629	2		258x24 (22)	186457				
2.0DiTD	F	10/99→05/02	SUM 21755		598647	2		273x24					
1.8i, 2.0i	R	10/99→05/02	AKE 24045		598780	0		261x9,8 (8)	* 186458				
2.0DiTD	R	10/99→05/02	AKE 24045		598780	0		280x10 (8)	186851				
Demio (98>2003)													
1.3i	F	05/98→03/03	SUM 21655		● 601018	2		235x22					
	F	01/00→03/03						235x22					
1.5i	F	04/00→03/03						235x22					
MPV (95>99)													
2.5TD, 3.0 V6	F	12/95→10/99	SUM 20905		598515	2							
	R	12/95→10/99	AKE 23514		598516	1		286x18					
MPV (99>2002)													
2.0i	F	06/99→07/02	SUM 20905		598515	2		274x28					
MPV (2002>2006)													
2.3i	F	03/02→04/05	SUM 20905		598515	2		274x28					
2.0DiTD	F	03/02→04/05						296x28					
MX3 (91>98)													
1.6i, 1.8i V6	F	03/91→02/98	SUM 21539		598646	2		257x22 (20)	* 186451				
1.8i V6	R	03/91→09/96						251x9 (8)	* 186452				
MX5 (90>98)													
1.6i (eng 85KW)	F	04/90→08/93						235x18 (16)	* 186449				
1.6i (eng 66KW)	ABS(-)	F	12/94→02/98					235x18 (16)	* 186449				
1.6i (eng 66KW), 1.8i	ABS(+)	F	09/93→02/98	SUM 23354		598836	2		255x20 (18)	● 197063			
1.6i (eng 66/85KW)	ABS(-)	R	04/90→02/98	SUM 20031		598624	0		231x9				
1.6i (eng 66KW), 1.8i	ABS(+)	R	09/93→02/98	AKE 24029		598835	2		251x9 (8)	* 186452			
MX5 (98>2000)													
1.6i, 1.8i	F	03/98→08/00	SUM 23354		598836	2		255x20 (18)	● 197063				

MAZDA (../...)								
MX5 (98>2000) (../...)								
	R	03/98→08/00	AKE 24029	598835	2		251x9 (8)	* 186452
MX5 (2000>2005)								
1.6i	F	09/00→08/02	SUM 23354	598836	2		255x20 (18)	● 197063
	F	08/02→03/05					255x20 (18)	● 197063
1.8i	F	09/00→03/05	AKE 24297	598745	2		270x22	
1.6i	R	09/00→03/05	AKE 24029	598835	2		251x9 (8)	* 186452
1.8i	R	09/00→03/05					276x10	
MX5 (2005>)								
1.8i, 2.0i	F	03/05→	AKE 24297	598745	2		290x22	
	R	03/05→	AKE 24298	598746	1		280x10 (8)	186851
MX6 (91>97)								
2.0i, 2.5i V6	F	07/91→08/97	SUM 21754	598629	2		258x24 (22)	186457
	R	07/91→08/97	SUM 21766	598290	0		261x9,8 (8)	* 186458
Premacy (99>2001)								
1.8i, 2.0DiTD	F	06/99→06/01	SUM 21754	598629	2		258x24 (22)	186457
Premacy (2001>2005)								
1.8i	F	07/01→08/05	SUM 21755	598647	2		258x24 (22)	186457
2.0DiTD	7 places (-)	F	07/01→08/05	SUM 21754	2		258x24 (22)	186457
2.0DiTD, 2.0i	7 places (+)	F	07/01→08/05	SUM 21755	2		273x24	
1.8i, 2.0DiTD, 2.0i	7 places (-)	R	07/01→08/05				261x9,8 (8)	* 186458
2.0DiTD, 2.0i	7 places (+)	R	07/01→08/05	AKE 24045	0		280x10 (8)	186851
RX7 (85>91)								
2.6i	F	11/85→1986					250x22	
2.6i Turbo	F	03/89→12/91					242x20 (18)	186446
2.6i, 2.6i Turbo	R	11/85→12/91					273x20	
RX7 (92>)								
2.6i Twin Turbo	F	07/92→1996					294x22	

		R P F		WVA		Valeo		Valeo		Valeo	
MAZDA  (.../...)											
RX7 (92>) (.../...)											
2.6i Twin Turbo (...)	R	07/92→1996							294x20		
RX8 (2003>)											
1.3i	F	02/03→							302x24		
	SPOR(+)	F	02/03→						323x24		
		R	02/03→	AKE 24039 	598831	1			302x18		
Xedos 6 (91>99)											
2.0i V6	F	10/91→11/99	SUM 21754 	598629	2			258x24 (22)	186457		
		R	10/91→11/99	SUM 21766 	598290	0			261x9,8 (8)	* 186458	
MERCEDES 											
Class G (M460) (79>89)											
200, 230, 240, 250, 280, 300	F	03/79→08/89	PER 20784 	598613	0			303x16 (13)	* 186692		
Class G (M461/3) (89>)											
200GE, 230GE, 250GD, 290GD, 290GDT, 300GD 300GE, 350GD, 500GE, G270, G300, G320, G320A G400CDI, G500, G55AMG	F	09/89→	PER 20784 	598613	0			303x16 (13)	* 186692		
		F	09/91→	PER 20784 	598613	0			315x30		
G320, G400CDI, G500, G55AMG	R	07/97→	BOS 23021 	598300	0			272x16 (14)	187045		
Class GL (164) (2006>)											
GL 320	F	01/06→	ATE 23922 	598728	0			350x32			
GL 420, GL 450, GL 500	F	01/06→	ATE 23922 	598728	0			375x32			
GL 320, GL 420, GL 450, GL 500	R	01/06→	ATE 23923 	598802	0			330x22			
Class GLK (2008>)											
GLK 280, GLK 320, GLK 350	F	07/08→						330x32			
		R	07/08→	ATE 24253 	● 601051	0			300x22 (19,4)	186865	
Class ML (163) (97>2005)											
ML230, ML270CDi, ML320	F	05/97→09/00	KH 23193 	598442	1			303x26			
ML270CDi, ML320	F	09/00→04/05	BBO 23271 	598445	0			303x26			
ML350, ML400CDi, ML430, ML500, ML55	F	03/98→04/05	BBO 23271 	598445	0			345x31,9 (30)	186811		

																				
MERCEDES  (.../...)																				
Class ML (163) (97>2005) (.../...)																				
ML230, ML270CDi, ML320	R	05/97→09/00	KH 23189		598443	1		285x15 (13)	186753											
ML270CDi, ML320	R	09/00→04/05	BOS 23189		598813	1		285x15 (13)	186753											
ML350, ML400CDi, ML430, ML500, ML55	R	03/98→04/05	BBO 23157		598719			331x14												
ML230, ML270CDi, ML320, ML350, ML400CDi ML430, ML500, ML55	P	05/97→04/05			564010															
Class ML (164) (2005>2008)																				
ML 280, ML 320, ML 350	F	05/05→04/08	ATE 23922		598728	0		330x32 (29,4)	197092											
ML 420, ML 500, ML 63	F	05/05→04/08	ATE 23922		598728	0		350x32												
ML 280, ML 320, ML 350, ML 420, ML 500, ML 63	R	05/05→04/08	ATE 23923		598802	0														
ML 280, ML 320, ML 350	R	05/05→04/08	ATE 23923		598802	0		330x14												
ML 420, ML 500, ML 63	R	05/05→04/08	ATE 23923		598802	0		330x22												
Class ML (164) (2008>)																				
ML 280, ML 320, ML 350	 17"	F	04/08→	ATE 23922		598728	0		330x32 (29,4)	197092										
ML 280, ML 320, ML 350, ML 420	 18"	F	04/08→	ATE 23922		598728	0		350x32											
ML 500		F	04/08→						375x32											
ML 63		F	04/08→						390x											
ML 280, ML 320, ML 350	 17"	R	04/08→	ATE 23923		598802	0		330x14											
ML 280, ML 320, ML 350, ML 420	 18"	R	04/08→	ATE 23923		598802	0		330x22											
ML 500		R	04/08→	ATE 23923		598802	0		330x22											
ML 63		R	04/08→						365x											
MERCEDES  190 (201) (82>93)																				
1.8i, 2.0, 2.0D, 2.0i, 2.5D	F	12/82→08/93	LUC 21010		598241	431821		262x10,9 (9)	186176											
2.3i, 2.5D Turbo, 2.6i, 3.0i	F	07/86→08/93	LUC 21010		598241	431821		262x21,9 (19,4)	186177											
2.3i 16S, 2.5i 16S	F	08/84→1993	LUC 21028		598315	431821		284x21,9 (19,4)	186185	186944										
2.5i 16S Evolution II (eng 173KW)	F	07/89→1993	ATE 21153		598601	431821		300x28 (25,4)	* 186461											

										
MERCEDES  (.../...)										
190 (201) (82>93) (.../...)										
1.8i, 2.0, 2.0D, 2.0i, 2.3i, 2.5D, 2.5D Turbo 2.6i, 3.0i	R	12/82→08/93	ATE 20687 	598105	0		258x9 (7,3)	186184		
2.3i 16S, 2.5i 16S	R	08/84→1993	ATE 20687 	598345	0		258x9 (7,3)	186184		
2.5i 16S Evolution II (eng 173KW)	R	07/89→1993	ATE 21197 	598272	0		278x9 (7,3)	186462		
1.8i, 2.0, 2.0D, 2.0i, 2.3i, 2.3i 16S, 2.5D 2.5D Turbo, 2.5i, 2.5i 16S 2.5i 16S Evolution II (eng 173KW), 2.6i, 3.0i	P	12/82→08/93		562767						
200/300 (W123) (76>85)										
200, 200D, 220D, 230, 230C, 230T, 240D, 240DL 240TD, 250, 250L, 250T, 280, 280C, 280CE 280E, 280EL, 280TE, 300D, 300DL, 300TD 	F	01/76→09/79	ATE 20392 	598109	0		278x12,6 (10,6)	* 186180		
200, 200D, 200T, 230, 230C, 230CE, 230E, 230T 230TE, 240D, 240DL, 240TD, 250, 250L, 250T 280, 280C, 280CE, 280E, 280EL, 280TE, 300D 300DL, 300TD 	F	08/79→07/85	ATE 20392 	598110	431828		278x12,6 (10,6)	* 186180		
200, 200D, 200T, 220D, 230, 230C, 230CE, 230E 230T, 230TE, 240D, 240DL, 240TD, 250, 250L 250T, 280, 280C, 280CE, 280E, 280EL, 280TE 300D, 300DL, 300TD 	R	01/76→07/85					279x10			
200/300 (W124) (84>93)										
200, 200 CE, 200D, 200E, 200T, 200TD, 200TE 250D, 250TD, 300D, 300TD 	F	12/84→06/93	LUC 21028 	598315	431821		284x12 (10)	186182		
200 CE, 200E, 200TE, 220 CE, 250D, 250DL 250TD, 260E, 300 CE, 300D, 300E, 300TD 300TE 	F	01/85→06/93	LUC 21028 	598315	431821		284x21,9 (19,4)	186185	186944	
280EL 	F	10/92→06/93	ATE 21153 	598601	0		284x21,9 (19,4)	186185		
260E, 300D, 300E, 300TD, 300TE 	F	06/85→06/93	LUC 21028 	598315	431821		284x22			
230 CE 	 A797178	F	03/87→	LUC 21028 	598315	431821		284x12 (10)	186182	
	 A797179	F	→1992	LUC 21028 	598315	431821		284x21,9 (19,4)	186185	
230E 	 A805931	F	12/84→	LUC 21028 	598315	431821		284x12 (10)	186182	

											
						WVA					
MERCEDES  (.../...)											
200/300 (W124) (84>93) (.../...)											
230E  (...)	 A805932	F	-1992	LUC 21028 	598315	431821		284x21,9 (19,4)	186185		
230TE 	 F081909	F	03/86→	LUC 21028 	598315	431821		284x12 (10)	186182		
	 F081910	F	-09/92	LUC 21028 	598315	431821		284x21,9 (19,4)	186185		
300 CE, 300E, 300TE 		F	07/89→06/93	ATE 21153 	598601	0		295x21,9 (19,4) *	186460		
320 CE 	 B862121	F	10/92→	ATE 21153 	598601	0		295x21,9 (19,4) *	186460		
	 B862122	F	-06/93					294x25			
400E 	 B938569	F	10/92→	ATE 21153 	598601	0		294x25			
	 B938569	F	-06/93					294x25			
500E 		F	06/90→06/93	ATE 21153 	598601	0		300x28 (25,4) *	186461		
200, 200 CE, 200D, 200E, 220 CE 230 CE, 230E, 250D, 260E, 300D 300E 	ASR(-)	R	12/84→06/93	ATE 20687 	598345	0		258x9 (7,3)	186184		
200T, 200TD, 200TE, 230TE, 250DL 250TD, 260E, 300E, 300TD 320 CE 	ASR(+)	R	03/86→06/93	ATE 21197 	598272	0		278x9 (7,3)	186183		
	ASR(+)	R	03/86→06/93	ATE 21197 	598272	0		278x9 (7,3)	186470		
280EL 		R	10/92→06/93	ATE 21197 	598272	0		278x9			
300 CE 	ASR(-)	R	05/87→06/93	ATE 20687 	598345	0		258x9 (7,3)	186184		
	ASR(+)	R	05/87→06/93					258x9 (7,3)	186184		
300 CE 24V 	ASR(+)	R	07/89→06/93	ATE 21197 	598272	0		278x9 (7,3)	186183		
	ASR(+)	R	07/89→06/93	ATE 21197 	598272	0		278x9 (7,3)	186470		
300TE 		R	03/86→06/93	ATE 21197 	598272	0		278x9 (7,3)	186183		
		R	03/86→06/93	ATE 21197 	598272	0		278x9 (7,3)	186470		
300TE 24V 		R	07/89→09/92	ATE 21197 	598272	0		278x9			
400E 		R	10/92→06/93	ATE 21197 	598272	0		278x24			
500E 	 B927760	R	06/90→	ATE 21197 	598272	0		278x24			



MERCEDES (../..)

200/300 (W124) (84>93) (../..)

500E (...)	B927761	R	-06/93	ATE 21305	598617	0		278x24		
200, 200 CE, 200D, 200E, 200T, 200TD, 200TE 220 CE, 230 CE, 230E, 230TE, 250D, 250DL 250TD, 260E, 280EL, 300 CE, 300D, 300E, 300TD 300TE, 320 CE, 400E, 500E		P	12/84-06/93		562767					

Class A (W168) (97>2004)

A140, A160CDI		F	05/97-06/04	LUC 23070	598549	431828		260x12 (10)	186562	
A140, A160, A170CDI		F	05/97-06/04	LUC 23070	598549	431828		260x22 (19,4)	186573	
A190, A210		F	04/99-06/04	LUC 23070	598549	431828		276x22 (19,4)	186783	
A160, A170CDI, A190, A210		R	04/99-06/04	LUC 23138	598583	0		258x8 (7)	186760	
		P	04/99-06/04		562767					

Class A (W169) (2004>2008)





















































A150, A160CDI		F	07/04-03/08	LUC 24077	598704	0		276x12 (10)	186798	
A170, A180CDI, A200		F	07/04-03/08	LUC 24077	598704	0		276x22 (19,4)	186799	
A200, A200CDI		F	07/04-03/08	LUC 23881	598795	2		288x25 (22,4)	197091	
A150, A160CDI, A170, A180CDI, A200, A200CDI		R	07/04-03/08	LUC 23138	598583	0		258x8 (7)	197036	
		P	07/04-03/08		562767					

Class A (W169) (2008>)













































A150		F	04/08→	LUC 24077	598704	0		276x12 (10)	186798	
A160, A170, A180, A200		F	04/08→	LUC 24077	598704	0		276x22 (19,4)	186799	
A200		F	04/08→	LUC 23881	598795	2		288x25 (22,4)	197091	
A150, A160, A170, A180, A200		R	04/08→	LUC 23138	598583	0		258x8 (7)	197036	

Class B (W245) (2005>2008)











































B150, B170		F	05/05-03/08	LUC 24077	598704	0		276x22 (19,4)	186799	
B180, B200		F	05/05-03/08	LUC 23881	598795	2		288x25 (22,4)	197091	
B150, B170, B180, B200		R	05/05-03/08	LUC 23138	598583	0		258x8 (7)	197036	
		P	05/05-03/08		562767					

																	
MERCEDES  (.../...)																	
Class B (W245) (2008>)																	
B150, B170	F	04/08→	LUC 24077		598704	0		276x22 (19,4)	186799								
B180, B200	F	04/08→	LUC 23881		598795	2		288x25 (22,4)	197091								
B150, B170, B180, B200	R	04/08→	LUC 23138		598583	0		258x8 (7)	197036								
Class C (W202) (93>2001)																	
C180, C200D, C220D, C250D 	F	03/93→02/00	LUC 21439		598013	431828		284x12 (10)	186298								
C180, C200, C200 CDI, C200CDI, C200D, C220 C220 CDI, C220CDI, C220D, C230 	F	03/93→02/01	LUC 21439		598013	431828		284x22 (19,4)	186280								
C200K, C230K, C250TD, C280, C36 	F	05/93→02/01	ATE 21195		598357	431828		284x22 (19,4)	186280								
C200K, C230K, C240, C280 	F	05/93→02/01	ATE 21195		598357	431828		288x25 (22,4)	186467								
C43 AMG, C43AMG 	F	10/97→02/01	ATE 21484		598712	1		334x32									
C180, C200, C200D, C220  C220D, C250D 	R	03/93→	ATE 20687		598345	0		258x8,9 (7,3)	186281								
C180, C200, C200 CDI  C200D, C220, C220 CDI C220D, C230, C250D 	R	→02/00	ATE 21900		598763	0		258x8,9 (7,3)	186281								
C180, C200  C200D, C200K C220D, C230 C230K, C240 C250TD, C280 C36 	R	05/93→	ATE 21197		598272	0		278x9 (7,3)	186470								
C180, C200CDI  C200K, C220CDI C230K, C240 C280 	R	→02/01	ATE 21919		598444	0		278x9 (7,3)	186470								
C180, C200, C200D, C200K, C220 C220D, C230K, C250D, C250TD, C280 C36 	R	03/93→02/00						278x9 (7,3)	186470								
C43 AMG, C43AMG 	R	10/97→02/01	ATE 21305		598617	0		278x24									

MERCEDES (.../...)								
Class C (W202) (93>2001) (.../...)								
C180, C200, C200 CDI, C200CDI, C200D, C200K C220, C220 CDI, C220CDI, C220D, C230, C230K C240, C250D, C250TD, C280, C36, C43 AMG C43AMG	P	03/93→02/01	562767					
Class C (W203) (2000>2003)								
C180, C200, C200CDI, C200CGI, C220CDI 	F	04/00→12/03	LUC 23144	598448	431843	288x25 (22,4)	186864	
C180, C200, C200CDI, C220CDI	F	09/00→12/03	LUC 23144	598448	431843	288x25 (22,4)	186864	
C200, C230, C240, C270CDI, C320	F	04/00→12/03	LUC 23144	598448	431843	300x28		
C30CDI	F	09/02→12/03	BBO 23745	598659	0	345x30		
C32	F	09/00→12/03	BBO 23271	598445	0	345x30		
C180, C200, C200CDI, C200CGI, C220CDI	R	04/00→12/03	ATE 21919	598444	0	278x9 (7,3)	186470	
C180, C200, C200CDI, C200CGI, C220CDI, C230 C240, C270CDI, C320	R	04/00→12/03	ATE 21899	598447	431843	290x10 (8,3)	186469	
C30CDI	A556572 A556573	R	09/02→06/03	ATE 21305	598617	0	290x10 (8,3)	186469
		R	06/03→12/03	ATE 21305	598617	0	278x24	
C30CDI, C32	R	09/00→12/03	ATE 21305	598617	0	278x24		
C180, C200, C200CDI, C200CGI, C220CDI, C230 C240, C270CDI, C30CDI, C32, C320	P	04/00→12/03		562807				
Class C (W203) (2004>)								
C160, C180, C200, C200CDI, C200CGI, C220CDI C220CGI	F	01/04→	LUC 23144	598448	431843	288x25 (22,4)	186864	
C230, C240, C270CDI, C280, C320	F	01/04→	LUC 23144	598448	431843	300x28		
C230, C240, C270CDI, C320	F	01/04→08/07	BBO 23745	598659	0	300x28		
	F	01/04→08/07	ATE 23945	● 601034	0	300x28		
C320CDI, C350	F	01/05→	ATE 23945	● 601034	0	330x28		
C30CDI, C55AMG	F	01/04→	BBO 23745	598659	0	345x30		
C350	F	07/05→08/07	BBO 23745	598659	0	345x30		

 			   			  		
MERCEDES  (.../...)								
Class C (W203) (2004>) (.../...)								
C55AMG 	F	01/04→12/06	BBO 23271 	598445	0		345x30	
C160, C180, C200, C200CDI, C200CGI, C220CDI C220CGI  	R	01/04→	ATE 21919 	598444	0		278x9 (7,3)	186470
C180, C200, C200CDI, C200CGI, C220CDI C220CGI, C230, C240, C270CDI, C280, C30CDI C320, C320CDI, C350   	R	01/04→	ATE 21899 	598447	431843		290x10 (8,3)	186469
C30CDI, C350, C55AMG  	R	01/04→08/07	ATE 21305 	598617	0		278x24	
C180, C200, C200CDI, C200CGI, C220CDI C220CGI, C230, C240, C270CDI, C30CDI, C320 C55AMG  	P	01/04→		562807				
Class C (W204) (2007>)								
C 180, C 200	F	05/07→					288x25 (22,4)	● 197203
C 180, C 200, C 220, C 230, C 250	F	01/07→					295x28 (26)	● 197201
C 200, C 220, C 230, C 250, C 280	F	01/07→					295x28 (25,4)	● 197202
C 250, C 280, C 320, C 350, C 63 AMG	F	01/07→					332x22	
C 180, C 200, C 220, C 230, C 250, C 280	R	01/07→	ATE 24253 	● 601051	0		300x10 (8,3)	● 197127
C 180, C 200	R	05/07→	ATE 24253 	● 601051	0		278x9 (7,3)	● 197128
C 250, C 280, C 320, C 350	R	01/07→	ATE 24253 	● 601051	0		300x22	
C 63 AMG	R	10/07→						
Class CL (W215) (99>2006)								
CL500	F	08/99→04/06	BBO 23271 	598445	0		330x32	
CL55, CL600	F	08/99→04/06	BBO 23271 	598445	0		345x32	
	F	09/02→04/06					360x36	
CL65	F	09/03→04/06						
CL500, CL55, CL600	R	08/99→04/06	ATE 23078 	598446	0			
CL55, CL600, CL65	R	09/02→04/06						
CL500, CL55, CL600	P	08/99→04/06		564007				

MERCEDES (.../...)			
Class CL (W216) (2006>)			
Coupé CL 500	F 06/06→	BBO 23960 ● 598995 0 350x32	
Coupé CL 600	F 05/06→		
Coupé CL 63 AMG, Coupé CL 65 AMG	F 10/06→		
Coupé CL 500	R 06/06→	ATE 23334 ● 598637 0 320x24	
Coupé CL 600, Coupé CL 63 AMG Coupé CL 65 AMG	R 05/06→		
Class CLC (W203) (2008>)			
CLC 180, CLC 200, CLC 220	F 03/08→	LUC 23144 ● 598448 431843 288x25 (22,4) 186864	
CLC 230	F 03/08→	LUC 23144 ● 598448 431843 300x28	
CLC 350	F 03/08→	ATE 23945 ● 601034 0 330x28	
CLC 180, CLC 200, CLC 220	R 03/08→	ATE 21919 ● 598444 0 278x9 (7,3) 186470	
CLC 230, CLC 350	R 03/08→	ATE 21899 ● 598447 0 290x10 (8,3) 186469	
Class CLK (W208) (97>2003)			
CLK200, CLK200K, CLK230K	F 06/97→01/03	ATE 21195 ● 598357 431828 288x25 (22,4) 186467	
CLK200K, CLK230K	F 06/99→02/02	ATE 21195 ● 598357 431828 288x25 (22,4) 186864	
CLK200K, CLK230K, CLK320, CLK430	F 06/97→01/03	ATE 21670 ● 598636 431828 300x28	
CLK430	► F129678,T028296	F 06/98→	ATE 21153 ● 598601 0 318x28
	► F129679,T028297	F -01/03	ATE 21484 ● 598712 1 300x28
CLK430	► F129679,T028297	F -01/03	ATE 21484 ● 598712 1 330x32
CLK430	F 06/98→02/02	ATE 21670 ● 598636 431828 330x32	
CLK55	F 06/99→02/02	ATE 21484 ● 598712 1	
CLK200, CLK200K, CLK230K	R 06/97→01/03	ATE 21919 ● 598444 0 278x9 (7,3) 186470	
CLK200K, CLK230K, CLK320	R 06/97→01/03	ATE 21305 ● 598617 0 290x10 (8,3) 186469	
CLK430	► F129678,T028295	R 06/97→	ATE 21305 ● 598617 0 290x10 (8,3) 186469
	► F129679,T028296	R -01/03	ATE 21305 ● 598617 0 278x24

									
MERCEDES  (.../...)									
Class CLK (W208) (97>2003) (.../...)									
CLK55 	R	06/99→02/02	ATE 21305 	598617	0		278x24		
CLK200, CLK200K, CLK230K, CLK320, CLK430 CLK55	P	06/97→01/03		562767					
Class CLK (W209) (2002>2009)									
CLK 200, CLK 220 	F	03/02→06/09	LUC 23144 	598448	431843		288x25 (22,4)	186864	
CLK 200, CLK 240, CLK 270, CLK 280, CLK 320 CLK 350 	F	03/02→06/09	LUC 23144 	598448	431843		300x28		
CLK 320 	F	06/05→06/09	BBO 23745 	598659	0		330x28		
CLK 350 	F	01/05→06/09	LUC 23144 	598448	431843		330x28		
CLK 500 	F	03/02→06/09	BBO 23745 	598659	0		345x30		
CLK 55 AMG 	F	03/02→06/09	BBO 23745 	598659	0		345x30		
CLK 63 AMG 	F	04/06→06/09							
CLK 200, CLK 220 	R	03/02→06/09	ATE 21919 	598444	0		278x9 (7,3)	186470	
CLK 200, CLK 240, CLK 270, CLK 280, CLK 320 CLK 350 	R	03/02→06/09	ATE 21899 	598447	0		290x10 (8,3)	186469	
CLK 500, CLK 55 AMG 	R	03/02→06/09	ATE 21305 	598617	0		278x24		
CLK 63 AMG 	R	04/06→06/09							
CLK 200, CLK 240, CLK 320, CLK 500 CLK 55 AMG	P	02/03→		562807					
Class CLS (W219) (2004>2008)									
CLS 320CDI	F	06/05→01/08	BBO 23745 	598659	0		312x28		
CLS350, CLS500	F	07/04→01/08	BBO 23745 	598659	0		312x28		
CLS350	F	07/05→01/08	BBO 23960 	● 598995	0		350x32		
CLS55	F	01/05→01/08					360x36		
CLS63	F	04/06→01/08							
CLS 320CDI, CLS350, CLS500	R	07/04→01/08	ATE 23334 	598637	0		300x22 (19,4)	186865	
CLS350, CLS55, CLS63	R	01/05→01/08							



































































MERCEDES (…/…)

Class CLS (W219) (2008>)

CLS 320CDI	F	02/08→	BBO 23745	598659	0		312x28		
CLS 280, CLS 350	F	02/08→	BBO 23745	598659	0		312x28		
CLS 500	F	02/08→	BBO 23960	● 598995	0		350x32		
CLS 63	F	02/08→							
CLS 280, CLS 320CDI, CLS 350	R	02/08→	ATE 23334	598637	0		300x22 (19,4)	186865	
CLS 500, CLS 63	R	02/08→							

Class E (W124) (93>98)

E200D, E250D, E250TD	F	07/93→02/96	LUC 21028	598315	431821		284x12 (10)	186182	
E200, E200T, E220, E250DL, E250TD E300TD	F	07/93→03/98	LUC 21028	598315	431821		284x21,9 (19,4)	186185	186944
E300T, E300TD	4WD(+)	F 07/93→02/96	LUC 21028	598315	431821		284x22		
E300, E300TD	4WD(+)	F 07/93→09/95	LUC 21028	598315	431821		294x25		
E280L, E320 E320T E36 AMG	• 884946, B862121, F242721	F 07/93→	ATE 21153	598601	0		295x21,9 (19,4)	* 186460	
E280L, E320 E320T, E36 E36 AMG	• 884947, B862122, F242722	F →03/98					294x25		
E420	• B938568	F 07/93→					294x25		
	• B938569	F →09/95	ATE 21153	598601	0		320x30		
E500	• B927760	F 07/93→					300x28 (25,4)	* 186461	
	• B927761	F →09/95					320x30		
E200, E200D, E220, E250D, E250TD, E300 E300TD		R 07/93→06/97	ATE 20687	598345	0		258x9 (7,3)	186184	
E200, E200T, E220, E250DL, E250TD, E300T E300TD, E320, E36, E36 AMG		R 07/93→03/98	ATE 21197	598272	0		278x9 (7,3)	186470	
E280L		R	ATE 21197	598272	0		278x9		

											
						WVA		Valeo			
										Valeo	
										Valeo	
MERCEDES  (.../...)											
Class E (W124) (93>98) (.../...)											
E320T 	 F323055	R	07/93→	ATE 21197		598272	0		278x9		
	 F323056	R	→02/96	ATE 21305		598617	0		290x10 (8,3)	186469	
E420 		R	07/93→09/95	ATE 21197		598272	0		278x24		
E500 	 B927760	R	07/93→	ATE 21305		598617	0		278x24		
	 B927761	R	→09/95	ATE 21197		598272	0		300x22 (19,4)	197094	
E200, E200D, E200T, E220, E250D, E250DL E250TD, E280L, E300, E300T, E300TD, E320, E320T, E36 E36 AMG, E420, E500 		P	07/93→03/98			562767					
Class E (W210) (95>2003)											
E200, E200D, E200L, E220, E220D E230, E240, E250D, E250TD, E290TD E300D 	ESP(-)	F	04/95→03/03	ATE 21195		598357	431828		288x25 (22,4)	186467	
E200, E220, E240, E250DL, E270 E280, E280L, E290TDL, E300TD E320 	ESP(+)	F	04/95→03/03	ATE 21670		598636	431828		300x28		
E240 	ESP(+)	F	03/96→06/99	ATE 21195		598357	431828		300x28		
E320 		F	06/99→03/02	ATE 21153		598601	0		300x28		
E420, E430 		F	04/95→03/02	ATE 21153		598601	0		318x28		
E430 		F	09/97→03/02	ATE 21670		598636	431828		318x28		
		F	06/99→03/02	ATE 21484		598712	1		318x28		
		F	06/99→03/02	ATE 21153		598601	0		330x32		
E430 		F	06/99→03/03	ATE 21484		598712	1		330x32		
E50, E55 		F	03/96→03/02	ATE 21484		598712	1				
E200, E200D, E220D, E230 E240, E250D, E290TD E300D 	 A379346	R	04/95→	ATE 21197		598272	0		278x9 (7,3)	186470	
E200, E200D, E220, E220D E230, E240, E250D, E250TD E290TD, E300D 	 A379347	R	→03/03	ATE 21919		598444	0		278x9 (7,3)	186470	

		WVA	Valeo					Valeo	Valeo

MERCEDES (../...)

Class E (W210) (95>2003) (../...)

























































E200, E200L, E220, E230, E240 E250D, E250DL, E250TD, E270 E280, E280L, E290TD, E290TDL E300TD, E320, E420, E430 E55		R	04/95→	ATE 21305	598617	0			
E200, E240, E270, E280 E300TD, E320, E420, E430		R	-03/03	ATE 21899	598447	431843		290x10 (8,3)	186469
E50		R	03/96-06/99	ATE 21305	598617	0		300x22 (19,4)	● 197094
E200, E200D, E220, E220D, E230, E240, E250D E250TD, E270, E280, E290TD, E300D, E300TD E320, E420, E430, E50, E55		P	04/95-03/03		562767				
E220, E250DL, E270, E280L, E290TDL		P	03/96-03/03		562726				



























Class E (W211) (2002>2006)

















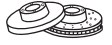















E 200, E 220, E 240, E 270		F	03/02-03/06	BOS 23743	598638	2		295,5x28 (25,4)	186751
E 280, E 320, E 350		F	03/02-03/06	BBO 23745	598659	0		295,5x28 (25,4)	186751
E 240, E 320	4WD(+)	F	03/03-03/06	ATE 21670	598636	431828		303x30	
E 220, E 270, E 280		F	03/02-03/06	BOS 23743	598638	2		312x28	
E 280, E 320, E 350, E 400, E 500		F	03/02-03/06	BBO 23745	598659	0		312x28	
E 350	4WD(+)	F	07/04-03/06	ATE 21484	598712	1		312x28	
E 350, E 500	4WD(+)	F	03/02-03/06	ATE 21484	598712	1		330x32 (29,4)	● 197093
E 55		F	07/02-03/06					360x36	
E 200, E 220, E 240, E 270, E 280, E 320		R	03/02-03/06	ATE 23334	598637	0		300x10 (8,3)	● 197035
E 200, E 220, E 240, E 270, E 280 E 320, E 350, E 400, E 500	SPOR(+)	R	03/02-03/06	ATE 23334	598637	0		300x22 (19,4)	186865
E 55		R	07/02-03/06					300x22 (19,4)	186865









































Class E (W211) (2006>2009)

E200, E200 NGT, E220, E230, E280 E300 BLUETEC, E320		F	04/06-11/09	BOS 23743	598638	2		295,5x28 (25,4)	186751
E280, E320, E350	4WD(+)	F	04/06-11/09	ATE 21670	598636	431828		303x30	

																	
MERCEDES  (.../...)																	
Class E (W211) (2006>2009) (.../...)																	
E350, E350 CGI 	F	04/06→11/09	BBO 23745 	598659	0		312x28										
E220 LONG 	F	04/06→03/09	BOS 23743 	598638	2		330x32 (29,4)	● 197093									
E500  4WD(+)	F	04/06→11/09	ATE 23922 	598728	0		330x32 (29,4)	● 197093									
E420, E500 	F	04/06→11/09	BBO 23960 	● 598995	0		350x32										
E63 	F	04/06→11/09															
E200, E200 NGT, E220, E230, E280 	R	04/06→11/09	ATE 23334 	598637	0		300x10 (8,3)	● 197035									
E220 LONG, E280, E300 BLUETEC, E320, E350 E350 CGI, E500 	R	04/06→11/09	ATE 23334 	598637	0		300x22 (19,4)	186865									
E420, E500 	R	04/06→11/09	ATE 23334 	598637	0		330x26										
E63 	R	04/06→11/09															
Class E (207-212) (2009>)																	
E200, E220, E250 CDI 	F	03/09→					295x28 (25,4)	● 197202									
E250, E350, E500, E63 AMG 	F	03/09→															
E200, E220, E250 	R	03/09→	ATE 23334 	598637	0		300x10 (8,3)	● 197035									
E220, E250 	R	05/09→	ATE 24253 	● 601051	0		300x10 (8,3)	● 197127									
E250 CDI, E350, E500 	R	05/09→	ATE 24253 	● 601051	0												
E350 	R	03/09→	ATE 23334 	598637	0		300x22 (19,4)	186865									
E500 	R	03/09→	ATE 23334 	598637	0												
E63 AMG 	R	06/09→															
Class R (W251) (2005>)																	
R 280, R 320, R 350	F	10/05→	ATE 23922 	598728	0		330x32 (29,4)	● 197092									
R 280, R 320, R 500	F	10/05→	ATE 23922 	598728	0		350x32										
R 500	F	04/08→					375x32										
R 63	F	04/06→05/07															
R 280, R 320, R 350	R	10/05→	ATE 23923 	598802	0		330x14										

																				
						WVA														
MERCEDES  (.../...)																				
Class R (W251) (2005>) (.../...)																				
R 280, R 320, R 500			R	10/05→	ATE 23923		598802	0		330x22										
R 63			R	04/06→05/07																
Class S (W116) (72>80)																				
280, 350, 450			F	08/72→09/80	ATE 20392		598109	0												
			R	08/72→09/80						279x10										
Class S (W126) (79>91)																				
380 SEL 			F	05/80→09/85	ATE 20392		598110	431828		278x12,6 (10,6)	* 186180									
280 S, 280 SE, 280 SEL, 380 SE, 380 SEL 			F	09/79→09/85	ATE 20392		598110	431828		278x22										
380 SEC, 500 SEC 			F	09/81→08/85						286x22										
260 SE, 300 SE, 300 SEL, 420 SE, 420 SEC 420 SEL, 500 SE, 500 SEC, 500 SEL, 560 SE 560 SEC, 560 SEL 			F	09/85→12/91	ATE 20392		598110	431828		300x27,9										
260 SE, 280 S, 280 SE, 280 SEL, 300 SE 300 SEL, 380 SE, 380 SEC, 380 SEL, 420 SE 420 SEC, 420 SEL, 500 SE, 500 SEC, 500 SEL 560 SE, 560 SEC, 560 SEL 			R	09/79→12/91						279x10										
Class S (W140) (91>93)																				
300 					 A023718	F	03/91→				310x28									
300, 400, 500, 600 					 A023719	F	→06/93				320x30									
300 			R	03/91→06/93	ATE 21305		598617	0		290x12										
400, 500, 600 			R	03/91→06/93	ATE 21305		598617	0		300x22 (19,4)	* 186465									
300, 400, 500, 600 			P	03/91→06/93			562726													
Class S (W140) (93>99)																				
CL420, CL500, CL600, S280, S300TD, S320 S320L, S350, S420, S420L, S500, S500L, S600 S600L 			F	07/93→07/99						320x30										
S280, S300TD, S320, S320L, S350 			R	07/93→08/98	ATE 21305		598617	0		290x12										
CL420, CL500, CL600, S420, S420L, S500, S500L S600, S600L 			R	07/93→07/99	ATE 21305		598617	0		300x22 (19,4)	* 186465									

															
MERCEDES  (.../...)															
Class S (W140) (93>99) (.../...)															
CL420, CL500, CL600, S280, S300TD, S320 S320L, S350, S420, S420L, S500, S500L, S600 S600L 		P	07/93-07/99			562726									
Class S (W220) (98>2004)															
S280, S320, S320L		F	09/98-09/04	BBO 23271 	598445	0		312x28							
S280L, S350, S350L		F	03/99-09/04	BBO 23745 	598659	0		312x28							
S350, S350L		F	09/02-09/04	ATE 21670 	598636	431828		312x28							
S320CDI, S320CDIL		F	09/02-09/04	BBO 23745 	598659	0		330x32							
S320CDI, S320CDIL, S400CDI, S430, S430L, S500 S500L		F	09/98-09/04	BBO 23271 	598445	0		330x32							
S430, S430L, S500, S500L		F	09/02-09/04	ATE 21484 	598712	1		330x32							
S55, S600L		F	01/00-09/04	BBO 23271 	598445	0		345x32							
S500L, S600L		F	09/98-09/04					360x32							
S55, S600L		F	06/02-09/04					360x36							
S65		F	01/04-09/04												
S280, S320, S320CDI, S320CDIL, S320L, S400CDI S430, S430L, S500, S500L, S55, S600L		R	09/98-09/04	ATE 23078 	598446	0									
S280L, S320CDI, S320CDIL, S350, S350L, S430 S430L, S500, S500L		R	03/99-09/04	ATE 23334 	598637	0									
S500L, S600L		R	09/98-09/04	ATE 21305 	598617	0									
S55, S600L, S65		R	06/02-09/04												
S280, S280L, S320, S320CDI, S320CDIL, S320L S350, S350L, S400CDI, S430, S430L, S500 S500L, S55, S600L		P	09/98-09/04		564007										
Class S (W221) (2004>)															
S320, S350		F	10/04-06/09	BBO 23960 	598995	0		335x32							
S320 4MATIC, S420, S450, S450 4MATIC, S500 S500 4MATIC, S550 4MATIC, S600		F	10/04-06/09	BBO 23960 	598995	0		350x32							

																		
MERCEDES  (.../...)																		
Class S (W221) (2004>) (.../...)																		
S 63 AMG, S65		F	01/06→06/09															
S320, S320 4MATIC, S350		R	10/04→06/09	ATE 23334		598637	0		300x12									
S420, S450, S450 4MATIC, S500, S500 4MATIC S550 4MATIC, S600		R	10/04→06/09	ATE 23334		598637	0		320x24									
S 63 AMG, S65		R	01/06→06/09															
Class SL (C107) (71>81)																		
350			10/71→	ATE 20011		* 598111	0		278x22									
280, 350, 450 SLC, 500			→02/80	ATE 20392		598109	0		278x22									
280, 380, 450 SLC, 500			09/79→08/81	ATE 20392		598110	431828											
280, 350, 380, 450 SLC, 500		R	10/71→08/81						279x10									
Class SL (R107) (71>89)																		
350		F	04/71→02/80	ATE 20392		598109	0		278x22									
280		F	06/82→07/85	ATE 20392		598109	0		278x22									
280, 380, 500		F	03/80→08/89	ATE 20392		598110	431828		278x22									
300, 420		F	09/85→08/89						284x21,9 (19,4)				186185					
280, 300, 350, 380, 420, 500		R	04/71→08/89						279x10									
Class SL (129) (89>2001)																		
300, 500, SL280, SL320, SL500		F	03/89→07/01	ATE 21153		598601	431826		300x28 (25,4)				* 186461					
SL280, SL320, SL500, SL600		ESP(+)	F	08/93→07/01	BBO 23271		598445	0		300x28 (25,4)			* 186461					
600, SL600		F	06/92→07/01	ATE 21153		598601	431826		320x30									
300, 500, SL280 SL320, SL500			03/89→	ATE 21197		598272	0		278x9 (7,3)				186462					
500, SL500			→07/01	ATE 21305		598617	0		290x10									
			→07/01	ATE 21305		598617	0		278x24									
600, SL320, SL600		R	06/92→07/01	ATE 21305		598617	0		300x22 (19,4)				● 197094					
300, 500, 600, SL280, SL320, SL500, SL600		P	03/89→07/01			562767												

--	--	--	--	--	--	--	--	--

MERCEDES (.../...)

Class SL (230) (2001>2008)

SL350	F	03/03→10/05	BBO 23745	598659	0		312x28		
	F	11/05→01/08	BBO 23745	598659	0		330x32		
SL500	F	08/01→10/05	BBO 23745	598659	0		330x32		
	F	11/05→01/08	BBO 23960	● 598995	0		350x32		
SL55 AMG	F	08/01→10/05					360x36		
	F	11/05→01/08							
SL600	F	04/03→01/08					360x36		
SL65 AMG	F	01/04→01/08							
SL350	R	08/01→01/08	ATE 23334	598637	0		300x12		
SL500	R	08/01→01/08	ATE 23334	598637	0		320x24		
SL350, SL500, SL55 AMG, SL600, SL65 AMG	R	08/01→01/08							

Class SL (230) (2008>)

SL 280, SL 350	F	02/08→	BBO 23745	598659	0		330x32		
SL500	F	02/08→	BBO 23960	● 598995	0		350x32		
SL600	F	02/08→					360x36		
SL 63 AMG	F	02/08→							
SL 65 AMG	F	02/08→							
SL 280	R	02/08→	ATE 23334	598637	0		300x12		
SL 350	R	02/08→	ATE 23334	598637	0				
SL500	R	02/08→	ATE 23334	598637	0		320x24		
SL 63 AMG, SL 65 AMG, SL600	R	02/08→							

Class SLK (170) (96>2003)

SLK200, SLK200K, SLK230K	F	08/96→12/03	ATE 21195	598357	431828		288x25 (22,4)	186467	
SLK320	F	01/00→12/03	ATE 21670	598636	431828		300x28		
SLK32	F	10/01→12/03	ATE 21484	598712	1		330x32		



MERCEDES (.../...)

Class SLK (170) (96>2003) (.../...)

SLK200, SLK200K, SLK230K	F017687	R	08/96→	ATE 21197		598272	0		278x9 (7,3)	186470
	F017688	R	→12/03	ATE 21919		598444	0		278x9 (7,3)	186470
SLK320		R	01/00→12/03	ATE 21919		598444	0		278x9 (7,3)	186470
SLK320 Auto		R	01/00→12/03	ATE 21919		598444	0		278x24	
SLK32		R	10/01→12/03	ATE 21305		598617	0		278x24	
SLK200, SLK200K, SLK230K, SLK32, SLK320		P	08/96→12/03			562767				

Class SLK (171) (2004>2007)





































1.8i		F	01/04→12/07	LUC 23144		598448	431843		288x25 (22,4)	186864
3.0i V6		F	01/05→12/07	LUC 23144		598448	431843		300x28	
3.5i V6		F	01/04→12/07	BBO 23745		598659	0		330x28 (26)	197200
5.4i V8		F	01/04→12/07							
1.8i, 3.0i V6		R	01/04→12/07	ATE 21919		598444	0		278x9 (7,3)	186470
3.5i V6		R	01/04→12/07	ATE 21899		598447	0		290x10 (8,3)	186469
5.4i V8		R	01/04→12/07							
1.8i, 3.5i V6, 5.4i V8		P	01/04→12/07			562807				



































Class SLK (171) (2008>)











































SLK 200, SLK 280		F	01/08→	LUC 23144		598448	431843		300x28	
SLK 350		F	01/08→	ATE 23945		601034	0		345x30	
SLK 55 AMG		F	01/08→	BBO 23745		598659	0			
SLK 200, SLK 280		R	01/08→	ATE 21919		598444	0		278x9 (7,3)	186470
SLK 350		R	01/08→	ATE 21899		598447	0		290x10 (8,3)	186469
SLK 55 AMG		R	01/08→	ATE 21305		598617	0			

Class V (96>2002)





V200, V220, V230, V230TD, V280	F	10/96→12/02	BOS 23022		598299	0		276x22 (19)	186551
	F	10/96→12/02	ATE 21576		598044	431825		276x22 (19)	186551











































																				
MERCEDES  (.../...)																				
Class V (96>2002) (.../...)																				
V200, V220, V230, V230TD, V280 (...)			R	10/96→12/02	BOS 23020 	598301	0		280x9,9 (8)	186552										
			R	10/96→12/02	ATE 21279 	598062	2		280x9,9 (8)	186552										
			P	10/96→12/02		562745														
Vaneo (2001>)																				
1.6i, 1.7CDI, 1.9i			F	10/01→	LUC 23070 	598582	0		270x22 (19,4)	197060										
			R	10/01→	LUC 23138 	598583	0		258x8 (7)	186760										
			P	10/01→		562807														
MERCEDES 																				
MB100																				
2.0D 100, 2.4D 120, 2.4D 140			F	09/89→01/96					238,5x16											
			F	09/89→01/96	BDX 21573 	598000	0		238,5x16 (14,5)	186178										
2.4D 140, 2.4D 160, 2.4D 180			F	09/89→01/96	BDX 20706 	598112	0(B)		263x24 (22)	* 186612										
Sprinter (95>2006)																				
208CDI, 208D, 210D, 211CDI, 212D, 213CDI, 214 216CDI, 308CDI, 308D, 310D, 311CDI, 312D 313CDI, 314, 316CDI			F	02/95→02/06	ATE 21576 	598044	431825		276x22 (20)	* 186774										
			F	02/95→02/06	ATE 21576 	598044	431825		276x22 (20)	* 186774										
208CDI, 208D, 210D, 211CDI, 212D, 213CDI, 214 216CDI, 308CDI, 308D, 310D, 311CDI, 312D 313CDI, 314, 316CDI			F	02/95→02/06	BBO 29076 	541664	2		276x22 (20)	* 186774										
			F	02/95→02/06	BBO 29076 	541664	2		276x22 (20)	* 186774										
616CDI			F	06/01→02/06																
208CDI, 208D, 211CDI, 212D, 213CDI, 214			R	02/95→02/06	ATE 21621 	598045	0		258,5x12 (10)	197033										
208CDI, 208D, 210D, 211CDI, 212D, 213CDI, 214 216CDI, 308CDI, 308D, 310D, 311CDI, 312D 313CDI, 314, 316CDI			R	02/95→02/06	ATE 21661 	598046	0		272x16 (14)	187045										
			R	02/95→02/06	BOS 23021 	598300	0		272x16 (14)	187045										







































															
MERCEDES  (.../...)															
Sprinter (95>2006) (.../...)															
408CDI, 408D, 410D, 411CD, 411CDI, 412D 413CDI, 414, 416CDI	R	02/95→02/06	BBO 29076		541664	2		285x21,9 (19)	●	197059					
616CDI	R	06/01→02/06	LUC 29835		541655	2									
Sprinter II (2006>)															
209CDI, 211CDI, 213CDI, 215CDI, 218CDI, 224 309CDI, 311CDI, 313CDI, 315CDI, 318CDI, 324	F	02/06→	BBO 29192		598882			300x28 (25)	●	187141					
411CDI, 509CDI, 511CDI, 515CDI, 518CDI	F	02/06→	BBO 29200		598881			300x28 (25)	●	187141					
209CDI, 211CDI, 213CDI, 215CDI, 218CDI, 224 309CDI, 311CDI, 313CDI, 315CDI, 318CDI, 324 411CDI, 509CDI, 511CDI, 515CDI, 518CDI	R	02/06→	BOS 29190		541728	0		298x16 (14)	●	197030					
509CDI, 511CDI, 515CDI, 518CDI	R	02/06→	BOS 29190		598876			303x28 (25)	●	187146					
Transporter 207-410 (77>96)															
207D, 208, 208D, 209D, 210, 210D, 307D, 308 308D, 309D, 310, 310D	F	04/77→02/96	PER 20784		598613	0		280x16							
407D, 408D, 409D, 410, 410D			→  A 025460	F	04/77→	PER 20784		598613	0		280x22				
			 A 025461	F	-02/96	PER 20784		598613	0		280x22				
Viano (2003>)															
2.0Cdi, 2.2Cdi, 3.2i, 3.7i	F	01/03→	BOS 24007		598764	2		300x28 (25)		186890					
2.0Cdi, 2.2Cdi, 3.2i, 3.5i V6, 3.7i	F	04/07→	BBO 29192		598882			300x28 (25)		186890					
	R	01/03→	BOS 24008		598765	2		296x10 (8)		186858					
Vito (96>2003)															
2.0i, 2.2CDI, 2.3D, 2.3TD, 2.3i	F	01/96→09/03	BOS 23022		598299	0		276x22 (19)		186551					
	F	01/96→09/03	ATE 21576		598044	431825		276x22 (19)		186551					
	R	01/96→09/03	BOS 23020		598301	0		280x9,9 (8)		186552					
	R	01/96→09/03	ATE 21279		598062	2		280x9,9 (8)		186552					
	P	01/96→09/03			562745										
Vito (2003>)															
2.2CDI, 3.2i, 3.2i V6, 3.7i V6	F	01/03→	BOS 24007		598764	2		300x28 (25)		186890					

													
MERCEDES  (.../...)													
Vito (2003>) (.../...)													
2.2CDI, 3.0CDI V6, 3.5i V6	F	09/07→	BBO 29192		598882					300x28 (25)	186890		
2.2CDI, 3.2i, 3.2i V6, 3.7i V6	R	01/03→	BOS 24008		598765	2				296x10 (8)	186858		
MG 													
Midget (62>80)													
1.1, 1.3	F	1962→1974								209x7,7			
1.5	F	09/74→12/79	AP 20038		598392	0							
MG F (95>2002)													
1.6i, 1.8i, 1.8i VVC (110KW)	F	03/95→03/02	LUC 21518		598254	0				240x22 (20,5)	* 186613		
1.8i VVC (118KW)	F	10/01→03/02								240x22 (20,5)	* 186613		
1.6i, 1.8i, 1.8i VVC (110/118KW)	R	03/95→03/02	LUC 21682		● 598903	2				240x10			
MG TF (2002>2005)													
1.6i, 1.8i	F	03/02→04/05	LUC 21518		598254	0				240x22 (20,5)	* 186613		
1.8i VVC	F	03/02→04/05											
1.6i, 1.8i, 1.8i VVC	R	03/02→04/05	LUC 21682		● 598903	2				240x10			
MG ZR (2001>2005)													
1.4i	F	06/01→04/05	LUC 21515		598022	2				262x12 (11)	186620		
1.8i, 2.0TD	F	06/01→04/05	LUC 21515		598022	2				262x21 (19)	186438		
1.8i VVC	F	06/01→04/05	LUC 23095		598436	2				282x25			
1.8i	R	06/01→04/05	AKE 21312		598053	2				238,5x10 (8)	186435		
1.8i VVC, 2.0TD	R	06/01→04/05	AKE 21719		598682	2				260x10			
MG ZS (2001>2005)													
1.6i	F	07/01→04/05	LUC 23095		598436	2				262x21 (19)	186438		
1.8i, 2.0TD, 2.5i V6	F	07/01→04/05	LUC 23095		598436	2				282x25			
1.6i, 1.8i, 2.0TD, 2.5i V6	R	07/01→04/05	AKE 21719		598682	2				260x10			
MG ZT (2001>2005)													
1.8i, 1.8i Turbo, 2.0CDTi, 2.5i V6	F	06/01→04/05	ATE 23114		598632	0				325x25			



















































MG (.../...)								
MG ZT (2001>2005) (.../...)								
2.5i V6, 4.6i V8	F	10/01→04/05	ATE 23183	598811	0		325x25	
1.8i, 1.8i Turbo, 2.0CDTi, 2.5i V6	R	06/01→04/05	ATE 21934	598753	431827		280x9,8 (8)	● 197016
4.6i V8	R	10/01→04/05	ATE 21934	598753	431827			
1.8i, 1.8i Turbo, 2.0CDTi, 2.5i V6, 4.6i V8	P	06/01→04/05		564028				
MINI								
MINI (R50/52/53) (2001>)								
1.4CRTDI, 1.4d, 1.6i	F	09/01→	ATE 23282	598413	0		276x22 (20,4)	186762
1.6i Cooper Works 16V	F	11/03→	LUC 23984	● 598925	2		294x22	
1.4CRTDI, 1.4d, 1.6i, 1.6i Cooper Works 16V	R	09/01→	ATE 23716	598643	0		259x9,9 (8,4)	186812
MINI (R56/57) (2006>)								
1.4i, 1.6d, 1.6i	F	11/06→	LUC 23915	598699	0		280x22 (20,4)	● 197074
1.6i Turbo	F	11/06→	LUC 23984	● 598925	2		294x22 (20,4)	● 197160
1.6i Cooper S JCW Turbo	F	09/08→					316x22	
1.4i, 1.6d, 1.6i, 1.6i Turbo	R	11/06→	LUC 24289	● 601041	0		259x9,9 (8,4)	186812
1.6i Cooper S JCW Turbo	R	09/08→					280x10	
MINI (R56/57) (2009>)								
1.4i, 1.4i 75, 1.6i	F	03/09→	LUC 23915	598699	0		280x22 (20,4)	● 197074
1.6i Turbo	F	06/09→	LUC 23984	● 598925	2		294x22 (20,4)	● 197160
1.6i Turbo JCW 211 16V	F	07/09→					316x22	
1.4i, 1.4i 75, 1.6i, 1.6i Turbo	R	03/09→	LUC 24289	● 601041	0		259x9,9 (8,4)	186812
1.6i Turbo JCW 211 16V	R	07/09→	LUC 24289	● 601041	0		280x10	
MINI Clubman (2007>)								
1.6 d, 1.6d, 1.6i	F	08/07→	LUC 23915	598699	0		280x22 (20,4)	● 197074
1.6i Cooper S	F	08/07→03/09	LUC 23984	● 598925	2		294x22 (20,4)	● 197160
1.6i Cooper S JCW Turbo	F	09/08→					316x22	
1.6 d, 1.6d, 1.6i, 1.6i Cooper S	R	08/07→	LUC 24289	● 601041	0		259x9,9 (8,4)	186812









































									
MINI  (.../...)									
MINI Clubman (2007>) (.../...)									
1.6i Cooper S JCW Turbo	R	09/08→	LUC 24289		● 601041	0		280x10	
MINI Clubman (2009>)									
1.4i One 16V, 1.6i Cooper 16V	F	03/09→	LUC 23915		● 598699	0		280x22 (20,4)	● 197074
1.6i Cooper S 16V	F	03/09→	LUC 23984		● 598925	2		294x22 (20,4)	● 197160
1.6i Turbo JCW 211	F	03/09→						316x22	
1.4i One 16V, 1.6i Cooper 16V 1.6i Cooper S 16V	R	03/09→	LUC 24289		● 601041	0		259x9,9 (8,4)	186812
1.6i Turbo JCW 211	R	03/09→	LUC 24289		● 601041	0		280x10	
MINI Countryman (2010>)									
1.4i 98, 1.6D 110, 1.6D 90, 1.6i 122	F	08/10→						294x22	
1.6i Turbo 184	F	08/10→						307x24	
1.4i 98, 1.6D 110, 1.6D 90, 1.6i 122 1.6i Turbo 184	R	08/10→						280x10	
MITSUBISHI 									
L200 (K1/2/3) (86>2001)									
1.6, 2.0, 2.4i, 2.5D 	F	11/86→11/97	AKE 20512		● 598597	2		258,5x22 (20,4)	* 186664
1.6, 2.4i, 2.5D 	F	03/90→03/01						258,5x22 (20,4)	* 186664
2.0 4WD, 2.4i 4WD, 2.5D 4WD, 2.6 4WD 	F	11/86→11/97	AKE 20512		● 598597	2		277x22 (20,4)	* 186653
2.5D 4WD, 3.0i 4WD V6 	F	03/90→03/01						277x22 (20,4)	* 186653
2.5D 4WD 	F	06/94→12/96	AKE 21363		● 598517	2		276x24 (22,4)	186719
L200 (K6/7) (96>2007)									
2.0i 2WD, 2.5D 2WD, 2.5TD 2WD	F	01/96→12/07	AKE 23316		● 598523	2		254x24	
2.5D 2WD, 2.5TD 2WD	ABS(+)	F	01/96→12/07	AKE 23290		2		254x24	
2.5TD 4WD	F	01/96→03/98	AKE 23290		● 598522	2		276x24 (22,4)	186719
2.5D 4WD, 2.5TD 4WD	ABS(+)	F	01/96→05/01	AKE 21363		2		276x24 (22,4)	186719
2.4i 4WD, 2.5TD 4WD	F	07/01→12/07	SUM 23879		● 598855	1		314x24	
2.5TD 4WD	F	12/03→12/07	AKE 23316		● 598523	2			







































															
MITSUBISHI  (.../...)															
L200 (K6/7) (96>2007) (.../...)															
2.5TD 4WD (...)	ABS(+)	F	12/03→12/07	AKE 21363		598517	2								
L200 (K84T) (2006>)															
2.5TD		F	01/06→	TOK 24529		598893	2		294x28						
Montero (V2/4) (93>2006)															
2.5TD, 2.8TD		F	11/93→08/06	AKE 21363		598517	2		276x24 (22,4)	186719					
		R	11/93→08/06	AKE 21840		598519	2		315x18 (16,4)	* 186691					
Montero Sport (K9) (98>2009)															
2.5TD		F	08/98→02/09	AKE 21363		598517	2		276x24 (22,4)	186719					
2.5TD, 3.0i V6		F	08/98→02/09	AKE 21370		601020	2		314x24						
		R	08/98→02/09	SUM 23593		598778	2		315x18 (16,4)	* 186691					
Outlander (CU) (2003>2008)															
2.0i, 2.0i Turbo, 2.4i		F	06/03→12/08	AKE 21370		601020	2		293x24						
		R	06/03→12/08	AKE 24014		598852	2		262x10						
Outlander (CW) (2006>)															
2.0DI-D, 3.0 V6		F	11/06→						293x24						
		R	11/06→	AKE 23582		598520	2		302x10 (8,4)	197116					
Pajero (L0/1) (83>91)															
2.3TD, 2.5TD, 2.6		F	01/83→05/87	AKE 21373		598620	0		255x20						
2.3TD, 2.5TD, 2.6, 2.6i		F	09/84→05/87						276x20						
2.5TD, 2.6	⊙ 14"	F	06/87→06/91	AKE 20512		598597	2		258x22						
2.5TD, 2.6, 2.6i, 3.0i V6	⊙ 15"	F	06/87→06/91	AKE 20512		598597	2		277x22 (20,4)	* 186653					
Pajero (V2/4) (90>2001)															
2.4i, 2.5TD, 3.0i V6		F	12/90→10/93	AKE 21363		598517	2		276x24 (22,4)	186719					
2.5D, 2.6i		F	04/91→05/95						277x22 (20,4)	* 186653					
2.5D		F	06/95→05/99	AKE 23290		598522	2		276x24 (22,4)	186719					
2.5TD, 2.8D, 2.8TD, 3.0i V6		F	11/93→05/01	AKE 21363		598517	2		276x24 (22,4)	186719					
3.5i V6		F	11/93→02/00	AKE 21363		598517	2		276x27						



















										
MITSUBISHI  (.../...)										
Pajero (V2/4) (90>2001) (.../...)										
2.4i, 2.5TD, 2.8TD, 3.0i V6, 3.5i V6	R	12/90→	AKE 21840 	598519	2		315x18 (16,4) * 186691			
Pajero (VD/VF) (2000>2006)										
2.5TD, 3.2DI-D, 3.5GDI V6	F	02/00→08/06	SUM 21016 	598518	2		290x26 (24,4) 186813			
	R	02/00→08/06	AKE 23582 	598520	2		298x22			
Pajero (2006>)										
3.2DI-D, 3.8i V6 (3 doors)	F	09/06→	SUM 21016 	598518	2					
3.2DI-D, 3.8i V6 (5 doors)	F	09/06→								
3.2DI-D, 3.8i V6 (3 doors)	R	09/06→	AKE 23582 	598520	2		298x22			
3.2DI-D, 3.8i V6 (5 doors)	R	09/06→	SUM 21947 	598777	0					
Pajero Sport (K9) (98>2009)										
2.5TD	F	08/98→02/09	AKE 21363 	598517	2		276x24 (22,4) 186719			
2.5TD, 3.0i V6	F	08/98→02/09	AKE 21370 	● 601020	2		314x24			
	R	08/98→02/09	SUM 23593	598778	2		315x18 (16,4) * 186691			
Pajero Pinin (H7) (99>)										
1.8GDI, 1.8i, 2.0GDI	F	08/99→	AKE 23487 	598521	1		285x22 (20,4) ● 197067			
1.8GDI, 2.0GDI	R	08/99→	AKE 21706 	598834	2		260x10			
Sapporo (76>90)										
2.4i 	F	02/87→12/90					256x24 (22,4) 186648			
	R	02/87→12/90	AKE 21706 	598834	2		266x18			
Shogun (L0/1) (83>91)										
2.3TD, 2.5TD, 2.6	F	01/83→05/87	AKE 21373 	598620	0		255x20			
	F	09/84→05/87					276x20			
2.5TD, 2.6	⊙ 14"	F	06/87→06/91	AKE 20512 	598597	2		258x22		
2.5TD, 2.6, 3.0i V6	⊙ 15"	F	06/87→06/91	AKE 20512 	598597	2		277x22 (20,4) * 186653		
Shogun (V2/4) (90>2001)										
2.5D	F	04/91→05/95					277x22 (20,4) * 186653			
	F	06/95→05/99	AKE 23290 	598522	2		276x24 (22,4) 186719			































































MITSUBISHI (.../...)											
Shogun (V2/4) (90>2001) (.../...)											
2.5TD, 2.8D, 2.8TD, 3.0i V6	F	12/90→05/01	AKE 21363	598517	2		276x24 (22,4)	186719			
3.5i V6	F	11/93→05/01	AKE 21363	598517	2		276x27				
2.5TD, 2.8TD, 3.0i V6, 3.5i V6	R	12/90→05/01	AKE 21840	598519	2		315x18 (16,4)	* 186691			
Shogun (V6/7) (2000>2006)											
2.5TD, 3.2DI-D, 3.5GDI V6	F	02/00→08/06	SUM 21016	598518	2		290x26 (24,4)	186813			
	R	02/00→08/06	AKE 23582	598520	2		298x22				
Shogun (2006>)											
3.2DI-D, 3.8i V6 (3 doors)	F	09/06→	SUM 21016	598518	2						
3.2DI-D, 3.8i V6 (5 doors)	F	09/06→									
3.2DI-D, 3.8i V6 (3 doors)	R	09/06→	AKE 23582	598520	2		298x22				
3.2DI-D, 3.8i V6 (5 doors)	R	09/06→	SUM 21947	598777	0						
Shogun Pinin (99>)											
1.8GDI, 1.8i, 2.0GDI	F	08/99→	AKE 23487	598521	1		285x22 (20,4)	● 197067			
1.8GDI, 2.0GDI	R	08/99→	AKE 21706	598834	2		260x10				
Space Runner (N1/2) (91>)											
1.8i, 2.0TD	F	06/91→	SUM 21647	598625	0		256x24 (22,4)	186648			
2.0i, 2.4GDi	F	05/99→04/00	AKE 21370	● 601020	2		276x24				
	F	05/00→	AKE 23584	598886	2		276x26				
1.8i, 2.0TD	R	06/91→	AKE 21706	598834	2		262x18				
2.0i, 2.4GDi	R	05/99→	AKE 21706	598834	2		262x10				
MITSUBISHI											
3000 GT (90>2000)											
3.0i Turbo	F	04/90→05/93	AKE 21363	598517	2		276x24				
	F	06/92→03/00					313x30				
	R	04/90→05/93	AKE 21706	598834	2		266x18				
	R	06/92→03/00					284x20				









































										
MITSUBISHI  (.../...)										
Carisma (95>99)										
1.6i, 1.9TD	F	05/95→02/99	LUC 23080		598320	2		236x18 (16,4)	186818	
1.8GDI, 1.8i	F	05/95→02/99	LUC 21920		598318	2		256x24 (22,4)	186648	
1.6i	R	05/95→02/99	AKE 21872		598844	2		260x10		
1.8i	R	05/95→02/99	AKE 21872		598844	2		260x10 (8,4)	186647	
Carisma (99>2003)										
1.6i, 1.8i, 1.9TD	⊙ 14"	F	03/99→06/00	LUC 21920		598318	2		256x24 (22,4)	186648
1.8GDI, 1.8i	⊙ 14"	F	03/99→12/03	LUC 21983		598493	0		256x24 (22,4)	186648
1.6i, 1.8GDI, 1.8i, 1.9DI-D	⊙ 15"	F	03/99→12/03	LUC 21983		598493	0		281x24 (21,5)	186707
		R	03/99→	LUC 21861		598319	2		260x10 (8,4)	186647
1.6i		R	07/00→	LUC 21861		598319	2		260x10	
Challenger (98>)										
2.5TD	F	10/98→	AKE 21363		598517	2		276x24 (22,4)	186719	
2.5TD, 3.0i V6	F	10/98→	AKE 21370		601020	2		314x24		
2.5TD	F	05/00→								
2.5TD, 3.0i V6	R	10/98→	SUM 23593		598778	2		315x18 (16,4)	* 186691	
Colt (A15) (78>84)										
1.2, 1.4	F	03/78→04/83						229x13		
1.4 Turbo	F	10/79→04/83	AKE 20955		598220	0		242x18		
Colt (C1) (84>89)										
1.2, 1.3, 1.5	F	01/84→02/89	SUM 21126		598224	0		243x13		
1.6 Turbo, 1.8D	F	01/84→06/88	AKE 20955		598220	0		242x18		
Colt (C5) (88>92)										
1.3, 1.5 	F	04/88→05/90	SUM 21126		598224	0		243x13		
	F	06/90→05/92	SUM 21650		598626	0		234x13		
1.8D 	F	12/89→05/90						242x18		
1.3, 1.5, 1.8D 	F	04/88→05/90	AKE 20955		598220	0		242x18		











































			R P F		2.3		WVA		Valeo		Valeo		Valeo		
MITSUBISHI  (.../...)															
Colt (C5) (88>92) (.../...)															
1.3, 1.5, 1.8D  (...)	F	06/90→05/92										236x18 (16,4)	186476		
1.8 16V GTI 	F	11/89→05/92	SUM 21647		598625	0						236x18 (16,4)	186476		
1.6 16V GTI 	F	04/88→05/90	AKE 20955		598220	0						266x24			
1.6 16V GTI, 1.8 16V GTI 	R	04/88→05/92	AKE 21125		598964	0						265x10			
Colt (CA) (91>96)															
1.3	F	12/91→12/96	SUM 21650		598626	0						234x13			
1.3, 1.6	F	12/91→12/96										236x18 (16,4)	186818		
1.8	F	12/91→12/96	SUM 21647		598625	0						256x24			
1.3, 1.6	R	12/91→12/96	AKE 21872		598844	2						236x10			
1.8	R	12/91→12/96	AKE 21872		598844	2						260x10			
Colt (CJ) (95>2003)															
1.3i 12V, 1.5	F	11/95→05/00										236x18 (16,4)	186818		
1.3i, 1.3i Auto 12V, 1.6i, 1.6i Auto	F	11/95→06/03										236x18 (16,4)	186818		
Colt (230) (2004>)															
1.1i, 1.3i Mivec, 1.5DI-D, 1.5i Mivec 	F	04/04→	LUC 21920		598318	2						256x24 (21,5)	● 197214		
1.5i Turbo 	F	06/05→	LUC 21983		598493	0						281x26			
1.1i, 1.3i Mivec, 1.5DI-D, 1.5i Mivec 1.5i Turbo 	R	04/04→	LUC 21861		598319	2						250x10 (8)	● 197129		
Cordia (A21) (81>85)															
1.6, 1.8	F	11/81→1985										243x13			
1.6 Turbo	F	11/81→1985										242x18			
1.8 4WD	F	11/81→1985	AKE 20955		598220	0						266x24			
1.8 Turbo	F	06/83→1985	AKE 20955		598220	0						266x24			
Galant (D16) (80>84)															
1.6	F	05/80→05/84	AKE 20955		598220	0						255x12,5			
2, 2.3TD	F	05/80→05/84	AKE 21373		598620	0						255x12,5			



																		
MITSUBISHI  (.../...)																		
Galant (D16) (80>84) (.../...)																		
2 Turbo		F	09/81→05/84										256,5x24					
2		R	05/80→05/84										247x10					
2 Turbo		R	09/81→05/84										247x18					
Galant (E1) (84>87)																		
1.6		F	05/84→11/87	AKE 20955		598220	0						242x18					
	☉ 14"	F	05/84→11/87										242x18					
1.6, 1.8TD, 2.0, 2.0 Turbo, 2.4		F	05/84→11/87	AKE 20955		598220	0						266x24					
1.6	☉ 14"	F	05/84→11/87										266x24					
2.0, 2.0 Turbo, 2.4		R	05/84→11/87	AKE 21125		598964	0						265x10					
Galant (E3) (87>92)																		
1.6		F	12/87→05/90	AKE 20955		598220	0						242x18					
		F	06/90→10/92										236x18 (16,4)	186476				
1.6, 1.6 Auto		F	06/90→10/92	SUM 21650		598626	0						236x18 (16,4)	186476				
1.8, 1.8 Auto, 1.8TD, 1.8TD Auto, 2.0 2.0 16V, 2.0 4WD, 2.0 4WD 4WS, 2.0 Auto		F	12/87→05/90	AKE 20955		598220	0						266x24					
1.8, 1.8 Auto, 1.8TD, 1.8TD Auto, 2.0 2.0 Auto, 2.0 16V, 2.0 4WD, 2.0 4WD 4WS 2.0 Auto		F	10/89→10/92	SUM 21647		598625	0						256x24 (22,4)	186648				
2.0 4WD 4WS 16V		F	11/89→10/92	AKE 21363		598517	2						276x24					
1.8, 1.8 Auto, 2.0, 2.0 16V 2.0 4WD, 2.0 4WD 4WS 2.0 4WD 4WS 16V, 2.0 Auto	ABS(+)	R	12/87→10/92	AKE 21125		598964	0						265x10					
	ABS(+)	R	12/87→10/92										265x10					
Galant (E5) (92>96)																		
1.8, 2.0, 2.0 V6, 2.0TD		F	11/92→09/96	SUM 21647		598625	0						256x24 (22,4)	186648				
2.5 V6		F	11/92→05/96										276x24					
1.8, 2.0, 2.0 V6, 2.0TD		R	11/92→09/96	AKE 21706		598834	2											





















		R P F		2+2		WVA		Valeo		Valeo		Valeo	
MITSUBISHI  (.../...)													
Galant (E5) (92>96) (.../...)													
2.5 V6	R	11/92→05/96											
Galant (EA) (96>2003)													
2.0TD, 2.0i, 2.5i V6	F	10/96→02/00	SUM 21647		598625	0		256x24 (22,4)	186648				
2.0i	F	07/99→02/00	AKE 21363		598517	2		256x24 (22,4)	186648				
	⊙ 15"	F	07/99→02/00	SUM 21647		598625	0		276x24				
2.4i	F	12/98→02/00	AKE 21363		598517	2		276x24					
2.0i, 2.4GDI, 2.5i V6	⊙ 15"	F	03/00→05/03	AKE 23584		598886	2		276x26				
2.0i, 2.4GDI, 2.4i, 2.5i V6	R	10/96→05/03	AKE 21706		598834	2		262x18					
Galant (2006>)													
2.4i	F	07/06→	AKE 23584		598886	2							
	R	07/06→	AKE 21706		598834	2							
Grandis (2004>)													
2.0Di-D, 2.4i	F	01/04→	SUM 21016		598518	2							
	⊙ 17"	F	01/04→	SUM 21016		598518	2						
	R	01/04→	AKE 23582		598520	2							
Lancer (A17) (79>83)													
1.6	F	03/79→02/83	AKE 20955		598220	0		232x13					
Lancer (CB/CD4) (92>)													
1.6i, 2.0D 	F	06/92→						236x18 (16,4)	186818				
1.6i 4WD 	F	06/92→	SUM 21647		598625	0		256x24 (22,4)	186648				
1.6i, 2.0D 	R	06/92→	AKE 21872		598844	2		236x10					
Lancer (CK1/CP) (95>)													
1.3i 	F	11/95→						236x18 (16,4)	186818				
1.3i, 1.5i, 1.6i 	F	11/95→						236x18 (16,4)	186818				
Lancer F (C1) (84>88)													
1.2, 1.5 	F	01/84→06/88	SUM 21126		598224	0		243x13					
1.8D 	F	01/84→06/88	AKE 20955		598220	0		242x18					



























																		
MITSUBISHI  (.../...)																		
Lancer F (CV) (85>92)																		
1.5 	F	07/85→05/90	SUM 21126 	598224	0		243x13											
	F	07/85→05/90	AKE 20955 	598220	0		242x18											
	F	06/90→03/92	SUM 21650 	598626	0		234x13											
	F	06/90→03/92						236x18 (16,4)	186476									
1.8 4WD, 1.8D 	F	07/85→05/90	AKE 20955 	598220	0		242x18											
	F	06/90→03/92					236x18 (16,4)	186476										
Lancer F (C6/7) (88>95)																		
1.2, 1.3, 1.5, 1.5 Auto 	F	04/88→05/90	SUM 21126 	598224	0		243x13											
1.5, 1.5 Auto 	F	12/89→05/90					243x13											
1.2, 1.3, 1.5, 1.5 Auto 	F	06/90→05/92	SUM 21650 	598626	0		234x13											
1.5, 1.5 Auto 	F	06/90→07/95					234x13											
1.3, 1.3 Auto 	F	04/88→05/90	SUM 21126 	598224	0		242x18											
1.3, 1.5, 1.5 Auto, 1.8 4WD, 1.8D 	F	04/88→05/90	AKE 20955 	598220	0		242x18											
1.8D 	F	12/89→05/90					242x18											
1.3 Auto 	F	06/90→05/92	SUM 21650 	598626	0		236x18 (16,4)	186476										
1.3, 1.5, 1.5 Auto, 1.6, 1.6 4WD 1.6 Auto, 1.8 4WD, 1.8D, 2D 	ABS(-) F	06/90→07/95					236x18 (16,4)	186476										
1.5, 1.5 Auto 	F	06/91→04/92					236x18 (16,4)	186476										
1.6, 1.6 Auto, 1.8 16V 	ABS(+) F	11/89→07/95	SUM 21647 	598625	0		236x18 (16,4)	186476										
1.6 16V 	F	04/88→05/90	AKE 20955 	598220	0		266x24											
1.6, 1.6 16V, 1.6 Auto, 1.8 16V 	R	04/88→07/95	AKE 21125 	598964	0		265x10											
Lancer F (CB/CD) (91>96)																		
1.3 	F	05/92→12/96	SUM 21650 	598626	0		234x13											
1.3, 1.5 	F	12/91→10/96					234x13											
1.3, 1.6, 1.6 4WD, 2.0D 	F	05/92→12/96					236x18 (16,4)	186818										









































			 		 		 		 		
MITSUBISHI  (.../...)											
Lancer F (CB/CD) (91>96) (.../...)											
1.8 16V 	F	05/92→12/96	SUM 21647 	598625	0		256x24				
1.3, 1.6, 1.6 4WD, 2.0D 	R	05/92→12/96	AKE 21872 	598844	2		236x10				
1.8 16V 	R	05/92→12/96	AKE 21872 	598844	2		260x10				
Lancer (CS/CT) (2003>)											
1.3, 1.6i, 2.0i	F	06/03→	AKE 23584 	598886	2		276x26				
	F	06/03→	SUM 24291 	598864	2		276x26				
	R	06/03→	AKE 24014 	598852	2		262x10				
1.6i, 2.0i	SPOR(+)	R	06/03→	AKE 24014 	598852	2		262x18			
Lancer Evolution (98>)											
2.0i Evolution V 4WD Turbo 2.0i Evolution VI 4WD Turbo	F	01/98→09/00	AKE 21370 	● 601020	2		276x24				
	F	01/98→09/00	BBO 23092 	● 598919	1		276x24				
2.0i Evolution VII 4WD Turbo	F	12/00→02/03	AKE 21370 	● 601020	2		276x24				
2.0i Evolution V 4WD Turbo 2.0i Evolution VI 4WD Turbo 2.0i Evolution VII 4WD Turbo	⊙ 17"	F	01/98→02/03	AKE 21370 	● 601020	2		320x32			
2.0i Evolution V 4WD Turbo 2.0i Evolution VI 4WD Turbo 2.0i Evolution VII 4WD Turbo 2.0i Evolution VIII 4WD Turbo	⊙ 17"	F	01/98→07/05	BBO 23092 	● 598919	1		320x32			
2.0i Evolution VII 4WD Turbo	⊙ 17"	F	05/01→02/03	BBO 23092 	● 598919	1					
2.0i Evolution IX 4WD Turbo	F	08/05→07/07	BBO 23092 	● 598919	1						
2.0MIVEC Evolution X 4WD Turbo 16V 2.0MIVEC Evolution X TC-SST 4WD Turbo 16V	F	08/07→									
2.0i Turbo	R	01/98→07/07	BBO 21580 	● 598914	2						
2.0MIVEC Turbo, 2.0i Turbo	R	01/98→									
Lancer (CY) (2007>)											
1.5MIVEC, 1.8MIVEC, 2.0MIVEC	F	03/07→	AKE 23584 	598886	2						





































															
MITSUBISHI  (.../...)															
Lancer (CY) (2007>) (.../...)															
1.5MIVEC, 2.0DI-D	F	06/07→	AKE 23584		598886	2									
1.5MIVEC, 1.8MIVEC, 2.0DI-D, 2.0MIVEC	R	03/07→													
Lancer Sportback (CX) (2008>)															
1.8MIVEC, 2.0DI-D	F	07/08→	AKE 23584		598886	2									
	R	07/08→													
Sigma (F16) (90>94)															
3.0i V6 	F	10/90→10/94	AKE 21363		598517	2		276x24							
3.0i V6 	R	10/90→05/94	AKE 21840		598519	2		266x18							
3.0i V6 	R	10/92→10/94						284x20							
Space Gear (PA/PD) (94>98)															
2.0i, 2.4i, 2.5TD	⊙ 14"	F	12/94→02/98	AKE 23290		598522	2		253x24						
	⊙ 14"	F	08/97→02/98	AKE 21370		● 601020	2		253x24						
2.0i, 2.4i	⊙ 15"	F	06/96→07/97	AKE 21370		● 601020	2		276x24						
2.4i, 2.5TD	R	12/94→11/98	AKE 21840		598519	2		315x18 (16,4) * 186691							
Space Star (DG) (98>)															
1.3i, 1.6i, 1.8GDi, 1.9DI-D	F	06/98→	LUC 21920		598318	2		256x24 (22,4)	186648						
	ABS(+)	R	06/98→	LUC 21861		598319	2		260x10 (8,4)	186647					
Space Wagon (D0) (83>91)															
1.8, 1.8TD, 2.0	F	10/83→04/91	AKE 20955		598220	0		242x18							
2.0 4WD	F	02/85→04/91	AKE 20955		598220	0		266x24							
Space Wagon (N3) (91>2000)															
1.8, 1.8TD, 2.0, 2.0TD, 2.4	F	05/91→11/00	SUM 21647		598625	0		256x24 (22,4)	186648						
	R	05/91→11/00	AKE 21706		598834	2		262x18							
Space Wagon (N8) (98>2004)															
2.0i, 2.4GDi	F	07/98→01/04	AKE 21370		● 601020	2		276x24							
2.4GDi	F	09/99→09/00	AKE 21363		598517	2		276x24							
	F	10/00→04/02						276x24							



															
MITSUBISHI  (.../...)															
Space Wagon (N8) (98>2004) (.../...)															
2.0i, 2.4GDi		R	07/98→01/04										284x20		
MITSUBISHI 															
Canter (FB)															
2.3, 2.5		F	01/86→05/96		SUM 23501		598590	4(B)							
		F	01/86→05/96		SUM 598588		598588	0							
2.8		F	05/96→		SUM 23501		598589	2(A)+2(B)							
L300 (P0/1/2/3)															
1.6, 2.0, 2.0i, 2.4i, 2.5D		4WD(-)	F	11/86→		AKE 20512		598597	2		258,5x22				
2.0, 2.4i, 2.5TD		4WD(+)	F	11/86→		AKE 20512		598597	2		277x22 (20,4)	* 186653			
L300 (L030)															
1.6 (4 doors)			F	09/79→05/86		AKE 21373		598620	0		255,5x20 (18,4)	● 197165			
1.6 (5 doors)			F	05/80→05/86							255,5x20 (18,4)	● 197165			
L 300 (Truck) (94>2000)															
2.0, 2.5D 			F	06/94→04/00		AKE 23290		598522	2		253x24				
L400 (PA/PB/PD)															
2.0i 16V, 2.5TD			F	12/94→		AKE 23290		598522	2		253x24				
2.4i 4WD 16V, 2.5TD 4WD			F	12/94→03/96		AKE 21363		598517	2		276x24				
			F	04/96→		AKE 21370		● 601020	2		276x24				
NISSAN 															
720 Pick-up (79>85)															
1.6, 1.8, 2.2D			F	09/79→12/82							271x12,5				
1.6, 1.8, 2.3D			F	01/83→08/85		AKE 21099		598123	2		250x22				
1.8 4WD, 2.2D 4WD			F	09/79→03/83							271x12,5				
2.2 4WD, 2.5D 4WD			F	04/83→08/85		AKE 21099		598123	2		267x22				
			F	04/83→08/85							267x22				
D21 Pick-up (85>98)															
2.0, 2.3D, 2.4, 2.5D			F	09/85→02/98		AKE 21099		598123	2		250x22				





																	
NISSAN  (.../...)																	
D21 Pick-up (85>98) (.../...)																	
2.4 4WD, 2.4i 4WD, 2.5D 4WD		F	09/85→02/98	AKE 21099		598123	2		267x22								
2.4i 4WD		F	04/92→02/98	AKE 21347		598618	2		277x26								
D22 King Cab (98>)																	
2.4i, 2.5TD, 2.5TD 4WD, 2.5TDi		ABS(-)	F	02/98→	AKE 21347		598618	2		260x26							
2.4i, 2.5TDi		ABS(+)	F	11/01→	AKE 21347		598618	2		260x26							
2.4i 4WD, 2.5TDi 4WD			F	02/98→11/01	AKE 21347		598618	2		277x26							
			F	11/01→	AKE 23970		598889	2		300x28							
Murano (Z50) (2005>)																	
3.5i V6			F	02/05→	AKE 29738		598738	1		320x28							
			R	02/05→	AKE 23871		598672	2		308x16							
Navara (D40M) (2005>)																	
2.5TDi		☉ 16"	F	05/05→	AKE 29738		598738	1		296x28							
			F	05/05→	AKE 29738		598738	1		320x28							
Pathfinder (D21) (86>98)																	
2.4			F	08/86→02/98	AKE 21099		598123	2		267x22							
2.7D			F	10/87→02/98	LUC 21481		598602	0		277x26							
Pathfinder (R50) (97>2003)																	
3.3i V6			F	10/97→08/03	NIS 23420		598452	0		300x28							
Pathfinder (R51M) (2005>)																	
2.5dCi, 4.0C-VTC		☉ 16"	F	02/05→	AKE 29738		598738	1		296x28							
			F	02/05→	AKE 29738		598738	1		320x28							
			R	02/05→	TOK 24240		598730	1		307x18							
Patrol 160 Made in Japan (80>85)																	
2.8, 3.3D, 3.3TD 			F	07/80→07/85	SUM 20863		598122	0		295x20 (18)	186479						
3.3D, 3.3TD 			F	07/80→08/83						295x20 (18)	186479						
4.0 			F	07/80→08/83						295x20 (18)	186479						





































			R P F		WVA			Valeo		Valeo		Valeo	
NISSAN  (.../...)													
Patrol 160 Made in Spain (79>85)													
2.7D	F	11/79→09/83									295x20 (18)	186479	
	F	09/83→01/85									295x20 (18)	186479	
Patrol 260 (84>96)													
2.8, 2.8D, 2.8TD, 3.3D, 3.3TD	F	11/84→03/96									295x20 (18)	186479	
Patrol GR (Y60) (88>97)													
2.8TD 4WD	F	09/88→09/97	SUM 20863		598122	0					295x20 (18)	186479	186945
4.2D 2WD	F	01/93→09/97									295x20 (18)	186479	
4.2 4WD	F	10/91→09/97									295x20		
2.8TD 4WD, 4.2D 2WD, 4.2 4WD	R	09/88→09/97	SUM 20098		598851	0					316x18		
Patrol GR (Y61) (97>2004)													
2.8TD, 3.0TDi	F	10/97→07/04	SUM 23611		598524	2					306x32		
4.8i	F	10/02→07/04											
2.8TD, 3.0TDi	R	10/97→07/04	SUM 23502		● 601002	2					316x18		
4.8i	R	10/02→07/04											
Patrol GR (Y61) (2004>)													
3.0TDi	F	08/04→	SUM 23611		598524	2					306x32		
	R	08/04→	SUM 23502		● 601002	2					316x18		
Terrano (WD21) (87>95)													
2.4i, 2.7TD, 3.0 V6	F	08/87→06/92	AKE 21347		598618	2					277x26		
	F	08/87→02/93	AKE 21099		598123	2					277x26		
3.0 V6	R	01/90→02/93									286x18		
Terrano (R20) (93>2004)													
2.4i, 2.7TD, 2.7TDi, 3.0Di	F	03/93→02/04	LUC 21481		598602	0					277x26		
Terrano (R20) (2004>2006)													
2.7Di, 3.0Di	F	02/04→12/06	LUC 21481		598602	0					277x26		
X-Trail (T30) (2001>2003)													
2.0i, 2.2Di	F	06/01→09/03	NIS 23420		598452	0					280x28 (26)	186728	



























































																		
NISSAN  (.../...)																		
X-Trail (T30) (2001>2003) (.../...)																		
2.0i, 2.2Di (...)	R	06/01→09/03	AKE 23871		598672	2		292x16										
X-Trail (T30) (2003>2007)																		
2.0, 2.2dCi, 2.5i	F	09/03→03/07	NIS 23420		598452	0		280x28 (26)	186728									
	R	09/03→03/07	AKE 23871		598672	2		292x16										
X-Trail (T31) (2007>)																		
2.0, 2.0dCi, 2.5	F	03/07→						295,5x26 (24)	● 197164									
	R	03/07→	AKE 24632		● 601009	1		292x16										
NISSAN 																		
100 NX (B13) (90>94)																		
1.6, 1.6i	F	10/90→10/94	BDX 21657		598628	0		240x18 (16)	186482									
2.0i	F	10/90→10/94						257x26										
1.6, 1.6i	R	10/90→10/94	SUM 21734		598826	0		234x7 (6)	* 186654									
2.0i	R	10/90→10/94	SUM 21715		598668	2		258x9 (8)	* 186564									
200 SX (S13) (88>94)																		
1.8 Turbo	AKEBONO	F	09/88→08/91	AKE 21527		598786	2		257x22 (20)	186485								
	SUMIMOTO	F	09/88→08/91						257x22 (20)	186485								
	AKEBONO	F	09/91→06/94						280x21									
	SUMIMOTO	F	09/91→06/94						280x21									
		R	09/88→06/94						266x9									
200 SX (S14) (94>)																		
2.0 Turbo	F	04/94→12/99	SUM 21854		598476	4		280x30										
	R	04/94→12/99						258x9										
300 ZX (Z31) (84>89)																		
3.0i	F	02/84→02/87	AKE 21099		598123	2		258x10										
3.0 Turbo, 3.0i	F	02/84→01/89	AKE 21099		598123	2		274x22										
3.0 Turbo	F	02/84→01/87	AKE 21099		598123	2		300x22										













































		
NISSAN  (.../...)		
300 ZX (Z31) (84>89) (.../...)		
3.0 Turbo (...)	F	02/87→01/89 AKE 21099  598123 2  280x26
3.0 Turbo, 3.0i, 3.0i Turbo	SUMIMOTO F	02/87→01/89  280x26
	R	02/84→01/89
350Z (Z33) (2003>)		
3.5i V6	F	07/03→  324x30
	R	07/03→ BBO 21580  ● 598914 2
Almera (N15) (95>2000)		
1.4i	F	07/95→01/98 AKE 23502 598806 2  232x18 (16) 186576
1.4i, 1.6i, 2.0D	ABS(+) F	07/95→01/00 AKE 23502 598806 2  247x18 (16) 186577
	F	07/95→01/98 AKE 23004  598071 2  247x18 (16) 186577
	ABS(+) F	07/95→01/00 AKE 23004  598071 2  252x20
1.6i	F	01/98→01/00 AKE 23502 598806 2  252x20
2.0i	F	04/96→01/00  257x26
1.4i, 1.6i, 2.0D	ABS(+) R	07/95→01/98 AKE 23023  598449 2  234x7 (6) * 186654
1.4i, 1.6i, 2.0D, 2.0i	ABS(+) R	04/96→01/00 SUM 21715  598668 2  258x9 (8) * 186654
Almera (N16E) (2000>2003)		
1.5dCi, 1.5i	ABS(-) F	02/00→01/03 LUC 21546  598054 0  257x22 (20) 186485
1.5dCi	ABS(+) F	09/02→01/03 LUC 23093  598450 0  257x22 (20) 186485
1.5dCi, 1.5i	ABS(+) F	02/00→01/03 LUC 21546  598054 0  280x22 (20) 186821
1.5dCi, 1.5i, 1.8i, 2.2TDi, 2.2VDi	ABS(+) F	02/00→01/03 LUC 23093  598450 0  280x22 (20) 186821
	R	02/00→01/03 LUC 21545  598057 0  258x10 (9) 186487
Almera (N16E) (2003>2006)		
1.5i	F	02/03→11/06 LUC 21546  598054 0  257x22 (20) 186485
	ABS(+) F	02/03→11/06 LUC 23093  598450 0  257x22 (20) 186485
1.5DCi, 1.5i	ABS(+) F	02/03→11/06 LUC 21546  598054 0  280x22 (20) 186821
1.5DCi, 1.5i, 1.8i, 2.2DCi	ABS(+) F	02/03→11/06 LUC 23093  598450 0  280x22 (20) 186821





















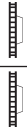

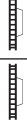











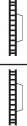





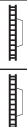













															
NISSAN  (.../...)															
Almera (N16E) (2003>2006) (.../...)															
1.5DCi, 1.5i, 1.8i, 2.2DCi (...)	F	02/03→11/06	AKE 29747		598747	1		280x22 (20)	186821						
	R	02/03→11/06	LUC 21545		598057	0		258x10 (9)	186487						
Almera Tino (V10M) (2000>2003)															
1.8i, 2.0i, 2.2Vdi	F	08/00→01/03	LUC 23095		598451	0		280x28 (26)	186728						
	R	08/00→01/03	LUC 21545		598057	0		278x10							
Almera Tino (V10B) (2003>2005)															
1.8i, 2.2DCi	F	02/03→11/05	LUC 23095		598451	0		280x28 (26)	186728						
	R	02/03→11/05	LUC 21545		598057	0		278x10							
Bluebird (910) (80>84)															
1.6, 1.8, 2.0D	F	04/80→07/80	AKE 20718		598379	0		238x22							
	F	08/80→03/84	AKE 20718		598379	0		232x22							
1.6, 1.8, 2.0, 2.0D	F	04/80→07/80	AKE 20718		598379	0		250x18							
	F	08/80→03/84						250x18							
Bluebird (T12) (85>90)															
1.6, 2.0	F	12/85→02/88	AKE 20718		598379	0		250x22							
1.6, 1.8 Turbo, 1.8i, 1.8i Turbo, 2.0, 2.0D 2.0i	F	12/85→12/90	AKE 21099		598123	2		250x22							
1.8 Turbo	R	12/85→03/87													
	R	03/87→01/88	SUM 21553		598817	2									
1.8 Turbo, 1.8i, 1.8i Turbo	R	09/87→12/90													
Bluebird (T72) (85>90)															
1.6, 1.8 Turbo, 1.8i, 1.8i Turbo, 2.0, 2.0D 2.0i	F	12/85→12/90	AKE 21099		598123	2		250x22							
1.8 Turbo, 1.8i, 1.8i Turbo	R	09/88→12/90													
Bluebird (U11) (83>90)															
1.8, 2.0, 2.0D  	F	10/83→1987	AKE 20718		598379	0		250x22							
1.8, 1.8 Turbo, 1.8T Turbo, 2.0, 2.0D 2.0D Turbo  	F	10/83→1987	AKE 21099		598123	2		250x22							

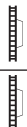

				 WVA			 Valeo		 Valeo		 Valeo		 Valeo		 Valeo	
NISSAN  (.../...)																
Bluebird (U11) (83>90) (.../...)																
1.8, 2.0D 	F	10/83→1987								250x22						
1.8 Turbo, 1.8T Turbo 	R	10/83→1987								260x10						
Cedric (Y30) (83>88)																
2.0, 2.3D, 3.0   	F	10/83→01/86														
	F	01/86→06/88	AKE 21347 	598618	2											
2.0, 2.3D, 2.8D, 3.0   	F	10/83→06/88	AKE 21099 	598123	2											
2.0, 2.3D, 2.8D, 3.0 	R	10/83→06/88								290x10						
3.0 	R	10/83→06/88								257x22 (20)	186485					
Cherry (N12) (82>87)																
1.0, 1.3, 1.5, 1.5 Turbo, 1.6	F	04/82→02/87	SUM 20958 	598278	0					240x12						
1.5 Turbo, 1.7D	F	10/82→12/86	AKE 20718 	598379	0					232x18						
Cube (2010>)																
1.5dCi, 1.6i	F	08/09→								279x24						
	R	08/09→	AKE 24632 	601009	1					291x9						
Laurel (C31) (81>84)																
2.0, 2.0i	F	06/81→12/84								250x18						
2.4	F	06/81→12/84	AKE 20718 	598379	0					250x18						
2.8D	F	06/81→12/84	AKE 20718 	598379	0					250x18						
Laurel (C32) (85>90)																
2.0, 2.4i, 2.8D	F	01/85→06/90	AKE 21099 	598123	2					250x22						
3.0i	F	03/86→06/90	AKE 21099 	598123	2					274x22						
Maxima (J30) (88>94)																
3.0	F	12/88→05/89	TOK 21561 	598787	2					280x22						
	F	06/89→10/91								280x22						
	F	10/91→09/94								280x26						
	R	12/88→09/94	SUM 21553 	598817	2					258x10 (9)	186487					











																	
NISSAN  (.../...)																	
Maxima QX (A32) (88>94)																	
2.0i V6	F	10/94→08/97	TOK 21561		598787	2		280x22									
	F	08/97→12/99	TOK 21561		598787	2		280x26									
3.0i V6	F	10/94→12/99	AKE 23316		598523	2		280x26									
2.0i V6, 3.0i V6	R	10/94→12/99	SUM 21715		598668	2		278x9									
Maxima QX (CA33) (2000>2006)																	
2.0i V6, 3.0i V6	F	01/00→01/06	AKE 23184		● 598912	2		280x28 (26)	186728								
	R	01/00→04/04	SUM 21715		598668	2		278x9									
	R	04/04→01/06						278x9									
Micra (K10) (82>92)																	
1.0, 1.2	F	11/82→11/88	SUM 20957		598384	0		214x12 (11)	* 186299								
	F	12/88→11/92	SUM 20957		598384	0		214x12									
	F	12/88→11/92	SUM 20957		598384	0		214x15									
Micra (K11E) (92>2000)																	
1.0i, 1.3i, 1.5D	F	08/92→06/00	AKE 21626		598014	0		234x12 (10)	186300								
	R	08/92→06/00	AKE 23454		598642	0		240x7 (6)	186846								
Micra (K11E) (2000>2002)																	
1.0i, 1.4i, 1.5D	ABS(-)	F	07/00→12/02	AKE 21626		598014	0		234x12 (10)	186300							
	ABS(+)	F	07/00→12/02	AKE 21626		598014	0		238x20,7								
		R	07/00→12/02	AKE 23454		598642	0		240x7 (6)	186846							
Micra (K12E) (2003>2005)																	
1.0i, 1.2i, 1.4i, 1.5dCi	F	01/03→05/05	LUC 23973		598641	0		260x22 (19,8)	186764	●186980							
Micra (K12E) (2005>)																	
1.2i, 1.4i, 1.5dCi, 1.6i 	F	06/05→	LUC 23973		598641	0		260x22 (19,8)	186764	●186980							
Note (E11E) (2005>2007)																	
1.4i, 1.5dCi, 1.6i	F	09/05→12/07	LUC 23973		598641	0		260x22 (19,8)	186764	●186980							
Note (E11E) (2008>)																	
1.4i, 1.5dCi 106, 1.5dCi 68, 1.5dCi 86, 1.6i	F	01/08→	LUC 23973		598641	0		260x22 (19,8)	186764	●186980							















































			 		 		 			
NISSAN  (.../...)										
Pixo (2009>)										
1.0i	F	06/09→	AKE 23507		598733	1		230x19		
Prairie (M10) (82>88)										
1.5, 1.8	F	09/82→08/87	AKE 20718		598379	0		232x18		
	F	08/87→09/88	AKE 21099		598123	2		232x18		
2.0, 2.0i	F	01/86→09/88	AKE 21099		598123	2		250x22		
Prairie (M11) (88>94)										
2.0, 2.0i	F	10/88→03/92	AKE 21527		598786	2		257x22 (20)	186485	
2.4i	F	04/92→07/94	AKE 21527		598786	2		257x24		
Primera (P10/W10) (90>98)										
1.6, 2.0D 	F	02/90→05/96	AKE 21280		598024	0		242x20 (18)	186301	
2.0, 2.0 16V, 2.0 4WD, 2.0D, 2.0e 16V, 2.0i 2.0i 16V, 2.0i 4WD 	F	02/90→05/96	LUC 21546		598054	0		257x22 (20)	186485	
1.6, 1.6i, 2.0, 2.0D 	F	07/90→01/98	AKE 21527		598786	2		257x22 (20)	186485	
2.0, 2.0 16V, 2.0D, 2.0e 16V, 2.0i 2.0i 16V 	R	02/90→05/96	LUC 21545		598057	0		258x9 (8)	* 186564	
2.0 4WD, 2.0i 4WD 	R	05/93→09/94	LUC 21545		598057	0				
1.6, 2.0, 2.0D  ABS(+)	R	07/90→01/98						258x9 (8)	* 186564	
Primera (P11/W11) (96>2002)										
1.6i, 1.8i, 2.0TD, 2.0i  ABS(-)	F	06/96→02/02	LUC 21546		598054	0		257x22 (20)	186485	
1.6i, 1.8i, 2.0TD, 2.0i   ABS(+)	F	06/96→02/02	LUC 23093		598450	0		280x22 (20)	186821	
2.0i  	F	06/99→02/02						280x22 (20)	186821	
1.6i, 1.8i, 2.0i 	R	06/96→05/99	LUC 21545		598057	0		258x10 (9)	186487	
1.6i, 1.8i, 2.0TD, 2.0i   ABS(+)	R	01/98→02/02	LUC 21545		598057	0		278x10 (9)	186845	
Primera (P12/W12) (2001>)										
1.6i, 1.8i, 1.9dCi, 2.0i, 2.2VDi, 2.2dCi 2.5i  	F	02/01→	LUC 23095		598451	0		280x28 (26)	186728	
	R	02/01→	ATE 23482		598472	0		278x10		

















































































															
NISSAN  (.../...)															
Qashqai (2007>2010)															
1.5dCi, 1.6i, 2.0dCi, 2.0i		F	03/07→01/10							 295,5x26 (24)	● 197164				
		R	03/07→01/10	AKE 24632 	● 601009	1				 291,5x9 (8)	● 197106				
Qashqai (2010>)															
1.5dCi 2WD 103, 1.5dCi 2WD 106, 1.6i 2WD 115 2.0dCi 2WD 150, 2.0dCi 4WD 150, 2.0i 2WD 140 2.0i 4WD 140		F	01/10→							 295,5x26 (24)	● 197164				
2.0dCi 4WD 150, 2.0i 4WD 140		F	01/10→							 320x28					
1.5dCi 2WD 103, 1.5dCi 2WD 106, 1.6i 2WD 115 2.0dCi 2WD 150, 2.0dCi 4WD 150, 2.0i 2WD 140 2.0i 4WD 140		R	01/10→	AKE 24632 	● 601009	1				 291,5x9 (8)	● 197106				
Serena (C23M) (92>2001)															
1.6i, 2.0D, 2.0i, 2.3D		F	07/92→11/01	LUC 21481 	598602	0				 256,5x26 (24)	* 186563				
Silvia (S12) (83>88)															
2.0		F	10/83→08/88	AKE 21099 	598123	2				 250x18					
1.8 Turbo		F	10/83→08/88	AKE 21099 	598123	2				 274x22					
2.0		R	10/83→08/88							 258x10					
1.8 Turbo		R	10/83→08/88							 290x10					
Stanza (T11) (81>85)															
1.6, 1.7D, 1.8		F	08/81→12/85	AKE 20718 	598379	0				 250x22					
1.6		F	08/81→08/82	AKE 21099 	598123	2				 250x22					
Sunny (B11) (81>86)															
1.3 		F	05/83→1986	SUM 20958 	598278	0									
1.3, 1.5 		F	10/81→1986	SUM 20958 	598278	0				 240x12					
1.7D 		F	09/82→1986							 240x12					
1.7D 		F	09/82→1986	AKE 20718 	598379	0				 232x18					
Sunny (B12) (86>90)															
1.5, 1.6 		F	06/86→09/88	SUM 20958 	598278	0				 240x12					
1.6 		F	10/88→05/90	SUM 20958 	598278	0				 240x12					























































































			 R P F		 WVA	 Valeo	 Valeo	 Valeo	 Valeo
NISSAN  (.../...)									
Sunny (B12) (86>90) (.../...)									
1.5, 1.6, 1.6 4x4, 1.6i, 1.7D 	F	06/86→09/88	AKE 21344 	598296	2	 240x18 (16)	186482		
1.6 16V 	F	06/86→09/88	AKE 21344 	598296	2	 240x18 (16)	186482		
1.8i 16V 	F	10/88→05/90	AKE 21344 	598296	2	 254x20			
1.6 16V, 1.8i 16V 	R	06/86→05/90	SUM 21734 	598826	0	 233x10			
Sunny (N13) (86>90)									
1.3 	F	06/86→10/90				 240x12			
	F	06/86→10/88							
1.0, 1.3, 1.4, 1.5, 1.6, 1.6i 	F	06/86→10/90	SUM 20958 	598278	0	 240x12			
1.6 16V 	F	02/87→10/88				 240x18 (16)	186482		
1.6 16V, 1.7D 	F	06/86→10/88	AKE 21344 	598296	2	 240x18 (16)	186482		
1.6 4x4, 1.6i 4x4, 1.7D 	F	06/86→10/90	AKE 21344 	598296	2	 240x18 (16)	186482		
1.8 16V 	F	10/88→10/90	AKE 21344 	598296	2	 254x20			
	F	10/88→10/90				 254x20			
1.6 16V, 1.8 16V 	R	02/87→10/90	SUM 21734 	598826	0	 233x10			
Sunny (N14) (90>95)									
1.4, 1.4i 16V, 1.6, 1.6 4WD, 1.6i, 1.6i 4WD 2.0D	F	10/90→05/95	BDX 21657 	598628	0	 240x18 (16)	186482		
2.0 16V, 2.0 4WD 16V	F	10/90→05/95				 257x26			
1.4, 1.6, 2.0D ABS(+)	R	10/90→05/95	SUM 21734 	598826	0	 234x7 (6)	* 186654		
2.0 16V	R	10/90→05/95	SUM 21715 	598668	2	 258x9 (8)	* 186564		
2.0 4WD 16V	R	10/90→05/95				 258x9			
Sunny (Y10) (90>2000)									
1.6, 1.6i 16V, 1.6i 4WD 16V, 1.7D, 2.0D 	F	11/90→12/96	AKE 21716 	598840	2	 240x18 (16)	186482		
1.6i 4WD 16V  ABS(+)	F	10/92→12/96	AKE 21716 	598840	2	 250x18			
Tiida (C11X) (2007>)									
1.5dCi, 1.6i, 1.8i	F	03/07→	24280 	● 601013	2	 279x24			











































															
NISSAN  (.../...)															
Tiida (C11X) (2007>) (.../...)															
1.5dCi, 1.6i, 1.8i (...)	R	03/07→	AKE 24632		● 601009	1					291x9				
NISSAN 															
Cabstar (98>2006)															
2.3D 75, 2.7TD 90, 3.0TD 110, 3.0TD 120	F	10/98→10/06	BOS 23432		541733	2									
Cabstar (2006>)															
2.5td, 3.0td	F	09/06→	BBO 29230		541737	2									
	R	09/06→	BBO 23921		541738	2									
Interstar (2002>2006)															
1.9dCi, 2.2dCi, 2.5dCi, 3.0dCi	F	09/02→09/06	BOS 23613		598537	0		306x28 (25)	186868						
	R	09/02→09/06	BOS 23669		598538	0		305x12 (10,5)	186740						
2.5dCi	R	09/02→11/03	BOS 23669		598538	0		259x20,6 (17,7)	186208						
Interstar (2006>)															
2.5dCi	F	09/06→	BOS 23613		598537	0		306x28 (25)	186868						
	R	09/06→	BOS 23669		598538	0		305x12 (10,5)	186740						
Kubistar (2003>)															
1.2E	GV(+)	F	09/03→	BOS 21980		598726	1		238x20 (17,7)	186229	●186982				
1.2E, 1.4E, 1.5dCi, 1.5dCi 60, 1.5dCi 70 1.5dCi 85, 1.6E		F	09/03→	BOS 21980		598726	1		259x20,6 (17,7)	186208	●186977				
Primastar (2002>2006)															
1.9dCi, 2.0i, 2.5dCi		F	09/02→09/06	LUC 23099		598545	0		305,5x28 (24)	186712	●186987				
Bearing Roulement (-)		R	09/02→09/06	LUC 21748		598546	0(A)		280x12 (10)	186713					
Bearing Roulement (+)		R	09/02→09/06	LUC 21748		598546	0(A)		280x12 (10)	● 197001					
Primastar (2006>)															
2.0dCi, 2.5dCi		F	09/06→	LUC 23099		598545	0		305,5x28 (24)	186712	●186987				
Bearing Roulement (-)		R	09/06→	LUC 21748		598546	0(A)		280x12 (10)	186713					
Bearing Roulement (+)		R	09/06→	LUC 21748		598546	0(A)		280x12 (10)	● 197001					
Trade (84>)															
2.0D		F	01/84→03/93	BDX 20706		598112	0(B)		263x24						

			R P F		WVA		Valeo		Valeo		Valeo	
NISSAN  (.../...)												
Trade (84>) (.../...)												
2.0D (...)	F	09/87→03/93	BDX 20706		598001	2(A)		263x24				
2.0D, 2.8D, 3.0D	F	01/84→	BDX 20706		598112	0(B)		262,8x24 (22)	* 186607			
3.0D	F	06/96→						262,8x24 (22)	* 186607			
Urvan (E24) (87>97)												
2.0, 2.3D, 2.4i, 2.5D	F	02/87→05/97	AKE 21347		598618	2		260x26				
Vanette (C120) Made in Japan (81>86)												
1.5, 2.0D 	F	06/81→01/83						232x22				
1.5, 2.0D  	F	08/82→09/86	AKE 20718		598379	0		250x18				
Vanette (C120) Made in Spain (86>94)												
1.5, 2.0, 2.0D, 2.4	F	09/86→11/94						250x22 (20)	* 186611			
Vanette (C220) Made in Spain (86>94)												
1.5, 2.0D	F	04/87→11/94	AKE 21099		598123	2		250x22 (20)	* 186611			
Vanette (C23M) (92>2001)												
1.6i, 2.0D, 2.3D	2 SEATS	F	07/92→11/01	AKE 21099		598123	2		250x22			
	5 SEATS	F	07/92→11/01	LUC 21481		598602	0		250x22			
Vanette (GC22) (86>93)												
1.5, 2.0, 2.0D, 2.4i	F	09/86→03/93	AKE 21347		598618	2		260x26				
2.0D	F	09/86→03/93	AKE 21099		598123	2		260x26				
OPEL 												
Antara (2006>)												
2.0CDTi, 2.4i, 3.2i V6	F	10/06→	MDO 24510		● 598942	2		296x29 (27,5)	● 197190			
	R	10/06→	AKE 24498		● 598941	2		303x20 (18,4)	● 197191			
Frontera A (91>98)												
2.0i, 2.3TD, 2.4i	F	03/91→04/95	AKE 21543		598020	4		257x22 (20,6)	186488			
2.0i, 2.2i, 2.5TDS, 2.8TDi	ABS(-)	F	04/95→09/98	AKE 21845		598460	1		280x26 (24,6)	186585		
	ABS(+)	F	04/95→09/98	AKE 21845		598460	1		280x26 (24,6)	● 197223		
2.0i, 2.2i, 2.3TD, 2.4i, 2.5TDS, 2.8TDi	R	03/91→09/98	SUM 21875		598507	2		313x18 (16,6)	186685			



















































									
OPEL  (.../...)									
Frontera A (91>98) (.../...)									
2.0i, 2.2i, 2.5TDS, 2.8TDi	P	04/95→09/98			564009				
Frontera B (98>2005)									
2.2DTi, 2.2i, 3.2i V6	ABS(-)	F	10/98→07/05	AKE 21845 	598460	1	 280x26 (24,6)	186585	
	ABS(-)	F	10/98→07/05	AKE 23250 	598661	2	 280x26 (24,6)	186585	
	ABS(+)	F	10/98→07/05	AKE 21845 	598460	1	 280x26 (24,6)	● 197223	
	ABS(+)	F	10/98→07/05	AKE 23250 	598661	2	 280x26 (24,6)	● 197223	
		R	10/98→07/05	SUM 21875 	598507	2	 313x18 (16,6)	186685	
	 2V599999	P	10/98→		564009				
Monterey (91>99)									
3.0DTi, 3.1TD, 3.2i V6, 3.5i V6	ABS(-)	F	09/91→08/99	AKE 21845 	598460	1	 280x26 (24,6)	186585	
	ABS(+)	F	09/91→08/99	AKE 21845 	598460	1	 280x26 (24,6)	● 197223	
		R	09/91→08/99	SUM 21875 	598507	2	 313x18 (16,6)	186685	
OPEL 									
Agila (2000>2007)									
1.0i, 1.2i	 3G002367,3G002706	F	03/00→	BOS 23253 	598453	2	 247x12 (10)	186784	
1.0i, 1.0i Twinport 1.2i, 1.2i Twinport 1.3CDTi	 3G002368,3G002706	F	→12/07	BOS 23253 	598453	2	 253x17 (15)	186805	
Agila (2007>)									
1.0i, 1.2i, 1.3CDTi		F	12/07→	LUC 23973 	598847	1	 252x20 (18)	● 197066	
Ascona A (70>75)									
1.2, 1.6, 1.6S, 1.9	 52512050	F	08/70→	ATE 20228 	598099	0	 238x11		
	 52512051	F	→07/75	ATE 20228 	598099	0	 246x12,6		
Ascona B (75>81)									
1.2, 1.3, 1.3S, 1.6, 1.6S, 1.9, 2.0, 2.0D 2.0E		F	08/75→07/81	ATE 20588 	598108	0	 246x12,6		
		F	08/75→07/81	20867 	598182	0	 246x12,6		



























































			RPF		WVA			Valeo		Valeo		
			RPF		WVA			Valeo		Valeo		
OPEL  (.../...)												
Ascona C (81>88)												
1.3, 1.3S, 1.6, 1.6D, 1.6S, 1.6i, 1.8E 1.8i 	F	08/81→08/88	20867		598182	0	 236x12,6 (9,7)	186187	186925			
	F	08/81→08/88	20867		598182	0	 238x11					
1.8E, 1.8i, 2i 	F	08/81→08/88	20867		598182	0	 236x19,9 (17)	186188				
2i 	F	08/85→08/88	20867		598182	0	 256x23,9 (21)	186189				
Astra F (91>2001)												
1.4i   			 T5000073	F	09/91→	ATE 21201		598184	0	 236x12,6 (9,7)	186187	
1.4, 1.4i   			 T5000073	F	09/91→	ATE 21353		598356	2	 236x12,6 (9,7)	186187	186924
1.4i   			 T5000073	F	09/91→	ATE 21201		598184	0	 238x11		
1.4, 1.4i   			 T5000073	F	09/91→	ATE 21353		598356	2	 238x11		
1.8i  			 T5000073	F	09/91→	ATE 21353		598356	2	 256x19,9 (17)	186282	
1.4i, 1.6i, 1.7D 1.7TD Ecoturbo 1.7TD Turbo   			 T5000074	F	-02/01	ATE 21201		598184	0	 236x19,9 (17)	186188	186946
1.4i, 1.6i, 1.7D, 1.7TD 1.7TD Ecoturbo 1.7TD Turbo   			 T5000074	F	-02/01	ATE 21353		598356	2	 236x19,9 (17)	186188	
1.4i, 1.6i, 1.7D, 1.7TD Ecoturbo, 1.7TD Turbo 1.8i, 2.0i    				F	09/91→02/01	ATE 21201		598184	431836	 256x23,9 (21)	186189	186932
1.4i, 1.6i, 1.7D, 1.7TD, 1.7TD Ecoturbo 1.7TD Turbo   				F	09/91→02/01	ATE 21353		598356	2	 256x23,9 (21)	186189	
1.4, 1.4i, 1.6i, 1.7D, 1.7TD, 1.7TD Ecoturbo 1.7TD Turbo, 1.8i, 2.0i   				R	09/91→02/01	ATE 21140		598253	0	 260x10 (8)	186490	
Astra Classic (98>2002)												
1.4i  	F	09/98→12/02		ATE 21353		598356	2	 238x11				
	F	09/98→12/02		ATE 21353		598356	2	 236x12,6 (9,7)	186187	186924		
1.6i  	F	09/98→12/02		ATE 21353		598356	2	 236x19,9 (17)	186188			
	F	09/98→12/02		ATE 21201		598184	0	 256x23,9 (21)	186189	186932		































































									
OPEL  (.../...)									
Astra G (98>2005)									
1.2i  	F	02/98→09/04	ATE 23063 	598322	4		256x11 (8)	186591	
	F	02/98→09/04	ATE 23063 	598322	4		256x24 (21)	186592	
1.4i, 1.6i, 1.6i Twinport, 1.7CDTI, 1.7DTi, 1.7TD, 1.7TD Ecoturbo, 1.8i, 2.0Di     	F	02/98→12/05	ATE 23063 	598322	4		256x24 (21)	186592	
1.6i, 1.6i Twinport, 1.8i, 2.0DTi, 2.0Di, 2.2DTi     	ABS(+)	F	02/98→12/05	ATE 23063 	598322	4		280x25 (22)	186684
1.6i GNV, 2.0i, 2.2i    	F	02/98→12/05	ATE 23062 	598454	2		280x25 (22)	186684	
2.0i  	F	02/98→02/04	ATE 23062 	598454	2		308x25 (23)	197244	
2.0i Turbo    	F	02/00→02/04	ATE 23116 	598475	2		308x25 (23)	197244	
1.2i, 1.4i, 1.6i, 1.6i GNV, 1.6i Twinport 1.7CDTi, 1.7DTi, 1.7TD, 1.7TD Ecoturbo, 1.8i 2.0Di     	R	02/98→12/05	LUC 23417 	598584	2		240x10 (8)	186594	
	R	02/98→12/05	BOS 23258 	598926	2(A)		240x10 (8)	186594	
1.8i, 2.0DTi, 2.0Di, 2.0i, 2.0i Turbo, 2.2DTi 2.2i     	R	02/98→12/05	LUC 23417 	598584	2		263,4x10 (8)	186593	
	R	02/98→12/05	BOS 23258 	598926	2(A)		263,4x10 (8)	186593	
Astra H (2004>)									
1.2i Twinport, 1.3CDTi 1.4i Twinport, 1.6i Twinport 1.7CDTi, 1.8i 	⊗4	F	03/04→	ATE 23832 	598860	2		280x25 (22)	186869
	⊗5	F	03/04→	ATE 23832 	598860	2		280x25 (22)	186684
	⊗5	F	03/04→	ATE 23832 	598860	2		308x25 (23)	197244
1.6i Turbo, 1.7CDTi, 1.9CDTi 2.0i Turbo, 2.2i    	⊗5	F	03/04→	ATE 23832 	598860	2		308x25 (23)	197244
2.0i Turbo (5 Doors) 	⊗5	F	03/05→09/06	ATE 23832 	598860	2		321x28 (25)	197150
2.0i Turbo OPC (3 Doors) 	⊗5	F	03/05→	ATE 23402 	598678	0		321x28 (25)	197150
1.6i Twinport, 1.7CDTi, 1.8i 	⊗4	R	02/07→	LUC 23417 	598584	2		240x10 (8)	186594



























































			 R P F		 WVA	 Valeo	 Valeo	 Valeo	 Valeo	
OPEL  (.../...)										
Astra H (2004>) (.../...)										
1.2i Twinport, 1.3CDTI 1.4i Twinport, 1.6i, 1.6i Turbo 1.6i Twinport, 1.7CDTI, 1.8i 1.9CDTI, 2.0i Turbo, 2.2i 	⊕5	R	03/04→	LUC 23417 	598584	2	 263,4x10 (8)	186593		
2.0i Turbo (5 Doors) 2.0i Turbo OPC (3 Doors) 	⊕5	R	03/05→	LUC 23417 	598584	2	 278x10			
Astra J (2009>)										
1.3CDTI, 1.4i Turbo 1.4i Twinport, 1.6i 115 1.6i Turbo, 1.7CDTI 110 1.7CDTI 125, 2.0CDTI 160	⊕ 15", 16"	F	09/09→							
	⊕ 15", 16"	R	09/09→							
Calibra (89>97)										
2.0i	F	09/89→07/97	ATE 21201 	598184	431836	 256x23,9 (21)	186189	186932		
2.5i V6	F	05/93→06/95	ATE 21411 	598050	431836	 256x23,9 (21)	186189			
2.0i Turbo	F	09/91→06/95	ATE 21411 	598050	431836	 284x24 (21)	186496			
2.0i Turbo, 2.5i V6	F	07/95→07/97	ATE 21829 	598305	0	 288x25 (21)	197226			
2.0i	R	09/89→07/97	ATE 21140 	598253	0	 270x10				
2.5i V6	R	05/93→06/95	ATE 21140 	598253	0	 270x10				
	R	07/95→07/97	ATE 21051 	598183	0	 270x10				
2.0i Turbo	R	09/91→07/97	ATE 21140 	598253	0	 270x10				
Commodore (78>82)										
2.5	F	08/78→07/82	ATE 20011 	* 598111	0	 271x12,7				
2.5, 2.5i	F	07/80→07/82	ATE 20011 	* 598111	0	 271x22				
Corsa A (82>93)										
1.0, 1.2, 1.3, 1.3i, 1.4 	F	10/82→06/91	20867 	598182	0	 236x9 (7)	186186	186947		
1.0, 1.2, 1.3, 1.3i 	F	10/82→09/90	ATE 21353 	598356	2	 236x9 (7)	186186			
1.2, 1.2i, 1.4, 1.4i, 1.5D, 1.5TD, 1.6i 	F	09/87→03/93	20867 	598182	0	 238x11				































															
OPEL  (.../...)															
Corsa A (82>93) (.../...)															
1.2, 1.2i, 1.4, 1.4i, 1.5D, 1.5TD, 1.6i  (...)	F	09/87-03/93	ATE 21353 	598356	2		238x11								
1.2, 1.6i 	F	1990-03/93	20867 	598182	0		236x12,6 (9,7)	186187	186925						
1.2, 1.2i, 1.6i 	F	1990-03/93	ATE 21353 	598356	2		236x12,6 (9,7)	186187	186924						
1.6i 	F	03/88-03/93	20867 	598182	0		236x19,9 (17)	186188							
1.4, 1.6i 	F	03/88-03/93	ATE 21353 	598356	2		236x19,9 (17)	186188							
Corsa B (93>2000)															
1.0i, 1.2, 1.2i, 1.4i, 1.5D, 1.5TD, 1.7D  	F	03/93-08/00	ATE 21353 	598356	2		238x11								
	F	03/93-08/00	ATE 21353 	598356	2		236x12,6 (9,7)	186187	186924						
1.2i, 1.4i, 1.7D  	F	03/93-08/00	ATE 21353 	598356	2		236x19,9 (17)	186188							
1.6i 	F	03/93-08/00	ATE 21353 	598356	2		256x19,9 (17)	186282							
Corsa C (2000>2003)															
1.0i, 1.2i  	ABS(-)	F	09/00-08/03	LUC 23225 	598456	2		240x11 (8)	186757						
1.0i, 1.2i, 1.7DI  	ABS(+)	F	09/00-08/03	LUC 23225 	598456	2		240x20 (17)	186790						
1.4i, 1.7DTi, 1.8i  		F	09/00-08/03	LUC 23225 	598456	2		260,5x24 (22,4)	186759						
1.4i, 1.8i 	ESP(+)	R	09/00-08/03	LUC 23284 	598457	2		240x10,2 (8,2)	186791						
Corsa C (2003>2006)															
1.0i Twinport, 1.2i, 1.2i Twinport	ABS(-)	F	09/03-07/06	LUC 23225 	598456	2		240x11 (8)	186757						
	ABS(+)	F	09/03-07/06	LUC 23225 	598456	2		240x20 (17)	186790						
1.3CDTI, 1.4i Twinport, 1.8i		F	09/03-07/06	LUC 23225 	598456	2		260,5x24 (22,4)	186759						
1.7CDTI		F	09/03-07/06	ATE 23832 	598860	2		280x25 (22)	186684						
1.4i Twinport, 1.8i	ESP(+)	R	09/03-07/06	LUC 23284 	598457	2		240x10,2 (8,2)	186791						
Corsa D (2006>)															
1.0i Twinport		F	07/06→	BOS 23982 	598825	1		257x12 (10)	● 197028						
1.0i Twinport, 1.2i Twinport, 1.3CDTI 75 1.4i Twinport		F	07/06→	BOS 23982 	598825	1		257x22 (20)	● 197044						
1.3CDTI 90, 1.3CDTI 95		F	07/06→	BOS 23708 	598839	1		284x22 (20)	● 197045						























































																			
OPEL  (.../...)																			
Corsa D (2006>) (.../...)																			
1.7CDTI 125 FAP, 1.7CDTI 130			F	09/06→								278x26 (23)	●	197149					
1.6i Turbo			F	02/07→	ATE 23832		598860	2				308x25 (23)	●	197244					
1.6i Turbo, 1.7CDTI 125 FAP, 1.7CDTI 130			R	09/06→	BOS 24349		598722	0				264x10							
Insignia (2009>)																			
1.6i, 1.6i 115, 1.6i 180, 1.8i 1.8i 140, 2.0CDTI			⊙ 16"	F	01/09→	MDO 24415		● 601047	2			296x30							
			⊙ 17"	F	01/09→	MDO 24412		● 601046	2			321x30							
1.6i, 1.6i 115, 1.6i 180 1.8i, 1.8i 140, 2.0CDTI 2.0i, 2.0i 220, 2.8i V6			⊙ 18", 19"	F	01/09→	24418		● 601048	2			337x30							
			⊙ 16", 17", 18", 19"	R	01/09→	24421		● 601049	4			315x23							
Kadett C (73>79)																			
1, 1.2N, 1.2S, 1S 			F	08/73→07/79	ATE 20228		598099	0				238x11							
1.6S, 1.9, 2, 2E 			F	08/75→07/79	ATE 20588		598108	0				246x12,6							
Kadett D (79>84)																			
1.0, 1.2, 1.3			F	08/79→08/84	20867		598182	0				236x9 (7)	186186	186947					
1.3, 1.6, 1.6D			F	08/79→08/84	20867		598182	0				238x11							
			F	08/79→08/84	20867		598182	0				236x12,6 (9,7)	186187						
1.8i GTE			F	05/83→08/84	20867		598182	0				236x19,9 (17)	186188						
Kadett E (84>91)																			
1.2S, 1.3, 1.3N, 1.3S, 1.4S, 1.4i 1.5TD 			F	08/84→08/91	20867		598182	0				236x9 (7)	186186	186947					
1.2S, 1.3, 1.3N, 1.3S, 1.4S, 1.4i, 1.6, 1.6D 1.6S, 1.6i, 1.7D, 1.8, 1.8E, 1.8i 			F	08/84→08/91	20867		598182	0				236x12,6 (9,7)	186187	186925					
1.8i 			F	09/87→1991	ATE 21201		598184	0				236x12,6 (9,7)	186187						
1.6S, 1.7D 			F	08/85→1991	ATE 21051		598243	0				236x12,6 (9,7)	186187						
1.2S, 1.3, 1.3N, 1.3S, 1.4S, 1.4i, 1.6, 1.6D 1.6S, 1.6i, 1.7D, 1.8, 1.8E, 1.8i 			F	08/84→08/91	20867		598182	0				238x11							

















































									
OPEL  (.../...)									
Kadett E (84>91) (.../...)									
1.8i 	F	09/87→1991	ATE 21201 	598184	0		238x11		
1.6S, 1.7D 	F	08/85→1991	ATE 21051 	598243	0		238x11		
1.7D, 1.8i 	F	09/86→1991	20867 	598182	0		271x12,7		
1.5TD, 1.6D, 1.6S, 1.6i, 1.7D, 1.8E 1.8i 	F	08/84→08/91	20867 	598182	0		236x19,9 (17)	186188	
1.8i 	F	09/87→1991	ATE 21201 	598184	0		236x19,9 (17)	186188	186946
1.6S, 1.7D 	F	08/85→1991	ATE 21051 	598243	0		236x19,9 (17)	186188	
1.8i, 2.0i 	F	09/86→1991	ATE 21201 	598184	0		256x23,9 (21)	186189	186932
2.0i 	R	09/86→1991	ATE 21140 	598253	0		261x10 (8)	* 186302	
Manta A (70>75)									
1.2, 1.6, 1.9		 51019912	F 08/70→	ATE 20228 	598099	0		238x11	
		 51019913	F →07/75	ATE 20228 	598099	0		246x12,6	
Manta B (75>88)									
1.2N, 1.2S, 1.3N, 1.3S, 1.6N, 1.6S, 1.8S 1.9N, 1.9S, 2.0S, 2E	F	08/75→08/88	ATE 20588 	598108	0		246x12,6		
	F	08/75→08/88	20867 	598182	0		246x12,6		
Meriva (2003>)									
1.4i Twinport, 1.6i	⊗4	F	05/03→	LUC 23225 	598456	2		260,5x24 (22,4)	186759
1.3CDTi, 1.6i 16V, 1.7CDTi, 1.7DTi 1.8i	⊗4	F	05/03→	ATE 23832 	598860	2		280x25 (22)	186869
	⊗5	F	05/03→	ATE 23832 	598860	2		280x25 (22)	186684
1.6i Turbo OPC	⊗5	F	03/06→	ATE 23832 	598860	2		308x25 (23)	● 197244
1.4i Twinport, 1.6i	⊗4	R	05/03→	LUC 23417 	598584	2		240x10 (8)	186594
1.3CDTi, 1.6i 16V, 1.7CDTi, 1.7DTi 1.8i	⊗4	R	05/03→	LUC 23417 	598584	2		264x10 (8)	186855
1.3CDTi, 1.6i 16V, 1.6i Turbo OPC 1.7CDTi, 1.7DTi, 1.8i	⊗5	R	05/03→	LUC 23417 	598584	2		263,4x10 (8)	186593

																		
OPEL  (.../...)																		
Meriva (2010>)																		
1.3CDTi, 1.4Turbo (eng 88KW), 1.4i 1.7CDTi (eng 74/81KW)	F	05/10→	ATE 23832		598860	2		280x25 (22)	186684									
1.4Turbo (eng 103KW), 1.7CDTi (eng 96KW)	F	05/10→	ATE 23832		598860	2		308x25 (23)	197244									
1.3CDTi, 1.4Turbo (eng 88/103KW), 1.4i 1.7CDTi (eng 74/81/96KW)	R	05/10→	LUC 23417		598584	2		263,4x10 (8)	186593									
Monza (78>86)																		
2.0i	F	12/82→07/84	ATE 20011		* 598111	0		271x12,7										
2.0i, 2.5i, 2.8, 3.0		 E1019586	F	06/78→	ATE 20011		* 598111	0		271x22								
2.2i, 2.5i, 3.0, 3.0i		 E1019587	F	-08/86	ATE 21226		* 598186	0		271x22								
2.0i, 2.2i, 2.5i, 2.8, 3.0, 3.0i	R	06/78→08/86	ATE 20228		598099	0		279x10										
Omega A (86>94)																		
1.8, 1.8i, 2.0i 2.3D, 2.3TD 		 K1000098,L1019854	F	10/86→	20867		598182	431849		258x12,6 (9,7)	* 186192							
1.8, 1.8i, 2.0i 2.3D, 2.3TD 2.4i 		 K1000099,L1019855	F	-02/94	ATE 21201		598184	431845		258x23,9 (21)	186191							
3i 		 L1999999	F	02/87→06/90	ATE 21226		* 598186	0		280x24 (21)	* 186625							
		 L1999999	F	02/87→06/90	ATE 21226		* 598186	0		296x28 (25)	197225							
		 M1000001	F	07/90→02/94	LUC 21368		598256	0		280x24 (21)	* 186625							
		 M1000001	F	07/90→02/94	LUC 21368		598256	0		296x28 (25)	197225							
2.6i 	F	08/90→02/94	LUC 21368		598256	0		296x28 (25)	197225									
3.6i Lotus 	F	04/90→02/94								296x28 (25)	197225							
1.8, 1.8i, 2.0i 2.3D, 2.3TD, 2.4i 3i 		 K1000098,M1068548	R	10/86→	ATE 21051		598243	0		270x10 (8)	* 186190							
1.8, 1.8i, 2.0i, 2.3D, 2.3TD 2.4i, 2.6i, 3i 		 K1000099	R	-02/94	ATE 21051		598183	0		270x10 (8)	* 186190							
3.6i Lotus 	R	04/90→02/94	ATE 21051		598183	0		271x12,7										

									
OPEL  (.../...)									
Omega B (94>2003)									
2.0i  	F	02/94→07/03	ATE 21411 	598050	0		246x12,6		
	F	02/94→07/03	LUC 21368 	598256	0		246x12,6		
2.0DTi, 2.5TDi  	F	09/97→07/03	LUC 21368 	598256	0		271x13		
2.5TD 	F	02/94→01/97	ATE 21411 	598050	0		286x12		
	F	02/94→01/97	LUC 21368 	598256	0		286x12		
2.0i  	F	02/94→06/97	ATE 21411 	598050	431834		286x24		
2.0i, 2.2DTi, 2.2i, 2.5TD, 2.5i V6 2.6i V6, 3.0i V6, 3.2i V6  	CU(+)	F 02/94→07/03	ATE 21411 	598050	0		296x28 (25)	● 197225	
2.0DTi, 2.0i, 2.2DTi, 2.2i, 2.5TD 2.5TDi, 2.5i V6, 2.6i V6, 3.0i V6 3.2i V6  	CU(+)	F 02/94→07/03	LUC 21368 	598256	0		296x28 (25)	● 197225	
	R	02/94→07/03	ATE 21051 	598183	0		286x12		
	R	02/94→07/03	ATE 21051 	598183	0		286x20		
Rekord D (72>77)									
1.7, 1.9, 2.1D	F	01/72→09/73	ATE 20228 	598099	0		238x11		
1.7, 1.9, 2, 2.1D, 2D	F	10/73→08/77	ATE 20588 	598108	0		246x12,6		
Rekord E (77>86)									
1.7, 1.8, 1.9, 2, 2.1D, 2.3D, 2.3TD	F	08/77→09/86	ATE 20588 	598108	0		246x12,6		
1.8, 1.9, 2, 2.1D, 2.3D, 2.3TD	F	08/77→09/86	20867 	598182	0		246x12,6		
1.8, 2, 2E	F	08/77→09/86	ATE 20588 	598108	0		246x20		
	F	08/77→09/86	20867 	598182	0		246x20		
1.7, 1.8, 1.9, 2, 2.1D, 2.2i, 2.3D 2.3TD, 2D, 2E	ABS(+)	F 08/77→09/86	ATE 20588 	598108	0		246x23		
1.8, 1.9, 2, 2.1D, 2.2i, 2.3D 2.3TD, 2D, 2E	ABS(+)	F 08/77→09/86	20867 	598182	0		246x23		
Senator A (78>87)									
2.0i	F	12/82→07/84	ATE 20011 	* 598111	0		271x12,7		

		
OPEL  (.../...)		
Senator A (78>87) (.../...)		
2.2i, 2.3TD, 2.5i, 3.0, 3.0i	F	06/78→02/87 ATE 21226  * 598186 0  271x22
2.5i, 3.0	F	06/78→02/87 ATE 20011  * 598111 0  271x22
2.8	F	06/78→1981 ATE 20011  * 598111 0  271x22
2.0i, 2.2i, 2.3TD, 2.5i, 2.8, 3.0, 3.0i	R	06/78→02/87 ATE 20228  598099 0  279x10
Senator B (87>93)		
2.5i, 3.0i	F	02/87→07/89 ATE 21226  * 598186 0  280x24 (21) * 186625
2.6i, 3.0i	F	02/87→06/93 LUC 21368  598256 0  296x28 (25) ● 197225
2.5i, 2.6i, 3.0i	R	02/87→06/93 ATE 21051  598183 0  270x10 (8) * 186190
Signum A (2003>2005)		
1.8i, 1.9CDTI, 2.0DTI, 2.2DIG, 2.2DTI	F	06/03→09/05 ATE 23402  598678 0  285x24,9 (22,2) 186881
1.8i, 1.9CDTI, 2.0i Turbo, 2.2DIG, 2.2DTI	F	06/03→09/05 ATE 23402  598678 0  302x28 (25) 186880
3.0CDTi V6, 3.2i V6	F	31068239 -09/05 ATE 20224  598808 0  314x28
1.8i, 1.9CDTI, 2.0DTI, 2.2DIG, 2.2DTI	R	06/03→09/05 ATE 24137  598783 0  278x11,9 (10) 186854
1.8i, 1.9CDTI, 2.0i Turbo, 2.2DIG, 2.2DTI	R	06/03→09/05 ATE 24137  598783 0  292x19,9 (18) 186882
3.0CDTi V6, 3.2i V6	R	06/03→09/05 ATE 23482  598472 0  292x19,9 (18) 186882
Signum B (2005>2008)		
1.8i, 1.9CDTI, 2.2DIG	F	10/05→11/08 ATE 23402  598678 0  285x24,9 (22,2) 186881
2.0i Turbo	F	10/05→11/08 ATE 23402  598678 0  302x28 (25) 186880
2.8i V6 Turbo	F	10/05→12/06 ATE 20224  598808 0  314x28
1.8i, 1.9CDTI, 2.2DIG	R	10/05→11/08 ATE 24137  598783 0  278x11,9 (10) 186854
2.0i Turbo, 2.8i V6 Turbo	R	10/05→11/08 ATE 24137  598783 0  292x19,9 (18) 186882
Sintra (96>99)		
2.2DTI, 2.2i, 3.0i V6	F	03/96→12/99 23358  598458 2  278x32,2 (30,7) ● 197004
	R	03/96→12/99 AKE 23361  598459 2  257x22 (20,6) 186488

































																				
OPEL  (.../...)																				
Speedster (2000>2005)																				
2.0i Turbo		F	03/03→09/05																	
		R	03/03→09/05																	
2.2i		F	08/00→09/05																	
		R	08/00→09/05																	
Tigra (94>2001)																				
1.4i, 1.6i		F	10/94→01/01	ATE 21353 	598356	2		256x19,9 (17)	186282											
Tigra Twintop (2004>2008)																				
1.3CDTi, 1.4i Twinport, 1.8i		F	07/04→07/08	LUC 23225 	598456	2		260,5x24 (22,4)	186759											
1.8i		R	07/04→07/08	LUC 23284 	598457	2		240x10,2 (8,2)	186791											
Vectra A (88>95)																				
1.4, 1.6S, 1.6i 1.7D, 1.7TD, 1.8i			►  N1038529,N5000000	F	09/88→	ATE 21201 	598184	0		238x11										
			►  N1038529,N5000000	F	09/88→	20867 	598182	0		238x11										
1.4, 1.6S, 1.6i			 N1038530,N5000001	F	→09/95	ATE 21201 	598184	0		236x19,9 (17)	186188	186946								
			 N1038530,N5000001	F	→09/95	20867 	598182	0		236x19,9 (17)	186188									
			 N1038530,N5000001	F	→09/95	ATE 21353 	598356	2		236x19,9 (17)	186188									
1.6S, 1.6i, 1.7D, 1.7TD 1.8i			►  R*999999	F		ATE 21201 	598184	0		256x19,9 (17)	186282									
			►  R*999999	F		20867 	598182	0		256x19,9 (17)	186282									
			►  R*999999	F		ATE 21353 	598356	2		256x19,9 (17)	186282									
1.8 4x4, 2.0i, 2.0i 16V 2.0i 4WD 16V			 S*000001	F	→09/95	ATE 21201 	598184	0		256x23,9 (21)	186189	186932								
			 S*000001	F	→09/95	20867 	598182	0		256x23,9 (21)	186189									
1.7D, 1.7TD, 1.8i			 S*000001	F	→09/95	ATE 21353 	598356	2		256x23,9 (21)	186189									
2 4x4 Turbo 16S, 2.5i V6 24V				F	08/92→09/95	ATE 21201 	598184	0		284x24 (21)	186496									
				F	08/92→09/95	ATE 21411 	598050	431836		284x24 (21)	186496									
2.5i V6 24V				F	05/93→09/95	20867 	598182	0		284x24 (21)	186496									



















































													
			R P F		WVA			Valeo		Valeo		Valeo	
OPEL  (.../...)													
Vectra A (88>95) (.../...)													
2.0i	 N*999999	R	09/88→	ATE 21140		598253	0		261x10 (8)	* 186302			
	 P*000001	R	→09/95	ATE 21140		598253	0		260x10 (8)	186490			
2.0i 16V	 N*999999	R	03/90→	ATE 21140		598253	0		270x10				
2.0i 16V, 2.0i 4WD 16V	 P*000001	R	→09/95	ATE 21140		598253	0		260x10 (8)	186490			
2.5i V6 24V		R	05/93→09/95	ATE 21140		598253	0		260x10 (8)	* 186497			
2 4x4 Turbo 16S		R	08/92→09/95	ATE 21140		598253	0		270x10				
Vectra B (95>99)													
1.6i, 1.7TD, 1.8i, 2.0Di, 2.0TDi, 2.0i		F	10/95→01/99	ATE 21201		598184	0		256x23,9 (21)	186189	186932		
		F	10/95→01/99	ATE 21829		598305	0		256x23,9 (21)	186189			
1.6i, 1.8i, 2.0Di, 2.0TDi, 2.0i		F	10/95→01/99	ATE 21201		598184	0		288x25 (21)	● 197226			
1.6i, 1.8i, 2.0Di, 2.0TDi, 2.0i, 2.5i V6		F	10/95→01/99	ATE 21829		598305	0		288x25 (21)	● 197226			
2.5i V6		F	10/95→01/99	ATE 21829		598305	0		288x25				
1.6i, 1.7TD, 1.8i, 2.0Di 2.0TDi, 2.0i, 2.5i V6	 W*999999	R	10/95→	ATE 21051		598183	0		270x9,9 (8)	186565			
	 W*999999	R	10/95→	ATE 20009		598187	0		270x9,9 (8)	186565			
	 X*000001	R	→01/99	ATE 21051		598183	0		286x10 (8)	* 186566			
	 X*000001	R	→01/99	ATE 20009		598187	0		286x10 (8)	* 186566			
Vectra B (99>2003)													
1.6i, 1.8i, 2.0DTi		F	02/99→06/03	ATE 21201		598184	0		288x25 (21)	● 197226			
1.6i, 1.8i, 2.0DTi, 2.2DTi, 2.2i, 2.6i V6		F	02/99→06/03	ATE 21829		598305	0		288x25 (21)	● 197226			
1.6i, 1.8i, 2.0DTi		R	02/99→06/03	ATE 20009		598187	0		286x10 (8)	* 186566			
1.6i, 1.8i, 2.0DTi, 2.2DTi, 2.2i, 2.6i V6		R	02/99→06/03	ATE 21051		598183	0		286x10 (8)	* 186566			
Vectra C (2002>2005)													
1.6i, 1.8i, 1.8i GPL, 1.9CDTi, 2.0DTi, 2.2DiG 2.2DTi, 2.2i		F	04/02→09/05	ATE 23402		598678	0		285x24,9 (22,2)	186881			
2.0i Turbo		F	03/03→09/05	ATE 23402		598678	0		302x28 (25)	186880			

























































OPEL (././.)									
Vectra C (2002>2005) (././.)									
3.0CDTI V6, 3.2i V6	31070293,38047797	F	06/02→	ATE 23402	598678	0		302x28 (25)	186880
	31070294,38047798	F	→09/05	ATE 20224	598808	0		314x28	
1.6i, 1.8i, 1.8i GPL, 1.9CDTI, 2.0DTI 2.0i Turbo, 2.2DIG, 2.2DTI, 2.2i		R	04/02→09/05	ATE 24137	598783	0		278x11,9 (10)	186854
		R	04/02→09/05	ATE 23482	598472	0		278x11,9 (10)	186854
3.0CDTI V6, 3.2i V6		R	06/02→09/05	ATE 24137	598783	0		292x19,9 (18)	186882
		R	06/02→09/05	ATE 23482	598472	0		292x19,9 (18)	186882
Vectra C (2005>2009)									
1.6i, 1.8i, 1.9CDTI, 2.2DIG		F	10/05→02/09	ATE 23402	598678	0		285x24,9 (22,2)	186881
2.0i Turbo		F	10/05→02/09	ATE 23402	598678	0		302x28 (25)	186880
2.8i V6 Turbo, 3.0CDTI V6		F	10/05→02/09	ATE 20224	598808	0		314x28	
2.8i V6 Turbo OPC		F	02/06→02/09	ATE 23762	598822	0		345x30	
1.6i, 1.8i, 1.9CDTI, 2.2DIG		R	10/05→02/09	ATE 24137	598783	0		278x11,9 (10)	186854
2.0i Turbo, 2.8i V6 Turbo, 2.8i V6 Turbo OPC 3.0CDTI V6		R	10/05→02/09	ATE 24137	598783	0		292x19,9 (18)	186882
Zafira A (98>2003)									
1.6i, 1.8i, 2.0DT, 2.0DTI, 2.2DTI, 2.2i		F	01/99→06/03	ATE 23062	598454	2		280x25 (22)	186684
2.0i Turbo		F	09/01→06/03	ATE 23116	598475	2		308x25 (23) ●	197244
1.8i, 2.0DTi, 2.0i Turbo, 2.2DTI, 2.2i		R	01/99→06/03	LUC 23417	598584	2		263,4x10 (8)	186593
1.6i, 1.8i, 2.0DT, 2.0DTi, 2.0i Turbo, 2.2DTI 2.2i		R	01/99→06/03	BOS 23258	● 598926	2(A)		263,4x10 (8)	186593
Zafira A (2003>2005)									
1.6i, 1.6i GNV, 1.8i, 2.0DTI, 2.2DTI, 2.2i		F	07/03→06/05	ATE 23062	598454	2		280x25 (22)	186684
2.0i Turbo		F	07/03→06/05	ATE 23116	598475	2		308x25 (23) ●	197244
1.6i GNV, 1.8i, 2.0DTI, 2.0i Turbo, 2.2DTI 2.2i		R	07/03→06/05	LUC 23417	598584	2		263,4x10 (8)	186593

OPEL (.../...)		
Zafira A (2003>2005) (.../...)		
1.6i, 1.6i GNV, 1.8i, 2.0DTI, 2.0i Turbo 2.2DTI, 2.2i	R 07/03→06/05	BOS 23258 ● 598926 2(A) 263,4x10 (8) 186593
Zafira B (2005>2008)		
1.6i, 1.6i GNV, 1.6i VVT, 1.8i	F 07/05→07/08	ATE 23832 598860 2 280x25 (22) 186684
1.7CDTI, 1.9CDTI, 2.0i Turbo, 2.2i	F 07/05→07/08	ATE 23832 598860 2 308x25 (23) ● 197244
2.0i Turbo OPC	F 07/05→07/08	ATE 23402 598678 0 321x28 (25) ● 197150
1.6i, 1.6i VVT, 1.7CDTI, 1.8i, 1.9CDTI 2.0i Turbo, 2.2i	R 07/05→07/08	LUC 23417 598584 2 263,4x10 (8) 186593
1.6i GNV	R 01/06→07/08	LUC 23417 598584 2 264x10
2.0i Turbo OPC	R 07/05→07/08	LUC 23417 598584 2 278x10
Zafira B (2008>)		
1.6i, 1.8i	F 07/08→	ATE 23832 598860 2 280x25 (22) 186684
1.6i GNV, 1.7CDTI, 1.9CDTI, 2.0i Turbo, 2.2i	F 07/08→	ATE 23832 598860 2 308x25 (23) ● 197244
2.0i Turbo OPC	F 07/08→	ATE 23402 598678 0 321x28 (25) ● 197150
1.6i, 1.7CDTI, 1.8i, 1.9CDTI, 2.0i Turbo 2.2i	R 07/08→	LUC 23417 598584 2 263,4x10 (8) 186593
1.6i GNV	R 07/08→	LUC 23417 598584 2 264x10
2.0i Turbo OPC	R 07/08→	LUC 23417 598584 2 278x10
OPEL		
Arena (98>2001)		
1.9D, 2.5D	F 01/98→08/01	BDX 20928 598086 0 252,5x24 (22) 186218
Campo (88>96)		
2.2D, 2.3, 2.5D, 2.5TD, 3.1TD	F 10/88→06/96	AKE 21845 598460 1 257x22 (20,6) 186488
	F 10/88→06/96	AKE 21543 598020 4 257x22 (20,6) 186488
Campo (96>)		
2.5DTI, 2.5TD, 3.1TDS	F 07/96→	AKE 21543 598020 4 257x22 (20,6) 186488
Combo (85>93)		
1.3, 1.3i, 1.4, 1.4i	→ M4999999 F 07/85→	20867 598182 0 236x9 (7) 186186 186947





















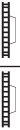











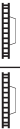



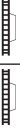





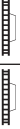

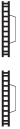











OPEL (.../...)																
Combo (85>93) (.../...)																
1.3, 1.3i, 1.4, 1.4i (...)		N4000001	F	→03/93	20867		598182	0		238x11						
		CU(-)	F	07/85→03/93	20867		598182	0		238x11						
		CU(+)	F	07/85→03/93	20867		598182	0		236x19,9 (17)	186188					
1.6, 1.6D, 1.6i, 1.7D	CU(-)	F	07/85→03/93	ATE 21353		598356	2		238x11							
		F	07/85→03/93	ATE 21353		598356	2		236x19,9 (17)	186188						
Combo (93>2001)																
1.2, 1.2i, 1.4i, 1.7D		F	03/93→09/01	ATE 21353		598356	2		246x12,6							
		F	03/93→09/01	ATE 21353		598356	2		236x19,9 (17)	186188						
Combo/Combo Tour (2001>)																
1.3CDTi, 1.4i Twinport, 1.6i 1.7CDTi, 1.7Di, 1.7DTi		43999999	F	10/01→	LUC 23225		598456	2		260,5x24 (22,4)	186759					
			F		ATE 23832		598860	2		260,5x24 (22,4)	186759					
1.3CDTi, 1.4i Twinport, 1.6i, 1.7Di, 1.7DTi		R	10/01→	LUC 23417		598584	2		264x10 (8)	186855						
1.7CDTi		R	07/04→	LUC 23417		598584	2		263,4x10 (8)	186593						
Movano (98>2003)																
1.9Dti, 2.2Dti, 2.5D, 2.5Dti 2.8Dti	☉ 15"	F	10/98→09/03	BDX 23302		598490	0		280x24 (21)	186688						
		F	10/98→09/03	BOS 23613		598537	0		306x28 (25)	186868						
		R	07/00→09/03	BOS 23669		598538	0		305x12 (10,5)	186740						
Movano (2003>2006)																
1.9DTi, 2.2DTi, 2.5CDTi, 2.5DTi 3.0CDTi, 3.0Di	☉ 15"	F	10/03→10/06	BDX 23302		598490	0		280x24 (21)	186688						
		F	10/03→10/06	BOS 23613		598537	0		306x28 (25)	186868						
		R	10/03→	BOS 23669		598538	0		305x12 (10,5)	186740						
Movano (2006>)																
2.5CDTi	☉ 15"	F	10/06→	BDX 23302		598490	0		280x24 (21)	186688						
		F	10/06→	BOS 23613		598537	0		306x28 (25)	186868						

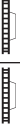









































			R P F		WVA		Valeo		Valeo		Valeo	
OPEL  (.../...)												
Movano (2006>) (.../...)												
2.5CDTi (...)	R	10/06→	BOS 23669 	598538	0		305x12 (10,5)	186740				
Movano (2010>)												
2.3CDTi 125, 2.3CDTi 146	F	05/10→					302x28					
2.3CDTi 125, 2.3CDTi 146 traction	R	05/10→					305x12					
2.3CDTi 125, 2.3CDTi 146 propulsion	R	05/10→					305x12					
2.3CDTi 125 2.3CDTi 146 (double Wheel) propulsion	R	05/10→					305x18					
Vivaro (2001>2006)												
1.9Di, 1.9DTi, 2.0i, 2.5DTi	F	05/01→07/06	LUC 23099 	598545	0		305,5x28 (24)	186712	●186987			
Bearing Roulement (-)	R	05/01→07/06	LUC 21748 	598546	0(A)		280x12 (10)	186713				
Bearing Roulement (+)	R	05/01→07/06	LUC 21748 	598546	0(A)		280x12 (10)	● 197001				
Vivaro (2006>)												
2.0CDTi, 2.0i, 2.5CDTi	F	07/06→	LUC 23099 	598545	0		305,5x28 (24)	186712	●186987			
Bearing Roulement (-)	R	07/06→	LUC 21748 	598546	0(A)		280x12 (10)	186713				
Bearing Roulement (+)	R	07/06→	LUC 21748 	598546	0(A)		280x12 (10)	● 197001				
PEUGEOT 												
4007 (2007>)												
2.2HDi, 2.4i	F	07/07→										
	R	07/07→	AKE 24014 	598852	2		302x10 (8,4)	● 197116				
PEUGEOT 												
104 (72>88)												
1.1	F		CIT 20594 	598150	4		244,5x8,9 (7)	186143				
1.0, 1.1, 1.2, 1.4	F	07/72→05/88	ATE 20913 	* 598375	2(A)		241x10 (9)	186142				
	F	07/72→05/88	BDX 20347 	598078	2		241x10 (9)	186142				
106 (91>96)												
1.0, 1.0i, 1.1, 1.1i	⊗3	F 09/91→03/96	BDX 21061 	598181	4		238x8 (6)	186130				
	⊗4	F 09/91→03/96	BDX 21061 	598181	4		247,3x10 (8)	186200	186951			































																		
PEUGEOT  (.../...)																		
106 (91>96) (.../...)																		
1.0i, 1.1i, 1.4, 1.4i	ABS(+)	F	09/91→03/96	BDX 21061		598181	4		247x20,5 (18,5)	186194								
1.3i, 1.4D, 1.5D, 1.6i		F	09/91→03/96	BDX 21061		598181	4		247,3x10 (8)	186200	186951							
	ABS(+)	F	09/91→	BDX 21061		598181	4		247x20,5 (18,5)	186194								
	51132346	F	09/91→	BDX 21061		598181	4		247x20,5 (18,5)	186194								
	ABS(+)	F	→03/96	ATE 21430		598074	0		247x20,5 (18,5)	186194	●186986							
Electric	3DA(-)	F	07/94→03/96	ATE 21145		598156	4		238x8 (6)	186130	186916							
	DA(+)	F	07/94→03/96	BDX 21061		598075	0		247x10									
106 (96>2003)																		
1.0i, 1.1, 1.1i, 1.1i GPL	3	F	03/96→07/03	ATE 21145		598156	4		238x8 (6)	186130	186916							
1.0i, 1.1, 1.1i, 1.1i GPL 1.4, 1.4i, 1.5D, 1.6i	ABS(+)	F	03/96→07/03	BDX 21061		598081	2		247,3x10 (8)	186200	186914							
1.0i, 1.1, 1.1i, 1.1i GPL 1.4, 1.4i, 1.6i	ABS(-)	F	03/96→07/03	BDX 21061		598181	4		247,3x10 (8)	186200	186951							
Electric		F	03/96→07/03	BDX 21061		598075	0		247,3x10 (8)	186200								
1.6i		F	03/96→07/03	ATE 21430		598074	0		247x20,5 (18,5)	186194	●186986							
		R	03/96→07/03	BDX 20635		598396	0		247x8 (6)	186416								
107 (2005>)																		
1.0i, 1.4HDi		F	06/05→	BOS 23959		598718	0		247x20 (18)	●197047								
1007 (2005>)																		
1.4HDi, 1.4i, 1.6i		F	04/05→	BOS 23599		598464	0		266x22 (20,4)	186695	●186968							
1.6HDi		F	02/07→	BOS 23600		598465	0		283x26 (24)	186693	●186972							
1.6HDi, 1.6i		R	04/05→	LUC 20960		598463	0(D)		247x9 (7)	186694								
204 (65>77)																		
1.1		F	10/65→06/66															
1.1, 1.2D		F	10/65→07/68	ATE 20088		598338	0											
205 (741) (83>87)																		
1.0, 1.1 		F	02/83→07/87	BDX 20635		598177	2		247,3x10 (8)	186200								
1.0, 1.1, 1.3, 1.4, 1.6, 1.7D  		F	02/83→07/87	BDX 20635		598177	2		247,3x10 (8)	186200								













































			R P F		2+2		WVA		Valeo		Valeo		Valeo		
PEUGEOT  (.../...)															
205 (741) (83>87) (.../...)															
1.1, 1.3, 1.4, 1.6, 1.7D 	F	02/83-07/87	LUC 20989		* 598176	2		247,3x10 (8)	186200	186913					
1.6i, 1.9i 	CTi,GTi	F	02/83-07/87	BDX 20635		598177	2		247x20,4 (18,5)	186195					
1.6i 	CTi	F	02/83-07/87	LUC 20989		* 598176	2		247x20,4 (18,5)	186195					
1.9i 	CTi	F	02/83-07/87	LUC 20772		598084	2(A)		247x20,4 (18,5)	186195					
1.8, 1.9i 	F	08/83-07/87	LUC 20772		598084	2(A)		247x20,5 (18,5)	186194						
	R	08/83-07/87	BDX 20635		598396	0		247x8 (7)	186196						
205 (87>98)															
1.0, 1.0i, 1.1, 1.1i, 1.3, 1.4, 1.4i, 1.6 1.6i, 1.7D, 1.9D 	F	08/87-09/98	LUC 20989		* 598176	2		247,3x10 (8)	186200	186913					
	F	08/87-09/98	BDX 20635		598177	2		247,3x10 (8)	186200						
1.3, 1.6i, 1.9i 	F	08/87-09/98	BDX 20635		598177	2		247x20,4 (18,5)	186195						
	F	08/87-09/98	LUC 20772		598084	2(A)		247x20,4 (18,5)	186195						
1.6i 	F	08/87-12/94	LUC 20989		* 598176	2		247x20,4 (18,5)	186195						
1.6i, 1.7TD 	ABS(+)	F	06/90-09/98	LUC 20989		* 598176	2		247x20,5 (18,5)	186194					
1.6i, 1.7TD, 1.9i 	ABS(+)	F	08/87-09/98	BDX 20635		598177	2		247x20,5 (18,5)	186194					
1.6i, 1.9i 	F	08/87-09/98	LUC 20772		598084	2(A)		247x20,5 (18,5)	186194						
1.7D 	F	03/94-10/96	ATE 21430		598038	2		247x20,5 (18,5)	186194	186950					
1.0, 1.0i, 1.1, 1.1i, 1.3, 1.4, 1.4i, 1.6 1.6i, 1.7D, 1.9D 	F	08/87-09/98	BDX 21061		598081	2									
1.6i, 1.9i 	R	08/87-09/98	BDX 20635		598396	0		247x8 (7)	186196						
206 (98>)															
1.1i (3/5 doors)	ABS(-)	F	09/98-10/05	BOS 21980		598461	O(A)		247,3x10 (8)	186200					
	ABS(+)	F	09/98-09/05	BOS 21980		598461	O(A)		247x13 (11)	186598	●186971				
	ABS(+)	F	09/05-10/05	BOS 21980		598461	O(A)		247x20,5 (18,5)	186194	●186970				
1.4HDi (3/5 doors)	F	03/02-09/05	BOS 21980		598461	O(A)		247x13 (11)	186598	●186971					
	F	09/05-02/09	BOS 21980		598461	O(A)		247x20,5 (18,5)	186194	●186970					









































PEUGEOT (.../...)											
206 (98>) (.../...)											
1.4i (3/5 doors) (55KW)	F	09/98→09/05	BOS 21980	598461	O(A)		247x13 (11)	186598	● 186971		
	F	09/05→02/09	BOS 21980	598461	O(A)		247x20,5 (18,5)	186194	● 186970		
1.4i 16V (3/5 doors) (65...66KW)	F	10/03→05/06	BOS 23599	598464	0		266x22 (20,4)	186695	● 186968		
1.6HDi (3/5 doors)	F	04/04→02/09	BOS 23599	598464	0		266x22 (20,4)	186695	● 186968		
1.6i (3/5 doors) (66KW)	F	09/98→02/09	BOS 21980	598461	O(A)		247x20,5 (18,5)	186194	● 186970		
1.6i (3/5 doors) (81KW)	F	09/00→09/01	BOS 23396	598462	0		266x20,5 (18,6)	186198			
	F	09/01→09/06	BOS 23599	598464	0		266x22 (20,4)	186695	● 186968		
	F	09/06→02/09	LUC 23124	598398	0		266x22 (20,4)	186695			
1.9D (3/5 doors)	F	09/98→02/09	BOS 21980	598461	O(A)		247x20,5 (18,5)	186194	● 186970		
2.0HDi (3/5 doors)	F	09/99→09/01	BOS 23396	598462	0		266x20,5 (18,6)	186198			
	F	09/01→06/08	BOS 23599	598464	0		266x22 (20,4)	186695	● 186968		
2.0i 16V (3 doors) (100...101KW)	F	04/99→09/01	BOS 23396	598462	0		266x20,5 (18,6)	186198			
	F	09/01→10/05	BOS 23599	598464	0		266x22 (20,4)	186695	● 186968		
2.0i RC 16V (3 doors) (130KW)	F	05/03→02/09	BOS 23600	598465	0		283x26 (24)	186693	● 186972		
1.1i SW	F	05/02→03/04	BOS 21980	598461	O(A)		247x13 (11)	186598	● 186971		
	F	03/04→10/05	BOS 21980	598461	O(A)		247x20,5 (18,5)	186194	● 186970		
1.4HDi SW	F	05/02→09/05	BOS 21980	598461	O(A)		247x13 (11)	186598	● 186971		
	F	10/05→02/09	BOS 21980	598461	O(A)		247x20,5 (18,5)	186194	● 186970		
1.4i SW (55KW)	F	05/02→09/05	BOS 21980	598461	O(A)		247x13 (11)	186598	● 186971		
	F	10/05→02/09	BOS 21980	598461	O(A)		247x20,5 (18,5)	186194	● 186970		
1.4i 16V SW (66KW)	F	10/03→05/06	BOS 23599	598464	0		266x22 (20,4)	186695	● 186968		
1.6HDi SW	F	04/04→02/09	BOS 23599	598464	0		266x22 (20,4)	186695	● 186968		
1.6i SW	F	05/02→06/06	BOS 23599	598464	0		266x22 (20,4)	186695	● 186968		
	F	06/06→02/09	LUC 23124	598398	0		266x22 (20,4)	186695			















































			 R P F		 WVA	 Valeo	 Valeo	 Valeo	 Valeo	 Valeo
PEUGEOT  (.../...)										
206 (98>) (.../...)										
2.0HDi SW 	F	05/02→10/05	BOS 23599 	598464	0		266x22 (20,4)	186695	●186968	
2.0i SW 	F	05/02→10/05	BOS 23599 	598464	0		266x22 (20,4)	186695	●186968	
1.6HDi CC 	F	04/04→02/09	BOS 23599 	598464	0		266x22 (20,4)	186695	●186968	
1.6i CC 	F	02/01→09/01	BOS 23396 	598462	0		266x20,5 (18,6)	186198		
	F	09/01→11/06	BOS 23599 	598464	0		266x22 (20,4)	186695	●186968	
	F	11/06→02/09	LUC 23124 	598398	0		266x22 (20,4)	186695		
2.0i CC 	F	10/00→09/01	BOS 23396 	598462	0		266x20,5 (18,6)	186198		
	F	09/01→02/09	BOS 23599 	598464	0		266x22 (20,4)	186695	●186968	
1.4HDi (sedan 4 doors)	F	11/08→	BOS 21980 	598461	O(A)		247x20,5 (18,5)	186194	●186970	
1.4i (sedan 4 doors)	F	10/05→	BOS 21980 	598461	O(A)		247x13 (11)	186598	●186971	
	F	10/05→	BOS 21980 	598461	O(A)		247x20,5 (18,5)	186194	●186970	
1.6i (sedan 4 doors)	F	10/05→11/06	BOS 23599 	598464	0		266x22 (20,4)	186695	●186968	
	F	11/06→	LUC 23124 	598398	0		266x22 (20,4)	186695		
1.4i 16V, 1.4i SW 16V, 1.6HDi, 1.6HDi CC 1.6HDi SW, 1.6i 16V, 1.6i CC 16V, 1.6i SW 16V 2.0i 16V, 2.0i CC 16V, 2.0i RC 16V 2.0i SW 16V	R	04/99→	BDX 20635 	598396	0		247x8 (6)	186416		
206+ (2009>)										
1.1i, 1.4HDi, 1.4i	F	03/09→	BOS 21980 	598461	O(A)		247x13 (11)	186598	●186971	
	F	03/09→	BOS 21980 	598461	O(A)		247x20,5 (18,5)	186194	●186970	
207 (2006>)										
1.4HDi, 1.4e, 1.6HDi 	F	03/06→	BOS 23599 	598464	0		266x22 (20,4)	186695	●186968	
1.4VTi, 1.6HDi, 1.6THP, 1.6VTi, 1.6e 	F	03/06→	BOS 23600 	598465	0		283x26 (24)	186693	●186972	
1.6THP 	F	04/07→	ATE 23589 	598715	0		302x26 (24)	●197232		
1.6HDi, 1.6THP 1.6VTi, 1.6e 	Bearing Roulement (+)	R	03/06→	BOS 24150 	598702	0		249x9 (7)	●197002	
	Bearing Roulement (+)	R	09/08→	LUC 20960 	598474	O(D+C)		249x9 (7)	●197002	











































										
PEUGEOT  (.../...)										
304 (69>80)										
1.1, 1.3, 1.4D 	F	07/69-07/77								
1.1, 1.3, 1.4D, 1.6D 	F	08/77-03/80	BDX 20347 	598078	2		263x10 (9)	* 186197		
	F	08/77-03/80	ATE 20913 	* 598375	2(A)		263x10 (9)	* 186197		
305 (77>82)										
1.1, 1.3, 1.5, 1.5D	F	11/77-07/82	BDX 20347 	598078	2		263x10 (9)	* 186197		
	F	11/77-07/82	ATE 20913 	* 598375	2(A)		263x10 (9)	* 186197		
305 (82>90)										
1.1, 1.3, 1.5, 1.6, 1.7D, 1.9D 	F	08/82-06/90	BDX 21061 	598081	2		266x10 (8)	186134		
	F	08/82-06/90	BDX 20635 	598177	2		266x10 (8)	186134		
1.3 	F	08/82-02/88	BDX 20347 	598078	2		266x10 (8)	186134		
	F	08/82-02/88	ATE 20913 	* 598375	2(A)		266x10 (8)	186134		
1.9, 1.9i 	F	08/82-06/90	BDX 20635 	598177	2		266x20,5 (18,6)	186198		
	F	08/82-06/90	BDX 21061 	598081	2		266x20,5 (18,6)	186198		
306 (93>97)										
1.1i, 1.4, 1.4i  ABS(-)	F	02/93-02/97	BDX 21061 	598181	4		247,3x10 (8)	186200	186951	
1.1i, 1.4, 1.4i, 1.6i, 1.8D, 1.8i 1.9D, 1.9TD  ABS(+)	F	02/93-02/97	ATE 21430 	598038	2		247x20,5 (18,5)	186194	186950	
2.0i, 2.0i 16V 	F	06/93-02/97	LUC 21209 	598353	4		266x20,5 (18,6)	186198		
2.0i (110KW) 	F	07/94-02/97	LUC 21209 	598353	4		283x22 (20)	186296		
2.0i 16V (123KW) 	F	03/96-02/97	LUC 21674 	598069	4		283x22 (20)	186296		
2.0i, 2.0i 16V 	R	06/93-02/97	BDX 20635 	598396	0		247x8 (6)	186416		
306 (97>2002)										
1.4, 1.4i, 1.4i GPL  ABS(-)	F	03/97-02/02					247x13 (11)	186598		
1.4, 1.4i, 1.4i GPL, 1.6i, 1.8D, 1.8i, 1.9D 1.9SD, 1.9TD 	F	03/97-09/02	ATE 21430 	598074	0		247x20,5 (18,5)	186194	●186986	





























															
PEUGEOT  (.../...)															
306 (97>2002) (.../...)															
1.4, 1.4i, 1.4i GPL, 1.6i, 1.8i 1.8i GPL, 1.9D, 1.9SD, 1.9TD 2.0HDi, 2.0i 	ABS(+)	F	03/97→09/02	BOS 23396 	598462	0		266x20,5 (18,6)	186198						
	ABS(+)	F	03/97→09/02	LUC 23124 	598326	4		266x20,5 (18,6)	186198	●186978					
1.4i 	ABS(+)	F	07/98→03/01	ATE 21430 	598074	0		266x20,5 (18,6)	186198						
2.0i 		F	03/97→02/02	LUC 21674 	598069	4		283x22 (20)	186296						
1.8i, 1.8i GPL, 2.0HDi, 2.0i 		R	03/97→09/02	BDX 20635 	598396	0		247x8 (6)	186416						
307 (2001>2005)															
1.4HDi, 1.4i, 1.6HDi, 1.6i 2.0HDi 	ESP(-)	F	09/01→06/05	BOS 23599 	598464	0		266x22 (20,4)	186695	●186968					
1.4i, 1.6HDi, 1.6i, 2.0HDi 2.0i 	ESP(+)	F	03/01→06/05	BOS 23600 	598465	0		283x26 (24)	186693	●186972					
2.0HDi, 2.0i 		F	09/03→06/05	ATE 23589 	598715	0		302x26 (24)	●197232						
1.4HDi, 1.4i, 1.6HDi, 1.6i, 2.0HDi 2.0i 		R	03/01→06/05	LUC 20960 	598463	0(D)		247x9 (7)	186694						
	Ø25 bearing, Bearing Roulement (-)	R	01/04→06/05	BOS 24150 	598702	0		249x9 (8)	186840						
	Ø25 bearing, Bearing Roulement (+)	R	01/04→06/05	BOS 24150 	598702	0		249x9 (8)	186899						
307 (2005>)															
1.4i, 1.6HDi, 1.6i 		F	06/05→	BOS 23599 	598464	0		266x22 (20,4)	186695	●186968					
1.4i, 1.6HDi, 1.6i, 2.0HDi 2.0i 	ESP(+)	F	06/05→	BOS 23600 	598465	0		283x26 (24)	186693	●186972					
2.0HDi, 2.0i 		F	06/05→	ATE 23589 	598715	0		302x26 (24)	●197232						
1.4i, 1.6HDi, 1.6i, 2.0HDi, 2.0i 		R	06/05→	LUC 20960 	598463	0(D)		247x9 (7)	186694						
	Ø25 bearing, Bearing Roulement (-)	R	06/05→	BOS 24150 	598702	0		249x9 (8)	186840						
	Ø25 bearing, Bearing Roulement (+)	R	06/05→	BOS 24150 	598702	0		249x9 (8)	186899						
	Ø30 bearing, Bearing Roulement (+)	R	06/05→	BOS 24150 	598702	0		249x9 (7)	●197002						

																		
PEUGEOT  (.../...)																		
308 (2007>)																		
1.4VTi, 1.6HDi, 1.6THP, 1.6VTi, 1.6VTi 120 2.0HDi 	F	09/07→	BOS 24660 	● 598927	0	 283x26 (24)	186693											
1.6THP, 1.6THP 156, 2.0HDi 	F	09/07→	ATE 23589 	598715	0	 302x26 (24)	● 197216											
1.4VTi, 1.6HDi, 1.6THP, 1.6THP 156, 1.6VTi 1.6VTi 120, 1.6i, 2.0HDi 	R	09/07→	LUC 20960 	598463	0(D)	 249x9 (8)	● 197100											
1.6HDi, 1.6THP 1.6VTi, 2.0HDi  Bearing Roulement (+)	R	05/08→	LUC 24765 	● 601042	0	 267x12	● 197117											
3008 (2009>)																		
1.6HDi 110, 1.6VTi 120	F	09/09→	BOS 24660 	● 598927	0	 283x26 (24)	186693											
1.6THP 150, 1.6THP 156, 2.0HDi 150 2.0HDi 163	F	09/09→	ATE 23589 	598715	0	 302x26 (24)	● 197216											
1.6HDi 110 1.6THP 150 1.6THP 156 1.6VTi 120 2.0HDi 150 2.0HDi 163	R	09/09→				 267x12	● 197117											
309 (85>89)																		
1.1, 1.3, 1.4, 1.4i, 1.5, 1.6, 1.6i, 1.7D 1.9, 1.9D, 1.9i	F	09/85→07/89	BDX 21061 	598081	2	 247,3x10 (8)	186200	186914										
	F	09/85→07/89	LUC 20989 	* 598176	2	 247,3x10 (8)	186200	186913										
1.9i	F	09/85→06/89	BDX 21061 	598081	2	 247x20,5 (18,5)	186194											
	F	09/85→06/89	LUC 20989 	* 598176	2	 247x20,5 (18,5)	186194											
	F	08/86→07/89	LUC 20772 	598084	2(A)	 247x20,5 (18,5)	186194											
1.6i, 1.9i	R	09/85→07/89	BDX 20635 	598396	0	 247x8 (7)	186196											
309 (89>94)																		
1.1, 1.1i, 1.3, 1.4, 1.4i, 1.5, 1.6, 1.6i 1.7D, 1.7TD, 1.9, 1.9D	F	08/89→08/94	BDX 21061 	598081	2	 247,3x10 (8)	186200	186914										
	F	08/89→08/94	LUC 20989 	* 598176	2	 247,3x10 (8)	186200	186913										
1.9, 1.9i	F	08/89→08/93	LUC 20772 	598084	2(A)	 247x20,5 (18,5)	186194											













































			RPF		WVA		Valeo		Valeo		Valeo	
PEUGEOT  (.../...)												
309 (89>94) (.../...)												
1.9, 1.9i (...)	F	08/89→08/93	BDX 21061		598081	2		247x20,5 (18,5)	186194			
1.9i	F	08/89→08/93	LUC 20989		* 598176	2		247x20,5 (18,5)	186194			
	R	08/89→08/93	BDX 20635		598396	0		247x8 (7)	186196			
405 (87>92)												
1.4, 1.4i GPL, 1.6, 1.7D, 1.7TD, 1.9, 1.9D	F	06/87→06/92	BDX 21061		598081	2		266x10 (8)	186134			
1.6i, 1.7TD, 1.9, 1.9D, 1.9i	F	06/88→06/92	LUC 21209		598179	2		266x10 (8)	186134			
1.6i, 1.9, 1.9i	F	06/87→06/92	LUC 21209		598179	2		266x20,5 (18,6)	186198	186915		
1.9i	4WD (-)	R	06/87→06/92	LUC 20960		598180	O(D)		247x10 (8)	186199		
1.9, 1.9i	4WD (+)	R	06/88→06/92	LUC 20960		598180	O(D)		247,3x10 (8)	186200		
405 (92>96)												
1.4, 1.6	F	07/92→10/96	BDX 21061		598081	2		266x10 (8)	186134			
	F	07/92→10/96	LUC 21209		598179	2		266x10 (8)	186134			
1.4, 1.6, 1.9	F	07/92→10/96	BDX 21061		598081	2		266x20,5 (18,6)	186198			
1.4, 1.4i, 1.6, 1.6i, 1.7TD, 1.8i, 1.9, 1.9D 1.9TD, 1.9i, 2.0i	F	07/92→10/96	LUC 21209		598179	2		266x20,5 (18,6)	186198	186915		
2.0i Turbo 	F	07/92→10/95	LUC 21209		598179	2		283x22 (20)	186296			
	F	07/92→10/95						283x22 (20)	186296			
1.9i, 2.0i	4WD (-)	R	07/92→10/96	LUC 20960		598180	O(D)		247x10 (8)	186199		
2.0i, 2.0i Turbo	4WD (+)	R	07/92→10/96	LUC 20960		598180	O(D)		247,3x10 (8)	186200		
406 (95>2004)												
1.6i, 1.8i, 1.8i GPL, 1.9TD 	F	10/95→04/04	LUC 21724		598068	4		260x27 (22)	186532			
1.9TD, 2.0, 2.0HDI, 2.0HPI, 2.0i, 2.0i Turbo 2.1TD, 2.2HDI, 2.2i, 3.0, 3.0i V6 	F	10/95→10/04	LUC 21674		598069	4		283x26 (24)	186533			
2.2HDI, 3.0i V6 	F	05/97→04/03	BBO 21381		598466	4		305x28 (26)	197231			
1.8i, 1.8i GPL, 2.0, 2.0HDI, 2.0HPI, 2.0i 2.0i Turbo, 2.1TD, 2.2HDI, 2.2i, 3.0 3.0i V6 	R	10/95→10/04	ATE 21279		598063	0		290,5x10 (8)	186579			



























									
PEUGEOT  (.../...)									
406 (95>2004) (.../...)									
1.8i, 1.8i GPL, 2.0HDI, 2.0HPi, 2.0i 2.0i Turbo, 2.1TD, 2.2HDI, 2.2i 3.0i V6 	P				564018				
2.0i, 2.0i Turbo, 2.1TD 3.0i V6 	 80012041	P	-10/97		562738				
407 (2004>)									
1.8i, 2.0i 	F	04/04→	LUC 24134 	598662	2	 283x26 (24)	186746		
1.6HDI, 2.0HDI 	F	02/05→	LUC 24134 	598662	2	 283x26 (24)	186746		
2.2HDI, 2.2i, 2.7HDI V6, 3.0i V6 	F	04/04→07/07	LUC 24133 	598663	2	 330x30 (28)	● 197046		
2.7HDI V6 	F	07/07→	LUC 24133 	598663	2	 330x30			
2.0HDI 	F	07/09→				 304x28 (26)	● 197133		
3.0HDI V6 	F	07/09→				 340x30			
1.6HDI, 1.8i, 2.0HDI, 2.0i, 2.2HDI, 2.2i 2.7HDI V6, 3.0i V6 	R	04/04→	LUC 24135 	598664	0	 290x12 (10)	186747		
2.0HDI, 2.2i, 2.7HDI V6, 3.0HDI V6 3.0i V6 	R	09/05→	LUC 24135 	598664	0	 290x12 (10)	● 197010		
504 (68>2000)									
1.6, 1.8, 1.8i, 1.9D, 2.0, 2.0i, 2.1D, 2.3D 2.5D 	F	06/68→09/93	LUC 20146 	598174	2	 273x12,9 (10,7)	186202		
1.6, 1.8 	F	08/79→09/93	ATE 20454 	598178	2	 273x12,9 (10,7)	186202		
2.0, 2.3D 	F	08/80→07/85	ATE 20454 	598178	2	 273x12,9 (10,7)	186202		
2.0, 2.3D 	F	10/93→1996				 273x12,9 (10,7)	186202		
	F	10/93→1996	BDX 20631 	598175	2	 273x12,9 (10,7)	186202		
2.7 V6, 2.7i V6 Injection 	F	09/74→07/84	ATE 20454 	598178	2	 273x20 (18)	* 186203		
1.8i, 2.0i, 2.7 V6, 2.7i V6 Injection 	R	06/68→07/84	LUC 20253 	598193	2	 273x12			
505 (79>90)									
1.6, 1.8, 2.0, 2.0i, 2.2i, 2.3D, 2.3TD, 2.5D 2.5TD 	F	05/79→1990	ATE 20454 	598178	2	 273x12,9 (10,7)	186202		







































															
PEUGEOT  (.../...)															
505 (79>90) (.../...)															
1.6, 1.8, 2.0, 2.0i, 2.2i, 2.3D, 2.3TD, 2.5D 2.5TD   (...)	F	05/79→1990	BDX 20631		598175	2		273x12,9 (10,7)	186202						
2.2 Turbo, 2.2 Turbo injection 2.2T, 2.8 V6  	ABS(+)	F	08/82→1990	ATE 20454		598178	2		273x20 (18)	* 186203					
2.8 V6 		F	08/85→1990	ATE 20454		598178	2								
2.0i, 2.2 Turbo, 2.2 Turbo injection, 2.2T 2.2i, 2.5D, 2.5TD 		R	05/79→1990	LUC 20253		598193	2		273x12						
5008 (2009>)															
1.6HDI 110, 1.6VTi 120		F	09/09→	ATE 24538		● 598997	0		283x26 (24)	186693					
1.6THP 156, 2.0HDI 150, 2.0HDI 163		F	09/09→	ATE 24557		● 598998	0		302x26 (24)	● 197216					
1.6HDI 110 1.6THP 156 1.6VTi 120 2.0HDI 150 2.0HDI 163	Bearing Roulement (+)	R	09/09→						267x12	● 197117					
604 (76>86)															
2.0i, 2.3TD, 2.5TD		F	02/79→12/86	ATE 20454		598178	2		273x12,9 (10,7)	186202					
2.7 V6, 2.7i V6, 2.8i V6		F	03/76→12/86	ATE 20454		598178	2		273x20 (18)	* 186203					
2.0i, 2.3TD, 2.5TD, 2.7 V6, 2.7i V6, 2.8i V6		R	03/76→12/86	LUC 20253		598193	2		273x12						
605 (89>94)															
2.0, 2.0i, 2.1D 2.1TD Turbo, 3.0i V6 3.0i V6 24V	 S90807683	F	10/89→	BDX 21295		598294	4		276x22 (20)	186145					
2.0i	 S90807684	F	-06/94	BDX 21507		598280	4		276x22 (20)	186145					
2.0, 2.0i, 2.0i Turbo, 2.1D 2.1TD Turbo, 3.0i V6	 S90807684	F	-06/94	BDX 21507		598280	4		283x26 (24)	186303					
3.0i V6 24V	 S90807684	F	-06/94	ATE 21211		598281	2		283x26						
2.0, 2.0i, 2.0i Turbo, 2.1D, 2.1TD Turbo 3.0i V6, 3.0i V6 24V		R	10/89-06/94	ATE 21279		598295	2		290x10 (8)	186204					

































								
PEUGEOT  (.../...)								
605 (94>99)								
2.0, 2.0i, 2.0i Turbo, 2.1TD Turbo, 2.5TD 3.0i V6	F	07/94→05/99				 283x26 (24)	186303	
3.0i V6 24V	⊙ 16"	F	07/94→12/97	ATE 21211 	598281	2		
	⊙ 16"	F	06/97→05/99					
2.0, 2.0i, 2.0i Turbo, 2.1TD Turbo, 2.5TD 3.0i V6, 3.0i V6 24V	R	07/94→05/99	ATE 21279 	598295	2	 290x10 (8)	186204	
607 (2000>2004)								
2.0HDi, 2.0i, 2.2HDi, 2.2i	F	05/00→09/04	LUC 21674 	598467	4	 283x26 (24)	186702	
3.0i V6	F	05/00→09/04	BBO 23092 	598468	4	 309x32 (30)	186703	
2.0HDi, 2.0i, 2.2HDi, 2.2i, 3.0i V6	R	05/00→09/04	ATE 21279 	598063	0	 289x10 (8)	186785	
	P	05/00→09/04		562738				
	P	05/00→09/04		564018				
607 (2004>)								
2.0HDi, 2.2HDi, 2.2i, 2.7HDi, 3.0i V6	F	10/04→	LUC 24133 	598663	2	 330x30 (28)	197046	
	R	10/04→	LUC 24135 	598664	0	 290x12 (10)	186747	
806 (94>98)								
1.8i	F	06/95→09/98	BDX 23042 	598073	2	 257x20 (18,2)	186589	186931
1.9TD, 2.0i, 2.0i Turbo, 2.1TD	F	07/94→09/98	LUC 21801 	598064	4	 281x26 (24,2)	186420	
1.8i, 1.9TD, 2.0i, 2.0i Turbo, 2.1TD	R	07/94→09/98	ATE 21275 	598502	0	 295x10 (8)	186421	
	P	07/94→09/98		562739				
806 (98>2002)								
1.8i	F	10/98→05/02	BDX 23042 	598073	2	 257x20 (18,2)	186589	186931
1.9TD, 2.0HDi, 2.0i, 2.0i Turbo CT, 2.1TD	F	10/98→05/02	LUC 21801 	598064	4	 281x26 (24,2)	186420	
1.8i, 1.9TD, 2.0i, 2.0i Turbo CT, 2.1TD	R	10/98→05/02	ATE 21275 	598502	0	 295x10 (8)	186421	
	P	10/98→05/02		562739				
807 (2002>)								
2.0HDi, 2.0i, 2.2HDi, 2.2i	F	06/02→	LUC 20261 	598553	2(A)	 285,2x28 (26)	197219	186984







PEUGEOT (.../...)									
807 (2002>) (.../...)									
2.2HDi	F	12/07→					310x32		
3.0i V6	F	06/02→09/05	BBO 23092	598468	4		310x32		
2.0HDi, 2.0i, 2.2HDi, 2.2i, 3.0i V6	R	06/02→	LUC 20960	598463	0(D)		272x12 (10)	186724	
RCZ (2010>)									
1.6THP 156, 2.0HDi 163	F	05/10→	ATE 23589	598715	0		302x26		
	R	05/10→					290x12 (10)	186747	
PEUGEOT									
Bipper (2007>)									
1.4HDi, 1.4i	F	12/07→	BOS 23705	598426	1		257x22 (20,5)	186590	
Boxer I (94>2001)									
1.9D, 1.9TD, 2.0, 2.0i, 2.5D	10Q, 14Q	F	02/94→12/01	LUC 21797	598070	2(B)	280x18 (15,9)	197217	
	10Q, 14Q	F	02/94→12/01	LUC 21797	598429	1(A)	280x18 (15,9)	197217	
2.0HDi, 2.5TD, 2.5TDi, 2.8D 2.8HDi, 2.8TD	10Q, 14Q	F	02/94→12/01	LUC 21797	598070	2(B)	280x24 (21,9)	186418	
	10Q, 14Q	F	02/94→12/01	LUC 21797	598429	1(A)	280x24 (21,9)	186418	
2.0i	18Q	F	02/94→08/98	LUC 21797	598070	2(B)	300x24 (21,9)	197228	
	18Q	F	02/94→08/98	LUC 21797	598429	1(A)	300x24 (21,9)	197228	
2.0, 2.0i, 2.5D, 2.5TD, 2.5TDi 2.8HDi	18Q	F	02/94→12/01	LUC 21799	598800	2(A)	300x24 (21,9)	197228	
	18Q	F	02/94→12/01	LUC 21799	598430	1(B)	300x24 (21,9)	197228	
Boxer I (2002>2006)									
2.0HDi, 2.0i, 2.2HDi 2.8HDi	11Q, 15Q, 33Q	F	01/02→06/06	BBO 23918	598568	1	280x24 (21,9)	186418	
2.0i, 2.2HDi, 2.8HDi	18Q, 35Q	F	01/02→06/06	BBO 23919	598569	1	300x24 (21,9)	197228	
2.8HDi	11Q, 15Q, 33Q	R	01/02→06/06	BBO 23921	598570	0	280x16		
2.0i, 2.2HDi, 2.8HDi	18Q, 35Q	R	01/02→06/06	BBO 23921	598570	0	280x16 (14,2)	186708	















																		
PEUGEOT  (.../...)																		
Boxer II (2006>)																		
2.2HDi, 3.0HDi	330, 333	F	07/06→	BBO 24468		● 598891	1		280x24 (21,9)	● 197043								
	335	F	07/06→	BBO 24468		● 598891	1		280x28 (25,9)	● 197248								
3.0HDi	335, 1700Kg	F	07/06→						300x24 (21,9)	● 197131								
	335, 2000Kg	F	07/06→						300x32									
2.2HDi, 3.0HDi	330, 333, 335	R	07/06→	BOS 24465		● 598892	0		280x16 (14,2)	● 197023								
	335, 1700Kg	R	07/06→						280x16 (14,2)	● 197097								
	335, 2000Kg	R	07/06→						300x16 (14,2)	● 197105								
Expert I (95>2003)																		
1.6i, 1.8i, 1.9D, 1.9TD, 2.0HDi, 2.0i		F	09/95→12/03	BDX 23042		598073	2		257x20 (18,2)	186589	186931							
1.6i, 1.9D, 1.9TD, 2.0HDi, 2.0i		F	09/95→12/03	LUC 21801		598064	4		281x26 (24,2)	186420								
Expert I (2004>2006)																		
1.9D		F	01/04→12/06	BDX 23042		598073	2		257x20 (18,2)	186589	186931							
2.0HDi, 2.0i		F	01/04→12/06	LUC 20261		598553	2(A)		285,2x28 (26)	● 197219	● 186984							
Expert II (2007>)																		
1.6HDi		F	01/07→	LUC 24595		● 598899	1		280x28 (26)	● 197188								
1.6HDi, 2.0HDi, 2.0i		F	01/07→	LUC 24595		● 598899	1		304x28 (26)	● 197133								
		R	01/07→	LUC 24578		● 601039	0		290x14 (12)	● 197099								
J5 (280) (81>90)																		
1.8, 1.8 GPL, 1.9D, 2.0, 2.5D	 154462	F	→08/90	LUC 20741		598153	2		256x16 (13,5)	186206								
1.8, 1.8 GPL, 2.0, 2.5D	 154461	F	11/81→	LUC 20741		598153	2		256x13 (11)	186205								
2.0, 2.5D, 2.5TD		F	11/81→08/90	LUC 21206		598138	2		290x16 (14,8)	186136								
J5 (290) (90>94)																		
1.8, 1.9D, 2.0, 2.5D, Electric		F	09/90→02/94	LUC 20741		598153	2		256x16 (13,5)	186206								
1.9TD		F	09/90→02/94	LUC 21206		598138	2		256x16 (13,5)	186206								
2.0, 2.5D, 2.5TD		F	09/90→02/94	LUC 21206		598138	2		290x16 (14,8)	186136								













										
PEUGEOT  (.../...)										
J7 (65>80)										
1.6, 1.8, 2.0D, 2.1D, 2.3D	F	08/73→01/80	BDX 20366 	598593	2		280x14 (12,6)	186207		
J9 (80>91)										
1.6, 2.0, 2.1D, 2.3D, 2.5D	F	01/80→1991	BDX 20366 	598593	2		280x14 (12,6)	186207		
1.6, 2.0, 2.1D, 2.5D	F	10/85→1991	BDX 20366 	598594	2		280x14 (12,6)	186207		
P4 (86>)										
2.5D, 2.5TD	F	1986→	PER 20784 	598613	0		303x16			
Partner (M49) (96>2002)										
1.1i, 1.1i GPL, 1.4, 1.4i, 1.4i GPL	F	06/96→11/02	LUC 23124 	598326	4		266x13 (11)	186599		
1.6i, 1.8D, 1.8i, 1.9D, 2.0HDi, Electric	F	06/96→11/02	LUC 23124 	598326	4		266x20,5 (18,6)	186198	● 186978	
	F	06/96→11/02	BOS 23599 	598464	0		266x20,5 (18,6)	186198		
	F	01/01→11/02	LUC 23124 	598326	4		266x22 (20,4)	186695		
	F	01/01→11/02	BOS 23599 	598464	0		266x22 (20,4)	186695	● 186968	
	F	01/01→11/02					266x22 (20,4)	186695		
Partner (M59/U) (2002>)										
1.1i, 1.4i, 1.4i GNV, 1.4i GPL 1.6HDi, 1.6i, 1.9D, 2.0HDi Electrique	ESP(-)	F	11/02→	BOS 23599 	598464	0		266x22 (20,4)	186695	● 186968
1.6HDi, 1.6i, 2.0HDi	ESP(+)	F	11/02→05/08	BOS 23600 	598465	0		283x26 (24)	186693	● 186972
	ESP(+)	R	11/02→05/08	LUC 20960 	598463	0(D)		247x9 (7)	186694	
Partner (2008>)										
1.6HDi, 1.6i Bearing Roulement (+)		F	05/08→	ATE 24538 	● 598997	0		283x26 (24)	186693	
		R	05/08→	LUC 24765 	● 601042	0		267x12	● 197117	
Ranch (M49) (96>2002)										
1.4i ABS(-)	F	06/96→11/02	LUC 23124 	598326	4		266x13 (11)	186599		
1.4i, 1.8D, 1.8i, 1.9D, 2.0HDi	F	06/96→11/02	LUC 23124 	598326	4		266x20,5 (18,6)	186198	● 186978	
	F	06/96→11/02	BOS 23599 	598464	0		266x20,5 (18,6)	186198		
1.8D, 1.8i, 1.9D, 2.0HDi	F	11/01→11/02	LUC 23124 	598326	4		266x22 (20,4)	186695		









															
PEUGEOT 															
Ranch (M49) (96>2002) (.../...)															
1.8D, 1.8i, 1.9D, 2.0HDI (...)			F	11/01→11/02	BOS 23599 	598464	0		266x22 (20,4)	186695	● 186968				
			F	11/01→11/02						266x22 (20,4)	186695				
Ranch (M59/U) (2002>)															
1.4i, 1.6HDI, 1.6i, 1.9D, 2.0HDI			ESP(-)	F	11/02→05/08	BOS 23599 	598464	0		266x22 (20,4)	186695	● 186968			
1.6HDI, 1.6i, 2.0HDI			ESP(+)	F	11/02→05/08	BOS 23600 	598465	0		283x26 (24)	186693	● 186972			
			ESP(+)	R	11/02→05/08	LUC 20960 	598463	0(D)		247x9 (7)	186694				
PORSCHE 															
Cayenne (2003>)															
3.2i V6			⊗ 17" Left disc	F	03/03→12/06	BBO 23692 	598655	0		330x32 (30)	● 197087				
			⊗ 17" Right disc	F	03/03→12/06	BBO 23692 	598655	0		330x32					
			⊗ 18"	F	03/03→12/06	BBO 23693 	598656	0		350x34					
3.6DFI V6 4.6DFI V8			Black Caliper Left disc	F	12/06→	BBO 23692 	598655	0		330x32 (30)	● 197087				
			Black Caliper Right disc	F	12/06→	BBO 23692 	598655	0		330x32					
3.6DFI V6, 4.5i V8 4.5i V8 Turbo, 4.6DFI V8			Silver Caliper	F	03/03→	BBO 23693 	598656	0		350x34					
3.6DFI V6, 4.6DFI V8			Red Caliper	F	03/03→					350x34					
4.5i V8 Turbo			⊗ 19"	F	12/04→	BBO 23961 	598709			350x34					
3.2i V6, 3.6DFI V6 4.6DFI V8			Black & Silver Caliper	R	03/03→	BBO 23694 	598770	0		330x28 (26)	● 197090				
			Red Caliper	R	03/03→						358x28 (26)	● 197051			
3.2i V6, 4.5i V8, 4.5i V8 Turbo				P	03/03→12/06		562805								
PORSCHE 															
911 (70>83)															
3.0, 3.3 Turbo				F	09/77→07/83	ATE 20011 	* 598111	0		282x20,4					





















































			R P F		WVA		Valeo		Valeo		Valeo	
PORSCHE  (.../...)												
911 (996) (97>2005)												
3.4i, 3.6i 	F	09/97→08/05	BBO 23329		598767	0						
	R	09/97→08/05	BBO 21792		598768	0		299x24				
Boxster (96>2002)												
2.5i, 2.7i	F	08/96→06/02	BBO 21937		598766	0		298x24				
3.2i	F	08/99→06/02	BBO 23329		598767	0		318x28				
2.5i, 2.7i, 3.2i	R	08/96→06/02	BBO 21792		598768	0						
Boxster (2002>2004)												
2.7i	F	07/02→10/04	BBO 21937		598766	0		298x24				
3.2i	F	07/02→10/04	BBO 23329		598767	0		318x28				
2.7i, 3.2i	R	07/02→10/04	BBO 21792		598768	0						
Boxster (2004>)												
2.7i, 3.2i, 3.4i	F	11/04→						318x28				
	R	11/04→	BBO 21792		598768	0		299x24				
Cayman (2005>)												
3.4i	F	11/05→	BBO 23329		598767	0		318x28				
2.7i, 3.4i	F	11/05→						318x28				
	R	11/05→	BBO 21792		598768	0		299x24				
PROTON 												
300 (96>)												
1.3i	F	08/96→	SUM 21650		598626	0						
1.5i	F	08/96→						236x18 (16,4)	186818			
1.6i	F	08/96→	SUM 21647		598625	0						
	R	08/96→	AKE 21872		598844	2		260x10				
400 (93>)												
1.3i	F	12/95→	SUM 21650		598626	0						
1.3i, 1.5i, 2.0D, 2.0TD	F	11/93→						236x18 (16,4)	186818			













































																	
PROTON  (.../...)																	
400 (93>) (.../...)																	
1.6i, 1.8i		F	11/93→	SUM 21647		598625	0										
		R	11/93→	AKE 21872		598844	2		260x10								
RELIANT 																	
Scimitar (68>92)																	
3.0 V6		F	01/68→1976														
2.8 V6, 3.0 V6		F	1976→06/86	AP 20894		* 598391	2										
1.3, 1.4, 1.6, 1.8		F	02/85→1990	AP 20754		598116	2										
1.4, 1.8		F	1990→1992	LUC 21084		598118	2										
RENAULT 																	
Cherokee																	
2.1TD, 4.0		F	09/84→12/89	KH 21820		598595	0		280x22								
		F	01/90→01/93	KH 21822		598491	0		280x								
Jeep																	
2.0, 2.1TD, 2.5		F	05/82→1990	KH 21820		598595	0										
2.5		F	1990→01/93	KH 21822		598491	0										
Koleos (2008>)																	
2.0dCi, 2.5i		F	06/08→	AKE 29738		598738	1										
		R	06/08→	AKE 24632		● 601009	1										
RENAULT 																	
R4 (62>92)																	
1.0, 1.1, 1.1 GPL		F	09/77→1992	BDX 20347		598077	0		228x10 (9)	186226	186956						
		F	09/77→1992	LUC 20480		598076	0		228x10 (9)	186226							
R5 (72>85)																	
0.9, 1.0, 1.1, 1.3, 1.4		F	01/72→06/85	LUC 20480		598076	0		228x10 (9)	186226							
1.0, 1.1, 1.3, 1.4, 1.4 Turbo		F	01/72→06/85	BDX 20347		598077	0		228x10 (9)	186226	186956						
1.3, 1.4		F	07/79→06/85	LUC 20772		598084	2(A)		228x10 (9)	186226							
1.4		F	06/82→06/85	BDX 20631		598175	2		228x10 (9)	186226							

																				
RENAULT  (.../...)																				
R5 (72>85) (.../...)																				
1.4, 1.4 Turbo	F	07/75→06/85	LUC 20671		598377	2		228x10 (9)	186226											
	R	07/81→06/85	BDX 20347		598085	2		228x10 (9)	186226											
Super 5 (84>96)																				
0.9, 1.1	F	07/84→1996						238x8 (7)	186228											
	F	07/84→1996	BDX 20635		598080	2		238x8 (7)	186228	186918										
1.2, 1.4, 1.4i, 1.6D, 1.7	F	07/84→12/96	BDX 21061		598081	2		238x11,9 (10,5)	186230	186919										
	F	07/84→12/96	LUC 20772		598002	2(B)		238x11,9 (10,5)	186230	186921										
1.4 Turbo, 1.7	F	07/84→08/90	LUC 20772		598002	2(B)		238x20 (17,7)	186229	186923										
	F	07/84→08/90	BDX 21061		598081	2		238x20 (17,7)	186229	186954										
	R	07/84→08/90	BDX 20635		598396	0		238x8 (7)	186231											
R6 (68>80)																				
0.8, 1.1, 1.3	F	10/68→1980	BDX 20347		598077	0		228x10 (9)	186226	186956										
R9 (81>88)																				
1.1, 1.4			 84200,170420	F	10/81→	BDX 21061		598081	2		238x12									
1.1, 1.2, 1.4, 1.6D, 1.7			 84201,170421	F	→12/88	LUC 20772		598002	2(B)		238x11,9 (10,5)	186230								
			 84201,170421	F	→12/88	BDX 21061		598081	2		238x11,9 (10,5)	186230								
1.4 Turbo, 1.7	F	09/84→12/88	LUC 20772		598002	2(B)		238x20 (17,7)	186229	186923										
	F	09/84→12/88	BDX 21061		598081	2		238x20 (17,7)	186229											
1.4 Turbo	R	07/86→09/88	BDX 20635		598396	0		238x8 (7)	186231											
R11 (82>89)																				
1.1, 1.2	F	07/82→07/89	LUC 20772		598084	2(A)		238x11,9 (10,5)	186230											
1.1, 1.2, 1.4, 1.4 GPL, 1.4i, 1.6D, 1.7 1.7 GPL, 1.7i	F	07/82→07/89	LUC 20772		598002	2(B)		238x11,9 (10,5)	186230	186921										
	F	07/82→07/89	BDX 21061		598081	2		238x11,9 (10,5)	186230	186919										
1.4 Turbo, 1.7, 1.7i	F	09/83→07/89	LUC 20772		598002	2(B)		238x20 (17,7)	186229	186923										
1.4 Turbo	R	07/86→07/89	BDX 20635		598396	0		238x8 (7)	186231											















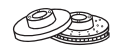





































																		
RENAULT  (.../...)																		
R12 (69>80)																		
1.3, 1.4, 1.6 		F	09/69→1980	BDX 20347 	598077	0		228x10 (9)	186226	186956								
		F	09/69→1980	LUC 20671 	598377	2		228x10 (9)	186226									
1.6 Gordini 		F	10/70→1974	BDX 20347 	598077	0		228x20										
		R	10/70→1974	BDX 20347 	598085	2		228x10 (9)	186226									
R14 (76>84)																		
1.2, 1.4		F	04/76→1984	BDX 20347 	598077	0		241x10 (9)	186142									
		F	04/76→1984	ATE 20913 	* 598375	2(A)		241x10 (9)	186142									
R15 (71>80)																		
1.3, 1.6		F	09/71→1980	BDX 20347 	598077	0		228x10 (9)	186226	186956								
1.6 TS		F	09/71→1976	BDX 20347 	598077	0		228x20										
R16 (65>80)																		
1.5		F	05/65→1970					254x12										
1.6		F	1968→1980	BDX 20347 	598077	0		254x12										
R17 (71>80)																		
1.6		F	09/75→1980	BDX 20347 	598077	0		228x10 (9)	186226	186956								
1.6 Gordini TS		F	07/71→1978	BDX 20347 	598077	0		228x20										
		R	07/71→1978	BDX 20347 	598085	2		228x10 (9)	186226									
R18 (77>86)																		
1.4, 1.6 		F	09/77→07/82	BDX 20347 	598077	0		228x10 (9)	186226	186956								
		F	09/77→07/82	LUC 20671 	598377	2		228x10 (9)	186226									
1.4 		F	07/82→1985	BDX 21061 	598081	2		228x10 (9)	186226									
1.6 		F	07/79→03/82	BDX 21061 	598081	2		228x10 (9)	186226									
2.1D 		F	07/80→1981	BDX 21061 	598081	2		238x12 (10,5)	186211									
		F	07/80→1981	LUC 20772 	598002	2(B)		238x12 (10,5)	186211									
1.6 		F	07/81→06/84	LUC 20772 	598002	2(B)		238x20										
		F	07/81→06/84	BDX 21061 	598081	2		238x20										













































										
RENAULT  (.../...)										
R18 (77>86) (.../...)										
2.1TD Turbo 	F	03/84→1986	BDX 21061 	598081	2		238x20 (17,7)	186213		
2.1TD Turbo, 2.2 Turbo 	F	07/83→06/86	LUC 20772 	598002	2(B)		238x20 (17,7)	186213		
1.6 Turbo, 1.6i Turbo 	F	07/82→1986	BDX 21061 	598081	2		259x19,6 (17,7)	186214		
	F	07/82→1986	LUC 20772 	598002	2(B)		259x19,6 (17,7)	186214		
	R	07/82→1986	BDX 20347 	598085	2		254x12 (10,5)	186225		
R19 (88>92)										
1.2, 1.4, 1.4 GPL, 1.4i, 1.7, 1.7i, 1.9D 1.9TD 	F	07/88→04/92	BDX 21061 	598081	2		238x11,9 (10,5)	186230	186919	
	F	07/88→04/92	LUC 20772 	598002	2(B)		238x11,9 (10,5)	186230	186921	
1.7, 1.7i, 1.9TD 	ABS(-)	F	07/88→04/92	LUC 20772 	598002	2(B)		238x20 (17,7)	186229	
1.7, 1.8, 1.8i 	ABS(+)	F	07/88→04/92	LUC 20772 	598002	2(B)		259x20,6 (17,7)	186208	186957
1.4i, 1.7, 1.7i, 1.8, 1.8i, 1.9D, 1.9TD 	R	07/88→06/91	BDX 20635 	598396	0		238x8 (7)	186768		
	R	06/91→04/92	BDX 20635 	598158	0		238x8 (7)	186768		
R19 (92>95)										
1.2, 1.2e, 1.4, 1.4e, 1.4i, 1.7i 1.9D 	ABS(-)	F	05/92→11/95	BDX 21061 	598081	2		238x11,9 (10,5)	186230	186919
		F	05/92→11/95	LUC 20772 	598002	2(B)		238x11,9 (10,5)	186230	186921
1.7, 1.7i, 1.8i, 1.9TD 		F	05/92→11/95	LUC 20772 	598002	2(B)		238x20 (17,7)	186229	186923
1.7i, 1.8i 		F	05/92→11/95	LUC 20772 	598002	2(B)		259x20,6 (17,7)	186208	186957
1.4e, 1.4i, 1.7, 1.7i, 1.8i, 1.9D, 1.9TD 	R	05/92→12/94	BDX 20635 	598158	0		238x8 (7)	186768		
	R	12/94→11/95	BDX 20635 	598396	0		238x8 (7)	186768		
R20 (75>84)										
1.6		 187000	F	12/75→	BDX 20347 	598077	0		228x20	
		 187001	F	→1984	BDX 21061 	598081	2		238x20	
2.0, 2.1			F	10/79→1984	BDX 21061 	598081	2		238x20	
2.0, 2.1, 2.1TD Turbo D			F	10/79→1984	LUC 20772 	598002	2(B)		238x20	









































																										
RENAULT  (.../...)																										
R20 (75>84) (.../...)																										
2.0, 2.2			F	07/77→1984	BDX 20488		598366	2		252,5x24 (22)	186218															
R21 (X48) (86>94)																										
1.4, 1.7			F	03/86→03/93	BDX 21061		598081	2		238x11,9 (10,5)	186230	186919														
			F	03/86→03/93	LUC 20772		598002	2(B)		238x11,9 (10,5)	186230	186921														
1.4, 1.7, 1.7i, 1.9D, 2.0			F	03/86→1994	LUC 20772		598002	2(B)		238x20 (17,7)	186229	186923														
1.4, 1.7, 1.7i			F	06/86→1994	BDX 21061		598081	2		238x20 (17,7)	186229	186954														
2.1D, 2.1TD			F	07/86→1994	BDX 21087		598082	2		244x20,5 (17,7)	186221															
2.0, 2.0i, 2.2, 2.2i			F	03/86→1994	BDX 21087		598082	2		265x20,5 (17,7)	186219	186958														
2.0, 2.0i			F	05/89→04/93	BDX 21087		598082	2		285x21																
2.0i Turbo			F	06/87→03/93	BDX 21087		598082	2		285x21 (19)	186220															
2.0, 2.0i, 2.1D, 2.1TD, 2.2, 2.2i			R	03/86→1994	BBO 20358		598055	0		255x10,5 (9,5)	186567															
			R	03/86→1994	BDX 20347		598085	2		255x10,5 (9,5)	186567															
2.0i Turbo			R	06/87→03/93	BBO 20358		598055	0		255x10,5 (9,5)	186596															
			R	06/87→03/93	BDX 20347		598085	2		255x10,5 (9,5)	186596															
2.0 Quadra, 2.0i Quadra			R	06/89→04/93	BBO 20358		598055	0		257x10,5																
			R	06/89→04/93	BDX 20347		598085	2		257x10,5																
2.0i Turbo Quadra			R	05/89→03/93	BBO 20358		598055	0		285x21																
			R	05/89→03/93	BDX 20347		598085	2		285x21																
R21 (X48) Nevada Savanna (86>95)																										
1.4, 1.7, 1.7i, 1.9D, 2.0			F	06/86→08/95	LUC 20772		598002	2(B)		238x20 (17,7)	186229	186923														
1.7, 1.9D			F	06/86→01/93	BDX 21061		598081	2		238x20 (17,7)	186229	186954														
2.1D			F	06/86→08/95	BDX 21087		598082	2		244x20,5 (17,7)	186221															
2.0, 2.1TD, 2.2			F	06/86→08/95	BDX 21087		598082	2		265x20,5 (17,7)	186219	186958														
			R	06/86→08/95	BBO 20358		598055	0		255x10,5 (9,5)	186567															
			R	06/86→08/95	BDX 20347		598085	2		255x10,5 (9,5)	186567															



















															
RENAULT  (.../...)															
R25 (83>92)															
2.0, 2.1D, 2.1TD, 2.2	F	09/83→1992	LUC 20772		598002	2(B)		259x19,6 (17,7)	186214						
2.2	ABS(+)	F 09/83→05/88	LUC 20772		598002	2(B)		280x22 (20)	186224						
2.5 V6 Turbo, 2.6 V6 Injection, 2.8 V6 2.8 V6 Injection	F	09/83→1992	LUC 20916		598061	2		280x22 (20)	186224						
2.0, 2.1D, 2.1TD, 2.2	ABS(+)	R 09/83→1992	BDX 20347		598085	2		254x12 (10,5)	186225						
2.2, 2.5 V6 Turbo 2.6 V6 Injection, 2.8 V6 2.8 V6 Injection	ABS(+)	R 09/83→1992	BDX 20347		598085	2		254x12 (10,5)	186223						
R30 (75>84)															
2.1TD Turbo D	F	10/81→1984	LUC 20772		598002	2(B)		238x20							
2.7	F	03/75→1984	BDX 20928		598086	0		252,5x24 (22)	186218						
	R	03/75→1984	BDX 20347		598085	2		254x12							
Alpine A310															
2.7		47708	F 07/76→	BDX 20347		598077	0								
		47709	F →1984	BDX 20631		598175	2								
		47708	R 07/76→	BDX 20347		598085	2								
		47709	R →1984	BDX 20631		598175	2								
Alpine A610															
3.0 Turbo	F	03/91→1993	BDX 21295		598294	4									
	R	03/91→1993	BDX 21295		598294	4		300x24							
Alpine GT D500															
2.5 V6 Turbo, 2.8 V6	F	09/84→08/85	LUC 20772		598002	2(B)		259x19,6 (17,7)	186214						
	F	09/84→1991	LUC 20772		598002	2(B)		259x21,6							
	R	09/84→1991	BDX 20635		598151	4		259x19,6 (17,7)	186214						
	R	09/84→1991	BDX 20635		598151	4		259x21,6							
Avantime (2001>2003)															
2.0i Turbo, 2.2dCi, 3.0i V6	F	09/01→03/03	LUC 23099		598669	0		305x28 (26)	197240						













































																	
RENAULT  (.../...)																	
Avantime (2001>2003) (.../...)																	
2.0i Turbo, 2.2dCi, 3.0i V6 (...)			R	09/01→03/03	LUC 20960		598180	0(D)		265x11							
Clio I (90>96)																	
1.1			F	06/90→05/92	BDX 20635		598080	2		238x8 (7)	186228	186918					
1.1, 1.2, 1.2i, 1.4, 1.4i, 1.9D, Electrique			F	06/90→02/96	BDX 21061		598081	2		238x11,9 (10,5)	186230	186919					
1.2, 1.2i, 1.4, 1.4i, 1.9D, Electrique			F	06/90→02/96	LUC 20772		598002	2(B)		238x11,9 (10,5)	186230	186921					
1.4, 1.4i, 1.7, 1.8i			F	06/90→02/96	LUC 20772		598002	2(B)		238x20 (17,7)	186229	186923					
			F	06/90→02/96	BDX 21061		598081	2		238x20 (17,7)	186229	186954					
1.8i, 2.0i			F	03/91→02/96	LUC 20772		598002	2(B)		259x20,6 (17,7)	186208	186957					
1.2i, 1.4i, 1.7, 1.8i, 1.9D, 2.0i			ABS(+)	R	06/90→02/96	BDX 20635		598396	0		238x8 (7)	186775					
			ABS(+)	R	09/90→02/96	BDX 20635		598158	0		238x8 (7)	186775					
Clio I (96>98)																	
1.2, 1.2i, 1.4, 1.4i, Electrique			F	03/96→02/98	LUC 20772		598002	2(B)		238x11,9 (10,5)	186230	186921					
			F	03/96→02/98	BDX 21061		598081	2		238x11,9 (10,5)	186230	186919					
1.4i, 1.8i, 1.9D			F	03/96→02/98	LUC 20772		598002	2(B)		238x20 (17,7)	186229	186923					
			F	03/96→02/98	BDX 21061		598081	2		238x20 (17,7)	186229	186954					
1.2i, 1.4i, 1.8i, 1.9D			ABS(+)	R	03/96→02/98	BDX 20635		598396	0		238x8 (7)	186775					
Clio II (98>2001)																	
1.2i, 1.2i GPL, 1.4i, 1.9D			ABS(-) AC(-)	F	03/98→03/01	LUC 20772		598002	2(B)		238x11,9 (10,5)	186230	186921				
1.2i, 1.2i GPL, 1.4i, 1.6i, 1.9D			AC(+)	F	03/98→03/01	LUC 20772		598002	2(B)		238x20 (17,7)	186229	186923				
1.4i, 1.6i, 1.9D, 1.9dTi			ABS(+)	F	03/98→03/01	LUC 20772		598002	2(B)		259x20,6 (17,7)	186208	186957				
2.0i				F	01/00→03/01	LUC 20916		598473	0		280x24 (21,8)	186655	●186975				
3.0i V6				F	01/00→03/01						310x28						
2.0i				R	01/00→03/01	BDX 20635		598396	0		238x8 (7)	186768					
3.0i V6				R	01/00→03/01	BDX 21295		598294	4		308x20						
Clio II (2001>)																	
1.2i, 1.2i GPL, 1.4i, 1.9D			ABS(-)	F	04/01→	LUC 20772		598002	2(B)		238x11,9 (10,5)	186230	186921				











































												
							WVA					
RENAULT  (.../...)												
Clio II (2001>) (.../...)												
1.0i, 1.2i, 1.2i GPL, 1.4i, 1.5dCi 1.6i, 1.9D	ABS(+)	F	04/01→	LUC 20772		598002	2(B)		238x20 (17,7)	186229	186923	
1.2i, 1.2i GPL, 1.4i, 1.5dCi, 1.6i, 1.6i GNV 1.9dTi		F	04/01→	LUC 20772		598002	2(B)		259x20,6 (17,7)	186208	186957	
2.0i		F	04/01→	LUC 20916		598473	0		280x24 (21,8)	186655	●186975	
3.0i V6		F	04/01→05/05						310x28			
1.6i, 1.6i GNV, 2.0i	ESP(+)	R	04/01→	BDX 20635		598396	0		238x8 (7)	186768		
3.0i V6		R	04/01→05/05	BDX 21295		598294	4		308x20			
Clio III (2005>)												
1.2i, 1.2i TCE, 1.4i, 1.5dCi, 1.6i 		F	09/05→	LUC 23973		598641	0		260x22 (19,8)	186764	●186980	
2.0i 16V 101KW 		F	09/06→	ATE 24535		●601012	0		280x24 (21,8)	186655		
2.0i 16V RS 145KW 		F	06/06→	BBO 24162		598861	0		312x26			
1.2i 1.2i TCE 1.4i 1.5dCi 1.6i 2.0i 16V 101KW 	ESP(+), Bearing Roulement (-)	R	09/05→	LUC 20960		598180	0(D)		240x8 (7)	186796		
	ESP(+), Bearing Roulement (+)	R	09/05→	LUC 20960		598180	0(D)		240x8 (7)	186897		
2.0i 16V RS 145KW 		R	06/06→04/07	LUC 20960		598180	0(D)		300x11			
		R	04/07→	LUC 20960		598474	0(D+C)		300x11			
Clio III (2009>)												
1.2Tce 100, 1.2i 65, 1.2i 75, 1.4i 1.5dCi 105, 1.5dCi 70, 1.5dCi 85, 1.6i 110 1.6i 128, 2.0i 140 		F	04/09→	LUC 23973		598641	0		260x22 (19,8)	186764	●186980	
2.0i 140 		F	04/09→	ATE 24535		●601012	0		280x24 (21,8)	186655		
2.0i 201 		F	04/09→	BBO 24162		598861	0		312x26			



















































															
RENAULT  (.../...)															
Clio III (2009>) (.../...)															
1.2TCe 100, 1.2i 65	Bearing Roulement (-)	R	04/09→	LUC 20960		598180	0(D)		240x8 (7)	186796					
1.2i 75, 1.4i															
1.5dCi 105															
1.5dCi 70															
1.5dCi 85, 1.6i 110															
1.6i 128															
2.0i 140  															
	Bearing Roulement (+)	R	04/09→	LUC 20960		598180	0(D)		240x8 (7)	186897					
2.0i 201 		R	04/09→	LUC 20960		598474	0(D+C)								
Clio Campus Evolution (2009>)															
1.2i, 1.5dCi 65, 1.5dCi 70, 1.5dCi 85		F	06/09→	LUC 20772		598002	2(B)		259x20,6 (17,7)	186208	186957				
Espace I (84>91)															
2.0  T000349,T000494,T012278,T022234		F	→01/91	LUC 20772		598084	2(A)		259x19,6 (17,7)	186214					
2.1TD															
2.2															
2.0  T000348,T000493,T012277,T022233		F	09/84→	LUC 20772		598084	2(A)		238x20 (17,7)	186213					
2.1TD															
2.0, 2.1TD, 2.2	Quadra (-)	R	09/84→01/91	BDX 20347		598085	2		254x12 (10,5)	186225					
2.0, 2.2	Quadra (+)	R	06/87→01/91	BDX 20347		598085	2		255x10,5 (9,5)	186567					
Espace II (91>96)															
2.0i, 2.1dT, 2.1dTv, 2.2i		F	01/91→08/96	LUC 20234		598382	1		259x19,6 (17,7)	186214					
2.8 V6		F	04/91→08/96	LUC 20916		598061	2		280x22 (20)	186224					
2.1dT Quadra, 2.2i Auto, 2.2i Quadra		R	01/91→08/96	BDX 20347		598085	2		257x10,5						
2.0i, 2.1dT, 2.1dTv, 2.2i		R	01/91→08/96	BDX 20347		598085	2		254x12 (10,5)	186225					
2.8 V6		R	04/91→08/96	BDX 20347		598085	2		254x12 (10,5)	186223					
Espace III (96>2000)															
1.9dTt, 2.0i, 2.2dT, 3.0i V6 (125KW)		F	09/96→06/00	LUC 20920		598470	2		280x24 (21,8)	186600					
3.0i V6 (143KW)		F	07/98→06/00	LUC 20920		598470	2		288x28						
2.0i, 3.0i V6 (125...143KW)		R	09/96→06/00	BBO 20358		598055	0		265x10,5						















































			R P F		WVA		Valeo		Valeo		Valeo	
RENAULT  (.../...)												
Espace III (2000>2002)												
1.9dTi, 2.0i	F	07/00→10/02	LUC 20920		598470	2		280x24 (21,8)	186600			
2.0i, 2.2dCi, 3.0i V6	F	07/00→10/02	LUC 23099		598545	0		305x28 (26)	197240			
	R	07/00→10/02	LUC 20960		598180	0(D)		265x10,5				
Espace IV (2002>2006)												
1.9dCi, 2.0i, 2.0i Turbo	F	09/02→02/06	ATE 23659		598471	0		308x28 (25,8)	197079			
1.9dCi, 2.0i, 2.0i Turbo, 2.2dCi, 3.0dCi 3.5i V6	F	09/02→02/06	ATE 23659		598471	0		324x28 (25,4)	186804			
	Bearing Roulement (+)	R	09/02→02/06	ATE 23482		598472	0		300x11 (9,5)	186893		
	Bearing Roulement (-)	R	09/02→02/06	ATE 23482		598472	0		300x11 (9,5)	186761		
Espace IV (2006>)												
2.0dCi, 2.0i, 2.0i Turbo	F	03/06→	ATE 23659		598471	0		308x28 (25,8)	197079			
2.0dCi, 2.2dCi, 3.0dCi V6, 3.5i V6	F	03/06→	ATE 23659		598471	0		324x28 (25,4)	186804			
2.0dCi, 2.0i 2.0i Turbo, 2.2dCi 3.0dCi V6, 3.5i V6	Bearing Roulement (+)	R	03/06→	ATE 23482		598472	0		300x11 (9,5)	186893		
	Bearing Roulement (-)	R	03/06→	ATE 23482		598472	0		300x11 (9,5)	186761		
Fluence (2009>)												
1.5dCi 110, 1.5dCi 85	F	11/09→	ATE 24914		601045	0		280x24 (21,8)	197192			
	ABS(+)	R	11/09→	LUC 20960		598474	0(D+C)					
Fuego (79>85)												
1.4, 1.6		F	09/79→	LUC 20772		598002	2(B)		238x12 (10,5)	186211		
		F	09/79→	BDX 21061		598081	2		238x12 (10,5)	186211		
		F	→1985	LUC 20772		598002	2(B)		238x12			
		F	→1985	BDX 21061		598081	2		238x12			
2.0, 2.2, 2.2 Turbo	F	09/84→1985	BDX 21061		598081	2		238x20 (17,7)	186213			
1.6 Turbo (eng A7L.23)	F	07/81→06/85	LUC 20772		598002	2(B)						

























































																							
RENAULT  (.../...)																							
Fuego (79>85) (.../...)																							
1.6 Turbo (eng A5L.750)		F	09/83→1985	LUC 20772		598002	2(B)		259x19,6 (17,7)	186214													
1.6i Turbo (eng A7L.752)																							
2.1TD		F	09/82→1984	LUC 20772		598002	2(B)		259x19,6 (17,7)	186214													
1.6 Turbo (eng A5L.750)		R	09/83→1985	BDX 20347		598085	2		254x12 (10,5)	186225													
1.6i Turbo (eng A7L.752)																							
Laguna I (B56) (94>98)																							
1.8i		⊗4	F	01/94→09/94	LUC 21574		598599	2		262x22 (19,8)	186304												
		⊗4	F	09/94→04/98	LUC 20916		598061	2		262x22 (19,8)	186304	186955											
2.0i (1998cc) 85KW		⊗4	F	01/94→04/98	LUC 20916		598061	2		262x22 (19,8)	186304	186955											
		⊗5	F	01/94→04/98	LUC 20916		598061	2		262x22 (19,8)	186305												
2.0i (1948cc) 103KW		⊗5	F	05/95→04/98	LUC 20916		598061	2		280x24 (21,8)	186600												
2.2D		⊗5	F	03/94→04/98	LUC 20916		598061	2		262x22 (19,8)	186304	186955											
2.2Dt		⊗5	F	03/96→04/98	LUC 20916		598061	2		280x24 (21,8)	186600												
3.0i V6		⊗5	F	01/94→04/98	LUC 20916		598061	2		280x24 (21,8)	186600												
1.8i, 2.0i (1998cc) 85KW, 2.2D		⊗4	R	01/94→04/98	BBO 20358		598055	0		265x10,5 (9,5)	186306												
2.0i (1948cc) 103KW		⊗5	R	05/95→01/97	BBO 20358		598055	0		265x10,5 (9,5)	186307												
2.0i (1998cc) 85KW, 2.2Dt		⊗5	R	02/97→04/98	BBO 21965		598328	0		265x10,5 (9,5)	186307												
3.0i V6		⊗5	R	01/94→01/97	BBO 20358		598055	0		265x10,5 (9,5)	186307												
		⊗5	R	02/97→04/98	BBO 21965		598328	0		265x10,5 (9,5)	186307												
Laguna I (B56) (98>2000)																							
1.6i, 1.8i, 1.9dCi		⊗4	F	05/98→12/00	LUC 20916		598473	0		280x24 (21,8)	186655	●186975											
1.6i, 1.8i, 1.8i GPL, 1.9dTi		⊗4	F	05/98→12/00	LUC 20916		598061	2		280x24 (21,8)	186655												
2.0i F3R																							
2.0i 16V F4R 1998 cc 103KW		⊗5	F	10/99→12/00	LUC 20916		598061	2		280x24 (21,8)	186600												
2.0i 16V N7Q 1948cc 103KW		⊗5	F	05/98→12/00	LUC 20916		598061	2		280x24 (21,8)	186600												
2.2dT		⊗5	F	05/98→05/99	LUC 20916		598061	2		280x24 (21,8)	186600												

















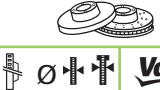







































			R P F		2.2		WVA		Valeo		Valeo		Valeo		
RENAULT  (.../...)															
Laguna I (98>2000) (.../...)															
2.2dT (...)	⊗4	F	05/99→12/00	LUC 20916		598061	2		280x24 (21,8)	186655					
3.0i V6	⊗5	F	05/98→05/99	LUC 20916		598061	2		280x24 (21,8)	186600					
	⊗4	F	05/99→12/00	LUC 20916		598473	0		280x24 (21,8)	186655	●186975				
2.0i 16V F4R 1998 cc 103KW 2.0i 16V N7Q 1948cc 103KW	⊗5	R	05/98→12/00	BBO 21965		598328	0		265x10,5 (9,5)	186307					
2.2dT	⊗5	R	05/98→05/99	BBO 21965		598328	0		265x10,5 (9,5)	186307					
	⊗4	R	05/99→12/00	BBO 21965		598328	0		265x10,5 (9,5)	186306					
3.0i V6	⊗5	R	05/98→05/99	BBO 21965		598328	0		265x10,5 (9,5)	186307					
	⊗4	R	05/99→12/00	BBO 21965		598328	0		265x10,5 (9,5)	186306					
Laguna I Nevada (K56) (95>98)															
1.8i, 2.0i F3R, 2.2D	⊗4	F	07/95→04/98	LUC 20916		598061	2		262x22 (19,8)	186304	186955				
2.0i 16V N7Q, 2.2dT, 3.0i V6	⊗5	F	07/95→04/98	LUC 20916		598061	2		280x24 (21,8)	186600					
1.8i, 2.0i F3R, 2.2D	⊗4	R	07/95→04/98	BBO 20358		598055	0		265x10,5 (9,5)	186306					
2.0i 16V N7Q, 2.2dT	⊗5	R	07/95→01/97	BBO 20358		598055	0		265x10,5 (9,5)	186307					
	⊗5	R	02/97→04/98	BBO 21965		598328	0		265x10,5 (9,5)	186307					
3.0i V6	⊗5	R	07/95→01/97	BBO 20358		598055	0		265x10,5 (9,5)	186307					
	⊗5	R	02/97→04/98	BBO 21965		598328	0		265x10,5 (9,5)	186307					
Laguna I Nevada (K56) (98>2000)															
1.6i, 1.8i, 1.9dCi	⊗4	F	05/98→12/00	LUC 20916		598473	0		280x24 (21,8)	186655	●186975				
1.6i, 1.8i, 1.8i GPL, 1.9dTi 2.0i F3R	⊗4	F	05/98→12/00	LUC 20916		598061	2		280x24 (21,8)	186655					
2.0i 16V F4R 1998 cc 103KW	⊗5	F	10/99→12/00	LUC 20916		598061	2		280x24 (21,8)	186600					
2.0i 16V N7Q 1948cc 103KW	⊗5	F	05/98→12/00	LUC 20916		598061	2		280x24 (21,8)	186600					
2.2dT	⊗5	F	05/98→05/99	LUC 20916		598061	2		280x24 (21,8)	186600					
	⊗4	F	05/99→12/00	LUC 20916		598061	2		280x24 (21,8)	186655					
3.0i V6	⊗5	F	05/98→05/99	LUC 20916		598061	2		280x24 (21,8)	186600					









































																		
RENAULT  (.../...)																		
Laguna I Nevada (98>2000) (.../...)																		
3.0i V6 (...)	⊗4	F	05/99→12/00	LUC 20916		598473	0		280x24 (21,8)	186655	●186975							
2.0i 16V F4R 1998 cc 103KW 2.0i 16V N7Q 1948cc 103KW	⊗5	R	05/98→12/00	BBO 21965		598328	0		265x10,5 (9,5)	186307								
1.9dCi	⊗4	R	05/99→12/00	BBO 21965		598328	0		265x10,5 (9,5)	186306								
2.2dT	⊗5	R	05/98→05/99	BBO 21965		598328	0		265x10,5 (9,5)	186307								
	⊗4	R	05/99→12/00	BBO 21965		598328	0		265x10,5 (9,5)	186306								
3.0i V6	⊗5	R	05/98→05/99	BBO 21965		598328	0		265x10,5 (9,5)	186307								
	⊗4	R	05/99→12/00	BBO 21965		598328	0		265x10,5 (9,5)	186306								
Laguna II (BGO) (2001>2005)																		
1.6i, 1.6i GPL, 1.8i, 1.9dCi	⊗ 15"	F	01/01→02/05	ATE 23659		598566	0		280x24 (21,8)	186715								
1.6i, 1.6i GPL, 1.8i, 1.9dCi 2.0i, 2.0ide, 2.2dCi	⊗ 16"	F	01/01→02/05	ATE 23659		598471	0		300x26 (22,8)	● 197221	●186978							
2.0i Turbo, 3.0i V6		F	01/01→02/05	ATE 23659		598471	0		308x28 (25,4)	186717								
1.6i, 1.6i GPL 1.8i, 1.9dCi, 2.0i 2.0i Turbo, 2.0ide 2.2dCi, 3.0i V6	Bearing Roulement (-)	R	01/01→02/05	ATE 24137		598783	0		274x11 (9,5)	186718								
	Bearing Roulement (+)	R	01/01→02/05	ATE 24137		598783	0		274x11 (9,5)	186896								
Laguna II (2005>2007)																		
1.6i, 1.6i GPL, 1.8i, 1.9dCi	⊗ 15"	F	03/05→09/07	ATE 23659		598566	0		280x24 (21,8)	186715								
1.8i, 1.9dCi, 2.0dCi, 2.0i, 2.0i Turbo 2.2dCi		F	03/05→09/07	ATE 23659		598471	0		300x26 (22,8)	● 197221	●186978							
2.0dCi, 2.0i Turbo, 3.0i V6		F	03/05→09/07	ATE 23659		598471	0		308x28 (25,4)	186717								
1.6i, 1.6i GPL 1.8i, 1.9dCi 2.0dCi, 2.0i 2.0i Turbo, 2.2dCi 3.0i V6	Bearing Roulement (-)	R	03/05→09/07	ATE 24137		598783	0		274x11 (9,5)	186718								
	Bearing Roulement (+)	R	03/05→09/07	ATE 24137		598783	0		274x11 (9,5)	186896								



















































									
RENAULT  (.../...)									
Laguna III (2007>)									
1.5dCi, 1.6i 	F	10/07→	ATE 24535 	● 601012	0		280x24 (21,8)	● 197192	
2.0dCi, 2.0i, 2.0i Turbo, 3.0dCi V6 3.5i V6 	F	10/07→					296x26		
1.5dCi, 1.6i, 2.0dCi, 2.0i, 2.0i Turbo 3.0dCi V6, 3.5i V6 	R	10/07→	ATE 24137 	598783	0		300x11		
Lutecia (Japan) (94>98)									
1.4i	F	03/96→02/98	BDX 21061 	598081	2		238x11,9 (10,5)	186230	186919
	F	03/96→02/98	LUC 20772 	598002	2(B)		238x11,9 (10,5)	186230	186921
1.8i	F	10/94→02/98	BDX 21061 	598081	2		238x20 (17,7)	186229	186954
	F	10/94→02/98	LUC 20772 	598002	2(B)		238x20 (17,7)	186229	186923
1.4i, 1.8i	R	10/94→02/98	BDX 20635 	598396	0		238x8 (7)	186775	
1.8i	R	10/94→02/96	BDX 20635 	598158	0		238x8 (7)	186775	
1.4i, 1.8i	R	10/94→02/98					238x8 (7)	186775	
Mégane (95>99)									
1.9D 	F	11/95→10/97	LUC 20772 	598002	2(B)		238x11,9 (10,5)	186230	186921
1.4i, 1.6i, 1.9D, 1.9dTi, 2.0i 	F	11/95→02/99	LUC 20772 	598002	2(B)		238x20 (17,7)	186229	186923
1.4i 16V, 1.6i, 1.9D, 1.9dTi, 1.9dTi 2.0i 	F	11/95→02/99	LUC 20772 	598002	2(B)		259x20,6 (17,7)	186208	186957
1.6i 16V, 2.0i 16V (F7R 714) 2.0i 16V 	F	02/97→02/99	LUC 20916 	598061	2		280x24 (21,8)	186655	
2.0i 16V (F7R 710) 	F	11/95→04/98	LUC 20916 	598061	2		262x22 (19,8)	186304	186955
2.0i 16V (F7R 710) (F7R 714) 2.0i 16V 	R	11/95→02/99	BDX 20635 	598396	0		238x8 (7)	186768	
Mégane (98>2003)									
1.4i 16V, 1.6i 16V 	F	02/99→09/02	LUC 20772 	598002	2(B)		280x24 (21,8)	186655	
1.4i 16V, 1.6i 16V, 1.8i 16V, 1.9dCi, 1.9dTi 2.0i 16V, 2.0i 16V 	F	02/99→02/03	LUC 20916 	598473	0		280x24 (21,8)	186655	●186975





































									
RENAULT  (.../...)									
Mégane (98>2003) (.../...)									
1.4i, 1.4i 16V, 1.6i, 1.6i 16V, 1.9d, 1.9dTi 2.0i 	F	01/99→02/03	LUC 20772 	598002	2(B)	 259x20,6 (17,7)	186208	186957	
1.6i 16V, 2.0i 16V 	F	02/99→08/01	LUC 20916 	598061	2	 280x24 (21,8)	186655		
1.4i 16V 1.6i 16V 1.8i 16V 1.9dCi 1.9dTi 	R	06/99→02/03	LUC 20960 	598180	0(D)	 274x10,9 (9,5)	186720		
	R	06/99→02/03	LUC 20960 	598180	0(D)	 274x11 (9,5)	186895		
1.4i 16V, 1.6i 16V, 1.8i 16V 1.9dCi, 1.9dTi, 2.0i 16V 2.0ide 16V 	R	02/99→02/03	BDX 20635 	598396	0	 238x8 (7)	186768		
Mégane Classic (96>99)									
1.4i, 1.6e, 1.9D	F	09/96→08/97	LUC 20772 	598002	2(B)	 238x11,9 (10,5)	186230	186921	
1.4i, 1.6e	F	09/96→09/98	LUC 20772 	598002	2(B)	 238x20 (17,7)	186229		
1.4i, 1.6e, 1.9D, 1.9dT, 1.9dTi, 2.0i	F	09/96→02/99	LUC 20772 	598002	2(B)	 259x20,6 (17,7)	186208	186957	
1.6i	F	06/98→02/99	LUC 20916 	598061	2	 280x24 (21,8)	186655		
1.6i, 1.9dTi	F	04/97→02/99	LUC 20772 	598002	2(B)	 280x24 (21,8)	186655		
Mégane Classic (99>2002)									
1.9D	F	03/99→03/01	LUC 20916 	598473	0	 259x20,6 (17,7)	186208	●186976	
1.4i, 1.4i 16V, 1.6i, 1.6i 16V, 2.0i	F	03/99→08/02	LUC 20772 	598002	2(B)	 259x20,6 (17,7)	186208	186957	
1.6i 16V, 1.8i 16V, 1.9dCi, 1.9dTi, 2.0i 16V	F	03/99→08/02	LUC 20916 	598473	0	 280x24 (21,8)	186655	●186975	
1.6i 16V, 1.9dCi, 1.9dTi	F	03/99→08/02	LUC 20772 	598002	2(B)	 280x24 (21,8)	186655		
1.9dTi, 2.0i 16V	F	03/99→10/01	LUC 20916 	598061	2	 280x24 (21,8)	186655		
2.0i 16V (LA1L)	R	01/01→10/01				 238x8 (7)	186768		
1.4i 16V, 1.6i 16V, 1.8i 16V, 1.9dCi, 1.9dTi 2.0i 16V (LA1D)	R	01/00→08/02	BDX 20635 	598396	0	 238x8 (7)	186768		

			 		  		  	
RENAULT  (.../...)								
Mégane II (2002>)								
1.4i (3/4/5 doors)		F	09/02→	BOS 23934 	598557	0	 260x22 (19,8)	186764
1.4i 	Turkey(+)	F	08/03→	LUC 29773 	598773	2		
1.5dCi (4 doors)	Proactive (-)	F	09/03→10/05	BOS 23930 	598558	0	 280x24 (21,8)	186655 ● 186969
	Proactive (-)	F	10/05→	ATE 24535 	● 601012	0	 280x24 (21,8)	186655
	Proactive (+)	F	09/03→10/05	BOS 23930 	598558	0	 280x24	
	Proactive (+)	F	10/05→	ATE 24535 	● 601012	0	 280x24	
1.5dCi (2/3/5 doors)		F	09/02→10/05	BOS 23930 	598558	0	 280x24 (21,8)	186655 ● 186969
		F	10/05→	ATE 24535 	● 601012	0	 280x24 (21,8)	186655
1.6i		F	09/02→10/05	BOS 23930 	598558	0	 280x24 (21,8)	186655 ● 186969
		F	10/05→	ATE 24535 	● 601012	0	 280x24 (21,8)	186655
1.9dCi		F	09/02→10/05	BOS 23930 	598558	0	 280x24 (21,8)	186655 ● 186969
		F	10/05→	ATE 24535 	● 601012	0	 280x24 (21,8)	186655
2.0dCi	Estate (-)	F	01/06→	ATE 24535 	● 601012	0	 280x24	
	Estate (+)	F	01/06→	ATE 24535 	● 601012	0	 280x24 (21,8)	186655
2.0i, 2.0i Turbo (100...121KW)		F	09/02→10/05	BOS 23930 	598558	0	 280x24 (21,8)	186655 ● 186969
		F	10/05→	ATE 24535 	● 601012	0	 280x24 (21,8)	186655
2.0i Turbo (170KW)		F	03/04→	BBO 24162 	598861	0	 312x26	
2.0i Turbo (170KW) CM2H		F	09/05→	BBO 24162 	598861	0	 312x28	
1.4i, 1.5dCi 1.9dCi, 2.0dCi 2.0i 	Bearing Roulement (-)	R	09/03→04/07	LUC 20960 	598180	O(D)	 270x10 (9)	186853
	Bearing Roulement (+)	R	09/03→04/07	LUC 20960 	598180	O(D)	 270x10 (9)	186898
	Bearing Roulement (-)	R	04/07→	LUC 20960 	598474	O(D+C)	 270x10 (9)	186853
	Bearing Roulement (+)	R	04/07→	LUC 20960 	598474	O(D+C)	 270x10 (9)	186898
1.6i K4M 812.813 	Bearing Roulement (-)	R	09/05→	LUC 20960 	598474	O(D+C)	 240x8 (7)	186796









































															
RENAULT  (.../...)															
Mégane II (2002>) (.../...)															
1.6i K4M 812.813 	Bearing Roulement (+)	R	09/05→	LUC 20960		598474	O(D+C)		240x8 (7)	186897					
1.6i K4M 760.761.764 	Bearing Roulement (-)	R	09/03→	LUC 20960		598180	O(D)		270x10 (9)	186853					
	Bearing Roulement (+)	R	09/03→	LUC 20960		598180	O(D)		270x10 (9)	186898					
1.6i K4M 856 	Bearing Roulement (-)	R	01/08→	LUC 20960		598474	O(D+C)		270x10 (9)	186853					
	Bearing Roulement (+)	R	01/08→	LUC 20960		598474	O(D+C)		270x10 (9)	186898					
1.4i, 1.5dCi, 1.6i 1.9dCi, 2.0i 2.0i Turbo (100...121KW) 	Bearing Roulement (-)	R	09/02→	LUC 20960		598474	O(D+C)		240x8 (7)	186796					
	Bearing Roulement (+)	R	09/02→	LUC 20960		598474	O(D+C)		240x8 (7)	186897					
2.0dCi 		R	01/06→	LUC 20960		598474	O(D+C)		270x10						
1.5dCi proactive 		R	09/03→	LUC 20960		598474	O(D+C)		270x10						
2.0i Turbo (170KW)		R	03/04→	ATE 23482		598472	0		300x11						
Mégane III (2008>)															
1.4TCe 130, 1.4i 130, 1.5dCi 105, 1.5dCi 110 1.5dCi 85, 1.5dCi 90, 1.6i 100, 1.6i 110 1.9dCi 130, 2.0i 140 		F	10/08→	ATE 24914		● 601045	0		280x24 (21,8)	● 197192					
2.0TCe 180, 2.0dCi 150, 2.0dCi 160 		F	10/08→	ATE 24710		● 601050	0		296x26						
2.0TCe 180 		F	12/08→	BBO 24162		598861	0								
1.4TCe 130, 1.4i 130, 1.5dCi 105, 1.5dCi 110 1.5dCi 85, 1.5dCi 90, 1.6i 100, 1.6i 110 1.9dCi 130, 2.0TCe 180, 2.0dCi 150 2.0dCi 160, 2.0i 140 		R	10/08→	24820		● 601000	0								
		R	10/08→	LUC 20960		598474	O(D+C)								
Mégane Scenic (96>99)															
1.4i, 1.6i		F	10/96→09/98	LUC 20772		598002	2(B)		259x20,6 (17,7)	186208	186957				
1.6i Auto		F	10/96→09/97	LUC 20772		598002	2(B)		262x22 (19,8)	186304					
1.9D, 1.9dTi, 1.9dTi, 2.0i		F	10/96→09/98	LUC 20916		598061	2		262x22 (19,8)	186304	186955				
1.4i		F	09/98→09/99	LUC 20916		598061	2		280x24 (21,8)	186655					

															
RENAULT  (.../...)															
Mégane Scenic (96>99) (.../...)															
1.4i 16V, 1.6i, 1.9D, 1.9dTi	F	05/98→09/99	LUC 20916		598473	0		280x24 (21,8)	186655	● 186975					
Mégane Scenic (99>2003)															
1.4i 16V, 1.6i 16V, 1.8i 16V, 1.9dCi 1.9dCi 4x4, 1.9dTi, 2.0i 16V	F	09/99→04/03	LUC 20916		598473	0		280x24 (21,8)	186655	● 186975					
1.9dCi 4x4, 2.0i 4x4 16V	F	09/99→04/03	LUC 20916		598473	0		280x24 (21,8)	186600						
	F	04/00→04/03	ATE 23659		598471	0		300x26 (22,8)	● 197081						
1.8i 4x4 16V, 1.9dCi 4x4, 2.0i 4x4 16V	F	09/99→04/03	ATE 23659		598471	0		280x24 (21,8)	186600						
1.4i 16V, 1.6i 16V 1.8i 16V, 1.9dCi 1.9dCi 4x4, 1.9dTi 2.0i 16V	Bearing Roulement (-)	R	09/99→04/03	LUC 20960		598180	O(D)		274x10,9 (9,5)	186720					
	Bearing Roulement (+)	R	09/99→04/03	LUC 20960		598180	O(D)		274x11 (9,5)	186895					
1.8i 4x4 16V, 1.9dCi 4x4, 2.0i 4x4 16V	R	09/99→04/03	LUC 20960		598180	O(D)		265x10,5							
Modus (2004>2008)															
1.2i, 1.2i TCE, 1.4i, 1.5dCi, 1.5dCi 105 FAP 1.6i	F	09/04→12/07	LUC 23973		598641	0		260x22 (19,8)	186764	● 186980					
ESP(+), Bearing Roulement (-)	R	09/04→12/07	LUC 20960		598180	O(D)		240x8 (7)	186796						
	R	09/04→12/07	LUC 20960		598180	O(D)		240x8 (7)	186897						
Modus (2008>)															
1.2i, 1.5dCi, 1.6i	F	01/08→	LUC 23973		598641	0		260x22 (19,8)	186764	● 186980					
ESP(+), Bearing Roulement (-)	R	01/08→	LUC 20960		598180	O(D)		240x8 (7)	186796						
	R	01/08→	LUC 20960		598180	O(D)		240x8 (7)	186897						
Rodeo (70>86)															
1.1	F	1972→1981							228x10 (9)	186226					
	F	1982→1986	BDX 20347		598077	0									
Safrane (92>96)															
2.0Si, 2.0i, 2.1Dt, 2.2Si, 2.2i	F	05/92→09/96	LUC 20916		598061	2		262x22 (19,8)	186304						
2.0Si, 2.0i, 2.2Si, 2.2i, 2.5Dt	F	04/93→09/96	LUC 20916		598061	2		262x22 (19,8)	186305						











































																		
RENAULT  (.../...)																		
Safrane (92>96) (.../...)																		
2.5Dt, 3.0i V6, 3.0i V6i	F	05/92→09/96	LUC 20916		598061	2		280x24 (21,8)	186600									
3.0i V6i Biturbo	F	12/93→09/96	LUC 20916		598061	2												
2.0Si, 2.0i, 2.1Dt, 2.2Si, 2.2i	ABS(+)	R	05/92→09/96	BBO 20358		598055	0		265x10,5 (9,5)	186306								
2.0Si, 2.0i, 2.2Si, 2.2i, 2.5Dt 3.0i V6	ABS(+)	R	05/92→09/96	BBO 20358		598055	0		265x10,5 (9,5)	186307								
3.0i V6i, 3.0i V6i Biturbo	4WD	R	05/92→09/96	BDX 20635		598396	0		265x10,5									
Safrane (96>2000)																		
2.0i	F	09/96→01/98	LUC 20916		598061	2		262x22 (19,8)	186305									
	F	01/98→03/99	LUC 20916		598061	2		280x24 (21,8)	186600									
	F	03/99→11/00	LUC 20916		598473	0		280x24 (21,8)	186600									
2.2TD, 2.5i, 3.0i	F	09/96→03/99	LUC 20916		598061	2		280x24 (21,8)	186600									
	F	03/99→11/00	LUC 20916		598473	0		280x24 (21,8)	186600									
2.0i, 2.2TD, 2.5i, 3.0i	R	09/96→11/00	BBO 20358		598055	0		265x10,5 (9,5)	186307									
Scenic II (2003>)																		
1.4i, 1.5dCi, 1.6i, 1.6i GPL, 1.9dCi, 2.0i 2.0i Turbo	F	05/03→10/05	BOS 23930		598558	0		280x24 (21,8)	186655	●186969								
	F	10/05→	ATE 23245		● 598993	0		280x24 (21,8)	186655									
1.5dCi, 1.9dCi, 2.0i, 2.0i Turbo	F	05/03→10/05	BOS 23930		598558	0		300x24 (21,8)	● 197241									
	F	10/05→	ATE 23245		● 598993	0		300x24 (21,8)	● 197241									
1.4i K4J 740, 1.6i K4M 812	F	10/05→	ATE 24535		● 601012	0		280x24 (21,8)	186655									
2.0dCi	F	01/06→	ATE 23245		● 598993	0		300x24 (22)	● 197215									
1.4i, 1.5dCi, 1.6i 1.6i GPL, 1.9dCi 2.0i, 2.0i Turbo	Bearing Roulement (-)	R	05/03→04/07	LUC 20960		598180	O(D)		270x10 (9)	186853								
	Bearing Roulement (+)	R	05/03→04/07	LUC 20960		598180	O(D)		270x10 (9)	186898								
	Bearing Roulement (-)	R	04/07→	LUC 20960		598474	O(D+C)		270x10 (9)	186853								
	Bearing Roulement (+)	R	04/07→	LUC 20960		598474	O(D+C)		270x10 (9)	186898								

			R P F		WVA		Valeo		Valeo		Valeo	
RENAULT  (.../...)												
Grand Scenic II (2003>)												
1.5dCi, 1.6i, 1.9dCi, 2.0i, 2.0i Turbo	F	03/04→10/05	BOS 23930		598558	0		300x24 (21,8)	●	197241		
	F	10/05→	ATE 23245		● 598993	0		300x24 (21,8)	●	197241		
2.0dCi	F	01/06→	ATE 23245		● 598993	0		300x24 (22)	●	197215		
1.5dCi, 1.6i 1.9dCi, 2.0i 2.0i Turbo	Bearing Roulement (-)	R	03/04→04/07	LUC 20960		598180	O(D)		274x10,9 (9,5)	186720		
	Bearing Roulement (+)	R	03/04→04/07	LUC 20960		598180	O(D)		274x11 (9,5)	197000		
	Bearing Roulement (-)	R	04/07→	LUC 20960		598474	O(D+C)		274x10,9 (9,5)	186720		
	Bearing Roulement (+)	R	04/07→	LUC 20960		598474	O(D+C)		274x11 (9,5)	197000		
2.0dCi	Bearing Roulement (-)	R	01/06→04/07	LUC 20960		598180	O(D)		274x11 (9,5)	186718		
	Bearing Roulement (+)	R	01/06→04/07	LUC 20960		598180	O(D)		274x11 (9,5)	186896		
	Bearing Roulement (-)	R	04/07→	LUC 20960		598474	O(D+C)		274x11 (9,5)	186718		
	Bearing Roulement (+)	R	04/07→	LUC 20960		598474	O(D+C)		274x11 (9,5)	186896		
Scenic III (2009>)												
1.5dCi 105, 1.5dCi 110, 1.5dCi 85 1.6i 110	⊙ 15"	F	04/09→	ATE 24914		● 601045	0		280x24 (21,8)	●	197192	
1.4TCE 130, 1.5dCi 105 1.5dCi 110, 1.5dCi 85, 1.6i 110 1.9dCi 130, 2.0dCi 150 2.0dCi 160, 2.0i 140	⊙ 16"	F	04/09→	ATE 24710		● 601050	0		296x26			
	Handbrake electric	R	04/09→	24820		● 601000	0					
	Handbrake mechanic	R	04/09→	LUC 20960		598474	O(D+C)					
Spider (96>99)												
2.0i	F	01/96→10/99	LUC 20916		598061	2		300x24				
	R	01/96→10/99	BDX 21295		598294	4		300x24				
Thalia (2001>)												
1.4i	F	01/01→	LUC 20772		598002	2(B)		238x11,9 (10,5)		186230	186921	
1.4i 16V, 1.5dCi	ABS(-)	F	01/01→	LUC 20772		598002	2(B)		238x20 (17,7)	186229	186923	



																		
RENAULT  (.../...)																		
Thalia (2001>) (.../...)																		
1.5dCi, 1.6i 16V	ABS(+)	F	01/01→	LUC 20772		598002	2(B)		259x20,6 (17,7)	186208	186957							
Twingo I (X65) (93>98)																		
1.2, 1.2i		F	03/93→08/98	BDX 20635		598080	2		238x8 (7)	186228	186918							
1.2i Auto		F	07/96→08/98	LUC 20772		598002	2(B)		238x11,9 (10,5)	186230	186921							
Twingo II (X65) (98>2007)																		
1.2i, 1.2i GPL	SAR(+)	F	09/98→08/04	LUC 20772		598002	2(B)		238x11,9 (10,5)	186230	186921							
	SAR(-)	F	09/98→08/04	LUC 20772		598002	2(B)		259x20,6 (17,7)	186208	186957							
Twingo III (2007>)																		
1.2i, 1.5dCi 47KW		F	07/07→	LUC 20772		598002	2(B)		259x12 (10,6)	186802								
1.2i 16V, 1.2i TCE 16V, 1.5dCi 63KW		F	07/07→	LUC 20772		598002	2(B)		259x20,6 (17,7)	186208	186957							
1.6i 16V		F	06/08→	ATE 24535		● 601012	0		280x24 (21,8)	186655								
	Bearing Roulement (-)	R	06/08→	LUC 20960		598474	O(D+C)		240x8 (7)	186796								
	Bearing Roulement (+)	R	06/08→	LUC 20960		598474	O(D+C)		240x8 (7)	186897								
Vel Satis (2002>2005)																		
2.0i Turbo, 2.2dCi, 3.0dCi V6, 3.5i V6		F	01/02→01/05	ATE 23659		598471	0		324x28 (25,4)	186804								
	Bearing Roulement (+)	R	01/02→09/02	ATE 23482		598472	0		300x11 (9,5)	● 197003								
	Bearing Roulement (+)	R	01/02→09/02	ATE 23482		598472	0		300x11 (9,5)	● 186894								
	Bearing Roulement (+)	R	09/02→01/05	ATE 23482		598472	0		300x11 (9,5)	● 186893								
	Bearing Roulement (-)	R	09/02→01/05	ATE 23482		598472	0		300x11 (9,5)	186761								
Vel Satis (2005>)																		
2.0dCi FAP, 2.0i Turbo, 2.2dCi, 3.0dCi V6 3.5i V6		F	02/05→	ATE 23659		598471	0		324x28 (25,4)	186804								
	Bearing Roulement (+)	R	02/05→	ATE 23482		598472	0		300x11 (9,5)	● 186893								
	Bearing Roulement (-)	R	02/05→	ATE 23482		598472	0		300x11 (9,5)	186761								
Wind (2010>)																		
1.2TCE 100, 1.6i 133		F	07/10→	ATE 24535		● 601012	0		280x24 (21,8)	186655								
	Bearing Roulement (-)	R	07/10→	LUC 20960		598474	O(D+C)		240x8 (7)	186796								



















































			R P F		WVA			Valeo		Valeo		Valeo	
RENAULT  (.../...)													
Wind (2010>) (.../...)													
1.2TCE 100, 1.6i 133 (...)	Bearing Roulement (+)	R	07/10→	LUC 20960		598474	0(D+C)		240x8 (7)	186897			
RENAULT 													
Express (85>91)													
1.0, 1.1, 1.6D		F	09/85→05/88	BDX 20635		598080	2		238x8 (7)	186228	186918		
1.0, 1.1, 1.4, 1.4i, 1.6D		F	09/85→08/91	BDX 21061		598081	2		238x8 (7)	186228			
		F	09/85→08/91	LUC 20772		598002	2(B)		238x8 (7)	186228			
1.0, 1.1, 1.6D		F	09/85→05/88	BDX 20635		598080	2		238x11,9 (10,5)	186230			
1.0, 1.1, 1.4, 1.4i, 1.6D		F	09/85→08/91	BDX 21061		598081	2		238x11,9 (10,5)	186230	186919		
		F	09/85→08/91	LUC 20772		598002	2(B)		238x11,9 (10,5)	186230	186921		
Express (91>2003)													
1.1, 1.2, 1.2i, 1.4, 1.4i, 1.6D, 1.9D		F	09/91→08/97	LUC 20772		598002	2(B)		238x11,9 (10,5)	186230	186921		
		F	09/91→02/03	BDX 21061		598081	2		238x11,9 (10,5)	186230	186919		
Electrique		F	10/93→10/98						238x11,9 (10,5)	186230			
Extra (85>91)													
1.0, 1.1, 1.6D		F	09/85→08/91	BDX 20635		598080	2		238x8 (7)	186228	186918		
		F	09/85→08/91	BDX 21061		598081	2		238x8 (7)	186228			
1.1, 1.4, 1.6D		F	09/85→08/91	BDX 20635		598080	2		238x11,9 (10,5)	186230			
		F	09/85→08/91	BDX 21061		598081	2		238x11,9 (10,5)	186230	186919		
Extra (91>97)													
1.2, 1.2i, 1.4, 1.4i, 1.6D, 1.9D		F	09/91→08/97	LUC 20772		598002	2(B)		238x11,9 (10,5)	186230	186921		
		F	09/91→08/97	BDX 21061		598081	2		238x11,9 (10,5)	186230	186919		
Kangoo (97>2003)													
1.2i, 1.4i, 1.6i, 1.9D, 1.9DTi	ABS(-)	F	09/97→02/03	BOS 21980		598726	1		238x20 (17,7)	186229	●186982		
	ABS(+)	F	03/98→02/03	BOS 21980		598726	1		259x20,6 (17,7)	186208	●186977		
1.6i, 1.9dCi	4WD(+)	F	01/02→02/03	BOS 23930		598558	0		280x24 (21,8)	186655	●186969		
	4WD(+)	R	01/02→02/03	BOS 23557		598527	0		280,5x12 (11)	186786			











































				WVA	Valeo	Valeo	Valeo	Valeo	Valeo
RENAULT (.../...)									
Kangoo (2003>)									
1.2i, 1.2i GPL, 1.4i, 1.5dCi, 1.6i, 1.6i GNV 1.9D, 1.9dCi, 1.9dTi	F	03/03→	BOS 21980	598726	1	259x20,6 (17,7)	186208	●186977	
1.5dCi, 1.9D Elect road (Long Version)	GV(+)	F	03/03→	BOS 21980	598726	1	238x20 (17,7)	186229	●186982
1.6i, 1.9dCi	F	03/03→	BOS 23930	598558	0	280x24 (21,8)	186655	●186969	
	R	03/03→	BOS 23557	598527	0	280,5x12 (11)	186786		
Kangoo (2007>)									
1.5dCi, 1.6i, 1.6i 105	F	11/07→	LUC 23973	598641	0				
1.5dCi, 1.6i, 1.6i Ethanol	F	11/07→	24693	● 601010	0				
1.5dCi, 1.6i, 1.6i 105, 1.6i Ethanol	R	11/07→	24692	● 601011	0	275x11			
Master (80>89)									
2.0, 2.1D, 2.4D	F	08/80→02/89	LUC 20380	598374	1	278,5x24 (22)	186210		
Master (89>94)									
2.0, 2.1D, 2.5D, 2.5TD	F	03/89→09/94	LUC 20380	598374	1	278,5x24 (22)	186210		
Master (94>97)									
2.2i, 2.5D, 2.5TD, Electrique	F	10/94→09/97	LUC 20380	598374	1	278,5x24 (22)	186210		
Master (97>2003)									
2.5D, 2.8dTi	F	09/97→09/03	BDX 23302	598490	0	280x24 (21)	186688		
1.9dCi, 1.9dTi, 2.2dCi, 2.5D, 2.5dCi, 2.8dTi	F	01/98→09/03	BOS 23613	598537	0	306x28 (25)	186868		
	R	01/98→09/03	BOS 23669	598538	0	305x12 (10,5)	186740		
Master (2003>2006)									
1.9dCi, 2.2dCi, 2.5dCi, 2.5dCi 100 2.5dCi 114, 3.0dCi	F	10/03→05/06	BOS 23613	598537	0	306x28 (25)	186868		
	R	10/03→05/06	BOS 23669	598538	0	305x12 (10,5)	186740		
Master (2006>)									
2.5dCi 100, 2.5dCi 120, 2.5dCi 146 2.5dCi 150	F	06/06→	BOS 23613	598537	0	306x28 (25)	186868		
	R	06/06→	BOS 23669	598538	0	305x12 (10,5)	186740		



















																				
RENAULT  (.../...)																				
Master (2010>)																				
2.3dCi	F	04/10→										302x28								
2.3dCi traction	R	04/10→										305x12								
2.3dCi propulsion	R	04/10→										305x12								
2.3dCi (double Wheel) propulsion	R	04/10→										305x18								
Master Propulsion I (99>2004)																				
2.8dCi 110, 2.8dCi 130, 2.8dCi 150	F	07/99→06/04	BBO 29121		541683	2														
	R	07/99→06/04	BBO 29121		541683	2		290x22 (19)	● 187061											
Master Propulsion II (2004>)																				
3.0dCi 120, 3.0dCi 160	F	05/04→	BBO 29121		541683	2														
	R	05/04→	BBO 29121		541683	2		290x22 (19)	● 187061											
Rapid (85>91)																				
1.0, 1.1, 1.6D	F	09/85→08/91	BDX 20635		598080	2		238x8 (7)	186228											
	F	09/85→08/91	BDX 21061		598081	2		238x8 (7)	186228											
1.1, 1.4, 1.4i, 1.6D	F	09/85→08/91	BDX 20635		598080	2		238x11,9 (10,5)	186230											
	F	09/85→08/91	BDX 21061		598081	2		238x11,9 (10,5)	186230											
Rapid (91>98)																				
1.4i, 1.9D	F	09/91→03/98	LUC 20772		598002	2(B)		238x11,9 (10,5)	186230	186921										
	F	09/91→03/98	BDX 21061		598081	2		238x11,9 (10,5)	186230	186919										
Trafic (80>89)																				
1.4, 1.4 GPL, 1.6, 1.7, 2.1D			 5150	F	07/80→	BDX 20488		598366	2		252,5x24 (22)	186218								
1.4, 1.6, 1.6 GPL, 1.7, 2.0 2.1D, 2.5D			 5151	F	→02/89	BDX 20928		598086	0		252,5x24 (22)	186218								
Trafic (89>94)																				
1.4, 1.7, 2.1D	F	03/89→09/94		BDX 20488		598366	2		252,5x24 (22)	186218										
1.7, 2.0, 2.1D, 2.2, 2.5D	F	03/89→09/94		BDX 20928		598086	0		252,5x24 (22)	186218										
Trafic (94>97)																				
2.1D, 2.2i, 2.5D	F	10/94→08/97		BDX 20928		598086	0		252,5x24 (22)	186218										

















































										
RENAULT  (.../...)										
Trafic (97>2001)										
1.9D, 2.5D	F	09/97→03/01	BDX 20928 	598086	0		252,5x24 (22)	186218		
Trafic II (2001>2006)										
1.9dCi, 2.0i, 2.5dCi	F	04/01→07/06	LUC 23099 	598545	0		305,5x28 (24)	186712	● 186987	
Bearing Roulement (-)	R	04/01→07/06	LUC 21748 	598546	0(A)		280x12 (10)	186713		
Bearing Roulement (+)	R	04/01→07/06	LUC 21748 	598546	0(A)		280x12 (10)	● 197001		
Trafic II (2006>)										
2.0dCi, 2.0i, 2.5dCi	F	07/06→	LUC 23099 	598545	0		305,5x28 (24)	186712	● 186987	
Bearing Roulement (-)	R	07/06→	LUC 21748 	598546	0(A)		280x12 (10)	186713		
Bearing Roulement (+)	R	07/06→	LUC 21748 	598546	0(A)		280x12 (10)	● 197001		
ROVER 										
25 (99>2005)										
1.1i, 1.4i, 1.6i, 1.8i, 2.0D	F	12/99→04/05	LUC 21515 	598022	2		262x12 (11)	186620		
1.8i, 2.0Di	F	12/99→04/05	LUC 21515 	598022	2		262x21 (19)	186438		
	R	12/99→04/05	AKE 21312 	598053	2		238,5x10 (8)	186435		
45 (2000>2005)										
1.4i, 1.6i, 2.0D, 2.0iDT	F	01/00→04/05	LUC 21515 	598022	2		262x12 (11)	186620		
1.6i, 1.8i, 2.0Di, 2.0i V6	F	01/00→04/05	LUC 21515 	598022	2		262x21 (19)	186438		
1.6i, 1.8i, 2.0i V6	R	01/00→04/04	AKE 21312 	598053	2		238,5x10 (8)	186435		
1.8i, 2.0Di, 2.0i V6	R	12/02→04/05	AKE 21312 	598053	2		260x10			
75 (99>2005)										
1.8T, 1.8i, 2.0CDT, 2.0CDTi, 2.0i V6 2.5i V6 	F	02/99→04/05	ATE 23114 	598632	0		284x22 (19)	186814		
2.5i V6 	F	08/01→06/04	ATE 23114 	598632	0					
1.8T, 1.8i, 2.0CDT, 2.0CDTi, 2.0i V6 2.5i V6 	R	02/99→04/05	ATE 21934 	598753	0		280x9,8 (8)	● 197016		
2.5i V6 	R	08/01→06/04					280x10			
1.8T, 1.8i, 2.0CDT, 2.0CDTi, 2.0i V6, 2.5i V6	P	02/99→		564028						





























			R P F		WVA		Valeo		Valeo		Valeo	
ROVER (.../...)												
100 (90>98)												
1.1, 1.1i, 1.4, 1.4D, 1.4i, 1.5D	F	09/90→12/98	LUC 21518		598254	0		240x12,7 (11,7)	186236			
1.4i 16V 76KW	F	06/91→12/98	LUC 21518		598254	0		240x22 (20,5) *	186613			
200 (84>90)												
1.3, 1.6, 1.6i 	F	06/84→09/90	SUM 20895		598131	2		231x12 (10) *	186232			
1.6i 	F	09/85→09/90	SUM 20895		598131	2		231x17				
200 (89>96)												
1.4, 1.4i 	F	10/89→03/96	LUC 21520		598019	2		238x12,7 (10,7)	186285			
ABS(+)	F	10/89→03/96	LUC 21515		598022	2		238x12,7 (10,7)	186285			
1.4, 1.4i, 1.8D 	ABS(+)	F	10/89→03/96	LUC 21520		2		262x21 (19)	186286			
1.4, 1.4i, 1.6i, 1.8D 1.8TD Turbo 	ABS(+)	F	10/89→03/96	LUC 21515		2		262x21 (19)	186286			
2.0i, 2.0i Turbo 	F	06/91→03/96	LUC 21515		598022	2		262x21 (19)	186286			
1.4, 1.4i, 1.6i, 1.8D, 1.8TD Turbo 2.0i, 2.0i Turbo 	ABS(+)	R	10/89→03/96	AKE 21312		2		238,5x10 (8)	186435			
200 (95>99)												
1.1i, 1.4i, 1.6i, 2.0TD	ABS(-)	F	11/95→11/99	LUC 21515		2		262x12 (11)	186620			
1.4i, 1.6i, 1.8i, 2.0TD	ABS(+)	F	11/95→11/99	LUC 21515		2		262x21 (19)	186438			
	R	11/95→11/99	AKE 21312		598053	2		238,5x10 (8)	186435			
200 Coupé/Cabriolet (96>99)												
1.6i	F	03/96→1999	LUC 21515		598022	2		262x12 (11)	186620			
1.6i, 1.8i WC	ABS(+)	F	03/96→1999	LUC 21515		2		262x21 (19)	186438			
	ABS(+)	R	03/96→1999	AKE 21312		2		238,5x10 (8)	186435			
400 (90>95)												
1.4i, 1.6i, 1.7TD 	F	03/90→04/95	LUC 21520		598019	2		238x12,7 (10,7)	186285			
	ABS(+)	F	03/90→04/95	LUC 21515		2		238x12,7 (10,7)	186285			
	ABS(+)	F	03/90→04/95	LUC 21520		2		262x21 (19)	186286			





































															
ROVER  (.../...)															
400 (90>95) (.../...)															
1.4i, 1.6i, 1.7TD, 1.9D, 2.0i		ABS(+)	F	03/90-04/95	LUC 21515 	598022	2		262x21 (19)	186286					
2.0i Turbo  		ABS(+)	R	03/90-04/95	AKE 21312 	598053	2		238,5x10 (8)	186435					
400 (95>2000)															
1.4i, 2.0TD  			F	05/95-03/00	LUC 21515 	598022	2		262x12 (11)	186620					
1.4i, 1.6i, 1.8i, 2.0TD, 2.0i  		ABS(+)	F	05/95-03/00	LUC 21515 	598022	2		262x21 (19)	186438					
		ABS(+)	R	05/95-03/00	AKE 21312 	598053	2		238,5x10 (8)	186435					
2.0i 			R	06/96-03/00	LUC 21084 	598118	2		238,5x10 (8)	186435					
600 (93>2000)															
1.8i 16V, 2.0Di, 2.0SDi, 2.0i			F	04/93-06/00	AKE 21880 	598056	2		282x23 (21)	186439					
1.8i Auto 16V, 2.0i Auto, 2.0i Turbo 16V 2.3i 16V, 2.3i Auto 16V			F	04/93-06/00	AKE 21651 	598627	0		282x23 (21)	186439					
1.8i 16V, 1.8i Auto 16V, 2.0Di, 2.0SDi, 2.0i 2.0i Auto, 2.0i Turbo 16V, 2.3i 16V 2.3i Auto 16V			R	04/93-06/00	AKE 21719 	598682	2		260x10						
800 (86>91)															
2.0, 2.0i, 2.5TD			F	09/86-09/91	LUC 21245 	598227	1		262x21 (19)	186234					
2.0i Turbo, 2.7i V6			F	09/87-09/91					285x21 (19)	* 186235					
2.5i V6			F	09/86-02/88	LUC 21245 	598227	1		285x21 (19)	* 186235					
2.0, 2.0i, 2.0i Turbo, 2.5TD, 2.5i V6 2.7i V6			R	09/86-09/91					260x10						
800 (91>99)															
2.0i Turbo, 2.7i V6  		 152056	F	10/91→	LUC 21515 	598022	2		285x21 (19)	* 186235					
2.0i, 2.0i Turbo, 2.5TD 2.5i V6, 2.7i V6  		 152057	F	→10/99	LUC 21515 	598022	2		262x21 (19)	186234					
2.0i 			R	10/91-12/95											
2.0i, 2.0i Turbo, 2.5TD, 2.5i V6 2.7i V6  			R	10/91-10/99	LUC 21682 	● 598903	2		260x10						

























































																										
ROVER  (.../...)																										
Acclaim (81>84)																										
1.3		F	10/81→06/84	SUM 20731		598185	0																			
Maestro (83>95)																										
1.3, 1.6, 2.0, 2.0i Turbo		F	03/83→10/94	LUC 21084		598118	2		240x12,7 (11,7)		186236															
1.3, 1.6, 2.0D		F	10/84→01/95	LUC 21084		598118	2		240x12,8																	
2.0D, 2.0TD, 2.0i		F	10/84→01/95	LUC 21084		598118	2		240x22 (20,5)		* 186613															
Metro (80>90)																										
1		F	10/80→09/84	ATE 20761		* 598117	2		213x9,5																	
1, 1.3, 1.3 Turbo		F	10/80→09/84	AP 20754		598116	2		213x9,5																	
1		F	10/84→04/90	ATE 20761		* 598117	2		213x20,6																	
1, 1.3		F	10/84→04/90	AP 20754		598116	2		213x20,6																	
Metro UK (90>95)																										
1.1, 1.1i, 1.4, 1.4D, 1.4i		F	05/90→01/95	LUC 21518		598254	0		240x12,7 (11,7)		186236															
1.4i		F	05/90→01/95	LUC 21518		598254	0		240x22 (20,5)		* 186613															
Mini (59>80)																										
1, 1.2		F	1970→09/80	AP 20038		598392	0																			
Mini (80>90)																										
0.8, 1, 1.1		F	10/80→08/90	AP 20038		598392	0		213x9,4 (8,6)		186495															
Mini (90>99)																										
1.3, 1.3i		F	09/90→1999	AP 20038		598392	0		213x9,4 (8,6)		186495															
Montego (84>94)																										
1.3, 1.6		F	05/84→12/94	LUC 21084		598118	2		240x12,7 (11,7)		186236															
2TD		F	10/88→12/94	LUC 21084		598118	2		240x12,7 (11,7)		186236															
2, 2 Turbo, 2i		F	05/84→12/94	LUC 21084		598118	2		240x22 (20,5)		* 186613															
SD1 (76>87)																										
2.0, 2.3, 2.4TD, 2.6, 3.5 V8	 317483	F	06/76→	AP 20894		* 598391	2																			
	 317484	F	→01/87																							































































															
ROVER  (.../...)															
Spitfire (70>80)															
1.3, 1.5	F	11/70→08/80	ATE 20088		598338	0									
Streetwise (2000>2005)															
1.4i, 1.6i, 1.8i, 2.0D	F	08/03→04/05	LUC 21515		598022	2		262x12	(11)	186620					
TR7 (74>81)															
2.0	F	09/74→05/81	AP 20038		598392	0									
RVI 															
Mascott (99>)															
3.0DXi3	F	05/04→	BBO 29121		541683	2									
	R	05/04→	BBO 29121		541683	2		290x22	(19)	187061					
SAAB 															
9-7X (2005>)															
4.2i, 4.2i Bi-Carburation, 4.2i GPL	F	12/05→						326x29							
5.3i, 5.3i Bi-Carburation, 5.3i GPL	F	12/05→						326x29							
4.2i, 4.2i Bi-Carburation, 4.2i GPL, 5.3i 5.3i Bi-Carburation, 5.3i GPL	R	12/05→													
SAAB 															
9-3 (98>2003)															
2.0SE Turbo, 2.0i, 2.0i Turbo, 2.2TiD, 2.3i	F	04/98→12/98	ATE 21829		598305	0		288x25	(21)	197226					
2.0SE Turbo, 2.0i, 2.0i Turbo, 2.2TiD, 2.3i 2.3i Turbo	F	04/98→05/03	ATE 23116		598475	2		288x25	(21)	197226					
	R	04/98→05/03	ATE 21051		598183	0		286x10	(8)	* 186566					
9-3 (2002>)															
1.8t Turbo, 1.9TiD 	⊙ 15"	F	09/02→	ATE 23402		598678	0		285x24,9	(22,2)	186881				
1.8t Turbo 	⊙ 16"	F	09/02→	ATE 23402		598678	0		302x28	(25)	186880				
1.8t Turbo, 2.0t Turbo 	⊙ 16"	F	07/07→	ATE 20224		598808	0		302x28	(25)	186880				
2.0t Turbo 		F	07/07→	ATE 20224		598808	0		314x28						
2.8t V6 		F	06/05→	ATE 23762		598822	0		345x30						

























































			 R P F		 WVA	 Valeo	 Valeo	 Valeo	 Valeo	
SAAB  (.../...)										
9-3 (2002>) (.../...)										
1.8i, 1.8t Turbo, 1.9TiD, 2.0t Turbo 2.2TiD 	R	09/02→	ATE 23482 	598472	0	 278x11,9 (10)	186854			
1.8t Turbo, 2.0t Turbo, 2.8t V6 	R	09/02→	ATE 23482 	598472	0	 292x19,9 (18)	186882			
9-5 (97>2001)										
2.0i Turbo, 2.3i Turbo	F	09/97→08/01	ATE 21829 	598305	0	 288x25 (21)	● 197226			
	F	09/97→08/01	ATE 23116 	598475	2	 288x25 (21)	● 197226			
2.3i Turbo, 3.0i V6 Turbo	⊙ 16"	F	01/98→08/01	ATE 21829 	598305	0	 308x25 (23)	● 197244		
	⊙ 16"	F	01/98→08/01	ATE 23116 	598475	2	 308x25 (23)	● 197244		
2.0i Turbo, 2.3i Turbo 3.0i V6 Turbo			 X3025751	R	09/97→	ATE 21051 	598183	0	 286x10 (8)	* 186566
			 X3025752	R	-08/01	ATE 21934 	598753	431827	 286x10 (8)	● 197009
9-5 (2001>2005)										
2.0i Turbo, 2.2TiD, 2.3i Turbo	F	09/01→01/05	ATE 23116 	598475	2	 288x25 (21)	● 197226			
2.3T Turbo, 2.3i Turbo, 3.0TiD V6 3.0i V6 Turbo	F	09/01→11/05	ATE 23116 	598475	2	 308x25 (23)	● 197244			
2.0i Turbo, 2.2TiD, 2.3i Turbo	R	09/01→01/05	ATE 21934 	598753	431827	 286x10 (8)	● 197009			
2.3T Turbo, 2.3i Turbo, 3.0TiD V6 3.0i V6 Turbo	R	09/01→11/05	ATE 21934 	598753	431827	 300x20 (18)	● 197050			
9-5 (2005>)										
1.9TiD Turbo, 2.0i Turbo, 2.3i Turbo	F	11/05→07/09	ATE 23116 	598475	2	 288x25 (21)	● 197226			
	F	11/05→07/09	ATE 20676 	● 601006	0	 308x25 (23)	● 197244			
	R	11/05→07/09	ATE 21934 	598753	431827	 286x10 (8)	● 197009			
	R	11/05→07/09	ATE 21934 	598753	431827	 300x20 (18)	● 197050			
99 (67>85)										
1.9, 2.0	F	11/67→07/74	ATE 20228 	598099	0	 280x13				
2.0, 2.0 Turbo, 2.0i	F	08/74→1985				 280x13				
1.9, 2.0, 2.0 Turbo, 2.0i	R	11/67→1985	ATE 20009 	598187	0	 269x10				

																				
SAAB 																				
99 (67>85) (.../...)																				
2.0, 2.0i		R	08/74→05/75																	
900 (80>93)																				
2.0, 2.0T Turbo, 2.0i 		F	10/80→06/86																	
2.0T Turbo 		F	07/85→06/86																	
2.0T Turbo, 2.0i 		F	07/86→06/93	ATE 21154		* 598269	0													
2.0, 2.0T Turbo, 2.0i 		F	07/86→06/93	LUC 21010		598237	431829													
		R	10/80→06/87	ATE 20009		598187	0													
		R	07/87→06/93	ATE 20756		598291	0													
900 (93>98)																				
2.0 Turbo, 2.3 		F	07/94→02/98	LUC 21010		598237	431829													
2.0, 2.0 Turbo, 2.3, 2.5 V6 		F	07/93→06/96	ATE 21411		598050	0													
		F	07/96→12/96	ATE 21829		598305	0													
		F	01/97→02/98	ATE 21829		598305	0													
		R	07/93→12/96	ATE 21140		598253	0													
		R	01/97→02/98	ATE 21140		598253	0													
2.0 Turbo, 2.3 		R	07/94→02/98	ATE 20756		598291	0													
9000 (84>98)																				
2.0 Turbo, 2.0i		F	06/84→12/89	LUC 21010		598237	0													
2.0 Turbo, 2.0i, 2.3T Turbo, 2.3i, 3.0i V6		F	06/84→07/98	ATE 21154		* 598269	0													
		R	06/84→07/98	ATE 20756		598291	0													
SANTANA 																				
Land Rover																				
2.25		F	06/85→12/91																	
2.25, 2.5		F	06/85→																	
Samurai																				
1.0, 1.3, 1.3i		F	09/86→																	























































																							
						WVA			Valeo									Valeo			Valeo		
SANTANA  (.../...)																							
Vitara																							
1.6, 1.6i			F	09/89→									290x10 (8)	186504									
			F	09/89→	LUC 20708		598531	0		290x10 (8)	186504												
1.6i			F	07/91→	AKE 21500		598023	2		290x10 (8)	186504												
			F	07/93→	AKE 21907		598533	2		287x17 (15)	186628												
			F	07/91→	AKE 21500		598023	2															
SEAT 																							
124																							
1.2, 1.4, 1.6, 1.8			F	03/69→10/80									227,5x10,8 (9)	186151									
127																							
0.9			F	03/71→03/82									227,5x10,8 (9)	186151									
			F	03/71→03/82	BDX 20647		598090	2		227,5x10,8 (9)	186151												
128																							
1.2, 1.4			F	01/77→06/79	BDX 20647		598090	2		227,5x10,8 (9)	186151												
131																							
1.4			F	07/75→12/85	BDX 20647		598090	2		227,5x10,8 (9)	186151												
132																							
1.6, 1.8			F	1973→12/85	BDX 20647		598090	2		227,5x10,8 (9)	186151												
			R	1973→07/78	BDX 20647		598088	0															
133																							
0.9			F	1974→1980									227,5x10,8 (9)	186151									
850																							
0.8, 0.9			F	1968→1973									227,5x10,8 (9)	186151									
1430																							
1.4			F	09/77→06/79									227,5x10,8 (9)	186151									
Alhambra (96>2000)																							
1.8i, 1.9TDi, 2.0i			F	03/96→05/00	ATE 20676		598067	0		288x25 (21)	● 197236												
			R	03/96→05/00	LUC 20960		598463	0(D)		268x10 (8)	186624												





















































																				
SEAT  (.../...)																				
Alhambra (2000>2003)																				
2.0i	 1-530 756	F	06/00-05/01	ATE 20676		598489	1(A)		288x25 (21)	● 197236										
	 2-500 001	F	05/01-05/03	ATE 23034			598801	2		300x26 (22)	● 197239									
1.9TDi (eng 66/85KW)	 1-530 756	F	06/00-05/01	ATE 20676		598489	1(A)		288x25 (21)	● 197236										
	 2-500 001	F	05/01-05/03	ATE 23034			598801	2		300x26 (22)	● 197239									
1.9TDi (eng 96KW)		F	11/02-05/03	ATE 23269		598565	2		313x25,9 (22)	186800										
1.8i Turbo	 1-530 756	F	06/00-05/01	ATE 20676		598489	1(A)		288x25 (21)	● 197236										
	 2-500 001	F	05/01-05/03	ATE 23269		598565	2		313x25,9 (22)	186800										
2.8i VR6		F	06/00-05/03	ATE 23269		598565	2		313x25,9 (22)	186800										
1.8i Turbo	 1-530 756	R	06/00-05/01	LUC 20960		598681	1(A+D)		268x10 (8)	186624										
	 2-500 001	R	05/01-05/03	LUC 23446		598650	2		294x13,6 (11,5)	186801										
1.9TDi (eng 66/85KW), 2.0i		R	06/00-05/03	LUC 20960		598681	1(A+D)		268x10 (8)	186624										
1.9TDi (eng 96KW), 2.8i VR6		R	06/00-05/03	LUC 23446		598650	2		294x13,6 (11,5)	186801										
Alhambra (2003>2010)																				
1.8i Turbo, 1.9TDi, 2.0TDi, 2.0i, 2.8i VR6		F	06/03-03/10	ATE 23269		598565	2		313x25,9 (22)	186800										
		R	06/03-03/10	LUC 23446		598650	2		294x13,6 (11,5)	186801										
Alhambra (2010>)																				
1.4TSi 150, 2.0TDi CR 136, 2.0TDi CR 140 2.0TDi CR 170		F	06/10→						312x25 (22)	● 197242										
2.0TFSi 200		F	11/10→						314x30											
1.4TSi 150, 2.0TDi CR 136, 2.0TDi CR 140 2.0TDi CR 170, 2.0TFSi 200		R	06/10→	LUC 23914		598752	0		286x12 (10)	● 197031										
Altea (2004>)																				
1.4TSi, 1.4i, 1.6i, 1.9TDi		F	03/04→	ATE 21974		598408	1		280x22 (19)	186754	● 186974									
1.8TFSi, 2.0FSi, 2.0TDi, 2.0TDi PD		F	03/04→	ATE 23587		598635	1		288x25 (22)	186755										
2.0TFSi		F	05/06→	ATE 23587		598635	1		312x25 (22)	● 197242										
1.4TSi, 1.4i, 1.6i, 1.9TDi		R	03/04→	LUC 20960		598463	0(D)		255x10 (8)	186857										































												
SEAT (.../...)												
Altea (2004>) (.../...)												
1.8TFSI, 2.0FSI, 2.0TDi, 2.0TDi PD	R	03/04→	LUC 23914		598752	0		260x12 (10)	186833			
2.0TFSI	R	05/06→	LUC 23914		598752	0		286x12 (10)	197031			
Arosa (97>2004)												
1.0i	F	02/97→06/04	ATE 21865		598488	0		239x9,9 (8)	186581			
1.4TDi, 1.4i, 1.7SDi	F	02/97→06/04	ATE 21865		598488	0		239x17,9 (16)	186523			
1.4TDi, 1.4i	F	05/03→06/04	LUC 21945		598330	0		256x19,9 (18)	186247			
1.4i	R	10/99→06/04	LUC 20960		598463	0(D)		232x9 (8)	186729			
Cordoba (93>96)												
1.4i		ABS(-)  TR-099 020	F	11/93→11/95	VW 20889		598127	0		239x9,9 (8)	186249	
		ABS(-)  TR-099 021	F	11/95→06/96	VW 20887		598258	0		239x9,9 (8)	186249	
1.4i, 1.6i, 1.8i		ABS(+)  TR-046 558	F	09/93→09/95	VW 20887		598128	0		239x11,9 (10)	186245	186912
1.9D, 1.9TD												
1.4i, 1.6i, 1.8i		ABS(+)  TR-046 559	F	09/95→06/96	ATE 21866		598066	0		239x11,9 (10)	186245	
1.9D, 1.9SDi, 1.9TD												
1.6i, 1.8i, 1.9D, 1.9TD	F		09/93→01/95	VW 20887		598124	0		239x19,9 (18)	186246		
1.8i 16V, 2.0i		 TR-184 566	F	09/93→04/96	LUC 20901		598016	2		256x19,9 (18)	186247	
		 TR-184 567	F	04/96→06/96	LUC 21945		598330	0		256x19,9 (18)	186247	
	R		09/93→06/96	LUC 20960		598180	0(D)		226x10 (8)	186288	186961	
Cordoba (96>99)												
1.0i, 1.4i, 1.6i, 1.9D		 V-241 400	F	07/96→09/97	ATE 21866		598066	0		239x9,9 (8)	186249	
1.9SDi 												
		 V-241 400	F	07/96→09/97	VW 20887		598258	0		239x9,9 (8)	186249	
		 V-241 400	F	07/96→09/97	ATE 21866		598066	0		239x11,9 (10)	186245	
		 V-241 400	F	07/96→09/97	VW 20887		598258	0		239x11,9 (10)	186245	
		 W-000 001	F	09/97→05/99	ATE 21866		598403	0		239x19,9 (18)	186246	
1.4i 16V, 1.6i, 1.9TD, 1.9TDi 	F		07/96→05/99	LUC 21945		598330	0		256x19,9 (18)	186247		
1.8i, 2.0i, 2.0i 16V 	F		07/96→05/99	LUC 20901		598252	0		280x22 (20)	186519		









































															
SEAT  (.../...)															
Cordoba (96>99) (.../...)															
2.0i 	R	07/96-04/99	LUC 20960		598180	0(D)		226x10 (8)	186288						
2.0i 16V 	R	07/96-04/99	LUC 20960		598463	0(D)		226x10 (8)	186288						
1.9TDi 	R	03/97-04/99	LUC 20960		598180	0(D)		226x10 (8)	186288						
1.9TDi 		 X-290 000	R	05/98-05/99	LUC 20960		598180	0(D)		226x10 (8)	186288				
		 X-290 001	R	05/99-05/99	LUC 20960		598180	0(D)		232x9 (8)	186729				
Cordoba (99>2002)															
1.0i, 1.4i, 1.6i, 1.9SDi, 1.9TDi (eng 66KW)	F	05/99-08/02	ATE 21866		598403	0		239x19,9 (18)	186246						
	F	05/99-08/02	LUC 21945		598330	0		239x19,9 (18)	186246						
	F	05/99-08/02	ATE 21866		598403	0		256x19,9 (18)	186247						
	F	05/99-08/02	LUC 21945		598330	0		256x19,9 (18)	186247						
1.8i Turbo, 1.9TDi (eng 81KW)	F	03/99-08/02	LUC 20901		598252	0		280x22 (20)	186519						
	R	03/99-08/02	LUC 20960		598180	0(D)		232x9 (8)	186729						
Cordoba (2002>)															
1.2i, 1.4TDi, 1.4i, 1.6i, 1.9SDi 1.9TDi (eng 74KW), 2.0i	F	09/02-11/09	ATE 21974		598332	0		256x21,9 (19)	186603	●186983					
1.9TDi (eng 96KW)	F	10/02-07/09	LUC 23581		598667	0		288x24,9 (22)	● 197230						
1.4i, 1.6i, 1.9TDi (eng 74KW), 2.0i	R	09/02-11/09	LUC 20960		598463	0(D)		232x9 (7)	186597						
1.9TDi (eng 96KW)		 4 209 240	R	10/02-→	LUC 20960		598463	0(D)		232x9 (7)	186597				
		 4 209 241	R	-07/09	LUC 20960		598180	0(D)		232x9 (7)	186597				
Exeo (2008>)															
1.6i, 2.0TDI (eng 88KW)	F	03/09-→	LUC 21366		598484	2		280x22 (20)	186582						
1.8i Turbo, 2.0TDI (eng 105KW)	F	12/08-→	ATE 20676		598483	2(A)		288x24,9 (23)	● 197222						
2.0TDI (eng 125KW)	F	02/09-→	ATE 20676		598483	2(A)		312x25 (23)	186758						
2.0TFSI	F	03/09-→	ATE 23762		598779	2		320x30 (28)	● 197198						
1.6i, 2.0TDI (eng 88KW)	R	03/09-→	LUC 20960		598474	0(D+C)		245x10 (8)	186807						
1.8i Turbo, 2.0TDI (eng 105/125KW)	R	12/08-→	LUC 20960		598474	0(D+C)		255x11,9 (10)	186856						





























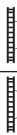



























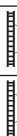



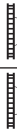

															
								WVA	Valeo						
SEAT (.../...)															
Exeo (2008>) (.../...)															
2.0TFSI		R	03/09→	LUC 23914		598752	0			255x12 (10)	●	197038			
Fura (82>86)															
0.9		LUC	F 1982→12/86							227,5x10,8 (9)		186151			
		BDX	F 1982→12/86	BDX 20647		598090	2			227,5x10,8 (9)		186151			
Ibiza (84>93)															
0.9, 1.2, 1.2i, 1.5, 1.5i, 1.7D		F	08/84→02/93	BDX 20775		598091	2			227,5x10,8 (9)		186151	186904		
1.5, 1.5i, 1.7i		F	02/87→02/93	BDX 20775		598091	2			251x20 (18)	*	186287			
Ibiza (93>96)															
1.05, 1.05i, 1.3i, 1.4i			TR-099 020	F 02/93→	VW 20889		598127	0		239x9,9 (8)		186249			
1.05i, 1.4i, 1.9SDI			TR-099 021	F →06/96	VW 20887		598258	0		239x9,9 (8)		186249			
1.6i		F	02/93→06/96	VW 20887		598128	0			239x11,9 (10)		186245	186912		
1.9D			ZR-003 611	F 02/93→	VW 20887		598128	0		239x11,9 (10)		186245	186912		
			ZR-003 612	F →06/96	VW 20887		598124	0		239x19,9 (18)		186246			
1.9TD			ZR-003 513	F 02/93→	VW 20887		598128	0		239x11,9 (10)		186245	186912		
			ZR-003 514	F →06/96	VW 20887		598124	0		239x19,9 (18)		186246			
1.8i (eng ABS 66 KW)			ZR-003 620	F 02/93→	VW 20887		598128	0		239x11,9 (10)		186245	186912		
			ZR-003 621	F →06/96	VW 20887		598124	0		239x19,9 (18)		186246			
1.8i (eng ADZ 66 KW)			TR-046 558	F 07/94→	VW 20887		598128	0		239x11,9 (10)		186245			
			TR-046 559	F →06/96	ATE 21866		598066	0		239x11,9 (10)		186245			
1.8i (eng ACC 66 KW)		F	07/94→03/95	VW 20887		598128	0			239x11,9 (10)		186245	186912		
1.8i 16V (eng ADL 96 KW), 2.0i		F	02/93→06/96	LUC 20901		598016	2			256x19,9 (18)		186247			
		R	02/93→06/96	LUC 20960		598180	0(D)			226x10 (8)		186288	186961		
Ibiza (96>99)															
1.0i, 1.4i, 1.6i, 1.9D 1.9SDi			V-241 400	F 07/96→09/97	VW 20887		598258	0		239x9,9 (8)		186249			
			V-241 400	F 07/96→09/97	ATE 21866		598066	0		239x9,9 (8)		186249			





















































											
						WVA					
SEAT  (.../...)											
Ibiza (96>99) (.../...)											
1.0i, 1.4i, 1.6i, 1.9D, 1.9SDi (...)	 V-241 400	F	07/96→09/97	VW 20887		598258	0		 239x11,9 (10)	186245	
	 V-241 400	F	07/96→09/97	ATE 21866		598066	0		 239x11,9 (10)	186245	
1.4i	 W-000 001	F	09/97→06/99	ATE 21866		598403	0		 239x11,9 (10)	186245	
1.0i, 1.4i, 1.6i, 1.9D 1.9SDi	 W-000 001	F	09/97→06/99	ATE 21866		598403	0		 239x19,9 (18)	186246	
1.4i 16V, 1.6i, 1.9TD, 1.9TDi		F	07/96→06/99	LUC 21945		598330	0		 256x19,9 (18)	186247	
1.9TDi		F	03/97→06/99	LUC 21945		598330	0		 280x22 (20)	186519	
1.8i, 2.0i		F	07/96→06/99	LUC 20901		598252	0		 280x22 (20)	186519	
1.9TDi, 2.0i		R	07/96→06/99	LUC 20960		598463	0(D)		 226x10 (8)	186288	
Ibiza (99>2001)											
1.0i, 1.4i (eng AKK, ANW, APE, AUA, AUD 44 55KW), 1.6i (eng ALM 55 KW), 1.9SDi 1.9TDi (eng AGR, AHL 66 KW)		F	04/99→11/01	ATE 21866		598403	0		 239x19,9 (18)	186246	
1.4i (eng AQQ, AUB 74KW), 1.6i (eng AEH, AKL APF, AUR 74KW)		F	06/99→11/01	LUC 21945		598330	0		 256x19,9 (18)	186247	
1.8i Turbo 6K15J6, 1.9TDi (eng ASV 81 KW)		F	03/99→11/01	LUC 20901		598252	0		 280x22 (20)	186519	
1.8i Turbo Cupra 6K16J6	BBO	F	12/99→11/01						 305x28		
1.8i Turbo 6K15J6, 1.8i Turbo Cupra 6K16J6 1.9TDi (eng ASV 81 KW)		R	03/99→11/01	LUC 20960		598180	0(D)		 232x9 (8)	186729	
Ibiza (2001>)											
1.2i, 1.4TDi, 1.4i, 1.9SDi		F	11/01→	ATE 21974		598332	0		 256x21,9 (19)	186603	● 186983
1.4i, 1.6i, 1.8i Turbo, 1.9TDi, 2.0i		F	09/01→	LUC 23581		598667	0		 288x24,9 (22)	● 197230	
		F	09/01→	LUC 23581		598720	1		 288x24,9 (22)	● 197230	
1.8i Turbo Cupra-R, 1.9TDi Cupra-R	ATE	F	12/03→02/08	ATE 21911		598303	0		 312x25 (23)	● 197246	
	AP	F	12/03→02/08						 312x25 (23)	● 197246	
1.4i, 1.6i, 1.8i Turbo, 1.9TDi, 2.0i		R	09/01→	LUC 20960		598463	0(D)		 232x9 (7)	186597	
		R	09/01→	LUC 20960		598674	1(E)		 232x9 (7)	186597	























































															
SEAT  (.../...)															
Leon (2005>) (.../...)															
1.4TFSi 125, 1.4i 86, 1.6i 102, 1.9TDi 105 1.9TDi 90, 2.0FSi 150, 2.0TDi 136, 2.0TDi 140		R	07/05→	LUC 20960		598463	0(D)	 255x10 (8)	186857						
1.8TFSi 160, 2.0TDi 170, 2.0TFSi, 2.0TFSi 185 2.0TFSi 200, 2.0TFSi 241		R	11/05→	LUC 23914		598752	0	 286x12 (10)	197031						
Malaga (85>93)															
1.2, 1.5, 1.7D		F	05/85→12/93	BDX 20647		* 598603	0	 227,5x10,8 (9)	186151						
		F	05/85→12/93	BDX 20775		598091	2	 227,5x10,8 (9)	186151	186904					
1.5		F	10/87→12/93	BDX 20775		598091	2	 251x20 (18)	* 186287						
Marbella (86>98)															
0.8, 0.9		F	11/86→05/98	BDX 20775		598091	2	 227,5x10,8 (9)	186151						
Panda (80>86)															
0.9		F	1980→03/82	BDX 20647		* 598603	0	 227,5x10,8 (9)	186151						
		F	04/82→1986	BDX 20775		598091	2	 227,5x10,8 (9)	186151						
Ronda (82>87)															
1.2, 1.5, 1.7D		F	06/82→06/87	BDX 20775		598091	2	 227,5x10,8 (9)	186151	186904					
1.6, 1.7D		F	06/82→10/86	BDX 20775		598091	2	 251,5x11 (9,5)	* 186501						
		F	06/82→10/84	LUC 20708		598093	2	 251,5x11 (9,5)	* 186501						
Toledo (91>98)															
1.6, 1.6i, 1.8i, 1.9D, 1.9TD		F	02/91→09/95	VW 20887		598128	0	 239x11,9 (10)	186245	186912					
1.6i, 1.8i, 1.9D, 1.9TD		F	10/95→09/98	ATE 21866		598066	0	 239x11,9 (10)	186245						
1.9TDi (66KW)				 TR-016 699	F	04/95→01/96	LUC 20901		598252	0	 256x12,9 (11)	186251			
				 TR-016 700  TR-031 348	F	01/96→03/96	LUC 20901		598016	2	 256x19,9 (18)	186247			
				 TR-031 349	F	03/96→12/96	LUC 21945		598330	0	 256x19,9 (18)	186247			
					F	12/96→09/98	ATE 21866		598066	0	 239x11,9 (10)	186245			
1.9TDi (81KW)		F	05/97→09/98	ATE 21866		598066	0	 239x11,9 (10)	186245						
1.8i 16V, 2.0i		F	02/91→09/98	LUC 20901		598016	2	 256x19,9 (18)	186247						
2.0i 16V		F	03/94→09/98	LUC 20901		598252	0	 280x22 (20)	186313						

















																							
SEAT 																							
Toledo (91>98) (.../...)																							
1.8i 16V, 2.0i			R	02/91→09/98	LUC 20960		598180	0(D)		226x10 (8)	186288	186961											
2.0i 16V			R	03/94→09/98	LUC 20960		598180	0(D)		226x10 (8)	186517												
Toledo (98>2004)																							
1.4i, 1.6i, 1.9TDi			⊙ 14"	F	10/98→07/04	ATE 21974		598332	0		256x21,9 (19)	186603	●186983										
			⊙ 15"	F	02/99→07/04	ATE 21974		598332	0		280x22 (19)	186604											
1.8i, 1.9TDi, 2.3i VR5			F	10/98→04/99	ATE 21911		598303	0		288x24,9 (22)	●197230												
			F	05/99→07/04	ATE 21911		598486	1		288x24,9 (22)	●197230												
1.4i, 1.6i, 1.8i, 1.9TDi, 2.3i VR5			R	10/98→07/04	LUC 20960		598180	0(D)		232x9 (7)	186597												
Toledo (2004>)																							
1.4FSi, 1.4iSRE, 1.6i, 1.9DTi, 1.9TDi			F	09/04→	ATE 21974		598408	1		280x22 (19)	186754	●186974											
1.8FSi, 2.0FSi, 2.0TDi, 2.0TDi PD, 2.0TFSi			F	09/04→	ATE 23587		598635	1		288x25 (22)	186755												
1.4FSi, 1.4iSRE, 1.6i, 1.8FSi, 1.9DTi, 1.9TDi 2.0FSi, 2.0TDi, 2.0TDi PD, 2.0TFSi			R	09/04→	LUC 20960		598463	0(D)		255x10 (8)	186857												
SEAT 																							
Inca (95>2003)																							
1.4i, 1.6i, 1.9D, 1.9SDi				T-011 100	F	11/95→03/96	LUC 20901		598252	0		256x12,9 (11)	186251										
1.4i, 1.6i, 1.7SDi, 1.9D 1.9SDi				T-011 101	F	03/96→06/03	LUC 21945		598330	0		256x19,9 (18)	186247										
Terra (87>96)																							
0.9			F	02/87→07/88	LUC 20708		598093	2		227,5x10,8 (9)	186151												
0.9, 1.3D, 1.4D			F	02/87→12/96	BDX 20775		598091	2		227,5x10,8 (9)	186151												
SKODA 																							
Yeti (2009>)																							
1.2TSi, 2.0TDI CR, 2.0TDI CR 110			F	09/09→	ATE 21974		598408	1		280x22 (19)	186754	●186974											
1.8TSi 152, 1.8TSi 160, 2.0TDI CR 140			F	05/09→	ATE 23587		598635	1		288x25 (22)	186755												
2.0TDI CR 170			F	11/09→	ATE 23587		598635	1		312x25 (22)	●197242												

































															
SKODA  (.../...)															
Yeti (2009>) (.../...)															
1.2TSI, 1.8TSI 152, 1.8TSI 160, 2.0TDI CR		R	05/09→	LUC 20960		598463	0(D)		255x10 (8)	186857					
2.0TDI CR 110, 2.0TDI CR 140															
2.0TDI CR 170		R	11/09→	LUC 23914		598752	0		286x12 (10)	197031					
SKODA 															
100-135															
S 100, S 110		F	1965→07/76	BDX 20576		601016	0		252x7,7						
S 100, S 105, S 110, S 120		F	1976→09/89	BDX 20576		601016	0		252x9						
S 130		F	09/81→12/89						247x9,6						
S 135		F	08/87→12/89						236x12,9 (11,4)	186530					
Fabia (99>2004)															
1.0i 		DA(-)	F 10/00→08/02	ATE 21865		598488	0		239x17,9 (16)	186888					
		DA(-)	F 10/00→08/02	ATE 21865		598805	1(A)		239x17,9 (16)	186888					
1.0i, 1.2i, 1.4TDi, 1.4i		DA(+)	F 08/99→07/04	ATE 21974		598332	0		256x21,9 (19)	186603	186983				
1.9SDi   		DA(+)	F 08/99→07/04	ATE 21974		598408	1		256x21,9 (19)	186603	186973				
1.4i, 1.9TDi, 2.0i  		F	11/99→07/04	LUC 23581		598667	0		288x24,9 (22)	197230					
		F	11/99→07/04	LUC 23581		598720	1		288x24,9 (22)	197230					
		 4-115 000	R 11/99→05/04	LUC 20960		598463	0(D)		232x9 (7)	186597					
		 4-115 001	R 05/04→07/04	LUC 20960		598180	0(D)		232x9 (7)	186597					
			R 11/99→07/04	LUC 20960		598674	1(E)		232x9 (7)	186597					
Fabia (2004>2007)															
1.2i, 1.4TDi, 1.4i, 1.9SDi   		F	08/04→12/07	ATE 21974		598332	0		256x21,9 (19)	186603	186983				
		F	08/04→12/07	ATE 21974		598408	1		256x21,9 (19)	186603					
1.4i, 1.9TDi, 2.0i  		F	08/04→12/07	LUC 23581		598667	0		288x24,9 (22)	197230					
		F	08/04→12/07	LUC 23581		598720	1		288x24,9 (22)	197230					
		R	08/04→12/07	LUC 20960		598180	0(D)		232x9 (7)	186597					





























































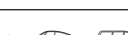

													
													
SKODA (…/…)													
Fabia (2006>)													
1.2i, 1.4TDI	☉ 13"	F	12/06→	ATE 21865		598488	0		239x17,9 (16)	186888			
	☉ 13"	F	12/06→	ATE 21865		598805	1(A)		239x17,9 (16)	186888			
1.2i, 1.4TDI, 1.4i	☉ 14"	F	12/06→	ATE 21974		598332	0		256x21,9 (19)	186603	●186983		
	☉ 14"	F	12/06→	ATE 21974		598408	1		256x21,9 (19)	186603			
1.4TDI, 1.4i, 1.6i, 1.9TDI	☉ 15"	F	01/07→	LUC 23581		598667	0		288x24,9 (22)	●197230			
	☉ 15"	F	01/07→	LUC 23581		598720	1		288x24,9 (22)	●197230			
1.6i, 1.9TDI		R	04/07→	LUC 20960		598463	0(D)		232x9 (7)	186597			
Favorit (88>95)													
1.1, 1.3		F	03/88→12/92	LUC 20862		598217	0		236x12,9 (11,4)	186530			
1.1, 1.3, 1.3i		F	12/92→03/94	LUC 20862		598217	0		236x12,8 (10,5)	186714			
		F	04/94→07/95	LUC 20862		598217	0		236x13 (11,4)	186681			
Felicia (94>2001)													
1.3, 1.3i, 1.6i, 1.9D		F	10/94→08/01	LUC 20862		598217	0		236x13 (11,4)	186681			
Forman (90>95)													
1.3		F	11/90→12/92	LUC 20862		598217	0		236x12,9 (11,4)	186530			
		F	12/92→03/94	LUC 20862		598217	0		236x12,8 (10,5)	186714			
		F	04/94→07/95	LUC 20862		598217	0		236x13 (11,4)	186681			
Octavia (96>2000)													
1.4i, 1.6i, 1.9SDi		▶  X-415 000	F	10/96→05/99	ATE 21974		598332	0		256x21,9 (19)	186603	●186983	
		▶  Y-000 001	F	05/99→07/00	ATE 21974		598408	1		256x21,9 (19)	186603		
1.9TDi		▶  X-415 000	F	10/96→05/99	ATE 21974		598332	0		280x22 (19)	186604		
		▶  Y-000 001	F	05/99→07/00	ATE 21974		598408	1		280x22 (19)	186604		
2.0i			F	05/99→07/00	ATE 21974		598408	1		280x22 (19)	186604		
1.8i (93KW)			F	10/96→04/99	ATE 21974		598332	0		280x22 (19)	186604		
1.8i (110KW) , 1.8i Turbo (110KW)			F	05/98→07/00	ATE 21911		598303	0		288x24,9 (22)	●197230		

																	
SKODA (.../...)																	
Octavia (96>2000) (.../...)																	
1.8i, 1.8i Turbo, 1.9TDi 2.0i 			4WD(-) R		10/96→07/00		LUC 20960 		598180		0(D)		 232x9 (7)		186597		
1.9TDi 			4WD(+)		06/99→07/00		LUC 20960 		598180		0(D)		 239x8,9 (7)		● 197011		
Octavia (2000>)																	
1.4i, 1.6i			F		08/00→		ATE 21974 		598332		0		 256x21,9 (19)		186603		●186983
			F		08/00→		ATE 21974 		598408		1		 256x21,9 (19)		186603		
1.9D, 1.9TDi, 2.0i			F		08/00→12/07		ATE 21974 		598332		0		 280x22 (19)		186604		
			F		08/00→12/07		ATE 21974 		598408		1		 280x22 (19)		186604		
1.8i Turbo			F		08/00→		ATE 21911 		598303		0		 288x24,9 (22)		● 197230		
			F		08/00→		ATE 21911 		598486		1		 288x24,9 (22)		● 197230		
1.8 RS, 1.8i Turbo RS			F		08/00→09/04		ATE 21911 		598486		1		 312x25 (23)		● 197246		
1.8i Turbo, 1.9D, 1.9TDi, 2.0i			R		08/00→		LUC 20960 		598180		0(D)		 232x9 (7)		186597		
1.8i Turbo, 1.9TDi, 2.0i			R		08/00→05/06		LUC 20960 		598463		0(D)		 239x8,9 (7)		● 197011		
1.8 RS, 1.8i Turbo RS			R		08/00→09/04		LUC 20960 		598463		0(D)		 256x22 (20)		● 197088		
Octavia (2004>2008)																	
1.4i, 1.6FSi, 1.6i, 1.9TDi			F		05/04→10/08		ATE 21974 		598408		1		 280x22 (19)		186754		●186974
1.8TFSi, 2.0FSi, 2.0TDi (100/103KW)			F		05/04→10/08		ATE 23587 		598635		1		 288x25 (22)		186755		
2.0TDi (125KW), 2.0TFSi			F		10/05→10/08		ATE 23587 		598635		1		 312x25 (22)		● 197242		
1.4i, 1.6FSi, 1.6i, 1.9TDi			R		05/04→10/08		LUC 20960 		598463		0(D)		 255x10 (8)		186857		
1.8TFSi, 2.0FSi, 2.0TDi (100/103KW)			R		05/04→10/08		LUC 23914 		598752		0		 260x12 (10)		186833		
2.0TDi (125KW), 2.0TFSi			R		10/05→10/08		LUC 23914 		598752		0		 286x12 (10)		● 197031		
Octavia (2008>)																	
1.4i, 1.6TDI CR, 1.6i, 1.9TDI PD			F		11/08→		ATE 21974 		598408		1		 280x22 (19)		186754		●186974
1.4T-FSi, 1.8T-FSi, 2.0TDI 136, 2.0TDI PD 2.0TDI PD 140			F		11/08→		ATE 23587 		598635		1		 288x25 (22)		186755		
2.0T-FSi, 2.0TDI 170			F		03/09→		ATE 23587 		598635		1		 312x25 (22)		● 197242		































															
SKODA  (.../...)															
Octavia (2008>) (.../...)															
1.4i, 1.6TDI CR, 1.6i, 1.9TDI PD	R	11/08→	LUC 20960		598463	0(D)		255x10 (8)	186857						
1.4T-FSI, 1.8T-FSI, 2.0TDI 136, 2.0TDI PD 2.0TDI PD 140	R	11/08→	LUC 23914		598752	0		260x12 (10)	186833						
2.0T-FSI, 2.0TDI 170	R	03/09→	LUC 23914		598752	0		286x12 (10)	197031						
Roomster (2006>)															
1.2i, 1.4TDi, 1.4i	F	05/06→	ATE 21974		598332	0		256x21,9 (19)	186603	186983					
	F	05/06→	ATE 21974		598408	1		256x21,9 (19)	186603	186973					
1.6i, 1.9TDi	F	03/06→	LUC 23581		598667	0		288x24,9 (22)	197230						
	F	03/06→	LUC 23581		598720	1		288x24,9 (22)	197230						
	R	03/06→02/07	LUC 20960		598180	0(D)		232x9 (7)	186597						
	R	03/07→	LUC 20960		598463	0(D)		232x9 (7)	186597						
Superb (2001>2008)															
1.9TDi, 2.0i			 69100 010	F	12/01→	ATE 20676		598751	2(A)		288x24,9 (23)	197222			
			 69100 011	F	-03/08	ATE 20676		598751	2(A)		288x25 (22)	186755			
2.0TDi	F	10/05→03/08			ATE 20676		598751	2(A)		288x25 (22)	186755				
1.8i Turbo, 2.5TDi V6 2.8i V6			 69100 010	F	12/01→	ATE 20676		598483	2(A)		312x25 (23)	186758			
			 69100 011	F	-03/08	ATE 20676		598483	2(A)		312x25 (22)	197242			
1.8i Turbo, 1.9TDi, 2.0TDi, 2.0i, 2.5TDi V6 2.8i V6	R	12/01→03/08			LUC 20960		598463	0(D)		245x9,9 (8)	186294				
Superb (2008>)															
1.4TFSi, 1.9TDi, 2.0TDi (103KW)	F	03/08→			ATE 23587		598635	1		288x25 (22)	186755				
1.8TFSi, 2.0TDi (125KW), 2.0TFSi	F	03/08→			ATE 23587		598635	1		312x25 (22)	197242				
3.6FSi	F	09/08→			ATE 23801		598863	1		345x30 (27)	197197				
1.4TFSi, 1.9TDi, 2.0TDi (103KW)	R	03/08→			LUC 23914		598752	0		260x12 (10)	186833				
1.8TFSi, 2.0TDi (125KW), 2.0TFSi	R	03/08→			LUC 23914		598752	0		286x12 (10)	197031				
3.6FSi	R	09/08→			LUC 23914		598752	0		310x22 (20)	197139				



































																				
SMART MCC 																				
Crossblade (2002>)																				
0.6i	F	06/02→	BOS 21999		598329	2		280x9 (8)	186859											
Forfour (2004>)																				
1.1i, 1.3i, 1.5Cdi, 1.5i	F	04/04→	LUC 21920		598318	2		256x24 (21,5)	● 197214											
1.5i Brabus	F	09/04→	LUC 21983		598493	0		281x26												
1.1i, 1.3i, 1.5Cdi, 1.5i, 1.5i Brabus	R	04/04→	LUC 21861		598319	2		250x10 (8)	● 197129											
Fortwo (98>2006)																				
0.6i, 0.7i, 0.8CDI	F	10/98→12/06	BOS 21999		598329	2		280x9 (8)	186859											
Fortwo (2007>)																				
0.8cdi, 1.0Turbo, 1.0i 45kW, 1.0i 52kW	F	01/07→	BOS 21999		598329	2		280x9,6												
Roadster (2003>2005)																				
0.7i	F	05/03→11/05	BOS 21999		598329	2		280x9 (8)	186859											
SSANGYONG 																				
Kyron (2005>2007)																				
2.0XDi	ABS(-)	F	11/05→09/07	AKE 23569		598505	2													
	ABS(+)	ESP(+)	F	11/05→09/07	AKE 23569		598505	2												
			R	11/05→09/07																
Musso (93>)																				
2.3D, 2.9D		F	08/93→03/99	LUC 23230		598528	2		278x24											
	ABS(+)	R	08/93→03/99	LUC 23242		598854	2		299x10,5											
Rexton (2002>)																				
3.2i		F	04/02→12/03	SUM 29877		598870	2		278x23,8 (22)	● 197195										
	ESP(+)	F	04/02→12/03	MDO 23726		598871	2		278x23,8 (22)	● 197195										
		F	12/03→	SUM 29877		598870	2		294x26											
	ESP(+)	F	12/03→	MDO 23726		598871	2		294x26											
		R	04/02→							299x10,4 (8,5)	● 197122									
Rexton (2004>)																				
2.7XDi, 3.2i	F	08/04→	SUM 29877		598870	2		294x26												

			R P F		WVA		Valeo		Valeo		Valeo	
SSANGYONG  (.../...)												
Rexton (2004>) (.../...)												
2.7XDi, 3.2i (...)	ESP(+)	F	08/04→	MDO 23726 	598871	2		294x26				
		R	08/04→					299x10,4 (8,5)	● 197122			
Rodius (2005>)												
2.7Xdi		F	05/05→	MDO 23726 	598871	2		300x28				
		R	05/05→	MDO 23543 	598748	2		307x20				
SUBARU 												
E10/E12 (KJ) (84>94)												
1.0, 1.2		F	08/84→02/94	SUM 20958 	598278	0		212x18				
E12 (FA) (93>)												
1.2i		F	05/93→					221x18				
Fiori (89>92)												
0.8		F	08/89→12/92					212x9				
Forester (SF) (97>2002)												
2.0i, 2.0i Turbo		F	07/97→09/02	AKE 23558 	598530	2		277x24				
2.0i	⊙ 15"	F	06/02→09/02	AKE 23865 	598853	2		277x24				
2.0i Turbo		R	07/98→09/02	AKE 23572 	● 598895	1		266x10 (8,5)	* 186503			
Forester (SG) (2002>2005)												
2.0X		F	09/02→05/05	AKE 23865 	598853	2		277x24				
2.0XT Turbo, 2.5XT Turbo		F	09/02→07/05	AKE 23865 	598853	2		295x24				
Forester (2005>2007)												
2.0X		F	08/05→11/07	AKE 23865 	598853	2		277x24				
2.5XT		F	08/05→11/07	AKE 23865 	598853	2		295x24				
		R	08/05→11/07	AKE 24331 	598875	2		266x10 (8,5)	* 186503			
Impreza (G10) (93>2000)												
1.6i, 1.6i 16V	ABS(-)	F	01/93→08/00	SUM 21495 	* 598691	2		242x18				
1.6i, 1.8i, 1.8i 4WD, 2.0i 4WD	ABS(+)	F	01/93→07/95	SUM 21495 	* 598691	2		260x24				











										
SUBARU  (.../...)										
Impreza (G10) (93>2000) (.../...)										
1.6i, 1.6i 16V, 1.6i 4WD 1.6i 4WD 16V, 1.8i 4WD, 2.0i 2.0i 4WD, 2.0i 16V, 2.0i 4WD 16V	ABS(+)	F	01/93-08/00	AKE 23780 	● 598915	2		260x24		
2.0i 4WD Turbo		F	09/94-07/96	SUM 21854 	598476	4		277x24		
		F	08/96-07/00	AKE 23558 	598530	2		277x24		
1.6i, 1.6i 4WD, 1.8i, 1.8i 4WD 2.0i, 2.0i 16V, 2.0i 4WD 2.0i 4WD 16V, 2.0i 4WD Turbo	ABS(+)	R	01/93-07/00	SUM 21703 	598828	2		266x10 (8,5) * 186503		
Impreza (G11) (2000>2005)										
1.6i 		F	09/00-08/05					260x24		
2.0i 		F	09/00-08/05	AKE 23865 	598853	2		277x24		
2.0i Turbo 		F	09/00-08/05	SUM 21854 	598476	4		294x24		
2.0STi Turbo 		F	11/01-08/05	BBO 23092 	● 598919	1		326x30		
2.0i 		R	09/00-08/05	AKE 24331 	598875	2		266x10 (8,5) * 186503		
2.0i 		R	09/00-08/05	AKE 23572 	● 598895	1		266x10 (8,5) * 186503		
2.0i Turbo 		R	09/00-08/05	AKE 23381 	● 598916	1		290x18		
2.0STi Turbo 		R	11/01-08/05	BBO 21580 	● 598914	2		316x20		
Impreza (G11) (2005>2007)										
2.0R 		F	09/05-06/06	AKE 23865 	598853	2		277x24		
2.5WRX Turbo 		F	09/05-06/07	SUM 21854 	598476	4		294x24		
2.5STi Turbo, 2.5STiS Turbo 		F	09/05-06/07	BBO 23092 	● 598919	1		326x30		
2.0R 		R	09/05-06/06	AKE 24331 	598875	2		266x10 (8,5) * 186503		
2.5WRX Turbo 		R	09/05-06/07	AKE 23381 	● 598916	1		290x18		
2.5STi Turbo, 2.5STiS Turbo 		R	09/05-06/07	BBO 21580 	● 598914	2		316x20		
Justy (86>95)										
1.0 		F	06/86-06/87					212x10		
1.0, 1.0 4WD 		F	06/86-06/88	SUM 20958 	598278	0		212x10		

		RPF		WVA			Valeo		Valeo		Valeo	
		232		Valeo			Valeo		Valeo		Valeo	
SUBARU  (.../...)												
Justy (86>95) (.../...)												
1.0 	F	06/86→05/95								212x18		
1.2, 1.2 4WD 	F	08/88→06/92								240x18		
Justy (95>2003)												
1.3i	F	10/95→12/97	AKE 21333 	598666	2		231x17 (15)	186505				
	F	12/97→10/03	BOS 23046 	598991	1		231x17 (15)	186505				
Justy G3X (2003>)												
1.3D, 1.3i, 1.5i	F	10/03→	BOS 23253 	598453	2		253x17 (15)	186805				
Legacy (89>94)												
1.6, 1.8i 	F	05/89→09/94	SUM 21495 	* 598691	2		242x18					
1.6, 1.8i, 1.8i 4WD, 2.2i, 2.2i 4WD, 2i 	F	05/89→09/94	SUM 21495 	* 598691	2		260x24					
2i 4WD Turbo 	F	08/91→09/94	SUM 21495 	* 598691	2		277x24					
1.8i, 1.8i 4WD, 2.2i, 2.2i 4WD, 2i 	R	05/89→09/94	SUM 21703 	598828	2		266x10 (8,5)	* 186503				
2i 4WD Turbo 	R	08/91→09/94	SUM 21703 	598828	2		266x18					
Legacy (94>98)												
2.0i, 2.0i 4WD, 2.2i, 2.2i 4WD 	F	01/94→06/96	SUM 21495 	* 598691	2		260x24					
1.8i, 2.0i, 2.0i 4WD, 2.2i, 2.2i 4WD 	F	07/95→11/98	AKE 23780 	598915	2		260x24					
2.5i 4WD 16V  	F	07/96→11/98	AKE 23558 	598530	2		277x24					
1.8i, 2.0i, 2.0i 4WD, 2.2i, 2.2i 4WD 2.5i 4WD 16V 	R	01/94→11/98	SUM 21703 	598828	2		266x10 (8,5)	* 186503				
Legacy (98>2003)												
2.0i (Typ B—3J) 	F	10/98→04/01	AKE 23780 	598915	2		260x24					
2.0i (Typ B—4J, B—4R), 2.5i, 3.0i 	F	10/98→04/03	AKE 23558 	598530	2		277x24					
2.0i, 2.5i  ABS(+)	R	10/98→02/00	AKE 23572 	598895	1		290x10					
2.0i, 2.5i, 3.0i  ABS(+)	R	02/00→04/01					290x10					
	R	05/01→04/03					290x10					
Legacy (2003>)												
2.0i 4WD 16V, 2.5i 4WD 16V 	F	05/03→	AKE 23865 	598853	2		277x24					







































																	
SUBARU  (.../...)																	
Legacy (2003>) (.../...)																	
2.5i Outback 4WD 16V		F		05/03→		AKE 23865 		598853		2		294x24					
3.0i Outback 4WD 24V 																	
3.0i 4WD 24V  		F		09/03→								316x30					
2.0i 4WD 16V, 2.5i 4WD 16V		R		05/03→		AKE 24271 		● 598929		2		273x10					
2.5i Outback 4WD 16V																	
3.0i Outback 4WD 24V  																	
3.0i 4WD 24V  		R		09/03→		AKE 23572 		● 598895		1		290x18					
SVX (91>97)																	
3.3i		⊙ 16"		F		05/91→12/97						301x28					
		R		05/91→12/97		SUM 21703 		598828		2		290x18					
SUBARU 																	
Sumo (87>94)																	
1.0, 1.2		F		06/87→02/94		SUM 20958 		598278		0		212x18					
SUZUKI 																	
Jimny (98>)																	
1.3i		F		09/98→		AKE 21142 		598021		0		290x10 (8)		186504			
S410/S413																	
1.0, 1.3		F		06/81→		AKE 21142 		598021		0		289,8x10 (9)		186374			
		F		07/85→								289,8x10 (9)		186374			
Samurai (92>)																	
1.3, 1.3i		F		04/92→		ATE 21336 		598532		0		289,8x10 (9)		186374			
Grand Vitara (98>2005)																	
1.6i, 2.0i		2/3 Doors		F		05/98→02/05		AKE 23314 		598534		2		287x17 (15)		● 197065	
2.0HDi, 2.0TD, 2.0i, 2.5i V6		5 Doors		F		05/98→02/05		AKE 23314 		598534		2		310x22 (20)		● 197162	
Grand Vitara XL7 (2001>2006)																	
2.0HDi		F		03/01→01/06		AKE 24301 		598878		2		310x22					
2.7i V6 (eng 127KW H27A)		F		03/01→01/04		AKE 23314 		598534		2		310x22 (20)		● 197162			
2.7i V6 (eng 135KW H27A-184)		F		03/03→01/04								310x22					









































			R P F		2/3		WVA		Valeo		Valeo		Valeo		
SUZUKI  (.../...)															
Grand Vitara (2006>)															
1.6VVT, 1.9DDiS, 2.0VWT		F	03/06→	AKE 24346		598877	2			294x25					
Vitara (88>98)															
1.6, 1.6i	2/3 Doors	F	10/88→03/98	AKE 21500		598023	2			290x10 (8)		186504			
1.9D, 1.9TD	2/3 Doors	F	01/96→03/98	LUC 20708		598531	0			290x10 (8)		186504			
1.6i, 1.9TD	5 Doors	F	10/91→03/98	AKE 21907		598533	2			287x17 (15)		186628			
2.0 V6, 2.0TD	5 Doors	F	01/95→03/98	AKE 23314		598534	2			311x22					
2.0HDI	5 Doors	F	01/98→03/98	AKE 21907		598533	2								
X90 (95>)															
1.6		F	11/95→	AKE 21500		598023	2			290x10 (8)		186504			
SUZUKI 															
Alto (SS80/SB30) (80>94)															
0.8		F	10/80→09/85	SUM 20731		598185	0			213,5x11					
		F	10/85→02/94	SUM 20731		598185	0			215x10 (8)		197114			
Alto (SH410) (94>2002)															
1.0		F	03/94→05/02	AKE 21333		598666	2			231x17 (15)		186505			
Alto (RF410) (2002>2006)															
1.1i		F	06/02→03/06							231x17					
Alto (2009>)															
1.0i		F	01/09→	AKE 23507		598733	1			230x19					
Baleno (95>)															
1.3i 16V, 1.5i 16V, 1.6i 16V	 160000	F	04/95→	SUM 23400		598830	4			235x20 (18)		186827			
1.6i 4WD 16V  	 160001	F		SUM 23795		598697	2			235x20 (18)		186827			
1.8i 16V  	 160000	F	06/96→	SUM 23400		598830	4			246x20					
	 160001	F		SUM 23795		598697	2			246x20					
		R	06/96→	SUM 20031		598624	0			240x10					
Cappuccino (SX306) (91>98)															
0.7		F	10/91→03/98	AKE 21333		598666	2			231x17 (15)		186505			

															
SUZUKI  (.../...)															
Cappuccino (SX306) (91>98) (.../...)															
0.7 (...)	R	10/91→03/98											232x10		
Ignis (RG) (2000>2003)															
1.3i, 1.5i			 170000	F	09/00→	AKE 23507		598832	2				257x17 (15)	● 197064	
			 170001	F	→08/03	AKE 23507		598733	1				257x17 (15)	● 197064	
		R	09/00→08/03				AKE 24039		598831	1					
Ignis (RM) (2003>)															
1.3DDiS, 1.3i, 1.5i	F	09/03→				BOS 23253		598453	2				253x17 (15)	186805	
Liana (R441) (2001>)															
1.3i 16V, 1.6i 16V, 1.6i 4WD 16V	F	06/01→				AKE 23817		598848	2				246x20		
1.4DDiS	F	04/04→				AKE 23817		598848	2				246x20		
	F	04/04→											246x20		
Splash (2008>)															
1.0i, 1.2i, 1.3DDiS	F	03/08→				LUC 23973		598847	1				252x20 (18)	● 197066	
Swift Made in Japan (SA) (83>89)															
1.0, 1.3	F	10/83→02/89											215x10 (8)	● 197114	
1.0 Turbo	F	10/83→1988											211x15		
1.3 16V	F	08/84→01/88				AKE 21333		598666	2				231x17		
	R	08/84→01/88											240x10		
Swift Made in Japan (SF) (89>96)															
1.0, 1.0i, 1.3, 1.3i, 1.3i 4WD 	F	03/89→08/96				AKE 21333		598666	2						
	F	03/89→08/96				AKE 21730		● 598986	4						
1.0, 1.0i, 1.3, 1.3i, 1.3i 4WD 	F	03/89→08/96				AKE 21333		598666	2				231x17 (15)	186505	
	F	03/89→08/96				AKE 21730		● 598986	4				231x17 (15)	186505	
1.3i 16V, 1.6i 16V, 1.6i 4WD 16V 	F	10/89→08/96				AKE 21344		598296	2				250x18,5		
1.3i 16V 	R	10/89→08/96											240x10		
Swift Made in Hungary (SF) (95>96)															
1.0i, 1.3i 	F	01/95→08/96				AKE 21333		598666	2				231x17 (15)	186505	







































																			
SUZUKI  (.../...)																			
Swift Made in Hungary (SF) (96>2005)																			
1.0i, 1.3i 			F	09/96→12/97	AKE 21333 	598666	2		231x17 (15)	186505									
			F	12/97→03/05	BOS 23046 	● 598991	1		231x17 (15)	186505									
Swift Made in Hungary (RS) (2005>)																			
1.3DDiS, 1.3i, 1.5i 			F	04/05→	LUC 23973 	598847	1		252x20 (18)	● 197066									
SX4 (2006>2009)																			
1.5i 4x2 16V, 1.6VWT 4x2 16V, 1.6VWT 4x4 16V 1.9DDiS 4x2, 1.9DDiS 4x4			F	03/06→06/09	LUC 24391 	598804	1		280x22 (20)	● 197135									
SX4 (2009>)																			
1.5VWT, 1.6DDiS, 1.6VWT, 2.0DDiS			F	07/09→	LUC 24391 	598804	1		280x22 (20)	● 197135									
2.0VWT			F	07/09→					280x22										
			R	07/09→															
Wagon R (SR) (97>)																			
1.0i, 1.2i			F	03/97→	AKE 23662 	598843	2		231x17 (15)	● 197163									
Wagon R+ (RB) (2000>)																			
1.0i, 1.3DDiS, 1.3i				 00210000	F	03/00→	BOS 23253 	598453	2		247x12 (10)	186784							
				 00210001 •  00280000	F							253x17 (15)	186805						
				 00280001	F		BOS 23253 	598453	2		253x17 (15)	186805							
SUZUKI 																			
Carry (GA4*)																			
1.3i			F	07/99→	AKE 23507 	598733	1		237x17										
Super Carry (SK4*)																			
1.0			F	04/85→01/99					215x10										
0.6i, 0.6i 4WD			F	1990→1999					215x10 (8)	● 197114									
0.6i Turbo			F	1990→1999					231x17										
TALBOT 																			
1000 (66>78)																			
1.3			F	07/72→06/78	ATE 20911 	598113	1		239x11 (9,9)	* 186240									
0.8, 0.9, 1.0, 1.1, 1.3			F	07/66→06/78	ATE 20228 	598099	0		234,5x11										

TALBOT (.../...)							
1000 (66>78) (.../...)							
1.3	R	07/72-06/78 BDX 20647	598088	0			
1100 (67>81)							
1.0, 1.1, 1.2, 1.3	F	09/67-07/81 ATE 20228	598099	0		234,5x11	
	F	09/67-07/81 LUC 20579	598161	2		234,5x11	
1.3	F	09/73-01/78 ATE 20009	598187	0		234,5x11	
1200S (69>71)							
1.2	F	07/69-06/71 ATE 20228	598099	0		234,5x11	
1301-1501 (63>76)							
1.3, 1.5	F	1965-1976 ATE 20911	598113	1		238,5x11	
1307/8/9 (75>79)							
1.3, 1.4, 1.6	F	07/75-07/79 BDX 21061	598081	2		240,5x11	
	F	07/75-07/79 ATE 20913	* 598375	2(A)		240,5x11	
1510 (79>82)							
1.4, 1.6	F	07/79-02/80 BDX 20661	598162	2		240,5x11	
	F	07/79-02/80				240,5x11	
1.3, 1.4, 1.6	F	02/80-1982 BDX 20661	598162	2		240,5x12,7(11,7) * 186242	
	F	02/80-1982				240,5x12,7(11,7) * 186242	
160 (70>80)							
1.6, 1.8	F	10/70-1973 ATE 20011	* 598111	0		249x12,7	
1.6, 1.8, 2.0	F	1973-05/80 LUC 20146	598174	2		249x12,7	
Alpine (81>85)							
1.3, 1.6	F	09/81-09/85				240,5x12,7(11,7) * 186242	
Avenger (70>81)							
1.2, 1.3, 1.5, 1.6	F	1970-1977 ATE 20088	598338	0			
1.3, 1.6	F	09/76-1981				241x9,8	
Bagheera (77>80)							
1.3, 1.4	F	07/77-06/80 ATE 20911	598113	1		239x11 (9,9) * 186240	

		R P F		WVA		Valeo		Valeo	
TALBOT  (.../...)									
Bagheera (77>80) (.../...)									
1.3, 1.4 (...)	R	07/77→06/80	BDX 20347 	598085	2		234,5x11		
Horizon (78>86)									
1.1, 1.3, 1.4	F	01/78→07/81	LUC 20579 	598161	2		239x11 (9,9)	* 186240	
1.1, 1.3, 1.4, 1.6, 1.7D, 1.9D	F	07/81→1986	ATE 20845 	* 598163	2		239x11 (9,9)	* 186240	
	F	01/78→1986	ATE 20911 	598113	1		239x11 (9,9)	* 186240	
	F	01/78→1986	BDX 20573 	598592	2		239x11 (9,9)	* 186240	
Murena (81>83)									
1.6, 2.2	F	1981→1983	BDX 21061 	598081	2		240,5x11		
	R	1981→1983	BDX 20347 	598085	2		234,5x11		
Rancho (77>86)									
1.4	F	09/77→07/80	ATE 20911 	598113	1		239x11 (9,9)	* 186240	
	F	09/77→07/80	LUC 20579 	598161	2		239x11 (9,9)	* 186240	
	F	07/80→1986	ATE 20845 	* 598163	2		239x11 (9,9)	* 186240	
	F	07/81→1986	BDX 20573 	598592	2		239x11 (9,9)	* 186240	
Samba (81>85)									
1.0, 1.1, 1.2, 1.4 	F	01/81→1985	BDX 20347 	598078	2		241x10 (9)	186142	
	F	01/81→1985	ATE 20913 	* 598375	2(A)		241x10 (9)	186142	
Solara (80>85)									
1.3, 1.4, 1.6	F	04/80→07/80	BDX 21061 	598081	2		240,5x11		
	F	04/80→07/80	ATE 20913 	* 598375	2(A)		240,5x11		
	F	07/80→1985	BDX 20661 	598162	2		240,5x12,7(11,7)	* 186242	
	F	07/80→1985					240,5x12,7(11,7)	* 186242	
Tagora (80>84)									
2.2, 2.3D, 2.7	F	07/80→1984	ATE 20454 	598178	2		273x12,9 (10,7)	186202	
2.7	F	07/81→1984	ATE 20454 	598178	2		273x20 (18)	* 186203	
	R	07/81→1984	LUC 20253 	598193	2		273x12		









































																	
TOYOTA 																	
4 Runner (60) (84>89)																	
2.0, 2.4D		F	03/84→08/85	SUM 20566		● 598921	0				302,5x12,5						
2.2i, 2.4D, 2.4i		F	08/85→12/89	SUM 20566		● 598921	0				289x20 (18)	* 186547					
4 Runner (130) (89>95)																	
2.4TD, 3.0TD, 3.0i		F	08/89→11/95	SUM 21775		598393	4				291x25 (23)	* 186640					
2.4TD		F	01/90→08/91	SUM 21785		● 598897	4				291x25 (23)	* 186640					
4 Runner (180) (95>2002)																	
2.7i, 3.4i V6	☉ 16"	F	11/95→08/02	SUM 21775		598393	4										
3.4i V6	☉ 16"	F	08/00→08/02	SUM 21775		598393	4				319x22 (20)	* 186704					
Hilux (RN, LN3,4) (78>84)																	
1.6, 2.0, 2.2D		F	08/78→03/84	AKE 20729		598614	0				252x20						
2.0		F	08/78→07/83								266x12,7						
2.0 4WD, 2.2D 4WD		F	01/79→07/83	SUM 20566		● 598921	0				302x12,4						
Hilux (RN, YN, LN5,6) (83>98)																	
2.0 4WD, 2.2i 4WD, 2.4D 4WD		F	08/83→08/95	SUM 20566		● 598921	0				302,5x12,5						
1.6, 1.8, 2.0, 2.0 Auto, 2.2D, 2.2i 2.2i Auto, 2.4, 2.4D, 2.4D Auto		F	08/83→07/98	AKE 21158		598402	0				257x25 (24)	186696					
2.2i, 2.2i Auto		F	08/87→08/88								257x25 (24)	186696					
1.8, 2.4D		F	08/88→08/97	AKE 20729		598614	0				257x25 (24)	186696					
2.2i 4WD, 2.4D 4WD		F	08/88→08/97	SUM 21785		● 598897	4				257x25 (24)	186696					
2.2i 4WD, 2.4D, 2.4D 4WD, 2.4i 4WD		F	08/88→08/97	SUM 21785		● 598897	4				289x20 (18)	* 186547					
Hilux (KDN) (2001>)																	
2.5D-4D 4WD	GX	F	08/01→								257x25 (24)	186696					
	VX	F	08/01→	SUM 21785		● 598897	4				257x25 (24)	186696					
2.5D-4D, 2.5D-4D 4WD 2.5D-4D Auto 4WD	GX, VX	F	08/01→	SUM 21785		● 598897	4				289x20 (18)	* 186547					
Hilux (2005>)																	
2.5D-4D 4WD		F	07/05→								255x28						















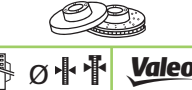

















TOYOTA (.../...)		
Hilux (2005>) (.../...)		
2.5D-4D 4WD, 2.5D-4D Auto 4WD	F 07/05→	SUM 29894 ● 598894 2 257x28
2.5D-4D 4WD, 3.0D-4D 4WD, 3.0D-4D Auto 4WD	F 07/05→	297x25
Land Cruiser (BJ40) (80>84)		
3.0D, 3.4D, 4.0D, 4.2	F 08/80→10/84	SUM 20566 ● 598921 0 302x20 (19) * 186637
Land Cruiser (BJ60) (80>90)		
3.4D, 4.0, 4.0D, 4.0TD, 4.0i, 4.2	F 08/80→01/90	SUM 20566 ● 598921 0 302x20 (19) * 186637
Land Cruiser (BJ70) (84>2001)		
2.4, 2.4D, 2.4TD, 2.4i, 3.4TD	F 11/84→05/93	SUM 21785 ● 598897 4 302,5x12,5
2.4, 2.4TD, 2.4i	F 01/90→04/96	
2.5TD, 3.4D	F 11/84→01/90	SUM 20566 ● 598921 0 302x20 (19) * 186637
3.0TD, 4.2D	F 08/92→08/99	SUM 21785 ● 598897 4 302x20 (19) * 186637
2.4, 2.4TD, 2.4i, 3.0TD, 4.2D	R 08/86→08/99	SUM 21947 598777 0
Land Cruiser (BJ80) (90>98)		
4.0i, 4.2D	F 01/90→08/92	SUM 21775 598393 4 286x25 (23) * 186645
4.2TD, 4.5i	F 08/92→01/98	SUM 21775 598393 4 311x32 (30) * 186638
4.0i, 4.2D, 4.2TD, 4.5i	R 01/90→01/98	SUM 21947 598777 0
Land Cruiser (HD/UZ10) (98>2007)		
4.2TD, 4.7i	F 01/98→08/07	SUM 23524 598535 2 313x32
	R 01/98→08/07	AKE 23539 598865 0 330x18
Land Cruiser (KZ/VZ9) (96>2002)		
3.0TD, 3.4i V6	F 04/96→09/02	SUM 21785 ● 598897 4 319x22 (20) * 186704
	R 04/96→09/02	SUM 21947 598777 0 312x18
Land Cruiser (KD/GR) (2002>)		
3.0D-4D, 4.0i WVT-i	F 09/02→08/04	SUM 24024 598857 2 338x28 (26) ● 197071
	R 09/02→08/04	SUM 21947 598777 0 312x18
Land Cruiser Prado (2009>)		
3.0D-4D, 4.0WVTi V6	F 08/09→	





















































																		
TOYOTA 																		
Land Cruiser Prado (2009>) (.../...)																		
3.0D-4D, 4.0VtTi V6 (...)		R	08/09→	SUM 21947		598777	0											
Model F (82>90)																		
1.8, 2.0, 2.0D, 2.2i		F	11/82→08/88															
2.0, 2.2i		F	08/88→01/90	AKE 21835		598496	0		255x20									
RAV4 (94>2000)																		
2.0i		F	04/94→07/00	AKE 21601		598551	2		302x18 (16)	186686								
		ABS(+)	F	01/98→07/00						302x18 (16)	186686							
		R	04/94→07/00	AKE 23656		598673	2											
RAV4 (2000>2005)																		
1.8i, 2.0D-4D, 2.0Vt-i, 2.0i		F	05/00→11/05	AKE 23585		598536	0		275x25 (23)	186765								
		R	05/00→11/05	AKE 23656		598673	2		303x9 (8)	197112								
RAV4 (2005>)																		
2.2D		Europe(-)	F	03/06→					275x25 (22)	197151								
2.0VtTi, 2.0VtTi 158, 2.2D-4D, 2.2D-4D 150 2.4VtTi		F	11/05→	SUM 24337		601037	0		296x28 (25)	197152								
		R	11/05→	AKE 24338		598819	0											
TOYOTA 																		
Auris Made in Japan (2006>)																		
1.3Vt-i 100, 1.4Vt-i 97, 1.6Vt-i 124 1.6Vt-i 132, 1.8Vt-i 147		F	10/06→10/09	AKE 24336		598943	0		275x22 (19)	197183								
1.4D-4D, 1.4D-4D 90		F	10/06→12/08	BOS 24122		601040	0		273x26 (23)	197185								
2.0D-4D, 2.0D-4D 126		F	10/06→10/09	AKE 24336		598943	0		295x26 (23)	197187								
1.3Vt-i 100, 1.4Vt-i 97, 1.6Vt-i 124 1.6Vt-i 132, 1.8Vt-i 147		R	10/06→10/09	AKE 24610		598933	2		259x9 (7,5)	197110								
1.4D-4D, 1.4D-4D 90, 2.0D-4D, 2.0D-4D 126		R	10/06→10/09	AKE 24610		598933	2		270x9,9 (8)	197109								
Auris Made in UK (2007>)																		
1.4D-4D, 1.4Vt-i, 1.6Vt-i		F	02/07→01/10	BOS 24122		601040	0		273x26 (23)	197185								





































TOYOTA (.../...)								
Auris Made in UK (2007>) (.../...)								
1.3WT-i 100, 1.4D-4D, 1.4D-4D 90, 1.4WT-i 1.6WT-i, 1.6WT-i 132	F	02/07→01/10					273x26 (23)	● 197185
2.0D-4D, 2.2D-4D	F	02/07→01/10					295x26 (23)	● 197187
1.3WT-i 100, 1.4D-4D, 1.4D-4D 90, 1.4WT-i 1.6WT-i, 1.6WT-i 132, 2.0D-4D	R	02/07→01/10					270x9,9 (8)	● 197109
2.0D-4D, 2.2D-4D	R	02/07→01/10	AKE 24610	● 598933	2		270x9,9 (8)	● 197109
Auris FL (UKP150) (2010>)								
1.3WT-i 100, 1.4D-4D 90, 1.6WT-i 124 1.6WT-i 132, 1.8WT-i 147	F	01/10→					273x26 (23)	● 197185
2.0D-4D 126, 2.2D-4D 177	F	01/10→					295x26 (23)	● 197187
1.3WT-i 100, 1.4D-4D 90, 1.6WT-i 124 1.6WT-i 132, 1.8WT-i 147, 2.0D-4D 126	R	01/10→					270x9,9 (8)	● 197109
2.2D-4D 177	R	01/10→	AKE 24610	● 598933	2		270x9,9 (8)	● 197109
Avensis (AT22) (97>2000)								
1.6i, 1.8i, 2.0D-4D 2.0TD, 2.0i	Rear brake Shoes	F	10/97→06/00	ATE 21976	● 598478	2		260x25 (23) ● 186705
	Rear brake Discs	F	01/00→06/00	AKE 21961	● 598809	0		275x28 (26) ● 186876
		R	01/00→06/00	LUC 24013	● 598810	2		288x10 (8,5) ● 186850
Avensis (ZZT22) (2000>2003)								
1.6WTi, 1.8i 2.0D4	⊙ 14" Rear brake Shoes	F	07/00→01/03	ATE 21976	● 598478	2		260x25 (23) ● 186705
1.6WTi, 1.8i, 2.0D-4D 2.0D4, 2.0i	Rear brake Discs	F	07/00→07/01	AKE 21961	● 598809	0		276x25
	Rear brake Discs	F	07/01→01/03	ATE 23996	● 598653	2		276x25
	⊙ 15"	F	07/00→01/03	ATE 21976	● 598478	2		275x28 (26) ● 186876
		R	07/00→07/01	LUC 24013	● 598810	2		288x10 (8,5) ● 186850
		R	07/01→01/03	LUC 24013	● 598810	2		271x10

TOYOTA (.../...)											
Avensis (T25) (2003>2008)											
1.6VtTi, 1.8VtTi, 2.0D-4D, 2.0VtTi, 2.2D-4D	F	01/03→11/08	BOS 23768	598665	2		295x26				
2.0D-4, 2.4VtTi	F	01/03→11/08	BOS 23768	598665	2		277x26 (24)	● 197072			
1.6VtTi, 1.8VtTi, 2.0D-4, 2.0D-4D, 2.0VtTi 2.4VtTi	R	01/03→11/08	BOS 23620	598812	2		280x10 (9)	186849			
2.2D-4D	R	04/05→11/08	BOS 23620	598812	2						
Avensis (2008>)											
1.6WT-i 132, 1.8WT-i 147, 2.0D-4D 126 2.0WT-i 152	F	11/08→					295x26 (23)	● 197187			
2.2D-4D 150, 2.2D-4D 177	F	11/08→									
1.6WT-i 132, 1.8WT-i 147, 2.0D-4D 126 2.0WT-i 152, 2.2D-4D 150, 2.2D-4D 177	R	11/08→									
Avensis Verso (CM20) (2001>2005)											
2.0D-4D, 2.0VtTi	F	05/01→07/05	SUM 21961	598541	2		275x28 (26)	● 197166			
	R	05/01→07/05	SUM 23646	598542	2		291x12 (10,5)	● 197018			
Aygo (KGB/WNB)(2005>)											
1.0VtTi, 1.4D	F	02/05→	BOS 23959	598718	0		247x20 (18)	● 197047			
Camry (SU/CU10)(82>86)											
1.8, 1.8TD, 2.0TD, 2.0i	F	10/82→10/86	AKE 20870	598266	4		243x22				
Camry (SU/CU20)(86>91)											
1.8, 2.0TD, 2.0i	F	10/86→01/88	AKE 20870	598266	4		255x22 (21)	* 186509			
1.8, 2.0i	F	01/88→08/88					255x22 (21)	* 186509			
2.0TD, 2.0i, 2.5i V6	F	08/88→06/91	AKE 21158	598402	0		255x22 (21)	* 186509			
2.0i, 2.5i V6	R	08/87→06/91					269x10				
2.0i, 2.5i V6	R	01/90→06/91	AKE 21833	598540	0		269x10				
Camry (SX/VC10) (91>96)											
2.2i	F	03/92→09/93	AKE 21601	598551	2		255x28 (26)	● 197167			
	F	09/93→07/96									
3.0i V6	F	08/93→08/96					275x28 (26)	● 197166			















					
TOYOTA  (.../...)					
Camry (SX/VC10)(91>96) (.../...)					
2.2i, 3.0i V6 	R 03/92→07/96 AKE 21833  598540 0				
2.2i, 3.0i V6 	R 06/91→08/96				
Camry (MCU/SXU20) (96>2001)					
2.2i, 3.0i V6	F 08/96→07/01				 275x28 (26) ● 197166
	R 08/96→07/01	AKE 21833 	598540	0	
	R 08/99→07/01				
Camry (ACU/MCU30) (2001>2006)					
2.0i, 2.4i, 3.0i V6	F 08/01→01/06	AKE 23806 	598862	0	 296x28 (26) ● 197168
	R 08/01→01/06				 288x10
Camry (ACU/GSV40) (2006>)					
2.4i, 3.5i V6	F 01/06→	AKE 24350 	● 598890	0	
	R 01/06→	AKE 24338 	598819	0	
Carina II (ST15) (83>87)					
1.6, 1.8i, 2.0D, 2.0i	F 09/83→12/87	AKE 20870 	598266	4	 243x22
Carina II (ST17) (87>92)					
1.6, 1.6i, 2.0D 	F 12/87→11/92	AKE 20870 	598266	4	 255x22 (21) * 186509
1.6, 1.6i, 2.0D, 2.0i  ⊙ 14"	F 12/87→11/92	AKE 20870 	598266	4	 x22
2.0i 	R 12/87→03/92	AKE 21833 	598540	0	 269x10
Carina E (DT/ST19) (92>97)					
1.6i 16V, 1.8i 16V, 2.0D, 2.0TD 	F 12/92→12/97	AKE 21601 	598551	2	 255x24,9 (24) ● 197169
	F 12/93→10/97	AKE 21601 	598551	2	 255x28 (26) 186822
2.0i 16V 103KW 	F 02/92→10/97	AKE 21601 	598551	2	 255x28 (26) ● 197148
2.0i 16V 118KW 	F 02/92→01/96	AKE 21961 	598809	0	
	R 02/92→01/96	AKE 21833 	598540	0	 268,5x10
Celica (ST16) (85>89)					
1.6, 1.6i 16V 	F 08/85→08/89	AKE 20870 	598266	4	 243x22
2.0i 	F 10/86→08/87	AKE 20870 	598266	4	 258x22 (21) * 186508

















															
TOYOTA  (.../...)															
Celica (ST16) (85>89) (.../...)															
2.0i, 2.0i Auto 	ABS(+)	F	08/87→08/89												
2.0i 4WD Turbo 		F	10/87→08/89	AKE 20870 	598266	4									
2.0i 4WD Turbo, 2.0i, 2.0i Auto 		R	08/85→08/89												
Celica (ST18) (89>93)															
1.6 16V 		F	10/89→08/91	AKE 20870 	598266	4									
		F	08/91→10/93	AKE 20870 	598266	4									
2.0 16V, 2.0 4WD Turbo, 2.0 4x4 Turbo 		F	10/89→10/93	AKE 20870 	598266	4									
		R	10/89→10/93												
Celica (ST200) (93>99)															
1.8i 16V 		F	11/93→07/99												
	ABS(+)	F	11/93→07/99	AKE 23294 	598579	0									
2.0i 		F	11/93→07/99												
2.0i 4WD Turbo 		F	02/94→06/96												
1.8i 16V 		R	11/93→07/99	AKE 21833 	598540	0									
2.0i 		R	11/93→07/99												
2.0i 4WD Turbo 		R	02/94→06/96												
Celica (ZT230) (99>2005)															
1.8VWT-i 16V 105KW		F	08/99→09/05	AKE 23510 	598737	2									
1.8i 16V 141KW		F	08/00→09/01	AKE 23526 	598827	0									
		F	09/01→09/05	AKE 23526 	598827	0									
1.8VWT-i 16V 105KW, 1.8i 16V 141KW		R	08/99→09/05	SUM 23521 	598577	2									
Corolla (80) (83>87)															
1.3 Auto 		F	05/85→09/87												
1.3, 1.3 Auto, 1.6, 1.6 Auto 		F	05/83→09/87	AKE 20870 	598266	4									
1.3, 1.3 Auto, 1.6, 1.6 Auto, 1.8D 		F	05/83→09/87	AKE 20870 	598266	4									
1.3, 1.3 Auto, 1.8D 		F	05/83→09/87	AKE 20870 	598266	4									

			RPF		WVA		Valeo		Valeo		Valeo	
			RPF		WVA		Valeo		Valeo		Valeo	
TOYOTA (.../...)												
Corolla (80) (83>87) (.../...)												
1.3, 1.3 Auto, 1.8D 	F	05/83-09/87	AKE 20870 	598266	4							
1.6i 16V 	F	10/84-09/87	AKE 20870 	598266	4							
1.6, 1.6 Auto 	F	05/83-09/87										
1.6, 1.6i 16V 	F	08/83-09/87										
1.6i 16V 	F	08/83-09/87										
1.6i 16V 	R	10/84-09/87	AKE 20076 	● 598984	0		242x9					
1.6i 16V 	R	08/83-09/87					242x9					
Corolla (90) (87>92)												
1.3 	F	05/87-08/89	AKE 20870 	598266	4		234x12,5 (11)	* 186510				
1.3, 1.6, 1.8D 	F	05/87-05/92	AKE 20870 	598266	4		238x18 (17)	186511				
1.6 	R	05/87-05/92	AKE 20076 	● 598984	0		242x9					
Corolla (100) (92>97)												
1.3 	F	05/92-04/97	AKE 20870 	598266	4		238x18 (17)	186511				
1.3, 1.6, 1.8, 2.0D 	F	05/92-04/97	AKE 21601 	598551	2		255x22 (20)	* 186701				
1.8 	R	11/92-05/95					266x9					
Corolla (110) (97>99)												
1.3i 12V 	F	04/97-09/99	AKE 23294 	598579	0		238x18 (17)	186511				
1.3i 16V 	F	04/97-09/99	AKE 23294 	598579	0		234x18					
1.3i 16V, 1.6i 16V 	F	04/97-09/99	AKE 23294 	598579	0		238x18 (17)	186511				
	F	04/97-09/99	AKE 23294 	598579	0		255x22 (20)	* 186701				
1.3i 16V, 1.6i 16V, 1.8i AWD 16V, 2.0D 	F	04/97-09/99	AKE 23294 	598579	0		255x22 (20)	* 186701				
1.3i 12V, 1.3i 16V, 1.6i 16V, 2.0D 	R	04/97-09/99	AKE 20076 	● 598984	0		266x9					
Corolla (110) (99>2001)												
1.4i, 1.6VVTi, 1.8i, 1.9D, 2.0D-4D 	F	10/99-10/01	AKE 23294 	598579	0		255x22 (20)	* 186701				
1.4i, 1.6VVTi, 1.9D 	F	11/99-10/01					255x22					
2.0D-4D 	F	08/00-10/01	AKE 23294 	598579	0							

















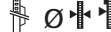

























																		
TOYOTA  (.../...)																		
Corolla (110) (99>2001) (.../...)																		
1.4i, 1.6WTi, 1.8i, 1.9D, 2.0D-4D 	R	10/99→10/01																
1.4i, 1.6WTi, 1.9D 	R	11/99→10/01	LUC 24013 	598810	2													
Corolla (120) (2001>2007)																		
1.4i, 1.6WT-i 	F	10/01→10/06	AKE 23510 	598917	2													
1.4i, 1.6WT-i, 1.8i 	F	11/01→02/07	LUC 23766 	598679	2													
1.4D4-D 	F	11/01→02/07	LUC 23766 	598679	2													
2.0D4-D 	F	11/01→02/07	LUC 23766 	598679	2													
2.0D4-D 	F	10/01→05/04	AKE 23526 	598827	0													
	F	05/04→02/07	AKE 23526 	598827	0													
1.4i, 1.6WT-i, 1.8i 	R	11/01→02/07	LUC 23816 	598680	2													
1.4i, 1.6WT-i, 2.0D4-D 	R	10/01→10/06	SUM 23521 	598577	2													
1.4D4-D, 2.0D4-D 	R	11/01→02/07	LUC 23816 	598680	2													
Corolla (150) (2006>)																		
1.4WT-i, 1.6WT-i	F	11/06→12/08	AKE 24336 	598943	0													
1.4D-4D	F	11/06→11/08	BOS 24122 	601040	0													
2.0D-4D	F	11/06→																
1.4WT-i, 1.6WT-i	R	11/06→12/08	AKE 24610 	598933	2													
1.4D-4D, 2.0D-4D	R	11/06→																
Corolla Verso (CDE1/ZZE1) (2001>2003)																		
1.6WTi	F	10/01→12/03	AKE 23510 	598917	2													
1.8WTi, 2.0D4-D	F	09/01→12/03	AKE 23526 	598827	0													
1.6WTi, 1.8WTi, 2.0D4-D	R	09/01→12/03	SUM 23521 	598577	2													
Corolla Verso (DUR/CUR/ZNR) (2004>2009)																		
1.6WTi, 1.8WTi, 2.0D4-D, 2.2D4-D	F	02/04→02/09	BOS 23768 	598665	2													
	R	02/04→02/09	BOS 23620 	598812	2													























TOYOTA (.../...)							
Corolla Verso (DUR/CUR/ZNR) (2009>)							
1.6WT-i 132, 1.8WT-i 147, 2.0D-4D 126	F 02/09→					295x26 (23) ● 197187	
2.2D-CAT 150, 2.2D-CAT 177	F 02/09→						
1.6WT-i 132, 1.8WT-i 147, 2.0D-4D 126 2.2D-CAT 150, 2.2D-CAT 177	R 02/09→						
IQ (2009>)							
1.0WT-i, 1.3WT-i, 1.4D-4D	F 01/09→						
	R 01/09→	AKE 24610	● 598933	2	259x9 (7,5) ● 197113		
MR 2 (84>89)							
1.6i	F 11/84→08/86	AKE 20870	● 598266	4	243x18		
	F 11/84→10/89	AKE 20870	● 598266	4	258x22		
	R 11/84→10/89	AKE 21759	● 598983	0	x10		
MR 2 (89>99)							
2.0i 16V	F 10/89→12/91				258x25		
	F 12/91→11/99	AKE 21961	● 598809	0	275x30		
	R 10/89→11/99	AKE 21759	● 598983	0			
MR 2 (99>2005)							
1.8WT-i	F 12/99→09/05	AKE 23510	● 598737	2	255x20 (18) ● 186766		
	R 12/99→09/05	AKE 21759	● 598983	0			
Paseo (95>99)							
1.5i	F 08/95→02/97	AKE 20870	● 598266	4	238x18 (17) ● 186875		
1.5i	F 08/95→07/99	AKE 20870	● 598266	4	254x18		
	R 12/95→07/99						
Picnic (96>2001)							
2.0i, 2.2TD	F 09/96→05/01	AKE 21601	● 598551	2	255x28 (26) ● 197167		
	F 09/96→05/01				255x28 (26) ● 197167		
Picnic (2001>2005)							
2.0D-4D, 2.0WTi	F 05/01→07/05	SUM 21961	● 598541	2	275x28 (26) ● 197166		



																										
TOYOTA  (.../...)																										
Picnic (2001>2005) (.../...)																										
2.0D-4D, 2.0VVTi (...)			R	05/01→07/05	SUM 23646 	598542	2		291x12 (10,5)	● 197018																
Previa (90>2000)																										
2.4			F	05/90→01/00	AKE 21835 	598496	0		255x25 (23)	* 186514																
			F	05/90→01/00					271x22																	
			F	05/90→01/00					279x25																	
			R	05/90→01/00					291x18																	
Previa (2000>)																										
2.0D-4D, 2.4VVTi			F	02/00→04/03					275x28 (26)	● 197166																
			F	04/03→	SUM 23759 	598710																				
			R	02/00→	SUM 23646 	598542	2		291x12 (10,5)	● 197018																
Prius (2000>2003)																										
1.5i			F	05/00→07/03	AKE 23510 	598737	2		255x25																	
			R	05/00→07/03	SUM 23521 	598577	2		269x9 (8)	186847																
Prius (2003>2009)																										
1.5i			F	08/03→03/09	AKE 23510 	● 598917	2																			
			R	08/03→03/09	SUM 23521 	598577	2		269x9																	
			P	08/03→03/09		564008																				
Prius (2009>)																										
1.8WT-i			F	04/09→																						
			R	04/09→					257x9																	
Starlet (EP/NP8) (89>95)																										
1.0, 1.3, 1.3i, 1.5D			F	01/92→12/95	AKE 20870 	598266	4		229x15,9 (14)	186874																
			F	01/92→12/95	AKE 21948 	598815	2		229x15,9 (14)	186874																
1.3i			ABS(+)	F	12/89→07/90	AKE 20870 	598266	4		230x16																
				F	12/89→07/90	AKE 21948 	598815	2		230x16																



























































										
TOYOTA  (.../...)										
Starlet (EP/NP8) (89>95) (.../...)										
1.0, 1.3, 1.3i, 1.5D	ABS(+)	F	12/89→12/95	AKE 20870 	598266	4		238x18 (17)	186875	
		F	12/89→12/95	AKE 21948 	598815	2		238x18 (17)	186875	
1.0	ABS(+)	F	12/89→12/92	AKE 20870 	598266	4		254x18		
		F	12/89→12/92	AKE 21948 	598815	2		254x18		
Starlet (EP91) (96>99)										
1.3i	ABS(-)	F	01/96→05/96	AKE 21948 	598815	2		229x15,9 (14)	186874	
	ABS(+)	F	01/96→07/99	AKE 20870 	598266	4		238x18 (17)	186875	
Supra (JZD80) (93>)										
3.0i		F	05/93→05/96	SUM 21490 	● 601023	2				
3.0i Turbo		F	05/93→01/96					323x30		
3.0i		R	05/93→05/96	SUM 23429 	● 601022	4		307x16		
3.0i Turbo		R	05/93→01/96					322x21		
Tercel (AL2) (82>88)										
1.3, 1.5 		F	05/82→01/88	AKE 20870 	598266	4				
Urban Cruiser										
1.3VWT-i 100, 1.4D-4D 90		F	01/09→	AKE 24336 	● 598943	0				
		R	01/09→	AKE 24610 	● 598933	2				
Verso (2009>)										
1.6VWT-i 132, 1.8VWT-i 147, 2.0D-4D 126		F	02/09→					295x26 (23)	● 197187	
2.2D-CAT 150, 2.2D-CAT 177		F	02/09→							
1.6VWT-i 132, 1.8VWT-i 147, 2.0D-4D 126 2.2D-CAT 150, 2.2D-CAT 177		R	02/09→							
Yaris Made in Japan (NCP1/NLP10/SCP10) (99>2005)										
1.0i, 1.3i, 1.4D-4D		F	01/99→08/05	AKE 23348 	598606	2		235x17,9 (16)	186587	
1.0i, 1.3i, 1.4D-4D, 1.5VWTi	ABS(+)	F	01/99→08/05	AKE 23510 	598737	2		255x20 (18)	186766	
		R	01/99→08/05	SUM 23521 	598577	2		269x9 (8)	186847	













































																		
TOYOTA  (.../...)																		
Yaris Made in France (NCP1/NLP10/SCP10) (2001>2005)																		
1.0i, 1.3WTi, 1.4D-4D	Rear brake Shoes	F	01/01→11/05	BOS 23340		598736	2		235x17,9 (16)	186587								
	Rear brake Discs	F	01/01→02/03	AKE 23510		598737	2		235x17,9 (16)	186587								
	Rear brake Discs	F	02/03→11/05	AKE 23510		598737	2		255x20 (18)	186766								
		R	01/01→11/05	SUM 23521		598577	2		269x9 (8)	186847								
Yaris Made in Japan (2005>)																		
1.0WTi		F	08/05→	AKE 24347		598896	0		255x22 (19)	197147								
1.8WTi		F	11/06→	SUM 24708		601052	0		275x22 (19)	197182								
1.0WTi, 1.8WTi	ESP(+)	R	08/05→	AKE 24610		598933	2		259x9 (7,5)	197113								
Yaris Made in France (2005>)																		
1.0WTi, 1.3WTi, 1.3VTi 100, 1.4D4-D		F	11/05→	ATE 24022		601026	1		258x22 (20)	197184								
	ASR(+), ESP(+)	R	11/05→	ATE 24574		601028	2		278x9 (7)	197111								
Yaris Verso (99>)																		
1.3i, 1.4D-4D, 1.5WT-i		F	08/99→	AKE 23510		598737	2		255x20 (18)	186766								
	ABS(+)	R	08/99→	SUM 23521		598577	2		269x9 (8)	186847								
TOYOTA 																		
Dyna (84>87)																		
2.0, 2.4, 3.4		F	09/84→08/87	AKE 20729		598614	0											
Dyna 100 (85>2001)																		
1.8, 2.4D		F	08/85→08/88	AKE 21158		598402	0		257x25									
		F	09/88→	AKE 21468		598947	0		257x25									
Dyna 150 (85>98)																		
2.0, 2.4, 2.8, 3.4		F	08/85→08/98						262x30									
Dyna 200 (88>95)																		
3.4, 3.7		F	08/88→05/95	AKE 20729		598614	0											
Hiace (R4/LH11) (77>83)																		
1.6, 2.0, 2.2D		F	02/77→03/83	AKE 20729		598614	0		252x20									





































































										
TOYOTA  (.../...)										
Hiace (YN/LH50-60) (82>89)										
1.8, 1.8 Auto, 2.0, 2.0 Auto, 2.2D, 2.2D Auto 2.2i, 2.2i Auto, 2.4D, 2.4D Auto	F	12/82→08/87	AKE 21158		598402	0		257x25		
2.0	F	08/86→08/87	AKE 21158		598402	0		275x28		
2.2i 4WD, 2.4D 4WD	F	08/87→08/88	AKE 21468		● 598947	0		287x22		
Hiace (89>95)										
2.0, 2.0 Auto	F	08/89→08/91						255x25		
2.4D, 2.4i, 2.4i Auto	F	08/89→07/95						255x25		
2.4D	F	08/93→07/95						285x28		
2.4D, 2.4i, 2.4i Auto	F	08/93→07/95	AKE 21468		● 598947	0		285x28		
2.4i 4WD	F	08/93→07/95	AKE 21468		● 598947	0		285x28		
Hiace (95>)										
2.4D, 2.4TD, 2.4i, 2.7i	F	08/95→05/06	AKE 21468		● 598947	0		285x28		
	ABS(+)	F	08/95→05/06	AKE 21468		● 598947	0		286x28	
2.4D, 2.4TD, 2.7i	F	08/95→05/06	AKE 21468		● 598947	0		285x28		
	ABS(+)	F	08/95→05/06	AKE 21468		● 598947	0		286x28	
2.4TD 4WD, 2.4i 4WD, 2.7i 4WD	⊕6	F	08/96→05/06	AKE 21468		● 598947	0		285x28	
2.5D-4D	F	08/01→08/06	AKE 21468		● 598947	0		285x28		
Liteace (79>95)										
1.3	F	10/79→07/88						231x18		
1.5, 1.8D, 2.0D	F	10/85→01/92						255x20		
1.5, 2.0D, 2.2	F	01/92→08/93	BDX 20635		598177	2		255x20		
	F	08/88→01/95	AKE 21835		598496	0		255x20		
U.M.M. 										
Alter 4x4										
	F	06/86→	BDX 20788		598222	0		286x22 (20,5)	186618	

















































	
VAUXHALL 	
Antara (2006>)	
2.0CDTi, 2.4i, 3.2i V6	F 10/06→ MDO 24510  ● 598942 2 296x29 (27,5) ● 197190
	R 10/06→ AKE 24498  ● 598941 2 303x20 (18,4) ● 197191
Frontera A (91>98)	
2.0i, 2.3TD, 2.4i	F 10/91→04/95 AKE 21543  598020 4 257x22 (20,6) 186488
2.0i, 2.2i, 2.5TDS, 2.8TDi	ABS(-) F 04/95→09/98 AKE 21845  598460 1 280x26 (24,6) 186585
	ABS(+) F 04/95→09/98 AKE 21845  598460 1 280x26 (24,6) ● 197223
	R 04/95→09/98 SUM 21875  598507 2 313x18 (16,6) 186685
	P 04/95→09/98 564009
Frontera B (98>2005)	
2.2DTi, 2.2i, 3.2i V6	ABS(-) F 10/98→07/05 AKE 23250  598661 2 280x26 (24,6) 186585
	ABS(+) F 10/98→07/05 AKE 23250  598661 2 280x26 (24,6) ● 197223
	R 10/98→07/05 SUM 21875  598507 2 313x18 (16,6) 186685
	P 10/98→05/02 564009
Monterey A (94>99)	
3.1TD, 3.2i	ABS(-) F 05/94→06/98 AKE 21845  598460 1 280x26 (24,6) 186585
	ABS(+) F 05/94→06/98 AKE 21845  598460 1 280x26 (24,6) ● 197223
	R 05/94→06/98 SUM 21875  598507 2 313x18 (16,6) 186685
Monterey B (98>99)	
3.0DTi, 3.5i V6	ABS(-) F 07/98→08/99 AKE 21845  598460 1 280x26 (24,6) 186585
	ABS(+) F 07/98→08/99 AKE 21845  598460 1 280x26 (24,6) ● 197223
	R 07/98→08/99 SUM 21875  598507 2 313x18 (16,6) 186685
VAUXHALL 	
Agila (2000>2007)	
1.0i, 1.2i  3G002367,3G002706	F 06/00→ BOS 23253  598453 2 247x12 (10) 186784
1.0i Twinport 1.2i Twinport 1.3CDTi  3G002368,3G002707	F →12/07 BOS 23253  598453 2 253x17 (15) 186805























































											
VAUXHALL  (.../...)											
Agila (2007>)											
1.0i, 1.2i, 1.3CDTi	F	12/07→	LUC 23973		598847	1		252x20 (18)	●	197066	
Astra MK I (80>84)											
1.2, 1.3  	F	02/80→10/84	20867		598182	0		236x9 (7)		186186	186947
1.2, 1.3, 1.6, 1.6D  	F	02/80→10/84	20867		598182	0		238x11			
1.6, 1.6D, 1.8i GTE  	F	12/81→10/84	20867		598182	0		236x19,9 (17)		186188	
Astra MK II (84>91)											
1.2, 1.3, 1.4i  	F	10/84→09/91	20867		598182	0		236x9 (7)		186186	186947
1.2, 1.3, 1.6, 1.6D, 1.6i, 1.7D, 1.8i   	F	10/84→10/91	20867		598182	0		238x11			
1.8i  	F	10/84→09/91	ATE 21201		598184	0		238x11			
1.2, 1.3, 1.6, 1.6D, 1.6i, 1.7D, 1.8i   	F	10/84→10/91	20867		598182	0		236x12,6 (9,7)		186187	
1.8i  	F	10/84→09/91	ATE 21201		598184	0		236x12,6 (9,7)		186187	
1.6, 1.6D, 1.6i, 1.7D, 1.8i   	F	10/84→09/91	20867		598182	0		236x19,9 (17)		186188	
1.8i  	F	10/84→09/91	ATE 21201		598184	0		236x19,9 (17)		186188	186946
1.8i, 2.0i   	F	10/84→09/91	20867		598182	0		256x23,9 (21)		186189	
	F	10/84→09/91	ATE 21201		598184	0		256x23,9 (21)		186189	186932
2.0i  	R	03/87→09/91	ATE 21140		598253	0		261x10 (8)	*	186302	
Astra Belmont (86>91)											
1.3, 1.4i	F	01/86→09/91	20867		598182	0		236x9 (7)		186186	186947
1.5DT, 1.6, 1.6D, 1.7D	F	01/86→09/91	20867		598182	0		238x11			
	F	01/86→09/91	20867		598182	0		236x12,6 (9,7)		186187	
1.8i	F	01/86→09/91	ATE 21201		598184	0		236x19,9 (17)		186188	186946
Astra MK III (91>2001)											
1.6i 	F	06/93→06/95	ATE 21201		598184	0		238x11			
1.4i, 1.6i  	F	06/93→03/98	ATE 21353		598356	2		238x11			
1.4i, 1.6i   	 T5000073	F	10/91→	ATE 21201		0		236x12,6 (9,7)		186187	
	 T5000073	F	09/91→	ATE 21353		2		236x12,6 (9,7)		186187	186924















































									
VAUXHALL  (.../...)									
Astra MK III (91>2001) (.../...)									
1.4i, 1.6i, 1.7D 1.7TD Turbo 	 T5000074	F	→03/01	ATE 21201 	598184	0	 236x19,9 (17)	186188	186946
	 T5000074	F	→03/01	ATE 21353 	598356	2	 236x19,9 (17)	186188	
1.8i 		F	10/91→07/94	ATE 21353 	598356	2	 256x19,9 (17)	186282	
1.4i, 1.6i, 1.7TD Turbo, 1.8i, 2.0i 		F	09/91→03/01	ATE 21201 	598184	0	 256x23,9 (21)	186189	186932
1.4i, 1.6i 		F	10/91→03/01	ATE 21353 	598356	2	 256x23,9 (21)	186189	
1.4, 1.4i, 1.6i, 1.7D, 1.7TD Turbo, 1.8i 2.0i 		R	09/91→03/01	ATE 21140 	598253	0	 260x10 (8)	186490	
		R	09/91→03/01	LUC 23417 	598584	2	 260x10 (8)	186490	
Astra MK IV (98>2005)									
1.2i 		F	04/98→02/04	ATE 23063 	598322	4	 256x11 (8)	186591	
1.2i, 1.4i, 1.6i, 1.6i Twinport, 1.7CDTi 1.7D Turbo, 1.7DTi, 1.8i, 1.8i LPG 2.0Di 		F	02/98→12/05	ATE 23063 	598322	4	 256x24 (21)	186592	
1.6i GNV, 2.0i, 2.2i 		F	04/98→12/05	ATE 23062 	598454	2	 280x25 (22)	186684	
1.6i, 1.6i Twinport, 1.8i 1.8i LPG, 2.0Di, 2.0TDi 	ABS(+)	F	04/98→12/05	ATE 23063 	598322	4	 280x25 (22)	186684	
2.0SRi Turbo 		F	04/02→02/04	ATE 23116 	598475	2	 308x25 (23)	197244	
1.2i, 1.4i, 1.6i, 1.6i GNV, 1.6i Twinport 1.7CDTi, 1.7D Turbo, 1.7DTi, 1.8i, 1.8i LPG 2.0Di 		R	02/98→12/05	LUC 23417 	598584	2	 240x10 (8)	186594	
		R	02/98→12/05	BOS 23258 	598926	2(A)	 240x10 (8)	186594	
1.8i, 1.8i LPG, 2.0Di 2.0SRi Turbo, 2.0TDi, 2.0i 2.2i 	ABS(+)	R	04/98→12/05	LUC 23417 	598584	2	 263,4x10 (8)	186593	
	ABS(+)	R	04/98→12/05	BOS 23258 	598926	2(A)	 263,4x10 (8)	186593	
Astra MK V (2004>)									
1.3CDTi, 1.4 Twinport 1.4i Twinport, 1.7CDTi 	⊗4	F	03/04→	ATE 23832 	598860	2	 280x25 (22)	186869	















































															
VAUXHALL  (.../...)															
Astra MK V (2004>) (.../...)															
1.3CDTi, 1.4 Twinport 1.4i Twinport, 1.6i, 1.6i Twinport 1.7CDTi, 1.8i 	⊗5	F	03/04→	ATE 23832 	598860	2		280x25 (22)	186684						
1.6i Turbo, 1.7CDTi, 1.9CDTi, 2.0T 2.0i Turbo 	⊗5	F	03/04→	ATE 23832 	598860	2		308x25 (23)	● 197244						
2.0i Turbo VXR 	⊗5	F	03/05→	ATE 23402 	598678	0		321x28 (25)	● 197150						
1.3CDTi, 1.4 Twinport 1.4i Twinport 	⊗4	R	03/04→	LUC 23417 	598584	2		240x10 (8)	186594						
1.3CDTi, 1.4 Twinport 1.4i Twinport, 1.6i, 1.6i Turbo 1.6i Twinport, 1.7CDTi, 1.8i 1.9CDTi, 2.0T, 2.0i Turbo 	⊗5	R	03/04→	LUC 23417 	598584	2		263,4x10 (8)	186593						
2.0i Turbo VXR 	⊗5	R	03/05→	LUC 23417 	598584	2		278x10							
Astra MK VI (2009>)															
1.3CDTi ecoFLEX, 1.4i 100 1.4i 87, 1.4i Turbo, 1.6i 1.6i Turbo, 1.7CDTi 1.7CDTi 110, 2.0CDTi	⊗ 15", 16"	F	09/09→												
	⊗ 15", 16"	R	09/09→												
Calibra (90>97)															
2.0i, 2.0i 16V, 2.0i 4x4 16V		F	06/90→06/97	ATE 21201 	598184	0		256x23,9 (21)	186189	186932					
		F	06/90→06/97	ATE 21829 	598305	0		256x23,9 (21)	186189						
2.0i 4x4 Turbo, 2.5i V6		F	04/92→06/96	ATE 21411 	598050	431836		284x24 (21)	186496						
2.5i V6		F	08/93→06/96	ATE 21829 	598305	0		284x24 (21)	186496						
		F	08/93→06/96	ATE 21411 	598050	431836		288x25 (21)	● 197226						
2.0i 4x4 Turbo, 2.5i V6, 2.5i V6 24V		F	08/93→07/97	ATE 21829 	598305	0		288x25 (21)	● 197226						
2.0i, 2.0i 16V, 2.0i 4x4 16V		R	06/90→06/97	ATE 21140 	598253	0		270x10							
2.5i V6		R	08/93→06/95	ATE 21140 	598253	0		270x10							
		R	07/95→07/97	ATE 21051 	598183	0		270x10							



																		
VAUXHALL  (.../...)																		
Calibra (90>97) (.../...)																		
2.0i 4x4 Turbo	R	04/92→07/97	ATE 21140		598253	0		270x10										
Carlton (78>86)																		
1.8, 2.0, 2.3D	F	01/78→10/86	ATE 20588		598108	0		246x12,6										
	F	01/78→10/86	20867		598182	0		246x12,6										
1.8, 2.0, 2.0i	F	01/78→10/86	ATE 20588		598108	0		246x20										
	F	01/78→10/86	20867		598182	0		246x20										
1.8, 2.0, 2.0i, 2.2i, 2.3D	ABS(+)	F	01/78→10/86	ATE 20588		598108	0		246x23									
	ABS(+)	F	01/78→10/86	20867		598182	0		246x23									
2.2i	F	08/85→08/86	ATE 20588		598108	0		246x23										
	F	08/85→08/86	20867		598182	0		246x23										
Carlton (86>94)																		
1.8, 1.8i, 2.0i			 K1000098,L1019854	F	11/86→	20867		598182	431845			258x12,6 (9,7)	* 186192					
2.3D																		
2.3TD Turbo																		
1.8, 1.8i, 2.3D			 K1000098,L1019854	F	11/86→	ATE 21201		598184	431845			258x12,6 (9,7)	* 186192					
2.3TD Turbo																		
1.8, 1.8i, 2.0i			 K1000099,L1019855	F	→05/94	ATE 21201		598184	431845			258x23,9 (21)	186191					
2.3D																		
2.3TD Turbo																		
3.0i			 L1999999	F	03/87→	ATE 21226		* 598186	0			280x24 (21)	* 186625					
			 L2000000	F	→05/94	LUC 21368		598256	0			296x28 (25)	● 197225					
2.6i				F	09/90→05/94	LUC 21368		598256	0			296x28 (25)	● 197225					
3.6 Lotus				F	09/90→05/94							296x28 (25)	● 197225					
1.8, 1.8i, 2.0i			 K1000098	R	11/86→	ATE 21051		598243	0			270x10 (8)	* 186190					
1.8, 1.8i, 2.0i, 2.3D			 K1000099	R	→05/94	ATE 21051		598183	0			270x10 (8)	* 186190					
2.3TD Turbo, 2.6i, 3.0i																		
3.6 Lotus				R	09/90→05/94							271x12,7						









								
VAUXHALL  (.../...)								
Cavalier (75>81)								
1.3, 1.6, 1.9, 2.0	F	10/75→07/81	ATE 20588 	598108	0	 246x12,6		
	F	10/75→07/81	20867 	598182	0	 246x12,6		
Cavalier (81>88)								
1.3, 1.6, 1.6D, 1.8i 	F	08/81→08/88	20867 	598182	0	 238x11		
	F	08/81→08/88	20867 	598182	0	 236x12,6 (9,7)	186187	
1.8i, 2.0i 	F	10/82→08/88	20867 	598182	0	 236x19,9 (17)	186188	
2.0i 	F	04/87→08/88	20867 	598182	0	 256x23,9 (21)	186189	
Cavalier (88>95)								
1.7D Turbo	F	09/91→10/95	ATE 21201 	598184	0	 238x11		
1.4, 1.6, 1.8	F	10/88→1991	20867 	598182	0	 238x11		
1.7D	F	09/92→10/95	ATE 21353 	598356	2	 238x11		
1.7D Turbo	F	09/91→10/95	ATE 21201 	598184	0	 236x12,6 (9,7)	186187	
1.7D	F	09/92→10/95	ATE 21353 	598356	2	 236x12,6 (9,7)	186187	186924
1.4, 1.6, 1.6i, 1.7D	F	09/92→10/95	ATE 21353 	598356	2	 236x19,9 (17)	186188	
1.7D Turbo	F	09/91→10/95	ATE 21201 	598184	0	 256x19,9 (17)	186282	
1.7D, 1.8i	F	09/90→10/95	ATE 21353 	598356	2	 256x19,9 (17)	186282	
2.0i	F	10/88→10/95	ATE 21201 	598184	0	 256x23,9 (21)	186189	186932
2.0i Turbo, 2.5i V6	F	09/92→07/94	ATE 21411 	598050	431836	 284x24 (21)	186496	
1.4, 1.6, 1.6i, 1.7D, 1.8, 1.8i	F	11/88→10/95	ATE 21353 	598356	2			
1.4, 1.6, 1.8		▶  N5000000	F 10/88→1991	20867 	598182	0		
1.6i, 1.7D Turbo, 1.8i, 2.0i		▶  S5000001	F 10/88→10/95	ATE 21201 	598184	0		
1.4, 1.6, 1.6i, 1.7D		▶  N5000001	F 10/88→10/95				 236x19,9 (17)	186188
1.4, 1.6, 1.7D, 1.7D Turbo		▶  N5000000	F 10/88→				 236x12,6 (9,7)	186187
1.8, 1.8i		▶  N5000000	F 10/88→10/95				 238x11	





























																		
VAUXHALL  (.../...)																		
Cavalier (88>95) (.../...)																		
1.7D, 1.7D Turbo, 1.8, 1.8i		F	11/88→10/95										256x19,9 (17)	186282				
2.0i		F	10/88→10/95										256x23,9 (21)	186189				
		R	10/88→	ATE 21140		598253	0						261x10 (8)	* 186302				
		R	→10/95	ATE 21140		598253	0						260x10 (8)	186490				
2.0i, 2.0i Turbo		R	12/88→	ATE 21140		598253	0						270x10					
2.5i V6		R	03/93→07/94	ATE 21140		598253	0						260x10 (8)	* 186497				
2.0i Turbo		R	09/92→07/94	ATE 21140		598253	0						270x10					
Corsa MK I (93>2000)																		
1.0i, 1.2i, 1.4i, 1.5D, 1.5D Turbo, 1.7D 		F	04/93→08/00	ATE 21353		598356	2						238x11					
		F	04/93→08/00	ATE 21353		598356	2						236x12,6 (9,7)	186187	186924			
1.2i, 1.4i, 1.7D  		F	04/93→08/00	ATE 21353		598356	2						236x19,9 (17)	186188				
1.6i Gsi 		F	08/93→08/00	ATE 21353		598356	2						256x19,9 (17)	186282				
Corsa MK II (2000>2003)																		
1.0i, 1.2i  	ABS(-)	F	09/00→08/03	LUC 23225		598456	2						240x11 (8)	186757				
1.0i, 1.2i, 1.7Di  	ABS(+)	F	09/00→08/03	LUC 23225		598456	2						240x20 (17)	186790				
1.4i, 1.7DTi, 1.8i  		F	09/00→08/03	LUC 23225		598456	2						260,5x24 (22,4)	186759				
1.4i, 1.8i 	ESP(+)	R	09/00→08/03	LUC 23284		598457	2						240x10,2 (8,2)	186791				
Corsa MK II (2003>2006)																		
1.0i, 1.0i Twinport, 1.2i 1.2i Dualfuel 	ABS(-)	F	09/03→10/06	LUC 23225		598456	2						240x11 (8)	186757				
	ABS(+)	F	09/03→10/06	LUC 23225		598456	2						240x20 (17)	186790				
1.3CDTi, 1.4i Twinport, 1.8i  		F	09/03→10/06	LUC 23225		598456	2						260,5x24 (22,4)	186759				
1.7CDTi 		F	09/03→10/06	ATE 23832		598860	2						280x25 (22)	186684				
1.4i Twinport, 1.8i 	ESP(+)	R	09/03→10/06	LUC 23284		598457	2						240x10,2 (8,2)	186791				
Corsa MK III (2006>)																		
1.0i		F	07/06→	BOS 23982		598825	1						257x12 (10)	● 197028				









































													
													
VAUXHALL  (.../...)													
Corsa MK III (2006>) (.../...)													
1.0i, 1.2i, 1.3CDTi 75, 1.4i, 1.6i	F	07/06→	BOS 23982		598825	1		257x22 (20)	●	197044			
1.3CDTi 90	F	07/06→	BOS 23708		598839	1		284x22 (20)	●	197045			
1.7CDTi	F	07/06→						278x26 (23)	●	197149			
1.6i OPC	F	02/07→	ATE 23832		598860	2		308x25 (23)	●	197244			
1.6i OPC, 1.7CDTi	R	07/06→	BOS 24349		598722	0		264x10					
Insignia (2009>)													
1.8i, 2.0CDTi	⊙ 16"	F	01/09→	MDO 24415		● 601047	2		296x30				
1.6i Turbo, 1.8i, 2.0CDTi	⊙ 17"	F	01/09→	MDO 24412		● 601046	2		321x30				
1.6i Turbo, 1.8i, 2.0CDTi	⊙ 18", 19"	F	01/09→	24418		● 601048	2		337x30				
2.0i Turbo, 2.8i V6 Turbo	⊙ 16", 17", 18", 19"	R	01/09→	24421		● 601049	4		315x23				
Meriva (2003>)													
1.4i Twinport, 1.6i	⊙ 4	F	05/03→	LUC 23225		598456	2		260,5x24 (22,4)		186759		
1.3CDTi, 1.6i, 1.7CDTi, 1.7DTi 1.8i	⊙ 4	F	05/03→	ATE 23832		598860	2		280x25 (22)		186869		
1.3CDTi, 1.4i Twinport, 1.6i 1.7CDTi, 1.7DTi, 1.8i	⊙ 5	F	05/03→	ATE 23832		598860	2		280x25 (22)		186684		
1.6i Turbo	⊙ 5	F	03/06→	ATE 23832		598860	2		308x25 (23)	●	197244		
1.4i Twinport, 1.6i	⊙ 4	R	05/03→	LUC 23417		598584	2		240x10 (8)		186594		
1.3CDTi, 1.6i, 1.7CDTi, 1.7DTi 1.8i	⊙ 4	R	05/03→	LUC 23417		598584	2		264x10 (8)		186855		
1.3CDTi, 1.4i Twinport, 1.6i 1.6i Turbo, 1.7CDTi, 1.7DTi, 1.8i	⊙ 5	R	05/03→	LUC 23417		598584	2		263,4x10 (8)		186593		
Meriva (2010>)													
1.3CDTi, 1.4Turbo (eng 88KW), 1.4i 1.7CDTi (eng 74/81KW)	F	05/10→	ATE 23832		598860	2		280x25 (22)		186684			
1.4Turbo (eng 103KW), 1.7CDTi (eng 96KW)	F	05/10→	ATE 23832		598860	2		308x25 (23)	●	197244			







































															
VAUXHALL  (.../...)															
Meriva (2010>) (.../...)															
1.3CDTi, 1.4Turbo (eng 88/103KW), 1.4i 1.7CDTi (eng 74/81/96KW)		R	05/10→	LUC 23417 	598584	2		 263,4x10 (8)	186593						
Nova (83>93)															
1.0, 1.2, 1.2i, 1.3, 1.4, 1.4i		F	04/83→03/93	20867 	598182	0		 236x9 (7)	186186	186947					
1.5D, 1.5TD		F	09/89→03/93	20867 	598182	0		 238x11							
		F	09/89→03/93	20867 	598182	0		 236x12,6 (9,7)	186187						
1.6i		F	05/88→08/90	20867 	598182	0		 236x19,9 (17)	186188						
1.4, 1.6i		F	02/92→03/93	ATE 21353 	598356	2		 236x19,9 (17)	186188						
Omega (94>)															
2.0Di		F	01/98→09/00	LUC 21368 	598256	0		 271x13							
2.5TDi		F	09/01→	LUC 21368 	598256	0		 271x13							
2.0i		F	04/94→	ATE 21411 	598050	431834		 286x24							
		F	04/94→	LUC 21368 	598256	0		 286x24							
		CU(+)	04/94→	ATE 21411 	598050	431836		 296x28 (25)	● 197225						
2.0Di, 2.0i, 2.2DTi, 2.2i, 2.5TD, 2.5TDi 2.5i V6, 2.6i V6, 3.0i, 3.0i V6, 3.2i V6		F	04/94→	LUC 21368 	598256	0		 296x28 (25)	● 197225						
2.5TDi		F	09/01→	LUC 21368 	598256	0		 296x28 (25)	● 197225						
2.0Di, 2.0i, 2.2DTi, 2.2i 2.5TD, 2.5i V6, 2.6i V6 3.0i, 3.0i V6, 3.2i V6		►  Y1007789	R	04/94→				 286x12							
		►  Y1007789	R	04/94→				 286x20							
2.0Di, 2.0i, 2.2DTi, 2.2i 2.5TD, 2.5TDi, 2.5i V6 2.6i V6, 3.0i, 3.0i V6 3.2i V6		 Y1007790	R		ATE 21051 	598183	0	 286x12							
		 Y1007790	R		ATE 21051 	598183	0	 286x20							
Royale (78>82)															
2.8, 3.0		F	01/78→12/82	ATE 20011 	* 598111	0									



















































		
VAUXHALL  (.../...)		
Senator B (87>93)		
2.5i, 3.0i	 L1999999	F 09/87→ ATE 21226  * 598186 0  280x24 (21) * 186625
2.5i, 2.6i, 3.0i	 M1000001	F -08/93 LUC 21368  598256 0  296x28 (25) ● 197225
		R 09/87-08/93 ATE 21051  598183 0  270x10 (8) * 186190
Signum A (2003>2005)		
1.8i, 1.9CDTi, 2.0DTi, 2.2DIG, 2.2DTi		F 06/03-09/05 ATE 23402  598678 0  285x24,9 (22,2) 186881
1.8i, 1.9CDTi, 2.0i Turbo, 2.2DIG, 2.2DTi		F 06/03-09/05 ATE 23402  598678 0  302x28 (25) 186880
3.0CDTi V6, 3.2i V6	 31068238	F 06/03→ ATE 23402  598678 0  302x28 (25) 186880
	 31068239	F -09/05 ATE 20224  598808 0  314x28
1.8i, 1.9CDTi, 2.0DTi, 2.2DIG, 2.2DTi		R 06/03-09/05 ATE 24137  598783 0  278x11,9 (10) 186854
1.8i, 1.9CDTi, 2.0i Turbo, 2.2DIG, 2.2DTi 3.0CDTi V6, 3.2i V6		R 06/03-09/05 ATE 24137  598783 0  292x19,9 (18) 186882
		R 06/03-09/05 ATE 23482  598472 0  292x19,9 (18) 186882
Signum B (2005>2008)		
1.8i, 1.9CDTi, 2.2DIGi		F 10/05-11/08 ATE 23402  598678 0  285x24,9 (22,2) 186881
2.0i Turbo		F 10/05-11/08 ATE 23402  598678 0  302x28 (25) 186880
2.8i V6 Turbo, 3.0CDTi V6		F 10/05-11/08 ATE 20224  598808 0  314x28
1.8i, 1.9CDTi, 2.2DIGi		R 10/05-11/08 ATE 24137  598783 0  278x11,9 (10) 186854
2.0i Turbo, 2.8i V6 Turbo, 3.0CDTi V6		R 10/05-11/08 ATE 24137  598783 0  292x19,9 (18) 186882
Sintra (96>99)		
2.2TDi, 2.2i, 3.0i V6		F 03/96-12/99 23358  598458 2  278x32,2 (30,7) ● 197004
		R 03/96-12/99 AKE 23361  598459 2  257x22 (20,6) 186488
Tigra (94>2001)		
1.4i, 1.6i		F 11/94-01/01 ATE 21353  598356 2  256x19,9 (17) 186282
Tigra Twintop (2004>2008)		
1.3CDTi Twinport, 1.4i Twinport, 1.8i		F 07/04-07/08 LUC 23225  598456 2  260,5x24 (22,4) 186759
1.8i		R 07/04-07/08 LUC 23284  598457 2  240x10,2 (8,2) 186791















































										
VAUXHALL  (.../...)										
Vectra (95>2002)										
1.6i, 1.7TD, 1.8i, 2.0DTI, 2.0Di	F	10/95→03/02	ATE 21201 	598184	0	 256x23,9 (21)	186189	186932		
1.8i	F	10/95→03/02	ATE 21829 	598305	0	 256x23,9 (21)	186189			
1.8i, 2.0i, 2.2DTI, 2.2i	F	10/95→03/02	ATE 21201 	598184	0	 288x25 (21)	● 197226			
1.8i, 2.0i, 2.2DTI, 2.2i, 2.5i V6, 2.6i V6	F	10/95→03/02	ATE 21829 	598305	0	 288x25 (21)	● 197226			
2.0i, 2.5i V6	F	10/95→03/02	ATE 21829 	598305	0	 308x25 (23)	● 197244			
1.6i, 1.7TD, 1.8i, 2.0DTI, 2.0Di	R	10/95→03/02	ATE 21051 	598183	0	 270x9,9 (8)	186565			
1.8i, 2.0DTI, 2.0i, 2.2DTI, 2.2i, 2.5i V6 2.6i V6	R	10/95→03/02	ATE 21051 	598183	0	 286x10 (8)	* 186566			
Vectra (2002>2005)										
1.6i, 1.8i, 1.8i LPG, 1.9CDTI, 2.0DTI, 2.2DGI 2.2DTI, 2.2i	F	04/02→09/05	ATE 23402 	598678	0	 285x24,9 (22,2)	186881			
2.0i Turbo	F	05/03→09/05	ATE 23402 	598678	0	 302x28 (25)	186880			
3.0CDTi V6, 3.2i V6	F	04/02→	ATE 23402 	598678	0	 302x28 (25)	186880			
	F	→09/05	ATE 20224 	598808	0	 314x28				
1.6i, 1.8i, 1.8i LPG, 1.9CDTI, 2.0DTI 2.0i Turbo, 2.2DGI, 2.2DTI, 2.2i	R	04/02→09/05	ATE 24137 	598783	0	 278x11,9 (10)	186854			
1.8i, 1.9CDTI, 2.0DTI, 2.0i Turbo, 2.2DTI 2.2i	R	04/02→09/05	ATE 23482 	598472	0	 278x11,9 (10)	186854			
3.0CDTi V6, 3.2i V6	R	04/02→09/05	ATE 24137 	598783	0	 292x19,9 (18)	186882			
	R	04/02→09/05	ATE 23482 	598472	0	 292x19,9 (18)	186882			
Vectra (2005>2009)										
1.6i, 1.8i, 1.9CDTI, 2.2DGI	F	10/05→02/09	ATE 23402 	598678	0	 285x24,9 (22,2)	186881			
2.0i Turbo	F	10/05→02/09	ATE 23402 	598678	0	 302x28 (25)	186880			
2.8i V6 Turbo, 3.0CDTi V6	F	10/05→02/09	ATE 20224 	598808	0	 314x28				
1.6i, 1.8i, 1.9CDTI, 2.2DGI	R	10/05→	ATE 24137 	598783	0	 278x11,9 (10)	186854			
	R	→02/09	ATE 23482 	598472	0	 278x11,9 (10)	186854			





































































													
					WVA	Valeo					Valeo	Valeo	
VAUXHALL  (.../...)													
Vectra (2005>2009) (.../...)													
2.0i Turbo, 2.8i V6 Turbo	 71041573	R	10/05→	ATE 24137 	598783	0		292x19,9 (18)	186882				
3.0CDTI V6													
	 71041574	R	→02/09	ATE 23482 	598472	0		292x19,9 (18)	186882				
Viceroy (80>81)													
2.5		F	10/80→07/81	ATE 20011 	* 598111	0							
VX 220 (2000>)													
2.0i Turbo		F	05/04→										
		R	05/04→										
2.2i		F	08/00→										
		R	08/00→										
Zafira I (99>2003)													
1.6i, 1.6i GNV, 1.8i, 2.0Di, 2.2DTI, 2.2i		F	05/99→06/03	ATE 23062 	598454	2		280x25 (22)	186684				
2.0i Turbo		F	10/01→06/03	ATE 23116 	598475	2		308x25 (23)	● 197244				
1.8i, 2.0Di, 2.0i Turbo, 2.2DTI, 2.2i		R	05/99→06/03	LUC 23417 	598584	2		263,4x10 (8)	186593				
1.6i, 1.6i GNV, 1.8i, 2.0Di, 2.0i Turbo 2.2DTI, 2.2i		R	05/99→06/03	BOS 23258 	● 598926	2(A)		263,4x10 (8)	186593				
Zafira I (2003>2005)													
1.6i, 1.6i GNV, 1.8i, 2.0DTI, 2.2DTI, 2.2i		F	07/03→06/05	ATE 23062 	598454	2		280x25 (22)	186684				
2.0i Turbo		F	07/03→06/05	ATE 23116 	598475	2		308x25 (23)	● 197244				
1.6i GNV, 1.8i, 2.0DTI, 2.0i Turbo, 2.2DTI 2.2i		R	07/03→06/05	LUC 23417 	598584	2		263,4x10 (8)	186593				
1.6i, 1.6i GNV, 1.8i, 2.0DTI, 2.0i Turbo 2.2DTI, 2.2i		R	07/03→06/05	BOS 23258 	● 598926	2(A)		263,4x10 (8)	186593				
Zafira II (2005>2009)													
1.6i Twinport, 1.8i		F	07/05→02/09	ATE 23832 	598860	2		280x25 (22)	186684				
1.7CDTI, 1.9CDTI, 2.0i Turbo, 2.2i		F	07/05→02/09	ATE 23832 	598860	2		308x25 (23)	● 197244				
2.0i Turbo VXR		F	07/05→02/09	ATE 23402 	598678	0		321x28 (25)	● 197150				
1.6i Twinport, 1.7CDTI, 1.8i, 1.9CDTI, 2.2i		R	07/05→02/09	LUC 23417 	598584	2		263,4x10 (8)	186593				































































																				
VAUXHALL  (.../...)																				
Zafira II (2005>2009) (.../...)																				
2.0i Turbo VXR			R	07/05→02/09	LUC 23417 	598584	2		278x10											
Zafira II (2009>)																				
1.6i, 1.8i WT			F	02/09→	ATE 23832 	598860	2		280x25 (22)		186684									
1.9CDTi, 2.0i, 2.2i			F	02/09→	ATE 23832 	598860	2		308x25 (23)		197244									
2.0i VXR			F	02/09→	ATE 23402 	598678	0		321x28 (25)		197150									
1.6i, 1.8i WT, 1.9CDTi, 2.0i, 2.2i			R	02/09→	LUC 23417 	598584	2		263,4x10 (8)		186593									
2.0i VXR			R	02/09→	LUC 23417 	598584	2		278x10											
VAUXHALL 																				
Arena (98>2001)																				
1.9D, 2.5D			F	03/98→08/01	BDX 20928 	598086	0		252,5x24 (22)		186218									
Astramax (91>98)																				
1.4, 1.4i, 1.6i, 1.7D, 1.7D Turbo, 1.8i			F	10/91→03/98	LUC 23225 	598456	2		260,5x24 (22,4)		186759									
Brava (88>96)																				
2.2D, 2.3, 2.5D, 2.5TD			F	10/88→06/96	AKE 21543 	598020	4		257x22 (20,6)		186488									
Brava (96>)																				
2.5TD			F	07/96→	AKE 21543 	598020	4		257x22 (20,6)		186488									
Combo (93>2001)																				
1.4i, 1.7D			F	10/93→09/01	ATE 21353 	598356	2		246x12,6											
			F	10/93→09/01	ATE 21353 	598356	2		236x19,9 (17)		186188									
Combo (2001>)																				
1.3CDTi, 1.4i GPL Twinport			 43999999	F	10/01→	LUC 23225 	598456	2		260,5x24 (22,4)		186759								
1.4i Twinport, 1.6i																				
1.6i GPL, 1.7CDTi, 1.7DTi																				
1.7Di																				
			 53000001	F		ATE 23832 	598860	2		260,5x24 (22,4)		186759								
1.3CDTi, 1.4i GPL Twinport, 1.4i Twinport																				
1.6i, 1.6i GPL, 1.7DTi, 1.7Di																				
1.7CDTi			R	07/04→	LUC 23417 	598584	2		263,4x10 (8)		186593									

															
VAUXHALL  (.../...)															
Movano (98>2003)															
1.9Dti, 2.2Dti, 2.5D, 2.5Dti 2.8Dti	⊙ 15"	F	10/98→09/03	BDX 23302		598490	0		280x24 (21)	186688					
	⊙ 16"	F	10/98→09/03	BOS 23613		598537	0		306x28 (25)	186868					
		R	07/00→09/03	BOS 23669		598538	0		305x12 (10,5)	186740					
Movano (2003>2006)															
1.9DTi, 2.2DTi, 2.5D, 2.5DTi 3.0CDTi	⊙ 15"	F	10/03→10/06	BDX 23302		598490	0		280x24 (21)	186688					
	⊙ 16"	F	10/03→10/06	BOS 23613		598537	0		306x28 (25)	186868					
		R	10/03→10/06	BOS 23669		598538	0		305x12 (10,5)	186740					
Movano (2006>)															
2.5CDTi	⊙ 15"	F	10/06→	BDX 23302		598490	0		280x24 (21)	186688					
	⊙ 16"	F	10/06→	BOS 23613		598537	0		306x28 (25)	186868					
		R	10/06→	BOS 23669		598538	0		305x12 (10,5)	186740					
Movano (2010>)															
2.3CDTi 100, 2.3CDTi 125 , 2.3CDTi 146 2.3CDTi 150		F	05/10→						302x28						
2.3CDTi 100, 2.3CDTi 125 , 2.3CDTi 146 2.3CDTi 150 traction		R	05/10→						305x12						
2.3CDTi 100, 2.3CDTi 125 , 2.3CDTi 146 2.3CDTi 150 propulsion		R	05/10→						305x12						
2.3CDTi 100, 2.3CDTi 125 , 2.3CDTi 146 2.3CDTi 150 (double Wheel) propulsion		R	05/10→						305x18						
Vivaro (2001>2006)															
1.9Di, 1.9DTi, 2.0i, 2.5DTi		F	08/01→06/06	LUC 23099		598545	0		305,5x28 (24)	186712	●186987				
	Bearing Roulement (-)	R	08/01→06/06	LUC 21748		598546	O(A)		280x12 (10)	186713					
	Bearing Roulement (+)	R	08/01→06/06	LUC 21748		598546	O(A)		280x12 (10)	●197001					
Vivaro (2006>)															
2.0CDTi, 2.5CDTi		F	07/06→	LUC 23099		598545	0		305,5x28 (24)	186712	●186987				

















































															
VAUXHALL  (.../...)															
Vivaro (2006>) (.../...)															
2.0CDTi, 2.5CDTi (...)		Bearing Roulement (-)	R	07/06→	LUC 21748 	598546	0(A)		280x12 (10)	186713					
		Bearing Roulement (+)	R	07/06→	LUC 21748 	598546	0(A)		280x12 (10)	● 197001					
VOLKSWAGEN 															
Tiguan (2007>)															
1.4TSi, 2.0FSi, 2.0TDi, 2.0TFSi, 2.0TSi			F	11/07→	ATE 24333 	● 601036	1		312x25 (22)	● 197242					
			R	11/07→					286x12 (10)	● 197031					
Touareg I (2002>2006)															
2.5TDi			F	01/03→11/06	ATE 23467 	● 598940	2		308x29,5 (25,5)	186756					
3.0TDi V6		Left disc	F	11/04→05/05	BBO 23692 	598655	0		330x32 (30)	● 197087					
		Right disc	F	11/04→05/05	BBO 23692 	598655	0		330x32						
		Left disc	F	06/05→11/06	BBO 24098 	● 598994	0		330x32 (30)	● 197087					
		Right disc	F	06/05→11/06	BBO 24098 	● 598994	0		330x32						
3.2i V6			Left disc	F	11/02→05/05	BBO 23692 	598655	0		330x32 (30)	● 197087				
			Right disc	F	11/02→05/05	BBO 23692 	598655	0		330x32					
			Left disc	F	06/05→11/06	BBO 24098 	● 598994	0		330x32 (30)	● 197087				
			Right disc	F	06/05→11/06	BBO 24098 	● 598994	0		330x32					
3.6FSi V6			Left disc	F	10/05→11/06	BBO 24098 	● 598994	0		330x32 (30)	● 197087				
			Right disc	F	10/05→11/06	BBO 24098 	● 598994	0		330x32					
4.2i V8			Left disc	F	11/02→11/06	BBO 23692 	598655	0		330x32 (30)	● 197087				
			Right disc	F	11/02→11/06	BBO 23692 	598655	0		330x32					
5.0TDi V10, 6.0i W12			Left disc	F	11/02→11/06	BBO 23692 	598655	0		350x34					
			Right disc	F	11/02→11/06	BBO 23692 	598655	0		350x34					
2.5TDi			R	01/03→11/06	ATE 24367 	598967	0		314x22 (18)	● 197243					
3.0TDi V6, 3.2i V6			R	11/02→05/05	BBO 23694 	598770	0		330x28 (26)	● 197090					
3.0TDi V6, 3.2i V6, 3.6FSi V6			R	06/05→11/06					330x28 (26)	● 197090					

































																					
VOLKSWAGEN 																					
Touareg I (2002>2006) (.../...)																					
4.2i V8, 5.0TDi V10, 6.0i W12			R	11/02→11/06	BBO 23694		598770	0		330x28 (26)	● 197090										
2.5TDi, 3.2i V6, 4.2i V8 5.0TDi V10			⊙ 16"	P	11/02→11/06		562805														
Touareg II (2006>2010)																					
2.5TDi			F	12/06→05/10	ATE 23467		● 598940	2		308x29,5 (25,5)	186756										
3.0TDi V6, 3.6FSi V6, 4.2i V8			Left disc	F	12/06→05/10	BBO 24098		● 598994	0		330x32 (30)	● 197087									
			Right disc	F	12/06→05/10	BBO 24098		● 598994	0		330x32										
5.0TDi V10, 6.0i W12			Left disc	F	12/06→05/10	BBO 23693		598656	0		350x34										
			Right disc	F	12/06→05/10	BBO 23693		598656	0		350x34										
2.5TDi			R	12/06→05/10	ATE 24367		598967	0		314x22 (18)	● 197243										
3.0TDi V6, 3.6FSi V6			R	12/06→05/10						330x28 (26)	● 197090										
4.2FSi V8, 5.0TDi V10, 6.0i W12			R	12/06→05/10	BBO 23694		598770	0		330x28 (26)	● 197090										
Touareg II (2006>)																					
2.5TDi			P	12/06→05/10			562805														
Touareg II (2010>)																					
3.0TSi, 3.0TDi V6, 3.6FSi V6			Left disc	F	01/10→					330x32 (30)	● 197087										
			Right disc	F	01/10→						330x32										
4.2TDi			Left disc	F	01/10→	BBO 24098		● 598994	0		330x32 (30)	● 197087									
			Right disc	F	01/10→	BBO 24098		● 598994	0		330x32										
3.0TSi, 3.0TDi V6, 3.6FSi V6, 4.2TDi			R	01/10→						330x28 (26)	● 197090										
VOLKSWAGEN 																					
412 (68>74)																					
1.7, 1.8			F	08/68→07/74	ATE 20228		598099	0		281x11											
Bora (98>2005)																					
1.4i, 1.6i, 1.8i, 2.0i  			F	09/98→05/99	ATE 21974		598332	0		256x21,9 (19)	186603	●186983									
			F	05/99→05/01	ATE 21974		598408	1		256x21,9 (19)	186603	●186973									
			F	05/01→05/05	ATE 21974		598408	1		280x22 (19)	186604										































































										
VOLKSWAGEN  (.../...)										
Bora (98>2005) (.../...)										
1.8i Turbo 110KW 	F	05/00→05/05	ATE 21911 	598486	1		288x24,9 (22)	● 197230		
1.8i Turbo 132KW 	F	05/02→05/05	ATE 21911 	598486	1		312x25 (23)	● 197246		
2.3i V5 110KW 	F	09/98→05/99	ATE 21911 	598303	0		288x24,9 (22)	● 197230		
	F	05/99→02/01	ATE 21911 	598486	1		288x24,9 (22)	● 197230		
	4WD(+)	F	01/99→05/99	ATE 21911 	598303	0		280x22 (19)	186604	
	4WD(+)	F	05/99→02/01	ATE 21911 	598486	1		280x22 (19)	186604	
2.3i V5 110KW 	4WD(+)	F	09/00→05/05	ATE 21911 	598486	1		312x25 (23)	● 197246	
2.3i V5 125KW	F	09/00→05/05	ATE 21911 	598486	1		312x25 (23)	● 197246		
2.8i VR6 	F	05/99→05/03	ATE 21911 	598486	1		312x25 (23)	● 197246		
1.9SDi 	F	09/98→05/99	ATE 21974 	598332	0		280x22 (19)	186604		
	F	05/99→05/05	ATE 21974 	598408	1		280x22 (19)	186604		
1.9TDi (66...85KW) 	F	09/98→05/99	ATE 21974 	598332	0		280x22 (19)	186604		
1.9TDi (66...85KW) 	F	05/99→05/05	ATE 21974 	598408	1		280x22 (19)	186604		
1.9TDi 96KW 	F	04/01→05/05	ATE 21911 	598486	1		288x24,9 (22)	● 197230		
1.9TDi 110KW 	F	09/00→05/05	LUC 20901 	598017	2		288x24,9 (22)	● 197230		
	F	09/00→05/05	ATE 21911 	598486	1		288x24,9 (22)	● 197230		
1.4i, 1.6i 	R	09/98→05/05	LUC 20960 	598180	0(D)		232x9 (7)	186597		
1.8i 	4WD(-)	R	02/99→05/99	LUC 20960 	598180	0(D)	232x9 (7)	186597		
1.8i 	4WD(+)	R	02/99→10/00	LUC 20960 	598180	0(D)	239x8,9 (7)	● 197011		
1.8i Turbo (110KW) 	R	05/00→05/05	LUC 20960 	598180	0(D)		232x9 (7)	186597		
1.8i Turbo (132KW) 	R	05/02→05/05					256x22 (20)	● 197088		
2.0i 	4WD(-)	R	09/98→05/05	LUC 20960 	598180	0(D)	232x9 (7)	186597		
	4WD(+)	R	04/00→05/03	LUC 20960 	598180	0(D)	239x8,9 (7)	● 197011		
2.3i V5 110KW 	4WD(-)	R	09/98→05/05	LUC 20960 	598180	0(D)	232x9 (7)	186597		















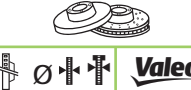













































												
												
VOLKSWAGEN  (.../...)												
Bora (98>2005) (.../...)												
2.3i V5 110KW 	4WD(+)	R	09/00→02/01	LUC 20960		598180	0(D)		239x8,9 (7)	●	197011	
2.3i V5 110KW 	4WD(+)	R	09/00→02/01	LUC 20960		598463	0(D)		239x8,9 (7)	●	197011	
2.3i V5 110KW Auto 	4WD(+)	R	09/00→02/01	LUC 20960		598463	0(D)		256x22 (20)	●	197088	
2.3i V5 125KW	4WD(-)	R	09/00→05/05						256x22 (20)	●	197088	
	4WD(+)	R	09/00→05/03	LUC 20960		598463	0(D)		256x22 (20)	●	197088	
2.8i VR6  		R	05/99→05/03	LUC 20960		598463	0(D)		256x22 (20)	●	197088	
1.9SDi 		R	09/98→05/05	LUC 20960		598180	0(D)		232x9 (7)		186597	
1.9TDi (66...96KW)  	4WD(-)	R	09/98→05/05	LUC 20960		598180	0(D)		232x9 (7)		186597	
1.9TDi 110KW 	4WD(-)	R	09/00→05/05	LUC 20960		598180	0(D)		232x9 (7)		186597	
1.9TDi 110KW 	4WD(-)	R	09/00→05/05	LUC 20960		598180	0(D)		239x8,9 (7)	●	197011	
1.9TDi (66...110KW)  	4WD(+)	R	09/98→05/05	LUC 20960		598180	0(D)		239x8,9 (7)	●	197011	
Coccinelle/Beetle (47>83)												
1.2, 1.6			→  1122076273	F	07/70→							
1.2, 1.3			 1122076274 •  1332013626	F		ATE 20009						
1.6			 1332013627	F	-07/83							
Corrado (88>95)												
1.8i, 2.0i		F	04/89→07/95	LUC 20901		598016	2		256x19,9 (18)		186247	
1.8i G60		F	09/88→07/93	LUC 20901		598252	0		280x22 (20)		186519	
2.9E VR6		F	08/91→07/95	LUC 20901		598252	0		280x22 (20)		186313	
1.8i, 2.0i		R	04/89→07/95	LUC 20960		598180	0(D)		226x10 (8)		186288	
1.8i G60			→  P-009 000	R	09/88→03/93	LUC 20960			226x10 (8)		186288	
			 P-009 001	R	03/93→07/93	LUC 20960			226x10 (8)		186288	
2.9E VR6			→  P-009 000	R	08/91→03/93	LUC 20960			226x10 (8)		186517	
			 P-009 001	R	03/93→07/95	LUC 20960			226x10 (8)		186517	































































																				
VOLKSWAGEN  (.../...)																				
Dasher (75>80)																				
1.6			F	08/75→07/80																
			F	08/75→07/80																
Derby (77>81)																				
0.9, 1.1, 1.3			F	01/77→09/81	ATE 20228		598099	0												
Derby (81>84)																				
1.05, 1.1, 1.3			F	10/81→10/84	ATE 20228		598099	0												
Eos (2006>)																				
1.4FSi 90KW, 1.6FSi			F	05/06→	ATE 23587		598635	1												
1.4FSi 118KW, 2.0FSi, 2.0TDi, 2.0TFSi			F	05/06→	ATE 23587		598635	1												
3.2i V6			F	05/06→	ATE 23801		598863	1												
1.4FSi 90KW, 1.6FSi			R	05/06→	LUC 20960		598463	0(D)												
1.4FSi 118KW, 2.0FSi, 2.0TDi, 2.0TFSi			R	05/06→	LUC 23914		598752	0												
3.2i V6			R	05/06→	LUC 23914		598752	0												
Fox (2004>)																				
1.2i, 1.4TDi, 1.4i			DA(+)	F	11/04→	ATE 21974		598332	0											
			DA(-)	F	11/04→	ATE 21865		598488	0											
Golf I (74>83)																				
1.1, 1.3, 1.5D, 1.6D			F	08/76→12/83	ATE 20228		598099	0												
1.1, 1.5, 1.6, 1.6TD, 1.7i			F	02/74→12/83	VW 20887		598128	0												
1.6, 1.7i, 1.8			F	06/76→12/83	VW 20887		598124	0												
Golf I Cabriolet (79>93)																				
1.6			F	08/81→07/92	VW 20887		598128	0												
1.3i, 1.8, 1.8i			F	08/82→07/93	VW 20887		598124	0												
Golf II (83>92)																				
1.05, 1.3, 1.6D			F	08/83→07/92	VW 20889		598127	0												
1.3, 1.6D			F	08/85→07/92	VW 20887		598128	0												
			F	08/85→07/92	VW 20889		598127	0												



























































			RPF		WVA		Valeo		Valeo		Valeo	
VOLKSWAGEN  (.../...)												
Golf II (83>92) (.../...)												
1.05, 1.3, 1.6, 1.6D, 1.6TD, 1.8, 1.8i	F	08/83→07/92	VW 20887		598128	0		239x11,9 (10)	186245	186912		
1.8, 1.8i	F	01/84→10/91	VW 20887		598124	0		239x19,9 (18)	186246			
1.8i	F	02/86→07/88	ATE 21866		598066	0		239x19,9 (18)	186246			
	F	08/88→10/91	LUC 20901		598016	2		256x19,9 (18)	186247			
1.8, 1.8 G60	F	08/88→07/91	LUC 20901		598252	0		280x22 (20)	186519			
1.8, 1.8i	R	01/84→10/91	LUC 20960		598180	0(D)		226x10 (8)	186288	186961		
1.8 G60	R	08/88→07/91	LUC 20960		598180	0(D)		239x9,9 (8)	186249			
Golf II Cabriolet (93>98)												
1.8i	F	01/98→02/98	VW 20887		598128	0		239x11,9 (10)	186245	186912		
	ABS(+)	F	01/98→02/98	VW 20887		598124	0		239x11,9 (10)	186245		
1.6i, 1.8i, 1.9TDi	F	09/93→02/98	LUC 20901		598252	0		256x12,9 (11)	186251			
1.6i, 1.8i, 1.9TDi, 2.0i	F	07/95→05/96	LUC 20901		598016	2		256x12,9 (11)	186251			
	F	05/96→02/98	LUC 20901		598252	0		256x19,9 (18)	186247			
2.0i	F	09/93→12/95	LUC 20901		598016	2		256x19,9 (18)	186247			
1.8i, 1.9TDi, 2.0i	R	08/95→02/98	LUC 20960		598180	0(D)		226x10 (8)	186288			
Golf III (91>99)												
1.4 (eng ABD 44KW) 1.6 (eng ABU AEA 55KW) 	F	11/91→06/95	VW 20887		598128	0		239x11,9 (10)	186245	186912		
1.4 (eng AEX 44KW) 1.6 (eng AEE 55KW) 	ABS(-)	F	07/95→12/97	ATE 21866		598066	0		239x11,9 (10)	186245		
	ABS(+)	F	10/96→12/97	ATE 21866		598403	0		239x19,9 (18)	186246		
	ABS(+)	F	10/96→12/97	LUC 21945		598330	0		256x19,9 (18)	186247		
1.6 (eng AEK 74KW) 1H15 	F	10/94→12/95	LUC 20901		598016	2		256x12,9 (11)	186251			
1.6 (eng AEK 74KW) 1H12 1H13 	F	10/94→12/95	LUC 20901		598252	0		256x19,9 (18)	186247			
1.6 (eng AFT 74KW) 1H15, 1H1E 	ABS(-)	F	12/95→10/96	LUC 20901		598016	2		256x12,9 (11)	186251		

										
VOLKSWAGEN  (.../...)										
Golf III (91>99) (.../...)										
1.6 (eng AFT 74KW) 1H10, 1H12 1H13, 1H1B 	ABS(-)	F	12/95→10/96	LUC 20901 	598252	0		256x12,9 (11)	186251	
1.6 (eng AFT 74KW) 1H10, 1H12 1H13, 1H15, 1H1B, 1H1E 	ABS(+)	F	10/96→12/97	LUC 21945 	598330	0		256x19,9 (18)	186247	
1.6 (eng AKS 74KW) 1H10 		F	05/97→12/97	LUC 20901 	598252	0		256x12,9 (11)	186251	
1.6 (eng AKS 74KW) 1H15 		F	05/97→12/97	LUC 21945 	598330	0		256x19,9 (18)	186247	
1.8 (eng AAM 55KW) 1H12 1H13 	ABS(-)	F	11/91→08/95	VW 20887 	598128	0		239x11,9 (10)	186245	186912
1.8 (eng AAM 55KW) 1H10 1H12 1H13 	ABS(-)	F	08/95→12/97	ATE 21866 	598066	0		239x11,9 (10)	186245	
	ABS(-)	F	01/95→12/97	LUC 20901 	598252	0		256x12,9 (11)	186251	
1.8 (eng AAM 55KW) 1H10 	ABS(-)	F	05/96→12/97	LUC 21945 	598330	0		256x19,9 (18)	186247	
1.8 (eng AAM 55KW) 1H12 1H13 	ABS(+)	F	05/96→12/97	LUC 21945 	598330	0		256x19,9 (18)	186247	
1.8 (eng ABS 66KW) 1H12 1H13 	4WD(-)	F	11/91→06/95	VW 20887 	598128	0		239x11,9 (10)	186245	186912
1.8 (eng ABS 66KW) 1H15 	4WD(-)	F	11/91→06/95	LUC 20901 	598016	2		256x19,9 (18)	186247	
1.8 (eng ABS 66KW) 	4WD(+)	F	11/91→08/95	VW 20887 	598128	0		239x11,9 (10)	186245	186912
1.8 (eng ACC 66KW) 		F	12/94→12/97	LUC 20901 	598252	0		256x12,9 (11)	186251	
1.8 (eng ADZ 66KW) 1H12 1H13 	4WD(-)	F	10/94→01/95	VW 20887 	598128	0		239x11,9 (10)	186245	186912
1.8 (eng ADZ 66KW) 1H15 	4WD(-)	F	10/94→12/97	LUC 20901 	598016	2		256x19,9 (18)	186247	
1.8 (eng ADZ 66KW) 1H10 1H12 1H13 	4WD(-)	F	10/94→12/97	LUC 20901 	598252	0		256x12,9 (11)	186251	
	4WD(+)	F	10/94→01/95	VW 20887 	598128	0		239x11,9 (10)	186245	186912
	4WD(+)	F	02/95→04/99	LUC 20901 	598252	0		256x12,9 (11)	186251	
	2.0E (eng AEP 79KW) 		F	01/95→10/96	LUC 20901 	598016	2		256x19,9 (18)	186247
		F	10/96→12/97	VW 20887 	598128	0		256x19,9 (18)	186247	
2.0E (eng 2E 85KW) 1H12 1H13 1H15L 		F	11/91→09/94	LUC 20901 	598016	2		256x19,9 (18)	186247	
2.0E (eng 2E 85KW) 1H15K 1H16 		F	11/91→09/94	LUC 21366 	● 598982	2		280x22 (20)	186313	
2.0E (eng ADY 85KW) 1H12 1H13 1H15 		F	10/94→10/96	LUC 20901 	598016	2		256x19,9 (18)	186247	

		R P F		2 2 2		WVA		Valeo		Valeo	
VOLKSWAGEN  (.../...)											
Golf III (91>99) (.../...)											
2.0E (eng ADY 85KW) 1H12 1H13 1H15 		F	10/96→12/97	VW 20887 	598128	0		256x19,9 (18)	186247		
2.0E (eng ADY 85KW) 1H16 		F	10/94→02/95	LUC 21366 	● 598982	2		280x22 (20)	186313		
		F	02/95→12/97	LUC 20901 	598252	0		280x22 (20)	186313		
2.0E (eng AKR 85KW) 1H16 		F	05/94→02/95	VW 20887 	598128	0		280x22 (20)	186313		
		F	02/95→12/97	VW 20887 	598124	0		280x22 (20)	186313		
2.0E (eng AKR 85KW) 1H10 	Red Caliper	F	05/97→12/97	ATE 21911 	598303	0		288x25 (23)	186521		
2.0E (eng AGG 85KW) 1H12 1H13 1H15 	4WD(-)	F	10/94→05/96	LUC 20901 	598016	2		256x19,9 (18)	186247		
2.0E (eng AGG 85KW) 1H13 	4WD(-)	F	05/96→12/97	ATE 21911 	598303	0		288x25 (23)	186521		
2.0E (eng AGG 85KW) 1H16 	4WD(-)	F	10/94→06/95	VW 20887 	598124	0		280x22 (20)	186313		
2.0i (eng AGG 85KW) 	4WD(+)	F	07/95→04/99	LUC 21945 	598330	0		256x19,9 (18)	186247		
2.0 16V (eng ABF 110KW) 		F	10/94→02/95	LUC 21366 	● 598982	2		280x22 (20)	186313		
		F	02/95→12/97	LUC 20901 	598252	0		280x22 (20)	186313		
		Red Caliper	F	05/96→12/97	ATE 21911 	598303	0		288x25 (23)	186521	
2.8 VR6 (eng AAA 128KW) 		F	01/92→01/95	LUC 21366 	● 598982	2		280x22 (20)	186313		
		F	01/95→12/97	ATE 21911 	598303	0		288x25 (23)	186521		
2.9i VR6 (eng ABV 140KW) 		F	01/94→04/99	ATE 21911 	598303	0		288x25 (23)	186521		
1.9D ecomatic (eng 1Y 48KW) 	ABS(-)	F	07/92→01/95	VW 20887 	598128	0		239x11,9 (10)	186245	186912	
	ABS(-)	F	01/95→04/96	LUC 20901 	598016	2		256x19,9 (18)	186247		
	ABS(+)	F	07/92→04/96	LUC 21945 	598330	0		256x19,9 (18)	186247		
1.9D (eng 1Y 48KW) 	ABS(-)	F	11/91→08/95	VW 20887 	598128	0		239x11,9 (10)	186245	186912	
	ABS(-)	F	08/95→12/97	ATE 21866 	598066	0		239x11,9 (10)	186245		
	ABS(+)	F	10/96→12/97	ATE 21866 	598403	0		239x19,9 (18)	186246		
	ABS(+)	F	10/96→12/97	LUC 21945 	598330	0		256x19,9 (18)	186247		
1.9SDi	ABS(-)	F	01/95→08/95	VW 20887 	598128	0		239x11,9 (10)	186245	186912	
1.9SDi ecomatic (eng AEY 47KW) 											

															
VOLKSWAGEN  (.../...)															
Golf III (91>99) (.../...)															
1.9SDi, 1.9SDi ecomatic (eng AEY 47KW) 	ABS(-)	F	08/95→12/97	ATE 21866		598066	0		239x11,9 (10)	186245					
	ABS(+)	F	10/96→12/97	ATE 21866		598403	0		239x19,9 (18)	186246					
	ABS(+)	F	10/96→12/97	LUC 21945		598330	0		256x19,9 (18)	186247					
1.9TD (eng AAZ 55KW) 	ABS(-)	F	11/91→08/95	VW 20887		598128	0		239x11,9 (10)	186245	186912				
	ABS(-)	F	08/95→12/97	ATE 21866		598066	0		239x11,9 (10)	186245					
	ABS(+)	F	05/96→12/97	LUC 21945		598330	0		256x19,9 (18)	186247					
1.9TDi (eng 1Z 66KW) 	ABS(-) 4WD(-)	F	06/93→07/96	LUC 20901		598252	0		256x12,9 (11)	186251					
	ABS(+)	F	05/96→07/96	LUC 21945		598330	0		256x19,9 (18)	186247					
	4WD(+)	F	05/96→07/96	LUC 20901		598252	0		256x12,9 (11)	186251					
1.9TDi (eng AHU 66KW) 	4WD(-)	F	08/96→12/97	LUC 21945		598330	0		256x19,9 (18)	186247					
	4WD(+)	F	08/96→04/99	LUC 20901		598252	0		256x12,9 (11)	186251					
1.9TDi (eng ALE 66KW) 	4WD(-)	F	05/97→12/97	LUC 21945		598330	0		256x19,9 (18)	186247					
	4WD(+)	F	05/96→04/99	LUC 20901		598252	0		256x12,9 (11)	186251					
1.9TDi (eng AFN 81KW) 		F	07/95→12/97	LUC 20901		598016	2		256x19,9 (18)	186247					
	Red Caliper	F	07/95→05/96	LUC 20901		598252	0		256x19,9 (18)	186247					
	Red Caliper	F	05/96→12/97	ATE 21911		598303	0		288x25 (23)	186521					
1.4i (eng ABD 44KW) 		F	07/93→07/95	VW 20887		598128	0		239x11,9 (10)	186245	186912				
1.4i (eng AEX APQ 44KW) 		F	07/95→05/98	ATE 21866		598066	0		239x11,9 (10)	186245					
1.6i (eng AEK 74KW) 		F	10/94→12/95	LUC 20901		598252	0		256x12,9 (11)	186251					
1.6i (eng AFT 74 KW) 		F	01/96→02/99	LUC 20901		598252	0		256x12,9 (11)	186251					
		F	01/96→02/99	LUC 20901		598016	2		256x19,9 (18)	186247					
1.6i (eng AKS 74KW) 		F	04/97→02/99	LUC 20901		598016	2		256x19,9 (18)	186247					
1.8 (eng ANN 55KW) 		F	12/97→02/99	LUC 20901		598252	0		256x12,9 (11)	186251					
1.8 (eng AMM 55KW) 		F	07/93→02/99	LUC 20901		598252	0		256x12,9 (11)	186251					

			R P F		2 2 2		WVA		Valeo		Valeo		Valeo		
VOLKSWAGEN  (.../...)															
Golf III (91>99) (.../...)															
1.8 (eng AMM 55KW) 	F	07/93→02/99	LUC 20901		598016	2		256x19,9 (18)	186247						
1.8 (eng ABS 66KW) 	F	07/93→07/94	LUC 20901		598252	0		256x12,9 (11)	186251						
1.8 (eng ADZ 66KW) 	4WD(-)	F 10/94→02/99	LUC 20901		598252	0		256x12,9 (11)	186251						
	4WD(-)	F 10/94→02/99	LUC 20901		598016	2		256x19,9 (18)	186247						
	4WD(+)	F 10/94→01/95	VW 20887		598128	0		239x11,9 (10)	186245	186912					
	4WD(+)	F 02/95→04/99	LUC 20901		598252	0		256x12,9 (11)	186251						
1.8 (eng ANP 66KW) 	F	12/97→02/99	LUC 20901		598016	2		256x19,9 (18)	186247						
2.0i (eng 2E ADY AGG AKR 85KW) 	4WD(-)	F 07/93→02/99	LUC 20901		598016	2		256x19,9 (18)	186247						
2.0i (eng AGG 85KW) 	4WD(+)	F 07/95→04/99	LUC 21945		598330	0		256x19,9 (18)	186247						
2.9i VR6 (eng ABV 140KW) 	F	07/95→04/99	ATE 21911		598303	0		288x25 (23)	186521						
1.9D (eng 1Y 48KW) 	F	08/93→02/99	LUC 20901		598252	0		256x12,9 (11)	186251						
	F	08/93→02/99	LUC 20901		598016	2		256x19,9 (18)	186247						
1.9SDi (eng AEY 47KW) 	F	07/95→02/99	LUC 20901		598252	0		256x12,9 (11)	186251						
1.9TD (eng AAZ 55KW) 	F	07/93→02/99	LUC 20901		598252	0		256x12,9 (11)	186251						
	F	07/93→02/99	LUC 20901		598016	2		256x19,9 (18)	186247						
1.9TDi (eng 1Z 66KW) 	4WD(-)	F 07/93→07/96	LUC 20901		598252	0		256x12,9 (11)	186251						
1.9TDi (eng 1Z AHU ALE 66KW) 	4WD(-)	F 07/93→02/99	LUC 20901		598016	2		256x19,9 (18)	186247						
	4WD(+)	F 10/94→04/99	LUC 20901		598252	0		256x12,9 (11)	186251						
1.9TDi (eng AFN 81KW) 	F	02/96→02/99	LUC 20901		598016	2		256x19,9 (18)	186247						
1.6, 1.6i, 1.8i, 1.9TDi	R	11/91→12/97	LUC 20960		598180	0(D)		226x10 (8)	186288						
	R	10/92→04/99	LUC 20960		598463	0(D)		226x10 (8)	186288						
2.0, 2.0E	R	10/92→12/97	LUC 20960		598180	0(D)		226x10 (8)	186288						
	R	10/92→12/97	LUC 20960		598463	0(D)		226x10 (8)	186288						
	R	10/92→12/97	LUC 20960		598180	0(D)		226x10 (8)	186517						

																			
VOLKSWAGEN  (.../...)																			
Golf III (91>99) (.../...)																			
2.0, 2.0E (...)	R	10/92-12/97	LUC 20960		598463	0(D)		226x10 (8)	186517										
2.8 VR6	R	01/91-10/92	LUC 20960		598180	0(D)		226x10 (8)	186517										
	R	10/92-12/97	LUC 20960		598463	0(D)		226x10 (8)	186517										
2.9i VR6	R	01/94-04/99	LUC 20960		598463	0(D)		239x10											
1.9TDi 110KW	R	07/95-12/97	LUC 20960		598180	0(D)		226x10 (8)	186288										
	Red Caliper	R	07/95-12/97	LUC 20960		598463	0(D)		226x10 (8)	186517									
Golf III Cabriolet (98>2002)																			
1.6i, 1.8i, 1.9TDi, 2.0i	ABS(-)	F	03/98-06/02	LUC 20901		598252	0		256x12,9 (11)	186251									
	ABS(+)	F	03/98-06/02	LUC 21945		598330	0		256x19,9 (18)	186247									
	ABS(-)	R	03/98-06/02	LUC 20960		598180	0(D)		226x10 (8)	186288									
	ABS(+)	R	09/98-06/02						226x10 (8)	186288									
Golf IV (97>2006)																			
1.6i 	F	10/97-05/99	ATE 21974		598332	0		256x21,9 (19)	186603	●186983									
	F	08/98-05/99	ATE 21974		598332	0		256x21,9 (19)	186603	●186983									
1.8i 	F	05/98-05/99	ATE 21974		598332	0		280x22 (19)	186604										
1.8i Turbo 	F	10/98-05/99	ATE 21911		598303	0		288x24,9 (22)	●197230										
1.8i, 1.9TDi, 2.0i 	F	05/99-06/05	ATE 21974		598408	1		280x22 (19)	186604										
1.9TDi  	F	07/98-04/02	ATE 21974		598408	1		256x21,9 (19)	186603	●186973									
1.9TDi, 2.3i VR5 	F	05/99-06/05	ATE 21911		598486	1		288x24,9 (22)	●197230										
2.3i VR5, 2.8i V6, 2.8i VR6 	F	05/99-06/05	ATE 21911		598486	1		312x25 (23)	●197246										
1.4i, 1.6FSI, 1.6i, 1.8i 	F	07/98-06/06	ATE 21974		598408	1													
1.9SDi, 1.9TDi, 2.0i  																			
1.4i, 1.6i, 1.8i, 1.9SDi, 1.9TDi, 2.0i 	F	10/97-05/99	ATE 21974		598332	0													
1.8i Turbo, 2.3i VR5 	F	10/97-05/99	ATE 21911		598303	0													



VOLKSWAGEN (…/…)







































Golf IV (97>2006) (…/…)















































1.8i Turbo, 1.9TDi 2.3i VR5, 2.8i V6 2.8i VR6	Y-000 001	F	10/97→05/06	ATE 21911	598486	1			
1.4i, 1.6FSI, 1.6i, 1.9SDi, 1.9TDi		F	10/97→06/06					256x21,9 (19)	186603
1.8i, 1.9TDi, 2.0i		F	10/97→06/06					280x22 (19)	186604
1.8i Turbo, 1.9TDi, 2.3i VR5		F	10/97→05/06					288x24,9 (22)	● 197230
1.8i Turbo, 2.3i VR5, 2.8i V6, 2.8i VR6		F	05/99→05/06					312x25 (23)	● 197246
3.2i V6		F	06/02→05/04	ATE 21484	598712	1		334x32	
1.8i, 1.8i Turbo, 1.9TDi, 2.0i, 2.3i VR5 2.8i V6, 2.8i VR6, 3.2i V6		R	07/98→06/05	LUC 20960	598463	0(D)			
1.8i Turbo, 2.3i VR5, 2.8i V6, 2.8i VR6		R	05/99→05/06						
1.4i, 1.6FSI, 1.6i, 1.8i, 1.8i Turbo, 1.9SDi 1.9TDi, 2.0i, 2.3i VR5		R	10/97→06/06	LUC 20960	598180	0(D)		232x9 (7)	186597
1.8i, 1.9TDi, 2.0i, 2.3i VR5		R	07/98→06/05					239x8,9 (7)	● 197011
1.8i Turbo, 2.3i VR5, 2.8i V6, 2.8i VR6 3.2i V6		R	05/99→05/06					256x22 (20)	● 197088





































Golf V (2003>)



















1.4FSi, 1.4TFSi, 1.4TSi, 1.4i, 1.6i, 1.9TDi		F	05/05→	ATE 21974	598408	1		280x22 (19)	186754	● 186974
1.4FSi, 1.4TFSi, 1.4TSi, 1.4i, 1.6i, 1.9TDi 2.0SDi		F	10/03→	ATE 21974	598408	1		280x22 (19)	186754	● 186974
1.4FSi, 1.6FSi		F	10/03→11/08	ATE 21974	598408	1		288x25 (22)	186755	
1.6FSi, 2.0FSi, 2.0TDi		F	10/03→	ATE 23587	598635	1		288x25 (22)	186755	
2.0FSi, 2.0TFSi		F	09/04→03/09	ATE 23587	598635	1		312x25 (22)	● 197242	
3.2i VR6		F	08/05→	ATE 23801	598863	1		345x30 (27)	● 197197	
1.4FSi, 1.4TFSi, 1.4TSi, 1.4i, 1.6FSi, 1.6i 1.9TDi, 2.0SDi		F	10/03→	ATE 21974	598408	1				
1.6FSi, 2.0FSi, 2.0TDi, 2.0TFSi		F	10/03→	ATE 23587	598635	1				

















































VOLKSWAGEN (.../...)									
Golf Plus (2005>) (.../...)									
1.4FSi, 1.4TFSi, 1.4TSi, 1.4i, 1.6FSi, 1.6i 1.9TDi, 2.0FSi, 2.0TDi	R	01/05→	LUC 20960	598463	0(D)		255x10 (8)	186857	
Golf Plus (2009>)									
1.4TSi, 1.4i, 1.6TDi, 1.6i, 2.0TDi	F	01/09→	ATE 21974	598408	1		280x22 (19)	186754	● 186974
1.4TSi, 2.0TDi	F	01/09→	ATE 23587	598635	1		288x25 (22)	186755	
1.4TSi, 1.4i, 1.6TDi, 1.6i, 2.0TDi	R	01/09→	LUC 20960	598463	0(D)		255x10 (8)	186857	
1.4TSi, 2.0TDi	R	01/09→	LUC 23914	598752	0		286x12 (10)	● 197031	
Jetta I (78>84)									
1.1, 1.3, 1.6D	F	08/79→02/84	ATE 20228	598099	0		239x9,9 (8)	186249	
1.5, 1.6, 1.6TD, 1.7	F	08/78→02/84	VW 20887	598128	0		239x11,9 (10)	186245	186912
1.6	F	08/78→07/82	VW 20887	598128	0		239x19,9 (18)	186246	
1.7, 1.8	F	08/81→02/84	VW 20887	598124	0		239x19,9 (18)	186246	
1.8	R	08/82→02/84	LUC 20960	598180	0(D)		226x10 (8)	186288	186961
Jetta II (83>92)									
1.05, 1.3, 1.3i, 1.6D	F	08/83→07/92	ATE 20228	598099	0		239x9,9 (8)	186249	
1.3	F	08/83→07/87	VW 20889	598127	0		239x9,9 (8)	186249	
1.6, 1.6D, 1.6TD, 1.8, 1.8i	F	08/83→07/92	VW 20887	598128	0		239x11,9 (10)	186245	186912
1.8, 1.8i	ABS(+)	F 08/86→10/91	VW 20887	598124	0		239x11,9 (10)	186245	
	ABS(+)	F 01/84→10/91	VW 20887	598124	0		239x19,9 (18)	186246	
	ABS(+)	F 08/86→10/91	VW 20887	598128	0		239x19,9 (18)	186246	
1.8i	F	08/86→07/88	LUC 20901	598016	2		256x19,9 (18)	186247	
1.8, 1.8i	R	01/84→07/88	LUC 20960	598180	0(D)		239x9,9 (8)	186249	
	R	07/88→10/91	LUC 20960	598180	0(D)		226x10 (8)	186288	
Jetta III (2005>)									
1.4TSi, 1.6i, 1.9TDi	F	08/05→	ATE 21974	598408	1		280x22 (19)	186754	● 186974
1.6FSi	F	09/05→	ATE 23587	598635	1		280x22 (19)	186754	

																			
VOLKSWAGEN  (.../...)																			
Jetta III (2005>) (.../...)																			
1.4TSi, 2.0FSi, 2.0TDi, 2.5i	F	08/05→	ATE 23587		598635	1		288x25 (22)	186755										
1.4TSi, 2.0TDi, 2.0TFSi, 2.0TSI	F	09/05→	ATE 23587		598635	1		312x25 (22)	● 197242										
1.6FSi, 1.6i, 1.9TDI	R	08/05→	LUC 20960		598463	0(D)		260x12 (10)	186833										
1.4TSi, 1.9TDI, 2.0FSi, 2.0TDi, 2.5i	R	08/05→	LUC 23914		598752	0		260x12 (10)	186833										
1.4TSi, 2.0TDi, 2.0TFSi, 2.0TSI	R	09/05→	LUC 23914		598752	0		286x12 (10)	● 197031										
Lupo (98>2005)																			
1.2TDi	F	05/99→07/05	ATE 23395		598735	0		239x14,9 (13)	186788										
1.0i, 1.4FSi, 1.4TDi, 1.4i, 1.7SDi	F	10/98→07/05	ATE 21865		598488	0		239x17,9 (16)	186523										
1.6i	F	06/00→07/05	ATE 21865		598805	1(A)		256x24,9 (23)	● 197086										
1.4FSi, 1.4i, 1.6i	R	05/99→07/05	LUC 20960		598463	0(D)		232x9 (8)	186729										
New Beetle (98>2001)																			
1.6i, 1.9TDi, 2.0i	F	06/99→05/01	ATE 21974		598408	1		280x22 (19)	186604										
2.0i	F	03/00→05/01	ATE 21974		598332	0		280x22 (19)	186604										
1.6i, 1.9TDi, 2.0i	F	06/99→05/01	 Y-600 001	ATE 21974	598408	1													
1.8i Turbo	F	01/99→06/99	 X-699 000	ATE 21911	598303	0													
1.8i Turbo, 2.3i V5 3.2i V6	F	06/99→05/01	 Y-600 001	ATE 21911	598486	1													
1.9TDi, 2.0i	F	01/98→05/01	ATE 21974		598332	0													
1.6i, 1.9TDi, 2.0i	F	01/98→05/01						280x22 (19)	186604										
1.8i Turbo	F	01/99→05/01						288x24,9 (22)	● 197230										
2.3i V5, 3.2i V6	F	10/00→05/01						312x25 (23)	● 197246										
1.6i, 1.8i Turbo, 1.9TDi, 2.0i, 2.3i V5	R	01/98→05/01	LUC 20960		598180	0(D)		232x9 (7)	186597										
3.2i V6	R	10/00→05/01	LUC 20960		598463	0(D)		256x22 (20)	● 197088										
New Beetle (2001>2005)																			
1.4i, 1.6i, 1.9TDi, 2.0i	F	06/01→06/05	ATE 21974		598408	1		280x22 (19)	186604										
1.8i Turbo, 2.3i V5	F	06/01→06/05	ATE 21911		598486	1		288x24,9 (22)	● 197230										



















































																		
VOLKSWAGEN  (.../...)																		
New Beetle (2001>2005) (.../...)																		
1.4i, 1.6i, 1.9TDi, 2.0i	R	06/01→06/05	LUC 20960		598180	0(D)		232x9 (7)	186597									
1.8i Turbo, 2.3i V5	R	06/01→06/05						256x22 (20)	197088									
New Beetle (2005>)																		
1.4i, 1.6i, 1.8i Turbo, 1.9TDi, 2.0i 	F	07/05→	ATE 21974		598408	1		280x22 (19)	186604									
2.5i 	F	07/05→	ATE 21911		598486	1		288x24,9 (22)	197230									
1.4i, 1.6i, 1.8i Turbo, 1.9TDi, 2.0i 2.5i 	R	07/05→	LUC 20960		598463	0(D)		232x9 (7)	186597									
Passat I (73>81)																		
1.3 	F	05/73→01/78	ATE 20228		598099	0		239x9,9 (8)	186249									
1.3, 1.5, 1.6 	F	05/73→07/77	ATE 20228		598099	0		239x11,9 (10)	186245									
1.6, 1.6D 	F	02/76→07/81	VW 20887		598128	0		239x11,9 (10)	186245	186912								
1.3, 1.5D, 1.6 	F	08/78→02/80	LUC 20574		598205	0		239x11,9 (10)	186245									
1.6 	F	02/79→07/80	VW 20887		598128	0		239x19,9 (18)	186246									
1.9, 2.2 	F	01/81→07/81	VW 20887		598124	0		239x19,9 (18)	186246									
Passat II (81>88)																		
1.3, 1.6D 	F	08/81→07/82	ATE 20228		598099	0		239x9,9 (8)	186249									
1.8, 2.0i, 2.3 	R	08/84→07/88	LUC 20960		598180	0(D)		239x9,9 (8)	186249									
1.3 	F	08/82→07/83	ATE 20228		598099	0		239x11,9 (10)	186245									
1.3, 1.3i, 1.6, 1.6D, 1.6TD, 1.8, 1.8i 	F	08/81→04/88	VW 20887		598128	0		239x11,9 (10)	186245	186912								
2.3, 2.3i 	R	01/85→04/88	LUC 20960		598180	0(D)		226x10 (8)	186288									
1.9, 2.0i, 2.2, 2.2i, 2.3i 	F	08/81→04/88	VW 20887		598124	0		239x19,9 (18)	186246									
1.8, 2.0i, 2.3, 2.3i 	F	08/84→07/88	LUC 20901		598016	2		256x19,9 (18)	186247									
Passat III (88>93)																		
1.8i  4WD(-)	F	04/88→07/92	LUC 20901		598016	2		256x12,9 (11)	186251									
1.6, 1.6i  4WD(-)	F	04/88→07/90	VW 20887		598128	0		256x12,9 (11)	186251									
1.6, 1.6TD, 1.6i, 1.8i, 1.9D 1.9TD, 2.0, 2.0i  4WD(-)	F	04/88→10/93	LUC 20901		598252	0		256x12,9 (11)	186251									

















































									
VOLKSWAGEN  (.../...)									
Passat III (88>93) (.../...)									
1.8, 1.8i, 2.0, 2.0i 	F	04/88→10/93	LUC 20901 	598016	2		256x19,9 (18)	186247	
1.8 	4WD(+)	F 09/89→10/93	LUC 20901 	598252	0		280x22 (20)	186519	
	4WD(+)	F 09/89→10/93	VW 20887 	598124	0		280x22 (20)	186519	
2.8i, 2.8i V6, 2.8i VR6 	F	06/91→10/93	LUC 20901 	598252	0		280x22		
1.8, 1.8i, 2.0, 2.0i, 2.8i 2.8i V6, 2.8i VR6 	 P-080 000	R 04/88→10/92	LUC 20960 	598180	0(D)				
1.8, 2.0, 2.0i, 2.8i 2.8i V6, 2.8i VR6 	 P-080 001	R 10/92→10/93	LUC 20960 	598463	0(D)				
1.8, 2.0 	R	09/89→10/93					239x9,9 (8)	186249	
1.8, 1.8i, 2.0, 2.0i 	R	04/88→10/93					226x10 (8)	186288	
2.8i, 2.8i V6, 2.8i VR6 	R	06/91→10/93					226x10 (8)	186517	
Passat IV (93>97)									
1.9TDi 	F	10/93→06/95	LUC 20901 	598252	0		239x11,9 (10)	186245	
1.6i, 1.8i, 1.9TD, 1.9TDi 	F	10/93→12/96	LUC 20901 	598252	0		256x12,9 (11)	186251	
1.9TDi, 2.0i 	F	10/93→12/96	LUC 21945 	598330	0		256x19,9 (18)	186247	
2.0i 	F	01/94→05/97	LUC 20901 	598016	2		256x19,9 (18)	186247	
1.9TDi 	F	03/96→12/96	LUC 20901 	598252	0		280x22 (20)	186313	
2.0i, 2.8i VR6, 2.9i VR6 	F	10/93→05/97	ATE 21911 	598303	0		288x25 (23)	186521	
1.9TDi, 2.0i 	R	10/93→05/97	LUC 20960 	598463	0(D)		226x10 (8)	186288	
2.0i, 2.8i VR6 	R	10/93→12/96	LUC 20960 	598463	0(D)		226x10 (8)	186517	
2.0i 	R	01/94→09/94	LUC 20960 	598180	0(D)		239x9,9 (8)	186249	
2.9i VR6 	R	01/94→05/97	LUC 20960 	598180	0(D)		239x10		
Passat V (96>2000)									
1.9TDi	F	10/96→04/99	LUC 20901 	598017	2		280x22 (20)	186582	
	F	05/99→08/00	LUC 21366 	598484	2		280x22 (20)	186582	
1.6i, 1.8i, 1.9TDi	F	10/96→06/98	ATE 21911 	598355	0		282,5x25 (23)	186583	













																		
VOLKSWAGEN  (.../...)																		
Passat V (96>2000) (.../...)																		
1.6i, 1.8i, 1.8i Turbo, 1.9TDi, 2.3i VR5 2.5TDi V6, 2.8i V6			F	10/96→08/00	ATE 20676 	598751	2(A)	 288x24,9 (23)	● 197222									
			R	10/96→08/00	LUC 20960 	598463	0(D)	 245x9,9 (8)	186294									
1.8i, 1.9TDi, 2.3i VR5, 2.5TDi V6, 2.8i V6			R	05/97→08/00	LUC 20960 	598463	0(D)	 245x10 (8)	186773									
Passat VI (2000>2005)																		
1.6i, 1.9TDi, 2.0i 			⊙ 15"	F	10/00→05/05	ATE 20676 	598751	2(A)	 288x24,9 (23)	● 197222								
1.9TDi, 2.0TDi, 2.0i 				F	10/00→05/05	ATE 20676 	598483	2(A)	 312x25 (23)	186758								
1.9TDi, 2.0TDi, 2.0i 			⊙ 15"	F	10/00→05/05	ATE 20676 	598751	2(A)	 312x25 (23)	186758								
2.5TDi V6, 2.8i V6, 4.0i W8 				F	10/00→05/05	ATE 21484 	598712	1	 321x30 (27)	● 197141								
1.8i Turbo, 1.9TDi, 2.0TDi, 2.0i, 2.3i V5 2.5TDi V6, 2.8i V6 				F	10/00→05/05	ATE 20676 	598483	2(A)										
1.8i Turbo, 2.3i V5, 2.5TDi, 2.5TDi V6 2.8i V6, 4.0i W8 				F	10/00→05/05	ATE 21484 	598712	1	 334x32									
1.6i, 1.8i Turbo, 1.9TDi, 2.0TDi, 2.0i 2.3i V5, 2.5TDi V6, 2.8i V6 				R	10/00→05/05	LUC 20960 	598463	0(D)	 245x9,9 (8)	186294								
2.0i 				R	10/00→05/05	LUC 20960 	598463	0(D)	 245x10 (8)	186773								
1.9TDi, 2.3i V5, 2.5TDi, 2.5TDi V6, 2.8i V6 4.0i W8 				R	10/00→05/05	LUC 20960 	598463	0(D)	 256x22									
2.5TDi V6, 2.8i V6, 4.0i W8 				R	10/00→05/05	LUC 20960 	598463	0(D)	 269x22 (20)	● 197089								
Passat VII (2005>)																		
1.4FSi, 1.4TFSi, 1.6FSi, 1.6i, 1.8FSi, 1.9TDi 2.0FSi, 2.0TDi, 2.0TFSi 				F	03/05→	ATE 23587 	598635	1	 312x25 (22)	● 197242								
2.0TFSi, 3.2FSi V6, 3.6FSi V6 				F	03/05→	ATE 23801 	598863	1	 345x30 (27)	● 197197								
1.4FSi, 1.4TFSi, 1.6FSi, 1.6i, 1.8FSi, 1.9TDi 2.0FSi, 2.0TDi, 2.0TFSi 				R	03/05→	LUC 23914 	598752	0	 286x12 (10)	● 197031								
2.0TFSi, 3.2FSi V6, 3.6FSi V6 				R	03/05→	LUC 23914 	598752	0	 310x22 (20)	● 197139								
Passat CC (2008>)																		
1.8TFSi, 2.0TDI				F	05/08→	ATE 23587 	598635	1	 312x25 (22)	● 197242								





















































																				
VOLKSWAGEN  (.../...)																				
Passat CC (2008>) (.../...)																				
2.0TFSI, 3.6FSI V6	F	05/08→	ATE 23801		598863	1		345x30 (27)	●	197197										
1.8TFSI, 2.0TDI	R	05/08→	LUC 23914		598752	0		286x12 (10)	●	197031										
2.0TFSI, 3.6FSI V6	R	05/08→	LUC 23914		598752	0		310x22 (20)	●	197139										
Phaeton (2002>2007)																				
3.0TDi V6, 3.2i VR6, 4.2i V8	F	05/03→05/07	ATE 23885		598845	2		360x34												
3.2i VR6	F	07/03→05/07	LUC 23118		● 598992	2		323x30												
5.0TDi V10, 6.0i W12	F	05/02→05/07						365x34												
3.2i VR6	R	05/02→05/07						280x22 (20)		186582										
3.0TDi V6, 3.2i VR6, 4.2i V8, 5.0TDi V10 6.0i W12	R																			
Phaeton (2007>)																				
3.0TDi V6, 3.2i V6, 4.2i V8	F	03/07→	ATE 23885		598845	2		360x34												
6.0i W12	F	06/07→						365x34												
3.0TDi V6, 3.2i V6, 4.2i V8, 6.0i W12	R	03/07→																		
Polo I (74>81)																				
0.8, 0.9, 1.1, 1.3	F	04/75→09/81	ATE 20228		598099	0		239x8												
1.3	F	01/77→07/81	ATE 20228		598099	0		239x9,9 (8)		186249										
Polo II (81>86)																				
1.05, 1.1, 1.3	F	10/81→07/84	ATE 20228		598099	0		239x9,9 (8)		186249										
1.05, 1.3	F	08/83→07/86	VW 20887		598258	0		239x9,9 (8)		186249										
Polo III (86>90)																				
1.05, 1.3D 	F	08/86→10/90	VW 20889		598127	0		239x9,9 (8)		186249										
1.3 	 F127903	F	08/87→	ATE 20228		598099	0		239x9,9 (8)	186249										
	 F127904	F	→10/90	VW 20889		598127	0		239x9,9 (8)	186249										
1.3 GT G40 	F	01/87→10/90	VW 20887		598124	0		239x19,9 (18)		186246										
Polo IV (90>94)																				
1.05, 1.3, 1.3i, 1.4D 	F	10/90→10/94	VW 20887		598258	0		239x9,9 (8)		186249										























































																					
VOLKSWAGEN  (.../...)																					
Polo IV (90>94) (.../...)																					
1.3 GT G40 			F	10/90→10/94	VW 20887 	598124	0		239x19,9 (18)	186246											
Polo V (94>99)																					
1.0i, 1.3i, 1.6i, 1.9D 			F	10/94→12/94	VW 20887 	598258	0		239x9,9 (8)	186581											
1.0i, 1.3i, 1.4i, 1.6i, 1.9D 1.9SDi, 1.9TDi 			ABS(-)	F	10/94→08/97	VW 20887 	598258	0		239x9,9 (8)	186249										
1.9SDi 			F	05/96→08/97	ATE 21866 	598066	0		239x11,9 (10)	186245											
1.9SDi, 1.9TDi 			F	05/96→08/97	VW 20887 	598258	0		239x11,9 (10)	186245											
1.0i, 1.3i, 1.4i, 1.6i, 1.7SDi, 1.9D 1.9SDi 			F	12/94→12/99	ATE 21865 	598488	0		239x17,9 (16)	186523											
1.4i, 1.9SDi 			F	08/97→08/99	ATE 21974 	598332	0		239x19,9 (18)	186246											
1.4i, 1.6i, 1.7SDi, 1.8i, 1.9SDi, 1.9TDi 			F	10/96→09/99	ATE 21866 	598403	0		239x19,9 (18)	186246											
1.4i, 1.6i 			F	03/96→12/99	LUC 21945 	598330	0		256x19,9 (18)	186247											
1.6i, 1.9TDi, 2.0i 			F	09/97→08/99	ATE 21866 	598403	0		256x19,9 (18)	186247											
1.6i Gti 			F	08/98→12/99	LUC 21945 	598330	0		256x24,9 (23)	● 197086											
1.6i, 1.9TDi, 2.0i 			ABS(-)	R	05/96→09/99	LUC 20960 	598180	O(D)		226x10 (8)	186288										
1.4i, 1.6i, 1.9TDi, 2.0i 			ABS(+)	R	04/96→12/99	LUC 20960 	598463	O(D)		226x10 (8)	186288										
Polo VI (99>2001)																					
1.0i, 1.4i, 1.7SDi, 1.9D 1.9SDi 			ABS(-)	F	10/99→09/01	ATE 21865 	598488	0		239x17,9 (16)	186523										
1.4i, 1.7SDi, 1.9D, 1.9SDi 			F	10/99→09/01	ATE 21865 	598488	0		239x17,9 (16)	186523											
1.4TDi 			F	10/99→09/01	LUC 21945 	598330	0		239x17,9 (16)	186523											
1.4i, 1.6i, 1.8i, 1.9SDi 			F	10/99→09/01	ATE 21866 	598403	0		239x19,9 (18)	186246											
2.0i 			F	06/00→09/01	LUC 21945 	598330	0		239x19,9 (18)	186246											
1.4TDi, 1.4i, 1.6i, 1.9TDi 			ABS(+)	F	10/99→09/01	LUC 21945 	598330	0		256x19,9 (18)	186247										
1.6i Gti 			F	11/99→09/01	LUC 21945 	598330	0		256x24,9 (23)	● 197086											
1.4TDi, 1.4i, 1.6i, 1.9TDi, 2.0i 			R	10/99→09/01	LUC 20960 	598180	O(D)		232x9 (8)	186729											















































										
VOLKSWAGEN  (.../...)										
Polo VII (2001>)										
1.2i, 1.9SDi	DA(-)	F	11/01→05/05	ATE 21865 	598488	0	 239x17,9 (16)	186888		
1.9SDi	DA(-)	F	11/01→05/05	ATE 21974 	598332	0	 239x17,9 (16)	186888		
1.2i, 1.9SDi	DA(-)	F	11/01→05/05	ATE 21865 	598805	1(A)	 239x17,9 (16)	186888		
1.9TDi		F	11/03→05/05	LUC 23581 	598720	1	 239x17,9 (16)	186888		
1.0i, 1.2i, 1.4, 1.4FSi, 1.4TDi 1.4i, 1.6i, 1.9SDi, 1.9TDi	DA(+)	F	11/01→	ATE 21974 	598408	1	 256x21,9 (19)	186603	●186973	
1.2i, 1.4, 1.4FSi, 1.4TDi, 1.4i 1.9SDi, 1.9TDi	DA(+)	F	11/01→05/05	ATE 21974 	598332	0	 256x21,9 (19)	186603	●186983	
1.0i, 1.4TDi, 1.4i, 1.6i, 1.9SDi		F	09/02→				 256x21,9 (19)	186603		
1.9TDi		F	11/03→05/05	LUC 23581 	598667	0	 288x24,9 (22)	●197230		
2.0i		F	09/02→				 288x24,9 (22)	●197230		
1.4, 1.4TDi, 1.4i, 1.6i, 1.9SDi, 1.9TDi, 2.0i	R		09/02→	LUC 20960 	598463	0(D)	 232x9 (7)	186597		
1.4i, 1.9TDi	R		11/01→05/03	LUC 20960 	598674	1(E)	 232x9 (7)	186597		
2.0i	R		09/02→02/04	LUC 20960 	598180	0(D)	 232x9 (7)	186597		
Polo VIII (2005>)										
1.2i	DA(-)	F	04/05→07/07	ATE 21865 	598488	0	 239x17,9 (16)	186888		
	DA(-)	F	04/05→07/07	ATE 21865 	598805	1(A)	 239x17,9 (16)	186888		
1.2i, 1.4FSi, 1.4TDi, 1.4i, 1.6i 1.9SDi, 1.9TDi	DA(+)	F	04/05→	ATE 21974 	598332	0	 256x21,9 (19)	186603	●186983	
	DA(+)	F	04/05→	ATE 21974 	598408	1	 256x21,9 (19)	186603	●186973	
1.8GTI Turbo, 1.9TDi		F	04/05→	LUC 23581 	598667	0	 288x24,9 (22)	●197230		
		F	04/05→	LUC 23581 	598720	1	 288x24,9 (22)	●197230		
1.8GTI Turbo		F	05/06→	ATE 21911 	598486	1	 312x25 (23)	●197246		
1.4i, 1.6i, 1.8GTI Turbo, 1.9TDi	R		04/05→	LUC 20960 	598463	0(D)	 232x9 (7)	186597		
Polo IX (2009>)										
1.2i 60, 1.2i 70, 1.4i 85, 1.6TDI 75 1.6TDI 90		F	06/09→	ATE 21974 	598332	0	 256x21,9 (19)	186603	●186983	















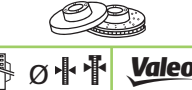

























																	
						WVA			Valeo						Valeo		
VOLKSWAGEN  (.../...)																	
Polo IX (2009>) (.../...)																	
1.6TDI 105	F	06/09→	ATE 23587		598635	1		288x24,9 (22)	●	197230							
	R	06/09→	LUC 20960		598463	0(D)		232x9 (7)		186597							
Quantum (81>88)																	
1.7, 1.8, 2.2, 2.2i	F	08/81→03/88						239x11,9 (10)		186245							
2.2	F	01/85→07/88						256x19,9 (18)		186247							
	R	01/85→07/88						239x9,9 (8)		186249							
Santana (81>84)																	
1.3, 1.6, 1.6D, 1.6TD, 1.8, 1.8i	F	08/81→12/84	VW 20887		598128	0		239x11,9 (10)		186245	186912						
1.9, 2.0i, 2.2i	F	08/81→12/84	VW 20887		598124	0		239x19,9 (18)		186246							
Scirocco (74>90)																	
1.1, 1.3, 1.5, 1.6, 1.7	F	08/81→07/83	ATE 20228		598099	0		239x11,9 (10)		186245							
1.3, 1.5, 1.6	F	08/80→07/90	VW 20887		598128	0		239x11,9 (10)		186245	186912						
1.6, 1.7, 1.8	F	08/80→07/90	VW 20887		598124	0		239x19,9 (18)		186246							
1.8	F	10/85→07/90	LUC 20901		598016	2		239x19,9 (18)		186246							
	F	08/83→07/90	VW 20887		598128	0		239x19,9 (18)		186246							
	R	10/85→07/90	LUC 20960		598180	0(D)		226x10 (8)		186288	186961						
Scirocco (2008>)																	
1.4TSI, 2.0TDI	F	08/08→	ATE 23587		598635	1		288x25 (22)		186755							
2.0TFSI 147KW 155KW	F	08/08→	ATE 23587		598635	1		312x25 (22)	●	197242							
2.0TFSI 188KW 195KW	F	11/09→	ATE 23801		598863	1		345x30 (27)	●	197197							
1.4TSI, 2.0TDI	R	08/08→	LUC 20960		598463	0(D)		255x10 (8)		186857							
2.0TFSI 155KW	R	11/09→	LUC 23914		598752	0		260x12 (10)		186833							
2.0TFSI 147KW 188KW 195KW	R	08/08→	LUC 23914		598752	0		286x12 (10)	●	197031							
Sharan (95>2000)																	
1.8i Turbo, 1.9TDi, 2.0i, 2.8i VR6	F	09/95→02/00	ATE 20676		598067	0		288x25 (21)	●	197236							
	R	09/95→02/00	LUC 20960		598463	0(D)		268x10 (8)		186624							

									
VOLKSWAGEN  (.../...)									
Sharan (2000>2003)									
1.8i Turbo, 1.9TDi, 2.0i	☉ 15"	F	04/00→05/01	ATE 20676 	598489	1 (A)	 288x25 (21)	● 197236	
1.9TDi, 2.0i	☉ 16"	F	05/01→05/03	ATE 23034	598801	2	 300x26 (22)	● 197239	
1.8i Turbo, 1.9TDi, 2.8i V6 2.8i VR6	☉ 16"	F	04/00→05/03	ATE 23269 	598565	2	 313x25,9 (22)	186800	
1.8i Turbo, 1.9TDi, 2.0i		R	04/00→05/01	LUC 20960 	598681	1 (A+D)	 268x10 (8)	186624	
1.8i Turbo, 1.9TDi, 2.0i, 2.8i V6, 2.8i VR6		R	04/00→05/03	LUC 23446 	598650	2	 294x13,6 (11,5)	186801	
Sharan (2003>2010)									
1.9TDi, 2.0TDi, 2.0i		F	06/03→	ATE 23034	598801	2	 300x26 (22)	● 197239	
1.8i Turbo, 1.9TDi, 2.8i VR6		F	06/03→	ATE 23269 	598565	2	 313x25,9 (22)	186800	
1.9TDi, 2.0TDi, 2.0i		R	06/03→	LUC 20960 	598681	1 (A+D)	 268x10 (8)	186624	
1.8i Turbo, 1.9TDi, 2.8i VR6		R	06/03→	LUC 23446 	598650	2	 294x13,6 (11,5)	186801	
1.9TDi		R	06/05→	LUC 23446 	598650	2	 280x24 (20)	186682	
Sharan (2010>)									
1.4 TSi, 2.0 TDi		F	05/10→				 312x25 (22)	● 197242	
2.0 TFSi		F	11/10→				 314x30		
1.4 TSi, 2.0 TDi, 2.0 TFSi		R	05/10→	LUC 23914 	598752	0	 286x12 (10)	● 197031	
Touran I (2003>2006)									
1.6i, 1.9TDi, 2.0i		F	02/03→11/06	ATE 23587 	598635	1	 288x25 (22)	186755	
1.4TSi, 1.6FSi, 2.0FSi, 2.0TDi		F	02/03→11/06	ATE 23587 	598635	1	 312x25 (22)	● 197242	
1.6i, 1.9TDi, 2.0i		R	02/03→11/06	LUC 23914 	598752	0	 260x12 (10)	186833	
1.4TSi, 1.6FSi, 2.0FSi, 2.0TDi		R	02/03→11/06	LUC 23914 	598752	0	 286x12 (10)	● 197031	
Touran II (2006>2010)									
1.6FSi, 1.6i, 1.9TDi, 2.0i		F	11/06→05/10	ATE 23587 	598635	1	 288x25 (22)	186755	
1.4TSi, 1.6FSi, 2.0FSi, 2.0TDi		F	11/06→05/10	ATE 23587 	598635	1	 312x25 (22)	● 197242	
1.6FSi, 1.6i, 1.9TDi, 2.0i		R	11/06→11/09	LUC 23914 	598752	0	 260x12 (10)	186833	
1.4TSi, 2.0FSi, 2.0TDi		R	11/06→11/09	LUC 23914 	598752	0	 286x12 (10)	● 197031	

																	
						WVA			Valeo						Valeo		
VOLKSWAGEN  (.../...)																	
Touran II (2006>2010) (.../...)																	
1.4TSi, 1.6FSi, 1.6i, 1.9TDi, 2.0TDi, 2.0i			R	11/09→05/10													
Touran III (2010>)																	
1.2TSi, 1.4TSi, 1.6TDi, 2.0TDi			F	05/10→	ATE 23587 	598635	1		288x25 (22)	186755							
			F	05/10→					288x25 (22)	186755							
			F	05/10→	ATE 23587 	598635	1		312x25 (22)	● 197242							
			F	05/10→					312x25 (22)	● 197242							
			R	05/10→							272x10						
Vento (91>97)																	
1.9D, 1.9SDi					 TW-028 355	F	-07/95	VW 20887 	598128	0		239x11,9 (10)	186245	186912			
					 TW-028 356	F	-12/97	ATE 21866 	598066	0		239x11,9 (10)	186245				
			ABS(+)		 VW-300 000	F	-07/95	LUC 21945 	598330	0		239x11,9 (10)	186245				
			ABS(+)		 VW-300 001	F	-12/97	ATE 21866 	598403	0		239x11,9 (10)	186245				
1.8i			F	08/95→12/97	ATE 21866 	598066	0		239x11,9 (10)	186245							
1.4i, 1.6i, 1.8i, 1.9TD					 TW-028 355	F	11/91→	VW 20887 	598128	0		239x11,9 (10)	186245	186912			
1.6i, 1.8i, 1.9TD					 TW-028 356	F	-12/97	LUC 20901 	598252	0		256x12,9 (11)	186251				
1.9TD, 1.9TDi			ABS(+)	F	05/96→12/97	LUC 21945 	598330	0		256x12,9 (11)	186251						
1.6i, 1.8i, 2.0E			F	11/91→12/95	LUC 20901 	598016	2		256x19,9 (18)	186247							
1.9TDi, 2.0E			F	10/94→12/97	LUC 21945 	598330	0		256x19,9 (18)	186247							
2.0E, 2.8i, 2.8i VR6			F	11/91→07/95	LUC 21366 	● 598982	2		280x22 (20)	186313							
2.8i VR6			F	08/95→12/97	ATE 21911 	598303	0		288x25 (23)	186521							
1.8i, 1.9TDi, 2.0E			R	11/91→12/97	LUC 20960 	598180	0(D)		226x10 (8)	186288							
2.0E, 2.8i, 2.8i VR6			R	11/91→12/97	LUC 20960 	598463	0(D)		226x10 (8)	186517							
VOLKSWAGEN 																	
Caddy I (82>92)																	
1.5, 1.6, 1.6D, 1.8i			F	08/82→07/92	VW 20887 	598128	0		239x11,9 (10)	186245	186912						

															
VOLKSWAGEN  (.../...)															
Caddy II (95>2004)															
1.4i, 1.6i, 1.9D, 1.9SDi 	F	11/95→03/96	LUC 20901 	598252	0		256x12,9 (11)	186251							
1.4i, 1.6i, 1.7SDi, 1.9D, 1.9SDi, 1.9TDi 	F	03/96→06/03	LUC 21945 	598330	0		256x19,9 (18)	186247							
1.6i, 1.9D 	F	06/96→12/00	LUC 20862 	598217	0		256x19,9 (18)	186247							
Caddy III (2004>)															
1.4i, 1.9TDi, 2.0SDi	F	02/04→	ATE 21974 	598408	1		280x22 (19)	186754	●186974						
1.6i, 1.9TDi, 2.0i	F	02/04→	ATE 23587 	598635	1		288x25 (22)	186755							
2.0TDi	F	05/08→	ATE 23587 	598635	1		312x25 (22)	●197242							
1.4i, 1.9TDi, 2.0SDi	R	02/04→	LUC 20960 	598463	0(D)		255x10 (8)	186857							
1.6i, 1.9TDi, 2.0TDi, 2.0i	R	02/04→	LUC 23914 	598752	0		260x12 (10)	186833							
Crafter (2006>)															
2.5TDi	F	04/06→	BBO 29192 	598882			300x28 (25)	●187141							
	CU(+)	F	04/06→	BBO 29200 	598881			300x28 (25)	●187141						
	R	04/06→	BOS 29190 	541728	0		298x16 (14)	●197030							
	CU(+)	R	04/06→	BOS 29190 	598876			298x16 (14)	●197030						
LT I (75>96)															
2.0, 2.4, 2.4D, 2.4TD, 2.4i 2.7D 	4WD(-)	F	04/75→12/95	ATE 20392 	598110	431828		281x19,9							
2.4, 2.4D, 2.4TD	4WD(+)	F	08/85→07/91	PER 20784 	598613	0		281x19,9							
LT II (96>2003)															
2.3i, 2.5SDi, 2.5TDi, 2.8TD 2.8TDi	LT 28, LT 35	F	05/96→05/03	ATE 21576 	598044	0		276x22 (20)	*186774						
2.3i, 2.5TDi, 2.8TD 2.8TDi	 3-003 239LT 46	F	05/96→	BBO 29076 	541664	2		276x22 (20)	*186774						
2.5TDi, 2.8TDi	 3-003 240LT 46	F	→05/03	BOS 29153 	598966	2		276x22 (20)	*186774						
2.3i, 2.5SDi, 2.5TDi, 2.8TD, 2.8TDi	LT 28	R	05/96→05/03	ATE 21621 	598045	0		258,5x12 (10)	●197033						
	LT 28	R	05/96→05/03	ATE 21621 	598045	0		272x16 (14)	187045						
2.3i, 2.5SDi, 2.5TDi, 2.8TD	LT 35	R		BOS 23021 	598300	0		272x16 (14)	187045						

															
VOLKSWAGEN  (.../...)															
LT II (96>2003) (.../...)															
2.3i, 2.5SDi, 2.5TDI, 2.8TD, 2.8TDI	LT 35	R		ATE 21661		598046	0		272x16 (14)	187045					
2.3i, 2.5TDI, 2.8TD	 2-005 686LT 46	R	05/96→	BBO 29076		541664	2		285x21,9 (19)	197059					
2.3i, 2.5TDI, 2.8TD 2.8TDI	 2-005 687LT 46	R	-05/03	BOS 29153		598966	2		285x21,9 (19)	197059					
LT III (2003>2006)															
2.5TDi, 2.8TDi	LT 28, LT 35	F	06/03→07/06	ATE 21576		598044	431825		276x22 (20)	* 186774					
	LT 46	F	06/03→07/06	BOS 29153		598966	2		276x22 (20)	* 186774					
	LT 28	R	06/03→07/06	ATE 21621		598045	0		258,5x12 (10)	197033					
	LT 35	R	06/03→07/06	ATE 21661		598046	0		272x16 (14)	187045					
	LT 46	R	06/03→07/06	BOS 23021		598300	0		285x21,9 (19)	197059					
Taro (89>97)															
1.8, 2.4D	4WD(-)	F	02/89→03/97						257x25 (24)	186696					
2.2, 2.4D, 2.4i	4WD(+)	F	02/89→03/97	SUM 21785		598897	4		289x20 (18)	* 186547					
Transporter (67>79)															
1.3, 1.6, 1.7		F	08/70→07/72	ATE 20011		* 598111	0		278x13						
1.3, 1.6, 1.7, 1.8, 2.0		F	08/70→05/79	ATE 20011		598106	0		278,5x13						
Transporter (F24) (79>92)															
1.6D, 1.6TD, 1.8D, 1.9, 2.0, 2.1	4WD(-)	F	05/79→07/92	LUC 20979		598027	0		258x16 (13)	* 186770					
1.6D, 1.6TD, 1.9, 2.0, 2.1	4WD(-)	F	05/79→07/92	ATE 20011		598106	0		258x16 (13)	* 186770					
	4WD(-)	F	05/79→07/92	LUC 20979		598027	0		278x12,9 (11)	* 186771					
1.6, 1.6D, 1.6TD, 1.9, 2.0, 2.1	4WD(-)	F	05/79→07/92	ATE 20011		598106	0		278x12,9 (11)	* 186771					
1.6TD, 1.9, 2.1	 14"4WD(+)	F	10/84→07/92	LUC 20979		598027	0		258x16 (13)	* 186770					
	 16"4WD(+)	F	10/84→07/92	LUC 20979		598027	0		277x16 (13)	* 186520					
Transporter (F70) (90>96)															
1.8, 1.9D, 1.9TD, 2.0, 2.4D 2.5, 2.5TDI	 14"4WD(-)	F	09/90→12/95	LUC 20124		598025	0		260x16 (13)	* 186314					

															
VOLKSWAGEN  (.../...)															
Transporter (F70) (90>96) (.../...)															
1.8, 1.9D, 1.9TD 2.0, 2.4D, 2.5 2.5TDI, 2.5i	⊗ 15"4WD(+), 4WD(-)	F	09/90→05/96	LUC 21479		598622	0		280x24 (20)	186315					
	⊗ 15"4WD(+), 4WD(-)	F	09/90→05/96	LUC 21479		598622	0		282x18 (15)	● 197218					
	⊗ 15"4WD(+), 4WD(-)	F	09/90→05/96	LUC 20652		598048	0		280x24 (20)	186315					
	⊗ 15"4WD(+), 4WD(-)	F	09/90→05/96	LUC 20652		598048	0		282x18 (15)	● 197218					
2.4D, 2.5i	⊗ 15"4WD(+)	F	07/95→05/96	LUC 21479		598622	0		280x24 (20)	186682					
	⊗ 15"4WD(+)	F	07/95→05/96	LUC 20652		598048	0		280x24 (20)	186682					
	⊗ 15"4WD(+)	R	01/96→05/96	LUC 21748		598482	0(B)		280x12						
Transporter (F7D) (96>2003)															
1.9TD, 2.0i, 2.4D, 2.5TDi 2.5i	⊗ 15"4WD(-)	F	01/96→04/99	LUC 21479		598622	0		282x18 (15)	186725					
	⊗ 15"4WD(-)	F	01/96→04/99	LUC 21479		598622	0		280x24 (20)	186682					
2.8i VR6	⊗ 15"4WD(-)	F	01/96→03/98	ATE 21883		598675	0		280x24 (20)	186682					
2.5TDi, 2.8i V6, 2.8i VR6	⊗ 16"4WD(-)	F	05/97→06/03	ATE 23034		598858	1		294x13,6 (11,5)	186801					
2.5TDi, 2.8i VR6	⊗ 16"4WD(-)	F	05/97→05/00	ATE 23034		598858	1		300x26 (22)	● 197239					
1.9TD, 2.0i, 2.4D 2.5DTi, 2.5TDi 2.5i	⊗ 15"4WD(+), 4WD(-)	F	01/96→06/03	LUC 23176		598807	2		282x18 (15)	186725					
	⊗ 15"4WD(+), 4WD(-)	F	01/96→05/99	LUC 21479		598622	0		282x18 (15)	186725					
	⊗ 15"4WD(+), 4WD(-)	F	05/99→06/03	LUC 21479		598814	1		282x18 (15)	186725					
1.9TD, 2.0i, 2.4D 2.5TDi, 2.5i	⊗ 15"4WD(+), 4WD(-)	F	01/96→06/03	LUC 23176		598807	2		280x24 (20)	186682					
2.4D, 2.5DTi 2.5TDi, 2.5i 2.8i VR6	⊗ 15"4WD(+), 4WD(-)	F	01/96→05/99	ATE 21883		598675	0		280x24 (20)	186682					
2.5TDi, 2.5i	⊗ 15"4WD(+), 4WD(-)	F	05/99→06/03	LUC 21479		598814	1		280x24 (20)	186682					



VOLKSWAGEN (.../...)

Transporter (F7D) (96>2003) (.../...)









































2.5TDi, 2.5TDi 2.5i, 2.8i V6 2.8i VR6	⊙ 15"4WD(+), 4WD(-)	F	05/99→06/03	ATE 21883	598676	1(A)		186682
2.4D, 2.5TDi 2.5TDi, 2.5i 2.8i V6, 2.8i VR6	⊙ 16"4WD(+), 4WD(-)	F	05/96→06/03	ATE 23269	598565	2		186800
2.4D, 2.5TDi, 2.5TDi, 2.5i	⊙ 15"4WD(+)	F	05/96→05/99	LUC 20652	598048	0		186682
2.5TDi, 2.5i	⊙ 15"4WD(+)	F	05/99→06/03	ATE 21883	598676	1(A)		186725
1.9TD, 2.0i, 2.4D 2.5TDi, 2.5TDi 2.5i, 2.8i V6 2.8i VR6	⊙ 15"4WD(+), 4WD(-)	R	01/96→06/03	LUC 21748	598482	0(B)		
2.4D, 2.5TDi 2.5TDi, 2.5i 2.8i V6, 2.8i VR6	⊙ 16"4WD(+), 4WD(-)	R	05/96→06/03	LUC 23446	598650	2		186801

Transporter (7J/7H) (2003>2009)













































1.9TDi, 2.0i, 2.5TDi, 3.2i V6	⊙ 16"	F	04/03→11/09	ATE 23746	598651	1		186756
	⊙ 17"	F	04/03→11/09	ATE 23746	598652	1		186885
		R	04/03→11/09	LUC 23326	598671	1		186886
		R	04/03→11/09	LUC 23326	● 601004	0		186886
	3200Kg	R	04/03→2007	ATE 24367	● 598946	2		● 197243



















































Transporter (7E/7F) (2009>)



2.0TDI 102, 2.0TDI 140 2.0TDI 180, 2.0TDI 84, 2.0i	⊙ 16"	F	09/09→	ATE 23746	598651	1		186756
	⊙ 17"	F	09/09→					
		R	09/09→	LUC 23326	598671	1		186886
		R	09/09→	LUC 23326	● 601004	0		186886













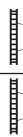





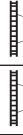

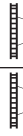

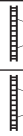

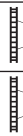













																			
VOLVO 																			
XC 60 (2008>)																			
2.4TDi, 3.0Ti			F	07/08→															
			R	07/08→	LUC 24496		● 598928	0											
XC 70 (97>99)																			
2.0i, 2.4i, 2.5i			⊙ 15"	F	12/97→12/99	ATE 21273		598616	2		280x26 (23)	186526							
			⊙ 16"	F	12/97→12/99	ATE 21273		598616	2		302x26 (23)	● 197056							
			 587441	R	12/97→	LUC 21385		598621	0		283x10								
			 587442	R	→12/99	ATE 23075		598480	0		283x10								
XC 70 (2000>2007)																			
2.3i Turbo, 2.4TDi, 2.4i Turbo 2.5T			⊙ 15"	F	01/00→03/07	ATE 23072		598479	0		286x26 (23)	186789							
2.4TDi, 2.5T			⊙ 15", 16"	F	08/02→03/07	ATE 23072		598479	0		305x28 (25)	186741							
2.3i Turbo, 2.5T			⊙ 16"	F	01/00→03/07	ATE 23072		598479	0		305x28 (25)	186741							
2.4TDi, 2.4i Turbo, 2.5T			⊙ 17"	F	09/00→03/07	ATE 23072		598479	0		320x								
2.3i Turbo, 2.4TDi, 2.4i Turbo, 2.5T				R	01/00→03/07	ATE 23075		598480	0		288x12 (10)	186841							
XC 70 (2007>)																			
2.4TDi, 3.0T6, 3.2i			⊙ 16"	F	03/07→	ATE 24123		598879	0		300x28 (26)	● 197055							
			⊙ 17"	F	03/07→						316x								
			⊙ 18"	F	03/07→	ATE 24142		● 601007	0		336x								
Handbrake mechanic				R	03/07→														
Handbrake electric				R	03/07→	LUC 24496		● 598928	0										
XC 90 (2002>)																			
2.4TDi, 2.5T, 2.9i, 3.2i V6 4.4i V8			⊙ 16"	F	05/02→	ATE 23590		● 601030	0		316x28 (25)	● 197057							
			⊙ 17"	F	05/02→	ATE 24141		598657	0		336x30								
				R	05/02→	ATE 24011		598829	0		308x20								











































			R P F		WVA		Valeo		Valeo		Valeo	
VOLVO												
240 (82>93)												
2.0, 2.4D 	F	09/82→1993	LUC 20152		598337	0		263x14,3 (12,7)	186254			
2.0, 2.1 Turbo, 2.3, 2.4D 	F	09/82→07/93	LUC 20152		598337	0		263x22 (20,4)	186255			
	R	09/82→06/84	ATE 20467		598270	0		281x9,6 (8,4)	186256			
	R	09/82→07/93	ATE 20088		598338	0		281x9,6 (8,4)	186256			
242 (74>84)												
2.1i 	F	08/74→02/79						263x14,3 (12,7)	186254			
2.1i, 2.3i 	F	08/74→07/79	LUC 20152		598337	0		263x14,3 (12,7)	186254			
	R	08/74→07/79	ATE 20467		598270	0		281x9,6 (8,4)	186256			
	R	08/74→07/79	ATE 20088		598338	0		281x9,6 (8,4)	186256			
244 (79>82)												
2.0, 2.3, 2.4D 	F	03/79→08/82	LUC 20152		598337	0		263x14,3 (12,7)	186254			
	R	03/79→08/82	ATE 20467		598270	0		281x9,6 (8,4)	186256			
	R	03/79→08/82	ATE 20088		598338	0		281x9,6 (8,4)	186256			
245 (79>82)												
2.0, 2.4D, 2.4D D6 	F	07/79→08/82	LUC 20152		598337	0		263x14,3 (12,7)	186254			
2.1 Turbo 	F	07/81→08/82	LUC 20152		598337	0		263x22 (20,4)	186255			
2.0, 2.1 Turbo, 2.4D, 2.4D D6 	R	07/79→08/82	ATE 20467		598270	0		281x9,6 (8,4)	186256			
	R	07/79→08/82	ATE 20088		598338	0		281x9,6 (8,4)	186256			
262 (78>80)												
2.7 	F	08/78→07/80	LUC 20152		598337	0		263x22 (20,4)	186255			
	R	08/78→07/80	ATE 20467		598270	0		281x9,6 (8,4)	186256			
	R	08/78→07/80	ATE 20088		598338	0		281x9,6 (8,4)	186256			
264 (78>82)												
2.3, 2.4D, 2.7, 2.8 	F	08/78→07/82	LUC 20152		598337	0		263x22 (20,4)	186255			
	R	08/78→07/82	ATE 20467		598270	0		281x9,6 (8,4)	186256			
	R	08/78→07/82	ATE 20088		598338	0		281x9,6 (8,4)	186256			









































															
VOLVO  (.../...)															
265 (78>85)															
2.7, 2.8 	F	08/78→07/85	LUC 20152		598337	0		263x22 (20,4)	186255						
	R	08/78→07/85	ATE 20467		598270	0		281x9,6 (8,4)	186256						
	R	08/78→07/85	ATE 20088		598338	0		281x9,6 (8,4)	186256						
340 (82>91)															
1.4, 1.6D, 1.7, 2.0	F	09/82→07/91	LUC 20574		598205	0		239x12,7 (11,4)	* 186257						
343 (76>82)															
1.4	F	02/76→1979						239x12,7 (11,4)	* 186257						
1.4, 2.0	F	08/79→08/82	LUC 20574		598205	0		239x12,7 (11,4)	* 186257						
345 (79>82)															
1.4, 1.9	F	08/79→08/82	LUC 20574		598205	0		239x12,7 (11,4)	* 186257						
360 (82>89)															
1.6D, 2.0	F	09/82→07/89	LUC 20574		598205	0		239x12,7 (11,4)	* 186257						
440 (88>97)															
1.6i, 1.7, 1.7i, 1.7i Turbo, 1.8i, 1.9TD 2.0i	F	10/88→06/97	LUC 21217		598015	0		260x12 (10,8)	186258						
	F	10/88→06/97						256x22							
	R	10/88→06/97	ATE 20756		598291	0		228x9 (8)	186311						
460 (90>97)															
1.6, 1.7, 1.7 Turbo, 1.7i, 1.7i Turbo, 1.8i 1.9TD, 2.0	F	01/90→06/97	LUC 21217		598015	0		260x12 (10,8)	186258						
	F	01/90→06/97						256x22							
	R	01/90→06/97	ATE 20756		598291	0		228x9 (8)	186311						
480 (86>95)															
1.7, 1.7i Turbo			 538519	F	07/86→	LUC 21010		598102	0		260x12 (10,8)	186258			
1.7, 1.7i Turbo, 2.0			 538520	F	→07/95	LUC 21217		598015	0		260x12 (10,8)	186258			
1.7i Turbo, 2.0				F	01/90→07/95						256x22				
1.7, 1.7i Turbo, 2.0				R	07/86→07/95	ATE 20756		598291	0		228x9 (8)	186311			





















			R P F		WVA		Valeo		Valeo		Valeo	
VOLVO (.../...)												
740 (84>92)												
2.0, 2.3, 2.4D 	F	07/84→07/87	LUC 20740		598221	0		262,5x22 (20)	* 186776			
	F	07/84→08/92	BDX 21233		598257	0		262,5x22 (20)	* 186776			
2.3 	F	07/85→08/92	LUC 20164		* 598695			262,5x22 (20)	* 186776			
	2.3, 2.4D 	F	07/85→08/92	BDX 21233		598257	0		263x22 (20)	* 186263		
F		07/85→08/92	LUC 20164		* 598695			263x22 (20)	* 186263			
2.0, 2.3, 2.4D, 2.4TD 	ABS(+)	F	07/85→08/92	BDX 21233		598257	0		280x26 (24)	* 186289		
	ABS(+)	F	07/85→08/92	LUC 20164		* 598695			280x26 (24)	* 186289		
2.0 Turbo, 2.3 	F	07/84→06/85	LUC 20740		598221	0		287x22				
	F	07/84→06/85	BDX 21233		598257	0		287x22				
2.0, 2.0 Turbo, 2.3, 2.4D 	ABS(+)	F	07/84→07/87	LUC 20740		598221	0		287x22			
	ABS(+)	F	07/84→07/87	BDX 21233		598257	0		287x22			
2.0, 2.0 Turbo, 2.3, 2.3 Turbo 2.3 Turbo Intercooler, 2.4D 2.4TD 	ABS(+)	F	08/84→08/91	LUC 20740		598221	0		287x22 (20)	186264		
	ABS(+)	F	08/84→08/91	BDX 21233		598257	0		287x22 (20)	186264		
2.3 	F	07/85→08/92	BDX 21233		598257	0		322x30				
	F	07/85→08/92	LUC 20164		* 598695			322x30				
2.0, 2.0 Turbo, 2.0 Turbo Intercooler, 2.3 2.3 Turbo, 2.3 Turbo Intercooler, 2.4D 2.4TD 	R	07/84→08/92	ATE 20467		598270	0		281x9,6 (8,4)	186256			
760 (82>90)												
2.3 Turbo, 2.4TD, 2.4TD Intercooler, 2.8 	F	02/82→1990	LUC 20740		598221	0		280x14				
	F	02/82→1990	BDX 21233		598257	0		280x14				
2.3 Turbo, 2.3 Turbo Intercooler, 2.4TD 2.4TD Intercooler, 2.8 	F	02/82→1990	LUC 20740		598221	0		287x22 (20)	186264			
	F	02/82→1990	BDX 21233		598257	0		287x22 (20)	186264			









































	
VOLVO  (.../...)	
760 (82>90) (.../...)	
2.3 Turbo, 2.3 Turbo Intercooler, 2.4TD 2.4TD Intercooler, 2.8 	R 02/82-1990 LUC 21385  598621 0  265x10
2.4TD Intercooler, 2.8 	R 07/86-1990 ATE 20467  598270 0  281x9,6 (8,4) 186256
780 (85>91)	
2.0 Turbo, 2.4TD Intercooler, 2.8 V6 	F 03/85-07/91 LUC 20740  598221 0  287x22 (20) 186264
	F 03/85-07/91 BDX 21233  598257 0  287x22 (20) 186264
	F 07/90-07/91  598257 0  280x26 (24) * 186289
	R 03/85-07/87 ATE 20467  598270 0  281x9,6 (8,4) 186256
	R 07/87-07/91 LUC 21385  598621 0  265x10
2.4TD Intercooler 	R 07/90-07/91 LUC 21385  598621 0  280x26 (24) * 186289
850 (91>96)	
2.3 Turbo 	F 04/94-08/95 ATE 21273  598616 2  256x22
2.0, 2.5 	F 06/91-07/93  598257 0  280x26
2.0, 2.0 Turbo, 2.5, 2.5TDi, 2.5i Turbo 	F 01/94-12/96 ATE 21273  598616 2  280x26 (23) 186526
2.0, 2.5 	R 06/91-12/96 ATE 20467  598270 0  295x9,6
2.0, 2.0 Turbo, 2.3 Turbo, 2.5, 2.5TDi 2.5i Turbo 	R 12/92-12/96 ATE 20467  598270 0  295x9,6 (8,4) 186528
2.0, 2.0 Turbo, 2.3 Turbo, 2.5, 2.5TDi	P 06/91-12/96  562728
940 (90>98)	
2.0, 2.0 Turbo, 2.3, 2.3 Turbo, 2.4TD	F 09/90-07/93 BDX 21233  598257 0  287x22 (20) 186264
2.0, 2.4TD	F 09/90-06/93 LUC 20740  598221 0  287x22 (20) 186264
	ABS(+) F 09/90-06/93 LUC 20164  * 598695  287x22 (20) 186264
2.0, 2.3, 2.4TD	ABS(+) F 09/90-07/93 BDX 21233  598257 0  280x26 (24) * 186289
2.0, 2.4TD	ABS(+) F 09/90-08/94 LUC 20164  * 598695  280x26 (24) * 186289
	ABS(+) F 09/90-06/93 LUC 20740  598221 0  280x26 (24) * 186289
2.3 Turbo	F 09/94-06/98 LUC 20164  * 598695  280x26 (23) 186526
2.0, 2.0 Turbo, 2.3, 2.3 Turbo, 2.4TD	R 09/90-06/98 ATE 20467  598270 0  281x9,6 (8,4) 186256

		R P F		2+2		WVA		Valeo		Valeo	
VOLVO (.../...)											
960 (90>97)											
2.0 Turbo, 2.3 Turbo, 2.4TD, 2.8i, 3.0 	F	09/90→08/93	BDX 21233 	598257	0		287x22 (20)	186264			
2.4TD, 2.8i 	F	09/90→08/93	LUC 20740 	598221	0		287x22 (20)	186264			
2.8i  ABS(+)	F	09/90→08/91	LUC 20164 	* 598695			287x22 (20)	186264			
2.4TD, 2.8i  ABS(+)	F	09/90→08/93	BDX 21233 	598257	0		280x26 (24)	* 186289			
2.0 Turbo, 2.4TD, 2.8i  ABS(+)	F	09/90→08/94	LUC 20740 	598221	0		280x26 (24)	* 186289			
2.3 Turbo, 2.8i  ABS(+)	F	09/90→08/94	LUC 20164 	* 598695			280x26 (24)	* 186289			
2.3 Turbo, 2.5 	F	09/94→01/97	LUC 20164 	* 598695			280x26 (23)	186526			
2.0 Turbo, 2.3 Turbo, 2.4TD, 2.5, 2.8i 3.0 	R	09/90→01/97	LUC 21385 	598621	0		265x10				
2.0 Turbo, 2.3 Turbo, 2.4TD, 2.5, 2.8i 3.0 	R	09/90→01/97	ATE 20467 	598270	0		281x9,6 (8,4)	186256			
C30 (2006>)											
1.6D Turbo, 1.6i, 1.8i 1.8i Flexifuel, 2.0D Turbo, 2.0i 2.4TDi, 2.4i	☉ 15"	F	10/06→	ATE 23723 	598649	0		278x25 (23)	186819		
	☉ 16"	F	10/06→	ATE 23723 	598649	0		300x25 (23)	186863		
		R	10/06→	TVS 23483 	● 601044	0		280x10,9 (9)	186843		
S40 (95>2004)											
1.6i, 1.8i, 1.9TD, 1.9i Turbo, 2.0i 2.0i Turbo	F	10/95→12/97	LUC 21920 	598318	2		256x24 (22,4)	186648			
1.6i, 1.8i, 1.9TD, 1.9TDCi, 1.9TDi 1.9i Turbo, 2.0i, 2.0i Turbo	F	01/98→03/04	LUC 21983 	598493	0		281x24 (21,5)	186707			
	R	10/95→03/04	LUC 21861 	598319	2		260x10 (8,4)	186647			
S40 (2004>)											
1.6D, 1.6i, 1.8i, 2.0D, 2.0i 2.4D5, 2.4i, 2.5i	☉ 15"	F	03/04→	ATE 23723 	598649	0		278x25 (23)	186819		
	☉ 16"	F	03/04→	ATE 23723 	598649	0		300x25 (23)	186863		

																		
VOLVO  (.../...)																		
S40 (2004>) (.../...)																		
1.6D, 1.6i, 1.8i, 2.0D, 2.0i 2.4D5, 2.4i	☉ 17"	F	03/04→	ATE 23762 	598822	0		320x25 (23)	● 197143									
2.5i	☉ 17"  361422	F	03/04→	ATE 23762 	598822	0		320x25 (23)	● 197143									
	☉ 17"  361423	F		ATE 23762 	598822	0		320x										
1.6D, 1.6i, 1.8i, 2.0D, 2.0i, 2.4D5, 2.4i 2.5i		R	03/04→	TVS 23483 	● 601044	0		280x10,9 (9)	186843									
1.6D, 1.6i, 1.8i, 2.0D, 2.4i 2.5i	☉ 17"	R	03/04→	ATE 23723 	● 601005	0												
V40 (95>2004)																		
1.6i, 1.8i, 1.9T, 1.9TD, 2.0T Turbo, 2.0i		F	10/95→12/97	LUC 21920 	598318	2		256x24 (22,4)	186648									
1.6i, 1.8i, 1.9T, 1.9TD, 1.9TDi, 2.0T Turbo 2.0i, 2.0i Turbo		F	01/98→03/04	LUC 21983 	598493	0		281x24 (21,5)	186707									
		R	10/95→03/04	LUC 21861 	598319	2		260x10 (8,4)	186647									
V50 (2004>)																		
1.6D, 1.6i, 1.8i, 1.8i Flexifuel 2.0D, 2.0i, 2.4D5, 2.4i, 2.5i	☉ 15"	F	03/04→	ATE 23723 	598649	0		278x25 (23)	186819									
	☉ 16"	F	03/04→	ATE 23723 	598649	0		300x25 (23)	186863									
	☉ 17"  373967	F	03/04→	ATE 23762 	598822	0		320x25 (23)	● 197143									
1.6D, 1.8i 1.8i Flexifuel, 2.0D 2.0i, 2.4D5, 2.4i, 2.5i	☉ 17"  373968	F		ATE 23762 	598822	0		320x										
1.6D, 1.6i, 1.8i, 1.8i Flexifuel, 2.0D, 2.0i 2.4D5, 2.4i, 2.5i		R	03/04→	TVS 23483 	● 601044	0		280x10,9 (9)	186843									
1.6D, 1.6i, 1.8i, 2.0D, 2.4i, 2.5i		R	03/04→	ATE 23723 	● 601005	0												
S60 (2000>)																		
2.0i Turbo, 2.3i Turbo, 2.4TDi 2.4i, 2.4i CNG, 2.4i GPL 2.4i Turbo, 2.5i Turbo	☉ 15"	F	08/00→	ATE 23072 	598479	0		286x26 (23)	186789									
	☉ 16"	F	08/00→	ATE 23072 	598479	0		305x28 (25)	186741									

																			
VOLVO  (.../...)																			
S60 (2000>) (.../...)																			
2.0i Turbo, 2.3i Turbo, 2.4TDi 2.4i, 2.4i CNG, 2.4i GPL, 2.4i Turbo, 2.5i Turbo (...)			⊙ 17"	F	08/00→	ATE 23072 	598479	0		320x									
2.5i Turbo				F	03/03→04/07					330x									
2.0i Turbo, 2.3i Turbo, 2.4TDi, 2.4i 2.4i CNG, 2.4i GPL, 2.4i Turbo, 2.5i Turbo				R	08/00→	ATE 23075 	598480	0		288x12 (10)									186841
2.5i Turbo			⊙ 16"	R	02/04→					305x28 (25)									186741
				R	03/03→04/07														
C70 (97>2005)																			
2.0i Turbo, 2.3i Turbo, 2.4i 2.4i Turbo, 2.5i, 2.5i Turbo			⊙ 15"	F	03/97→12/05	ATE 21273 	598616	2		280x26 (23)									186526
			⊙ 15"	F	03/97→12/05	ATE 21911 	598481	0		280x26 (23)									186526
			⊙ 16"	F	03/97→12/05	ATE 21273 	598616	2		302x26 (23)									197056
			⊙ 16"	F	03/97→12/05	ATE 21911 	598481	0		302x26 (23)									197056
				R	03/97→12/05	ATE 20467 	598270	0		295x9,6 (8,4)									186528
				P	03/97→12/05		562728												
C70 CC (2006>)																			
2.0D, 2.4, 2.4TDi, 2.4i 2.5i Turbo			⊙ 15"	F	01/06→	ATE 23723 	598649	0		278x25 (23)									186819
			⊙ 16"	F	01/06→	ATE 23723 	598649	0		300x25 (23)									186863
2.4TDi, 2.5i Turbo				F	01/06→12/07	ATE 23762 	598822	0		320x25 (23)									197143
				F	01/08→	ATE 23762 	598822	0		320x									
2.0D, 2.4, 2.4TDi, 2.4i, 2.5i Turbo				R	01/06→	TVS 23483 	601044	0		280x10,9 (9)									186843
S70 (96>2000)																			
2.0i, 2.0i Turbo, 2.3i 2.3i Turbo, 2.4TDi, 2.4i 2.4i GPL, 2.4i Turbo, 2.5i 2.5i GPL, 2.5i Turbo			⊙ 15"	F	12/96→11/00	ATE 21273 	598616	2		280x26 (23)									186526
2.0i, 2.3i, 2.3i Turbo, 2.4i 2.4i GPL, 2.4i Turbo, 2.5i			⊙ 16"	F	12/96→11/00	ATE 21273 	598616	2		302x26 (23)									197056

																							
VOLVO  (.../...)																							
S70 (96>2000) (.../...)																							
2.0i, 2.0i Turbo, 2.3i, 2.3i Turbo, 2.4TDi			R			12/96→11/00			ATE 20467 			598270			0								
2.4i, 2.4i GPL, 2.4i Turbo, 2.5i, 2.5i GPL																							
2.5i Turbo			R			12/96→11/00																	
2.4i, 2.4i Turbo						05/99→			LUC 21385 			598621			0			283x10					
						→11/00			ATE 23075 			598480			0			283x10					
2.0i, 2.0i Turbo, 2.3i, 2.3i Turbo, 2.4TDi			R			12/96→11/00			ATE 20467 			598270			0			295x9,6 (8,4) 186528					
2.4i, 2.4i GPL, 2.4i Turbo, 2.5i, 2.5i GPL																							
2.5i Turbo			P			12/96→11/00						562728											
V70 (96>2000)																							
2.0i, 2.0i Turbo, 2.3i			⊙ 15"			F			12/96→03/00			ATE 21273 			598616			2			280x26 (23) 186526		
2.3i Turbo, 2.4TDi, 2.4i																							
2.4i GPL, 2.4i Turbo, 2.5i																							
2.5i Turbo			⊙ 16"			F			12/96→03/00			ATE 21273 			598616			2			302x26 (23) ● 197056		
2.0i Turbo, 2.3i Turbo						R			12/96→			LUC 21385 			598621			0			283x10		
2.4i, 2.4i Turbo																							
2.5i Turbo						R			→03/00			ATE 23075 			598480			0			283x10		
2.0i, 2.0i Turbo, 2.3i, 2.3i Turbo, 2.4TDi						R			12/96→03/00			ATE 20467 			598270			0			295x9,6 (8,4) 186528		
2.4i, 2.4i GPL, 2.4i Turbo, 2.5i, 2.5i Turbo						P			12/96→03/00						562728								
V70 (2000>2007)																							
2.0i Turbo, 2.3i, 2.4TDi, 2.4i			⊙ 15"			F			01/00→04/07			ATE 23072 			598479			0			286x26 (23) 186789		
2.5T, 2.5TDi						F			01/00→04/07			ATE 23072 			598479			0			305x28 (25) 186741		
						F			01/00→04/07			ATE 23072 			598479			0					
2.5T						F			01/03→04/07														

																	
VOLVO  (.../...)																	
V70 (2000>2007) (.../...)																	
2.0i Turbo, 2.3i, 2.4TDi, 2.4i, 2.5T, 2.5TDi		R	01/00→04/07	ATE 23075 	598480	0		288x12 (10)	186841								
2.5T		R	01/03→04/07														
V70 (2007>)																	
2.0TD, 2.0i, 2.4TDi, 2.5i, 3.0Ti 3.2i		⊙ 16"	F 03/07→	ATE 24123 	598879	0		300x28 (26)	● 197055								
		⊙ 17"	F 03/07→					316x									
		⊙ 18"	F 03/07→	ATE 24142 	● 601007	0		336x									
			R 03/07→	LUC 24496 	● 598928	0		310,5x11									
			R 03/07→					302x22									
S80 (98>2006)																	
2.0i, 2.0i Turbo, 2.4TDi, 2.4i 2.4i CNG, 2.4i GPL, 2.4i Turbo 2.5i Turbo, 2.8i, 2.9i, 3.0i		⊙ 15"	F 06/98→02/06	ATE 23072 	598479	0		286x26 (23)	186789								
		⊙ 16"	F 06/98→02/06	ATE 23072 	598479	0		305x28 (25)	186741								
			R 06/98→02/06	ATE 23075 	598480	0		288x12 (10)	186841								
S80 (2006>)																	
2.0, 2.0i, 2.0i Flexifuel, 2.4TDi 2.5T, 2.5i Flexifuel, 3.0i, 3.2i 4.4i V8		⊙ 16"	F 03/06→	ATE 24123 	598879	0		300x28 (26)	● 197055								
		⊙ 17"  35287	F 03/06→	ATE 24142 	● 601007	0		316x									
		⊙ 17"  35288	F					316x									
		⊙ 18"	F 03/06→	ATE 24142 	● 601007	0		336x									
			R 03/06→	LUC 24496 	● 598928	0		310,5x11									
			R 03/06→					302x22									
S90 (96>98)																	
3.0			F 09/96→05/98	LUC 20164 	* 598695			280x26 (23)	186526								
			R 09/96→05/98	LUC 21385 	598621	0		277x12									

Pads and Discs

Plaquettes et Disques

Pastillas y Discos

Pastillas e Discos

Pastiglie e Dischi

Blokjes en Schijven

Bremsbeläge und Bremsscheiben

Klocki i Tarcze

Balatalari ve Diskleri

Κολοдки и диски

Δισκόφρενα & Δισκόπλακες

刹车片和刹车盘

بطانات و قرص



Valeo		VVA	Valeo	
540436			2	IVECO Daily (89>96) 165 Daily (96>99) 165
541641			4	IVECO Daily (89>96) 165
541655			2	MERCEDES Sprinter (95>2006) 215
541662	29121 880		2	IVECO Daily (96>99) 165 Daily (99>) 165
541663			2	IVECO Daily (99>) 165
541664			2	MERCEDES Sprinter (95>2006) 214 VOLKSWAGEN LT II (96>2003) 380
541683			2	RENAULT Master Propulsion I (99>2004) ... 297 Master Propulsion II (2004>) 297 RVI Mascott (99>) 302
541705	29123 880		2	IVECO Daily (99>) 166 Daily (2006>) 166
541717			2	IVECO Daily (99>) 165
541728			0	MERCEDES Sprinter II (2006>) 215 VOLKSWAGEN Crafter (2006>) 380
541733			2	NISSAN Cabstar (98>2006) 240
541734			0	IVECO Daily (2006>) 166
541735	29232 886		0	IVECO Daily (2006>) 166
541736	24486 856		2	FORD Transit (2006>) 144
541737			2	NISSAN Cabstar (2006>) 240
541738			2	NISSAN Cabstar (2006>) 240
562726				MERCEDES Class E (W210) (95>2003) 207 Class S (W140) (91>93) 209 Class S (W140) (93>99) 210
562728				VOLVO 850 (91>96) 388 C70 (97>2005) 391 S70 (96>2000) 392 V70 (96>2000) 392
562736				LAND ROVER Defender (90>2007) 182 Discovery (98>2004) 183 Land 90 183 Land 110 183 Range Rover (81>86) 184 Range Rover (86>94) 184

Valeo		VVA	Valeo	
562738				PEUGEOT 406 (95>2004) 266 607 (2000>2004) 268
562739				CITROËN Evasion (94>98) 96 Evasion (98>2002) 96 Synergie (95>98) 98 Synergie (98>2002) 98 LANCIA Zeta (94>2002) 181 PEUGEOT 806 (94>98) 268 806 (98>2002) 268
562745				MERCEDES Class V (96>2002) 214 MERCEDES Vito (96>2003) 215
562767				MERCEDES 190 (201) (82>93) 197 200/300 (W124) (84>93) 199 Class A (W168) (97>2004) 199 Class A (W169) (2004>2008) 199 Class B (W245) (2005>2008) 199 Class C (W202) (93>2001) 201 Class CLK (W208) (97>2003) 204 Class E (W124) (93>98) 206 Class E (W210) (95>2003) 207 Class SL (129) (89>2001) 211 Class SLK (170) (96>2003) 213
562805				BMW X3 (2003>2006) 73 X5 (2000>2006) 74 BMW Series 5 (E60/61) (2003>) 82 Series 6 (E63/64) (2003>) 82 Series 7 (E65) (2001>2008) 84 Series 7 (E66) (2002>2008) 84 M3 (E46) (2000>2006) 85 M5 (E39) (99>2003) 85 PORSCHE Cayenne (2003>) 272 VOLKSWAGEN Touareg I (2002>2006) 357 Touareg II (2006>) 357
562807				MERCEDES Class C (W203) (2000>2003) 201 Class C (W203) (2004>) 202 Class CLK (W209) (2002>2009) ... 204 Class SLK (171) (2004>2007) ... 213 Vaneo (2001>) 214
562808				BMW Series 1 (E87) (2004>) 75 Series 3 (E46) (98>2006) 78 Series 3 (E90/91/92/93) (2005>) .. 79 Z4 (E85/86) (2002>2009) 86
564007				MERCEDES Class CL (W215) (99>2006) 202 Class S (W220) (98>2004) 210
564008				TOYOTA Prius (2003>2009) 338

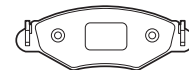

Valeo		WVA	Valeo	
564009				OPEL Frontera A (91>98) 242 Frontera B (98>2005) 242 VAUXHALL Frontera A (91>98) 342 Frontera B (98>2005) 342
564010				MERCEDES Class ML (163) (97>2005) 196
564014				LAND ROVER Defender (90>2007) 182 Discovery (98>2004) 183 Range Rover (86>94) 184 Range Rover (94>2002) 184
564015				LEXUS LS400 (89>94) 187
564016				HONDA Odyssey (97>) 154 Shuttle (94>2000) 155
564018				PEUGEOT 406 (95>2004) 266 607 (2000>2004) 268
564028				MG MG ZT (2001>2005) 217 ROVER 75 (99>2005) 298
598000	21573	610	0	MERCEDES MB100 214
598001	20706	532	2 (A)	NISSAN Trade (84>) 241

Valeo		WVA	Valeo	
598002	20772	537	2 (B)	DACIA Logan (2004>) 105 Sandero (2008>) 106 RENAULT Super 5 (84>96) 275 R9 (81>88) 275 R11 (82>89) 275 R18 (77>86) 276 R19 (88>92) 277 R19 (92>95) 277 R20 (75>84) 277 R21 (86>94) 278 R21 Nevada Savanna (86>95) ... 278 R25 (83>92) 279 R30 (75>84) 279 Alpine GT D500 279 Clio I (90>96) 280 Clio I (96>98) 280 Clio II (98>2001) 280 Clio II (2001>) 280 Clio Campus Evolution (2009>) .. 282 Fuego (79>85) 283 Lutecia (Japan) (94>98) 287 Mégane (95>99) 287 Mégane (98>2003) 287 Mégane Classic (96>99) 288 Mégane Classic (99>2002) 288 Mégane Scenic (96>99) 290 Thalia (2001>) 293 Twingo I (93>98) 294 Twingo II (98>2007) 294 Twingo III (2007>) 294 RENAULT Express (85>91) 295 Express (91>2003) 295 Extra (91>97) 295 Rapid (91>98) 297
*598003	21156	570	2	ALFA ROMEO 164 (87>92) 49
598004	20901	546	0	AUDI 80 (81>86) 55 90 (84>87) 57 Coupé (80>88) 67
598005	21272	579	2	ALFA ROMEO 33 (89>94) 44
598006	21227	577	2 (A)	ALFA ROMEO 164 (87>92) 49 164 (92>98) 49
598007	21049	559	4 (B)	ALFA ROMEO AR8 (80>86) 54 IVECO Daily (78>89) 164
*598008	21165	571	2	ALFA ROMEO 33 (89>94) 44
598010	21227	577	2 (C)	ALFA ROMEO 155 (91>97) 47
598011	21365	589	1	FIAT Punto (93>99) 118



Valeo	WVA		
598012	21365 589	0	FIAT <ul style="list-style-type: none"> Cinquecento (92>98) 113 Panda (2003>) 118 Punto (93>99) 118 Punto II (99>2003) 119 Punto II (2003>) 119 Seicento (98>2005) 120 LANCIA <ul style="list-style-type: none"> Y Ipsilon (95>2000) 181 Y Ipsilon (2000>2003) 181
598013	21439 597	431828	MERCEDES <ul style="list-style-type: none"> Class C (W202) (93>2001) 200
598014	21626 614	0	NISSAN <ul style="list-style-type: none"> Micra (K11E) (92>2000) 236 Micra (K11E) (2000>2002) 236
598015	21217 576	0	VOLVO <ul style="list-style-type: none"> 440 (88>97) 386 460 (90>97) 386 480 (86>95) 386
598016	20901 546	2	AUDI <ul style="list-style-type: none"> 90 (84>87) 57 SEAT <ul style="list-style-type: none"> Cordoba (93>96) 307 Ibiza (93>96) 309 Toledo (91>98) 312 VOLKSWAGEN <ul style="list-style-type: none"> Corrado (88>95) 359 Golf II (83>92) 361 Golf II Cabriolet (93>98) 361 Golf III (91>99) 361 Jetta II (83>92) 369 Passat II (81>88) 371 Passat III (88>93) 371 Passat IV (93>97) 372 Scirocco (74>90) 377 Vento (91>97) 379
598017	20901 546	2	AUDI <ul style="list-style-type: none"> 80 (86>91) 55 80 (91>95) 56 Cabriolet (91>2000) 56 90 (87>91) 57 100 (71>82) 57 100 (82>90) 58 200 (79>90) 59 A4 (94>98) 61 Coupé (88>96) 68 Quattro (80>91) 68 VOLKSWAGEN <ul style="list-style-type: none"> Bora (98>2005) 358 Passat V (96>2000) 372
598018	21292 583	431822	BMW <ul style="list-style-type: none"> Series 3 (E36) (90>2001) 77 Series 3 (E46) (98>2006) 77 Z3 (E36) (96>2002) 86 Z4 (E85/86) (2002>2009) 86
598019	21520 606	2	ROVER <ul style="list-style-type: none"> 200 (89>96) 299 400 (90>95) 299



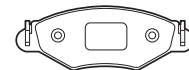









Valeo	WVA		
598020	21543 607	4	BEDFORD <ul style="list-style-type: none"> Brava (88>90) 73 ISUZU <ul style="list-style-type: none"> Trooper (81>97) 164 OPEL <ul style="list-style-type: none"> Frontera A (91>98) 241 OPEL <ul style="list-style-type: none"> Campo (88>96) 255 Campo (96>) 255 VAUXHALL <ul style="list-style-type: none"> Frontera A (91>98) 342 VAUXHALL <ul style="list-style-type: none"> Brava (88>96) 354 Brava (96>) 354
598021	21142 566	0	SUZUKI <ul style="list-style-type: none"> Jimny (98>) 322 S410/S413 322
598022	21515 604	2	HONDA <ul style="list-style-type: none"> Civic V (MA/MB) (95>2001) 149 Civic (EP) (2001>2006) 150 Civic Aerodeck (97>2001) 151 Concerto (89>96) 151 MG <ul style="list-style-type: none"> MG ZR (2001>2005) 216 ROVER <ul style="list-style-type: none"> 25 (99>2005) 298 45 (2000>2005) 298 200 (89>96) 299 200 (95>99) 299 200 Coupé/Cabriolet (96>99) 299 400 (90>95) 299 400 (95>2000) 300 800 (91>99) 300 Streetwise (2000>2005) 302
598023	21500 603	2	SANTANA <ul style="list-style-type: none"> Vitara 305 SUZUKI <ul style="list-style-type: none"> Vitara (88>98) 323 X90 (95>) 323
598024	21280 582	0	NISSAN <ul style="list-style-type: none"> Primera (P10/W10) (90>98) 237
598025	20124 502	0	VOLKSWAGEN <ul style="list-style-type: none"> Transporter (F70) (90>96) 381
598027	20979 554	0	VOLKSWAGEN <ul style="list-style-type: none"> Transporter (F24) (79>92) 381
598028	21507 603	4	CITROËN <ul style="list-style-type: none"> XM (89>94) 99 XM (94>2001) 99
598029	21295 584	4	CITROËN <ul style="list-style-type: none"> XM (89>94) 99
598030	21145 567	4	CITROËN <ul style="list-style-type: none"> AX (86>91) 91 AX (91>98) 92
598031	21631 615	4	CITROËN <ul style="list-style-type: none"> Xantia (93>97) 98 Xantia (97>2002) 99
598032	21141 566	0	FORD <ul style="list-style-type: none"> Transit (85>91) 143



















Valeo	WVA	Valeo	
598033	21394 594	2	FORD <ul style="list-style-type: none"> Cougar (98>2001) 130 Granada (92>95) 136 Mondeo (93>96) 137 Mondeo (96>2000) 137 Scorpio (92>94) 139
598034	21394 594	0	FORD <ul style="list-style-type: none"> Cougar (98>2001) 130 Granada (92>95) 136 Mondeo (93>96) 137 Mondeo (96>2000) 137 Scorpio (92>94) 139 Scorpio (94>98) 139
598035	21586 613	2	FORD <ul style="list-style-type: none"> Cougar (98>2001) 130 Mondeo (93>96) 137 Mondeo (96>2000) 137
598036	21470 598	0	FORD <ul style="list-style-type: none"> Transit (91>94) 143 Transit (94>99) 143
598037	21469 598	0	FORD <ul style="list-style-type: none"> Transit (91>94) 143 Transit (94>99) 143
598038	21430 596	2	PEUGEOT <ul style="list-style-type: none"> 205 (87>98) 259 306 (93>97) 262
598039	21353 587	0	DAEWOO <ul style="list-style-type: none"> Lanos (97>) 107 Nexia (95>) 107 JAGUAR <ul style="list-style-type: none"> Sovereign (94>) 167 XJ (94>2002) 167 XJR (94>) 168
598040	21930 656	1	ALFA ROMEO <ul style="list-style-type: none"> 145 (94>2001) 45 146 (94>2001) 46 FIAT <ul style="list-style-type: none"> Brava (95>2002) 112 Bravo (95>2002) 113 Marea (96>2002) 116 Marengo (185) (95>) 116 LANCIA <ul style="list-style-type: none"> Delta (93>99) 177
598041	21927 655	2 (A+B)	FIAT <ul style="list-style-type: none"> Barchetta (95>2003) 112 Barchetta (2003>) 112 Brava (95>2002) 112 Bravo (95>2002) 113 Marea (96>2002) 116 Marengo (185) (95>) 116 Punto (93>99) 119 LANCIA <ul style="list-style-type: none"> Dedra (94>99) 176 Delta (93>99) 177
598043	21203 574	0	FORD <ul style="list-style-type: none"> Fiesta (89>95) 132 Fiesta (95>99) 132 Ka (96>2008) 136

Valeo	WVA	Valeo	
598044	21576 611	431825	MERCEDES <ul style="list-style-type: none"> Class V (96>2002) 213 MERCEDES <ul style="list-style-type: none"> Sprinter (95>2006) 214 Vito (96>2003) 215 VOLKSWAGEN <ul style="list-style-type: none"> LT II (96>2003) 380 LT III (2003>2006) 381
598045	21621 614	0	MERCEDES <ul style="list-style-type: none"> Sprinter (95>2006) 214 VOLKSWAGEN <ul style="list-style-type: none"> LT II (96>2003) 380 LT III (2003>2006) 381
598046	21661 621	0	MERCEDES <ul style="list-style-type: none"> Sprinter (95>2006) 214 VOLKSWAGEN <ul style="list-style-type: none"> LT II (96>2003) 381 LT III (2003>2006) 381
598047	20959 552	2	HONDA <ul style="list-style-type: none"> Civic II (83>87) 148 Civic III (87>91) 149 Civic IV (91>95) 149 CRX (87>92) 151 Prelude (82>87) 154
598048	20652 526	0	VOLKSWAGEN <ul style="list-style-type: none"> Transporter (F70) (90>96) 382 Transporter (F7D) (96>2003) 383
598050	21411 595	431836 0 431836 0 431836 431836 431834	OPEL <ul style="list-style-type: none"> Calibra (89>97) 245 Omega B (94>2003) 250 Vectra A (88>95) 252 SAAB <ul style="list-style-type: none"> 900 (93>98) 304 VAUXHALL <ul style="list-style-type: none"> Calibra (90>97) 345 Cavalier (88>95) 347 Omega (94>) 350
598051	21725 628	2	HYUNDAI <ul style="list-style-type: none"> Elantra (90>95) 157 Elantra (95>2000) 158 Lantra (90>95) 159 Lantra (95>2000) 160 Sonata (88>93) 161 Sonata (93>98) 161



Valeo	WVA 		
598052	21012 557	2	HONDA  Accord II (83>85) 146 HYUNDAI  Accent (94>99) 156 Accent (99>2003) 156 Accent (2003>) 156 Elantra (90>95) 157 Excel (86>89) 158 Excel (89>94) 158 Excel (94>99) 158 Getz (2002>2005) 158 Getz (2005>) 158 Lantra (90>95) 159 Lantra (95>2000) 160 Pony (82>94) 160 Pony (94>99) 160 Scoupe (90>96) 161 Stellar (83>92) 162
598053	21312 585	2	HONDA  Civic III (87>91) 149 Civic V (MA/MB) (95>2001) 149 Civic Aerodeck (97>2001) 151 Concerto (89>96) 151 CRX (87>92) 151 Integra (85>89) 152 Prelude (82>87) 154 MG  MG ZR (2001>2005) 216 ROVER  25 (99>2005) 298 45 (2000>2005) 298 200 (89>96) 299 200 (95>99) 299 200 Coupé/Cabriolet (96>99) 299 400 (90>95) 300 400 (95>2000) 300
598054	21546 608	0	NISSAN  Almera (N16E) (2000>2003) 233 Almera (N16E) (2003>2006) 233 Primera (P10/W10) (90>98) 237 Primera (P11/W11) (96>2002) ... 237
598055	20358 511	0	RENAULT  R21 (86>94) 278 R21 Nevada Savanna (86>95) ... 278 Espace III (96>2000) 282 Laguna I (94>98) 284 Laguna I Nevada (95>98) 285 Safrane (92>96) 292 Safrane (96>2000) 292
598056	21880 647	2	HONDA  Accord III (85>89) 146 Accord V (93>95) 146 Accord V (95>98) 147 Accord Aerodeck (85>89) 147 Prelude (87>91) 154 Prelude (91>96) 154 Prelude (96>2001) 154 ROVER  600 (93>2000) 300



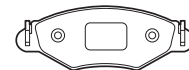









Valeo	WVA 		
598057	21545 608	0	NISSAN  Almera (N16E) (2000>2003) 233 Almera (N16E) (2003>2006) 234 Almera Tino (V10M) (2000>2003) 234 Almera Tino (V10B) (2003>2005) . 234 Primera (P10/W10) (90>98) 237 Primera (P11/W11) (96>2002) ... 237
598061	20916 549	2	DAEWOO  Lublin (97>) 108 RENAULT  R25 (83>92) 279 Espace II (91>96) 282 Laguna I (94>98) 284 Laguna I (98>2000) 284 Laguna I Nevada (95>98) 285 Laguna I Nevada (98>2000) 285 Mégane (95>99) 287 Mégane (98>2003) 288 Mégane Classic (96>99) 288 Mégane Classic (99>2002) 288 Mégane Scenic (96>99) 290 Safrane (92>96) 291 Safrane (96>2000) 292 Spider (96>99) 293
598062	21279 582	2	MERCEDES  Class V (96>2002) 214 MERCEDES  Vito (96>2003) 215
598063	21279 582	0	PEUGEOT  406 (95>2004) 265 607 (2000>2004) 268
598064	21801 638	4	CITROËN  Evasion (94>98) 96 Evasion (98>2002) 96 Synergie (95>98) 98 Synergie (98>2002) 98 CITROËN  Dispatch (95>2003) 102 Jumpy (95>2003) 104 FIAT  Ulysse (94>98) 123 Ulysse (98>2002) 123 FIAT  Scudo (95>2003) 128 LANCIA  Zeta (94>2002) 181 PEUGEOT  806 (94>98) 268 806 (98>2002) 268 PEUGEOT  Expert I (95>2003) 270



















Valeo	WVA		
598065	21636 616	2	ALFA ROMEO
			146 (94>2001) 46
			155 (91>97) 47
			156 (97>2003) 47
			GTV (95>2003) 52
			GTV (2003>2006) 52
			Spider (95>2003) 53
			Spider (2003>2006) 54
			FIAT
			Bravo (95>2002) 113
Coupe (93>2000) 113			
Marea (96>2002) 116			
Multipla (98>2003) 116			
Multipla (2004>) 116			
LANCIA			
Dedra (94>99) 176			
Delta (93>99) 177			
598066	21866 646	0	SEAT
			Cordoba (93>96) 307
			Cordoba (96>99) 307
			Ibiza (93>96) 309
			Ibiza (96>99) 309
			Toledo (91>98) 312
			VOLKSWAGEN
			Golf II (83>92) 361
			Golf III (91>99) 361
			Polo V (94>99) 375
Vento (91>97) 379			
598067	20676 530	0	FORD
			Galaxy (95>2000) 135
			Galaxy (2000>2006) 135
			SEAT
Alhambra (96>2000) 305			
598068	21724 628	4	PEUGEOT
			406 (95>2004) 265
598069	21674 623	4	CITROËN
			Xsara (97>2000) 100
			Xsara (2000>2005) 100
			ZX (91>98) 101
			PEUGEOT
			306 (93>97) 262
306 (97>2002) 263			
406 (95>2004) 265			
598070	21797 637	2 (B)	CITROËN
			Jumper (94>2001) 103
			Relay (94>2001) 104
			FIAT
			Ducato (94>2001) 126
PEUGEOT			
Boxer I (94>2001) 269			
598071	23004 664	2	NISSAN
			Almera (N15) (95>2000) 233

Valeo	WVA		
598073	23042 667	2	CITROËN
			Evasion (94>98) 96
			Evasion (98>2002) 96
			Synergie (95>98) 98
			CITROËN
			Dispatch (95>2003) 102
			Dispatch (2004>2006) 103
			Jumpy (95>2003) 104
			Jumpy (2004>2006) 104
			FIAT
Ulysse (94>98) 123			
Ulysse (98>2002) 123			
FIAT			
Scudo (95>2003) 128			
Scudo (2004>2006) 128			
PEUGEOT			
806 (94>98) 268			
806 (98>2002) 268			
PEUGEOT			
Expert I (95>2003) 270			
Expert I (2004>2006) 270			
598074	21430 596	0	CITROËN
			Saxo (96>99) 97
			Saxo (99>2005) 98
			Xsara (97>2000) 100
PEUGEOT			
106 (91>96) 258			
106 (96>2003) 258			
306 (97>2002) 262			
598075	21061 560	0	CITROËN
			Saxo (96>99) 97
			Saxo (99>2005) 98
PEUGEOT			
106 (91>96) 258			
106 (96>2003) 258			
598076	20480 518	0	RENAULT
			R4 (62>92) 274
			R5 (72>85) 274
598077	20347 511	0	MAZDA
			616 (SN) (73>78) 191
			RENAULT
			R4 (62>92) 274
			R5 (72>85) 274
			R6 (68>80) 275
			R12 (69>80) 276
			R14 (76>84) 276
			R15 (71>80) 276
			R16 (65>80) 276
R17 (71>80) 276			
R18 (77>86) 276			
R20 (75>84) 277			
Alpine A310 279			
Rodeo (70>86) 291			
598078	20347 511	2	PEUGEOT
			104 (72>88) 257
			304 (69>80) 262
			305 (77>82) 262
			305 (82>90) 262
			TALBOT
Samba (81>85) 327			



Valeo	WVA 		
598080	20635 525	2	RENAULT  <ul style="list-style-type: none"> Super 5 (84>96) 275 Clio I (90>96) 280 Twingo I (93>98) 294 RENAULT  <ul style="list-style-type: none"> Express (85>91) 295 Extra (85>91) 295 Rapid (85>91) 297
598081	21061 560	2	PEUGEOT  <ul style="list-style-type: none"> 106 (96>2003) 258 205 (87>98) 259 305 (82>90) 262 309 (85>89) 264 309 (89>94) 264 405 (87>92) 265 405 (92>96) 265 RENAULT  <ul style="list-style-type: none"> Super 5 (84>96) 275 R9 (81>88) 275 R11 (82>89) 275 R18 (77>86) 276 R19 (88>92) 277 R19 (92>95) 277 R20 (75>84) 277 R21 (86>94) 278 R21 Nevada Savanna (86>95) ... 278 Clio I (90>96) 280 Clio I (96>98) 280 Fuego (79>85) 283 Lutecia (Japan) (94>98) 287 RENAULT  <ul style="list-style-type: none"> Express (85>91) 295 Express (91>2003) 295 Extra (85>91) 295 Extra (91>97) 295 Rapid (85>91) 297 Rapid (91>98) 297 TALBOT  <ul style="list-style-type: none"> 1307/8/9 (75>79) 326 Murena (81>83) 327 Solara (80>85) 327
598082	21087 562	2	RENAULT  <ul style="list-style-type: none"> R21 (86>94) 278 R21 Nevada Savanna (86>95) ... 278
598084	20772 537	2 (A)	PEUGEOT  <ul style="list-style-type: none"> 205 (83>87) 259 205 (87>98) 259 309 (85>89) 264 309 (89>94) 264 RENAULT  <ul style="list-style-type: none"> R5 (72>85) 274 R11 (82>89) 275 Espace I (84>91) 282

Valeo	WVA 		
598085	20347 511	2	ARO  <ul style="list-style-type: none"> 10 (80>) 54 CITROËN  <ul style="list-style-type: none"> LN/LNA (76>86) 97 Visa (78>88) 98 FIAT  <ul style="list-style-type: none"> Ritmo (78>82) 120 RENAULT  <ul style="list-style-type: none"> R5 (72>85) 275 R12 (69>80) 276 R17 (71>80) 276 R18 (77>86) 277 R21 (86>94) 278 R21 Nevada Savanna (86>95) ... 278 R25 (83>92) 279 R30 (75>84) 279 Alpine A310 279 Espace I (84>91) 282 Espace II (91>96) 282 Fuego (79>85) 284 TALBOT  <ul style="list-style-type: none"> Bagheera (77>80) 327 Murena (81>83) 327
598086	20928 550	0	OPEL  <ul style="list-style-type: none"> Arena (98>2001) 255 RENAULT  <ul style="list-style-type: none"> R30 (75>84) 279 RENAULT  <ul style="list-style-type: none"> Trafic (80>89) 297 Trafic (89>94) 297 Trafic (94>97) 297 Trafic (97>2001) 298 VAUXHALL  <ul style="list-style-type: none"> Arena (98>2001) 354
598088	20647 525	0	FIAT  <ul style="list-style-type: none"> 124 (66>77) 111 125 (67>73) 111 131/132 (72>85) 112 Argenta (81>86) 112 Spider (82>85) 121 X1/9 (69>89) 125 FSO POLSKI  <ul style="list-style-type: none"> 125 (71>92) 144 Polonez (78>92) 145 SEAT  <ul style="list-style-type: none"> 132 305 TALBOT  <ul style="list-style-type: none"> 1000 (66>78) 326 YUGO/ZASTAVA  <ul style="list-style-type: none"> 124 394 132 394

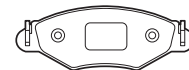

Valeo	VVA		
598090	20647 525	2	FIAT <ul style="list-style-type: none"> 124 (66>77)111 125 (67>73)111 127/128 (66>86)111 131/132 (72>85)111 Panda (80>86)117 Ritmo (78>82)120 Spider (82>85)121 X1/9 (69>89)125 FIAT <ul style="list-style-type: none"> Fiorino (127) (78>87) 128 INNOCENTI <ul style="list-style-type: none"> Koral (90>)163 LANCIA <ul style="list-style-type: none"> Beta (72>85)175 Trevi (80>85)180 SEAT <ul style="list-style-type: none"> 127305 128305 131305 132305 Fura (82>86)309
598091	20775 537	2	AUTOBIANCHI <ul style="list-style-type: none"> Y10 (85>95) 73 FIAT <ul style="list-style-type: none"> 900 (76>87)112 Panda (80>86)117 Panda (86>2003)118 Regata (83>90)120 Ritmo (82>88)120 Strada (85>88)122 Uno (83>89)124 Uno (89>95)124 Uno Mondo (98>)125 LANCIA <ul style="list-style-type: none"> Y10 (89>95)181 SEAT <ul style="list-style-type: none"> Ibiza (84>93)309 Malaga (85>93)312 Marbella (86>98)312 Panda (80>86)312 Ronda (82>87)312 SEAT <ul style="list-style-type: none"> Terra (87>96)313
598093	20708 532	2	LANCIA <ul style="list-style-type: none"> Delta (79>86)176 Delta (86>93)176 Prisma (83>86)179 Prisma (86>89)179 SEAT <ul style="list-style-type: none"> Ronda (82>87)312 SEAT <ul style="list-style-type: none"> Terra (87>96)313
598094	20347 511	0	LANCIA <ul style="list-style-type: none"> Beta (72>85)175 Trevi (80>85)181

Valeo	VVA		
598095	21105 563	1	FIAT <ul style="list-style-type: none"> Tempra (89>93)122 Tipo (88>93)123 Uno (83>89)124 Uno (89>95)124 FSO POLSKI <ul style="list-style-type: none"> Atou (95>97)144 Caro (91>99)145 Celina (95>98)145 LANCIA <ul style="list-style-type: none"> Dedra (89>94)175
598099	20228 507	0	ALFA ROMEO <ul style="list-style-type: none"> Alfetta (72>85)50 Giulia (64>79)50 Giulietta (76>86)51 GTV (80>87)51 Spider (71>93)53 AUDI <ul style="list-style-type: none"> 50 (74>78)55 80 (72>81)55 100 (68>72)57 BMW <ul style="list-style-type: none"> 1500 / 200274 OPEL <ul style="list-style-type: none"> Ascona A (70>75)242 Kadett C (73>79)247 Manta A (70>75)248 Monza (78>86)249 Rekord D (72>77)250 Senator A (78>87)251 SAAB <ul style="list-style-type: none"> 99 (67>85)303 TALBOT <ul style="list-style-type: none"> 1000 (66>78)325 1100 (67>81)326 1200S (69>71)326 VOLKSWAGEN <ul style="list-style-type: none"> 412 (68>74)357 Derby (77>81)360 Derby (81>84)360 Golf I (74>83)360 Jetta I (78>84)369 Jetta II (83>92)369 Passat I (73>81)371 Passat II (81>88)371 Polo I (74>81)374 Polo II (81>86)374 Polo III (86>90)374 Scirocco (74>90)377
598102	21010 556	0	VOLVO <ul style="list-style-type: none"> 480 (86>95)386
598103	20675 529	431823 0 431823 0 431830 0 0 0 0 0	BMW <ul style="list-style-type: none"> Series 3 (E31) (82>93)76 Series 5 (E28) (81>88)80 Series 5 (E34) (88>96)80 Series 6 (E24) (76>89)82 Series 7 (E23) (77>86)83 Series 7 (E32) (86>94)83 Series 8 (E31) (89>2000)84 M5 (E28) (84>88)85 Z1 (E30) (89>92)86



Valeo	VVA	Valeo	
598104	20629 524	431823 431830 0 431823	BMW Series 5 (E28) (81>88) 80 Series 6 (E24) (76>89) 82 M3 (E30) (86>91) 84 M5 (E28) (84>88) 85
598105	20687 531	0	MERCEDES 190 (201) (82>93) 197
598106	20011 499	0	VOLKSWAGEN Transporter (67>79) 381 Transporter (F24) (79>92) 381
*598107	20437 516	0 0 431830 431830 431830 0 431823	ALFA ROMEO 75 (85>93) 45 Alfa 6 (79>87) 50 BMW Series 5 (E12) (72>81) 80 Series 6 (E24) (76>89) 82 Series 7 (E23) (77>86) 83 M5 (E12) (80>81) 85 M5 (E28) (84>88) 85
598108	20588 523	0	ALFA ROMEO GTV (80>87) 51 BMW Series 3 (E21) (75>83) 76 OPEL Ascona B (75>81) 242 Kadett C (73>79) 247 Manta B (75>88) 248 Rekord D (72>77) 250 Rekord E (77>86) 250 VAUXHALL Carlton (78>86) 346 Cavalier (75>81) 347
598109	20392 515	0	MERCEDES 200/300 (W123) (76>85) 197 Class S (W116) (72>80) 209 Class SL (C107) (71>81) 211 Class SL (R107) (71>89) 211
598110	20392 515	431828	MERCEDES 200/300 (W123) (76>85) 197 Class S (W126) (79>91) 209 Class SL (C107) (71>81) 211 Class SL (R107) (71>89) 211 VOLKSWAGEN LT I (75>96) 380

Valeo	VVA	Valeo	
*598111	20011 499	0	ALFA ROMEO 1750 49 2000 49 Montreal (70>75) 53 Spider (71>93) 53 MERCEDES Class SL (C107) (71>81) 211 OPEL Commodore (78>82) 245 Monza (78>86) 249 Senator A (78>87) 250 PORSCHE 911 (70>83) 272 TALBOT 160 (70>80) 326 VAUXHALL Royale (78>82) 350 Viceroy (80>81) 353 VOLKSWAGEN Transporter (67>79) 381
598112	20706 532	0 (B)	MERCEDES MB100 214 NISSAN Trade (84>) 240
598113	20911 548	1	ALFA ROMEO 75 (85>93) 45 Alfetta (72>85) 50 Giulietta (76>86) 51 TALBOT 1000 (66>78) 325 1301-1501 (63>76) 326 Bagheera (77>80) 326 Horizon (78>86) 327 Rancho (77>86) 327
598115	20998 556	1	ALFA ROMEO 75 (85>93) 45 90 (84>88) 45 Giulietta (76>86) 51 GTV (80>87) 51 RZ (92>93) 53 SZ (89>91) 54
598116	20754 535	2	RELIANT Scimitar (68>92) 274 ROVER Metro (80>90) 301
*598117	20761 536	2	ROVER Metro (80>90) 301
598118	21084 561	2	RELIANT Scimitar (68>92) 274 ROVER 400 (95>2000) 300 Maestro (83>95) 301 Montego (84>94) 301
598119	20989 555	4	CITROËN Visa (78>88) 98 CITROËN C15 (84>2005) 102

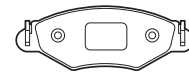

Valeo		WVA	Valeo	
598120		20907 547	2	FORD <ul style="list-style-type: none"> Escort (95>2001) 131 Granada (77>82) 136 Granada (85>91) 136 Granada (92>95) 136 Scorpio (85>92) 139 Scorpio (92>94) 139 Sierra (87>93) 141
598121		20981 554	2	FORD <ul style="list-style-type: none"> Granada (85>91) 136 Scorpio (85>92) 139
598122		20863 542	0	NISSAN <ul style="list-style-type: none"> Patrol 160 Made in Japan (80>85) 230 Patrol GR (Y60) (88>97) 231
598123	241	21099 562	2	NISSAN <ul style="list-style-type: none"> 720 Pick-up (79>85) 229 D21 Pick-up (85>98) 229 Pathfinder (D21) (86>98) 230 Terrano (WD21) (87>95) 231
NISSAN <ul style="list-style-type: none"> 300 ZX (Z31) (84>89) 232 Bluebird (T12) (85>90) 234 Bluebird (T72) (85>90) 234 Bluebird (U11) (83>90) 234 Cedric (Y30) (83>88) 235 Laurel (C32) (85>90) 235 Prairie (M10) (82>88) 237 Silvia (S12) (83>88) 238 Stanza (T11) (81>85) 238 				
				NISSAN <ul style="list-style-type: none"> Vanette (C220) Made in Spain (86>94)
				<ul style="list-style-type: none"> Vanette (C23M) (92>2001) 241 Vanette (GC22) (86>93) 241
598124		20887 544	0	SEAT <ul style="list-style-type: none"> Cordoba (93>96) 307 Ibiza (93>96) 309
				VOLKSWAGEN <ul style="list-style-type: none"> Golf I (74>83) 360 Golf I Cabriolet (79>93) 360 Golf II (83>92) 361 Golf II Cabriolet (93>98) 361 Golf III (91>99) 363 Jetta I (78>84) 369 Jetta II (83>92) 369 Passat I (73>81) 371 Passat II (81>88) 371 Passat III (88>93) 372 Polo III (86>90) 374 Polo IV (90>94) 375 Santana (81>84) 377 Scirocco (74>90) 377

Valeo		WVA	Valeo	
598125		20668 528	0	ALFA ROMEO <ul style="list-style-type: none"> 164 (87>92) 49 164 (92>98) 49
				AUDI <ul style="list-style-type: none"> 80 (81>86) 55 80 (86>91) 55 80 (91>95) 56 Cabriolet (91>2000) 56 90 (84>87) 57 90 (87>91) 57 100 (82>90) 58 100 (90>94) 59 200 (79>90) 59 A4 (94>98) 61 A4 (99>2001) 62 A6 (94>97) 64 A8 (94>2002) 67 Coupé (80>88) 68 Coupé (88>96) 68 Quattro (80>91) 68 S4 (97>99) 69 S6 (94>97) 70 S6 Plus Quattro (96>97) 71 S8 (96>98) 71 V8 (88>93) 72
				FIAT <ul style="list-style-type: none"> Croma (85>90) 114 Croma (91>96) 114
				LANCIA <ul style="list-style-type: none"> Thema (84>88) 180 Thema (88>92) 180 Thema (92>94) 180
598126		20775 537	2	ALFA ROMEO <ul style="list-style-type: none"> 33 (83>89) 44 Alfasud Sprint (79>89) 50
598127		20889 545	0	SEAT <ul style="list-style-type: none"> Cordoba (93>96) 307 Ibiza (93>96) 309
				VOLKSWAGEN <ul style="list-style-type: none"> Golf II (83>92) 360 Jetta II (83>92) 369 Polo III (86>90) 374
598128		20887 544	0	SEAT <ul style="list-style-type: none"> Cordoba (93>96) 307 Ibiza (93>96) 309 Toledo (91>98) 312
				VOLKSWAGEN <ul style="list-style-type: none"> Golf I (74>83) 360 Golf I Cabriolet (79>93) 360 Golf II (83>92) 360 Golf II Cabriolet (93>98) 361 Golf III (91>99) 361 Jetta I (78>84) 369 Jetta II (83>92) 369 Passat I (73>81) 371 Passat II (81>88) 371 Passat III (88>93) 371 Santana (81>84) 377 Scirocco (74>90) 377 Vento (91>97) 379
				VOLKSWAGEN <ul style="list-style-type: none"> Caddy I (82>92) 379



Valeo	VVA	Valeo	
598129	20359 512	4 (B)	ALFA ROMEO AR8 (80>86) 54 DAF 400 (86>96) 108 FORD Scorpio (92>94) 139 FORD Transit (78>85) 143 Transit (85>91) 143 IVECO Daily (78>89) 164 LAND ROVER Defender (90>2007) 181 Range Rover (81>86) 183 LDV Sherpa II (82>89) 185
*598130	20944 551	2	ALFA ROMEO 33 (83>89) 44 Alfasud Sprint (79>89) 50 Arna (83>87) 50
598131	20895 546	2	HONDA Accord I (76>83) 146 Ballade (83>90) 148 Civic II (83>87) 149 CRX (83>88) 151 ROVER 200 (84>90) 299
598132	20359 512	2 (A)	IVECO Daily (78>89) 164
598133	20838 540	2	LANCIA Prisma (83>86) 179
598134	20838 540	2	FIAT Croma (85>90) 114 LANCIA Prisma (86>89) 179 Thema (84>88) 179
598135	21185 572	2 (B)	ALFA ROMEO 164 (87>92) 49 164 (92>98) 49 FIAT Croma (85>90) 114 Croma (91>96) 114 LANCIA Thema (84>88) 179 Thema (88>92) 180 Thema (92>94) 180
598138	21206 575	2	AUVERLAND A3 73 CITROËN C25 (81>90) 102 C25 (90>94) 102 FIAT Ducato (85>90) 126 Ducato (90>94) 126 PEUGEOT J5 (81>90) 270 J5 (90>94) 270
598139	21049 559	2 (C)	IVECO Daily (78>89) 164

Valeo	VVA	Valeo	
598141	20775 537	0	FIAT Croma (85>90) 114 Croma (91>96) 114 Tempra (89>93) 122 Tempra (93>96) 122 LANCIA Dedra (89>94) 175 Delta (79>86) 176 Delta (86>93) 176 Prisma (83>86) 179 Prisma (86>89) 179
598142	21103 563	0	ALFA ROMEO 33 (89>94) 44 145 (94>2001) 46 146 (94>2001) 46 155 (91>97) 47 GTV (95>2003) 52 Spider (95>2003) 53 FIAT Barchetta (95>2003) 112 Bravo (95>2002) 113 Coupe (93>2000) 114 Marea (96>2002) 116 Marengo (159) (89>95) 116 Punto (93>99) 119 Tempra (89>93) 122 Tempra (93>96) 122 Tipo (88>93) 123 Tipo (93>95) 123 Uno (83>89) 124 Uno (89>95) 124 LANCIA Dedra (89>94) 175 Dedra (94>99) 176 Delta (93>99) 177
598144	20207 505	0	CITROËN 2 CV 91 Ami 8 91 Dyane (67>83) 96 Mehari (68>87) 97 CITROËN Acadiane (78>87) 101
*598145	20288 509	4	CITROËN Ami 8 91 GS (70>80) 97 GSA (79>86) 97 CITROËN C32 (73>79) 102 C35 (73>91) 102
*598146	20297 510	0	CITROËN Axel (84>90) 92 GS (70>80) 97 GSA (79>86) 97 Mehari (68>87) 97
598148	20575 521	0	CITROËN BX (82>94) 92
598149	20690 531	4	CITROËN Axel (84>90) 92 GSA (79>86) 97

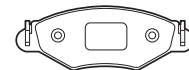

Valeo	VVA			
598150	20594 523	4	CITROËN	
			LN/LNA (76>86) 97	
			Visa (78>88) 98	
			CITROËN	
			C15 (84>2005) 102	
			PEUGEOT	
			104 (72>88) 257	
598151	20635 525	4	CITROËN	
			BX (82>94) 92	
			RENAULT	
			Alpine GT D500 279	
598153	20741 535	2	AUVERLAND	
			A3 73	
			CITROËN	
			C25 (81>90) 102	
			C25 (90>94) 102	
			FIAT	
			Ducato (81>85) 126	
			Ducato (85>90) 126	
			Ducato (90>94) 126	
			Talento (88>94) 129	
			PEUGEOT	
			J5 (81>90) 270	
			J5 (90>94) 270	
598154	20772 537	4 (A)	CITROËN	
			Fukang (93>) 97	
			ZX (91>98) 101	
598155	21061 560	4	CITROËN	
			AX (91>98) 92	
			Fukang (93>) 96	
			ZX (91>98) 101	
			CITROËN	
			C15 (84>2005) 102	
598156	21145 567	4	CITROËN	
			AX (86>91) 91	
			PEUGEOT	
			106 (91>96) 258	
			106 (96>2003) 258	
598158	20635 525	0	RENAULT	
			R19 (88>92) 277	
			R19 (92>95) 277	
			Clio I (90>96) 280	
			Lutecia (Japan) (94>98) 287	
598160	20775 537	0	ALFA ROMEO	
			Arna (83>87) 50	
598161	20579 522	2	TALBOT	
			1100 (67>81) 326	
			Horizon (78>86) 327	
			Rancho (77>86) 327	
598162	20661 527	2	TALBOT	
			1510 (79>82) 326	
			Solara (80>85) 327	
*598163	20845 540	2	TALBOT	
			Horizon (78>86) 327	
			Rancho (77>86) 327	
598165	20422 516	0	FORD	
			Fiesta (76>83) 131	

Valeo	VVA			
598166	20783 538	2	FORD	
			Escort (80>86) 130	
			Escort (86>90) 130	
			Orion (83>90) 138	
			Sierra (82>86) 140	
			Sierra (87>93) 140	
598167	20857 541	0	FORD	
			Fiesta (83>89) 131	
598168	20491 519	2	FORD	
			Capri (68>87) 129	
			Cortina (76>82) 130	
			Escort (74>80) 130	
			Granada (77>82) 136	
			Taurus (76>82) 142	
			HYUNDAI	
			Stellar (83>92) 162	
598169	20862 541	2	FORD	
			Sierra (82>86) 140	
598171	21203 574	0	FORD	
			Fiesta (89>95) 132	
			Fiesta (95>99) 132	
			Ka (96>2008) 136	
598172	23300 702	0	FORD	
			Escort (90>94) 130	
			Escort (95>2001) 131	
			Orion (90>93) 138	
598174	20146 503	2	PEUGEOT	
			504 (68>2000) 266	
			TALBOT	
			160 (70>80) 326	
598175	20631 524	2	PEUGEOT	
			504 (68>2000) 266	
			505 (79>90) 267	
			RENAULT	
			R5 (72>85) 274	
			Alpine A310 279	
*598176	20989 555	2	PEUGEOT	
			205 (83>87) 259	
			205 (87>98) 259	
			309 (85>89) 264	
			309 (89>94) 264	
598177	20635 525	2	PEUGEOT	
			205 (83>87) 258	
			205 (87>98) 259	
			305 (82>90) 262	
			TOYOTA	
			Liteace (79>95) 341	
598178	20454 517	2	PEUGEOT	
			504 (68>2000) 266	
			505 (79>90) 266	
			604 (76>86) 267	
			TALBOT	
			Tagora (80>84) 327	
598179	21209 575	2	PEUGEOT	
			405 (87>92) 265	
			405 (92>96) 265	



Valeo	VVA	Valeo	
598180	20960 553	0 (D)	<p>AUDI </p> A3 (96>2000) 60 A3 (2000>2003) 60 TT (98>2006) 72 <p>LANCIA </p> Delta (86>93) 176 <p>PEUGEOT </p> 405 (87>92) 265 405 (92>96) 265 <p>RENAULT </p> Avantime (2001>2003) 280 Clio III (2005>) 281 Clio III (2009>) 282 Espace III (2000>2002) 283 Mégane (98>2003) 288 Mégane II (2002>) 289 Mégane Scenic (99>2003) 291 Modus (2004>2008) 291 Modus (2008>) 291 Scenic II (2003>) 292 Grand Scenic II (2003>) 293 <p>SEAT </p> Cordoba (93>96) 307 Cordoba (96>99) 308 Cordoba (99>2002) 308 Cordoba (2002>) 308 Ibiza (93>96) 309 Ibiza (99>2001) 310 Ibiza (2001>) 311 Toledo (91>98) 313 Toledo (98>2004) 313 <p>SKODA </p> Fabia (99>2004) 314 Fabia (2004>2007) 314 Octavia (96>2000) 316 Octavia (2000>) 316 Roomster (2006>) 317 <p>VOLKSWAGEN </p> Bora (98>2005) 358 Corrado (88>95) 359 Golf II (83>92) 361 Golf II Cabriolet (93>98) 361 Golf III (91>99) 365 Golf III Cabriolet (98>2002) 366 Golf IV (97>2006) 367 Jetta I (78>84) 369 Jetta II (83>92) 369 New Beetle (98>2001) 370 New Beetle (2001>2005) 371 Passat II (81>88) 371 Passat III (88>93) 372 Passat IV (93>97) 372 Polo V (94>99) 375 Polo VI (99>2001) 375 Polo VII (2001>) 376 Scirocco (74>90) 377 Vento (91>97) 379
598181	21061 560	4	<p>PEUGEOT </p> 106 (91>96) 257 106 (96>2003) 258 306 (93>97) 262

Valeo	VVA	Valeo	
598182	20867 542	0	<p>BEDFORD </p> Novavan (82>88) 73 <p>OPEL </p> Ascona B (75>81) 242 Ascona C (81>88) 243 Corsa A (82>93) 245 Kadett D (79>84) 247 Kadett E (84>91) 247 Manta B (75>88) 248 Omega A (86>94) 249 Rekord E (77>86) 250 Vectra A (88>95) 252 <p>OPEL </p> Combo (85>93) 255 <p>VAUXHALL </p> Astra MK I (80>84) 343 Astra MK II (84>91) 343 Astra Belmont (86>91) 343 Carlton (78>86) 346 Carlton (86>94) 346 Cavalier (75>81) 347 Cavalier (81>88) 347 Cavalier (88>95) 347 Nova (83>93) 350
598183	21051 560	0	<p>OPEL </p> Calibra (89>97) 245 Omega A (86>94) 249 Omega B (94>2003) 250 Senator B (87>93) 251 Vectra B (95>99) 253 Vectra B (99>2003) 253 <p>SAAB </p> 9-3 (98>2003) 302 9-5 (97>2001) 303 <p>VAUXHALL </p> Calibra (90>97) 345 Carlton (86>94) 346 Omega (94>) 350 Senator B (87>93) 351 Vectra (95>2002) 352
598184	21201 574	0	<p>DAEWOO </p> Aranos (95>) 106 Espero (93>99) 106 Lanos (97>) 107 Nexia (95>) 107 <p>OPEL </p> Astra F (91>2001) 243 Astra Classic (98>2002) 243 Calibra (89>97) 245 Kadett E (84>91) 247 Omega A (86>94) 249 Vectra A (88>95) 252 Vectra B (95>99) 253 Vectra B (99>2003) 253 <p>VAUXHALL </p> Astra MK II (84>91) 343 Astra Belmont (86>91) 343 Astra MK III (91>2001) 343 Calibra (90>97) 345 Carlton (86>94) 346 Cavalier (88>95) 347 Vectra (95>2002) 352

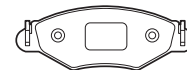

Valeo		WVA	Valeo	
598185		20731 534	0	HONDA Ballade (80>83) 148 Civic I (72>83) 148 MARUTI 800 187 ROVER Acclaim (81>84) 301 SUZUKI Alto (80>94) 323
*598186		21226 577	0	OPEL Monza (78>86) 249 Omega A (86>94) 249 Senator A (78>87) 251 Senator B (87>93) 251 VAUXHALL Carlton (86>94) 346 Senator B (87>93) 351
598187		20009 499	0	ALFA ROMEO 1750 49 2000 50 Giulia (64>79) 50 Montreal (70>75) 53 Spider (71>93) 53 BMW 2500 / 3300 75 Series 5 (E12) (72>81) 80 Series 6 (E24) (76>89) 82 Series 7 (E23) (77>86) 83 M5 (E12) (80>81) 85 OPEL Vectra B (95>99) 253 Vectra B (99>2003) 253 SAAB 99 (67>85) 303 900 (80>93) 304 TALBOT 1100 (67>81) 326 VOLKSWAGEN Coccinelle/Beetle (47>83) 359
598193		20253 508	2	PEUGEOT 504 (68>2000) 266 505 (79>90) 267 604 (76>86) 267 TALBOT Tagora (80>84) 327
598205		20574 521	0	AUDI 80 (72>81) 55 80 (81>86) 55 100 (71>82) 57 100 (82>90) 58 Coupé (80>88) 67 VOLKSWAGEN Passat I (73>81) 371 VOLVO 340 (82>91) 386 343 (76>82) 386 345 (79>82) 386 360 (82>89) 386

Valeo		WVA	Valeo	
598207		20389 515	0	CITROËN CX (74>91) 96 Xantia (93>97) 99 Xantia (97>2002) 99 XM (89>94) 99 XM (94>2001) 100
*598208		20735 534	0	HONDA Prelude (79>82) 154 Quintet (80>84) 155
598212		20783 538	0	FORD Escort (80>86) 130 Escort (86>90) 130 Fiesta (76>83) 131 Fiesta (83>89) 131 Fiesta (89>95) 132 Fiesta (95>99) 132 Fiesta (99>2002) 132 Orion (83>90) 138 Puma (97>2001) 139 Sierra (82>86) 140 Sierra (87>93) 140 FORD Courier (91>96) 142 Courier Courier (96>2002) 142 P100 Pick-up (88>93) 142 MAZDA 121 (96>) 190
598214		20574 521	0	AUDI 80 (81>86) 55 Coupé (80>88) 68
598217		20862 541	0	FORD Sierra (82>86) 140 SKODA Favorit (88>95) 315 Felicia (94>2001) 315 Forman (90>95) 315 VOLKSWAGEN Caddy II (95>2004) 380



Valeo	WVA	Valeo	
598219	20838 540	4	ALFA ROMEO
			145 (94>2001) 45
			146 (94>2001) 46
			155 (91>97) 47
			Spider (95>2003) 53
			AUTOBIANCHI
			Y10 (85>95) 73
			FIAT
			Argenta (81>86) 112
			Barchetta (95>2003) 112
			Marengo (159) (89>95) 116
			Panda (86>2003) 118
			Punto (93>99) 118
			Regata (83>90) 120
			Ritmo (82>88) 120
			Seicento (98>2005) 121
			Tempra (89>93) 122
			Tempra (93>96) 122
			Tipo (88>93) 123
			Tipo (93>95) 123
			Uno (83>89) 124
			Uno (89>95) 124
			Uno Mondo (98>) 125
LANCIA			
Dedra (89>94) 175			
Dedra (94>99) 175			
Delta (79>86) 176			
Delta (86>93) 176			
Delta (93>99) 176			
Prisma (83>86) 179			
Y Ipsilon (95>2000) 181			
Y10 (89>95) 181			
598220	20955 551	0	MITSUBISHI
			Colt (78>84) 222
			Colt (84>89) 222
			Colt (88>92) 222
			Cordia (81>85) 223
			Galant (80>84) 223
			Galant (84>87) 224
			Galant (87>92) 224
			Lancer (A17) (79>83) 225
			Lancer F (C1) (84>88) 225
			Lancer F (CV) (85>92) 226
			Lancer F (C6/7) (88>95) 226
			Space Wagon (D0) (83>91) 228
598221	20740 534	0	VOLVO
			740 (84>92) 387
			760 (82>90) 387
			780 (85>91) 388
			940 (90>98) 388
			960 (90>97) 389
598222	20788 539	0	U.M.M.
			Alter 4x4 341
598224	21126 564	0	MITSUBISHI
			Colt (84>89) 222
			Colt (88>92) 222
			Lancer F (C1) (84>88) 225
			Lancer F (CV) (85>92) 226
Lancer F (C6/7) (88>95) 226			

Valeo	WVA	Valeo		
598227	21245 579	1	HONDA	
			Legend (85>90) 153	
598230	21138 565	2	ROVER	
			800 (86>91) 300	
			AUDI	
			100 (82>90) 58	
			200 (79>90) 59	
			Quattro (80>91) 68	
598231	21064 561	431832	BMW	
			Series 5 (E34) (88>96) 80	
			431824	Series 7 (E23) (86>94) 83
			431850	M3 (E36) (92>2000) 84
			431832	M5 (E34) (88>95) 85
		0	Z3 (E36) (96>2002) 86	
598237	21010 556	431829	SAAB	
			900 (80>93) 304	
			431829	900 (93>98) 304
		0	9000 (84>98) 304	
598239	21041 558	0	MAZDA	
			626 (G) (82>87) 191	
598240	20981 554	0	FORD	
			Escort (90>94) 131	
			Granada (85>91) 136	
			Granada (92>95) 136	
			Scorpio (85>92) 139	
			Scorpio (92>94) 139	
			Scorpio (94>98) 140	
			Sierra (82>86) 140	
			Sierra (87>93) 141	
598241	21010 556	431821	MERCEDES	
			190 (201) (82>93) 196	
598243	21051 560	0	OPEL	
			Kadett E (84>91) 247	
			Omega A (86>94) 249	
			VAUXHALL	
			Carlton (86>94) 346	
598248	21322 585	2	HONDA	
			Civic III (87>91) 149	
			Civic Shuttle (87>92) 151	
			CRX (87>92) 151	
			Prelude (87>91) 154	
598250	21378 592	2	FORD	
			Probe (92>97) 138	
			MAZDA	
			626 (G) (87>92) 191	
			626 Wagon (GV) (88>92) 192	
			626 Wagon (GV) (92>97) 192	

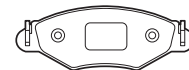

Valeo		WVA	Valeo	
598252		20901 546	0	SEAT Cordoba (96>99) 307 Cordoba (99>2002) 308 Ibiza (96>99) 310 Ibiza (99>2001) 310 Toledo (91>98) 312 SEAT Inca (95>2003) 313 VOLKSWAGEN Corrado (88>95) 359 Golf II (83>92) 361 Golf II Cabriolet (93>98) 361 Golf III (91>99) 361 Golf III Cabriolet (98>2002) 366 Passat III (88>93) 371 Passat IV (93>97) 372 Vento (91>97) 379 VOLKSWAGEN Caddy II (95>2004) 380
598253		21140 565	0	OPEL Astra F (91>2001) 243 Calibra (89>97) 245 Kadett E (84>91) 248 Vectra A (88>95) 253 SAAB 900 (93>98) 304 VAUXHALL Astra MK II (84>91) 343 Astra MK III (91>2001) 344 Calibra (90>97) 345 Cavalier (88>95) 348
598254		21518 605	0	MG MG F (95>2002) 216 MG TF (2002>2005) 216 ROVER 100 (90>98) 299 Metro UK (90>95) 301
598256		21368 591	0	OPEL Omega A (86>94) 249 Omega B (94>2003) 250 Senator B (87>93) 251 VAUXHALL Carlton (86>94) 346 Omega (94>) 350 Senator B (87>93) 351
598257		21233 578	0	VOLVO 740 (84>92) 387 760 (82>90) 387 780 (85>91) 388 940 (90>98) 388 960 (90>97) 389
598258		20887 544	0	SEAT Cordoba (93>96) 307 Cordoba (96>99) 307 Ibiza (93>96) 309 Ibiza (96>99) 309 VOLKSWAGEN Polo II (81>86) 374 Polo IV (90>94) 374 Polo V (94>99) 375

Valeo		WVA	Valeo	
598259		20996 555		BMW Series 5 (E34) (88>96) 80 Series 7 (E32) (86>94) 83 M3 (E30) (86>91) 84 M3 (E36) (92>2000) 84 M5 (E34) (88>95) 85 Z3 (E36) (96>2002) 86 431823 431839 0 0 431823 431823
598266		20870 542	4	TOYOTA Camry (82>86) 332 Camry (86>91) 332 Carina II (83>87) 333 Carina II (87>92) 333 Celica (85>89) 333 Celica (89>93) 334 Corolla (80) (83>87) 334 Corolla (90) (87>92) 335 Corolla (100) (92>97) 335 MR 2 (84>89) 337 Paseo (95>99) 337 Starlet (89>95) 338 Starlet (96>99) 339 Tercel (82>88) 339
598268		21355 588	4	KIA Pride (87>2000) 173 Pride Wagon (98>2000) 173 MAZDA 121 (88>90) 190
*598269		21154 569	0	SAAB 900 (80>93) 304 9000 (84>98) 304
598270		20467 517	0	VOLVO 240 (82>93) 385 242 (74>84) 385 244 (79>82) 385 245 (79>82) 385 262 (78>80) 385 264 (78>82) 385 265 (78>85) 386 740 (84>92) 387 760 (82>90) 388 780 (85>91) 388 850 (91>96) 388 940 (90>98) 388 960 (90>97) 389 C70 (97>2005) 391 S70 (96>2000) 392 V70 (96>2000) 392
598271		21193 572	2 (A)	FIAT Uno CS (87>) 125 FIAT Duna (87>91) 128 Fiorino (146) (88>93) 128 Fiorino (146) (93>2000) 128 INNOCENTI Elba (91>97) 163



Valeo	VVA	Valeo	
598272	21197 573	0	MERCEDES 190 (201) (82>93) 197 200/300 (W124) (84>93) 198 Class C (W202) (93>2001) 200 Class E (W124) (93>98) 205 Class E (W210) (95>2003) 206 Class SL (129) (89>2001) 211 Class SLK (170) (96>2003) 213
598274	21654 619	2	KIA Rio (2000>2005) 173 MAZDA 121 (90>96) 190 323 (BG) (89>94) 190 323 (BA) (94>98) 190
598278	20958 552	0	NISSAN Cherry (N12) (82>87) 235 Sunny (B11) (81>86) 238 Sunny (B12) (86>90) 238 Sunny (N13) (86>90) 239 SUBARU E10/E12 (KJ) (84>94) 319 Justy (86>95) 320 SUBARU Sumo (87>94) 322
598280	21507 603	4	PEUGEOT 605 (89>94) 267
598281	21211 576	2	PEUGEOT 605 (89>94) 267 605 (94>99) 268
598289	21165 571	2	ALFA ROMEO 33 (83>89) 44 Alfasud Sprint (79>89) 50
598290	21766 634	0	FORD Probe (92>97) 139 MAZDA 626 (GE) (91>97) 192 MX6 (91>97) 194 Xedos 6 (91>99) 195
598291	20756 536	0	SAAB 900 (80>93) 304 900 (93>98) 304 9000 (84>98) 304 VOLVO 440 (88>97) 386 460 (90>97) 386 480 (86>95) 386
598292	20575 521	0	CITROËN CX (74>91) 95 Xantia (93>97) 99 Xantia (97>2002) 99 XM (89>94) 99 XM (94>2001) 100
598293	21277 581	2	MAZDA 323 (BF) (85>89) 190 323 Wagon (BW) (86>93) 191



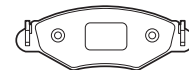











Valeo	VVA	Valeo	
598294	21295 584	4	PEUGEOT 605 (89>94) 267 RENAULT Alpine A610 279 Clio II (98>2001) 280 Clio II (2001>) 281 Spider (96>99) 293
598295	21279 582	2	PEUGEOT 605 (89>94) 267 605 (94>99) 268
598296	21344 586	2	NISSAN Sunny (B12) (86>90) 239 Sunny (N13) (86>90) 239 SUZUKI Swift Made in Japan (89>96) 324
598299	23022 666	0	MERCEDES Class V (96>2002) 213 MERCEDES Vito (96>2003) 215
598300	23021 665	0	MERCEDES Class G (M461/3) (89>) 195 MERCEDES Sprinter (95>2006) 214 VOLKSWAGEN LT II (96>2003) 380 LT III (2003>2006) 381
598301	23020 665	0	MERCEDES Class V (96>2002) 214 MERCEDES Vito (96>2003) 215
598303	21911 653	0	AUDI A3 (96>2000) 60 TT (98>2006) 72 SEAT Ibiza (2001>) 310 Leon (99>2006) 311 Toledo (98>2004) 313 SKODA Octavia (96>2000) 315 Octavia (2000>) 316 VOLKSWAGEN Bora (98>2005) 358 Golf III (91>99) 363 Golf IV (97>2006) 366 New Beetle (98>2001) 370 Passat IV (93>97) 372 Vento (91>97) 379
598305	21829 641	0	OPEL Calibra (89>97) 245 Vectra B (95>99) 253 Vectra B (99>2003) 253 SAAB 9-3 (98>2003) 302 9-5 (97>2001) 303 900 (93>98) 304 VAUXHALL Calibra (90>97) 345 Vectra (95>2002) 352



















Valeo		WVA	Valeo	
598308	21636 616	2	ALFA ROMEO	145 (94>2001) 45
				146 (94>2001) 46
				156 (97>2003) 48
				166 (98>2003) 49
				166 (2003>2007) 49
				GTV (95>2003) 52
				Spider (95>2003) 53
				FIAT
				Bravo (95>2002) 113
				Coupe (93>2000) 113
Marea (96>2002) 116				
LANCIA				
Kappa (94>2001) 178				
Lybra (99>2006) 178				
598310	21677 623	431831	BMW	Series 5 (E39) (95>2004) 81
598311	21691 624	431847	BMW	Series 5 (E39) (95>2004) 81
598312	21729 629	2	FORD	Scorpio (92>94) 139
598315	21028 558	431821	MERCEDES	190 (201) (82>93) 196
				200/300 (W124) (84>93) 197
				Class E (W124) (93>98) 205
598316	23241 692	0	CHEVROLET	Matiz (2005>) 88
				Spark (2005>) 88
			DAEWOO	Matiz (98>2005) 107
598317	23154 682	0	FORD	Focus (98>2001) 133
				Focus (2001>2004) 133
598318	21920 654	2	MITSUBISHI	Carisma (95>99) 222
				Carisma (99>2003) 222
				Colt (2004>) 223
				Space Star (98>) 228
			SMART MCC	Forfour (2004>) 318
			VOLVO	S40 (95>2004) 389
				V40 (95>2004) 390
598319	21861 645	2	MITSUBISHI	Carisma (99>2003) 222
				Colt (2004>) 223
				Space Star (98>) 228
			SMART MCC	Forfour (2004>) 318
			VOLVO	S40 (95>2004) 389
				V40 (95>2004) 390
598320	23080 673	2	MITSUBISHI	Carisma (95>99) 222
598322	23063 670	4	OPEL	Astra G (98>2005) 244
			VAUXHALL	Astra MK IV (98>2005) 344

Valeo		WVA	Valeo	
598326	23124 679	4	CITROËN	Xsara (97>2000) 100
				CITROËN
				Berlingo (96>2002) 101
				PEUGEOT
				306 (97>2002) 263
			PEUGEOT	Partner (96>2002) 271
				Ranch (96>2002) 271
598328	21965 660	0	RENAULT	Laguna I (94>98) 284
				Laguna I (98>2000) 285
				Laguna I Nevada (95>98) 285
				Laguna I Nevada (98>2000) 286
598329	21999 664	2	SMART MCC	Crossblade (2002>) 318
				Fortwo (98>2006) 318
				Fortwo (2007>) 318
				Roadster (2003>2005) 318
598330	21945 658	0	SEAT	Arosa (97>2004) 307
				Cordoba (93>96) 307
				Cordoba (96>99) 307
				Cordoba (99>2002) 308
				Ibiza (96>99) 310
				Ibiza (99>2001) 310
				Toledo (91>98) 312
			SEAT	Inca (95>2003) 313
			VOLKSWAGEN	Golf III (91>99) 361
				Golf III Cabriolet (98>2002) 366
				Passat IV (93>97) 372
				Polo V (94>99) 375
				Polo VI (99>2001) 375
				Vento (91>97) 379
			VOLKSWAGEN	Caddy II (95>2004) 380
598331	23177 684	0	ALFA ROMEO	146 (94>2001) 46
				155 (91>97) 47
				GTV (95>2003) 52
				GTV (2003>2006) 52
				Spider (95>2003) 54
				Spider (2003>2006) 54
			FIAT	Barchetta (95>2003) 112
				Barchetta (2003>) 112
				Bravo (95>2002) 113
				Coupe (93>2000) 114
				Marea (96>2002) 116
			LANCIA	Dedra (94>99) 176



Valeo	WVA 		
598332	21974 662	0	AUDI  A1 (2010>) 59 A3 (96>2000) 59 SEAT  Cordoba (2002>) 308 Ibiza (2001>) 310 Ibiza (2008>) 311 Leon (99>2006) 311 Toledo (98>2004) 313 SKODA  Fabia (99>2004) 314 Fabia (2004>2007) 314 Fabia (2006>) 315 Octavia (96>2000) 315 Octavia (2000>) 316 Roomster (2006>) 317 VOLKSWAGEN  Bora (98>2005) 357 Fox (2004>) 360 Golf IV (97>2006) 366 New Beetle (98>2001) 370 Polo V (94>99) 375 Polo VII (2001>) 376 Polo VIII (2005>) 376 Polo IX (2009>) 376
598334	20783 538	2	FORD  Escort (80>86) 130
598335	20908 548	0	FORD  Escort (86>90) 130 Escort (90>94) 131 Escort (95>2001) 131 Granada (92>95) 136 Orion (90>93) 138 Scorpio (85>92) 139 Scorpio (92>94) 139 Sierra (82>86) 140 Sierra (87>93) 140
598337	20152 503	0	VOLVO  240 (82>93) 385 242 (74>84) 385 244 (79>82) 385 245 (79>82) 385 262 (78>80) 385 264 (78>82) 385 265 (78>85) 386
598338	20088 501	0	FORD  Escort (67>74) 130 PEUGEOT  204 (65>77) 258 ROVER  Spitfire (70>80) 302 TALBOT  Avenger (70>81) 326 VOLVO  240 (82>93) 385 242 (74>84) 385 244 (79>82) 385 245 (79>82) 385 262 (78>80) 385 264 (78>82) 385 265 (78>85) 386



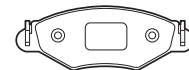





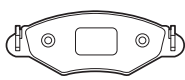







Valeo	WVA 		
598345	20687 531	0	MERCEDES  190 (201) (82>93) 197 200/300 (W124) (84>93) 198 Class C (W202) (93>2001) 200 Class E (W124) (93>98) 205
598351	20387 514	0	ALFA ROMEO  75 (85>93) 45 90 (84>88) 45 Alfetta (72>85) 50 Giulietta (76>86) 51 GTV (80>87) 52 RZ (92>93) 53 SZ (89>91) 54
598353	21209 575	4	CITROËN  ZX (91>98) 101 PEUGEOT  306 (93>97) 262
598355	21911 653	0	AUDI  Cabriolet (91>2000) 57 100 (82>90) 58 A4 (94>98) 61 VOLKSWAGEN  Passat V (96>2000) 372
598356	21353 587	2	OPEL  Astra F (91>2001) 243 Astra Classic (98>2002) 243 Corsa A (82>93) 245 Corsa B (93>2000) 246 Tigra (94>2001) 252 Vectra A (88>95) 252 OPEL  Combo (85>93) 256 Combo (93>2001) 256 VAUXHALL  Astra MK III (91>2001) 343 Cavalier (88>95) 347 Corsa MK I (93>2000) 348 Nova (83>93) 350 Tigra (94>2001) 351 VAUXHALL  Combo (93>2001) 354
598357	21195 573	431828	MERCEDES  Class C (W202) (93>2001) 200 Class CLK (W208) (97>2003) 203 Class E (W210) (95>2003) 206 Class SLK (170) (96>2003) 212
598360	21145 567	0	CITROËN  AX (91>98) 92 Saxo (96>99) 97 Saxo (99>2005) 97
598361	23235 691	2	CHEVROLET  Epica (2006>) 87 Evanda (2005>) 88 Rezzo (2005>2008) 88 Tacuma (2005>2008) 88 DAEWOO  Evanda (2002>2005) 106 Leganza (97>2003) 107 Rezzo (2000>) 107 Tacuma (2000>) 107

















Valeo	WVA	Valeo	Valeo
598362	20285 509	0	CITROËN 2 CV 91 Ami 8 91 Dyane (67>83) 96 GS (70>80) 97 Mehari (68>87) 97 CITROËN Acadiane (78>87) 101
*598363	20307 510	0	CITROËN Ami 8 91 Axel (84>90) 92 GS (70>80) 97 GSA (79>86) 97
598364	20371 513	0	CITROËN CX (74>91) 96
598366	20488 518	2	RENAULT R20 (75>84) 278 RENAULT Trafic (80>89) 297 Trafic (89>94) 297
598369	20784 538	2	IVECO Daily (78>89) 164 Daily (89>96) 165
*598371	20375 513	0	FIAT 127/128 (66>86) 111 FIAT Fiorino (147) (81>89) 128
598374	20380 514	1	JAGUAR XJ (73>86) 167 RENAULT Master (80>89) 296 Master (89>94) 296 Master (94>97) 296
*598375	20913 549	2 (A)	AUDI 100 (71>82) 57 BMW 1500 / 2002 74 CITROËN Visa (78>88) 98 PEUGEOT 104 (72>88) 257 304 (69>80) 262 305 (77>82) 262 305 (82>90) 262 RENAULT R14 (76>84) 276 TALBOT 1307/8/9 (75>79) 326 Samba (81>85) 327 Solara (80>85) 327
598377	20671 528	2	RENAULT R5 (72>85) 275 R12 (69>80) 276 R18 (77>86) 276

Valeo	WVA	Valeo	Valeo
598379	20718 533	0	NISSAN Bluebird (910) (80>84) 234 Bluebird (T12) (85>90) 234 Bluebird (U11) (83>90) 234 Cherry (N12) (82>87) 235 Laurel (C31) (81>84) 235 Prairie (M10) (82>88) 237 Stanza (T11) (81>85) 238 Sunny (B11) (81>86) 238 NISSAN Vanette (C120) Made in Japan (81>86)
241			
598380	20359 512	2 (A)	IVECO Daily (78>89) 164 Daily (89>96) 165
598382	20234 507	1	RENAULT Espace II (91>96) 282
598383	21632 615	4	CITROËN Xantia (93>97) 98 Xantia (97>2002) 99
598384	20957 551	0	NISSAN Micra (K10) (82>92) 236
598385	23129 679	4	CITROËN Xantia (93>97) 98 Xantia (97>2002) 99
598386	20180 505	431827	BMW Series 3 (E36) (90>2001) 77 Z1 (E30) (89>92) 86 Z3 (E36) (96>2002) 86
598389	20660 527	0	LADA Niva (76>) 174
*598391	20894 545	2	FORD Transit (78>85) 143 RELIANT Scimitar (68>92) 274 ROVER SD1 (76>87) 301
598392	20038 500	0	INNOCENTI Mini (74>84) 163 Mini tre (82>93) 163 MG Midget (62>80) 216 ROVER Mini (59>80) 301 Mini (80>90) 301 Mini (90>99) 301 TR7 (74>81) 302
598393	21775 635	4	TOYOTA 4 Runner (130) (89>95) 328 4 Runner (180) (95>2002) 328 Land Cruiser (BJ80) (90>98) 329



Valeo	WVA 		
598396	20635 525	0	CITROËN  Saxo (96>99) 97 Saxo (99>2005) 98 Xsara (97>2000) 100 Xsara (2000>2005) 100 ZX (91>98) 101 PEUGEOT  106 (96>2003) 258 205 (83>87) 259 205 (87>98) 259 206 (98>) 261 306 (93>97) 262 306 (97>2002) 263 309 (85>89) 264 309 (89>94) 265 RENAULT  Super 5 (84>96) 275 R9 (81>88) 275 R11 (82>89) 275 R19 (88>92) 277 R19 (92>95) 277 Clio I (90>96) 280 Clio I (96>98) 280 Clio II (98>2001) 280 Clio II (2001>) 281 Lutecia (Japan) (94>98) 287 Mégane (95>99) 287 Mégane (98>2003) 288 Mégane Classic (99>2002) 288 Safrane (92>96) 292
598398	23124 679	0	CITROËN  Xsara Picasso (99>) 100 CITROËN  Berlingo (96>2002) 101 PEUGEOT  206 (98>) 260
598399	23300 702	0	FORD  Escort (90>94) 130 Escort (95>2001) 131 Orion (90>93) 138
598402	21158 570	0	TOYOTA  Hilux (83>98) 328 TOYOTA  Camry (86>91) 332 TOYOTA  Dyna 100 (85>2001) 340 Hiace (82>89) 341
598403	21866 646	0	SEAT  Cordoba (96>99) 307 Cordoba (99>2002) 308 Ibiza (96>99) 310 Ibiza (99>2001) 310 VOLKSWAGEN  Golf III (91>99) 361 Polo V (94>99) 375 Polo VI (99>2001) 375 Vento (91>97) 379
598405	20166 504	0	LADA  1200/1300/1500/1600/ Classica 174 Kalinka (95>98) 175



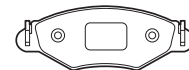















Valeo	WVA 		
598406	21170 571	0	LADA  Natacha (93>) 175 Sagona (91>) 175 Samara (86>) 175
598407	23661 757	0	ALFA ROMEO  147 (2000>2004) 46 147 (2004>) 47 156 (97>2003) 48 156 (2003>2007) 48 GT (2003>) 51 FIAT  Linea (2007>) 116 LANCIA  Lybra (99>2006) 178
598408	21974 662	1	AUDI  A2 (2000>2005) 59 A3 (2000>2003) 60 A3 (2003>2008) 60 A3 (2008>) 61 A3 Cabriolet (2008>) 61 SEAT  Altea (2004>) 306 Ibiza (2008>) 311 Leon (99>2006) 311 Leon (2005>) 311 Toledo (2004>) 313 SKODA  Yeti (2009>) 313 SKODA  Fabia (99>2004) 314 Fabia (2004>2007) 314 Fabia (2006>) 315 Octavia (96>2000) 315 Octavia (2000>) 316 Octavia (2004>2008) 316 Octavia (2008>) 316 Roomster (2006>) 317 VOLKSWAGEN  Bora (98>2005) 357 Golf IV (97>2006) 366 Golf V (2003>) 367 Golf VI (2008>) 368 Golf Plus (2005>) 368 Golf Plus (2009>) 369 Jetta III (2005>) 369 New Beetle (98>2001) 370 New Beetle (2001>2005) 370 New Beetle (2005>) 371 Polo VII (2001>) 376 Polo VIII (2005>) 376 VOLKSWAGEN  Caddy III (2004>) 380
598409	21064 561	0	BMW  Series 5 (E39) (95>2004) 81
598410	23312 703	0	BMW  Series 5 (E60/61) (2003>) 81 Series 6 (E63/64) (2003>) 82 Series 7 (E65) (2001>2008) 83 Series 7 (E66) (2002>2008) 84 M3 (E90/92/93) (2007>) 85

















Valeo		WVA	Valeo	
598411		21282 583	0	BMW Series 7 (E65) (2001>2008) 83 Series 7 (E66) (2002>2008) 84
598412		23449 726	0	BMW X3 (2006>) 74 X5 (2000>2006) 74 BMW Series 5 (E39) (95>2004) 81 Series 7 (E38) (94>2001) 83 M5 (E39) (99>2003) 85
598413		23282 700	0	MINI MINI (R50/52/53) (2001>) 217
598414		23638 755	2	JEEP Cherokee (2001>) 169 Grand Cherokee (2000>2003) 169
598415		23640 755	2	CHRYSLER Voyager IV (2001>) 90 Grand Voyager (2001>2004) 90
598416		23273 698	4	CITROËN C5 (2001>2008) 94
598417		23276 699	4	CITROËN C5 (2001>2008) 94
598418		23305 703	0	CITROËN C5 (2001>2008) 95
598419		23277 699	4	CITROËN C5 (2001>2008) 94
598420		23134 680	4	CITROËN Xantia (93>97) 99 Xantia (97>2002) 99 XM (94>2001) 99
598422		20907 547	0	FIAT Palio Week End (97>2001) 117 Palio Week End (2001>2002) 117 FIAT Doblo (2000>2003) 125 Doblo (2004>2005) 125 Doblo Cargo (2000>2003) 125 Doblo Cargo (2004>2005) 125
598423		21193 572	2 (B)	FIAT Palio (96>2001) 117 Palio (2001>) 117 Siena (97>2001) 121
598424		20907 547	2	FIAT Palio (2001>) 117 Palio Week End (97>2001) 117 Palio Week End (2001>2002) 117 Punto II (99>2003) 119 Siena (2002>) 121 FIAT Strada Pick up (99>2003) 128 Strada Pick up (2003>2006) 129 Strada II Pick-up (2006>) 129









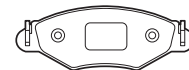









Valeo		WVA	Valeo	
598425		23661 757	0	ABARTH 500 Nuova (2008>) 44 FIAT 500 Nuova (2007>) 112 Panda (2003>) 118 Punto II (99>2003) 119 Punto II (2003>) 119 LANCIA Musa (2007>) 179 Ypsilon (2003>) 181
598426		23705 762	1	ALFA ROMEO MiTo (2008>) 52 CITROËN Nemo (2007>) 104 FIAT 500 Nuova (2007>) 112 Bravo II (2007>) 113 Linea (2007>) 115 Grande Punto (2005>) 119 Qubo (2008>) 120 Stilo (2001>2003) 121 Stilo (2004>) 121 FIAT Doblo Cargo II (2006>) 125 Fiorino (2007>) 128 PEUGEOT Bipper (2007>) 269
598427		23708 762	1 (A)	FIAT Bravo II (2007>) 113 Idea (2007>) 115 Stilo (2001>2003) 121 Stilo (2004>) 122 LANCIA Delta (2008>) 177 Musa (2007>) 178
598428		23711 763	1	ALFA ROMEO MiTo (2008>) 52 FIAT Bravo II (2007>) 113 Stilo (2001>2003) 121 Stilo (2004>) 122 LANCIA Delta (2008>) 177
598429		21797 637	1 (A)	CITROËN Jumper (94>2001) 103 Relay (94>2001) 104 FIAT Ducato (94>2001) 126 PEUGEOT Boxer I (94>2001) 269
598430		21799 638	1 (B)	CITROËN Jumper (94>2001) 103 Relay (94>2001) 104 FIAT Ducato (94>2001) 126 PEUGEOT Boxer I (94>2001) 269
598431		23353 712	1	FORD Fiesta (2002>2005) 132 Fiesta (2005>2008) 133 Focus (98>2001) 133 Focus (2001>2004) 133

















Valeo		WVA 		
598432		23577 744	2	FORD  Transit (2000>2006) 143
598433		23279 700	0	FORD  Mondeo (2000>2003) 137 Mondeo (2003>2005) 138 Mondeo (2005>2007) 138 JAGUAR  X-Type (2001>2008) 168
598434		23557 742	0	FORD  Mondeo (2000>2003) 137 Mondeo (2003>2005) 138 JAGUAR  X-Type (2001>2008) 168
598435		23097 675	0	HONDA  Accord VI (98>2003) 147
598436		23095 675	2	HONDA  Accord VI (98>2003) 147 MG  MG ZR (2001>2005) 216 MG ZS (2001>2005) 216
598437		21738 631	2	HONDA  Civic V (EJ/EK) (95>2001) 150 CRX (92>98) 152
598438		23424 721	0	JAGUAR  S-Type (98>2003) 166 S-Type (2004>) 167 Sovereign (2002>) 167 XJ (2002>) 167
598439		23423 721	0	JAGUAR  S-Type (98>2003) 166 S-Type (2004>) 167 Sovereign (2002>) 167 XJ (2002>) 167
598440		21064 561	0	JAGUAR  Sovereign (94>) 167 XJ (86>94) 167 XJ (94>2002) 167 XJR (88>94) 168 XJR (94>) 168 XK (2004>) 168 XK8 (96>2004) 168 XK8 (2004>) 168
598441		23452 727	0	LAND ROVER  Discovery (98>2004) 182 Range Rover (94>2002) 184
598442		23193 687	1	MERCEDES  Class ML (163) (97>2005) 195
598443		23189 686	1	MERCEDES  Class ML (163) (97>2005) 196

Valeo		WVA 		
598444		21919 654	0	CHRYSLER  Crossfire (2003>) 89 MERCEDES  Class C (W202) (93>2001) 200 Class C (W203) (2000>2003) 201 Class C (W203) (2004>) 202 Class CLC (W203) (2008>) 203 Class CLK (W208) (97>2003) 203 Class CLK (W209) (2002>2009) .. 204 Class E (W210) (95>2003) 206 Class SLK (170) (96>2003) 213 Class SLK (171) (2004>2007) ... 213 Class SLK (171) (2008>) 213
598445		23271 698	0	MERCEDES  Class ML (163) (97>2005) 195 MERCEDES  Class C (W203) (2000>2003) 201 Class C (W203) (2004>) 202 Class CL (W215) (99>2006) 202 Class S (W220) (98>2004) 210 Class SL (129) (89>2001) 211
598446		23078 672	0	MERCEDES  Class CL (W215) (99>2006) 202 Class S (W220) (98>2004) 210
598447		21899 650	431843 431843 0 0 431843 0 0	MERCEDES  Class C (W203) (2000>2003) 201 Class C (W203) (2004>) 202 Class CLC (W203) (2008>) 203 Class CLK (W209) (2002>2009) .. 204 Class E (W210) (95>2003) 207 Class SLK (171) (2004>2007) ... 213 Class SLK (171) (2008>) 213
598448		23144 681	431843	MERCEDES  Class C (W203) (2000>2003) 201 Class C (W203) (2004>) 201 Class CLC (W203) (2008>) 203 Class CLK (W209) (2002>2009) .. 204 Class SLK (171) (2004>2007) ... 213 Class SLK (171) (2008>) 213
598449		23023 666	2	NISSAN  Almera (N15) (95>2000) 233
598450		23093 674	0	NISSAN  Almera (N16E) (2000>2003) 233 Almera (N16E) (2003>2006) 233 Primera (P11/W11) (96>2002) ... 237
598451		23095 675	0	NISSAN  Almera Tino (V10M) (2000>2003) 234 Almera Tino (V10B) (2003>2005) . 234 Primera (P12/W12) (2001>) 237
598452		23420 720	0	NISSAN  Pathfinder (R50) (97>2003) 230 X-Trail (T30) (2001>2003) 231 X-Trail (T30) (2003>2007) 232



Valeo	WVA 		
598453	23253 695	2	OPEL  Agila (2000>2007) 242
			SUBARU  Justy G3X (2003>) 321
			SUZUKI  Ignis (2003>) 324 Wagon R+ (2000>) 325
			VAUXHALL  Agila (2000>2007) 342
			598454
598456	23225 690	2	OPEL  Corsa C (2000>2003) 246 Corsa C (2003>2006) 246 Meriva (2003>) 248 Tigra Twintop (2004>2008) 252
			OPEL  Combo/Combo Tour (2001>) 256
			VAUXHALL  Corsa MK II (2000>2003) 348 Corsa MK II (2003>2006) 348 Meriva (2003>) 349 Tigra Twintop (2004>2008) 351
			VAUXHALL  Astramax (91>98) 354 Combo (2001>) 354
			598457
598458	23358 713	2	OPEL  Sintra (96>99) 251
			VAUXHALL  Sintra (96>99) 351
598459	23361 714	2	OPEL  Sintra (96>99) 251
			VAUXHALL  Sintra (96>99) 351
598460	21845 644	1	ISUZU  Trooper (81>97) 164 Trooper (98>) 164
			OPEL  Frontera A (91>98) 241 Frontera B (98>2005) 242 Monterey (91>99) 242
			OPEL  Campo (88>96) 255
			VAUXHALL  Frontera A (91>98) 342 Monterey A (94>99) 342 Monterey B (98>99) 342

Valeo	WVA 		
598461	21980 663	0 (A)	CITROËN  Xsara (97>2000) 100
			PEUGEOT  206 (98>) 259 206+ (2009>) 261
			598462
598463	20960 553	0 (D)	PEUGEOT  206 (98>) 260 306 (97>2002) 263
			AUDI  A1 (2010>) 59 A2 (2000>2005) 59 A3 (2000>2003) 60 A3 (2003>2008) 60 A3 (2008>) 61 A3 Cabriolet (2008>) 61 A4 (94>98) 61 A4 (99>2001) 62 A4 (2000>2004) 62 A4 (2004>2008) 62 A4 Cabriolet (2002>2005) 63 A4 Cabriolet II (2006>2009) 63 A6 (97>2001) 64 A6 (2001>2005) 65 A6 (2004>2008) 65 A6 Allroad (2000>2005) 66 A8 (94>2002) 67 S4 (99>2001) 69 S4 (2004>2008) 70 S6 (99>2001) 71 S6 (2001>2005) 71 S8 (99>2002) 71 TT (98>2006) 72
598464	23396 715	0	CITROËN  C2 (2003>2010) 92 C3 (2002>2005) 92 C3 Pluriel (2003>) 93 C4 (2004>) 94 C8 (2002>) 95 Xsara Picasso (99>) 101
			CITROËN  Berlingo (2002>) 102
			FIAT  Ulysse (2002>) 124
			FORD  Galaxy (95>2000) 135 Galaxy (2000>2006) 135
			LANCIA  Phedra (2002>) 179
598465	23396 715	0	PEUGEOT  1007 (2005>) 258 307 (2001>2005) 263 307 (2005>) 263 308 (2007>) 264 807 (2002>) 269
			PEUGEOT  Partner (2002>) 271 Ranch (2002>) 272



Valeo	WVA	Valeo	
598463 (...)	20960 553	0 (D)	<p>SEAT </p> <p>Alhambra (96>2000) 305</p> <p>Altea (2004>) 306</p> <p>Arosa (97>2004) 307</p> <p>Cordoba (96>99) 308</p> <p>Cordoba (2002>) 308</p> <p>Ibiza (96>99) 310</p> <p>Ibiza (2001>) 310</p> <p>Ibiza (2008>) 311</p> <p>Leon (99>2006) 311</p> <p>Leon (2005>) 312</p> <p>Toledo (2004>) 313</p> <p>SKODA </p> <p>Yeti (2009>) 314</p> <p>SKODA </p> <p>Fabia (99>2004) 314</p> <p>Fabia (2006>) 315</p> <p>Octavia (2000>) 316</p> <p>Octavia (2004>2008) 316</p> <p>Octavia (2008>) 317</p> <p>Roomster (2006>) 317</p> <p>Superb (2001>2008) 317</p> <p>VOLKSWAGEN </p> <p>Bora (98>2005) 359</p> <p>Corrado (88>95) 359</p> <p>Eos (2006>) 360</p> <p>Golf III (91>99) 365</p> <p>Golf IV (97>2006) 367</p> <p>Golf V (2003>) 368</p> <p>Golf VI (2008>) 368</p> <p>Golf Plus (2005>) 369</p> <p>Golf Plus (2009>) 369</p> <p>Jetta III (2005>) 370</p> <p>Lupo (98>2005) 370</p> <p>New Beetle (98>2001) 370</p> <p>New Beetle (2005>) 371</p> <p>Passat III (88>93) 372</p> <p>Passat IV (93>97) 372</p> <p>Passat V (96>2000) 373</p> <p>Passat VI (2000>2005) 373</p> <p>Polo V (94>99) 375</p> <p>Polo VII (2001>) 376</p> <p>Polo VIII (2005>) 376</p> <p>Polo IX (2009>) 377</p> <p>Scirocco (2008>) 377</p> <p>Sharan (95>2000) 377</p> <p>Vento (91>97) 379</p> <p>VOLKSWAGEN </p> <p>Caddy III (2004>) 380</p>



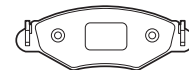

















Valeo	WVA	Valeo	
598464	23599 750	0	<p>CITROËN </p> <p>C2 (2003>2010) 92</p> <p>C3 (2005>) 93</p> <p>C3 (2009>) 93</p> <p>C3 Picasso (2009>) 93</p> <p>C4 (2004>) 93</p> <p>DS3 (2010>) 96</p> <p>Xsara (2000>2005) 100</p> <p>Xsara Picasso (99>) 100</p> <p>CITROËN </p> <p>Berlingo (96>2002) 101</p> <p>Berlingo (2002>) 101</p> <p>PEUGEOT </p> <p>1007 (2005>) 258</p> <p>206 (98>) 260</p> <p>207 (2006>) 261</p> <p>307 (2001>2005) 263</p> <p>307 (2005>) 263</p> <p>PEUGEOT </p> <p>Partner (96>2002) 271</p> <p>Partner (2002>) 271</p> <p>Ranch (96>2002) 271</p> <p>Ranch (2002>) 272</p>
598465	23600 750	0	<p>CITROËN </p> <p>C3 (2005>) 93</p> <p>C4 (2004>) 93</p> <p>Xsara (2000>2005) 100</p> <p>Xsara Picasso (99>) 101</p> <p>CITROËN </p> <p>Berlingo (2002>) 101</p> <p>PEUGEOT </p> <p>1007 (2005>) 258</p> <p>206 (98>) 260</p> <p>207 (2006>) 261</p> <p>307 (2001>2005) 263</p> <p>307 (2005>) 263</p> <p>PEUGEOT </p> <p>Partner (2002>) 271</p> <p>Ranch (2002>) 272</p>
598466	21381 593	4	<p>PEUGEOT </p> <p>406 (95>2004) 265</p>
598467	21674 623	4	<p>PEUGEOT </p> <p>607 (2000>2004) 268</p>
598468	23092 674	4	<p>CITROËN </p> <p>C8 (2002>) 95</p> <p>FIAT </p> <p>Ulysse (2002>) 124</p> <p>LANCIA </p> <p>Phedra (2002>) 179</p> <p>PEUGEOT </p> <p>607 (2000>2004) 268</p> <p>807 (2002>) 269</p>
598470	20920 550	2	<p>RENAULT </p> <p>Espace III (96>2000) 282</p> <p>Espace III (2000>2002) 283</p>























Valeo		VVA		
598471		23659 757	0	RENAULT <ul style="list-style-type: none"> Espace IV (2002>2006) 283 Espace IV (2006>) 283 Laguna II (2001>2005) 286 Laguna II (2005>2007) 286 Mégane Scenic (99>2003) 291 Vel Satis (2002>2005) 294 Vel Satis (2005>) 294
598472		23482 731	0	CADILLAC <ul style="list-style-type: none"> BLS (2005>) 87 FORD <ul style="list-style-type: none"> Focus (2004>) 133 Focus II (2007>) 134 Focus C-Max (2003>2007) 134 Focus C-Max (2007>) 134 Focus Coupé Cabriolet (2006>) .. 135 FORD <ul style="list-style-type: none"> Touneo Connect (2002>2006) .. 142 Touneo Connect (2006>) 142 Transit Connect (2002>2006) 144 Transit Connect (2006>) 144 NISSAN <ul style="list-style-type: none"> Primera (P12/W12) (2001>) 237 OPEL <ul style="list-style-type: none"> Signum A (2003>2005) 251 Vectra C (2002>2005) 254 RENAULT <ul style="list-style-type: none"> Espace IV (2002>2006) 283 Espace IV (2006>) 283 Mégane II (2002>) 290 Vel Satis (2002>2005) 294 Vel Satis (2005>) 294 SAAB <ul style="list-style-type: none"> 9-3 (2002>) 303 VAUXHALL <ul style="list-style-type: none"> Signum A (2003>2005) 351 Vectra (2002>2005) 352 Vectra (2005>2009) 352
598473		20916 549	0	RENAULT <ul style="list-style-type: none"> Clio II (98>2001) 280 Clio II (2001>) 281 Laguna I (98>2000) 284 Laguna I Nevada (98>2000) 285 Mégane (98>2003) 287 Mégane Classic (99>2002) 288 Mégane Scenic (96>99) 291 Mégane Scenic (99>2003) 291 Safrane (96>2000) 292

Valeo		VVA		
598474		20960 553	0 (D+C)	AUDI <ul style="list-style-type: none"> A4 Cabriolet II (2006>2009) 63 CITROËN <ul style="list-style-type: none"> C3 (2009>) 93 C3 Picasso (2009>) 93 DS3 (2010>) 96 PEUGEOT <ul style="list-style-type: none"> 207 (2006>) 261 RENAULT <ul style="list-style-type: none"> Clio III (2005>) 281 Clio III (2009>) 282 Fluence (2009>) 283 Mégane II (2002>) 289 Mégane III (2008>) 290 Scenic II (2003>) 292 Grand Scenic II (2003>) 293 Scenic III (2009>) 293 Twingo III (2007>) 294 Wind (2010>) 294 SEAT <ul style="list-style-type: none"> Exeo (2008>) 308
598475		23116 678	2	OPEL <ul style="list-style-type: none"> Astra G (98>2005) 244 Zafira A (98>2003) 254 Zafira A (2003>2005) 254 SAAB <ul style="list-style-type: none"> 9-3 (98>2003) 302 9-5 (97>2001) 303 9-5 (2001>2005) 303 9-5 (2005>) 303 VAUXHALL <ul style="list-style-type: none"> Astra MK IV (98>2005) 344 Zafira I (99>2003) 353 Zafira I (2003>2005) 353
598476		21854 644	4	NISSAN <ul style="list-style-type: none"> 200 SX (S14) (94>) 232 SUBARU <ul style="list-style-type: none"> Impreza (93>2000) 320 Impreza (2000>2005) 320 Impreza (2005>2007) 320
598478		21976 662	2	TOYOTA <ul style="list-style-type: none"> Avensis (97>2000) 331 Avensis (2000>2003) 331
598479		23072 671	0	VOLVO <ul style="list-style-type: none"> XC 70 (2000>2007) 384 VOLVO <ul style="list-style-type: none"> S60 (2000>) 390 V70 (2000>2007) 392 S80 (98>2006) 393
598480		23075 672	0	VOLVO <ul style="list-style-type: none"> XC 70 (97>99) 384 XC 70 (2000>2007) 384 VOLVO <ul style="list-style-type: none"> S60 (2000>) 391 S70 (96>2000) 392 V70 (96>2000) 392 V70 (2000>2007) 393 S80 (98>2006) 393
598481		21911 653	0	VOLVO <ul style="list-style-type: none"> C70 (97>2005) 391



Valeo		WVA 		
598482		21748 631	0 (B)	VOLKSWAGEN  Transporter (F70) (90>96) 382 Transporter (F7D) (96>2003) 383
598483		20676 530	2 (A)	AUDI  A4 (99>2001) 61 A4 (2000>2004) 62 A6 (97>2001) 64 A6 (2001>2005) 64 A6 (2008>) 65 SEAT  Exeo (2008>) 308 SKODA  Superb (2001>2008) 317 VOLKSWAGEN  Passat VI (2000>2005) 373
598484		21366 590	2	AUDI  A4 (99>2001) 61 A4 (2000>2004) 62 A4 (2004>2008) 62 SEAT  Exeo (2008>) 308 VOLKSWAGEN  Passat V (96>2000) 372
598486		21911 653	1	AUDI  A3 (2000>2003) 60 TT (98>2006) 72 SEAT  Leon (99>2006) 311 Toledo (98>2004) 313 SKODA  Octavia (2000>) 316 VOLKSWAGEN  Bora (98>2005) 358 Golf IV (97>2006) 366 New Beetle (98>2001) 370 New Beetle (2001>2005) 370 New Beetle (2005>) 371 Polo VIII (2005>) 376
598488		21865 645	0	SEAT  Arosa (97>2004) 307 SKODA  Fabia (99>2004) 314 Fabia (2006>) 315 VOLKSWAGEN  Fox (2004>) 360 Lupo (96>2005) 370 Polo V (94>99) 375 Polo VI (99>2001) 375 Polo VII (2001>) 376 Polo VIII (2005>) 376
598489		20676 530	1 (A)	FORD  Galaxy (2000>2006) 135 SEAT  Alhambra (2000>2003) 306 VOLKSWAGEN  Sharan (2000>2003) 378



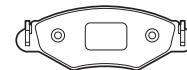

















Valeo		WVA 		
598490		23302 702	0	OPEL  Movano (98>2003) 256 Movano (2003>2006) 256 Movano (2006>) 256 RENAULT  Master (97>2003) 296 VAUXHALL  Movano (98>2003) 355 Movano (2003>2006) 355 Movano (2006>) 355
598491		21822 640	0	JEEP  Cherokee (77>) 168 Grand Cherokee (93>2000) 169 KIA  Carnival (99>2002) 171 RENAULT  Cherokee 274 Jeep 274
598493		21983 663	0	MITSUBISHI  Carisma (99>2003) 222 Colt (2004>) 223 SMART MCC  Forfour (2004>) 318 VOLVO  S40 (95>2004) 389 V40 (95>2004) 390
598494		21694 625	0	HONDA  Civic IV (91>95) 149 Civic V (EJ*) (96>2000) 149 Civic V (EJ/EK) (95>2001) 150 Civic (EP) (2001>2006) 150 Civic (FK/FD) (2006>) 150 CRX (92>98) 152
598495		21697 625	2	HONDA  Civic IV (91>95) 149 Civic V (EJ/EK) (95>2001) 150
598496		21835 642	0	TOYOTA  Model F (82>90) 330 TOYOTA  Previa (90>2000) 338 TOYOTA  Liteace (79>95) 341
598497		21237 578	1	LAND ROVER  Defender (90>2007) 182 Defender II (2007>) 182 Discovery (89>94) 182 Discovery (94>98) 182 Range Rover (81>86) 184 Range Rover (86>94) 184
598498		21897 650	1	LAND ROVER  Discovery (89>94) 182 Discovery (94>98) 182 Range Rover (86>94) 184
598499		20344 510	0	LAND ROVER  Discovery (98>2004) 182 Range Rover (94>2002) 184
598500		23407 719	0	CITROËN  C2 (2003>2010) 92 C3 (2002>2005) 92 C3 (2005>) 93























Valeo		VVA		
598501		23409 719	0	CITROËN C2 (2003>2010) 92 C3 (2002>2005) 92 C3 (2005>) 93 C3 Pluriel (2003>) 93 Xsara (2000>2005) 100
598502		21275 581	0	CITROËN Evasion (94>98) 96 Evasion (98>2002) 96 Synergie (95>98) 98 Synergie (98>2002) 98 FIAT Ulysse (94>98) 123 Ulysse (98>2002) 124 LANCIA Zeta (94>2002) 181 PEUGEOT 806 (94>98) 268 806 (98>2002) 268
598504		23518 736	2	GALLOPER Galloper (98>) 145 HYUNDAI Galloper (97>2002) 155
598505		23569 743	2	HYUNDAI Santa Fé (2000>2006) 155 HYUNDAI Satellite (98>2007) 160 Starex (98>) 162 XG (2002>) 162 HYUNDAI H1 (97>) 162 SSANGYONG Kyron (2005>2007) 318
598506		20789 539	0	HYUNDAI Terracan (2001>2002) 156 Terracan (2002>2007) 156
598507		21875 647	2	ISUZU Trooper (81>97) 164 Trooper (98>) 164 OPEL Frontera A (91>98) 241 Frontera B (98>2005) 242 Monterey (91>99) 242 VAUXHALL Frontera A (91>98) 342 Frontera B (98>2005) 342 Monterey A (94>99) 342 Monterey B (98>99) 342
598509		23425 722	2	JEEP Cherokee (77>) 168 Grand Cherokee (93>2000) 169
598510		23631 754	4	JEEP Grand Cherokee (2000>2003) 169
598511		23442 724	2	KIA Retona (99>) 170 Sportage (93>2002) 170
598512		21515 604	0	LAND ROVER Freelander (97>2003) 183
598514		23615 752	0	LAND ROVER Freelander (97>2003) 183 Freelander (2003>2006) 183









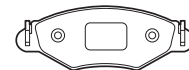









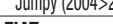

Valeo		VVA		
598515		20905 547	2	MAZDA MPV (95>99) 193 MPV (99>2002) 193 MPV (2002>2006) 193
598516		23514 736	1	MAZDA MPV (95>99) 193
598517		21363 588	2	MITSUBISHI L200 (K1/2/3) (86>2001) 218 L200 (K6/7) (96>2007) 218 Montero (V2/4) (93>2006) 219 Montero Sport (K9) (98>2009) ... 219 Pajero (V2/4) (90>2001) 219 Pajero Sport (K9) (98>2009) 220 Shogun (V2/4) (90>2001) 221 MITSUBISHI 3000 GT (90>2000) 221 Challenger (98>) 222 Galant (87>92) 224 Galant (96>2003) 225 Sigma (90>94) 228 Space Wagon (N8) (98>2004) ... 228 MITSUBISHI L400 (PA/PB/PD) 229
598518		21016 557	2	MITSUBISHI Pajero (VD/VF) (2000>2006) 220 Pajero (2006>) 220 Shogun (V6/7) (2000>2006) 221 Shogun (2006>) 221 MITSUBISHI Grandis (2004>) 225
598519		21840 643	2	MITSUBISHI Montero (V2/4) (93>2006) 219 Pajero (V2/4) (90>2001) 220 Shogun (V2/4) (90>2001) 221 MITSUBISHI Sigma (90>94) 228 Space Gear (94>98) 228
598520		23582 745	2	MITSUBISHI Outlander (CW) (2006>) 219 Pajero (VD/VF) (2000>2006) 220 Pajero (2006>) 220 Shogun (V6/7) (2000>2006) 221 Shogun (2006>) 221 MITSUBISHI Grandis (2004>) 225
598521		23487 731	1	MITSUBISHI Pajero Pinin (H7) (99>) 220 Shogun Pinin (99>) 221
598522		23290 701	2	MITSUBISHI L200 (K6/7) (96>2007) 218 Pajero (V2/4) (90>2001) 219 Shogun (V2/4) (90>2001) 220 MITSUBISHI Space Gear (94>98) 228 MITSUBISHI L 300 (Truck) (94>2000) 229 L400 (PA/PB/PD) 229
598523		23316 705	2	MITSUBISHI L200 (K6/7) (96>2007) 218 NISSAN Maxima QX (A32) (88>94) 236

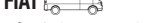





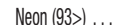
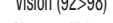







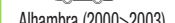
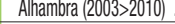
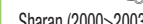
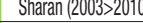

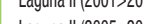
Valeo		VVA 		
598524		23611 751	2	NISSAN  Patrol GR (Y61) (97>2004) 231 Patrol GR (Y61) (2004>) 231
598527		23557 742	0	RENAULT  Kangoo (97>2003) 295 Kangoo (2003>) 296
598528		23230 691	2	SSANGYONG  Musso (93>) 318
598530		23558 742	2	SUBARU  Forester (97>2002) 319 Impreza (93>2000) 320 Legacy (94>98) 321 Legacy (98>2003) 321
598531		20708 532	0	SANTANA  Vitara 305 SUZUKI  Vitara (88>98) 323
598532		21336 586	0	SUZUKI  Samurai (92>) 322
598533		21907 651	2	SANTANA  Vitara 305 SUZUKI  Vitara (88>98) 323
598534		23314 705	2	SUZUKI  Grand Vitara (98>2005) 322 Grand Vitara XL7 (2001>2006) ... 322 Vitara (88>98) 323
598535		23524 737	2	LEXUS  LX 470 (2002>2007) 185 TOYOTA  Land Cruiser (HD/UZ10) (98>2007) 329
598536		23585 746	0	TOYOTA  RAV4 (2000>2005) 330
598537		23613 752	0	NISSAN  Interstar (2002>2006) 240 Interstar (2006>) 240 OPEL  Movano (98>2003) 256 Movano (2003>2006) 256 Movano (2006>) 256 RENAULT  Master (97>2003) 296 Master (2003>2006) 296 Master (2006>) 296 VAUXHALL  Movano (98>2003) 355 Movano (2003>2006) 355 Movano (2006>) 355

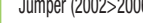
Valeo		VVA 		
598538		23669 758	0	NISSAN  Interstar (2002>2006) 240 Interstar (2006>) 240 OPEL  Movano (98>2003) 256 Movano (2003>2006) 256 Movano (2006>) 257 RENAULT  Master (97>2003) 296 Master (2003>2006) 296 Master (2006>) 296 VAUXHALL  Movano (98>2003) 355 Movano (2003>2006) 355 Movano (2006>) 355
598540		21833 641	0	TOYOTA  Camry (86>91) 332 Camry (91>96) 333 Camry (96>2001) 333 Carina II (87>92) 333 Carina E (92>97) 333 Celica (93>99) 334
598541		21961 660	2	TOYOTA  Avensis Verso (2001>2005) 332 Picnic (2001>2005) 337
598542		23646 756	2	TOYOTA  Avensis Verso (2001>2005) 332 Picnic (2001>2005) 338 Previa (2000>) 338
598543		23532 739	0	CHRYSLER  PT Cruiser (2000>2009) 89
598544		23561 743	0	CHRYSLER  300M (98>2003) 88 PT Cruiser (2000>2009) 89
598545		23099 676	0	NISSAN  Primastar (2002>2006) 240 Primastar (2006>) 240 OPEL  Vivaro (2001>2006) 257 Vivaro (2006>) 257 RENAULT  Espace III (2000>2002) 283 RENAULT  Trafic II (2001>2006) 298 Trafic II (2006>) 298 VAUXHALL  Vivaro (2001>2006) 355 Vivaro (2006>) 355
598546		21748 631	0 (A)	NISSAN  Primastar (2002>2006) 240 Primastar (2006>) 240 OPEL  Vivaro (2001>2006) 257 Vivaro (2006>) 257 RENAULT  Trafic II (2001>2006) 298 Trafic II (2006>) 298 VAUXHALL  Vivaro (2001>2006) 355 Vivaro (2006>) 356

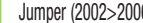

Valeo	WVA 		
598547	23577 744	0	FORD  Transit (2000>2006) 143
598548	23490 732	2	MAZDA  323 (BJ) (98>2000) 191 323 (BJ) (2000>2003) 191
598549	23070 671	431828	MERCEDES  Class A (W168) (97>2004) 199
598551	21601 613	2	TOYOTA  RAV4 (94>2000) 330 TOYOTA  Camry (91>96) 332 Carina E (92>97) 333 Corolla (100) (92>97) 335 Picnic (96>2001) 337
598553	20261 508	2 (A)	CITROËN  C8 (2002>) 95 CITROËN  Dispatch (2004>2006) 103 Jumpy (2004>2006) 104 FIAT  Ulysse (2002>) 124 FIAT  Scudo (2004>2006) 128 LANCIA  Phedra (2002>) 179 PEUGEOT  807 (2002>) 268 PEUGEOT  Expert I (2004>2006) 270
598556	23043 668	0	CHRYSLER  300M (98>2003) 88 Neon (93>) 89 Vision (92>98) 89 Voyager III (96>2001) 90 Grand Voyager (96>2001) 90
598557	23934 795	0	RENAULT  Mégane II (2002>) 289
598558	23930 794	0	RENAULT  Mégane II (2002>) 289 Scenic II (2003>) 292 Grand Scenic II (2003>) 293 RENAULT  Kangoo (97>2003) 295 Kangoo (2003>) 296
598563	23200 688	0	FORD  Fiesta (99>2002) 132 Ka (96>2008) 136 FORD  Courier Courier (96>2002) 142
598564	23202 689	0	FORD  Fiesta (99>2002) 132 Fiesta (2002>2005) 132 Fiesta (2005>2008) 133 Fusion (2002>2005) 135 Fusion (2005>) 135 Ka (96>2008) 136 Puma (97>2001) 139 StreetKa (2002>2005) 142 MAZDA  2 (2003>2008) 188

Valeo	WVA 		
598565	23269 697	2	FORD  Galaxy (2000>2006) 135 SEAT  Alhambra (2000>2003) 306 Alhambra (2003>2010) 306 VOLKSWAGEN  Sharan (2000>2003) 378 Sharan (2003>2010) 378 VOLKSWAGEN  Transporter (F7D) (96>2003) 383
598566	23659 757	0	RENAULT  Laguna II (2001>2005) 286 Laguna II (2005>2007) 286
598568	23918 790	1	CITROËN  Jumper (2002>2006) 103 Relay (2002>2006) 104 FIAT  Ducato (94>2001) 126 Ducato (2002>2006) 127 Ducato RU (2008>) 127 PEUGEOT  Boxer I (2002>2006) 269
598569	23919 790	1	CITROËN  Jumper (2002>2006) 103 Relay (2002>2006) 104 FIAT  Ducato (94>2001) 126 Ducato (2002>2006) 127 Ducato RU (2008>) 128 PEUGEOT  Boxer I (2002>2006) 269
598570	23921 791	0	CITROËN  Jumper (2002>2006) 103 Relay (2002>2006) 104 FIAT  Ducato RU (2008>) 128 PEUGEOT  Boxer I (2002>2006) 269
598574	21727 629	2	HYUNDAI  Coupe (95>2001) 157 Elantra (95>2000) 158 Elantra (2000>2007) 158 Lantra (95>2000) 160 Matrix (2001>2008) 160 Sonata (88>93) 161 Sonata (93>98) 161 Sonata (98>2001) 161 Sonica (98>2001) 161 KIA  Joice (99>) 172 Magentis (2001>2005) 172
598575	23238 692	2	HYUNDAI  Amica (2000>2001) 156 Atos/Atoz (98>2001) 157 Atos (2004>) 157 Atos Prime (99>2001) 157 Atos Prime (2004>) 157



Valeo	VVA	Valeo	
598577	23521 737	2	TOYOTA Celica (99>2005) 334 Corolla (120) (2001>2007) 336 Corolla Verso (2001>2003) 336 Prius (2000>2003) 338 Prius (2003>2009) 338 Yaris Made in Japan (99>2005) .. 339 Yaris Made in France (2001>2005) 340 Yaris Verso (99>) 340
598579	23294 701	0	TOYOTA Celica (93>99) 334 Corolla (110) (97>99) 335 Corolla (110) (99>2001) 335
598580	21487 601	0	BMW X3 (2003>2006) 73 X3 (2006>) 74 X5 (2000>2006) 74 BMW Series 3 (E46) (98>2006) 78 Series 7 (E38) (94>2001) 83 M3 (E46) (2000>2006) 84 M5 (E39) (99>2003) 85 Z4 (E85/86) (2002>2009) 86 Z8 (E52) (2000>2003) 87 LAND ROVER Range Rover (2002>) 184
598581	21606 614	0	ALFA ROMEO 156 (97>2003) 48 164 (92>98) 49 166 (98>2003) 49 166 (2003>2007) 49 LANCIA Kappa (94>2001) 178
598582	23070 671	0	MERCEDES Vaneo (2001>) 214
598583	23138 680	0	MERCEDES Class A (W168) (97>2004) 199 Class A (W169) (2004>2008) 199 Class A (W169) (2008>) 199 Class B (W245) (2005>2008) 199 Class B (W245) (2008>) 200 Vaneo (2001>) 214



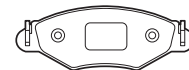













Valeo	VVA	Valeo	
598584	23417 720	2	OPEL Astra G (98>2005) 244 Astra H (2004>) 244 Meriva (2003>) 248 Meriva (2010>) 249 Zafira A (98>2003) 254 Zafira A (2003>2005) 254 Zafira B (2005>2008) 255 Zafira B (2008>) 255 OPEL Combo/Combo Tour (2001>) 256 VAUXHALL Astra MK III (91>2001) 344 Astra MK IV (98>2005) 344 Astra MK V (2004>) 345 Meriva (2003>) 349 Meriva (2010>) 350 Zafira I (99>2003) 353 Zafira I (2003>2005) 353 Zafira II (2005>2009) 353 Zafira II (2009>) 354 VAUXHALL Combo (2001>) 354
598585	21049 559	2 (D)	IVECO Daily (96>99) 165
598586	29139 881	2	IVECO Daily (96>99) 165
598588	598588 895	0	MITSUBISHI Canter 229
598589	23501 734	2(A)+2(B)	MITSUBISHI Canter 229
598590	23501 734	4 (B)	MITSUBISHI Canter 229
598591	20655 526	4	CITROËN C32 (73>79) 102 C35 (73>91) 102
598592	20573 520	2	TALBOT Horizon (78>86) 327 Rancho (77>86) 327
598593	20366 513	2	PEUGEOT J7 (65>80) 271 J9 (80>91) 271
598594	20366 513	2	PEUGEOT J9 (80>91) 271
598595	21820 640	0	RENAULT Cherokee 274 Jeep 274
598596	21049 559	2 (A)	IVECO Daily (78>89) 164 Daily (89>96) 165
598597	20512 519	2	MITSUBISHI L200 (K1/2/3) (86>2001) 218 Pajero (L0/1) (83>91) 219 Shogun (L0/1) (83>91) 220 MITSUBISHI L300 (P0/1/2/3) 229
598598	29037 879	2	IVECO Daily (89>96) 165 Daily (96>99) 165



















Valeo	VVA	Valeo	
598599	21574 610	2	RENAULT Laguna I (94>98) 284
598600	21815 639	0	CHRYSLER Le Baron (81>96) 89 Neon (93>) 89 Saratoga (88>90) 89 Voyager II (91>95) 90 Grand Voyager (92>95) 90
598601	21153 569	431821 0 0 0 0 431826	MERCEDES 190 (201) (82>93) 196 200/300 (W124) (84>93) 197 Class CLK (W208) (97>2003) 203 Class E (W124) (93>98) 205 Class E (W210) (95>2003) 206 Class SL (129) (89>2001) 211
598602	21481 599	0	FORD Maverick (93>98) 129 NISSAN Pathfinder (D21) (86>98) 230 Terrano (R20) (93>2004) 231 Terrano (R20) (2004>2006) 231 NISSAN Serena (C23M) (92>2001) 238 NISSAN Vanette (C23M) (92>2001) 241
*598603	20647 525	0	AUTOBIANCHI A111 (69>74) 72 A112 (69>85) 72 Primula (65>71) 73 FSO POLSKI 125 (71>92) 144 Caro (91>99) 145 Polonez (78>92) 145 FSO POLSKI Truck (92>) 145 SEAT Malaga (85>93) 312 Panda (80>86) 312 YUGO/ZASTAVA 101 394 124 394 132 394 1100 394 1300 394 Yugo 394
598605	21930 656	0	FIAT Punto II (99>2003) 119 Punto II (2003>) 119 LANCIA Y Ipsilon (2000>2003) 181
598606	23348 711	2	TOYOTA Yaris Made in Japan (99>2005) .. 339
598607	21930 656	0	FIAT Punto II (99>2003) 119
*598612	20760 536	0	MAZDA 323 (BD) (80>85) 190

Valeo	VVA	Valeo	
598613	20784 538	0	MERCEDES Class G (M460) (79>89) 195 Class G (M461/3) (89>) 195 MERCEDES Transporter 207-410 (77>96) ... 215 PEUGEOT P4 (86>) 271 VOLKSWAGEN LT I (75>96) 380
598614	20729 533	0	TOYOTA Hilux (78>84) 328 Hilux (83>98) 328 TOYOTA Dyna (84>87) 340 Dyna 200 (88>95) 340 Hiace (77>83) 340
598615	20880 543	0	ISUZU Trooper (81>97) 164
598616	21273 580	2	VOLVO XC 70 (97>99) 384 VOLVO 850 (91>96) 388 C70 (97>2005) 391 S70 (96>2000) 391 V70 (96>2000) 392
598617	21305 584	0	MERCEDES 200/300 (W124) (84>93) 199 Class C (W202) (93>2001) 200 Class C (W203) (2000>2003) 201 Class C (W203) (2004>) 202 Class CLK (W208) (97>2003) 203 Class CLK (W209) (2002>2009) .. 204 Class E (W124) (93>98) 206 Class E (W210) (95>2003) 207 Class S (W140) (91>93) 209 Class S (W140) (93>99) 209 Class S (W220) (98>2004) 210 Class SL (129) (89>2001) 211 Class SLK (170) (96>2003) 213 Class SLK (171) (2008>) 213
598618	21347 587	2	NISSAN D21 Pick-up (85>98) 230 D22 King Cab (98>) 230 Terrano (WD21) (87>95) 231 NISSAN Cedric (Y30) (83>88) 235 NISSAN Urvan (E24) (87>97) 241 Vanette (GC22) (86>93) 241
598619	21910 652	0	FORD Escort (90>94) 131 Mondeo (93>96) 137 Scorpio (94>98) 139
598620	21373 592	0	MITSUBISHI Pajero (L0/1) (83>91) 219 Shogun (L0/1) (83>91) 220 MITSUBISHI Galant (80>84) 223 MITSUBISHI L300 (L030) 229



Valeo	WVA 		
598621	21385 594	0	VOLVO  XC 70 (97>99) 384 VOLVO  760 (82>90) 388 780 (85>91) 388 960 (90>97) 389 S70 (96>2000) 392 V70 (96>2000) 392 S90 (96>98) 393 V90 (96>98) 394
598622	21479 599	0	VOLKSWAGEN  Transporter (F70) (90>96) 382 Transporter (F7D) (96>2003) 382
598623	21519 605	0	LAND ROVER  Defender (90>2007) 181 Land 110 183
598624	20031 500	0	DAIHATSU  Applause (89>) 108 MAZDA  323 (BG) (89>94) 190 626 (GE) (91>97) 192 MX5 (90>98) 193 SUZUKI  Baleno (95>) 323
598625	21647 618	0	GALLOPER  Santamo (98>) 145 HYUNDAI  Santamo (98>2001) 156 MITSUBISHI  Space Runner (91>) 221 MITSUBISHI  Colt (88>92) 223 Colt (91>96) 223 Galant (87>92) 224 Galant (92>96) 224 Galant (96>2003) 225 Lancer (CB/CD4) (92>) 225 Lancer F (C6/7) (88>95) 226 Lancer F (CB/CD) (91>96) 227 Space Wagon (N3) (91>2000) ... 228 PROTON  300 (96>) 273 400 (93>) 274
598626	21650 618	0	MITSUBISHI  Colt (88>92) 222 Colt (91>96) 223 Galant (87>92) 224 Lancer F (CV) (85>92) 226 Lancer F (C6/7) (88>95) 226 Lancer F (CB/CD) (91>96) 226 PROTON  300 (96>) 273 400 (93>) 273

Valeo	WVA 		
598627	21651 619	0	HONDA  CR-V (97>2002) 145 HONDA  Accord V (93>95) 146 Accord V (95>98) 147 Accord VI (98>2003) 147 Accord Aerodeck (90>93) 147 Accord Aerodeck (93>97) 148 Accord coupe (93>97) 148 Accord coupe (97>2002) 148 Civic V (MA/MB) (95>2001) 149 Civic (EP) (2001>2006) 150 Civic Aerodeck (97>2001) 151 HR-V (98>2005) 152 Integra (97>2001) 152 Legend (90>96) 153 Legend (96>2006) 153 NSX (89>2001) 153 Odyssey (97>) 153 Prelude (91>96) 154 Prelude (96>2001) 154 Shuttle (94>2000) 155 ROVER  600 (93>2000) 300
598628	21657 621	0	NISSAN  100 NX (B13) (90>94) 232 Sunny (N14) (90>95) 239
598629	21754 632	2	FORD  Probe (92>97) 139 MAZDA  323 (BJ) (98>2000) 191 323 (BJ) (2000>2003) 191 626 (GE) (91>97) 192 626 (GF) (97>2002) 192 626 Wagon (GW) (97>99) 192 626 Wagon (GW) (99>2002) 193 MX6 (91>97) 194 Premacy (99>2001) 194 Premacy (2001>2005) 194 Xedos 6 (91>99) 195
598630	21910 652	2	FORD  Mondeo (93>96) 137 Scorpio (92>94) 139
598632	23114 677	0	MG  MG ZT (2001>2005) 216 ROVER  75 (99>2005) 298
598633	23714 763	0	ALFA ROMEO  MiTo (2008>) 53 FIAT  Bravo II (2007>) 113 Multipla (98>2003) 116 Multipla (2004>) 116 Stilo (2001>2003) 121 Stilo (2004>) 122 LANCIA  Delta (2008>) 177
598634	23081 673	2	HYUNDAI  H100 (93>) 163 Jobs (98>) 163

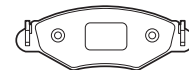

Valeo		VVA					
598635	23587 747	1	AUDI	A1 (2010>) 59			
			A3 (2003>2008) 60				
			A3 (2008>) 60				
			A3 Cabriolet (2008>) 61				
			S3 (98>2003) 69				
			TT (2006>) 72				
			SEAT	Altea (2004>) 306			
			Ibiza (2008>) 311				
			Leon (2005>) 311				
			Toledo (2004>) 313				
SKODA	Yeti (2009>) 313						
SKODA	Octavia (2004>2008) 316						
Octavia (2008>) 316							
Superb (2008>) 317							
VOLKSWAGEN	Eos (2006>) 360						
Golf V (2003>) 367							
Golf VI (2008>) 368							
Golf Plus (2005>) 368							
Golf Plus (2009>) 369							
Jetta III (2005>) 369							
Passat VII (2005>) 373							
Passat CC (2008>) 373							
Polo IX (2009>) 377							
Scirocco (2008>) 377							
Touran I (2003>2006) 378							
Touran II (2006>2010) 378							
Touran III (2010>) 379							
VOLKSWAGEN	Caddy III (2004>) 380						
598636	21670 622	431828	CHRYSLER	Crossfire (2003>) 89			
			MERCEDES	Class CLK (W208) (97>2003) 203			
			Class E (W210) (95>2003) 206				
			Class E (W211) (2002>2006) 207				
			Class E (W211) (2006>2009) 207				
			Class S (W220) (98>2004) 210				
			Class SLK (170) (96>2003) 212				
			598637	23334 708	0	MERCEDES	Class CL (W216) (2006>) 203
						Class CLS (W219) (2004>2008) .. 204	
						Class CLS (W219) (2008>) 205	
Class E (W211) (2002>2006) 207							
Class E (W211) (2006>2009) 208							
Class E (207-212) (2009>) 208							
Class S (W220) (98>2004) 210							
Class S (W221) (2004>) 211							
Class SL (230) (2001>2008) 212							
Class SL (230) (2008>) 212							
598638	23743 770	2	MERCEDES	Class E (W211) (2002>2006) 207			
			Class E (W211) (2006>2009) 207				

Valeo		VVA		
598639	23440 724	0	FORD	Fiesta (2002>2005) 132
			Fiesta (2005>2008) 133	
			Focus (2001>2004) 133	
			FORD	Tourneo Connect (2002>2006) .. 142
			Tourneo Connect (2006>) 142	
598640	23794 777	0	BMW	X1 (2009>) 73
			BMW	Series 3 (E90/91/92/93) (2005>) .. 78
			Series 3 (E90/91/93) (2007>) 79	
			Series 5 (E60/61) (2003>) 81	
			Z4 (E89) (2009>) 87	
598641	23973 801	0	DACIA	Duster (2010>) 105
			Logan (2004>) 106	
			NISSAN	Micra (K12E) (2003>2005) 236
			Micra (K12E) (2005>) 236	
			Note (E11E) (2005>2007) 236	
Renault (E11E) (2008>) 236				
598642	23454 727	0	RENAULT	Clio III (2005>) 281
			Clio III (2009>) 281	
			Modus (2004>2008) 291	
			Modus (2008>) 291	
			RENAULT	Kangoo (2007>) 296
598643	23716 764	0	NISSAN	Micra (K11E) (92>2000) 236
			Micra (K11E) (2000>2002) 236	
598644	23974 801	0	MINI	MINI (R50/52/53) (2001>) 217
			CHEVROLET	Aveo (2005>2008) 87
598645	21539 607	2	CHEVROLET	Kalos (2005>) 88
			DAEWOO	Kalos (2002>) 107
598646	21755 633	2	MAZDA	323 (BG) (89>94) 190
			323 (BA) (94>98) 191	
			MX3 (91>98) 193	
598647	24046 812	2	MAZDA	6 (2002>2007) 189
			323 (BJ) (2000>2003) 191	
			626 Wagon (GW) (97>99) 192	
			626 Wagon (GW) (99>2002) 193	
			Premacy (2001>2005) 194	
598648	24046 812	2	MAZDA	6 (2002>2007) 189



Valeo	VVA	Valeo	
598649	23723 767	0	FORD Focus (2004>) 133 Focus II (2007>) 134 Focus C-Max (2003>2007) 134 Focus C-Max (2007>) 134 Focus Coupé Cabriolet (2006>) ... 135 Kuga (2008>) 137 MAZDA 3 (2003>2006) 188 3 (2006>) 188 3 (2008>) 189 5 (2005>) 189 VOLVO C30 (2006>) 389 S40 (2004>) 389 V50 (2004>) 390 C70 CC (2006>) 391
598650	23446 725	2	SEAT Alhambra (2000>2003) 306 Alhambra (2003>2010) 306 VOLKSWAGEN Sharan (2000>2003) 378 Sharan (2003>2010) 378 VOLKSWAGEN Transporter (F7D) (96>2003) 383
598651	23746 771	1	VOLKSWAGEN Transporter (7J/7H) (2003>2009) . 383 Transporter (7E/7F) (2009>) 383
598652	23746 771	1	VOLKSWAGEN Transporter (7J/7H) (2003>2009) . 383
598653	23996 804	2	TOYOTA Avensis (2000>2003) 331
598654	24092 817	2	KIA Sorento (2002>2006) 170 Sorento (2006>) 170
598655	23692 759	0	PORSCHE Cayenne (2003>) 272 VOLKSWAGEN Touareg I (2002>2006) 356
598656	23693 760	0	AUDI Q7 (2006>) 55 PORSCHE Cayenne (2003>) 272 VOLKSWAGEN Touareg II (2006>2010) 357
598657	24141 825	0	VOLVO XC 90 (2002>) 384
598658	23399 716	0	LAND ROVER Range Rover (2002>) 184

Valeo	VVA	Valeo	
598659	23745 770	0	MERCEDES Class C (W203) (2000>2003) 201 Class C (W203) (2004>) 201 Class CLK (W209) (2002>2009) ... 204 Class CLS (W219) (2004>2008) ... 204 Class CLS (W219) (2008>) 205 Class E (W211) (2002>2006) 207 Class E (W211) (2006>2009) 208 Class S (W220) (98>2004) 210 Class SL (230) (2001>2008) 212 Class SL (230) (2008>) 212 Class SLK (171) (2004>2007) ... 213 Class SLK (171) (2008>) 213
598660	21170 571	1	LADA Vega 175
598661	23250 695	2	OPEL Frontera B (98>2005) 242 VAUXHALL Frontera B (98>2005) 342
598662	24134 822	2	PEUGEOT 407 (2004>) 266
598663	24133 821	2	CITROËN C5 (2008>) 95 C6 (2005>) 95 PEUGEOT 407 (2004>) 266 607 (2004>) 268
598664	24135 823	0	CITROËN C5 (2008>) 95 PEUGEOT 407 (2004>) 266 607 (2004>) 268
598665	23768 775	2	TOYOTA Avensis (2003>2008) 332 Corolla Verso (2004>2009) 336
598666	21333 585	2	SUBARU Justy (95>2003) 321 SUZUKI Alto (94>2002) 323 Cappuccino (91>98) 323 Swift Made in Japan (83>89) ... 324 Swift Made in Japan (89>96) ... 324 Swift Made in Hungary (95>96) .. 324 Swift Made in Hungary (96>2005) 325
598667	23581 745	0	SEAT Cordoba (2002>) 308 Ibiza (2001>) 310 SKODA Fabia (99>2004) 314 Fabia (2004>2007) 314 Fabia (2006>) 315 Roomster (2006>) 317 VOLKSWAGEN Polo VII (2001>) 376 Polo VIII (2005>) 376
598668	21715 626	2	NISSAN 100 NX (B13) (90>94) 232 Almera (N15) (95>2000) 233 Maxima QX (A32) (88>94) 236 Maxima QX (CA33) (2000>2006) . 236 Sunny (N14) (90>95) 239

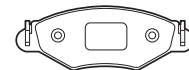

Valeo	WVA	Valeo				
598669	23099 676	0	RENAULT Avantime (2001>2003) 279			
598670	23705 762	2	FIAT Linea (2007>) 115			
			LANCIA Musa (2004>2007) 178			
598671	23326 706	1	VOLKSWAGEN Transporter (7J/7H) (2003>2009) . 383 Transporter (7E/7F) (2009>) 383			
598672	23871 784	2	NISSAN Murano (Z50) (2005>) 230			
			X-Trail (T30) (2001>2003) 232			
			X-Trail (T30) (2003>2007) 232			
598673	23656 756	2	TOYOTA RAV4 (94>2000) 330			
			RAV4 (2000>2005) 330			
598674	20960 553	1 (E)	SEAT Ibiza (2001>) 310			
			SKODA Fabia (99>2004) 314			
			VOLKSWAGEN Polo VII (2001>) 376			
598675	21883 648	0	VOLKSWAGEN Transporter (F7D) (96>2003) 382			
598676	21883 648	1 (A)	VOLKSWAGEN Transporter (F7D) (96>2003) 383			
598677	23339 709	0	JEEP Grand Cherokee (2000>2003) 169			
			Grand Cherokee (2003>2005) 169			
598678	23402 718	0	CADILLAC BLS (2005>) 87			
			FIAT Croma II (2005>2007) 115 Croma II (2007>) 115			
			OPEL Astra H (2004>) 244 Signum A (2003>2005) 251 Signum B (2005>2008) 251 Vectra C (2002>2005) 253 Vectra C (2005>2009) 254 Zafira B (2005>2008) 255 Zafira B (2008>) 255			
			SAAB 9-3 (2002>) 302			
			VAUXHALL Astra MK V (2004>) 345 Signum A (2003>2005) 351 Signum B (2005>2008) 351 Vectra (2002>2005) 352 Vectra (2005>2009) 352 Zafira II (2005>2009) 353 Zafira II (2009>) 354			
			TOYOTA Corolla (120) (2001>2007) 336			
			TOYOTA Corolla (120) (2001>2007) 336			

Valeo	WVA	Valeo	
598681	20960 553	1 (A+D)	FORD Galaxy (2000>2006) 135 Mondeo (2000>2003) 137
			SEAT Alhambra (2000>2003) 306
			VOLKSWAGEN Sharan (2000>2003) 378 Sharan (2003>2010) 378
			HONDA CR-V (2002>2006) 145
			HONDA Accord IV (89>93) 146 Accord V (93>95) 146 Accord V (95>98) 147 Accord VII (2003>2008) 147 Accord Aerodeck (90>93) 147 Accord Aerodeck (93>97) 148 Accord coupe (91>93) 148 Accord coupe (93>97) 148 Accord coupe (97>2002) 148 Civic V (MA/MB) (95>2001) 149 Civic (EP) (2001>2006) 150 Civic (FK/FD) (2006>) 151 Civic Aerodeck (97>2001) 151 Integra (97>2001) 152 Legend (90>96) 153 Legend (96>2006) 153 Odyssey (97>) 154 Prelude (96>2001) 154 S2000 (99>2004) 155 S2000 (2004>2009) 155 Shuttle (94>2000) 155 Stream (2001>2005) 155
598682	21719 627	2	MG MG ZR (2001>2005) 216 MG ZS (2001>2005) 216
			ROVER 600 (93>2000) 300
			SUBARU Impreza (93>2000) 319 Legacy (89>94) 321 Legacy (94>98) 321
*598691	21495 602	2	VOLVO 740 (84>92) 387 940 (90>98) 388 960 (90>97) 389 S90 (96>98) 393 V90 (96>98) 394
*598695	20164 504		
598696	24072 813	0	FIAT Panda (2003>) 118
598697	23400 717	2	SUZUKI Baleno (95>) 323
598698	23708 762	0	FIAT Idea (2003>2007) 115
			FIAT Doblo II (2006>) 125
			LANCIA Musa (2004>2007) 178



Valeo	VVA	Valeo	
598699	23915 789	0	BMW Series 1 (E87) (2004>) 75 Series 1 (E81/82/88) (2007>) 75 Series 3 (E90/91/92/93) (2005>) .. 78 MINI MINI (R56/57) (2006>) 217 MINI (R56/57) (2009>) 217 MINI Clubman (2007>) 217 MINI Clubman (2009>) 218
598700	23935 795	0	BMW Series 1 (E87) (2004>) 75 Series 3 (E90/91/92/93) (2005>) .. 78
598701	23623 753	0	BMW Series 1 (E87) (2004>) 75 Series 1 (E81/82/88) (2007>) 76 Series 3 (E90/91/92/93) (2005>) .. 79 Series 3 (E90/91/93) (2007>) 79
598702	24150 827	0	CITROËN C4 (2004>) 94 PEUGEOT 207 (2006>) 261 307 (2001>2005) 263 307 (2005>) 263
598703	23926 794	0	BMW X1 (2009>) 73 BMW Series 1 (E87) (2004>) 75 Series 1 (E81/82/88) (2007>) 76 Series 3 (E90/91/92/93) (2005>) .. 79 Series 3 (E90/91/93) (2007>) 79
598704	24077 815	0	MERCEDES Class A (W169) (2004>2008) 199 Class A (W169) (2008>) 199 Class B (W245) (2005>2008) 199 Class B (W245) (2008>) 200
598705	24218 828	2	KIA Cerato (2004>) 171
598706	24276 833	2	HYUNDAI i10 (2007>) 159 KIA Picanto (2004>2007) 172 Picanto (2007>) 172
598707	24275 832	2	HYUNDAI i10 (2007>) 159 KIA Picanto (2004>2007) 172 Picanto (2007>) 172
598708	24277 833	2	HYUNDAI Amica (2000>2001) 156 Amica (2001>2003) 157 Atos/Atoz (98>2001) 157 Atos (2001>2004) 157 Atos Prime (99>2001) 157 Atos Prime (2001>2004) 157
598709	23961 798		PORSCHE Cayenne (2003>) 272
598710	23759 772		TOYOTA Previa (2000>) 338

Valeo	VVA	Valeo	
598712	21484 600	1	AUDI A8 (94>2002) 66 RS4 Quattro (2000>2001) 69 TT (98>2006) 72 BMW Series 7 (E38) (94>2001) 83 Z8 (E52) (2000>2003) 87 MERCEDES Class C (W202) (93>2001) 200 Class CLK (W208) (97>2003) 203 Class E (W210) (95>2003) 206 Class E (W211) (2002>2006) 207 Class S (W220) (98>2004) 210 Class SLK (170) (96>2003) 212 VOLKSWAGEN Golf IV (97>2006) 367 Passat VI (2000>2005) 373
598714	20989 555	4	CITROËN AX (91>98) 92 ZX (91>98) 101
598715	23589 748	0	CITROËN C4 (2004>) 93 PEUGEOT 207 (2006>) 261 307 (2001>2005) 263 307 (2005>) 263 308 (2007>) 264 3008 (2009>) 264 RCZ (2010>) 269
598718	23959 797	0	CITROËN C1 (2005>) 92 PEUGEOT 107 (2005>) 258 TOYOTA Aygo (2005>) 332
598719	23157 682		MERCEDES Class ML (163) (97>2005) 196
598720	23581 745	1	SEAT Ibiza (2001>) 310 SKODA Fabia (99>2004) 314 Fabia (2004>2007) 314 Fabia (2006>) 315 Roomster (2006>) 317 VOLKSWAGEN Polo VII (2001>) 376 Polo VIII (2005>) 376
598721	23349 712	1	ABARTH 500 Nuova (2008>) 44 FIAT Grande Punto (2005>) 120
598722	24349 844	0	ABARTH Grande Punto (2007>) 44 FIAT Grande Punto (2005>) 120 OPEL Corsa D (2006>) 247 VAUXHALL Corsa MK III (2006>) 349

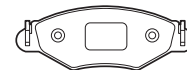

Valeo	WVA	Valeo	
598726	21980 663	1	NISSAN Kubistar (2003>) 240 RENAULT Kangoo (97>2003) 295 Kangoo (2003>) 296
598727	24348 843	0	FIAT Croma II (2005>2007) 115 Croma II (2007>) 115
598728	23922 792	0	MERCEDES Class GL (164) (2006>) 195 Class ML (164) (2005>2008) 196 Class ML (164) (2008>) 196 MERCEDES Class E (W211) (2006>2009) 208 Class R (W251) (2005>) 208
598729	23587 747	2	ALFA ROMEO 159 (2005>) 48 Brera (2006>) 50 Spider II (2006>) 54
598730	24240 829	1	NISSAN Pathfinder (R51M) (2005>) 230
598733	23507 735	1	DAIHATSU Copen (2003>2006) 109 Copen (2006>) 109 Sirion II (2005>) 110 YRV (2000>) 111 NISSAN Pixo (2009>) 237 SUZUKI Alto (2009>) 323 Ignis (2000>2003) 324 SUZUKI Carry (GA4*) 325
598734	23395 715	1	AUDI A2 (2000>2005) 59
598735	23395 715	0	VOLKSWAGEN Lupo (98>2005) 370
598736	23340 710	2	TOYOTA Yaris Made in France (2001>2005) 340
598737	23510 735	2	TOYOTA Celica (99>2005) 334 MR 2 (99>2005) 337 Prius (2000>2003) 338 Yaris Made in Japan (99>2005) .. 339 Yaris Made in France (2001>2005) 340 Yaris Verso (99>) 340
598738	29738 886	1	INFINITI FX (2008>) 163 NISSAN Murano (Z50) (2005>) 230 Navara (D40M) (2005>) 230 Pathfinder (R51M) (2005>) 230 RENAULT Koleos (2008>) 274
598739	24369 848	2	HYUNDAI Elantra (2000>2007) 158
598740	24260 831	0	FORD Mondeo (2003>2005) 138 Mondeo (2005>2007) 138

Valeo	WVA	Valeo	
598741	24191 828		LAND ROVER Discovery (2004>) 183 Range Rover Sport (2005>) 184
598742	24192 828		LAND ROVER Discovery (2004>) 183 Range Rover Sport (2005>) 184
598744	23891 788	2	HYUNDAI Tucson (2004>) 156 HYUNDAI Coupe (2002>2006) 157 Sonata (2001>2005) 161 Sonata (2005>) 161 Tiburon (2002>) 162 KIA Sportage (2004>) 170 KIA Magentis (2006>) 172
598745	24297 836	2	MAZDA MX5 (2000>2005) 194 MX5 (2005>) 194
598746	24298 837	1	MAZDA MX5 (2005>) 194
598747	29747 887	1	NISSAN Almera (N16E) (2003>2006) 234
598748	23543 741	2	HYUNDAI Santa Fé (2000>2006) 155 Tucson (2004>) 156 HYUNDAI Getz (2002>2005) 158 Getz (2005>) 159 Grandeur Azera (2005>) 159 Matrix (2001>2008) 160 Matrix (2008>) 160 Sonata (98>2001) 161 Sonata (2001>2005) 161 Sonata (2005>) 161 Sonica (98>2001) 161 Trajet (2000>2004) 162 Trajet (2004>) 162 XG (99>2002) 162 XG (2002>) 162 HYUNDAI Highway Van (2000>2004) 163 KIA Sportage (2004>) 170 KIA Magentis (2001>2005) 172 Magentis (2006>) 172 SSANGYONG Rodius (2005>) 319
598750	23762 774	2	AUDI A6 (2001>2005) 65 A6 Allroad (2000>2005) 66



Valeo	VVA	Valeo	
598751	20676 530	2 (A)	AUDI A4 (2004>2008) 62 A4 Cabriolet (2002>2005) 63 A4 Cabriolet II (2006>2009) 63 A6 (2001>2005) 64 A6 (2004>2008) 65 SKODA Superb (2001>2008) 317 VOLKSWAGEN Passat V (96>2000) 373 Passat VI (2000>2005) 373
598752	23914 788	0	AUDI A3 (2003>2008) 60 A3 (2008>) 61 A3 Cabriolet (2008>) 61 A4 (2004>2008) 63 A4 Cabriolet II (2006>2009) 63 A6 (2004>2008) 65 A6 (2008>) 65 A6 Allroad (2006>2008) 66 A6 Allroad (2008>) 66 S3 (98>2003) 69 S3 (2006>) 69 TT (2006>) 72 TT RS (2009>) 72 SEAT Alhambra (2010>) 306 Altea (2004>) 307 Exeo (2008>) 309 Leon (2005>) 312 SKODA Yeti (2009>) 314 SKODA Octavia (2004>2008) 316 Octavia (2008>) 317 Superb (2008>) 317 VOLKSWAGEN Eos (2006>) 360 Golf V (2003>) 368 Golf VI (2008>) 368 Golf Plus (2009>) 369 Jetta III (2005>) 370 Passat VII (2005>) 373 Passat CC (2008>) 374 Scirocco (2008>) 377 Sharan (2010>) 378 Touran I (2003>2006) 378 Touran II (2006>2010) 378 VOLKSWAGEN Caddy III (2004>) 380



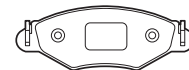



















Valeo	VVA	Valeo	
598753	21934 657		BMW Series 3 (E36) (90>2001) 77 431827 Series 3 (E46) (98>2006) 77 431827 Z1 (E30) (89>92) 86 431827 Z4 (E85/86) (2002>2009) 86 MG 431827 MG ZT (2001>2005) 217 ROVER 75 (99>2005) 298 SAAB 431827 9-5 (97>2001) 303 431827 9-5 (2001>2005) 303 431827 9-5 (2005>) 303
598754	21732 630	0	BMW Series 5 (E60/61) (2003>) 82 Series 6 (E63/64) (2003>) 82
598755	24036 811		CHRYSLER Voyager IV (2001>) 90 Voyager V (2004>) 90 Grand Voyager (2001>2004) 90 Grand Voyager (2004>2008) 91 JEEP Cherokee (2004>) 169
598756	23807 780		CHRYSLER Voyager IV (2001>) 90 Voyager V (2004>) 90 Grand Voyager (2001>2004) 90 Grand Voyager (2004>2008) 91
598757	23868 784	2	HONDA CR-V (2002>2006) 145
598758	23527 738	2	HONDA Accord VI (98>2003) 147
598759	23569 743		HYUNDAI Trajet (2000>2004) 162 Trajet (2004>) 162 HYUNDAI Highway Van (2000>2004) 163
598760	21697 625	2 (B)	HONDA Jazz II (J) (2002>2008) 152 Logo (98>2001) 153
598761	27073 877		LANCIA Y Ipsilon (2003>) 181
598762	23471 730		LAND ROVER Defender (90>2007) 182
598763	21900 651	0	MERCEDES Class C (W202) (93>2001) 200
598764	24007 805	2	MERCEDES Viano (2003>) 215 Vito (2003>) 215
598765	24008 805	2	MERCEDES Viano (2003>) 215 Vito (2003>) 216
598766	21937 657	0	PORSCHE Boxster (96>2002) 273 Boxster (2002>2004) 273
598767	23329 707	0	PORSCHE 911 (996) (97>2005) 273 Boxster (96>2002) 273 Boxster (2002>2004) 273 Cayman (2005>) 273























Valeo	VVA		
598768	21792 637	0	PORSCHE 911 (996) (97>2005) 273 Boxster (96>2002) 273 Boxster (2002>2004) 273 Boxster (2004>) 273 Cayman (2005>) 273
598770	23694 761	0	AUDI Q7 (2006>) 55 PORSCHE Cayenne (2003>) 272 VOLKSWAGEN Touareg I (2002>2006) 356 Touareg II (2006>2010) 357
598772	23092 674	2	ALFA ROMEO 147 (2004>) 47 156 (2003>2007) 48 159 (2005>) 48 166 (98>2003) 49 166 (2003>2007) 49 Brera (2006>) 50 Spider II (2006>) 54 LANCIA Kappa (94>2001) 178
598773	29773 887	2	RENAULT Mégane II (2002>) 289
598777	21947 658	0	MITSUBISHI Pajero (2006>) 220 Shogun (2006>) 221 TOYOTA Land Cruiser (BJ70) (84>2001) .. 329 Land Cruiser (BJ80) (90>98) 329 Land Cruiser (KZ/VZ9) (96>2002) . 329 Land Cruiser (KD/GR) (2002>) ... 329 Land Cruiser Prado (2009>) 330
598778	23593 750	2	MITSUBISHI Montero Sport (K9) (98>2009) ... 219 Pajero Sport (K9) (98>2009) 220 MITSUBISHI Challenger (98>) 222
598779	23762 774	2	AUDI A4 (2004>2008) 62 A4 Cabriolet II (2006>2009) 63 A6 (2004>2008) 65 A6 (2008>) 65 A6 Allroad (2006>2008) 66 A6 Allroad (2008>) 66 A8 (2002>2009) 67 S4 (2003>2004) 70 S4 (2004>2008) 70 S4 Cabriolet (2004>2005) 70 S4 Cabriolet II (2006>2009) 70 SEAT Exeo (2008>) 308

Valeo	VVA		
598780	24045 812	0	MAZDA 6 (2002>2007) 189 323 (BJ) (98>2000) 191 323 (BJ) (2000>2003) 191 626 (GD) (87>92) 192 626 (GE) (91>97) 192 626 (GF) (97>2002) 192 626 Wagon (GV) (88>92) 192 626 Wagon (GW) (97>99) 192 626 Wagon (GW) (99>2002) 193 Premacy (2001>2005) 194
598781	24031 811	2	HYUNDAI Elantra (2000>2007) 158 Matrix (2001>2008) 160 Matrix (2008>) 160
598783	24137 824	0	CADILLAC BLS (2005>) 87 CITROËN C5 (2008>) 95 FORD Tourneo Connect (2002>2006) .. 142 Tourneo Connect (2006>) 142 Transit Connect (2002>2006) 144 Transit Connect (2006>) 144 OPEL Signum A (2003>2005) 251 Signum B (2005>2008) 251 Vectra C (2002>2005) 254 Vectra C (2005>2009) 254 RENAULT Laguna II (2001>2005) 286 Laguna II (2005>2007) 286 Laguna III (2007>) 287 VAUXHALL Signum A (2003>2005) 351 Signum B (2005>2008) 351 Vectra (2002>2005) 352 Vectra (2005>2009) 352
598784	23540 740	1	FORD Ranger II (2002>2007) 129 MAZDA B Pick-up (99>) 188 BT50 (2006>) 188
598786	21527 606	2	NISSAN 200 SX (S13) (88>94) 232 Prairie (M11) (88>94) 237 Primera (P10/W10) (90>98) 237
598787	21561 609	2	NISSAN Maxima (J30) (88>94) 235 Maxima QX (A32) (88>94) 236
598788	21497 602	2	HONDA Accord IV (89>93) 146 Accord coupe (91>93) 148 Accord coupe (93>97) 148
598793	20261 508	2 (B)	FIAT Croma II (2005>2007) 115 Croma II (2007>) 115



Valeo	WVA 		
598795	23881 786	2	MERCEDES  Class A (W169) (2004>2008) 199 Class A (W169) (2008>) 199 Class B (W245) (2005>2008) 199 Class B (W245) (2008>) 200
598800	21799 638	2 (A)	CITROËN  Jumper (94>2001) 103 Relay (94>2001) 104 FIAT  Ducato (94>2001) 126 PEUGEOT  Boxer I (94>2001) 269
598801	23034 667	2	FORD  Galaxy (2000>2006) 135 SEAT  Alhambra (2000>2003) 306 VOLKSWAGEN  Sharan (2000>2003) 378 Sharan (2003>2010) 378
598802	23923 793	0	MERCEDES  Class GL (164) (2006>) 195 Class ML (164) (2005>2008) 196 Class ML (164) (2008>) 196 MERCEDES  Class R (W251) (2005>) 208
598803	24087 816	2	HONDA  Civic (FK/FD) (2006>) 150
598804	24391 848	1	FIAT  Sedici (2006>2009) 111 Sedici (2009>) 111 SUZUKI  SX4 (2006>2009) 325 SX4 (2009>) 325
598805	21865 645	1 (A)	SKODA  Fabia (99>2004) 314 Fabia (2006>) 315 VOLKSWAGEN  Lupo (98>2005) 370 Polo VII (2001>) 376 Polo VIII (2005>) 376
598806	23502 734	2	NISSAN  Almera (N15) (95>2000) 233
598807	23176 683	2	VOLKSWAGEN  Transporter (F7D) (96>2003) 382
598808	20224 506	0	CADILLAC  BLS (2005>) 87 OPEL  Signum A (2003>2005) 251 Signum B (2005>2008) 251 Vectra C (2002>2005) 254 Vectra C (2005>2009) 254 SAAB  9-3 (2002>) 302 VAUXHALL  Signum A (2003>2005) 351 Signum B (2005>2008) 351 Vectra (2002>2005) 352 Vectra (2005>2009) 352

Valeo	WVA 		
598809	21961 660	0	TOYOTA  Avenis (97>2000) 331 Avenis (2000>2003) 331 Carina E (92>97) 333 MR 2 (89>99) 337
598810	24013 807	2	TOYOTA  Avenis (97>2000) 331 Avenis (2000>2003) 331 Corolla (110) (99>2001) 336
598811	23183 684	0	BMW  X3 (2003>2006) 73 X3 (2006>) 73 BMW  Series 3 (E46) (98>2006) 77 Z4 (E85/86) (2002>2009) 86 MG  MG ZT (2001>2005) 217
598812	23620 753	2	TOYOTA  Avenis (2003>2008) 332 Corolla Verso (2004>2009) 336
598813	23189 686	1	MERCEDES  Class ML (163) (97>2005) 196
598814	21479 599	1	VOLKSWAGEN  Transporter (F7D) (96>2003) 382
598815	21948 659	2	TOYOTA  Starlet (89>95) 338 Starlet (96>99) 339
598816	29816 888	0	FORD  Transit (2006>) 143
598817	21553 609	2	HYUNDAI  Coupe (95>2001) 157 Coupe (2002>2006) 157 Elantra (95>2000) 158 Elantra (2000>2007) 158 Lantra (95>2000) 160 Tiburon (2002>) 162 KIA  Cerato (2004>) 171 NISSAN  Bluebird (T12) (85>90) 234 Maxima (J30) (88>94) 235
598818	29818 888	0	FORD  Transit (2006>) 143
598819	24338 842	0	TOYOTA  RAV4 (2005>) 330 TOYOTA  Camry (2006>) 333
598820	23730 768	0	BMW  X5 (2006>) 74 X6 (2008>) 74 BMW  Series 5 (E60/61) (2003>) 82 Series 6 (E63/64) (2003>) 82 Series 7 (E65) (2001>2008) 84 Series 7 (E66) (2002>2008) 84 M3 (E90/92/93) (2007>) 85 M5 (E60) (2004>) 85 M5 (E61) (2007>) 86 M6 (E63/64) (2007>) 86

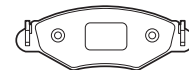

Valeo		VVA			
598821		23649	756	2	KIA Carnival (99>2002) 171 Carnival (2002>2006) 171 Sedona (99>2002) 173 Sedona (2002>) 173
598822		23762	774	0	FORD Focus (2004>) 133 Focus II (2007>) 134 OPEL Vectra C (2005>2009) 254 SAAB 9-3 (2002>) 302 VOLVO S40 (2004>) 390 V50 (2004>) 390 C70 CC (2006>) 391
598823		23993	804	2	KIA Sorento (2002>2006) 170 Sorento (2006>) 170
598824		23719	765	2	HONDA Accord VII (2003>2008) 147
598825		23982	802	1	OPEL Corsa D (2006>) 246 VAUXHALL Corsa MK III (2006>) 348
598826		21734	631	0	NISSAN 100 NX (B13) (90>94) 232 Sunny (B12) (86>90) 239 Sunny (N13) (86>90) 239 Sunny (N14) (90>95) 239
598827		23526	738	0	TOYOTA Celica (99>2005) 334 Corolla (120) (2001>2007) 336 Corolla Verso (2001>2003) 336
598828		21703	626	2	SUBARU Impreza (93>2000) 320 Legacy (89>94) 321 Legacy (94>98) 321 SVX (91>97) 322
598829		24011	806	0	VOLVO XC 90 (2002>) 384
598830		23400	717	4	SUZUKI Baleno (95>) 323
598831		24039	811	1	MAZDA RX8 (2003>) 195 SUZUKI Ignis (2000>2003) 324
598832		23507	735	2	SUZUKI Ignis (2000>2003) 324
598833		24083	815	0	JEEP Grand Cherokee (2000>2003) ... 169 Grand Cherokee (2003>2005) ... 169

Valeo		VVA			
598834		21706	626	2	GALLOPER Santamo (98>) 145 HYUNDAI Santamo (98>2001) 156 MITSUBISHI Pajero Pinin (H7) (99>) 220 Sapporo (76>90) 220 Shogun Pinin (99>) 221 Space Runner (91>) 221 MITSUBISHI 3000 GT (90>2000) 221 Galant (92>96) 224 Galant (96>2003) 225 Galant (2006>) 225 Space Wagon (N3) (91>2000) ... 228
598835		24029	810	2	MAZDA MX5 (90>98) 193 MX5 (98>2000) 194 MX5 (2000>2005) 194
598836		23354	713	2	MAZDA MX5 (90>98) 193 MX5 (98>2000) 193 MX5 (2000>2005) 194
598838		21892	649	2	KIA Sportage (93>2002) 170
598839		23708	762	1	OPEL Corsa D (2006>) 246 VAUXHALL Corsa MK III (2006>) 349
598840		21716	627	2	NISSAN Sunny (Y10) (90>2000) 239
598841		23455	728	2	KIA Carens (99>2002) 171 Carens (2002>2006) 171 Clarus (95>2001) 171 Cremos (97>) 172 Mentor (2001>2004) 172 Sephia (98>2001) 173 Shuma (98>2002) 173 Shuma (2001>2004) 174
598842		23966	799	2	HYUNDAI i30 (2007>) 159 i30 (CZ) (2008>) 159 KIA Carens (2002>2006) 171 Ceed (2006>) 171
598843		23662	758	2	SUZUKI Wagon R (97>) 325
598844		21872	646	2	MITSUBISHI Carisma (95>99) 222 Colt (91>96) 223 Lancer (CB/CD4) (92>) 225 Lancer F (CB/CD) (91>96) 227 PROTON 300 (96>) 273 400 (93>) 274



Valeo	VVA		
598845	23885 787	2	AUDI A8 (2002>2009) 67 S6 (2006>2008) 71 S6 (2008>) 71 S8 (2006>2007) 71 S8 (2007>) 71 VOLKSWAGEN Phaeton (2002>2007) 374 Phaeton (2007>) 374
598846	21558 609	0	FORD Probe (92>97) 139 MAZDA 626 (GD) (87>92) 192 626 Wagon (GV) (88>92) 192 626 Wagon (GV) (92>97) 192
598847	23973 801	1	OPEL Agila (2007>) 242 SUZUKI Splash (2008>) 324 Swift Made in Hungary (2005>) .. 325 VAUXHALL Agila (2007>) 343
598848	23817 781	2	SUZUKI Liana (2001>) 324
598849	24086 816	2	HONDA Civic (FK/FD) (2006>) 151
598850	21952 659	2	DAIHATSU Charade (93>2001) 108 Gran Move (96>) 109 Valera (94>) 110
598851	20098 502	0	NISSAN Patrol GR (Y60) (88>97) 231
598852	24014 808	2	CITROËN C Crossover 91 DODGE Caliber (2006>) 111 MITSUBISHI Outlander (CU) (2003>2008) 219 MITSUBISHI Lancer (CS/CT) (2003>) 227 PEUGEOT 4007 (2007>) 257
598853	23865 783	2	SUBARU Forester (97>2002) 319 Forester (2002>2005) 319 Forester (2005>2007) 319 Impreza (2000>2005) 320 Impreza (2005>2007) 320 Legacy (2003>) 321
598854	23242 693	2	DAEWOO Korando KJ (99>) 106 Musso (99>) 106 SSANGYONG Musso (93>) 318
598855	23879 785	1	MITSUBISHI L200 (K6/7) (96>2007) 218
598856	23497 733	0	DAIHATSU Move (99>2002) 110 Sirion (98>2005) 110 YRV (2000>) 110



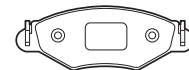





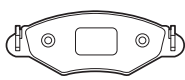













Valeo	VVA		
598857	24024 810	2	TOYOTA Land Cruiser (KD/GR) (2002>) ... 329
598858	23034 667	1	VOLKSWAGEN Transporter (F7D) (96>2003) 382
598859	21381 593	1	LANCIA Delta (86>93) 176 SEAT Leon (99>2006) 311
598860	23832 782	2	OPEL Astra H (2004>) 244 Corsa C (2003>2006) 246 Corsa D (2006>) 247 Meriva (2003>) 248 Meriva (2010>) 249 Zafira B (2005>2008) 255 Zafira B (2008>) 255 OPEL Combo/Combo Tour (2001>) 256 VAUXHALL Astra MK V (2004>) 344 Corsa MK II (2003>2006) 348 Corsa MK III (2006>) 349 Meriva (2003>) 349 Meriva (2010>) 349 Zafira II (2005>2009) 353 Zafira II (2009>) 354 VAUXHALL Combo (2001>) 354
598861	24162 827	0	RENAULT Clio III (2005>) 281 Clio III (2009>) 281 Mégane II (2002>) 289 Mégane III (2008>) 290
598862	23806 780	0	TOYOTA Camry (2001>2006) 333
598863	23801 779	1	AUDI A3 (2003>2008) 60 A3 (2008>) 61 SEAT Leon (2005>) 311 SKODA Superb (2008>) 317 VOLKSWAGEN Eos (2006>) 360 Golf V (2003>) 367 Passat VII (2005>) 373 Passat CC (2008>) 374 Scirocco (2008>) 377
598864	24291 835	2	MITSUBISHI Lancer (CS/CT) (2003>) 227
598865	23539 740	0	LEXUS LX 470 (2002>2007) 185 TOYOTA Land Cruiser (HD/UZ10) (98>2007) 329
598866	23608 751	2	KIA Joice (99>) 172
598867	24320 838	2	HYUNDAI Accent TR (2005>) 156 KIA Ceed (2006>) 171 Rio (2005>2008) 173























Valeo		WVA	Valeo	
598868	24317 838	2	HYUNDAI Accent TR (2005>) 156 i20 (2008>) 159 KIA Rio (2005>2008) 173	
598870	29877 890	2	SSANGYONG Rexton (2002>) 318 Rexton (2004>) 318	
598871	23726 767	2	SSANGYONG Rexton (2002>) 318 Rexton (2004>) 319 Rodius (2005>) 319	
598872	24250 830	2	JEEP Commander (2005>) 169 Grand Cherokee (2005>) 169	
598873	24229 829	2	DAIHATSU Cuore (2003>2005) 109 Trevis (2006>) 110	
598874	24071 812	0	CHEVROLET Lacetti (2005>) 88 Nubira (2005>) 88 DAEWOO Lacetti (2003>2004) 107	
598875	24331 839	2	SUBARU Forester (2005>2007) 319 Impreza (2000>2005) 320 Impreza (2005>2007) 320	
598876	29190 883		MERCEDES Sprinter II (2006>) 215 VOLKSWAGEN Crafter (2006>) 380	
598877	24346 842	2	SUZUKI Grand Vitara (2006>) 323	
598878	24301 837	2	SUZUKI Grand Vitara XL7 (2001>2006) ... 322	
598879	24123 820	0	FORD Galaxy (2006>) 135 Mondeo (2007>) 138 S-Max (2006>) 141 LAND ROVER Freelander 2 (2006>) 183 VOLVO XC 70 (2007>) 384 VOLVO V70 (2007>) 393 S80 (2006>) 393	
598880	21637 617	2	ALFA ROMEO 156 (97>2003) 48 LANCIA Lybra (99>2006) 178	
598881	29200 884		MERCEDES Sprinter II (2006>) 215 VOLKSWAGEN Crafter (2006>) 380	
598882	29192 883		MERCEDES Sprinter II (2006>) 215 Viano (2003>) 215 Vito (2003>) 216 VOLKSWAGEN Crafter (2006>) 380	

Valeo		WVA	Valeo	
598883	23494 732	2	DAIHATSU Cuore (98>2003) 109 Domino (98>2000) 109	
598885	23550 741	0	BMW X1 (2009>) 73 BMW Series 3 (E90/91/92/93) (2005>) .. 79 Series 3 (E90/91/93) (2007>) 79	
598886	23584 746	2	MITSUBISHI Space Runner (91>) 221 MITSUBISHI Galant (96>2003) 225 Galant (2006>) 225 Lancer (GS/CT) (2003>) 227 Lancer (CY) (2007>) 227 Lancer Sportback (CX) (2008>) .. 228	
●598887	23722 766	2	HONDA FR-V (2004>2007) 152 FR-V (2007>2010) 152 Legend (96>2006) 153 Stream (2001>2005) 155	
●598888	24323 839	2	LEXUS GS 300 (2005>) 186 GS 430 (2005>) 186 GS 450 (2006>) 186 IS 220D (2005>) 186 IS 250 (2005>) 186	
●598889	23970 800	2	NISSAN D22 King Cab (98>) 230	
●598890	24350 845	0	TOYOTA Camry (2006>) 333	
●598891	24468 855	1	CITROËN Jumper II (2006>) 103 Relay II (2006>) 104 FIAT Ducato (2006>) 127 PEUGEOT Boxer II (2006>) 270	
●598892	24465 854	0	CITROËN Jumper II (2006>) 103 Relay II (2006>) 105 FIAT Ducato (2006>) 127 PEUGEOT Boxer II (2006>) 270	
●598893	24529 862	2	MITSUBISHI L200 (K84T) (2006>) 219	
●598894	29894 891	2	TOYOTA Hilux (2005>) 329	
●598895	23572 744	1	SUBARU Forester (97>2002) 319 Impreza (2000>2005) 320 Legacy (98>2003) 321 Legacy (2003>) 322	
●598896	24347 843	0	TOYOTA Yaris Made in Japan (2005>) 340	



Valeo	VVA 		
●598897	21785 636	4	TOYOTA  4 Runner (130) (89>95) 328 Hilux (83>98) 328 Hilux (2001>) 328 Land Cruiser (BJ70) (84>2001) .. 329 Land Cruiser (KZ/VZ9) (96>2002) .. 329 VOLKSWAGEN  Taro (89>97) 381
●598898	23347 711	0	BMW  X1 (2009>) 73 BMW  Series 3 (E90/91/92/93) (2005>) .. 79 Series 3 (E90/91/93) (2007>) 79 Z4 (E89) (2009>) 87
●598899	24595 867	1	CITROËN  Dispatch (2007>) 103 Jumpy (2007>) 104 FIAT  Scudo (2007>) 128 PEUGEOT  Expert II (2007>) 270
●598901	29901 892	2	HONDA  CR-V (2006>) 145
●598902	23237 692	0	DAEWOO  Evanda (2002>2005) 106 Leganza (97>2003) 107 Nubira (97>) 107
●598903	21682 624	2	MG  MG F (95>2002) 216 MG TF (2002>2005) 216 ROVER  800 (91>99) 300
●598904	23320 706	4	CHRYSLER  Stratus (94>) 89
●598905	23951 797	0	CHRYSLER  Sebring (2000>2007) 89
●598906	23472 730	2	FORD  Explorer (90>) 129
●598907	29907 893	2	HONDA  Civic (EP) (2001>2006) 150 Civic (FK/FD) (2006>) 151 S2000 (99>2004) 155
●598908	23536 739	2	HYUNDAI  Plaza (98>) 160 Satellite (98>2007) 160 Starex (98>) 162 HYUNDAI  H1 (97>) 162
●598910	23873 785	2	KIA  Carens (99>2002) 171 Mentor (2001>2004) 172 Shuma (2001>2004) 174
●598911	21719 627	2	HONDA  Accord Aerodeck (90>93) 147 Legend (85>90) 153 Prelude (91>96) 154
●598912	23184 685	2	NISSAN  Maxima QX (CA33) (2000>2006) .. 236



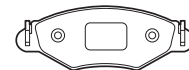















Valeo	VVA 		
●598913	23705 762	0	FIAT  Albea (2002>) 112 Idea (2003>2007) 115 Idea (2007>) 115 Panda (2003>) 118 LANCIA  Musa (2004>2007) 178 Musa (2007>) 178
●598914	21580 612	2	MITSUBISHI  Lancer Evolution (98>) 227 NISSAN  350Z (Z33) (2003>) 233 SUBARU  Impreza (2000>2005) 320 Impreza (2005>2007) 320
●598915	23780 776	2	SUBARU  Impreza (93>2000) 320 Legacy (94>98) 321 Legacy (98>2003) 321
●598916	23381 714	1	SUBARU  Impreza (2000>2005) 320 Impreza (2005>2007) 320
●598917	23510 735	2	TOYOTA  Corolla (120) (2001>2007) 336 Corolla Verso (2001>2003) 336 Prius (2003>2009) 338
598918	23834 783	1	INFINITI  FX (2003>) 163
●598919	23092 674	1	MITSUBISHI  Lancer Evolution (98>) 227 SUBARU  Impreza (2000>2005) 320 Impreza (2005>2007) 320
●598920	24111 818	2	JEEP  Commander (2005>) 169 Grand Cherokee (2005>) 169
●598921	20566 520	0	TOYOTA  4 Runner (60) (84>89) 328 Hilux (78>84) 328 Hilux (83>98) 328 Land Cruiser (BJ40) (80>84) 329 Land Cruiser (BJ60) (80>90) 329 Land Cruiser (BJ70) (84>2001) .. 329
●598924	29924 894	2	JEEP  Wrangler (2006>) 170
●598925	23984 803	2	MINI  MINI (R50/52/53) (2001>) 217 MINI (R56/57) (2006>) 217 MINI (R56/57) (2009>) 217 MINI Clubman (2007>) 217 MINI Clubman (2009>) 218
●598926	23258 695	2 (A)	OPEL  Astra G (98>2005) 244 Zafira A (98>2003) 254 Zafira A (2003>2005) 255 VAUXHALL  Astra MK IV (98>2005) 344 Zafira I (99>2003) 353 Zafira I (2003>2005) 353























Valeo	VVA	Valeo	
●598927	24660 869	0	PEUGEOT 308 (2007>) 264 3008 (2009>) 264
●598928	24496 858	0	FORD Galaxy (2006>) 136 S-Max (2006>) 141 VOLVO XC 60 (2008>) 384 XC 70 (2007>) 384 VOLVO V70 (2007>) 393 S80 (2006>) 393
●598929		2	SUBARU Legacy (2003>) 322
●598932	24464 853	2	HYUNDAI Santa Fé (2006>) 155
●598933	24610 868	2	TOYOTA Auris Made in Japan (2006>) 330 Auris Made in UK (2007>) 331 Auris FL (UKP150) (2010>) 331 Corolla (150) (2006>) 336 IQ (2009>) 337 Urban Cruiser 339 Yaris Made in Japan (2005>) 340
●598934	24501 860	1	KIA Carens (2006>) 171
●598935	24537 863	0	FORD Focus II (2007>) 134 Galaxy (2006>) 136 Kuga (2008>) 137 Mondeo (2007>) 138 S-Max (2006>) 141 LAND ROVER Freelander 2 (2006>) 183
●598936	24540 864	0	CITROËN C4 Picasso (2006>) 94
●598937	24351 846	2	HYUNDAI Santa Fé (2006>) 155
●598939	24462 852	1	CITROËN C6 (2005>) 95
●598940	23467 729	2	VOLKSWAGEN Touareg I (2002>2006) 356 Touareg II (2006>2010) 357
●598941	24498 859	2	CHEVROLET Captiva (2006>) 87 OPEL Antara (2006>) 241 VAUXHALL Antara (2006>) 342
●598942	24510 861	2	CHEVROLET Captiva (2006>) 87 OPEL Antara (2006>) 241 VAUXHALL Antara (2006>) 342
●598943	24336 841	0	TOYOTA Auris Made in Japan (2006>) 330 Corolla (150) (2006>) 336 Urban Cruiser 339

Valeo	VVA	Valeo	
●598944	23703 761	2	LEXUS RX 300 (2000>2003) 185 RX 350 (2006>) 185
●598945	24491 857	1	KIA Carens (2006>) 171
●598946	24367 847	2	VOLKSWAGEN Transporter (7J/7H) (2003>2009) . 383
●598947	21468 597	0	TOYOTA Dyna 100 (85>2001) 340 Hiace (82>89) 341 Hiace (89>95) 341 Hiace (95>) 341
598964		0	MITSUBISHI Colt (88>92) 223 Galant (84>87) 224 Galant (87>92) 224 Lancer F (C6/7) (88>95) 226
598965		0	CHRYSLER Neon (93>) 89 Stratus (94>) 89 Vision (92>98) 90
598966		2	VOLKSWAGEN LT II (96>2003) 380 LT III (2003>2006) 381
598967	24367 847	0	VOLKSWAGEN Touareg I (2002>2006) 356 Touareg II (2006>2010) 357
●598982	21366 590	2	VOLKSWAGEN Golf III (91>99) 362 Vento (91>97) 379
●598983	21759 634	0	TOYOTA MR 2 (84>89) 337 MR 2 (89>99) 337 MR 2 (99>2005) 337
●598984	20076 501	0	TOYOTA Corolla (80) (83>87) 335 Corolla (90) (87>92) 335 Corolla (110) (97>99) 335
●598985	21147 568	2	ALFA ROMEO 155 (91>97) 47 GTV (95>2003) 52 Spider (95>2003) 53 FIAT Coupe (93>2000) 113 Croma (91>96) 114 Tipo (93>95) 123 LANCIA Dedra (89>94) 175 Dedra (94>99) 176 Delta (86>93) 176 Delta (93>99) 177 Kappa (94>2001) 177 Thema (84>88) 180 Thema (88>92) 180 Thema (92>94) 180
●598986	21730 630	4	SUZUKI Swift Made in Japan (89>96) 324



Valeo	WVA 		
●598987	21436 596	1	FIAT  500 Nuova (2007>) 112 FORD  Ka (2008>) 137
●598988	21381 593	2	ALFA ROMEO  147 (2000>2004) 46 156 (97>2003) 48 156 (2003>2007) 48 GTV (95>2003) 52 GTV (2003>2006) 52 Spider (95>2003) 53 Spider (2003>2006) 54 FIAT  Coupe (93>2000) 114
●598989	23266 696	2	KIA  Leo (96>) 172 Mentor (94>2001) 172 Sephia (93>98) 173 Sephia (98>2001) 173 Shuma (98>2002) 173
●598990	21637 617	1	ALFA ROMEO  145 (94>2001) 45 146 (94>2001) 46 147 (2000>2004) 46 147 (2004>) 47 156 (2003>2007) 48 GT (2003>) 51 FIAT  Bravo (95>2002) 113 Marea (96>2002) 116 Punto II (2003>) 119 LANCIA  Lybra (99>2006) 178
●598991	23046 668	1	SUBARU  Justy (95>2003) 321 SUZUKI  Swift Made in Hungary (96>2005) 325
●598992	23118 678	2	AUDI  A4 (99>2001) 62 A6 (97>2001) 64 A6 (2001>2005) 65 A6 Allroad (2000>2005) 66 S4 (99>2001) 69 S6 (99>2001) 71 S6 (2001>2005) 71 VOLKSWAGEN  Phaeton (2002>2007) 374
●598993	23245 694	0	RENAULT  Scenic II (2003>) 292 Grand Scenic II (2003>) 293
●598994	24098 818	0	AUDI  TT RS (2009>) 72 VOLKSWAGEN  Touareg I (2002>2006) 356 Touareg II (2006>2010) 357 Touareg II (2010>) 357



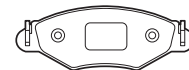





















Valeo	WVA 		
●598995	23960 798	0	MERCEDES  Class CL (W216) (2006>) 203 Class CLS (W219) (2004>2008) ... 204 Class CLS (W219) (2008>) 205 Class E (W211) (2006>2009) 208 Class S (W221) (2004>) 210 Class SL (230) (2001>2008) 212 Class SL (230) (2008>) 212
●598996	24705 872	1	AUDI  A4 (2007>) 63 A5 (2007>) 63 A5 Cabriolet (2009>) 63
●598997	24538 864	0	CITROËN  C4 Picasso (2006>) 94 CITROËN  Berlingo (2008>) 102 PEUGEOT  5008 (2009>) 267 PEUGEOT  Partner (2008>) 271
●598998	24557 865	0	CITROËN  C4 Picasso (2006>) 94 PEUGEOT  5008 (2009>) 267
●598999	24283 834	1	DAIHATSU  Sirion II (2005>) 110 FORD  Fiesta (2008>) 133 MAZDA  2 (2007>) 188
●601000	24820 876	0	RENAULT  Mégane III (2008>) 290 Scenic III (2009>) 293
●601001	23761 773	2	LANCIA  Thesis (2002>) 180
●601002	23502 734	2	NISSAN  Patrol GR (Y61) (97>2004) 231 Patrol GR (Y61) (2004>) 231
●601003	21927 655	0	FIAT  Punto II (99>2003) 119 Punto II (2003>) 119
●601004	23326 706	0	AUDI  A6 (2004>2008) 65 A6 (2008>) 65 A6 Allroad (2006>2008) 66 A6 Allroad (2008>) 66 A8 (2002>2009) 67 RS6 Quattro (2002>2004) 69 S4 (2003>2004) 70 S4 (2004>2008) 70 S4 Cabriolet (2004>2005) 70 S4 Cabriolet II (2006>2009) 70 S6 (2006>2008) 71 S6 (2008>) 71 S8 (2006>2007) 71 VOLKSWAGEN  Transporter (7J/7H) (2003>2009) . 383 Transporter (7E/7F) (2009>) 383



















Valeo	WVA	Valeo	Valeo
●601005	23723 767	0	FORD Focus C-Max (2003>2007) 134 MAZDA 3 (2003>2006) 188 VOLVO S40 (2004>) 390 V50 (2004>) 390
●601006	20676 530	0	SAAB 9-5 (2005>) 303
●601007	24142 826	0	FORD Galaxy (2006>) 136 Mondeo (2007>) 138 S-Max (2006>) 141 VOLVO XC 70 (2007>) 384 VOLVO V70 (2007>) 393 S80 (2006>) 393
●601008	23723 767	0	MAZDA 3 (2006>) 188 3 (2008>) 189 5 (2005>) 189
●601009	24632 868	1	INFINITI EX (2008>) 163 FX (2008>) 163 NISSAN X-Trail (T31) (2007>) 232 NISSAN Cube (2010>) 235 Qashqai (2007>2010) 238 Qashqai (2010>) 238 Tiida (C11X) (2007>) 240 RENAULT Koleos (2008>) 274
●601010	24693 871	0	RENAULT Kangoo (2007>) 296
●601011	24692 870	0	RENAULT Kangoo (2007>) 296
●601012	24535 863	0	RENAULT Clio III (2005>) 281 Clio III (2009>) 281 Laguna III (2007>) 287 Mégane II (2002>) 289 Scenic II (2003>) 292 Twingo III (2007>) 294 Wind (2010>) 294
●601013	24280 833	2	NISSAN Tiida (C11X) (2007>) 239
●601014	24727 874	1	LANCIA Delta (2008>) 177
●601015	24764 875	1	FIAT 500 Nuova (2007>) 112 FORD Ka (2008>) 137
●601016	20576 522	0	SKODA 100-135 314
●601017	24673 870	0	DACIA Logan (2004>) 106
●601018	21655 620	2	MAZDA Demio (98>2003) 193

Valeo	WVA	Valeo	Valeo
●601019	23776 776	2	FIAT Palio (96>2001) 117 Siena (97>2001) 121
●601020	21370 591	2	MITSUBISHI Montero Sport (K9) (98>2009) ... 219 Outlander (CU) (2003>2008) ... 219 Pajero Sport (K9) (98>2009) ... 220 Space Runner (91>) 221 MITSUBISHI Challenger (98>) 222 Lancer Evolution (98>) 227 Space Gear (94>98) 228 Space Wagon (N8) (98>2004) ... 228 MITSUBISHI L400 (PA/PB/PD) 229
●601021	21365 589	0	FIAT Cinquecento (92>98) 113
●601022	23429 722	4	LEXUS GS 300 (93>97) 185 TOYOTA Supra (93>) 339
●601023	21490 601	2	LEXUS GS 300 (93>97) 185 GS 300 (97>2004) 185 GS 430 (2000>2004) 186 IS I (99>2005) 186 IS 300 (99>2005) 186 SC430 (2001>) 187 TOYOTA Supra (93>) 339
●601024	21969 661	0	DAIHATSU Cuore (90>94) 109 Cuore (94>98) 109 Domino (90>94) 109 Domino (94>98) 109 Mira (92>94) 110 Mira (94>98) 110
●601025	23429 722	2	LEXUS GS 300 (97>2004) 186 GS 430 (2000>2004) 186 IS I (99>2005) 186 IS 300 (99>2005) 187 SC430 (2001>) 187
●601026	24022 809	1	TOYOTA Yaris Made in France (2005>) ... 340
●601027	23313 704	0	BMW X1 (2009>) 73 BMW Series 3 (E90/91/92/93) (2005>) .. 78 Series 3 (E90/91/93) (2007>) 79
●601028	24574 866	2	TOYOTA Yaris Made in France (2005>) ... 340
●601029	23760 772	0	ALFA ROMEO 159 (2005>) 48 Brera (2006>) 50 Spider II (2006>) 54 LANCIA Delta (2008>) 177 Thesis (2002>) 180
●601030	23590 749	0	VOLVO XC 90 (2002>) 384



Valeo	WVA 		
●601031	24073 814	1	LANCIA  Y Ipsilon (2003>) 181
●601032	23590 749	8	CHRYSLER  300C (2004>) 88
●601033		8	CHRYSLER  300C (2004>) 88
●601034	23945 796	0	MERCEDES  Class C (W203) (2004>) 201 Class CLC (W203) (2008>) 203 Class SLK (171) (2008>) 213
●601035	23983 802	0	LEXUS  IS 220D (2005>) 186 IS 250 (2005>) 186
●601036	24333 840	1	VOLKSWAGEN  Tiguan (2007>) 356
●601037	24337 841	0	TOYOTA  RAV4 (2005>) 330
●601038	24635 869	2	HONDA  CR-V (2006>) 146
●601039	24578 866	0	CITROËN  Dispatch (2007>) 103 Jumpy (2007>) 104 FIAT  Scudo (2007>) 128 PEUGEOT  Expert II (2007>) 270
●601040	24122 819	0	TOYOTA  Auris Made in Japan (2006>) 330 Auris Made in UK (2007>) 330 Corolla (150) (2006>) 336
●601041	24289 835	0	MINI  MINI (R56/57) (2006>) 217 MINI (R56/57) (2009>) 217 MINI Clubman (2007>) 217 MINI Clubman (2009>) 218
●601042	24765 876	0	CITROËN  Berlingo (2008>) 102 PEUGEOT  308 (2007>) 264 PEUGEOT  Partner (2008>) 271
●601043	23736 769	2	HONDA  CR-V (2002>2006) 145 HONDA  FR-V (2004>2007) 152 FR-V (2007>2010) 152
●601044	23483 731	0	FORD  Focus (2004>) 133 Focus II (2007>) 134 Focus C-Max (2003>2007) 134 MAZDA  5 (2005>) 189 VOLVO  C30 (2006>) 389 S40 (2004>) 390 V50 (2004>) 390 C70 CC (2006>) 391

Valeo	WVA 		
●601045	24914 877	0	DACIA  Duster (2010>) 105 RENAULT  Fluence (2009>) 283 Mégane III (2008>) 290 Scenic III (2009>) 293
●601046	24412 849	2	OPEL  Insignia (2009>) 247 VAUXHALL  Insignia (2009>) 349
●601047	24415 850	2	OPEL  Insignia (2009>) 247 VAUXHALL  Insignia (2009>) 349
●601048	24418 851	2	OPEL  Insignia (2009>) 247 VAUXHALL  Insignia (2009>) 349
●601049	24421 852	4	OPEL  Insignia (2009>) 247 VAUXHALL  Insignia (2009>) 349
●601050	24710 873	0	RENAULT  Mégane III (2008>) 290 Scenic III (2009>) 293
●601051	24253 830	0	MERCEDES  Class GLK (2008>) 195 MERCEDES  Class C (W204) (2007>) 202 Class E (207-212) (2009>) 208
●601052	24708 873	0	TOYOTA  Yaris Made in Japan (2005>) 340



Pads and Discs

Plaquettes et Disques

Pastillas y Discos

Pastillas e Discos

Pastiglie e Dischi

Blokjes en Schijven

Bremsbeläge und Bremsscheiben

Klocki i Tarcze

Balatalari ve Diskleri

Κολοдки и диски

Δισκόφρενα & Δισκόπλακες

刹车片和刹车盘



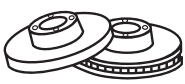



























بطانات و قرص















Valeo								
* 186102	D 076	239x22	899	ALFA ROMEO	33 (83>89) 44	33 (89>94) 44	Alfasud Sprint (79>89) 50	
* 186103	D 077	269x22	899	ALFA ROMEO	75 (85>93) 45	90 (84>88) 45	Giulietta (76>86) 51	GTV (80>87) 51
* 186110	D 081	250x12,7	899	ALFA ROMEO	75 (85>93) 45	Giulietta (76>86) 51		
186112	D 083	256x22	899	AUDI	80 (86>91) 55	90 (87>91) 57	100 (71>82) 57	100 (82>90) 58
186113	D 042	257x12,9	899	AUDI	80 (86>91) 55	90 (87>91) 57	100 (71>82) 57	100 (82>90) 58
186114	D 084	245x9,9	899	AUDI	80 (86>91) 56	80 (91>95) 56	Cabriolet (91>2000) 56	90 (84>87) 57
					90 (87>91) 57	100 (82>90) 58	Coupé (80>88) 68	Coupé (88>96) 68
* 186115	D 085	255x12,6	899	BMW	Series 3 (E21) (75>83) 76			
* 186116	D 086	255x21,9	899	BMW	Series 3 (E21) (75>83) 76			
186117	D 087	258x9,9	899	BMW	Series 3 (E21) (75>83) 76	Series 3 (E31) (82>93) 76		
186118	D 088	260x12,6	899	BMW	Series 3 (E31) (82>93) 76			
186119	D 036	260x21,9	899	BMW	Series 3 (E31) (82>93) 76	Z1 (E30) (89>92) 86		
186124	D 060	302x11,8	899	BMW	Series 5 (E34) (88>96) 80			
186125	D 091	300x9,9	899	BMW	Series 5 (E34) (88>96) 80	M5 (E34) (88>95) 85		
186128	D 094	244x7	899	CITROËN	2 CV 91	Ami 8 91	Dyane (67>83) 96	Mehari (68>87) 97
				CITROËN	Acadiane (78>87) 101			









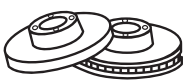





Valeo								
186130	D 012	238x8	899	CITROËN	AX (86>91) 91	AX (91>98) 92	Saxo (96>99) 97	Saxo (99>2005) 97
				PEUGEOT	106 (91>96) 257	106 (96>2003) 258		
* 186131	D 095	258x10	899	CITROËN	AX (86>91) 91			
186134	D 004	266x10	899	CITROËN	BX (82>94) 92			
				PEUGEOT	305 (82>90) 262	405 (87>92) 265	405 (92>96) 265	
186135	D 029	224x7	899	CITROËN	BX (82>94) 92			
186136	D 096	290x16	900	CITROËN	C25 (81>90) 102	C25 (90>94) 102		
				FIAT	Ducato (85>90) 126	Ducato (90>94) 126		
				PEUGEOT	J5 (81>90) 270	J5 (90>94) 270		
* 186137	D 097	285x20	900	CITROËN	C32 (73>79) 102	C35 (73>91) 102		
				FIAT	242 (73>85) 125			
* 186140	D 100	224x7	900	CITROËN	CX (74>91) 95			
186142	D 101	241x10	900	CITROËN	LN/LNA (76>86) 97	Visa (78>88) 98		
				PEUGEOT	104 (72>88) 257			
				RENAULT	R14 (76>84) 276			
				TALBOT	Samba (81>85) 327			
186143	D 102	244,5x8,9	900	CITROËN	LN/LNA (76>86) 97	Visa (78>88) 98		
				CITROËN	C15 (84>2005) 102			
				PEUGEOT	104 (72>88) 257			
186144	D 103	224x9	900	CITROËN	XM (89>94) 99	XM (94>2001) 100		



















Valeo		 Ø 		
186145	D 054	 276x22	900	CITROËN  XM (89>94) 99
				PEUGEOT  605 (89>94) 267
186146	D 104	 251,5x10	900	ALFA ROMEO  164 (87>92) 49 164 (92>98) 49
				FIAT  Bravo II (2007>) 113 Croma (85>90) 114 Croma (91>96) 114 Linea (2007>) 116 Multipla (98>2003) 116 Multipla (2004>) 116 Stilo (2001>2003) 121 Stilo (2004>) 122
				LANCIA  Delta (2008>) 177 Lybra (99>2006) 178 Thema (84>88) 180 Thema (88>92) 180 Thema (92>94) 180
				FIAT  Croma (85>90) 114 Croma (91>96) 114
				LANCIA  Thema (88>92) 180
				ALFA ROMEO  164 (87>92) 49 164 (92>98) 49
				FIAT  Croma (91>96) 114
				LANCIA  Thema (88>92) 180 Thema (92>94) 180
				ALFA ROMEO  164 (87>92) 49
				FIAT  Croma (85>90) 114
LANCIA  Delta (86>93) 176 Thema (84>88) 179				
* 186147	D 105	 257,5x14	900	FIAT  Croma (85>90) 114 Croma (91>96) 114
				LANCIA  Thema (88>92) 180
* 186148	D 106	 257,5x22	900	ALFA ROMEO  164 (87>92) 49 164 (92>98) 49
				FIAT  Croma (91>96) 114
* 186150	D 108	 257,5x12	900	FIAT  Croma (85>90) 114
				LANCIA  Thema (84>88) 179
186151	D 006	 227,5x10,8	900	AUTOBIANCHI  A111 (69>74) 72 A112 (69>85) 72 Y10 (85>95) 73
				FIAT  124 (66>77) 111 125 (67>73) 111









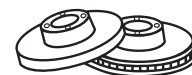





















Valeo		 Ø 		
186151 (...)	D 006	 227,5x10,8	900	FIAT  127/128 (66>86) 111 131/132 (72>85) 111 900 (76>87) 112 Argenta (81>86) 112 Panda (80>86) 117 Panda (86>2003) 118 Regata (83>90) 120 Ritmo (78>82) 120 Ritmo (82>88) 120 Spider (82>85) 121 Strada (85>88) 122 Uno (83>89) 124 Uno (89>95) 124 Uno Mondo (98>) 125 X1/9 (69>89) 125
				FIAT  Fiorino (127) (78>87) 128 Fiorino (147) (81>89) 128
				FSO POLSKI  125 (71>92) 144 Atou (95>97) 144 Caro (91>99) 145 Celina (95>98) 145 Polonez (78>92) 145
				FSO POLSKI  Truck (92>) 145
				INNOCENTI  Koral (90>) 163
				LANCIA  Delta (79>86) 176 Delta (86>93) 176 Prisma (83>86) 179 Prisma (86>89) 179 Y10 (89>95) 181
				SEAT  124 305 127 305 128 305 131 305 132 305 133 305 850 305 1430 305 Fura (82>86) 309 Ibiza (84>93) 309 Malaga (85>93) 312 Marbella (86>98) 312 Panda (80>86) 312 Ronda (82>87) 312
				SEAT  Terra (87>96) 313

















































Valeo		 \varnothing 		
186151 (...)	D 006	 227,5x10,8	900	YUGO/ZASTAVA  <ul style="list-style-type: none"> 101 394 124 394 128 394 132 394 1100 394 1300 394 Florida 394 Sana 394 Tempo 394 Yugo 394
* 186152	D 109	 257x12	900	FIAT  <ul style="list-style-type: none"> Argenta (81>86) 112 Regata (83>90) 120 Ritmo (82>88) 120 LANCIA  <ul style="list-style-type: none"> Delta (79>86) 176 Delta (86>93) 176 Prisma (83>86) 179 Prisma (86>89) 179
186153	D 057	 257,4x20	900	ALFA ROMEO  <ul style="list-style-type: none"> 145 (94>2001) 45 146 (94>2001) 46 155 (91>97) 47 FIAT  <ul style="list-style-type: none"> Albea (2002>) 112 Barchetta (95>2003) 112 Barchetta (2003>) 112 Brava (95>2002) 112 Bravo (95>2002) 113 Marea (96>2002) 116 Marengo (159) (89>95) 116 Marengo (185) (95>) 116 Palio (2001>) 117 Palio Week End (97>2001) 117 Palio Week End (2001>2002) 117 Punto (93>99) 119 Punto II (99>2003) 119 Punto II (2003>) 119 Siena (2002>) 121 Tempra (89>93) 122 Tempra (93>96) 122 Tipo (88>93) 123 Tipo (93>95) 123 FIAT  <ul style="list-style-type: none"> Doblo (2000>2003) 125 Doblo (2004>2005) 125 Doblo Cargo (2000>2003) 125 Doblo Cargo (2004>2005) 125 Strada Pick Up (99>2003) 128 Strada Pick up (2003>2006) 129 Strada II Pick-up (2006>) 129 LANCIA  <ul style="list-style-type: none"> Dedra (89>94) 175 Dedra (94>99) 176 Delta (93>99) 177

Valeo		 \varnothing 		
186154	D 038	 257,5x11,9	900	ALFA ROMEO  <ul style="list-style-type: none"> 145 (94>2001) 45 146 (94>2001) 46 155 (91>97) 47 FIAT  <ul style="list-style-type: none"> Brava (95>2002) 112 Bravo (95>2002) 113 Marea (96>2002) 116 Marengo (159) (89>95) 116 Marengo (185) (95>) 116 Punto (93>99) 118 Punto II (99>2003) 119 Punto II (2003>) 119 Tempra (89>93) 122 Tempra (93>96) 122 Tipo (88>93) 123 Tipo (93>95) 123 LANCIA  <ul style="list-style-type: none"> Dedra (89>94) 175 Dedra (94>99) 175 Delta (93>99) 177 Y Ipsilon (95>2000) 181 Y Ipsilon (2000>2003) 181 Y Ipsilon (2003>) 181
186155	D 035	 240,5x10,9	900	ABARTH  <ul style="list-style-type: none"> 500 Nuova (2008>) 44 ALFA ROMEO  <ul style="list-style-type: none"> 145 (94>2001) 46 146 (94>2001) 46 155 (91>97) 47 FIAT  <ul style="list-style-type: none"> 500 Nuova (2007>) 112 Barchetta (95>2003) 112 Barchetta (2003>) 112 Bravo (95>2002) 113 Cinquecento (92>98) 113 Coupe (93>2000) 114 Marea (96>2002) 116 Marengo (159) (89>95) 116 Panda (2003>) 118 Punto (93>99) 118 Punto II (99>2003) 119 Punto II (2003>) 119 Seicento (98>2005) 120 Tempra (89>93) 122 Tempra (93>96) 122 Tipo (88>93) 123 Tipo (93>95) 123 FORD  <ul style="list-style-type: none"> Ka (2008>) 137 LANCIA  <ul style="list-style-type: none"> Dedra (89>94) 175 Dedra (94>99) 176 Delta (93>99) 176 Musa (2007>) 179 Y Ipsilon (95>2000) 181 Y Ipsilon (2000>2003) 181 Y Ipsilon (2003>) 181
* 186156	D 439	 240x19,9	900	FIAT  <ul style="list-style-type: none"> Uno (83>89) 124 Uno (89>95) 124



Valeo		 Ø 		
186157	D 062	 240,5x12		901 AUTOBIANCHI  Y10 (85>95) 73
				FIAT  Panda (86>2003) 118 Siena (97>2001) 121 Uno (83>89) 124 Uno (89>95) 124 Uno CS (87>) 125 Uno Mondo (98>) 125
				FIAT  Duna (87>91) 128 Fiorino (146) (88>93) 128 Fiorino (146) (93>2000) 128
				INNOCENTI  Elba (91>97) 163
				LANCIA  Y10 (89>95) 181
186158	D 452	 239,7x10		901 FORD  Escort (80>86) 130 Escort (86>90) 130 Orion (83>90) 138
				901 FORD  Escort (80>86) 130 Escort (86>90) 130 Orion (83>90) 138 Sierra (82>86) 140 Sierra (87>93) 140
186159	D 014	 239,7x24,1		901 FORD  Escort (80>86) 130 Escort (86>90) 130 Orion (83>90) 138 Sierra (82>86) 140 Sierra (87>93) 140
				FORD  P100 Pick-up (82>87) 142 P100 Pick-up (88>93) 142
186160	D 016	 221x10		901 FORD  Fiesta (76>83) 131 Fiesta (83>89) 131
186162	D 033	 239,7x10		901 FORD  Escort (90>94) 130 Fiesta (89>95) 132 Orion (90>93) 138
				901 FORD  Escort (90>94) 130 Escort (95>2001) 131 Fiesta (76>83) 131 Fiesta (83>89) 131 Fiesta (89>95) 132 Fiesta (95>99) 132 Fiesta (99>2002) 132 Ka (96>2008) 136 Orion (90>93) 138 Puma (97>2001) 139
186163	D 030	 239,7x20		901 MAZDA  121 (96>) 190
				901 FORD  Granada (85>91) 136 Granada (92>95) 136 Scorpio (85>92) 139 Scorpio (92>94) 139



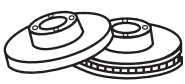





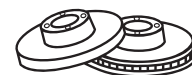













Valeo		 Ø 		
*	186166	D 444	 260,2x24,2	901 FORD  Escort (86>90) 130 Sierra (82>86) 140 Sierra (87>93) 141
				901 FORD  Transit (85>91) 143
				901 FORD  Transit (78>85) 143 Transit (85>91) 143
186169	D 473	 270x14,3		901 ALFA ROMEO  AR8 (80>86) 54
				IVECO  Daily (78>89) 164 Daily (89>96) 165
186170	D 523	 267x14,3		901 LADA  1200/1300/1500/1600/ Classica . 174 Kalinka (95>98) 175
186171	D 524	 252x10,5		901 LADA  Niva (76>) 174
186172	D 460	 272x11		901 LADA  110 (95>) 174 111 (95>) 174 Kalinka (95>98) 175 Natacha (93>) 175 Sagona (91>) 175 Samara (86>) 175
186173	D 461	 239x12		901 MERCEDES  190 (201) (82>93) 196
186176	D 037	 262x10,9		901 MERCEDES  190 (201) (82>93) 196
186177	D 441	 262x21,9		901 MERCEDES  190 (201) (82>93) 196
186178	D 463	 238,5x16		901 MERCEDES  MB100 214
*	186180	D 465	 278x12,6	901 MERCEDES  200/300 (W123) (76>85) 197 Class S (W126) (79>91) 209
186182	D 442	 284x12		902 MERCEDES  200/300 (W124) (84>93) 197 Class E (W124) (93>98) 205
186183	D 467	 278x9		902 MERCEDES  200/300 (W124) (84>93) 198
186184	D 061	 258x9		902 MERCEDES  190 (201) (82>93) 197 200/300 (W124) (84>93) 198 Class E (W124) (93>98) 205
186185	D 110	 284x21,9		902 MERCEDES  190 (201) (82>93) 196 200/300 (W124) (84>93) 197 Class E (W124) (93>98) 205 Class SL (R107) (71>89) 211





























Valeo										
186186	D 010		236x9	902	BEDFORD Novavan (82>88) 73					
					OPEL Corsa A (82>93) 245 Kadett D (79>84) 247 Kadett E (84>91) 247					
					OPEL Combo (85>93) 255					
					VAUXHALL Astra MK I (80>84) 343 Astra MK II (84>91) 343 Astra Belmont (86>91) 343 Nova (83>93) 350					
186187	D 023		236x12,6	902	OPEL Ascona C (81>88) 243 Astra F (91>2001) 243 Astra Classic (98>2002) 243 Corsa A (82>93) 246 Corsa B (93>2000) 246 Kadett D (79>84) 247 Kadett E (84>91) 247					
					VAUXHALL Astra MK II (84>91) 343 Astra Belmont (86>91) 343 Astra MK III (91>2001) 343 Cavalier (81>88) 347 Cavalier (88>95) 347 Corsa MK I (93>2000) 348 Nova (83>93) 350					
					DAEWOO Lanos (97>) 107 Nexia (95>) 107					
					OPEL Ascona C (81>88) 243 Astra F (91>2001) 243 Astra Classic (98>2002) 243 Corsa A (82>93) 246 Corsa B (93>2000) 246 Kadett D (79>84) 247 Kadett E (84>91) 248 Vectra A (88>95) 252					
					OPEL Combo (85>93) 256 Combo (93>2001) 256					
					VAUXHALL Astra MK I (80>84) 343 Astra MK II (84>91) 343 Astra Belmont (86>91) 343 Astra MK III (91>2001) 344 Cavalier (81>88) 347 Cavalier (88>95) 347 Corsa MK I (93>2000) 348 Nova (83>93) 350					
					VAUXHALL Combo (93>2001) 354					

Valeo					
186189	D 056		256x23,9	902	DAEWOO Aranos (95>) 106 Espero (93>99) 106 Lanos (97>) 107 Nexia (95>) 107
					OPEL Ascona C (81>88) 243 Astra F (91>2001) 243 Astra Classic (98>2002) 243 Calibra (89>97) 245 Kadett E (84>91) 248 Vectra A (88>95) 252 Vectra B (95>99) 253
					VAUXHALL Astra MK II (84>91) 343 Astra MK III (91>2001) 344 Calibra (90>97) 345 Cavalier (81>88) 347 Cavalier (88>95) 347 Vectra (95>2002) 352
					OPEL Omega A (86>94) 249 Senator B (87>93) 251
					VAUXHALL Carlton (86>94) 346 Senator B (87>93) 351
					OPEL Omega A (86>94) 249
					VAUXHALL Carlton (86>94) 346
					OPEL Omega A (86>94) 249
					VAUXHALL Carlton (86>94) 346
					CITROËN AX (91>98) 92 Fukang (93>) 96 Saxo (96>99) 97 Saxo (99>2005) 98 Xsara (97>2000) 100 ZX (91>98) 101
186190	D 111		270x10	902	OPEL Omega A (86>94) 249 Senator B (87>93) 251
					VAUXHALL Carlton (86>94) 346 Senator B (87>93) 351
					OPEL Omega A (86>94) 249
186191	D 112		258x23,9	902	OPEL Omega A (86>94) 249
					VAUXHALL Carlton (86>94) 346
* 186192	D 468		258x12,6	902	OPEL Omega A (86>94) 249
					VAUXHALL Carlton (86>94) 346
186194	D 031		247x20,5	902	CITROËN AX (91>98) 92 Fukang (93>) 96 Saxo (96>99) 97 Saxo (99>2005) 98 Xsara (97>2000) 100 ZX (91>98) 101
					PEUGEOT 106 (91>96) 258 106 (96>2003) 258 205 (83>87) 259 205 (87>98) 259 206 (98>) 259 206+ (2009>) 261 306 (93>97) 262 306 (97>2002) 262 309 (85>89) 264 309 (89>94) 264
186195	D 114		247x20,4	902	CITROËN Visa (78>88) 98
					PEUGEOT 205 (83>87) 259 205 (87>98) 259



Valeo		 Ø 		
186196	D 115	 247x8	902	PEUGEOT  205 (83>87) 259 205 (87>98) 259 309 (85>89) 264 309 (89>94) 265
* 186197	D 116	 263x10	902	PEUGEOT  304 (69>80) 262 305 (77>82) 262
186198	D 027	 266x20,5	902	CITROËN  BX (82>94) 92 Xantia (93>97) 98 Xantia (97>2002) 99 Xsara (97>2000) 100 Xsara Picasso (99>) 100 ZX (91>98) 101 CITROËN  Berlingo (96>2002) 101 PEUGEOT  206 (98>) 260 305 (82>90) 262 306 (93>97) 262 306 (97>2002) 263 405 (87>92) 265 405 (92>96) 265 PEUGEOT  Partner (96>2002) 271 Ranch (96>2002) 271
186199	D 117	 247x10	902	PEUGEOT  405 (87>92) 265 405 (92>96) 265
186200	D 003	 247,3x10	902	CITROËN  Fukang (93>) 96 Saxo (96>99) 97 Saxo (99>2005) 98 Visa (78>88) 98 ZX (91>98) 101 CITROËN  C15 (84>2005) 102 PEUGEOT  106 (91>96) 257 106 (96>2003) 258 205 (83>87) 258 205 (87>98) 259 206 (98>) 259 306 (93>97) 262 309 (85>89) 264 309 (89>94) 264 405 (87>92) 265 405 (92>96) 265
186202	D 119	 273x12,9	903	PEUGEOT  504 (68>2000) 266 505 (79>90) 266 604 (76>86) 267 TALBOT  Tagora (80>84) 327



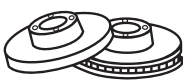





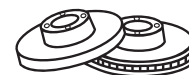









Valeo		 Ø 		
* 186203	D 120	 273x20	903	PEUGEOT  504 (68>2000) 266 505 (79>90) 267 604 (76>86) 267 TALBOT  Tagora (80>84) 327
186204	D 121	 290x10	903	PEUGEOT  605 (89>94) 267 605 (94>99) 268
186205	D 122	 256x13	903	CITROËN  C25 (81>90) 102 FIAT  Ducato (81>85) 126 PEUGEOT  J5 (81>90) 270
186206	D 123	 256x16	903	CITROËN  C25 (81>90) 102 C25 (90>94) 102 FIAT  Ducato (81>85) 126 Ducato (85>90) 126 Ducato (90>94) 126 Talento (88>94) 129 PEUGEOT  J5 (81>90) 270 J5 (90>94) 270
186207	D 124	 280x14	903	PEUGEOT  J7 (65>80) 271 J9 (80>91) 271
186208	D 050	 259x20,6	903	DACIA  Logan (2004>) 105 Sandero (2008>) 106 NISSAN  Interstar (2002>2006) 240 Kubistar (2003>) 240 RENAULT  R19 (88>92) 277 R19 (92>95) 277 Clio I (90>96) 280 Clio II (98>2001) 280 Clio II (2001>) 281 Clio Campus Evolution (2009>) 282 Mégane (95>99) 287 Mégane (98>2003) 288 Mégane Classic (96>99) 288 Mégane Classic (99>2002) 288 Mégane Scenic (96>99) 290 Thalia (2001>) 294 Twingo II (98>2007) 294 Twingo III (2007>) 294 RENAULT  Kangoo (97>2003) 295 Kangoo (2003>) 296
186210	D 126	 278,5x24	903	RENAULT  Master (80>89) 296 Master (89>94) 296 Master (94>97) 296















Valeo								
186211	D 127	238x12	903	RENAULT	R18 (77>86) 276 Fuego (79>85) 283			
186213	D 129	238x20	903	RENAULT	R18 (77>86) 277 Espace I (84>91) 282 Fuego (79>85) 283			
186214	D 015	259x19,6	903	RENAULT	R18 (77>86) 277 R25 (83>92) 279 Alpine GT D500 279 Espace I (84>91) 282 Espace II (91>96) 282 Fuego (79>85) 284			
186218	D 133	252,5x24	903	OPEL	Arena (98>2001) 255			
				RENAULT	R20 (75>84) 278 R30 (75>84) 279			
				RENAULT	Traffic (80>89) 297 Traffic (89>94) 297 Traffic (94>97) 297 Traffic (97>2001) 298			
				VAUXHALL	Arena (98>2001) 354			
186219	D 020	265x20,5	903	RENAULT	R21 (86>94) 278 R21 Nevada Savanna (86>95) ... 278			
186220	D 134	285x21	903	RENAULT	R21 (86>94) 278			
186221	D 028	244x20,5	903	RENAULT	R21 (86>94) 278 R21 Nevada Savanna (86>95) ... 278			
186223	D 135	254x12	903	RENAULT	R25 (83>92) 279 Espace II (91>96) 282			
186224	D 136	280x22	903	RENAULT	R25 (83>92) 279 Espace II (91>96) 282			
186225	D 137	254x12	903	RENAULT	R18 (77>86) 277 R25 (83>92) 279 Espace I (84>91) 282 Espace II (91>96) 282 Fuego (79>85) 284			

Valeo								
186226	D 138	228x10	904	ARO	10 (80>) 54			
				DACIA	1210 (85>2004) 105 1310 (85>2004) 105 1410 (85>2004) 105 Duster (84>99) 105			
				RENAULT	R4 (62>92) 274 R5 (72>85) 274 R6 (68>80) 275 R12 (69>80) 276 R15 (71>80) 276 R17 (71>80) 276 R18 (77>86) 276 Rodeo (70>86) 291			
186228	D 025	238x8	904	RENAULT	Super 5 (84>96) 275 Clio I (90>96) 280 Twingo I (93>98) 294			
				RENAULT	Express (85>91) 295 Extra (85>91) 295 Rapid (85>91) 297			
186229	D 007	238x20	904	NISSAN	Kubistar (2003>) 240			
				RENAULT	Super 5 (84>96) 275 R9 (81>88) 275 R11 (82>89) 275 R19 (88>92) 277 R19 (92>95) 277 R21 (86>94) 278 R21 Nevada Savanna (86>95) ... 278 Clio I (90>96) 280 Clio I (96>98) 280 Clio II (98>2001) 280 Clio II (2001>) 281 Lutecia (Japan) (94>98) 287 Mégane (95>99) 287 Mégane Classic (96>99) 288 Thalia (2001>) 293			
				RENAULT	Kangoo (97>2003) 295 Kangoo (2003>) 296			



Valeo		 Ø		
186230	D 001	 238x11,9	904	DACIA  <ul style="list-style-type: none"> 1210 (85>2004) 105 1310 (85>2004) 105 1410 (85>2004) 105 Duster (84>99) 105
				RENAULT  <ul style="list-style-type: none"> Super 5 (84>96) 275 R9 (81>88) 275 R11 (82>89) 275 R19 (88>92) 277 R19 (92>95) 277 R21 (86>94) 278 Clio I (90>96) 280 Clio I (96>98) 280 Clio II (98>2001) 280 Clio II (2001>) 280 Lutecia (Japan) (94>98) 287 Mégane (95>99) 287 Mégane Classic (96>99) 288 Thalia (2001>) 293 Twingo I (93>98) 294 Twingo II (98>2007) 294
186231	D 140	 238x8	904	RENAULT  <ul style="list-style-type: none"> Super 5 (84>96) 275 R9 (81>88) 275 R11 (82>89) 275
				HONDA  <ul style="list-style-type: none"> Ballade (83>90) 148 Civic II (83>87) 148 Civic III (87>91) 149 Civic Shuttle (83>87) 151
* 186232	D 141	 231x12	904	ROVER  <ul style="list-style-type: none"> 200 (84>90) 299
186234	D 142	 262x21		HONDA  <ul style="list-style-type: none"> Accord Aerodeck (85>89) 147 Prelude (82>87) 154 Prelude (87>91) 154
			ROVER  <ul style="list-style-type: none"> 800 (86>91) 300 800 (91>99) 300 	
* 186235	D 143	 285x21	904	HONDA  <ul style="list-style-type: none"> Legend (85>90) 153
186236	D 144	 240x12,7		ROVER  <ul style="list-style-type: none"> 100 (90>98) 299 Maestro (83>95) 301 Metro UK (90>95) 301 Montego (84>94) 301



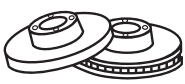













Valeo		 Ø		
* 186240	D 147	 239x11	904	TALBOT  <ul style="list-style-type: none"> 1000 (66>78) 325 Bagheera (77>80) 326 Horizon (78>86) 327 Rancho (77>86) 327
* 186242	D 148	 240,5x12,7	904	TALBOT  <ul style="list-style-type: none"> 1510 (79>82) 326 Alpine (81>85) 326 Solara (80>85) 327
186245	D 008	 239x11,9	904	AUDI  <ul style="list-style-type: none"> 80 (72>81) 55 80 (81>86) 55 Coupé (80>88) 67
				SEAT  <ul style="list-style-type: none"> Cordoba (93>96) 307 Cordoba (96>99) 307 Ibiza (93>96) 309 Ibiza (96>99) 310 Toledo (91>98) 312
				VOLKSWAGEN  <ul style="list-style-type: none"> Dasher (75>80) 360 Golf I (74>83) 360 Golf I Cabriolet (79>93) 360 Golf II (83>92) 360 Golf II Cabriolet (93>98) 361 Golf III (91>99) 361 Jetta I (78>84) 369 Jetta II (83>92) 369 Passat I (73>81) 371 Passat II (81>88) 371 Passat IV (93>97) 372 Polo V (94>99) 375 Quantum (81>88) 377 Santana (81>84) 377 Scirocco (74>90) 377 Vento (91>97) 379
				VOLKSWAGEN  <ul style="list-style-type: none"> Caddy I (82>92) 379



























Valeo		Ø		
186246	D 032	239x19,9	904	AUDI <ul style="list-style-type: none"> 80 (81>86) 55 4000 59 Coupé (80>88) 67
	SEAT <ul style="list-style-type: none"> Cordoba (93>96) 307 Cordoba (96>99) 307 Cordoba (99>2002) 308 Ibiza (93>96) 309 Ibiza (96>99) 310 Ibiza (99>2001) 310 			
				VOLKSWAGEN <ul style="list-style-type: none"> Golf I (74>83) 360 Golf I Cabriolet (79>93) 360 Golf II (83>92) 361 Golf III (91>99) 361 Jetta I (78>84) 369 Jetta II (83>92) 369 Passat I (73>81) 371 Passat II (81>88) 371 Polo III (86>90) 374 Polo IV (90>94) 375 Polo V (94>99) 375 Polo VI (99>2001) 375 Santana (81>84) 377 Scirocco (74>90) 377
186247	D 055	256x19,9	904	SEAT <ul style="list-style-type: none"> Arosa (97>2004) 307 Cordoba (93>96) 307 Cordoba (96>99) 307 Cordoba (99>2002) 308 Ibiza (93>96) 309 Ibiza (96>99) 310 Ibiza (99>2001) 310 Toledo (91>98) 312
				SEAT <ul style="list-style-type: none"> Inca (95>2003) 313
				VOLKSWAGEN <ul style="list-style-type: none"> Corrado (88>95) 359 Golf II (83>92) 361 Golf II Cabriolet (93>98) 361 Golf III (91>99) 361 Golf III Cabriolet (98>2002) 366 Jetta II (83>92) 369 Passat II (81>88) 371 Passat III (88>93) 372 Passat IV (93>97) 372 Polo V (94>99) 375 Polo VI (99>2001) 375 Quantum (81>88) 377 Vento (91>97) 379
				VOLKSWAGEN <ul style="list-style-type: none"> Caddy II (95>2004) 380

Valeo		Ø		
186249	D 017	239x9,9	904	AUDI <ul style="list-style-type: none"> 80 (72>81) 55
				SEAT <ul style="list-style-type: none"> Cordoba (93>96) 307 Cordoba (96>99) 307 Ibiza (93>96) 309 Ibiza (96>99) 309
				VOLKSWAGEN <ul style="list-style-type: none"> Derby (81>84) 360 Golf I (74>83) 360 Golf II (83>92) 360 Jetta I (78>84) 369 Jetta II (83>92) 369 Passat I (73>81) 371 Passat II (81>88) 371 Passat III (88>93) 372 Passat IV (93>97) 372 Polo I (74>81) 374 Polo II (81>86) 374 Polo III (86>90) 374 Polo IV (90>94) 374 Polo V (94>99) 375 Quantum (81>88) 377
186251	D 047	256x12,9	904	SEAT <ul style="list-style-type: none"> Toledo (91>98) 312
				SEAT <ul style="list-style-type: none"> Inca (95>2003) 313
				VOLKSWAGEN <ul style="list-style-type: none"> Golf II Cabriolet (93>98) 361 Golf III (91>99) 361 Golf III Cabriolet (98>2002) 366 Passat III (88>93) 371 Passat IV (93>97) 372 Vento (91>97) 379
				VOLKSWAGEN <ul style="list-style-type: none"> Caddy II (95>2004) 380
186254	D 152	263x14,3	904	VOLVO <ul style="list-style-type: none"> 240 (82>93) 385 242 (74>84) 385 244 (79>82) 385 245 (79>82) 385
186255	D 153	263x22	904	VOLVO <ul style="list-style-type: none"> 240 (82>93) 385 245 (79>82) 385 262 (78>80) 385 264 (78>82) 385 265 (78>85) 386
186256	D 154	281x9,6	905	VOLVO <ul style="list-style-type: none"> 240 (82>93) 385 242 (74>84) 385 244 (79>82) 385 245 (79>82) 385 262 (78>80) 385 264 (78>82) 385 265 (78>85) 386 740 (84>92) 387 760 (82>90) 388 780 (85>91) 388 940 (90>98) 388 960 (90>97) 389



Valeo		 Ø 		
* 186257	D 155	 239x12,7	905	VOLVO  340 (82>91) 386 343 (76>82) 386 345 (79>82) 386 360 (82>89) 386
186258	D 156	 260x12	905	VOLVO  440 (88>97) 386 460 (90>97) 386 480 (86>95) 386
* 186263		 263x22	905	VOLVO  740 (84>92) 387
186264	D 161	 287x22	905	VOLVO  740 (84>92) 387 760 (82>90) 387 780 (85>91) 388 940 (90>98) 388 960 (90>97) 389
186265	D 162	 284,5x22	905	ALFA ROMEO  147 (2000>2004) 46 147 (2004>) 47 156 (97>2003) 48 156 (2003>2007) 48 164 (87>92) 49 GT (2003>) 51 GTV (95>2003) 52 Spider (95>2003) 53 FIAT  Croma (91>96) 114 FIAT  Doblo III (2010>) 125 Doblo Cargo III (2010>) 126 LANCIA  Thema (84>88) 180 Thema (88>92) 180 Thema (92>94) 180









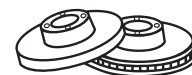



















Valeo		 Ø 		
186266	D 163	 284,5x22	905	ABARTH  500 Nuova (2008>) 44 ALFA ROMEO  155 (91>97) 47 FIAT  500 Nuova (2007>) 112 Bravo (95>2002) 113 Bravo II (2007>) 113 Coupe (93>2000) 113 Croma (85>90) 114 Croma (91>96) 114 Idea (2003>2007) 115 Idea (2007>) 115 Linea (2007>) 116 Marea (96>2002) 116 Stilo (2001>2003) 121 Stilo (2004>) 122 FIAT  Doblo II (2006>) 125 LANCIA  Delta (86>93) 176 Delta (93>99) 177 Delta (2008>) 177 Lybra (99>2006) 178 Musa (2004>2007) 178 Musa (2007>) 178 Thema (88>92) 180 Thema (92>94) 180
186267	D 164	 256x22	905	AUDI  80 (91>95) 56 Cabriolet (91>2000) 56 Coupé (80>88) 68 Coupé (88>96) 68
186268	D 165	 256x13	905	AUDI  80 (91>95) 56 90 (87>91) 57
186269	D 166	 280x13	905	AUDI  80 (91>95) 56
186270	D 167	 288x15	905	AUDI  100 (90>94) 58 A4 (94>98) 61 A6 (94>97) 64
* 186272	D 169	 276x25	905	AUDI  100 (82>90) 58 200 (79>90) 59 Quattro (80>91) 68
* 186273	D 170	 256x19,9	905	AUDI  80 (81>86) 55 90 (84>87) 57 Coupé (80>88) 67 VOLKSWAGEN  Dasher (75>80) 360
186274	D 171	 286x11,9	905	BMW  Series 3 (E36) (90>2001) 77 Z3 (E36) (96>2002) 86

































Valeo				
186275	D 045	286x21,9	905	BMW <ul style="list-style-type: none"> Series 3 (E36) (90>2001) 77 Series 3 (E46) (98>2006) 77 Z3 (E36) (96>2002) 86 Z4 (E85/86) (2002>2009) 86
186276	D 040	247x10	905	CITROËN <ul style="list-style-type: none"> AX (91>98) 92
186277	D 043	260x24,1	905	FORD <ul style="list-style-type: none"> Cougar (98>2001) 130 Granada (92>95) 136 Mondeo (93>96) 137 Mondeo (96>2000) 137 Scorpio (94>98) 139
186278	D 172	254x24,5	905	FORD <ul style="list-style-type: none"> Transit (91>94) 143 Transit (94>99) 143
186280	D 174	284x22	906	MERCEDES <ul style="list-style-type: none"> Class C (W202) (93>2001) 200
186281	D 175	258x8,9	906	MERCEDES <ul style="list-style-type: none"> Class C (W202) (93>2001) 200
186282	D 059	256x19,9	906	OPEL <ul style="list-style-type: none"> Astra F (91>2001) 243 Corsa B (93>2000) 246 Tigra (94>2001) 252 Vectra A (88>95) 252 VAUXHALL <ul style="list-style-type: none"> Astra MK III (91>2001) 344 Cavalier (88>95) 347 Corsa MK I (93>2000) 348 Tigra (94>2001) 351
186283	D 420	298,5x14	906	LAND ROVER <ul style="list-style-type: none"> Defender (90>2007) 181 Defender II (2007>) 182 Discovery (89>94) 182 Land 90 183 Land 110 183 Range Rover (81>86) 183 Range Rover (86>94) 184
* 186284	D 421	298x24	906	LAND ROVER <ul style="list-style-type: none"> Defender (90>2007) 181 Defender II (2007>) 182 Discovery (89>94) 182 Discovery (94>98) 182 Range Rover (86>94) 184
186285	D 176	238x12,7	906	ROVER <ul style="list-style-type: none"> 200 (89>96) 299 400 (90>95) 299
186286	D 065	262x21	906	HONDA <ul style="list-style-type: none"> Concerto (89>96) 151 ROVER <ul style="list-style-type: none"> 200 (89>96) 299 400 (90>95) 299
* 186287	D 177	251x20	906	SEAT <ul style="list-style-type: none"> Ibiza (84>93) 309 Malaga (85>93) 312

Valeo				
186288	D 180	226x10	906	SEAT <ul style="list-style-type: none"> Cordoba (93>96) 307 Cordoba (96>99) 308 Ibiza (93>96) 309 Ibiza (96>99) 310 Toledo (91>98) 313 VOLKSWAGEN <ul style="list-style-type: none"> Corrado (88>95) 359 Golf II (83>92) 361 Golf II Cabriolet (93>98) 361 Golf III (91>99) 365 Golf III Cabriolet (98>2002) 366 Jetta I (78>84) 369 Jetta II (83>92) 369 Passat II (81>88) 371 Passat III (88>93) 372 Passat IV (93>97) 372 Polo V (94>99) 375 Scirocco (74>90) 377 Vento (91>97) 379
* 186289	D 181	280x26	906	VOLVO <ul style="list-style-type: none"> 740 (84>92) 387 780 (85>91) 388 940 (90>98) 388 960 (90>97) 389
186290	D 182	251,5x10	906	ALFA ROMEO <ul style="list-style-type: none"> 147 (2000>2004) 46 147 (2004>) 47 156 (97>2003) 48 164 (87>92) 49 164 (92>98) 49 FIAT <ul style="list-style-type: none"> Croma (91>96) 114 LANCIA <ul style="list-style-type: none"> Delta (86>93) 176 Thema (84>88) 180 Thema (92>94) 180
186291	D 183	280x22	906	AUDI <ul style="list-style-type: none"> 80 (91>95) 56 Cabriolet (91>2000) 56 Coupé (88>96) 68
186292	D 184	245x10	906	AUDI <ul style="list-style-type: none"> 80 (81>86) 55 80 (86>91) 55 80 (91>95) 56 90 (84>87) 57 90 (87>91) 57 Coupé (80>88) 68 Coupé (88>96) 68
186294	D 186	245x9,9	906	AUDI <ul style="list-style-type: none"> 100 (90>94) 59 A6 (94>97) 64 A6 (97>2001) 64 A6 (2001>2005) 65 SKODA <ul style="list-style-type: none"> Superb (2001>2008) 317 VOLKSWAGEN <ul style="list-style-type: none"> Passat V (96>2000) 373 Passat VI (2000>2005) 373



Valeo		 Ø 		
186295	D 187	 280x9,9	906	BMW  Series 3 (E36) (90>2001) 77 Series 3 (E46) (98>2006) 78 Z4 (E85/86) (2002>2009) 86
186296	D 063	 283x22	906	CITROËN  AX (91>98) 92 Xantia (93>97) 98 Xantia (97>2002) 99 Xsara (97>2000) 100 Xsara (2000>2005) 100 ZX (91>98) 101 PEUGEOT  306 (93>97) 262 306 (97>2002) 263 405 (92>96) 265
186297	D 188	 284x22	906	ALFA ROMEO  145 (94>2001) 45 146 (94>2001) 46 155 (91>97) 47 FIAT  Coupe (93>2000) 113 Multipla (98>2003) 116 Multipla (2004>) 116 Punto II (2003>) 119 Tipo (88>93) 123 Tipo (93>95) 123 LANCIA  Dedra (89>94) 175 Dedra (94>99) 176 Delta (93>99) 177
186298	D 189	 284x12	906	MERCEDES  Class C (W202) (93>2001) 200
* 186299	D 190	 214x12	907	NISSAN  Micra (K10) (82>92) 236
186300	D 191	 234x12	907	NISSAN  Micra (K11E) (92>2000) 236 Micra (K11E) (2000>2002) 236
186301	D 192	 242x20	907	NISSAN  Primera (P10/W10) (90>98) 237
* 186302	D 193	 261x10	907	OPEL  Kadett E (84>91) 248 Vectra A (88>95) 253 VAUXHALL  Astra MK II (84>91) 343 Cavalier (88>95) 348
186303	D 053	 283x26	907	CITROËN  XM (89>94) 99 XM (94>2001) 99 PEUGEOT  605 (89>94) 267 605 (94>99) 268
186304	D 041	 262x22	907	RENAULT  Laguna I (94>98) 284 Laguna I Nevada (95>98) 285 Mégane (95>99) 287 Mégane Scenic (96>99) 290 Safrane (92>96) 291



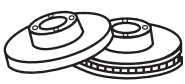





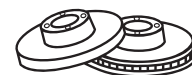









Valeo		 Ø 		
186305	D 067	 262x22	907	RENAULT  Laguna I (94>98) 284 Safrane (92>96) 291 Safrane (96>2000) 292
186306	D 068	 265x10,5	907	RENAULT  Laguna I (94>98) 284 Laguna I (98>2000) 285 Laguna I Nevada (95>98) 285 Laguna I Nevada (98>2000) 286 Safrane (92>96) 292
186307	D 058	 265x10,5	907	RENAULT  Laguna I (94>98) 284 Laguna I (98>2000) 285 Laguna I Nevada (95>98) 285 Laguna I Nevada (98>2000) 286 Safrane (92>96) 292 Safrane (96>2000) 292
* 186310	D 195	 291x12,7	907	LAND ROVER  Defender (90>2007) 182 Defender II (2007>) 182 Discovery (89>94) 182 Discovery (94>98) 182 Range Rover (81>86) 184 Range Rover (86>94) 184
186311	D 196	 228x9	907	VOLVO  440 (88>97) 386 460 (90>97) 386 480 (86>95) 386
186313	D 199	 280x22	907	SEAT  Toledo (91>98) 312 VOLKSWAGEN  Corrado (88>95) 359 Golf III (91>99) 362 Passat IV (93>97) 372 Vento (91>97) 379
* 186314	D 200	 260x16	907	VOLKSWAGEN  Transporter (F70) (90>96) 381
186315	D 201	 280x24	907	VOLKSWAGEN  Transporter (F70) (90>96) 382
186374	D 202	 289,8x10	907	SANTANA  Samurai 304 SUZUKI  S410/S413 322 Samurai (92>) 322
186401		 278x24	907	FORD  Cougar (98>2001) 130 Mondeo (93>96) 137 Mondeo (96>2000) 137 Scorpio (94>98) 139
* 186405	D 204	 281x26	907	ALFA ROMEO  164 (92>98) 49
186406	D 205	 240x10,9	907	ALFA ROMEO  33 (89>94) 44 145 (94>2001) 46 155 (91>97) 47































Valeo					
186408	D 207	280x13	908	AUDI	
				A4 (94>98) 61	
186416	D 069	247x8	908	CITROËN	
				Saxo (96>99) 97	
				Saxo (99>2005) 98	
				Xsara (97>2000) 100	
				Xsara (2000>2005) 100	
				ZX (91>98) 101	
				PEUGEOT	
				106 (96>2003) 258	
				206 (98>) 261	
				306 (93>97) 262	
				306 (97>2002) 263	
186418	D 214	280x24	908	CITROËN	
				Jumper (94>2001) 103	
				Jumper (2002>2006) 103	
				Relay (94>2001) 104	
				Relay (2002>2006) 104	
				FIAT	
				Ducato (94>2001) 126	
				Ducato (2002>2006) 127	
				Ducato RU (2008>) 127	
				PEUGEOT	
				Boxer I (94>2001) 269	
				Boxer I (2002>2006) 269	
186420	D 051	281x26	908	CITROËN	
				Evasion (94>98) 96	
				Evasion (98>2002) 96	
				Synergie (95>98) 98	
				Synergie (98>2002) 98	
				CITROËN	
				Dispatch (95>2003) 102	
				Jumpy (95>2003) 104	
				FIAT	
				Ulysse (94>98) 123	
				Ulysse (98>2002) 123	
				FIAT	
				Scudo (95>2003) 128	
				Scudo (2004>2006) 128	
				LANCIA	
				Zeta (94>2002) 181	
				PEUGEOT	
				806 (94>98) 268	
				806 (98>2002) 268	
				PEUGEOT	
				Expert I (95>2003) 270	

Valeo					
186421	D 215	295x10	908	CITROËN	
				Evasion (94>98) 96	
				Evasion (98>2002) 96	
				Synergie (95>98) 98	
				Synergie (98>2002) 98	
				FIAT	
				Ulysse (94>98) 123	
				Ulysse (98>2002) 124	
				LANCIA	
				Zeta (94>2002) 181	
				PEUGEOT	
				806 (94>98) 268	
				806 (98>2002) 268	
* 186424	D 217	253x10,1	908	FORD	
				Granada (85>91) 136	
				Granada (92>95) 136	
				Scorpio (85>92) 139	
				Scorpio (92>94) 139	
186425	D 218	253x10	908	FORD	
				Fiesta (2002>2005) 132	
				Fiesta (2005>2008) 133	
				Focus (98>2001) 133	
				Focus (2001>2004) 133	
				Granada (92>95) 136	
				Scorpio (94>98) 140	
				Sierra (87>93) 141	
186426	D 219	253x20	908	FORD	
				Cougar (98>2001) 130	
				Granada (92>95) 136	
				Mondeo (93>96) 137	
				Mondeo (96>2000) 137	
				Scorpio (94>98) 140	
186427	D 220	260x24,2	908	FORD	
				Escort (90>94) 131	
				Escort (95>2001) 131	
186428	D 221	270x10	908	FORD	
				Escort (90>94) 131	
				Escort (95>2001) 131	
* 186431	D 224	242x19	908	HONDA	
				Civic III (87>91) 149	
				Civic Shuttle (87>92) 151	
				CRX (83>88) 151	
				CRX (87>92) 151	
				Integra (85>89) 152	
* 186432	D 225	238,5x9	908	HONDA	
				Civic IV (91>95) 149	
				Civic V (EJ/EK) (95>2001) 150	
				CRX (92>98) 152	
186433	D 226	240x21	908	HONDA	
				Civic IV (91>95) 149	
				Civic V (EJ*) (96>2000) 149	
				Civic V (EJ/EK) (95>2001) 150	



Valeo		 Ø 		
186435	D 228	 238,5x10	908	HONDA  Accord III (85>89) 146 Accord Aerodeck (85>89) 147 Civic III (87>91) 149 Civic V (MA/MB) (95>2001) 149 Civic Aerodeck (97>2001) 151 Concerto (89>96) 151 CRX (87>92) 151 Integra (85>89) 152 Prelude (87>91) 154 MG  MG ZR (2001>2005) 216 ROVER  25 (99>2005) 298 45 (2000>2005) 298 200 (89>96) 299 200 (95>99) 299 200 Coupé/Cabriolet (96>99) 299 400 (90>95) 300 400 (95>2000) 300
* 186436	D 229	 260x23	908	HONDA  Accord IV (89>93) 146 Accord V (93>95) 146 Accord V (95>98) 147 Accord coupe (91>93) 148 Accord coupe (93>97) 148
186438	D 231	 262x21	908	HONDA  Civic III (87>91) 149 Civic IV (91>95) 149 Civic V (MA/MB) (95>2001) 149 Civic V (EJ*) (96>2000) 149 Civic V (EJ/EK) (95>2001) 150 Civic (EP) (2001>2006) 150 Civic Aerodeck (97>2001) 151 CRX (87>92) 151 CRX (92>98) 152 MG  MG ZR (2001>2005) 216 MG ZS (2001>2005) 216 ROVER  25 (99>2005) 298 45 (2000>2005) 298 200 (95>99) 299 200 Coupé/Cabriolet (96>99) 299 400 (95>2000) 300
186439	D 232	 282x23	908	HONDA  Accord IV (89>93) 146 Accord V (93>95) 146 Accord V (95>98) 147 Accord Aerodeck (90>93) 147 Accord Aerodeck (93>97) 148 Accord coupe (93>97) 148 ROVER  600 (93>2000) 300
186440	D 233	 257x22	908	HYUNDAI  Sonata (88>93) 161 Sonata (93>98) 161

Valeo		 Ø 		
* 186441	D 234	 242x19,1	909	HYUNDAI  Accent (94>99) 156 Excel (86>89) 158 Excel (89>94) 158 Excel (94>99) 158 Pony (82>94) 160 Pony (94>99) 160 Scoupe (90>96) 161
186442	D 426	 281x22	909	LANCIA  Kappa (94>2001) 177
* 186443	D 427	 281x26	909	ALFA ROMEO  166 (98>2003) 49 166 (2003>2007) 49 LANCIA  Kappa (94>2001) 178
186446	D 236	 242x20	909	MAZDA  626 (GD) (87>92) 191 RX7 (85>91) 194
* 186449	D 239	 235x18	909	MAZDA  121 (90>96) 190 323 (BG) (89>94) 190 323 (BA) (94>98) 190 MX5 (90>98) 193
* 186451	D 241	 257x22	909	MAZDA  323 (BG) (89>94) 190 323 (BA) (94>98) 191 MX3 (91>98) 193
* 186452	D 242	 251x9	909	MAZDA  323 (BG) (89>94) 190 MX3 (91>98) 193 MX5 (90>98) 193 MX5 (98>2000) 194 MX5 (2000>2005) 194
* 186453	D 243	 235x12	909	MAZDA  121 (90>96) 190
186454	D 244	 219x13	909	KIA  Pride (87>2000) 173 Pride Wagon (98>2000) 173 MAZDA  121 (88>90) 190
* 186455	D 245	 264x24	909	MAZDA  626 (GD) (87>92) 191 626 Wagon (GV) (88>92) 192 626 Wagon (GV) (92>97) 192
186457	D 247	 258x24	909	FORD  Probe (92>97) 138 MAZDA  626 (GE) (91>97) 192 626 (GF) (97>2002) 192 626 Wagon (GW) (97>99) 192 626 Wagon (GW) (99>2002) 193 MX6 (91>97) 194 Premacy (99>2001) 194 Premacy (2001>2005) 194 Xedos 6 (91>99) 195

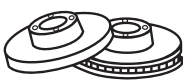

Valeo							
* 186458	D 248		261x9,8	909	FORD Probe (92>97) 139 MAZDA 626 (GE) (91>97) 192 626 (GF) (97>2002) 192 626 Wagon (GW) (97>99) 192 626 Wagon (GW) (99>2002) 193 MX6 (91>97) 194 Premacy (2001>2005) 194 Xedos 6 (91>99) 195		
* 186460	D 250		295x21,9	909	MERCEDES 200/300 (W124) (84>93) 198 Class E (W124) (93>98) 205		
* 186461	D 251		300x28	909	MERCEDES 190 (201) (82>93) 196 200/300 (W124) (84>93) 198 Class E (W124) (93>98) 205 Class SL (129) (89>2001) 211		
186462	D 252		278x9	909	MERCEDES 190 (201) (82>93) 197 Class SL (129) (89>2001) 211		
* 186465	D 255		300x22	909	MERCEDES Class S (W140) (91>93) 209 Class S (W140) (93>99) 209		
186467	D 257		288x25	909	MERCEDES Class C (W202) (93>2001) 200 Class CLK (W208) (97>2003) 203 Class E (W210) (95>2003) 206 Class SLK (170) (96>2003) 212		
186469	D 259		290x10	909	MERCEDES Class C (W203) (2000>2003) 201 Class C (W203) (2004>) 202 Class CLC (W203) (2008>) 203 Class CLK (W208) (97>2003) 203 Class CLK (W209) (2002>2009) 204 Class E (W124) (93>98) 206 Class E (W210) (95>2003) 207 Class SLK (171) (2004>2007) 213 Class SLK (171) (2008>) 213		
186470	D 262		278x9	910	CHRYSLER Crossfire (2003>) 89 MERCEDES 200/300 (W124) (84>93) 198 Class C (W202) (93>2001) 200 Class C (W203) (2000>2003) 201 Class C (W203) (2004>) 202 Class CLC (W203) (2008>) 203 Class CLK (W208) (97>2003) 203 Class CLK (W209) (2002>2009) 204 Class E (W124) (93>98) 205 Class E (W210) (95>2003) 206 Class SLK (170) (96>2003) 213 Class SLK (171) (2004>2007) 213 Class SLK (171) (2008>) 213		
186476	D 434		236x18	910	MITSUBISHI Colt (88>92) 223 Galant (87>92) 224 Lancer F (CV) (85>92) 226 Lancer F (C6/7) (88>95) 226		

Valeo							
186479	D 264		295x20	910	NISSAN Patrol 160 Made in Japan (80>85) 230 Patrol 160 Made in Spain (79>85) 231 Patrol 260 (84>96) 231 Patrol GR (Y60) (88>97) 231		
186482	D 268		240x18	910	NISSAN 100 NX (B13) (90>94) 232 Sunny (B12) (86>90) 239 Sunny (N13) (86>90) 239 Sunny (N14) (90>95) 239 Sunny (Y10) (90>2000) 239		
186485	D 271		257x22	910	NISSAN 200 SX (S13) (88>94) 232 Almera (N16E) (2000>2003) 233 Almera (N16E) (2003>2006) 233 Cedric (Y30) (83>88) 235 Prairie (M11) (88>94) 237 Primera (P10/W10) (90>98) 237 Primera (P11/W11) (96>2002) 237		
186487	D 273		258x10	910	NISSAN Almera (N16E) (2000>2003) 233 Almera (N16E) (2003>2006) 234 Maxima (J30) (88>94) 235 Primera (P11/W11) (96>2002) 237		
186488	D 274		257x22	910	BEDFORD Brava (88>90) 73 ISUZU Trooper (81>97) 164 OPEL Frontera A (91>98) 241 OPEL Sintra (96>99) 251 OPEL Campo (88>96) 255 Campo (96>) 255 VAUXHALL Frontera A (91>98) 342 VAUXHALL Sintra (96>99) 351 VAUXHALL Brava (88>96) 354 Brava (96>) 354		
186490	D 276		260x10	910	OPEL Astra F (91>2001) 243 Vectra A (88>95) 253 VAUXHALL Astra MK III (91>2001) 344 Cavalier (88>95) 348		
186495	D 281		213x9,4	910	INNOCENTI Mini (74>84) 163 ROVER Mini (80>90) 301 Mini (90>99) 301		

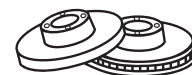

Valeo			\varnothing		
186496	D 282		284x24	910	OPEL Calibra (89>97) 245 Vectra A (88>95) 252 SAAB 900 (93>98) 304 VAUXHALL Calibra (90>97) 345 Cavalier (88>95) 347
* 186497	D 283		260x10	910	OPEL Vectra A (88>95) 253 SAAB 900 (93>98) 304 VAUXHALL Cavalier (88>95) 348
* 186498	D 284		258x9	910	SAAB 900 (80>93) 304 900 (93>98) 304 9000 (84>98) 304
186500	D 286		280x25	910	SAAB 9000 (84>98) 304
* 186501	D 287		251,5x11	910	FIAT 131/132 (72>85) 111 Ritmo (78>82) 120 SEAT Ronda (82>87) 312
* 186503	D 288		266x10	910	SUBARU Forester (97>2002) 319 Forester (2005>2007) 319 Impreza (93>2000) 320 Impreza (2000>2005) 320 Impreza (2005>2007) 320 Legacy (89>94) 321 Legacy (94>98) 321
186504	D 289		290x10	910	SANTANA Vitara 305 SUZUKI Jimny (98>) 322 Vitara (88>98) 323 X90 (95>) 323
186505	D 469		231x17	910	SUBARU Justy (95>2003) 321 SUZUKI Alto (94>2002) 323 Cappuccino (91>98) 323 Swift Made in Japan (89>96) 324 Swift Made in Hungary (95>96) 324 Swift Made in Hungary (96>2005) 325
* 186508	D 292		258x22	910	TOYOTA Celica (85>89) 333
* 186509	D 293		255x22	911	TOYOTA Camry (86>91) 332 Carina II (87>92) 333
* 186510	D 294		234x12,5	911	TOYOTA Corolla (90) (87>92) 335



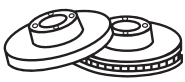





















Valeo			\varnothing		
186511	D 295		238x18	911	TOYOTA Corolla (90) (87>92) 335 Corolla (100) (92>97) 335 Corolla (110) (97>99) 335
* 186514	D 622		255x25	911	TOYOTA Previa (90>2000) 338
186517	D 298		226x10	911	SEAT Toledo (91>98) 313 VOLKSWAGEN Corrado (88>95) 359 Golf III (91>99) 365 Passat III (88>93) 372 Passat IV (93>97) 372 Vento (91>97) 379
186519	D 300		280x22	911	SEAT Cordoba (96>99) 307 Cordoba (99>2002) 308 Ibiza (96>99) 310 Ibiza (99>2001) 310 VOLKSWAGEN Corrado (88>95) 359 Golf II (83>92) 361 Passat III (88>93) 372
* 186520	D 301		277x16	911	VOLKSWAGEN Transporter (F24) (79>92) 381
186521	D 302		288x25	911	VOLKSWAGEN Golf III (91>99) 363 Passat IV (93>97) 372 Vento (91>97) 379
186523	D 046		239x17,9	911	SEAT Arosa (97>2004) 307 VOLKSWAGEN Lupo (98>2005) 370 Polo V (94>99) 375 Polo VI (99>2001) 375
186526	D 305		280x26	911	VOLVO XC 70 (97>99) 384 VOLVO 850 (91>96) 388 940 (90>98) 388 960 (90>97) 389 C70 (97>2005) 391 S70 (96>2000) 391 V70 (96>2000) 392 S90 (96>98) 393 V90 (96>98) 394
186528	D 307		295x9,6	911	VOLVO 850 (91>96) 388 C70 (97>2005) 391 S70 (96>2000) 392 V70 (96>2000) 392
186529	D 052		239,7x12	911	FORD Fiesta (95>99) 132 Ka (96>2008) 136 MAZDA 121 (96>) 190

























Valeo									
186530	D 308		236x12,9	911	SKODA	100-135 314 Favorit (88>95) 315 Forman (90>95) 315			
186532	D 064		260x27	911	PEUGEOT	406 (95>2004) 265			
186533	D 048		283x26	911	CITROËN	Xantia (93>97) 98 Xantia (97>2002) 99			
					PEUGEOT	406 (95>2004) 265			
* 186537	D 311		270x24	911	FORD	Transit (91>94) 143 Transit (94>99) 143			
* 186547	D 470		289x20	911	TOYOTA	4 Runner (60) (84>89) 328 Hilux (83>98) 328 Hilux (2001>) 328			
					VOLKSWAGEN	Taro (89>97) 381			
186551	D 319		276x22	911	MERCEDES	Class V (96>2002) 213			
					MERCEDES	Vito (96>2003) 215			
186552	D 320		280x9,9	912	MERCEDES	Class V (96>2002) 214			
					MERCEDES	Vito (96>2003) 215			
186559	D 325		276x18,9	912	BMW	Series 3 (E36) (90>2001) 77 Series 3 (E46) (98>2006) 78			
186560	D 326		258x22	912	FORD	Fiesta (99>2002) 132 Fiesta (2002>2005) 132 Fiesta (2005>2008) 133 Focus (98>2001) 133 Focus (2001>2004) 133 Fusion (2002>2005) 135 Fusion (2005>) 135 Ka (96>2008) 136 Puma (97>2001) 139 StreetKa (2002>2005) 142			
					FORD	Courier Courier (96>2002) 142			
					MAZDA	2 (2003>2008) 188			
186562	D 327		260x12	912	MERCEDES	Class A (W168) (97>2004) 199			
* 186563	D 328		256,5x26	912	NISSAN	Serena (C23M) (92>2001) 238			
* 186564	D 329		258x9	912	NISSAN	100 NX (B13) (90>94) 232 Almera (N15) (95>2000) 233 Primera (P10/W10) (90>98) 237 Sunny (N14) (90>95) 239			

Valeo									
186565	D 330		270x9,9	912	OPEL	Vectra B (95>99) 253			
					VAUXHALL	Vectra (95>2002) 352			
* 186566	D 471		286x10	912	OPEL	Vectra B (95>99) 253 Vectra B (99>2003) 253			
					SAAB	9-3 (98>2003) 302 9-5 (97>2001) 303 900 (93>98) 304			
					VAUXHALL	Vectra (95>2002) 352			
186567	D 331		255x10,5	912	RENAULT	R21 (86>94) 278 R21 Nevada Savanna (86>95) 278 Espace I (84>91) 282			
186568	D 332		298x9,9	912	BMW	Series 5 (E39) (95>2004) 81			
186569	D 333		251x12	912	CITROËN	Xantia (93>97) 99 Xantia (97>2002) 99			
186570	D 334		282,5x24	912	CHRYSLER	Voyager II (91>95) 90 Grand Voyager (92>95) 90			
186571	D 335		240x20	912	FIAT	Palio (96>2001) 117 Palio (2001>) 117 Palio Week End (97>2001) 117 Palio Week End (2001>2002) 117 Siena (97>2001) 121 Siena (2002>) 121			
* 186572	D 336		253x20	912	HYUNDAI	H100 (93>) 163 Jobs (98>) 163			
186573	D 337		260x22	912	MERCEDES	Class A (W168) (97>2004) 199			
186576	D 338		232x18	912	NISSAN	Almera (N15) (95>2000) 233			
186577	D 339		247x18	912	NISSAN	Almera (N15) (95>2000) 233			
186579	D 072		290,5x10	912	PEUGEOT	406 (95>2004) 265			
186581	D 341		239x9,9	913	SEAT	Arosa (97>2004) 307			
					VOLKSWAGEN	Polo V (94>99) 375			



Valeo		 Ø 		
186582	D 342	 280x22	913	AUDI  A4 (94>98) 61 A4 (99>2001) 61 A4 (2000>2004) 62 A4 (2004>2008) 62 A8 (94>2002) 67 A8 (2002>2009) 67
				SEAT  Exeo (2008>) 308
186583	D 343	 282,5x25	913	VOLKSWAGEN  Passat V (96>2000) 372
				VOLKSWAGEN  Passat V (96>2000) 372 Phaeton (2002>2007) 374
186585	D 345	 280x26	913	OPEL  Frontera A (91>98) 241 Frontera B (98>2005) 242 Monterey (91>99) 242
				VAUXHALL  Frontera A (91>98) 342 Frontera B (98>2005) 342 Monterey A (94>99) 342 Monterey B (98>99) 342
186586	D 071	 224x7	913	CITROËN  Xantia (93>97) 99 Xantia (97>2002) 99
186587	D 346	 235x17,9	913	TOYOTA  Yaris Made in Japan (99>2005) .. 339 Yaris Made in France (2001>2005) 340
186589	D 347	 257x20	913	CITROËN  Evasion (94>98) 96 Evasion (98>2002) 96 Synergie (95>98) 98
				CITROËN  Dispatch (95>2003) 102 Dispatch (2004>2006) 103 Jumpy (95>2003) 104 Jumpy (2004>2006) 104
				FIAT  Ulysse (94>98) 123 Ulysse (98>2002) 123
				FIAT  Scudo (95>2003) 128 Scudo (2004>2006) 128
				PEUGEOT  806 (94>98) 268 806 (98>2002) 268
				PEUGEOT  Expert I (95>2003) 270 Expert I (2004>2006) 270

Valeo		 Ø 		
186590	D 348	 257x22	913	ALFA ROMEO  145 (94>2001) 45 155 (91>97) 47 MiTo (2008>) 52
				CITROËN  Nemo (2007>) 104
				FIAT  500 Nuova (2007>) 112 Bravo II (2007>) 113 Idea (2003>2007) 115 Idea (2007>) 115 Linea (2007>) 115 Panda (2003>) 118 Punto II (99>2003) 119 Qubo (2008>) 120 Stilo (2001>2003) 121 Stilo (2004>) 121
				FIAT  Doblo Cargo II (2006>) 125 Fiorino (2007>) 128
				LANCIA  Dedra (94>99) 176 Musa (2004>2007) 178 Musa (2007>) 178 Y Ipsilon (2003>) 181
				PEUGEOT  Bipper (2007>) 269
186591	D 349	 256x11	913	OPEL  Astra G (98>2005) 244
				VAUXHALL  Astra MK IV (98>2005) 344
186592	D 350	 256x24	913	OPEL  Astra G (98>2005) 244
				VAUXHALL  Astra MK IV (98>2005) 344
186593	D 351	 263,4x10	913	OPEL  Astra G (98>2005) 244 Astra H (2004>) 245 Meriva (2003>) 248 Meriva (2010>) 249 Zafira A (98>2003) 254 Zafira A (2003>2005) 254 Zafira B (2005>2008) 255 Zafira B (2008>) 255
				OPEL  Combo/Combo Tour (2001>) 256
				VAUXHALL  Astra MK IV (98>2005) 344 Astra MK V (2004>) 345 Meriva (2003>) 349 Meriva (2010>) 350 Zafira I (99>2003) 353 Zafira I (2003>2005) 353 Zafira II (2005>2009) 353 Zafira II (2009>) 354
				VAUXHALL  Combo (2001>) 354

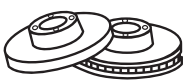

Valeo				
186594	D 352	240x10	913	OPEL <ul style="list-style-type: none"> Astra G (98>2005) 244 Astra H (2004>) 244 Meriva (2003>) 248 VAUXHALL <ul style="list-style-type: none"> Astra MK IV (98>2005) 344 Astra MK V (2004>) 345 Meriva (2003>) 349
186596	D 354	255x10,5	913	RENAULT <ul style="list-style-type: none"> R21 (86>94) 278
186597	D 355	232x9	913	AUDI <ul style="list-style-type: none"> A1 (2010>) 59 A2 (2000>2005) 59 A3 (96>2000) 60 A3 (2000>2003) 60 TT (98>2006) 72 SEAT <ul style="list-style-type: none"> Cordoba (2002>) 308 Ibiza (2001>) 310 Ibiza (2008>) 311 Leon (99>2006) 311 Toledo (98>2004) 313 SKODA <ul style="list-style-type: none"> Fabia (99>2004) 314 Fabia (2004>2007) 314 Fabia (2006>) 315 Octavia (96>2000) 316 Octavia (2000>) 316 Roomster (2006>) 317 VOLKSWAGEN <ul style="list-style-type: none"> Bora (98>2005) 358 Golf IV (97>2006) 367 New Beetle (98>2001) 370 New Beetle (2001>2005) 371 New Beetle (2005>) 371 Polo VII (2001>) 376 Polo VIII (2005>) 376 Polo IX (2009>) 377
186598	D 356	247x13	913	CITROËN <ul style="list-style-type: none"> Xsara (97>2000) 100 PEUGEOT <ul style="list-style-type: none"> 206 (98>) 259 206+ (2009>) 261 306 (97>2002) 262
186599	D 357	266x13	913	CITROËN <ul style="list-style-type: none"> C2 (2003>2010) 92 C3 (2002>2005) 92 C3 (2005>) 93 CITROËN <ul style="list-style-type: none"> Berlingo (96>2002) 101 PEUGEOT <ul style="list-style-type: none"> Partner (96>2002) 271 Ranch (96>2002) 271

Valeo				
186600	D 073	280x24	913	RENAULT <ul style="list-style-type: none"> Espace III (96>2000) 282 Espace III (2000>2002) 283 Laguna I (94>98) 284 Laguna I (98>2000) 284 Laguna I Nevada (95>98) 285 Laguna I Nevada (98>2000) 285 Mégane Scenic (99>2003) 291 Safrane (92>96) 292 Safrane (96>2000) 292
186603	D 360	256x21,9	913	AUDI <ul style="list-style-type: none"> A1 (2010>) 59 A2 (2000>2005) 59 A3 (96>2000) 59 A3 (2000>2003) 60 SEAT <ul style="list-style-type: none"> Cordoba (2002>) 308 Ibiza (2001>) 310 Ibiza (2008>) 311 Leon (99>2006) 311 Toledo (98>2004) 313 SKODA <ul style="list-style-type: none"> Fabia (99>2004) 314 Fabia (2004>2007) 314 Fabia (2006>) 315 Octavia (96>2000) 315 Octavia (2000>) 316 Roomster (2006>) 317 VOLKSWAGEN <ul style="list-style-type: none"> Bora (98>2005) 357 Fox (2004>) 360 Golf IV (97>2006) 366 Polo VII (2001>) 376 Polo VIII (2005>) 376 Polo IX (2009>) 376
186604	D 438	280x22	914	AUDI <ul style="list-style-type: none"> A3 (96>2000) 59 A3 (2000>2003) 60 SEAT <ul style="list-style-type: none"> Leon (99>2006) 311 Toledo (98>2004) 313 SKODA <ul style="list-style-type: none"> Octavia (96>2000) 315 Octavia (2000>) 316 VOLKSWAGEN <ul style="list-style-type: none"> Bora (98>2005) 357 Golf IV (97>2006) 366 New Beetle (98>2001) 370 New Beetle (2001>2005) 370 New Beetle (2005>) 371
186605	D 361	281x15	914	ALFA ROMEO <ul style="list-style-type: none"> 147 (2000>2004) 46 156 (97>2003) 47
* 186607	D 363	262,8x24	914	NISSAN <ul style="list-style-type: none"> Trade (84>) 241
* 186611	D 364	250x22	914	NISSAN <ul style="list-style-type: none"> Vanette (C120) Made in Spain (86>94) Vanette (C220) Made in Spain (86>94)

241

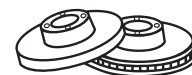

Valeo			\varnothing		
241					
* 186612	D 365		263x24	914	MERCEDES MB100 214
* 186613	D 366		240x22	914	MG MG F (95>2002) 216 MG TF (2002>2005) 216 ROVER 100 (90>98) 299 Maestro (83>95) 301 Metro UK (90>95) 301 Montego (84>94) 301
* 186614	D 367		267x14,2	914	ALFA ROMEO AR8 (80>86) 54 IVECO Daily (78>89) 164 Daily (89>96) 165 Daily (96>99) 165
186617	D 369		257x22	914	HYUNDAI Coupe (95>2001) 157 Elantra (90>95) 157 Elantra (95>2000) 158 Lantra (90>95) 159 Lantra (95>2000) 160
186618	D 370		286x22	914	U.M.M. Alter 4x4 341
186620	D 372		262x12	914	MG MG ZR (2001>2005) 216 ROVER 25 (99>2005) 298 45 (2000>2005) 298 200 (95>99) 299 200 Coupé/Cabriolet (96>99) ... 299 400 (95>2000) 300 Streetwise (2000>2005) 302
186621	D 373		250x12	914	CITROËN XM (89>94) 99 XM (94>2001) 100
186624	D 375		268x10	914	FORD Galaxy (95>2000) 135 Galaxy (2000>2006) 135 SEAT Alhambra (96>2000) 305 Alhambra (2000>2003) 306 VOLKSWAGEN Sharan (95>2000) 377 Sharan (2000>2003) 378 Sharan (2003>2010) 378
* 186625	D 376		280x24	914	OPEL Omega A (86>94) 249 Senator B (87>93) 251 VAUXHALL Carlton (86>94) 346 Senator B (87>93) 351
186628	D 379		287x17	914	SANTANA Vitara 305 SUZUKI Vitara (88>98) 323



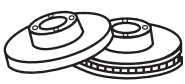





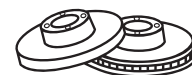







Valeo			\varnothing		
* 186637	D 386		302x20	914	TOYOTA Land Cruiser (BJ40) (80>84) ... 329 Land Cruiser (BJ60) (80>90) ... 329 Land Cruiser (BJ70) (84>2001) .. 329
* 186638	D 387		311x32	914	TOYOTA Land Cruiser (BJ80) (90>98) ... 329
* 186640	D 389		291x25	914	TOYOTA 4 Runner (130) (89>95) 328
* 186642	D 391		304x12,6	914	LAND ROVER Discovery (98>2004) 182 Range Rover (94>2002) 184 Range Rover (2002>) 184
* 186643	D 392		284x22	915	ALFA ROMEO GTV (95>2003) 52 GTV (2003>2006) 52 Spider (95>2003) 53 Spider (2003>2006) 54
* 186644			257x20	915	ALFA ROMEO Spider (95>2003) 53
* 186645	D 394		286x25	915	TOYOTA Land Cruiser (BJ80) (90>98) ... 329
186647	D 395		260x10	915	MITSUBISHI Carisma (95>99) 222 Carisma (99>2003) 222 Space Star (98>) 228 VOLVO S40 (95>2004) 389 V40 (95>2004) 390
186648	D 396		256x24	915	GALLOPER Santamo (98>) 145 HYUNDAI Santamo (98>2001) 156 KIA Joice (99>) 172 MITSUBISHI Sapporo (76>90) 220 Space Runner (91>) 221 MITSUBISHI Carisma (95>99) 222 Carisma (99>2003) 222 Galant (87>92) 224 Galant (92>96) 224 Galant (96>2003) 225 Lancer (CB/CD4) (92>) 225 Space Star (98>) 228 Space Wagon (N3) (91>2000) ... 228 VOLVO S40 (95>2004) 389 V40 (95>2004) 390
* 186652	D 399		255x22	915	TOYOTA Celica (89>93) 334



































Valeo						
* 186653	D 400		277x22	915	GALLOPER Galloper (98>) 145 HYUNDAI Galloper (97>2002) 155 mitsubishi L200 (K1/2/3) (86>2001) 218 Pajero (L0/1) (83>91) 219 Pajero (V2/4) (90>2001) 219 Shogun (L0/1) (83>91) 220 Shogun (V2/4) (90>2001) 220 mitsubishi L300 (P0/1/2/3) 229	
* 186654	D 401		234x7	915	NISSAN 100 NX (B13) (90>94) 232 Almera (N15) (95>2000) 233 Sunny (N14) (90>95) 239	
186655	D 474		280x24	915	RENAULT Clio II (98>2001) 280 Clio II (2001>) 281 Clio III (2005>) 281 Clio III (2009>) 281 Laguna I (98>2000) 284 Laguna I Nevada (98>2000) 285 Mégane (95>99) 287 Mégane (98>2003) 287 Mégane Classic (96>99) 288 Mégane Classic (99>2002) 288 Mégane II (2002>) 289 Mégane Scenic (96>99) 290 Mégane Scenic (99>2003) 291 Scenic II (2003>) 292 Twingo III (2007>) 294 Wind (2010>) 294 RENAULT Kangoo (97>2003) 295 Kangoo (2003>) 296	
* 186664	D 445		258,5x22	915	mitsubishi L200 (K1/2/3) (86>2001) 218	
* 186665	D 446		255,6x20	915	MAZDA B Pick-up (89>99) 187	
186681	D 451		236x13	915	SKODA Favorit (88>95) 315 Felicia (94>2001) 315 Forman (90>95) 315	
186682	D 488		280x24	915	VOLKSWAGEN Sharan (2003>2010) 378 VOLKSWAGEN Transporter (F70) (90>96) 382 Transporter (F7D) (96>2003) 382	

Valeo						
186684	D 490		280x25	915	OPEL Astra G (98>2005) 244 Astra H (2004>) 244 Corsa C (2003>2006) 246 Meriva (2003>) 248 Meriva (2010>) 249 Zafira A (98>2003) 254 Zafira A (2003>2005) 254 Zafira B (2005>2008) 255 Zafira B (2008>) 255 VAUXHALL Astra MK IV (98>2005) 344 Astra MK V (2004>) 345 Corsa MK II (2003>2006) 348 Meriva (2003>) 349 Meriva (2010>) 349 Zafira I (99>2003) 353 Zafira I (2003>2005) 353 Zafira II (2005>2009) 353 Zafira II (2009>) 354	
186685	D 491		313x18	915	ISUZU Trooper (81>97) 164 Trooper (98>) 164 OPEL Frontera A (91>98) 241 Frontera B (98>2005) 242 Monterey (91>99) 242 VAUXHALL Frontera A (91>98) 342 Frontera B (98>2005) 342 Monterey A (94>99) 342 Monterey B (98>99) 342	
186686	D 492		302x18	915	TOYOTA RAV4 (94>2000) 330	
186687	D 493		262x14	915	LAND ROVER Freelander (97>2003) 183	
186688	D 494		280x24	915	OPEL Movano (98>2003) 256 Movano (2003>2006) 256 Movano (2006>) 256 RENAULT Master (97>2003) 296 VAUXHALL Movano (98>2003) 355 Movano (2003>2006) 355 Movano (2006>) 355	
* 186691	D 497		315x18	916	mitsubishi Montero (V2/4) (93>2006) 219 Montero Sport (K9) (98>2009) 219 Pajero (V2/4) (90>2001) 220 Pajero Sport (K9) (98>2009) 220 Shogun (V2/4) (90>2001) 221 mitsubishi Challenger (98>) 222 Space Gear (94>98) 228	
* 186692	D 498		303x16	916	MERCEDES Class G (M460) (79>89) 195 Class G (M461/3) (89>) 195	



Valeo		 Ø 		   
186693	D 499	 283x26	916	CITROËN  C3 (2005>) 93 C3 (2009>) 93 C3 Picasso (2009>) 93 C4 (2004>) 93 C4 Picasso (2006>) 94 C5 (2001>2008) 94 DS3 (2010>) 96 Xsara (2000>2005) 100 Xsara Picasso (99>) 101
				CITROËN  Berlingo (2002>) 101 Berlingo (2008>) 102
				PEUGEOT  1007 (2005>) 258 206 (98>) 260 207 (2006>) 261 307 (2001>2005) 263 307 (2005>) 263 308 (2007>) 264 3008 (2009>) 264 5008 (2009>) 267
				PEUGEOT  Partner (2002>) 271 Partner (2008>) 271 Ranch (2002>) 272
186694	D 500	 247x9	916	CITROËN  C2 (2003>2010) 92 C3 (2002>2005) 92 C3 (2005>) 93 C3 Pluriel (2003>) 93 C4 (2004>) 94 Xsara Picasso (99>) 101
				CITROËN  Berlingo (2002>) 102
				PEUGEOT  1007 (2005>) 258 307 (2001>2005) 263 307 (2005>) 263
				PEUGEOT  Partner (2002>) 271 Ranch (2002>) 272



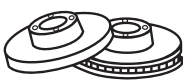



















Valeo		 Ø 		   
186695	D 501	 266x22	916	CITROËN  C2 (2003>2010) 92 C3 (2002>2005) 92 C3 (2005>) 93 C3 (2009>) 93 C3 Pluriel (2003>) 93 C3 Picasso (2009>) 93 C4 (2004>) 93 C5 (2001>2008) 94 DS3 (2010>) 96 Xsara (2000>2005) 100 Xsara Picasso (99>) 100
				CITROËN  Berlingo (96>2002) 101 Berlingo (2002>) 101
				PEUGEOT  1007 (2005>) 258 206 (98>) 260 207 (2006>) 261 307 (2001>2005) 263 307 (2005>) 263
				PEUGEOT  Partner (96>2002) 271 Partner (2002>) 271 Ranch (96>2002) 271 Ranch (2002>) 272
186696	D 502	 257x25	916	TOYOTA  Hilux (83>98) 328 Hilux (2001>) 328
				VOLKSWAGEN  Taro (89>97) 381
186697	D 503	 296x22	916	BMW  Series 5 (E39) (95>2004) 81
* 186699	D 504	 260x23	916	HONDA  Accord VI (98>2003) 147 Prelude (91>96) 154 Prelude (96>2001) 154
* 186701	D 506	 255x22	916	TOYOTA  Corolla (100) (92>97) 335 Corolla (110) (97>99) 335 Corolla (110) (99>2001) 335
186702	D 507	 283x26	916	PEUGEOT  607 (2000>2004) 268
186703	D 508	 309x32	916	PEUGEOT  607 (2000>2004) 268
* 186704	D 509	 319x22	916	TOYOTA  4 Runner (180) (95>2002) 328 Land Cruiser (KZ/VZ9) (96>2002) . 329
186705	D 510	 260x25	916	TOYOTA  Avensis (97>2000) 331 Avensis (2000>2003) 331
186707	D 512	 281x24	916	MITSUBISHI  Carisma (99>2003) 222
				VOLVO  S40 (95>2004) 389 V40 (95>2004) 390











Valeo												
186708	D 525	280x16		916	CITROËN	Jumper (2002>2006) 103 Relay (2002>2006) 104	FIAT	Ducato (2002>2006) 127 Ducato RU (2008>) 128	PEUGEOT	Boxer I (2002>2006) 269		
186709	D 526	276x24		916	FORD	Transit (2000>2006) 143						
186710	D 527	294x24		916	FORD	Transit (2000>2006) 143						
186712	D 529	305,5x28		916	NISSAN	Primastar (2002>2006) 240 Primastar (2006>) 240	OPEL	Vivaro (2001>2006) 257 Vivaro (2006>) 257	RENAULT	Trafic II (2001>2006) 298 Trafic II (2006>) 298	VAUXHALL	Vivaro (2001>2006) 355 Vivaro (2006>) 355
186713		280x12		917	NISSAN	Primastar (2002>2006) 240 Primastar (2006>) 240	OPEL	Vivaro (2001>2006) 257 Vivaro (2006>) 257	RENAULT	Trafic II (2001>2006) 298 Trafic II (2006>) 298	VAUXHALL	Vivaro (2001>2006) 355 Vivaro (2006>) 356
186714	D 531	236x12,8		917	SKODA	Favorit (88>95) 315 Forman (90>95) 315						
186715	D 532	280x24		917	RENAULT	Laguna II (2001>2005) 286 Laguna II (2005>2007) 286						
186717	D 534	308x28		917	RENAULT	Laguna II (2001>2005) 286 Laguna II (2005>2007) 286						
186718		274x11		917	RENAULT	Laguna II (2001>2005) 286 Laguna II (2005>2007) 286 Grand Scenic II (2003>) 293						

Valeo												
186719	D 536	276x24		917	MITSUBISHI	L200 (K1/2/3) (86>2001) 218 L200 (K6/7) (96>2007) 218 Montero (V2/4) (93>2006) 219 Montero Sport (K9) (98>2009) ... 219 Pajero (V2/4) (90>2001) 219 Pajero Sport (K9) (98>2009) 220 Shogun (V2/4) (90>2001) 220	MITSUBISHI	Challenger (98>) 222				
186720		274x10,9		917	RENAULT	Mégane (98>2003) 288 Mégane Scenic (99>2003) 291 Grand Scenic II (2003>) 293						
186724	D 541	272x12		917	CITROËN	C8 (2002>) 95	FIAT	Ulysse (2002>) 124	LANCIA	Phedra (2002>) 179	PEUGEOT	807 (2002>) 269
186725	D 542	282x18		917	VOLKSWAGEN	Transporter (F7D) (96>2003) 382						
186727	D 544	235x20		917	DACIA	SuperNova (2000>2003) 106 Solenza (2003>2005) 106						
186728	D 545	280x28		917	NISSAN	X-Trail (T30) (2001>2003) 231 X-Trail (T30) (2003>2007) 232	NISSAN	Almera Tino (V10M) (2000>2003) 234 Almera Tino (V10B) (2003>2005) . 234 Maxima QX (CA33) (2000>2006) . 236 Primera (P12/W12) (2001>) 237				
186729	D 546	232x9		917	SEAT	Arosa (97>2004) 307 Cordoba (96>99) 308 Cordoba (99>2002) 308 Ibiza (99>2001) 310	VOLKSWAGEN	Lupo (98>2005) 370 Polo VI (99>2001) 375				
186730	D 547	282x24		917	CHRYSLER	Voyager III (96>2001) 90 Grand Voyager (96>2001) 90						
186731	D 548	325x25		917	BMW	Series 3 (E46) (98>2006) 77 Z4 (E85/86) (2002>2009) 86						
186732	D 549	310x24		917	BMW	Series 5 (E60/61) (2003>) 81						
186734	D 551	280x23		917	CHRYSLER	PT Cruiser (2000>2009) 89						
186736	D 553	275x14		917	CITROËN	C5 (2001>2008) 95						



Valeo		 Ø 						
186740	D 557	 305x12	917	NISSAN  Interstar (2002>2006) 240 Interstar (2006>) 240 OPEL  Movano (98>2003) 256 Movano (2003>2006) 256 Movano (2006>) 257 RENAULT  Master (97>2003) 296 Master (2003>2006) 296 Master (2006>) 296 VAUXHALL  Movano (98>2003) 355 Movano (2003>2006) 355 Movano (2006>) 355				
				186741	D 558	 305x28	918	VOLVO  XC 70 (2000>2007) 384 VOLVO  S60 (2000>) 390 V70 (2000>2007) 392 S80 (98>2006) 393
								186742
				186743	D 560	 256x24	918	
186744	D 561	 240,5x20	918					FIAT  500 Nuova (2007>) 112 Panda (2003>) 118 FORD  Ka (2008>) 137
				186745	D 562	 281x26	918	ALFA ROMEO  MiTo (2008>) 52 FIAT  Bravo II (2007>) 113 Stilo (2001>2003) 121 Stilo (2004>) 122 LANCIA  Delta (2008>) 177
186746	D 563	 283x26	918					PEUGEOT  407 (2004>) 266
								186747
186748	D 565	 278x24	918					



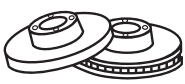































Valeo		 Ø 		
186750	D 567	 300x24	918	FORD  Mondeo (2000>2003) 137 Mondeo (2003>2005) 138 Mondeo (2005>2007) 138 JAGUAR  X-Type (2001>2008) 168
				186751
186753	D 570	 285x15	918	
				186754



























Valeo						
186755	D 572	288x25	918	AUDI A3 (2003>2008) 60 A3 (2008>) 60 A3 Cabriolet (2008>) 61 SEAT Altea (2004>) 306 Leon (2005>) 311 Toledo (2004>) 313 SKODA Yeti (2009>) 313 SKODA Octavia (2004>2008) 316 Octavia (2008>) 316 Superb (2001>2008) 317 Superb (2008>) 317 VOLKSWAGEN Eos (2006>) 360 Golf V (2003>) 367 Golf VI (2008>) 368 Golf Plus (2005>) 368 Golf Plus (2009>) 369 Jetta III (2005>) 370 Scirocco (2008>) 377 Touran I (2003>2006) 378 Touran II (2006>2010) 378 Touran III (2010>) 379 VOLKSWAGEN Caddy III (2004>) 380		
186756	D 573	308x29,5	918	VOLKSWAGEN Touareg I (2002>2006) 356 Touareg II (2006>2010) 357 VOLKSWAGEN Transporter (7J/7H) (2003>2009) 383 Transporter (7E/7F) (2009>) 383		
186757	D 574	240x11	918	OPEL Corsa C (2000>2003) 246 Corsa C (2003>2006) 246 VAUXHALL Corsa MK II (2000>2003) 348 Corsa MK II (2003>2006) 348		
186758	D 575	312x25	918	AUDI A4 (2000>2004) 62 A4 (2004>2008) 62 A4 Cabriolet (2002>2005) 63 A4 Cabriolet II (2006>2009) 63 A6 (97>2001) 64 A6 (2001>2005) 64 S4 (2004>2008) 70 SEAT Exeo (2008>) 308 SKODA Superb (2001>2008) 317 VOLKSWAGEN Passat VI (2000>2005) 373		

Valeo						
186759	D 576	260,5x24	918	OPEL Corsa C (2000>2003) 246 Corsa C (2003>2006) 246 Meriva (2003>) 248 Tigra Twintop (2004>2008) 252 OPEL Combo/Combo Tour (2001>) 256 VAUXHALL Corsa MK II (2000>2003) 348 Corsa MK II (2003>2006) 348 Meriva (2003>) 349 Tigra Twintop (2004>2008) 351 VAUXHALL Astramax (91>98) 354 Combo (2001>) 354		
186760	D 577	258x8	918	MERCEDES Class A (W168) (97>2004) 199 Vaneo (2001>) 214		
186761		300x11	919	RENAULT Espace IV (2002>2006) 283 Espace IV (2006>) 283 Vel Satis (2002>2005) 294 Vel Satis (2005>) 294		
186762	D 579	276x22	919	MINI MINI (R50/52/53) (2001>) 217		
186764	D 581	260x22	919	DACIA Logan (2004>) 106 NISSAN Micra (K12E) (2003>2005) 236 Micra (K12E) (2005>) 236 Note (E11E) (2005>2007) 236 Note (E11E) (2008>) 236 RENAULT Clio III (2005>) 281 Clio III (2009>) 281 Mégane II (2002>) 289 Modus (2004>2008) 291 Modus (2008>) 291		
186765	D 582	275x25	919	TOYOTA RAV4 (2000>2005) 330		
186766	D 583	255x20	919	TOYOTA MR 2 (99>2005) 337 Yaris Made in Japan (99>2005) ... 339 Yaris Made in France (2001>2005) 340 Yaris Verso (99>) 340		
186768	D 585	238x8	919	RENAULT R19 (88>92) 277 R19 (92>95) 277 Clio II (98>2001) 280 Clio II (2001>) 281 Mégane (95>99) 287 Mégane (98>2003) 288 Mégane Classic (99>2002) 288		
* 186770	D 587	258x16	919	VOLKSWAGEN Transporter (F24) (79>92) 381		
* 186771	D 588	278x12,9	919	VOLKSWAGEN Transporter (F24) (79>92) 381		



Valeo				
186773	D 590		245x10	919 <p>AUDI </p> A4 (94>98) 61 A4 (99>2001) 62 S4 (97>99) 69 <p>VOLKSWAGEN </p> Passat V (96>2000) 373 Passat VI (2000>2005) 373
* 186774	D 591		276x22	919 <p>MERCEDES </p> Sprinter (95>2006) 214 <p>VOLKSWAGEN </p> LT II (96>2003) 380 LT III (2003>2006) 381
186775	D 592		238x8	919 <p>RENAULT </p> Clio I (90>96) 280 Clio I (96>98) 280 Lutecia (Japan) (94>98) 287
* 186776	D 593		262,5x22	919 <p>VOLVO </p> 740 (84>92) 387
186777	D 594		230x11	919 <p>HYUNDAI </p> Atos/Atoz (98>2001) 157
186778	D 595		282x23	919 <p>HONDA </p> CR-V (97>2002) 145 <p>HONDA </p> HR-V (98>2005) 152 Integra (97>2001) 152 Legend (90>96) 153 Legend (96>2006) 153 Odyssey (97>) 153 Prelude (96>2001) 154 Shuttle (94>2000) 155
186780	D 597		282x25	919 <p>HONDA </p> Accord VI (98>2003) 147
186781	D 598		239x20	919 <p>LADA </p> 110 (95>) 174 Sagona (91>) 175 Samara (86>) 175 Vega 175
186783	D 600		276x22	919 <p>MERCEDES </p> Class A (W168) (97>2004) 199
186784	D 601		247x12	919 <p>OPEL </p> Agila (2000>2007) 242 <p>SUZUKI </p> Wagon R+ (2000>) 325 <p>VAUXHALL </p> Agila (2000>2007) 342
186785	D 602		289x10	920 <p>PEUGEOT </p> 607 (2000>2004) 268
186786	D 603		280,5x12	920 <p>RENAULT </p> Kangoo (97>2003) 295 Kangoo (2003>) 296
186788	D 605		239x14,9	920 <p>AUDI </p> A2 (2000>2005) 59 <p>VOLKSWAGEN </p> Lupo (98>2005) 370



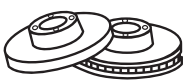





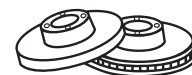



















Valeo				
186789	D 606		286x26	920 <p>VOLVO </p> XC 70 (2000>2007) 384 <p>VOLVO </p> S60 (2000>) 390 V70 (2000>2007) 392 S80 (98>2006) 393
186790	D 607		240x20	920 <p>OPEL </p> Corsa C (2000>2003) 246 Corsa C (2003>2006) 246 <p>VAUXHALL </p> Corsa MK II (2000>2003) 348 Corsa MK II (2003>2006) 348
186791	D 608		240x10,2	920 <p>OPEL </p> Corsa C (2000>2003) 246 Corsa C (2003>2006) 246 Tigra Twintop (2004>2008) 252 <p>VAUXHALL </p> Corsa MK II (2000>2003) 348 Corsa MK II (2003>2006) 348 Tigra Twintop (2004>2008) 351
186796			240x8	920 <p>RENAULT </p> Clio III (2005>) 281 Clio III (2009>) 282 Mégane II (2002>) 289 Modus (2004>2008) 291 Modus (2008>) 291 Twingo III (2007>) 294 Wind (2010>) 294
186797	D 614		276x10	920 <p>ALFA ROMEO </p> 147 (2000>2004) 47 147 (2004>) 47 156 (97>2003) 48 156 (2003>2007) 48 GT (2003>) 51
186798	D 615		276x12	920 <p>MERCEDES </p> Class A (W169) (2004>2008) 199 Class A (W169) (2008>) 199
186799	D 616		276x22	920 <p>MERCEDES </p> Class A (W169) (2004>2008) 199 Class A (W169) (2008>) 199 Class B (W245) (2005>2008) 199 Class B (W245) (2008>) 200
186800	D 617		313x25,9	920 <p>FORD </p> Galaxy (2000>2006) 135 <p>SEAT </p> Alhambra (2000>2003) 306 Alhambra (2003>2010) 306 <p>VOLKSWAGEN </p> Sharan (2000>2003) 378 Sharan (2003>2010) 378 <p>VOLKSWAGEN </p> Transporter (F7D) (96>2003) 383





























Valeo				
186801	D 618	294x13,6	920	FORD Galaxy (2000>2006) 135 SEAT Alhambra (2000>2003) 306 Alhambra (2003>2010) 306 VOLKSWAGEN Sharan (2000>2003) 378 Sharan (2003>2010) 378 VOLKSWAGEN Transporter (F7D) (96>2003) 382
186802	D 619	259x12	920	DACIA Logan (2004>) 105 Sandero (2008>) 106 RENAULT Twingo III (2007>) 294
186803	D 620	238x12	920	DACIA Logan (2004>) 105 Sandero (2008>) 106
186804	D 623	324x28	920	RENAULT Espace IV (2002>2006) 283 Espace IV (2006>) 283 Vel Satis (2002>2005) 294 Vel Satis (2005>) 294
186805	D 624	253x17	920	OPEL Agila (2000>2007) 242 SUBARU Justy G3X (2003>) 321 SUZUKI Ignis (2003>) 324 Wagon R+ (2000>) 325 VAUXHALL Agila (2000>2007) 342
186807	D 627	245x10	920	AUDI 80 (91>95) 56 A4 (2000>2004) 62 A4 (2004>2008) 62 A4 Cabriolet (2002>2005) 63 A4 Cabriolet II (2006>2009) 63 Coupé (88>96) 68 SEAT Exeo (2008>) 308
186808	D 628	332x30	920	BMW X3 (2006>) 74 X5 (2000>2006) 74
186809	D 629	324x12	921	BMW X5 (2000>2006) 74
186810	D 631	258x24	921	MAZDA 323 (BJ) (98>2000) 191 323 (BJ) (2000>2003) 191
186811	D 632	345x31,9	921	MERCEDES Class ML (163) (97>2005) 195

Valeo				
186812	D 633	259x9,9	921	MINI MINI (R50/52/53) (2001>) 217 MINI (R56/57) (2006>) 217 MINI (R56/57) (2009>) 217 MINI Clubman (2007>) 217 MINI Clubman (2009>) 218
186813	D 634	290x26	921	MITSUBISHI Pajero (VD/VF) (2000>2006) 220 Shogun (V6/7) (2000>2006) 221
186814	D 635	284x22	921	ROVER 75 (99>2005) 298
186815	D 636	300x22	921	BMW Series 3 (E46) (98>2006) 77 Z3 (E36) (96>2002) 86 Z4 (E85/86) (2002>2009) 86
186816	D 637	284x22	921	BMW Series 1 (E87) (2004>) 75 Series 1 (E81/82/88) (2007>) 75
186817	D 638	292x22	921	BMW Series 1 (E87) (2004>) 75 Series 1 (E81/82/88) (2007>) 75 Series 3 (E90/91/92/93) (2005>) .. 78
186818	D 639	236x18	921	MITSUBISHI Carisma (95>99) 222 Colt (91>96) 223 Colt (95>2003) 223 Lancer (CB/CD4) (92>) 225 Lancer (CK1/CP) (95>) 225 Lancer F (CB/CD) (91>96) 226 PROTON 300 (96>) 273 400 (93>) 273
186819	D 640	278x25	921	FORD Focus (2004>) 133 Focus II (2007>) 134 Focus C-Max (2003>2007) 134 Focus C-Max (2007>) 134 Focus Coupé Cabriolet (2006>) .. 135 VOLVO C30 (2006>) 389 S40 (2004>) 389 V50 (2004>) 390 C70 CC (2006>) 391
186821	D 642	280x22	921	NISSAN Almera (N16E) (2000>2003) 233 Almera (N16E) (2003>2006) 233 Primera (P11/W11) (96>2002) ... 237
186822	D 643	255x28	921	TOYOTA Carina E (92>97) 333
186823	D 644	257x24	921	HYUNDAI Coupe (95>2001) 157 Elantra (95>2000) 158 Lantra (95>2000) 160 Sonata (98>2001) 161 Sonata (98>2001) 161
186824	D 645	294x26	921	HYUNDAI Santa Fé (2000>2006) 155



Valeo				
186825	D 646		257x24	921 HYUNDAI  Elantra (2000>2007) 158 Matrix (2001>2008) 160 Matrix (2008>) 160
186827	D 647		235x20	921 SUZUKI  Baleno (95>) 323
186829	D 648		280x26	921 HYUNDAI  Elantra (2000>2007) 158 Sonata (2001>2005) 161
186833	D 649		260x12	922 AUDI  A3 (2003>2008) 60
				SEAT  Altea (2004>) 307
				SKODA  Octavia (2004>2008) 316 Octavia (2008>) 317 Superb (2008>) 317
				VOLKSWAGEN  Golf V (2003>) 368 Golf VI (2008>) 368 Jetta III (2005>) 370 Scirocco (2008>) 377 Touran I (2003>2006) 378 Touran II (2006>2010) 378
				VOLKSWAGEN  Caddy III (2004>) 380
186834	D 650		280x12	922 FORD  Mondeo (2000>2003) 137 Mondeo (2003>2005) 138 Mondeo (2005>2007) 138
				JAGUAR  X-Type (2001>2008) 168
186839	D 651		272x9,9	922 BMW  Series 3 (E36) (90>2001) 77
186840			249x9	922 CITROËN  C4 (2004>) 94
				PEUGEOT  307 (2001>2005) 263 307 (2005>) 263
186841	D 653		288x12	922 VOLVO  XC 70 (2000>2007) 384
				VOLVO  S60 (2000>) 391 V70 (2000>2007) 393 S80 (98>2006) 393
186842	D 654		265x11	922 FORD  Focus (2004>) 133 Focus C-Max (2003>2007) 134 Focus C-Max (2007>) 134 Focus Coupé Cabriolet (2006>) .. 135

Valeo							
186843	D 655		280x10,9	922 FORD  Focus (2004>) 133 Focus C-Max (2003>2007) 134 Focus C-Max (2007>) 135 Focus Coupé Cabriolet (2006>) .. 135			
				VOLVO  C30 (2006>) 389 S40 (2004>) 390 V50 (2004>) 390 C70 CC (2006>) 391			
186844	D 656		278x11	922 FORD  Tourneo Connect (2002>2006) .. 142 Tourneo Connect (2006>) 142 Transit Connect (2002>2006) 144 Transit Connect (2006>) 144			
				NISSAN  Primera (P11/W11) (96>2002) ... 237			
186845	D 657		278x10	922 NISSAN  Primera (P11/W11) (96>2002) ... 237			
186846	D 658		240x7	922 NISSAN  Micra (K11E) (92>2000) 236 Micra (K11E) (2000>2002) 236			
186847	D 659		269x9	922 TOYOTA  Corolla (120) (2001>2007) 336 Corolla Verso (2001>2003) 336 Prius (2000>2003) 338 Yaris Made in Japan (99>2005) .. 339 Yaris Made in France (2001>2005) 340 Yaris Verso (99>) 340			
				TOYOTA  Corolla (120) (2001>2007) 336			
186848	D 660		258x9	922 TOYOTA  Corolla (120) (2001>2007) 336			
186849	D 661		280x10	922 TOYOTA  Avensis (2003>2008) 332			
186850	D 662		288x10	922 TOYOTA  Avensis (97>2000) 331 Avensis (2000>2003) 331			
				TOYOTA  Avensis (97>2000) 331 Avensis (2000>2003) 331			
186851	D 663		280x10	922 MAZDA  6 (2002>2007) 189 6 (2007>) 190 323 (BJ) (2000>2003) 191 626 Wagon (GW) (97>99) 192 626 Wagon (GW) (99>2002) 193 MX5 (2005>) 194 Premacy (2001>2005) 194			
				RENAULT  Mégane II (2002>) 289 Scenic II (2003>) 292			
				RENAULT  Mégane II (2002>) 289 Scenic II (2003>) 292			

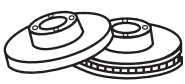

Valeo								
186854	D 666	278x11,9	922	FIAT	Croma II (2005>2007) 115	Croma II (2007>) 115		
				OPEL	Signum A (2003>2005) 251	Signum B (2005>2008) 251	Vectra C (2002>2005) 254	Vectra C (2005>2009) 254
				SAAB	9-3 (2002>) 303			
				VAUXHALL	Signum A (2003>2005) 351	Signum B (2005>2008) 351	Vectra (2002>2005) 352	Vectra (2005>2009) 352
186855	D 667	264x10	922	OPEL	Meriva (2003>) 248			
				OPEL	Combo/Combo Tour (2001>) ... 256			
				VAUXHALL	Meriva (2003>) 349			
				VAUXHALL	Combo (2001>) 354			
186856	D 668	255x11,9	923	AUDI	A4 (2000>2004) 62	A4 (2004>2008) 63	A4 Cabriolet II (2006>2009) 63	
				SEAT	Exeo (2008>) 308			
186857	D 669	255x10	923	AUDI	A3 (2003>2008) 60	A3 (2008>) 61	A3 Cabriolet (2008>) 61	
				SEAT	Altea (2004>) 306	Leon (2005>) 312	Toledo (2004>) 313	
				SKODA	Yeti (2009>) 314			
				SKODA	Octavia (2004>2008) 316	Octavia (2008>) 317		
				VOLKSWAGEN	Eos (2006>) 360	Golf V (2003>) 368	Golf VI (2008>) 368	
					Golf Plus (2005>) 369	Golf Plus (2009>) 369	Scirocco (2008>) 377	
				VOLKSWAGEN	Caddy III (2004>) 380			
186858	D 670	296x10	923	MERCEDES	Viano (2003>) 215	Vito (2003>) 216		
186859	D 671	280x9	923	SMART MCC	Crossblade (2002>) 318	Fortwo (98>2006) 318	Roadster (2003>2005) 318	



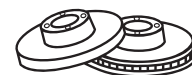





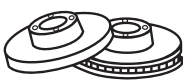





































Valeo								
186860	D 672	298x20	923	BMW	Series 5 (E39) (95>2004) 81			
186861	D 673	294x18,9	923	BMW	Series 3 (E46) (98>2006) 78			
186863	D 675	300x25	923	FORD	Focus (2004>) 133	Focus II (2007>) 134	Focus C-Max (2003>2007) 134	
					Focus C-Max (2007>) 134	Focus Coupé Cabriolet (2006>) .. 135	Kuga (2008>) 137	
				VOLVO	C30 (2006>) 389	S40 (2004>) 389	V50 (2004>) 390	C70 CC (2006>) 391
186864	D 676	288x25	923	MERCEDES	Class C (W203) (2000>2003) 201	Class C (W203) (2004>) 201	Class CLC (W203) (2008>) 203	
					Class CLK (W208) (97>2003) 203	Class CLK (W209) (2002>2009) .. 204	Class SLK (171) (2004>2007) ... 213	
				MERCEDES	Class GLK (2008>) 195			
					Class CLS (W219) (2004>2008) .. 204	Class CLS (W219) (2008>) 205	Class E (W211) (2002>2006) 207	
					Class E (W211) (2006>2009) 208	Class E (207-212) (2009>) 208		
186866	D 678	240x21	923	HONDA	Jazz II (J) (2002>2008) 152			
186868	D 679	306x28	923	NISSAN	Interstar (2002>2006) 240	Interstar (2006>) 240		
				OPEL	Movano (98>2003) 256	Movano (2003>2006) 256	Movano (2006>) 256	
				RENAULT	Master (97>2003) 296	Master (2003>2006) 296	Master (2006>) 296	
				VAUXHALL	Movano (98>2003) 355	Movano (2003>2006) 355	Movano (2006>) 355	
186869	D 680	280x25	923	OPEL	Astra H (2004>) 244	Meriva (2003>) 248		
				VAUXHALL	Astra MK V (2004>) 344	Meriva (2003>) 349		
186871	D 682	277x20,9	923	LAND ROVER	Freelander (97>2003) 183	Freelander (2003>2006) 183		





































Valeo			\varnothing		
186872	D 683		278x25	923	MAZDA 3 (2003>2006) 188 3 (2006>) 188 3 (2008>) 189 5 (2005>) 189
186874	D 685		229x15,9	923	TOYOTA Starlet (89>95) 338 Starlet (96>99) 339
186875	D 686		238x18	923	TOYOTA Paseo (95>99) 337 Starlet (89>95) 339 Starlet (96>99) 339
186876	D 687		275x28	923	TOYOTA Avensis (97>2000) 331 Avensis (2000>2003) 331 Celica (93>99) 334
186877	D 688		255x25	923	TOYOTA Corolla (120) (2001>2007) 336 Corolla Verso (2001>2003) 336
186878	D 689		256x19	924	HYUNDAI Getz (2002>2005) 158
186879	D 703		241x19	924	HYUNDAI Getz (2002>2005) 158 Getz (2005>) 158
186880	D 690		302x28	924	CADILLAC BLS (2005>) 87
					OPEL Signum A (2003>2005) 251 Signum B (2005>2008) 251 Vectra C (2002>2005) 253 Vectra C (2005>2009) 254
					SAAB 9-3 (2002>) 302
					VAUXHALL Signum A (2003>2005) 351 Signum B (2005>2008) 351 Vectra (2002>2005) 352 Vectra (2005>2009) 352
					FIAT Croma II (2005>2007) 115 Croma II (2007>) 115
186881	D 691		285x24,9	924	CADILLAC BLS (2005>) 87
					FIAT Croma II (2005>2007) 115 Croma II (2007>) 115
					OPEL Signum A (2003>2005) 251 Signum B (2005>2008) 251 Vectra C (2002>2005) 253 Vectra C (2005>2009) 254
					SAAB 9-3 (2002>) 302
					VAUXHALL Signum A (2003>2005) 351 Signum B (2005>2008) 351 Vectra (2002>2005) 352 Vectra (2005>2009) 352









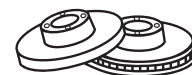

























Valeo			\varnothing		
186882	D 692		292x19,9	924	FIAT Croma II (2005>2007) 115 Croma II (2007>) 115
					OPEL Signum A (2003>2005) 251 Signum B (2005>2008) 251 Vectra C (2002>2005) 254 Vectra C (2005>2009) 254
					SAAB 9-3 (2002>) 303
					VAUXHALL Signum A (2003>2005) 351 Signum B (2005>2008) 351 Vectra (2002>2005) 352 Vectra (2005>2009) 353
					BMW Series 3 (E46) (98>2006) 78
186883	D 693		320x21,8	924	BMW Series 3 (E46) (98>2006) 78
186884	D 694		324x30	924	BMW Series 5 (E39) (95>2004) 81
186885	D 695		333x32,5	924	VOLKSWAGEN Transporter (7J/7H) (2003>2009) . 383
186886	D 696		294x21,9	924	VOLKSWAGEN Transporter (7J/7H) (2003>2009) . 383 Transporter (7E/7F) (2009>) 383
					SKODA Fabia (99>2004) 314 Fabia (2006>) 315
186888	D 698		239x17,9	924	SKODA Fabia (99>2004) 314 Fabia (2006>) 315
					VOLKSWAGEN Fox (2004>) 360 Polo VII (2001>) 376 Polo VIII (2005>) 376
					MERCEDES Viano (2003>) 215 Vito (2003>) 215
● 186893	D 708		300x11	924	RENAULT Espace IV (2002>2006) 283 Espace IV (2006>) 283 Vel Satis (2002>2005) 294 Vel Satis (2005>) 294
					RENAULT Vel Satis (2002>2005) 294
● 186894	D 709		300x11	924	RENAULT Vel Satis (2002>2005) 294
186895	D 710		274x11	924	RENAULT Mégane (98>2003) 288 Mégane Scenic (99>2003) 291
186896	D 711		274x11	924	RENAULT Laguna II (2001>2005) 286 Laguna II (2005>2007) 286 Grand Scenic II (2003>) 293
					RENAULT Clio III (2005>) 281 Clio III (2009>) 282 Mégane II (2002>) 290 Modus (2004>2008) 291 Modus (2008>) 291 Twingo III (2007>) 294 Wind (2010>) 295
					RENAULT Clio III (2005>) 281 Clio III (2009>) 282 Mégane II (2002>) 290 Modus (2004>2008) 291 Modus (2008>) 291 Twingo III (2007>) 294 Wind (2010>) 295



























Valeo		 \varnothing 		   
186898	D 713	 270x10	924	RENAULT  Mégane II (2002>) 289 Scenic II (2003>) 292
186899	D 714	 249x9	924	CITROËN  C4 (2004>) 94 PEUGEOT  307 (2001>2005) 263 307 (2005>) 263
187029	D 403	 280x16	925	IVECO  Daily (78>89) 164 Daily (89>96) 165
187040	D 405	 289x22	925	IVECO  Daily (96>99) 165 Daily (99>) 166
187045	D 513	 272x16	925	MERCEDES  Class G (M461/3) (89>) 195 MERCEDES  Sprinter (95>2006) 214 VOLKSWAGEN  LT II (96>2003) 380 LT III (2003>2006) 381
187058	D 514	 290x22	925	IVECO  Daily (96>99) 165 Daily (99>) 165
● 187061	D 515	 290x22	925	RENAULT  Master Propulsion I (99>2004) ... 297 Master Propulsion II (2004>) 297 RVI  Mascott (99>) 302
● 187130		 306x22	925	IVECO  Daily (99>) 166
● 187141	D 800	 300x28	925	MERCEDES  Sprinter II (2006>) 215 VOLKSWAGEN  Crafter (2006>) 380
● 187146		 303x28	925	MERCEDES  Sprinter II (2006>) 215
● 187147		 276x22	925	IVECO  Daily (99>) 165
● 187148		 276x16	925	IVECO  Daily (99>) 166
● 187149		 276x16	925	IVECO  Daily (99>) 166
● 187152		 280x16	925	FORD  Transit (2006>) 144
187154		 300x28	925	IVECO  Daily (2006>) 166
187155		 290x28	925	IVECO  Daily (2006>) 166
197000	D 715	 274x11	925	RENAULT  Grand Scenic II (2003>) 293

Valeo		 \varnothing 		   
● 197001	D 716	 280x12	925	NISSAN  Primastar (2002>2006) 240 Primastar (2006>) 240 OPEL  Vivaro (2001>2006) 257 Vivaro (2006>) 257 RENAULT  Trafic II (2001>2006) 298 Trafic II (2006>) 298 VAUXHALL  Vivaro (2001>2006) 355 Vivaro (2006>) 356
● 197002	D 717	 249x9	925	CITROËN  C3 (2009>) 93 C3 Picasso (2009>) 93 C4 (2004>) 94 DS3 (2010>) 96 PEUGEOT  207 (2006>) 261 307 (2005>) 263
● 197003	D 718	 300x11	925	RENAULT  Vel Satis (2002>2005) 294
● 197004	D 719	 278x32,2	926	OPEL  Sintra (96>99) 251 VAUXHALL  Sintra (96>99) 351
● 197008	D 723	 264x10	926	ABARTH  Grande Punto (2007>) 44 Punto Evo (2010>) 44 FIAT  Grande Punto (2005>) 120 Punto Evo (2009>) 120
● 197009	D 724	 286x10	926	SAAB  9-5 (97>2001) 303 9-5 (2001>2005) 303 9-5 (2005>) 303
● 197010	D 725	 290x12	926	PEUGEOT  407 (2004>) 266
● 197011	D 726	 239x8,9	926	AUDI  A3 (96>2000) 60 A3 (2000>2003) 60 TT (98>2006) 72 SKODA  Octavia (96>2000) 316 Octavia (2000>) 316 VOLKSWAGEN  Bora (98>2005) 358 Golf IV (97>2006) 367
● 197013	D 728	 278x10,9	926	FORD  Tourneo Connect (2002>2006) .. 142 Tourneo Connect (2006>) 142 Transit Connect (2002>2006) 144 Transit Connect (2006>) 144
● 197014	D 729	 260x9	926	HONDA  Civic (EP) (2001>2006) 150



Valeo				
● 197015	D 730		260x10	926 HONDA  Accord VI (98>2003) 147
● 197016	D 731		280x9,8	926 MG  MG ZT (2001>2005) 217 ROVER  75 (99>2005) 298
● 197017	D 732		354x11,9	926 LAND ROVER  Range Rover (2002>) 184
● 197018	D 733		291x12	926 TOYOTA  Avensis Verso (2001>2005) 332 Picnic (2001>2005) 338 Previa (2000>) 338
● 197019	D 734		279x9	926 TOYOTA  Corolla (120) (2001>2007) 336
● 197020	D 735		261x10	926 MAZDA  323 (BJ) (2000>2003) 191
● 197021	D 736		265x11	926 MAZDA  3 (2003>2006) 188 3 (2006>) 188 3 (2008>) 189
● 197022	D 737		290x12,5	926 CHRYSLER  Voyager IV (2001>) 90 Voyager V (2004>) 90 Grand Voyager (2001>2004) 90 Grand Voyager (2004>2008) 91 JEEP  Cherokee (2004>) 169 Wrangler (96>2006) 170
● 197023	D 738		280x16	926 CITROËN  Jumper II (2006>) 103 Relay II (2006>) 105 FIAT  Ducato (2006>) 127 PEUGEOT  Boxer II (2006>) 270
● 197027	D 742		284x10	926 HYUNDAI  Santa Fé (2000>2006) 155 Tucson (2004>) 156 HYUNDAI  Trajet (2000>2004) 162 Trajet (2004>) 162 HYUNDAI  Highway Van (2000>2004) 163 KIA  Sportage (2004>) 170
● 197028	D 743		257x12	926 FIAT  Grande Punto (2005>) 120 OPEL  Corsa D (2006>) 246 VAUXHALL  Corsa MK III (2006>) 348

Valeo				
● 197029	D 744		262x10	927 HYUNDAI  Accent TR (2005>) 156 Getz (2002>2005) 158 Getz (2005>) 159 i20 (2008>) 159 KIA  Rio (2005>2008) 173
● 197030	D 745		298x16	927 MERCEDES  Sprinter II (2006>) 215 VOLKSWAGEN  Crafter (2006>) 380
● 197031	D 746		286x12	927 AUDI  A3 (2003>2008) 60 A3 (2008>) 61 A3 Cabriolet (2008>) 61 S3 (98>2003) 69 SEAT  Alhambra (2010>) 306 Altea (2004>) 307 Leon (2005>) 312 SKODA  Yeti (2009>) 314 SKODA  Octavia (2004>2008) 316 Octavia (2008>) 317 Superb (2008>) 317 VOLKSWAGEN  Tiguan (2007>) 356 VOLKSWAGEN  Eos (2006>) 360 Golf V (2003>) 368 Golf VI (2008>) 368 Golf Plus (2009>) 369 Jetta III (2005>) 370 Passat VII (2005>) 373 Passat CC (2008>) 374 Scirocco (2008>) 377 Sharan (2010>) 378 Touran I (2003>2006) 378 Touran II (2006>2010) 378
● 197032	D 747		255x9,9	927 AUDI  A6 (97>2001) 64 A6 (2001>2005) 65 A6 Allroad (2000>2005) 66
● 197033	D 748		258,5x12	927 MERCEDES  Sprinter (95>2006) 214 VOLKSWAGEN  LT II (96>2003) 380 LT III (2003>2006) 381
● 197035	D 750		300x10	927 MERCEDES  Class E (W211) (2002>2006) 207 Class E (W211) (2006>2009) 208 Class E (207-212) (2009>) 208
● 197036	D 751		258x8	927 MERCEDES  Class A (W169) (2004>2008) 199 Class A (W169) (2008>) 199 Class B (W245) (2005>2008) 199 Class B (W245) (2008>) 200

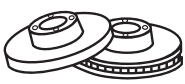

Valeo					
● 197038	D 753	255x12	927	AUDI A4 (2004>2008) 63 A4 Cabriolet II (2006>2009) 63 SEAT Exeo (2008>) 309	
● 197043	D 758	280x24	927	CITROËN Jumper II (2006>) 103 Relay II (2006>) 104 FIAT Ducato (2006>) 127 PEUGEOT Boxer II (2006>) 270	
● 197044	D 759	257x22	927	FIAT Grande Punto (2005>) 119 Punto Evo (2009>) 120 OPEL Corsa D (2006>) 246 VAUXHALL Corsa MK III (2006>) 349	
● 197045	D 760	284x22	927	FIAT Grande Punto (2005>) 120 Punto Evo (2009>) 120 OPEL Corsa D (2006>) 246 VAUXHALL Corsa MK III (2006>) 349	
● 197046	D 761	330x30	927	CITROËN C6 (2005>) 95 PEUGEOT 407 (2004>) 266 607 (2004>) 268	
● 197047	D 762	247x20	927	CITROËN C1 (2005>) 92 PEUGEOT 107 (2005>) 258 TOYOTA Aygo (2005>) 332	
● 197049	D 764	300x20	927	BMW Series 1 (E87) (2004>) 75 Series 1 (E81/82/88) (2007>) 76 Series 3 (E90/91/92/93) (2005>) .. 79 Series 3 (E90/91/93) (2007>) 79	
● 197050	D 765	300x20	927	SAAB 9-5 (2001>2005) 303 9-5 (2005>) 303	
● 197051	D 766	358x28	927	AUDI Q7 (2006>) 55 PORSCHE Cayenne (2003>) 272	
● 197052	D 767	314x25	927	AUDI A6 (2004>2008) 65 A6 (2008>) 65	
● 197054	D 769	300x28	927	FORD Transit (2006>) 143	

Valeo					
● 197055	D 770	300x28	928	FORD Galaxy (2006>) 135 Mondeo (2007>) 138 S-Max (2006>) 141 LAND ROVER Freelander 2 (2006>) 183 VOLVO XC 70 (2007>) 384 VOLVO V70 (2007>) 393 S80 (2006>) 393	
● 197056	D 771	302x26	928	VOLVO XC 70 (97>99) 384 VOLVO C70 (97>2005) 391 S70 (96>2000) 391 V70 (96>2000) 392	
● 197057	D 772	316x28	928	VOLVO XC 90 (2002>) 384	
● 197059	D 774	285x21,9	928	MERCEDES Sprinter (95>2006) 215 VOLKSWAGEN LT II (96>2003) 381 LT III (2003>2006) 381	
● 197060	D 775	270x22	928	MERCEDES Vaneo (2001>) 214	
● 197062	D 777	297,5x25	928	LAND ROVER Discovery (98>2004) 182	
● 197063	D 778	255x20	928	MAZDA MX5 (90>98) 193 MX5 (98>2000) 193 MX5 (2000>2005) 194	
● 197064	D 779	257x17	928	SUZUKI Ignis (2000>2003) 324	
● 197065	D 780	287x17	928	SUZUKI Grand Vitara (98>2005) 322	
● 197066	D 781	252x20	928	OPEL Agila (2007>) 242 SUZUKI Splash (2008>) 324 Swift Made in Hungary (2005>) .. 325 VAUXHALL Agila (2007>) 343	
● 197067	D 782	285x22	928	MITSUBISHI Pajero Pinin (H7) (99>) 220 Shogun Pinin (99>) 221	
● 197069	D 784	281x28	928	CHRYSLER Voyager IV (2001>) 90 Voyager V (2004>) 90 Grand Voyager (2001>2004) 90 Grand Voyager (2004>2008) 90	
● 197070	D 785	295x26	928	TOYOTA Corolla Verso (2004>2009) 336	



Valeo									
● 197071	D 786		338x28	928		TOYOTA Land Cruiser (KD/GR) (2002>) ... 329			
● 197072	D 787		277x26	928		TOYOTA Avensis (2003>2008) 332			
● 197073	D 788		330x24	928		BMW X1 (2009>) 73			
						BMW Series 1 (E87) (2004>) 75 Series 1 (E81/82/88) (2007>) 75 Series 3 (E90/91/92/93) (2005>) ... 78 Series 3 (E90/91/93) (2007>) 79			
● 197074	D 789		280x22	928		MINI (R56/57) (2006>) 217 MINI (R56/57) (2009>) 217 MINI Clubman (2007>) 217 MINI Clubman (2009>) 218			
● 197079	D 794		308x28	928		RENAULT Espace IV (2002>2006) 283 Espace IV (2006>) 283			
● 197081	D 796		300x26	929		RENAULT Mégane Scenic (99>2003) 291			
● 197083	D 798		325x25	929		BMW X3 (2003>2006) 73 X3 (2006>) 73			
● 197084	D 799		320x20	929		BMW Series 5 (E60/61) (2003>) 82 Series 6 (E63/64) (2003>) 82			
● 197086	D 801		256x24,9	929		VOLKSWAGEN Lupo (98>2005) 370 Polo V (94>99) 375 Polo VI (99>2001) 375			
● 197087	D 802		330x32	929		PORSCHE Cayenne (2003>) 272			
						VOLKSWAGEN Touareg I (2002>2006) 356 Touareg II (2006>2010) 357 Touareg II (2010>) 357			
● 197088	D 803		256x22	929		AUDI TT (98>2006) 72			
						SEAT Leon (99>2006) 311			
						SKODA Octavia (2000>) 316			
						VOLKSWAGEN Bora (98>2005) 358 Golf IV (97>2006) 367 New Beetle (98>2001) 370 New Beetle (2001>2005) 371			
● 197089	D 804		269x22	929		AUDI A6 (97>2001) 64 A6 (2001>2005) 65 S6 (99>2001) 71 S6 (2001>2005) 71			
						VOLKSWAGEN Passat VI (2000>2005) 373			



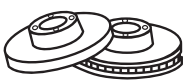





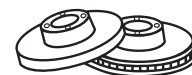

























Valeo									
● 197090	D 805		330x28	929		AUDI Q7 (2006>) 55			
						PORSCHE Cayenne (2003>) 272			
						VOLKSWAGEN Touareg I (2002>2006) 356 Touareg II (2006>2010) 357 Touareg II (2010>) 357			
● 197091	D 806		288x25	929		MERCEDES Class A (W169) (2004>2008) 199 Class A (W169) (2008>) 199 Class B (W245) (2005>2008) 199 Class B (W245) (2008>) 200			
● 197092	D 807		330x32	929		MERCEDES Class ML (164) (2005>2008) 196 Class ML (164) (2008>) 196			
						MERCEDES Class R (W251) (2005>) 208			
● 197093	D 808		330x32	929		MERCEDES Class E (W211) (2002>2006) 207 Class E (W211) (2006>2009) 208			
● 197094	D 809		300x22	929		MERCEDES Class E (W124) (93>98) 206 Class E (W210) (95>2003) 207 Class SL (129) (89>2001) 211			
● 197096	D 811		241x18	929		HYUNDAI i10 (2007>) 159			
						KIA Picanto (2004>2007) 172 Picanto (2007>) 172			
● 197097			280x16	929		CITROËN Jumper II (2006>) 103 Relay II (2006>) 105			
						FIAT Ducato (2006>) 127			
						PEUGEOT Boxer II (2006>) 270			
● 197098			278x12	929		ALFA ROMEO 159 (2005>) 48 Brera (2006>) 50 Giulietta (2010>) 51 Spider II (2006>) 54			
● 197099			290x14	929		CITROËN Dispatch (2007>) 103 Jumpy (2007>) 104			
						FIAT Scudo (2007>) 128			
						PEUGEOT Expert II (2007>) 270			
● 197100			249x9	929		PEUGEOT 308 (2007>) 264			







































Valeo					
● 197101		302x10,9	929	FORD	Focus II (2007>) 134 Galaxy (2006>) 136 Kuga (2008>) 137 Mondeo (2007>) 138 S-Max (2006>) 141
● 197102		304,5x9	930	HONDA	CR-V (2002>2006) 145
● 197103		260x10	930	HONDA	Civic (EP) (2001>2006) 150
● 197104		260x10	930	HONDA	Civic (EP) (2001>2006) 150
● 197105		300x16	930	CITROËN	Jumper II (2006>) 104 Relay II (2006>) 105
				FIAT	Ducato (2006>) 127
				PEUGEOT	Boxer II (2006>) 270
● 197106		291,5x9	930	NISSAN	Qashqai (2007>2010) 238 Qashqai (2010>) 238
● 197107		302x12	930	LAND ROVER	Freelander 2 (2006>) 183
● 197108		211x11	930	DAIHATSU	Cuore (98>2003) 109 Cuore (2003>2005) 109 Domino (98>2000) 109 Trevis (2006>) 110
				TOYOTA	Auris Made in Japan (2006>) 330 Auris Made in UK (2007>) 331 Auris FL (UKP150) (2010>) 331 Corolla (150) (2006>) 336
				TOYOTA	Auris Made in Japan (2006>) 330 Corolla (150) (2006>) 336
				TOYOTA	Yaris Made in France (2005>) ... 340
● 197112		303x9	930	TOYOTA	RAV4 (2000>2005) 330
● 197113		259x9	930	TOYOTA	IQ (2009>) 337 Yaris Made in Japan (2005>) ... 340
● 197114		215x10	930	SUZUKI	Alto (80>94) 323 Swift Made in Japan (83>89) 324
				SUZUKI	Super Carry (SK4*) 325

Valeo					
● 197116		302x10	930	CITROËN	C Crossover 91
				MITSUBISHI	Outlander (CW) (2006>) 219
				PEUGEOT	4007 (2007>) 257
● 197117		267x12	930	CITROËN	C4 Picasso (2006>) 94
				CITROËN	Berlingo (2008>) 102
				PEUGEOT	308 (2007>) 264 3008 (2009>) 264 5008 (2009>) 267
				PEUGEOT	Partner (2008>) 271
● 197120		258x10	930	HYUNDAI	Coupe (95>2001) 157 Elantra (95>2000) 158 Elantra (2000>2007) 158 Lantra (95>2000) 160
● 197121		262x10	930	HYUNDAI	Tucson (2004>) 156
				HYUNDAI	Sonata (2005>) 161 XG (99>2002) 162 XG (2002>) 162
				KIA	Sportage (2004>) 170
				KIA	Magentis (2006>) 172
● 197122		299x10,4	930	DAEWOO	Korando KJ (99>) 106 Musso (99>) 106
				SSANGYONG	Rexton (2002>) 318 Rexton (2004>) 319
● 197123		262x10	931	HYUNDAI	i30 (2007>) 159
				KIA	Ceed (2006>) 171
● 197124		255x9,9	931	AUDI	A6 (97>2001) 64 A6 (2001>2005) 65
				AUDI	A6 (2004>2008) 65 A6 (2008>) 65
● 197125		302x11,7	931	AUDI	A6 (2004>2008) 65 A6 (2008>) 65
● 197126		300x12	931	AUDI	Q5 (2008>) 55
				AUDI	A4 (2007>) 63 A5 (2007>) 63 A5 Cabriolet (2009>) 64 A7 (2010>) 66



Valeo		 Ø 		
● 197127		 300x10	931	MERCEDES  Class C (W204) (2007>) 202 Class E (207-212) (2009>) 208
● 197128		 278x9	931	MERCEDES  Class C (W204) (2007>) 202
● 197129		 250x10	931	MITSUBISHI  Colt (2004>) 223 SMART MCC  Forfour (2004>) 318
● 197130		 330x28	931	ALFA ROMEO  159 (2005>) 48 Brera (2006>) 50 Giulietta (2010>) 51 Spider II (2006>) 54
● 197131		 300x24	931	CITROËN  Jumper II (2006>) 103 Relay II (2006>) 105 FIAT  Ducato (2006>) 127 PEUGEOT  Boxer II (2006>) 270
● 197132		 292x22	931	ALFA ROMEO  159 (2005>) 48 Brera (2006>) 50
● 197133		 304x28	931	CITROËN  Dispatch (2007>) 103 Jumpy (2007>) 104 FIAT  Scudo (2007>) 128 PEUGEOT  407 (2004>) 266 PEUGEOT  Expert II (2007>) 270
● 197134		 292x22	931	ALFA ROMEO  159 (2005>) 49 Brera (2006>) 50 Spider II (2006>) 54
● 197135		 280x22	931	FIAT  Sedici (2006>2009) 111 Sedici (2009>) 111 SUZUKI  SX4 (2006>2009) 325 SX4 (2009>) 325
● 197136		 330x32	931	ALFA ROMEO  147 (2000>2004) 46 147 (2004>) 47 156 (2003>2007) 48 GT (2003>) 51
● 197137		 305,5x28	931	LANCIA  Thesis (2002>) 180
● 197138		 281x22	931	LANCIA  Thesis (2002>) 180

Valeo		 Ø 		
● 197139		 310x22	931	AUDI  A3 (2003>2008) 60 A3 (2008>) 61 S3 (2006>) 69 SKODA  Superb (2008>) 317 VOLKSWAGEN  Eos (2006>) 360 Golf V (2003>) 368 Passat VII (2005>) 373 Passat CC (2008>) 374
● 197140		 330x22	931	AUDI  A6 (2004>2008) 65 A6 (2008>) 65
● 197141		 321x30	932	VOLKSWAGEN  Passat VI (2000>2005) 373
● 197142		 347x30	932	AUDI  A6 (2004>2008) 65 A6 (2008>) 65 A6 Allroad (2006>2008) 66 A6 Allroad (2008>) 66
● 197143		 320x25	932	FORD  Focus (2004>) 133 Focus II (2007>) 134 VOLVO  S40 (2004>) 390 V50 (2004>) 390 C70 CC (2006>) 391
● 197144		 300x25	932	HONDA  Civic (EP) (2001>2006) 150
● 197145		 300x25	932	HONDA  Accord VII (2003>2008) 147
● 197146		 240x21	932	HONDA  Logo (98>2001) 153
● 197147		 255x22	932	TOYOTA  Yaris Made in Japan (2005>) 340
● 197148		 255x28	932	TOYOTA  Carina E (92>97) 333
● 197149		 278x26	932	OPEL  Corsa D (2006>) 247 VAUXHALL  Corsa MK III (2006>) 349
● 197150		 321x28	932	OPEL  Astra H (2004>) 244 Zafira B (2005>2008) 255 Zafira B (2008>) 255 VAUXHALL  Astra MK V (2004>) 345 Zafira II (2005>2009) 353 Zafira II (2009>) 354
● 197151		 275x25	932	TOYOTA  RAV4 (2005>) 330
● 197152		 296x28	932	TOYOTA  RAV4 (2005>) 330

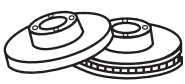

Valeo				
● 197153		280x25	932	HONDA Accord VII (2003>2008) 147
● 197154		282x25	932	HONDA Accord VI (98>2003) 147
● 197155		317x30	932	LAND ROVER Discovery (2004>) 183 Range Rover Sport (2005>) 184
● 197156		325x20	932	LAND ROVER Discovery (2004>) 183 Range Rover Sport (2005>) 184
● 197157		211x16	932	DAIHATSU Cuore (90>94) 109 Domino (90>94) 109 Mira (92>94) 110
● 197158		300x20	932	BMW X1 (2009>) 73 BMW Series 1 (E87) (2004>) 75 Series 1 (E81/82/88) (2007>) 76 Series 3 (E90/91/92/93) (2005>) .. 79 Series 3 (E90/91/93) (2007>) 79
● 197159		312x23,9	933	BMW X1 (2009>) 73 BMW Series 3 (E90/91/92/93) (2005>) .. 78 Series 3 (E90/91/93) (2007>) 79
● 197160		294x22	933	MINI MINI (R56/57) (2006>) 217 MINI (R56/57) (2009>) 217 MINI Clubman (2007>) 217 MINI Clubman (2009>) 218
● 197161		235x22	933	MAZDA 323 (BJ) (98>2000) 191 323 (BJ) (2000>2003) 191
● 197162		310x22	933	SUZUKI Grand Vitara (98>2005) 322 Grand Vitara XL7 (2001>2006) ... 322
● 197163		231x17	933	SUZUKI Wagon R (97>) 325
● 197164		295,5x26	933	NISSAN X-Trail (T31) (2007>) 232 NISSAN Qashqai (2007>2010) 238 Qashqai (2010>) 238
● 197165		255,5x20	933	MITSUBISHI L300 (L030) 229
● 197166		275x28	933	TOYOTA Avensis Verso (2001>2005) 332 Camry (91>96) 332 Camry (96>2001) 333 Picnic (2001>2005) 337 Previa (2000>) 338

Valeo				
● 197167		255x28	933	TOYOTA Camry (91>96) 332 Picnic (96>2001) 337
● 197168		296x28	933	TOYOTA Camry (2001>2006) 333
● 197169		255x24,9	933	TOYOTA Carina E (92>97) 333
● 197170		275x25	933	TOYOTA Celica (99>2005) 334
● 197171		275x25	933	TOYOTA Corolla (120) (2001>2007) 336
● 197172		276x26	933	HYUNDAI Trajet (2000>2004) 162 Trajet (2004>) 162 HYUNDAI Highway Van (2000>2004) 163
● 197173		241x19	933	HYUNDAI Accent (99>2003) 156 Accent (2003>) 156
● 197174		300x28	933	HYUNDAI i30 (2007>) 159 i30 (CZ) (2008>) 159
● 197175		336x22	933	BMW X1 (2009>) 73 BMW Series 3 (E90/91/92/93) (2005>) .. 79 Series 3 (E90/91/93) (2007>) 79
● 197176		348x30	933	BMW X1 (2009>) 73 BMW Series 3 (E90/91/92/93) (2005>) .. 79 Series 3 (E90/91/93) (2007>) 79
● 197177		332x29,9	934	BMW X5 (2006>) 74
● 197178		348x29,9	934	BMW X5 (2006>) 74 X6 (2008>) 74
● 197179		320x19,9	934	BMW X5 (2006>) 74 X6 (2008>) 74
● 197180		345x24	934	BMW X5 (2006>) 74 X6 (2008>) 74
● 197181		300x20	934	BMW Series 1 (E81/82/88) (2007>) 76
● 197182		275x22	934	TOYOTA Yaris Made in Japan (2005>) 340
● 197183		275x22	934	TOYOTA Auris Made in Japan (2006>) ... 330 Corolla (150) (2006>) 336
● 197184		258x22	934	TOYOTA Yaris Made in France (2005>) ... 340

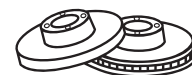

Valeo		Ø			
● 197185		273x26	934	TOYOTA	Auris Made in Japan (2006>) 330 Auris Made in UK (2007>) 330 Auris FL (UKP150) (2010>)..... 331 Corolla (150) (2006>) 336
● 197186		293x28	934	HONDA	CR-V (2006>) 145
● 197187		295x26	934	TOYOTA	Auris Made in Japan (2006>) 330 Auris Made in UK (2007>) 331 Auris FL (UKP150) (2010>)..... 331 Avensis (2008>) 332 Corolla (150) (2006>) 336 Corolla Verso (2009>) 337 Verso (2009>) 339
● 197188		280x28	934	CITROËN	Dispatch (2007>) 103 Jumpy (2007>) 104
				FIAT	Scudo (2007>) 128
				PEUGEOT	Expert II (2007>) 270
● 197190		296x29	934	CHEVROLET	Captiva (2006>) 87
				OPEL	Antara (2006>) 241
				VAUXHALL	Antara (2006>) 342
● 197191		303x20	934	CHEVROLET	Captiva (2006>) 87
				OPEL	Antara (2006>) 241
				VAUXHALL	Antara (2006>) 342
● 197192		280x24	934	DACIA	Duster (2010>) 105
				RENAULT	Fluence (2009>) 283 Laguna III (2007>) 287 Mégane III (2008>) 290 Scenic III (2009>) 293
● 197193		324x30	934	BMW	Series 5 (E60/61) (2003>) 81 Series 6 (E63/64) (2003>) 82
● 197194		296x32	934	LEXUS	GS 300 (97>2004) 185 GS 430 (2000>2004) 186 IS I (99>2005) 186 IS 300 (99>2005) 186 LS400 (89>94) 187 SC430 (2001>) 187
● 197195		278x23,8	934	DAEWOO	Korando KJ (99>) 106 Musso (99>) 106
				SSANGYONG	Rexton (2002>) 318



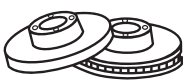





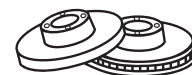

































Valeo		Ø			
● 197196		320x30	935	AUDI	Q5 (2008>) 54
				AUDI	A4 (2007>) 63 A5 (2007>) 63 A5 Cabriolet (2009>) 64
● 197197		345x30	935	AUDI	A3 (2003>2008) 60 A3 (2008>) 61 S3 (2006>) 69
				SEAT	Leon (2005>) 311
				SKODA	Superb (2008>) 317
				VOLKSWAGEN	Eos (2006>) 360 Golf V (2003>) 367 Golf VI (2008>) 368 Passat VII (2005>) 373 Passat CC (2008>) 374 Scirocco (2008>) 377
● 197198		320x30	935	AUDI	A4 (99>2001) 62 A4 (2004>2008) 62 A4 Cabriolet II (2006>2009) 63 A6 (97>2001) 64 A6 (2001>2005) 65 A6 Allroad (2000>2005) 66 S4 (97>99) 69 S4 (99>2001) 69
				SEAT	Exeo (2008>) 308
● 197199		321x30	935	AUDI	A6 (2004>2008) 65 A6 (2008>) 65 A6 Allroad (2006>2008) 66 A6 Allroad (2008>) 66 A8 (2002>2009) 67
● 197200		330x28	935	MERCEDES	Class SLK (171) (2004>2007) ... 213
● 197201		295x28	935	MERCEDES	Class C (W204) (2007>) 202
● 197202		295x28	935	MERCEDES	Class C (W204) (2007>) 202 Class E (207-212) (2009>) 208
● 197203		288x25	935	MERCEDES	Class C (W204) (2007>) 202
● 197204		302x28	935	KIA	Sorento (2006>) 170
● 197205		280x26	935	HYUNDAI	i30 (2007>) 159
				KIA	Ceed (2006>) 171
● 197206		274x24	935	KIA	Carnival (99>2002) 171 Sedona (99>2002) 173



Valeo					
● 197207		284,5x24	935	KIA	Retona (99>) 170 Sportage (93>2002) 170
● 197208		242x20	935	KIA	Sephia (98>2001) 173 Shuma (98>2002) 173
● 197209		315x20	935	KIA	Sorento (2002>2006) 170
● 197210		302x28	935	KIA	Sorento (2002>2006) 170
● 197211		274x28,3	935	KIA	Carnival (2002>2006) 171 Sedona (2002>) 173
● 197212		330x22	935	AUDI	A6 Allroad (2006>2008) 66 A6 Allroad (2008>) 66 S6 (2006>2008) 71 S6 (2008>) 71
● 197213		314x25	935	AUDI	A4 (2007>) 63 A5 (2007>) 63 A5 Cabriolet (2009>) 63
● 197214		256x24	936	MINISUBISHI	Colt (2004>) 223
				SMART MCC	Forfour (2004>) 318
● 197215		300x24	936	RENAULT	Scenic II (2003>) 292 Grand Scenic II (2003>) 293
● 197216		302x26	936	PEUGEOT	308 (2007>) 264 3008 (2009>) 264 5008 (2009>) 267
● 197217		280x18	936	CITROËN	Jumper (94>2001) 103 Relay (94>2001) 104
				FIAT	Ducato (94>2001) 126
				PEUGEOT	Boxer I (94>2001) 269
● 197218		282x18	936	VOLKSWAGEN	Transporter (F70) (90>96) 382

Valeo					
● 197219		285,2x28	936	CITROËN	C8 (2002>) 95
				CITROËN	Dispatch (2004>2006) 103 Jumpy (2004>2006) 104
				FIAT	Ulysse (2002>) 124
				LANCIA	Phedra (2002>) 179
				PEUGEOT	807 (2002>) 268
				PEUGEOT	Expert I (2004>2006) 270
● 197220		288x28	936	CITROËN	C5 (2001>2008) 94 Xantia (93>97) 99 Xantia (97>2002) 99
● 197221		300x26	936	RENAULT	Laguna II (2001>2005) 286 Laguna II (2005>2007) 286
● 197222		288x24,9	936	AUDI	100 (90>94) 58 A4 (94>98) 61 A4 (99>2001) 62 A4 (2000>2004) 62 A4 (2004>2008) 62 A6 (94>97) 64 A6 (97>2001) 64 A6 (2001>2005) 64
				SEAT	Exeo (2008>) 308
				SKODA	Superb (2001>2008) 317
				VOLKSWAGEN	Passat V (96>2000) 373 Passat VI (2000>2005) 373
● 197223		280x26	936	ISUZU	Trooper (81>97) 164 Trooper (98>) 164
				OPEL	Frontera A (91>98) 241 Frontera B (98>2005) 242 Monterey (91>99) 242
				VAUXHALL	Frontera A (91>98) 342 Frontera B (98>2005) 342 Monterey A (94>99) 342 Monterey B (98>99) 342
● 197224		297x25	936	LAND ROVER	Range Rover (94>2002) 184



Valeo					Valeo				
● 197225		 296x28	936	OPEL  Omega A (86>94) 249 Omega B (94>2003) 250 Senator B (87>93) 251 VAUXHALL  Carlton (86>94) 346 Omega (94>) 350 Senator B (87>93) 351	● 197230		 288x24,9	936	AUDI  A1 (2010>) 59 A3 (96>2000) 60 A3 (2000>2003) 60 SEAT  Cordoba (2002>) 308 Ibiza (2001>) 310 Ibiza (2008>) 311 Leon (99>2006) 311 Toledo (98>2004) 313 SKODA  Fabia (99>2004) 314 Fabia (2004>2007) 314 Fabia (2006>) 315 Octavia (96>2000) 315 Octavia (2000>) 316 Roomster (2006>) 317 VOLKSWAGEN  Bora (98>2005) 358 Golf IV (97>2006) 366 New Beetle (98>2001) 370 New Beetle (2001>2005) 370 New Beetle (2005>) 371 Polo VII (2001>) 376 Polo VIII (2005>) 376 Polo IX (2009>) 377
● 197226		 288x25	936	OPEL  Calibra (89>97) 245 Vectra B (95>99) 253 Vectra B (99>2003) 253 SAAB  9-3 (98>2003) 302 9-5 (97>2001) 303 9-5 (2001>2005) 303 9-5 (2005>) 303 900 (93>98) 304 VAUXHALL  Calibra (90>97) 345 Vectra (95>2002) 352	● 197231		 305x28	936	PEUGEOT  406 (95>2004) 265
● 197227		 316x28	936	BMW  Series 7 (E38) (94>2001) 83	● 197232		 302x26	937	CITROËN  C4 (2004>) 93 C4 Picasso (2006>) 94 PEUGEOT  207 (2006>) 261 307 (2001>2005) 263 307 (2005>) 263
● 197228		 300x24	936	CITROËN  Jumper (94>2001) 103 Jumper (2002>2006) 103 Relay (94>2001) 104 Relay (2002>2006) 104 FIAT  Ducato (94>2001) 126 Ducato (2002>2006) 127 Ducato RU (2008>) 128 PEUGEOT  Boxer I (94>2001) 269 Boxer I (2002>2006) 269	● 197233		 302x28	937	CHRYSLER  Voyager IV (2001>) 90 Voyager V (2004>) 90 Grand Voyager (96>2001) 90 Grand Voyager (2001>2004) 90 Grand Voyager (2004>2008) 91
● 197229		 310x28	936	ALFA ROMEO  166 (98>2003) 49 166 (2003>2007) 49 LANCIA  Kappa (94>2001) 178	● 197234		 300x24	937	BMW  Series 1 (E87) (2004>) 75 Series 1 (E81/82/88) (2007>) 75 Series 3 (E90/91/92/93) (2005>) .. 78 Series 3 (E90/91/93) (2007>) 79 Z4 (E89) (2009>) 87
					● 197236		 288x25	937	FORD  Galaxy (95>2000) 135 Galaxy (2000>2006) 135 SEAT  Alhambra (96>2000) 305 Alhambra (2000>2003) 306 VOLKSWAGEN  Sharan (95>2000) 377 Sharan (2000>2003) 378
					● 197238		 305x26	937	JEEP  Grand Cherokee (2000>2003) ... 169 Grand Cherokee (2003>2005) ... 169

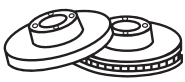

Valeo							
● 197239	300x26	937	FORD	Galaxy (2000>2006) 135			
			SEAT	Alhambra (2000>2003) 306			
			VOLKSWAGEN	Sharan (2000>2003) 378 Sharan (2003>2010) 378			
			VOLKSWAGEN	Transporter (F7D) (96>2003) 382			
● 197240	305x28	937	RENAULT	Avantime (2001>2003) 279 Espace III (2000>2002) 283			
● 197241	300x24	937	RENAULT	Scenic II (2003>) 292 Grand Scenic II (2003>) 293			
● 197242	312x25	937	AUDI	A3 (2003>2008) 60 A3 (2008>) 60 A3 Cabriolet (2008>) 61 S3 (98>2003) 69 TT (2006>) 72			
			SEAT	Alhambra (2010>) 306 Altea (2004>) 306 Leon (2005>) 311			
			SKODA	Yeti (2009>) 313			
			SKODA	Octavia (2004>2008) 316 Octavia (2008>) 316 Superb (2001>2008) 317 Superb (2008>) 317			
			VOLKSWAGEN	Tiguan (2007>) 356			
			VOLKSWAGEN	Eos (2006>) 360 Golf V (2003>) 367 Golf VI (2008>) 368 Jetta III (2005>) 370 Passat VII (2005>) 373 Passat CC (2008>) 373 Scirocco (2008>) 377 Sharan (2010>) 378 Touran I (2003>2006) 378 Touran II (2006>2010) 378 Touran III (2010>) 379			
			VOLKSWAGEN	Caddy III (2004>) 380			
			● 197243	314x22	937	VOLKSWAGEN	Touareg I (2002>2006) 356 Touareg II (2006>2010) 357
						VOLKSWAGEN	Transporter (7J/7H) (2003>2009) . 383

Valeo							
● 197244	308x25	937	OPEL	Astra G (98>2005) 244 Astra H (2004>) 244 Corsa D (2006>) 247 Meriva (2003>) 248 Meriva (2010>) 249 Zafira A (98>2003) 254 Zafira A (2003>2005) 254 Zafira B (2005>2008) 255 Zafira B (2008>) 255			
			SAAB	9-5 (97>2001) 303 9-5 (2001>2005) 303 9-5 (2005>) 303			
			VAUXHALL	Astra MK IV (98>2005) 344 Astra MK V (2004>) 345 Corsa MK III (2006>) 349 Meriva (2003>) 349 Meriva (2010>) 349 Vectra (95>2002) 352 Zafira I (99>2003) 353 Zafira I (2003>2005) 353 Zafira II (2005>2009) 353 Zafira II (2009>) 354			
			● 197245	283x25	937	MAZDA	6 (2002>2007) 189
			● 197246	312x25	937	AUDI	A3 (2000>2003) 60 TT (98>2006) 72
						SEAT	Ibiza (2001>) 310 Ibiza (2008>) 311 Leon (99>2006) 311
						SKODA	Octavia (2000>) 316
						VOLKSWAGEN	Bora (98>2005) 358 Golf IV (97>2006) 366 New Beetle (98>2001) 370 Polo VIII (2005>) 376
						● 197247	305x28
			● 197248	280x28	937	CITROËN	Jumper II (2006>) 103 Relay II (2006>) 105
						FIAT	Ducato (2006>) 127
			● 197249	280x28	937	PEUGEOT	Boxer II (2006>) 270
FORD	Transit (2006>) 143						
● 197251	320x22	937	BMW	X3 (2003>2006) 73 X3 (2006>) 74			



Valeo		 Ø 		   
● 197252	 288x28	937	JEEP  Cherokee (2001>)169 Cherokee (2004>)169	

Valeo		 Ø 		   



Pads and Discs

Plaquettes et Disques

Pastillas y Discos

Pastilas e Discos

Pastiglie e Dischi

Blokjes en Schijven

Bremsbeläge und Bremsscheiben

Klocki i Tarcze

















Balatalari ve Diskleri















Κολοдки и диски













Δισκόφρενα & Δισκόπλακες

















刹车片和刹车盘



















بطانات و قرص













Valeo			
186901	598171	186162	FORD  Fiesta (89>95) 132
186903	598172	186163	FORD  Escort (90>94) 131 Escort (95>2001) 131 Orion (90>93) 138
186904	598091	186151	AUTOBIANCHI  Y10 (85>95) 73 FIAT  900 (76>87) 112 Panda (80>86) 117 Panda (86>2003) 118 Regata (83>90) 120 Ritmo (82>88) 120 Strada (85>88) 122 Uno (83>89) 124 Uno (89>95) 124 Uno Mondo (98>) 125 LANCIA  Y10 (89>95) 181 SEAT  Ibiza (84>93) 309 Malaga (85>93) 312 Ronda (82>87) 312
186906	598151	186134	CITROËN  BX (82>94) 92
186907	598119	186200	CITROËN  Visa (78>88) 98 CITROËN  C15 (84>2005) 102
186908	598030	186130	CITROËN  AX (86>91) 91 AX (91>98) 92
186909	598154	186194	CITROËN  Fukang (93>) 97 ZX (91>98) 101
186910	598155	186200	CITROËN  Fukang (93>) 96 ZX (91>98) 101 CITROËN  C15 (84>2005) 102

















Valeo			
186912	598128	186245	SEAT  Cordoba (93>96) 307 Ibiza (93>96) 309 Toledo (91>98) 312 VOLKSWAGEN  Golf I (74>83) 360 Golf II Cabriolet (79>93) 360 Golf II (83>92) 361 Golf II Cabriolet (93>98) 361 Golf III (91>99) 361 Jetta I (78>84) 369 Jetta II (83>92) 369 Passat I (73>81) 371 Passat II (81>88) 371 Santana (81>84) 377 Scirocco (74>90) 377 Vento (91>97) 379 VOLKSWAGEN  Caddy I (82>92) 379
186913	598176	186200	PEUGEOT  205 (83>87) 259 205 (87>98) 259 309 (85>89) 264 309 (89>94) 264
186914	598081	186200	PEUGEOT  106 (96>2003) 258 309 (85>89) 264 309 (89>94) 264
186915	598179	186198	PEUGEOT  405 (87>92) 265 405 (92>96) 265
186916	598156	186130	PEUGEOT  106 (91>96) 258 106 (96>2003) 258
186918	598080	186228	RENAULT  Super 5 (84>96) 275 Clio I (90>96) 280 Twingo I (93>98) 294 RENAULT  Express (85>91) 295 Extra (85>91) 295
186919	598081	186230	RENAULT  Super 5 (84>96) 275 R11 (82>89) 275 R19 (88>92) 277 R19 (92>95) 277 R21 (86>94) 278 Clio I (90>96) 280 Clio I (96>98) 280 Lutecia (Japan) (94>98) 287 RENAULT  Express (85>91) 295 Express (91>2003) 295 Extra (85>91) 295 Extra (91>97) 295 Rapid (91>98) 297

















Valeo			
186921	598002	186230	RENAULT  <ul style="list-style-type: none"> Super 5 (84>96) 275 R11 (82>89) 275 R19 (88>92) 277 R19 (92>95) 277 R21 (86>94) 278 Clio I (90>96) 280 Clio I (96>98) 280 Clio II (98>2001) 280 Clio II (2001>) 280 Lutecia (Japan) (94>98) 287 Mégane (95>99) 287 Mégane Classic (96>99) 288 Thalia (2001>) 293 Twingo I (93>98) 294 Twingo II (98>2007) 294 RENAULT  <ul style="list-style-type: none"> Express (85>91) 295 Express (91>2003) 295 Extra (91>97) 295 Rapid (91>98) 297
186923	598002	186229	RENAULT  <ul style="list-style-type: none"> Super 5 (84>96) 275 R9 (81>88) 275 R11 (82>89) 275 R19 (92>95) 277 R21 (86>94) 278 R21 Nevada Savanna (86>95) ... 278 Clio I (90>96) 280 Clio I (96>98) 280 Clio II (98>2001) 280 Clio II (2001>) 281 Lutecia (Japan) (94>98) 287 Mégane (95>99) 287 Thalia (2001>) 293
186924	598356	186187	OPEL  <ul style="list-style-type: none"> Astra F (91>2001) 243 Astra Classic (98>2002) 243 Corsa A (82>93) 246 Corsa B (93>2000) 246 VAUXHALL  <ul style="list-style-type: none"> Astra MK III (91>2001) 343 Cavalier (88>95) 347 Corsa MK I (93>2000) 348
186925	598182	186187	OPEL  <ul style="list-style-type: none"> Ascona C (81>88) 243 Corsa A (82>93) 246 Kadett E (84>91) 247
186926	598714	186200	CITROËN  <ul style="list-style-type: none"> ZX (91>98) 101
186928	598031	186198	CITROËN  <ul style="list-style-type: none"> Xantia (93>97) 98 Xantia (97>2002) 99
186930	598155	186276	CITROËN  <ul style="list-style-type: none"> AX (91>98) 92



















Valeo			
186931	598073	186589	CITROËN  <ul style="list-style-type: none"> Evasion (94>98) 96 Evasion (98>2002) 96 Synergie (95>98) 98 CITROËN  <ul style="list-style-type: none"> Dispatch (95>2003) 102 Dispatch (2004>2006) 103 Jumpy (95>2003) 104 Jumpy (2004>2006) 104 FIAT  <ul style="list-style-type: none"> Ulysse (94>98) 123 Ulysse (98>2002) 123 FIAT  <ul style="list-style-type: none"> Scudo (95>2003) 128 Scudo (2004>2006) 128 PEUGEOT  <ul style="list-style-type: none"> 806 (94>98) 268 806 (98>2002) 268 PEUGEOT  <ul style="list-style-type: none"> Expert I (95>2003) 270 Expert I (2004>2006) 270
186932	598184	186189	DAEWOO  <ul style="list-style-type: none"> Aranos (95>) 106 Espero (93>99) 106 Lanos (97>) 107 Nexia (95>) 107 OPEL  <ul style="list-style-type: none"> Astra F (91>2001) 243 Astra Classic (98>2002) 243 Calibra (89>97) 245 Kadett E (84>91) 248 Vectra A (88>95) 252 Vectra B (95>99) 253 VAUXHALL  <ul style="list-style-type: none"> Astra MK II (84>91) 343 Astra MK III (91>2001) 344 Calibra (90>97) 345 Cavalier (88>95) 347 Vectra (95>2002) 352
186934	598212	186159	FORD  <ul style="list-style-type: none"> Escort (86>90) 130 Orion (83>90) 138 Sierra (82>86) 140 Sierra (87>93) 140 FORD  <ul style="list-style-type: none"> P100 Pick-up (88>93) 142
186935	598172	186162	FORD  <ul style="list-style-type: none"> Escort (90>94) 130 Orion (90>93) 138
186936	598166	186158	FORD  <ul style="list-style-type: none"> Orion (83>90) 138
186937	598033	186277	FORD  <ul style="list-style-type: none"> Mondeo (93>96) 137 Mondeo (96>2000) 137

















Valeo			
186938	598034	186277	FORD  Cougar (98>2001) 130 Granada (92>95) 136 Mondeo (93>96) 137 Mondeo (96>2000) 137 Scorpio (94>98) 139
186939	598036	186278	FORD  Transit (91>94) 143 Transit (94>99) 143
186940	598043	186529	FORD  Fiesta (95>99) 132 Ka (96>2008) 136
186941	598212	186163	FORD  Fiesta (76>83) 131 Fiesta (83>89) 131 Fiesta (89>95) 132 Fiesta (99>2002) 132 Puma (97>2001) 139 FORD  Courier (91>96) 142 Courier Courier (96>2002) 142 MAZDA  121 (96>) 190
186942	598095	186155	FIAT  Tempra (89>93) 122 Tipo (88>93) 123 LANCIA  Dedra (89>94) 175
186944	598315	186185	MERCEDES  190 (201) (82>93) 196 200/300 (W124) (84>93) 197 Class E (W124) (93>98) 205
186945	598122	186479	NISSAN  Patrol GR (Y60) (88>97) 231
186946	598184	186188	OPEL  Astra F (91>2001) 243 Kadett E (84>91) 248 Vectra A (88>95) 252 VAUXHALL  Astra MK II (84>91) 343 Astra Belmont (86>91) 343 Astra MK III (91>2001) 344
186947	598182	186186	BEDFORD  Novavan (82>88) 73 OPEL  Corsa A (82>93) 245 Kadett D (79>84) 247 Kadett E (84>91) 247 OPEL  Combo (85>93) 255 VAUXHALL  Astra MK I (80>84) 343 Astra MK II (84>91) 343 Astra Belmont (86>91) 343 Nova (83>93) 350

Valeo			
186950	598038	186194	PEUGEOT  205 (87>98) 259 306 (93>97) 262
186951	598181	186200	PEUGEOT  106 (91>96) 257 106 (96>2003) 258 306 (93>97) 262
186954	598081	186229	RENAULT  Super 5 (84>96) 275 R21 (86>94) 278 R21 Nevada Savanna (86>95) ... 278 Clio I (90>96) 280 Clio I (96>98) 280 Lutecia (Japan) (94>98) 287
186955	598061	186304	RENAULT  Laguna I (94>98) 284 Laguna I Nevada (95>98) 285 Mégane (95>99) 287 Mégane Scenic (96>99) 290
186956	598077	186226	RENAULT  R4 (62>92) 274 R5 (72>85) 274 R6 (68>80) 275 R12 (69>80) 276 R15 (71>80) 276 R17 (71>80) 276 R18 (77>86) 276
186957	598002	186208	DACIA  Logan (2004>) 105 Sandero (2008>) 106 RENAULT  R19 (88>92) 277 R19 (92>95) 277 Clio I (90>96) 280 Clio II (98>2001) 280 Clio II (2001>) 281 Clio Campus Evolution (2009>) .. 282 Mégane (95>99) 287 Mégane (98>2003) 288 Mégane Classic (96>99) 288 Mégane Classic (99>2002) 288 Mégane Scenic (96>99) 290 Thalia (2001>) 294 Twingo II (98>2007) 294 Twingo III (2007>) 294
186958	598082	186219	RENAULT  R21 (86>94) 278 R21 Nevada Savanna (86>95) ... 278
186961	598180	186288	SEAT  Cordoba (93>96) 307 Ibiza (93>96) 309 Toledo (91>98) 313 VOLKSWAGEN  Golf II (83>92) 361 Jetta I (78>84) 369 Scirocco (74>90) 377

Valeo			
186968	598464	186695	CITROËN  <ul style="list-style-type: none"> C2 (2003>2010) 92 C3 (2005>) 93 C3 (2009>) 93 C3 Picasso (2009>) 93 C4 (2004>) 93 DS3 (2010>) 96 Xsara (2000>2005) 100 Xsara Picasso (99>) 100 CITROËN  <ul style="list-style-type: none"> Berlingo (96>2002) 101 Berlingo (2002>) 101 PEUGEOT  <ul style="list-style-type: none"> 1007 (2005>) 258 206 (98>) 260 207 (2006>) 261 307 (2001>2005) 263 307 (2005>) 263 PEUGEOT  <ul style="list-style-type: none"> Partner (96>2002) 271 Partner (2002>) 271 Ranch (96>2002) 272 Ranch (2002>) 272
186969	598558	186655	RENAULT  <ul style="list-style-type: none"> Mégane II (2002>) 289 Scenic II (2003>) 292 RENAULT  <ul style="list-style-type: none"> Kangoo (97>2003) 295 Kangoo (2003>) 296
186970	598461	186194	PEUGEOT  <ul style="list-style-type: none"> 206 (98>) 259 206+ (2009>) 261
186971	598461	186598	CITROËN  <ul style="list-style-type: none"> Xsara (97>2000) 100 PEUGEOT  <ul style="list-style-type: none"> 206 (98>) 259 206+ (2009>) 261
186972	598465	186693	CITROËN  <ul style="list-style-type: none"> C3 (2005>) 93 C4 (2004>) 93 Xsara (2000>2005) 100 Xsara Picasso (99>) 101 CITROËN  <ul style="list-style-type: none"> Berlingo (2002>) 101 PEUGEOT  <ul style="list-style-type: none"> 1007 (2005>) 258 206 (98>) 260 207 (2006>) 261 307 (2001>2005) 263 307 (2005>) 263 PEUGEOT  <ul style="list-style-type: none"> Partner (2002>) 271 Ranch (2002>) 272

Valeo			
186973	598408	186603	AUDI  <ul style="list-style-type: none"> A2 (2000>2005) 59 A3 (2000>2003) 60 SEAT  <ul style="list-style-type: none"> Ibiza (2008>) 311 SKODA  <ul style="list-style-type: none"> Fabia (99>2004) 314 Roomster (2006>) 317 VOLKSWAGEN  <ul style="list-style-type: none"> Bora (98>2005) 357 Golf IV (97>2006) 366 Polo VII (2001>) 376 Polo VIII (2005>) 376
186974	598408	186754	AUDI  <ul style="list-style-type: none"> A3 (2003>2008) 60 A3 (2008>) 61 A3 Cabriolet (2008>) 61 SEAT  <ul style="list-style-type: none"> Altea (2004>) 306 Leon (2005>) 311 Toledo (2004>) 313 SKODA  <ul style="list-style-type: none"> Yeti (2009>) 313 SKODA  <ul style="list-style-type: none"> Octavia (2004>2008) 316 Octavia (2008>) 316 VOLKSWAGEN  <ul style="list-style-type: none"> Golf V (2003>) 367 Golf VI (2008>) 368 Golf Plus (2005>) 368 Golf Plus (2009>) 369 Jetta III (2005>) 369 VOLKSWAGEN  <ul style="list-style-type: none"> Caddy III (2004>) 380
186975	598473	186655	RENAULT  <ul style="list-style-type: none"> Clio II (98>2001) 280 Clio II (2001>) 281 Laguna I (98>2000) 284 Laguna I Nevada (98>2000) 285 Mégane (98>2003) 287 Mégane Classic (99>2002) 288 Mégane Scenic (96>99) 291 Mégane Scenic (99>2003) 291
186976	598473	186208	RENAULT  <ul style="list-style-type: none"> Mégane Classic (99>2002) 288
186977	598726	186208	NISSAN  <ul style="list-style-type: none"> Kubistar (2003>) 240 RENAULT  <ul style="list-style-type: none"> Kangoo (97>2003) 295 Kangoo (2003>) 296

Valeo			
186978	598326	186198	CITROËN  Xsara (97>2000) 100 CITROËN  Berlingo (96>2002) 101 PEUGEOT  306 (97>2002) 263 PEUGEOT  Partner (96>2002) 271 Ranch (96>2002) 271 RENAULT  Laguna II (2001>2005) 286 Laguna II (2005>2007) 286
186980	598641	186764	DACIA  Logan (2004>) 106 NISSAN  Micra (K12E) (2003>2005) 236 Micra (K12E) (2005>) 236 Note (E11E) (2005>2007) 236 Note (E11E) (2008>) 236 RENAULT  Clio III (2005>) 281 Clio III (2009>) 281 Modus (2004>2008) 291 Modus (2008>) 291
186981	598500	186599	CITROËN  C2 (2003>2010) 92 C3 (2002>2005) 92 C3 (2005>) 93
186982	598726	186229	NISSAN  Kubistar (2003>) 240 RENAULT  Kangoo (97>2003) 295 Kangoo (2003>) 296
186983	598332	186603	AUDI  A1 (2010>) 59 A3 (96>2000) 59 SEAT  Cordoba (2002>) 308 Ibiza (2001>) 310 Ibiza (2008>) 311 Toledo (98>2004) 313 SKODA  Fabia (99>2004) 314 Fabia (2004>2007) 314 Fabia (2006>) 315 Octavia (96>2000) 315 Octavia (2000>) 316 Roomster (2006>) 317 VOLKSWAGEN  Bora (98>2005) 357 Fox (2004>) 360 Golf IV (97>2006) 366 Polo VII (2001>) 376 Polo VIII (2005>) 376 Polo IX (2009>) 376

Valeo			
186984	598553	197219	CITROËN  C8 (2002>) 95 CITROËN  Dispatch (2004>2006) 103 Jumpy (2004>2006) 104 FIAT  Ulysse (2002>) 124 LANCIA  Phedra (2002>) 179 PEUGEOT  807 (2002>) 268 PEUGEOT  Expert I (2004>2006) 270
186985	598018	186275	BMW  Series 3 (E36) (90>2001) 77 Series 3 (E46) (98>2006) 77 Z3 (E36) (96>2002) 86 Z4 (E85/86) (2002>2009) 86
186986	598074	186194	CITROËN  Saxo (96>99) 97 Saxo (99>2005) 98 Xsara (97>2000) 100 PEUGEOT  106 (91>96) 258 106 (96>2003) 258 306 (97>2002) 262
186987	598545	186712	NISSAN  Primastar (2002>2006) 240 Primastar (2006>) 240 OPEL  Vivaro (2001>2006) 257 Vivaro (2006>) 257 RENAULT  Trafic II (2001>2006) 298 Trafic II (2006>) 298 VAUXHALL  Vivaro (2001>2006) 355 Vivaro (2006>) 355



Pads and Discs

Plaquettes et Disques

Pastillas y Discos

Pastilas e Discos

Pastiglie e Dischi

Blokjes en Schijven

Bremsbeläge und Bremsscheiben

Klocki i Tarcze

Balatalari ve Diskleri

Κολοδκι и ДИСКИ

Δισκόφρενα & Δισκόπλακες

刹车片和刹车盘

بطانات و قرص



20009 (WVA)

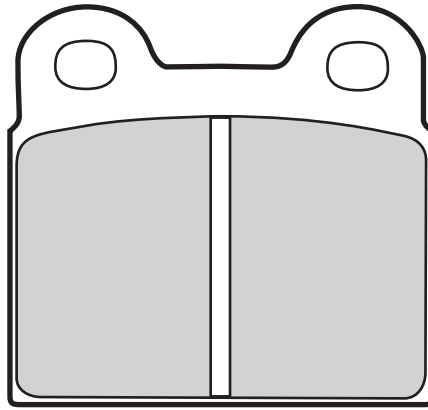

598187

0

55,8

53

15

TEVES

ALFA ROMEO, BMW, OPEL, SAAB, TALBOT, VOLKSWAGEN

20011 (WVA)

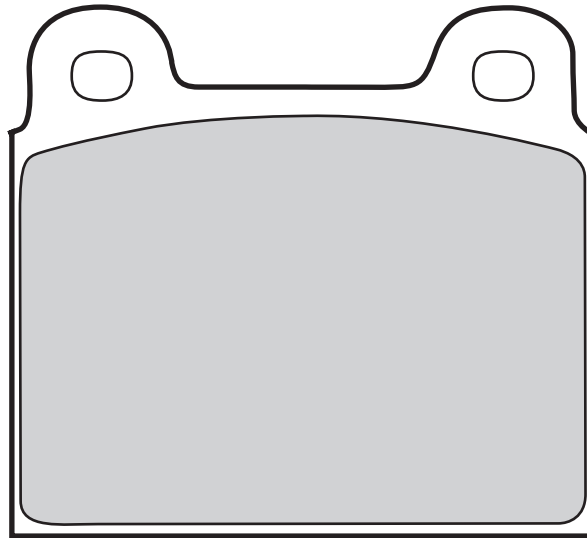

598106

0

76,6

70

19

TEVES

VOLKSWAGEN

598111

0

76,6

70

15

TEVES

ALFA ROMEO, MERCEDES, OPEL, PORSCHE, TALBOT, VAUXHALL, VOLKSWAGEN



20031 (WVA)

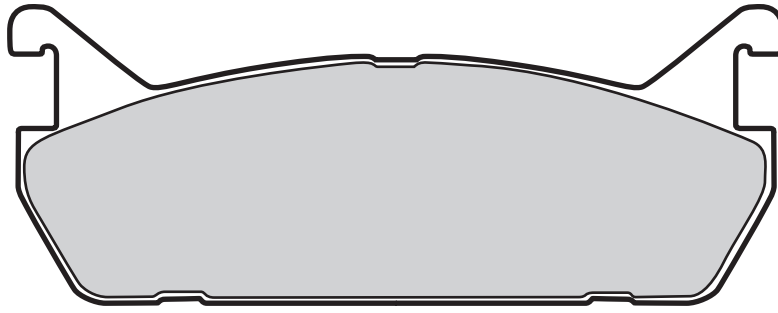

0



102



39



12,5



SUMITOMO



DAIHATSU, MAZDA, SUZUKI

598624

20038 (WVA)

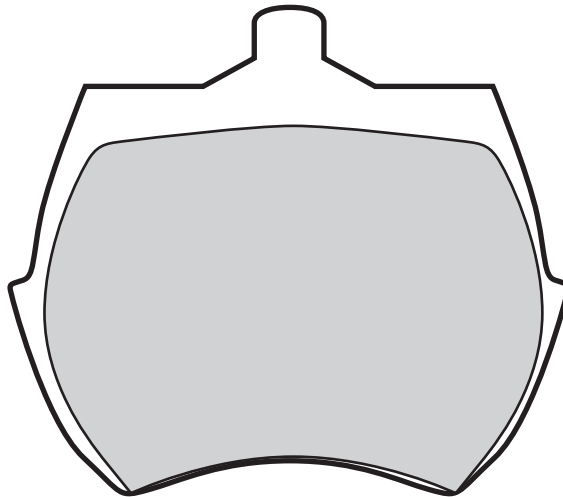

0



74,3



64,3



14



AP



INNOCENTI, MG, ROVER

598392

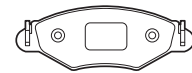

20076 (WVA)

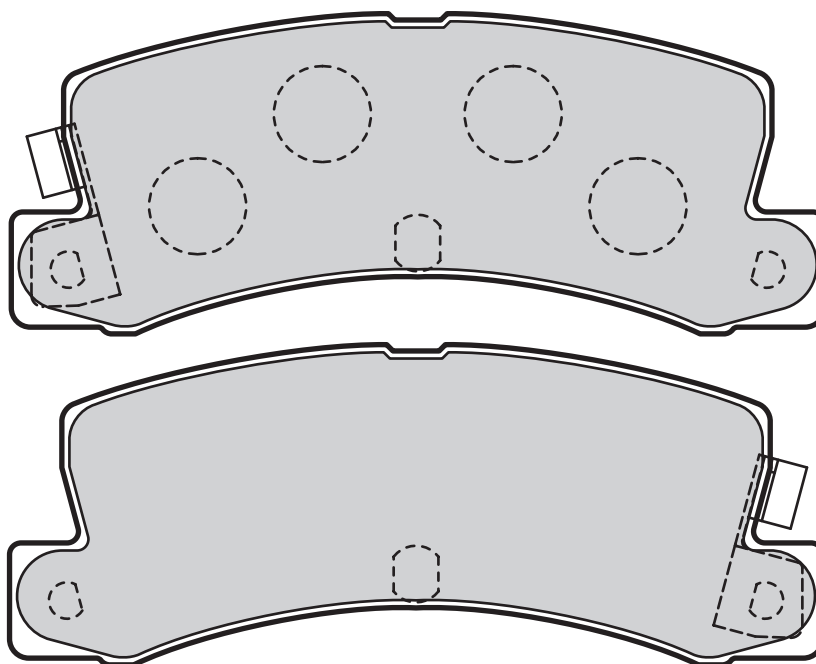

598984

0

107,6

42,5

15,5

AKEBONO

TOYOTA

20088 (WVA)

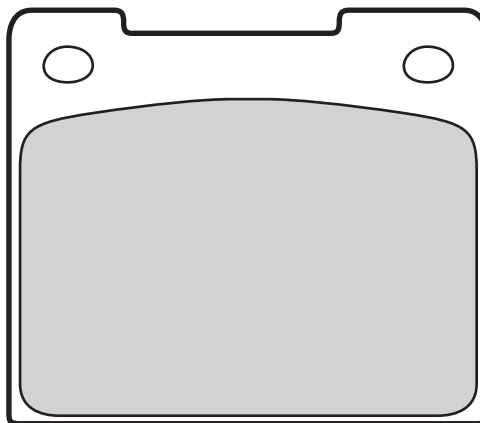

598338

0

63,3

55

12,2

TEVES

FORD, PEUGEOT, ROVER, TALBOT, VOLVO



20098 (WVA)

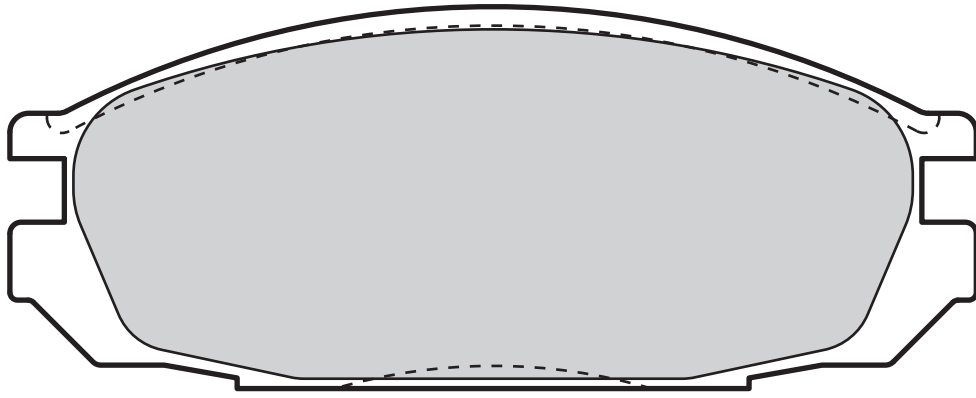

598851	0	127,8	50,5	19	SUMITOMO	NISSAN			

20124 (WVA)

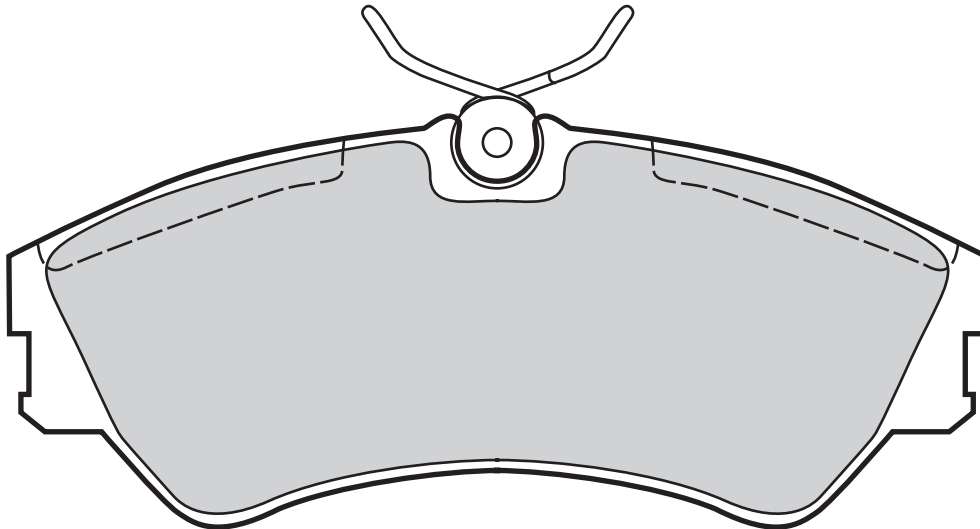

598025	0	130	54,8	19,2	LUCAS	VOLKSWAGEN			



20146 (WVA)

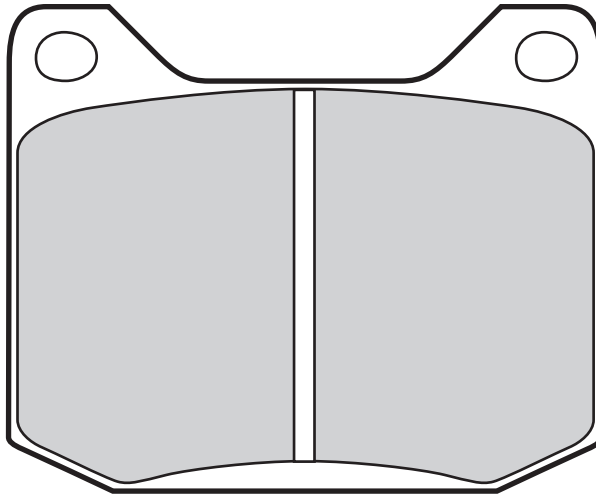

598174

2

76

78,4

64,5

17

LUCAS

PEUGEOT, TALBOT

20152 (WVA)

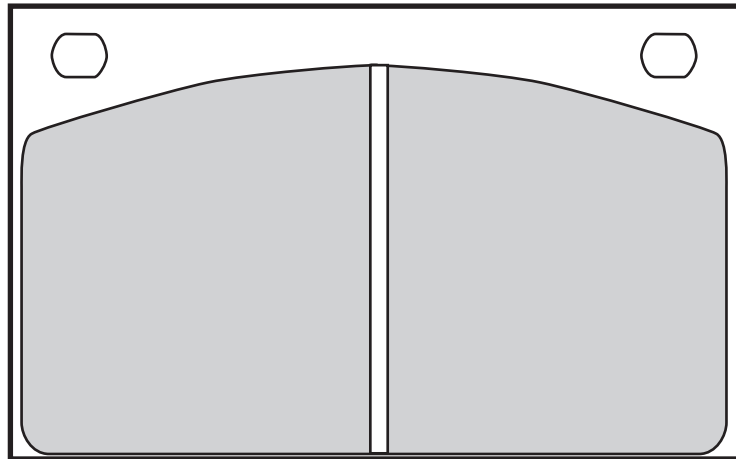

598337

0

98,3

60

16

LUCAS

VOLVO

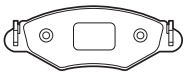

20164 (WVA)

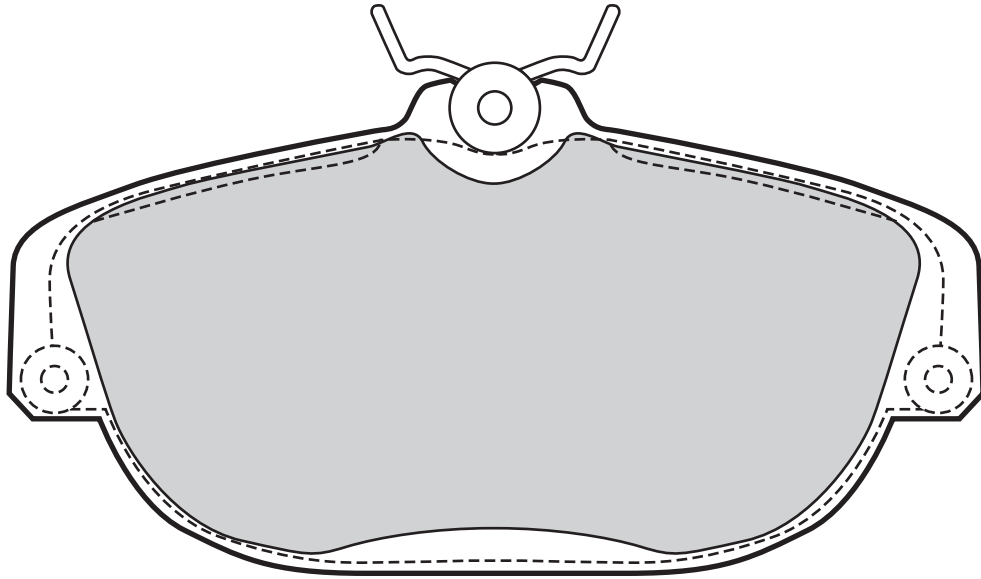

598695

129

65

18,2

LUCAS

VOLVO

20166 (WVA)

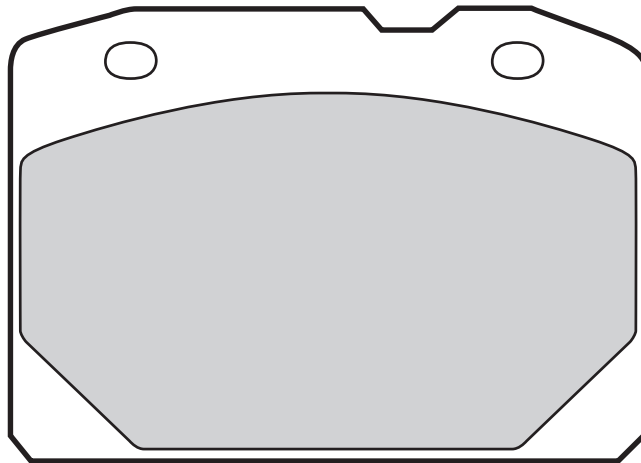

598405

0

83,9

60

16

BENDIX

LADA

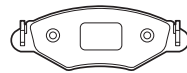

20180 (WVA)

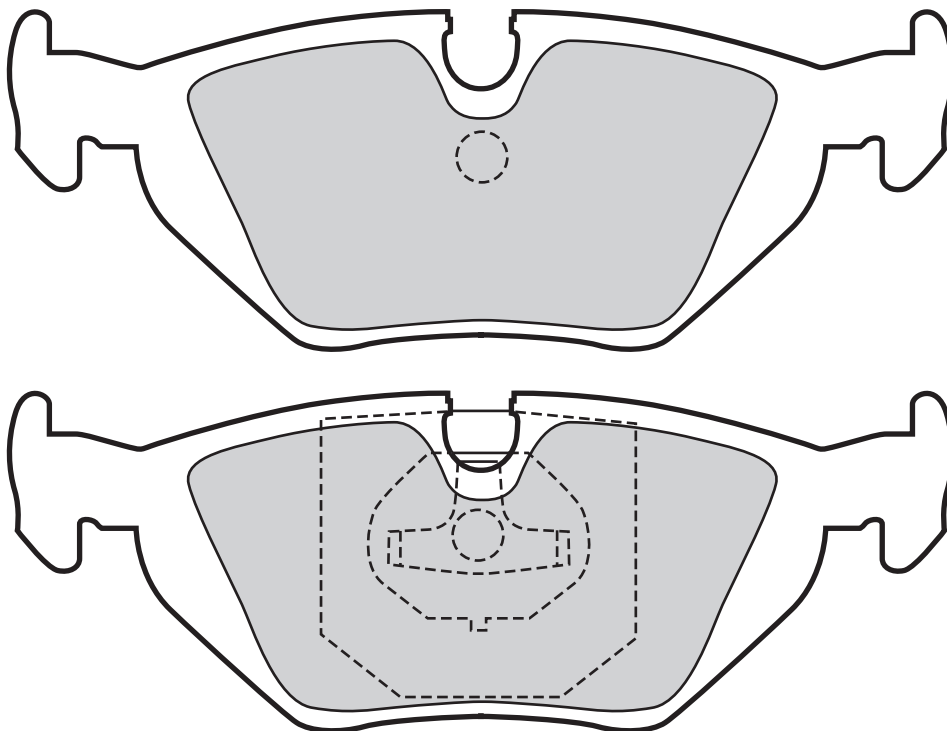

Valeo



0

Valeo



123



45



16,8



TEVES



BMW

598386

20207 (WVA)

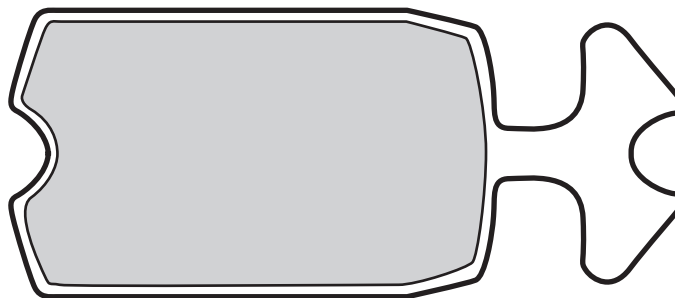

Valeo



0

Valeo



89,5



38



13



CITROEN



CITROËN

598144

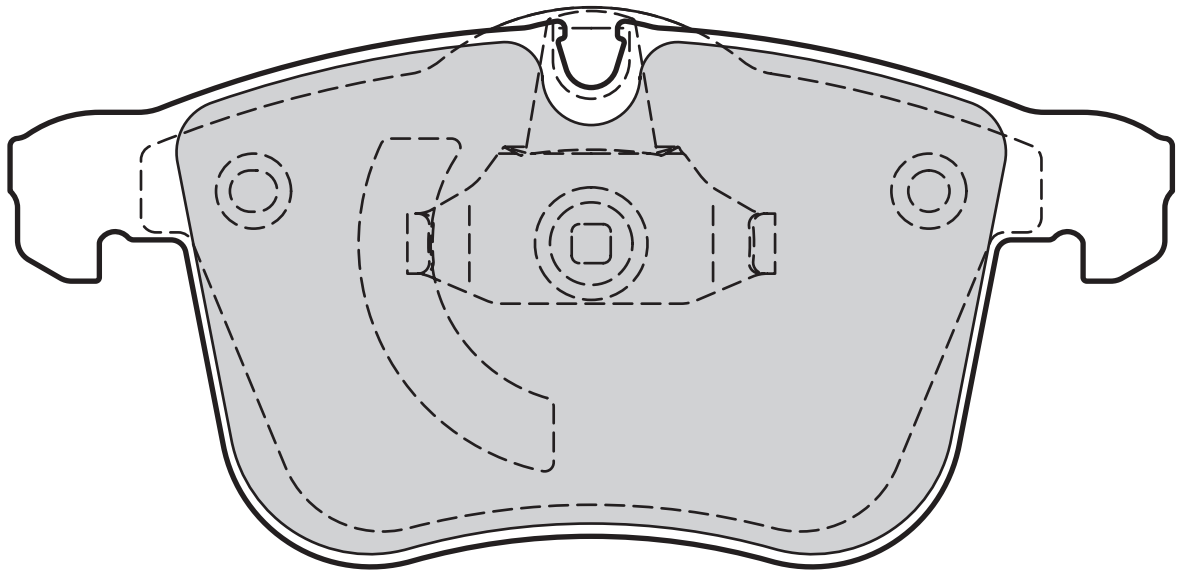
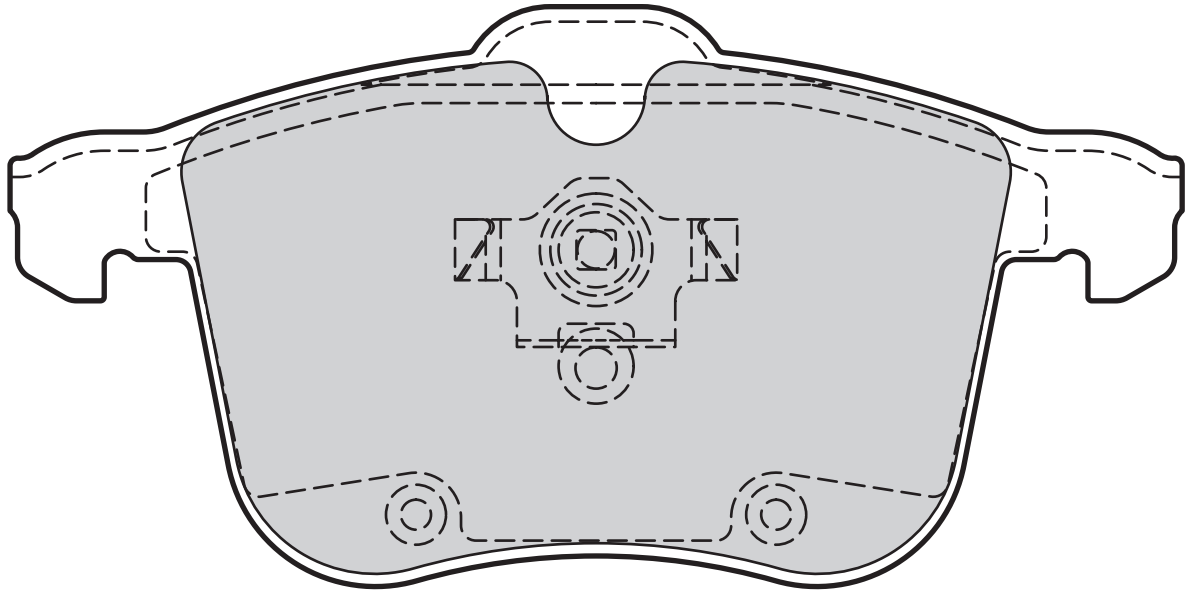
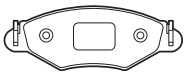

Valeo



Valeo



598808

0

156,2

72,8

20,4

TEVES

CADILLAC, OPEL, SAAB, VAUXHALL

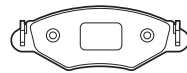

20228 (WVA)

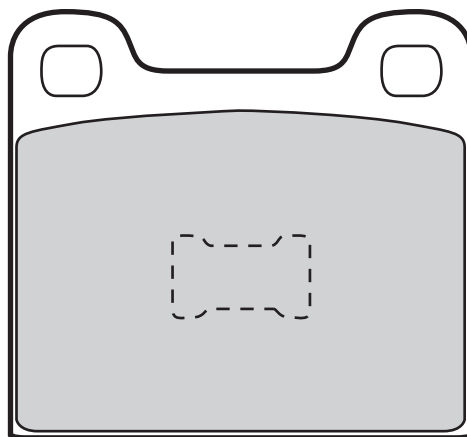

598099

0

61,8

56,6

15

TEVES

ALFA ROMEO, AUDI, BMW, OPEL, SAAB, TALBOT, VOLKSWAGEN

20234 (WVA)

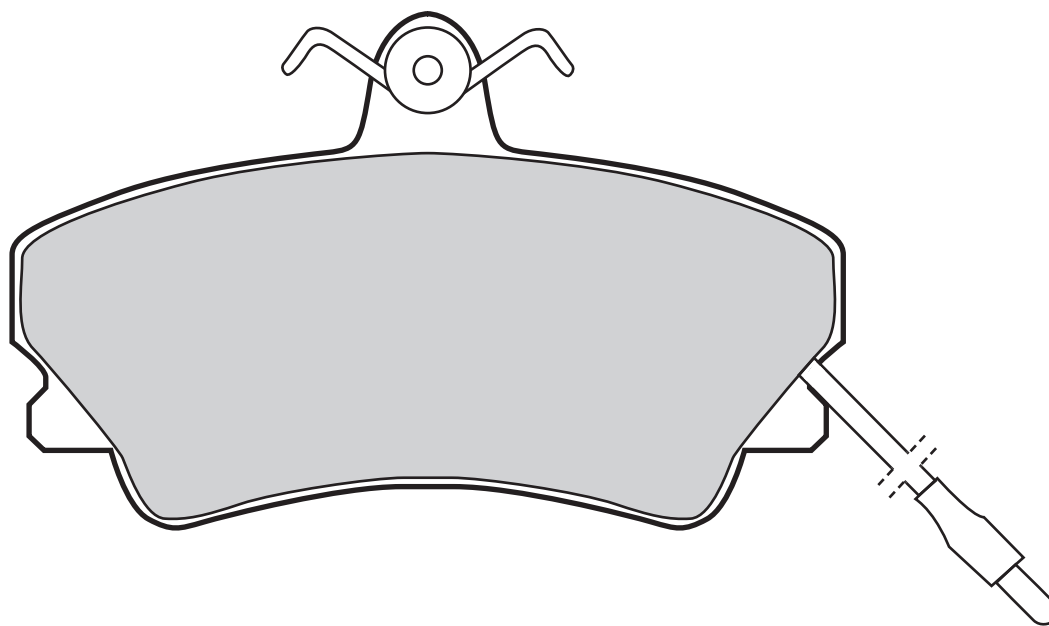

598382

1

110

68

18

LUCAS

RENAULT

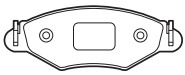

20253 (WVA)

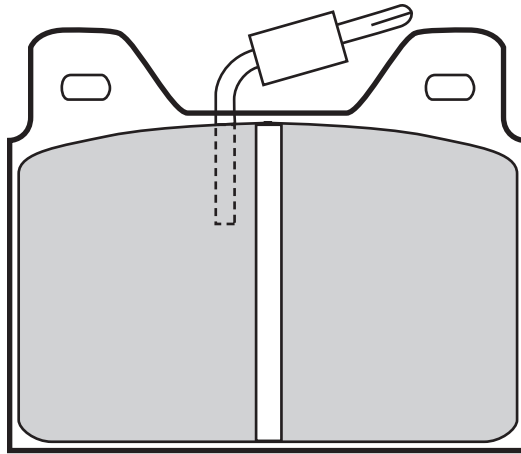

598193	2		68,4	55,2	16,4	LUCAS	PEUGEOT, TALBOT

20261 (WVA)

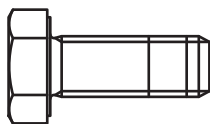
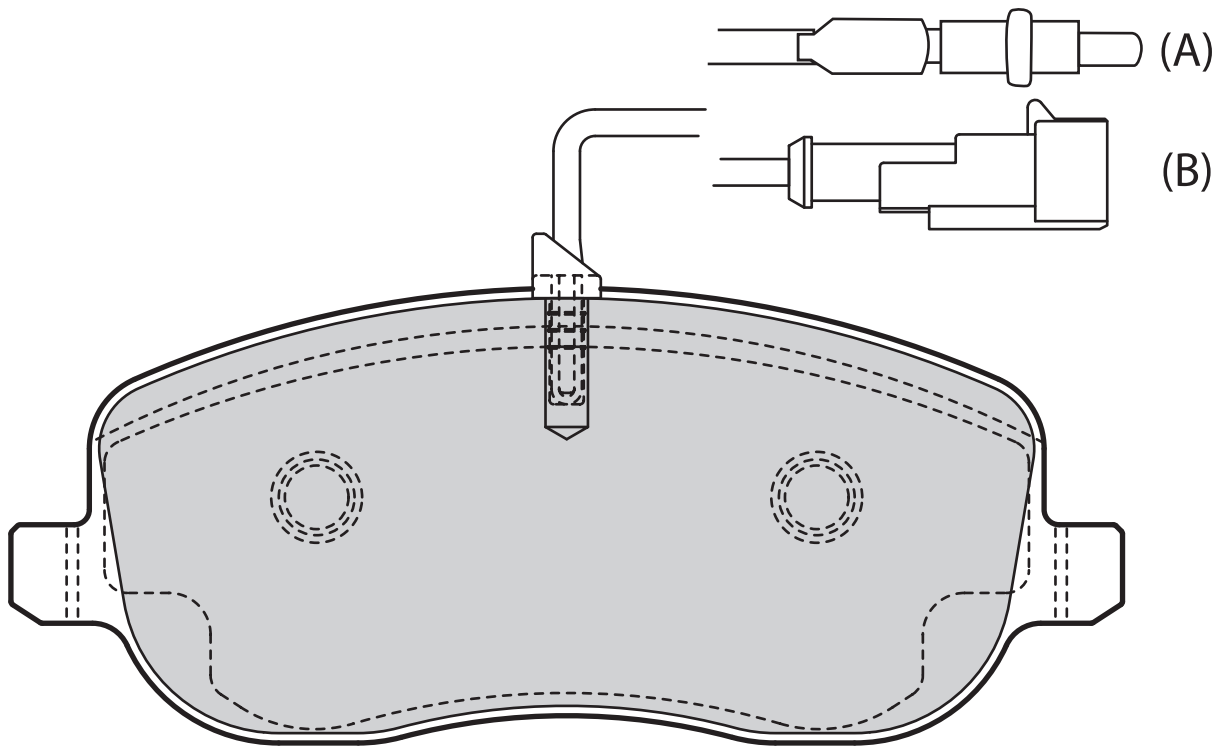

598553	2 (A)	180	147	59,6	19	LUCAS	CITROËN, FIAT, LANCIA, PEUGEOT
598793	2 (B)	190	146,5	59,7	19,3	LUCAS	FIAT

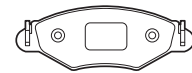

20285 (WVA)

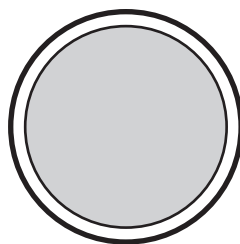

598362	0		30,5	30,5	7	CITROËN	CITROËN

20288 (WVA)

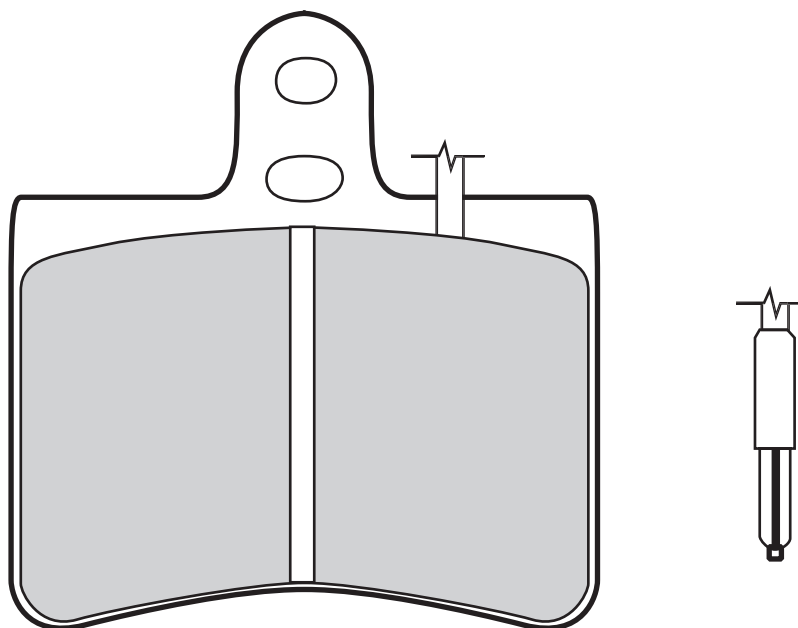

598145	4	74	77,1	82,2	16	CITROËN	CITROËN

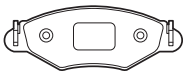

20297 (WVA)

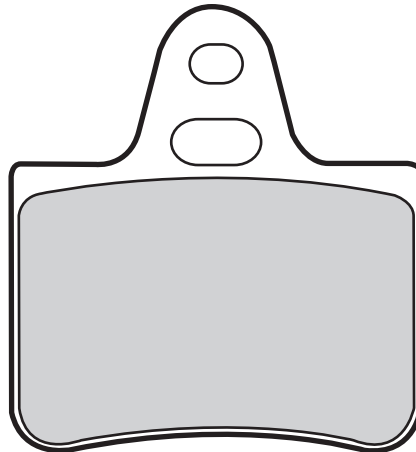

598146	0		54	59,1	12	CITROEN	CITROËN		

20307 (WVA)

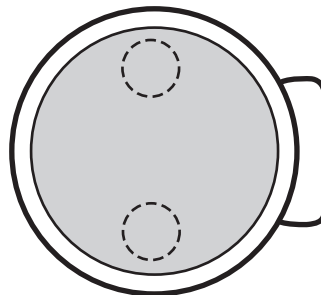

598363	0		37,4	41	9	CITROEN	CITROËN		

20344 (WVA)

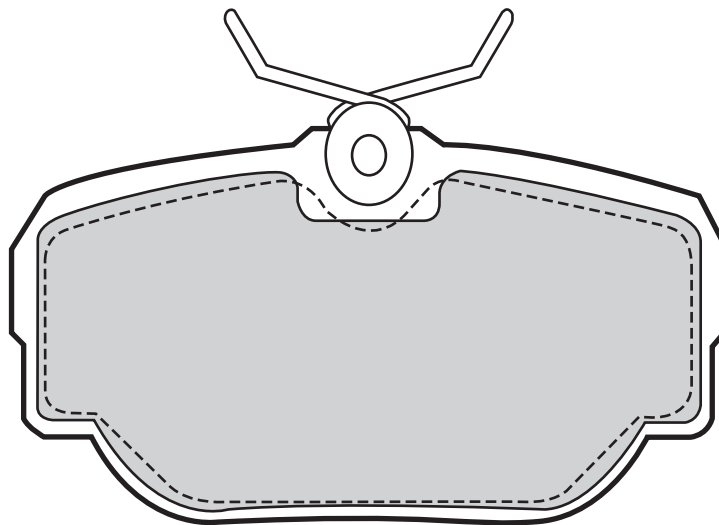

598499	0		95	52,1	16,3	LUCAS	LAND ROVER		

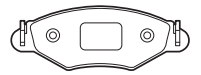

20347 (WVA)

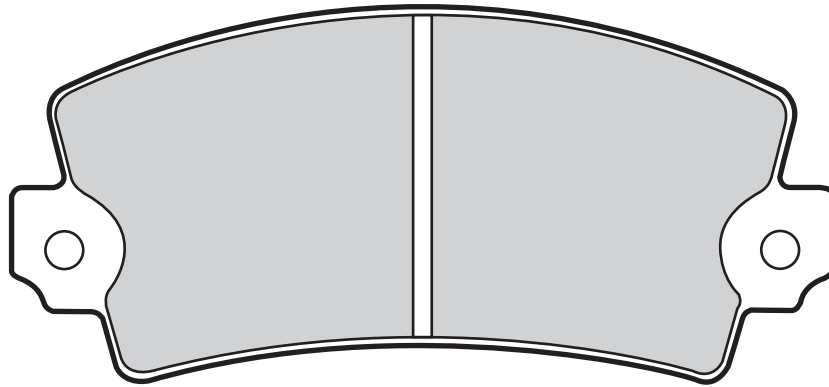

Valeo								
598077	0		108,9	49	14	BENDIX	MAZDA, RENAULT	
598078	2	135	108,9	49	15	BENDIX	PEUGEOT, TALBOT	
598085	2	Plugs	108,9	49	14	BENDIX	ARO, CITROËN, FIAT, RENAULT, TALBOT	
598094	0		109	49	12	BENDIX	LANCIA	

20358 (WVA)

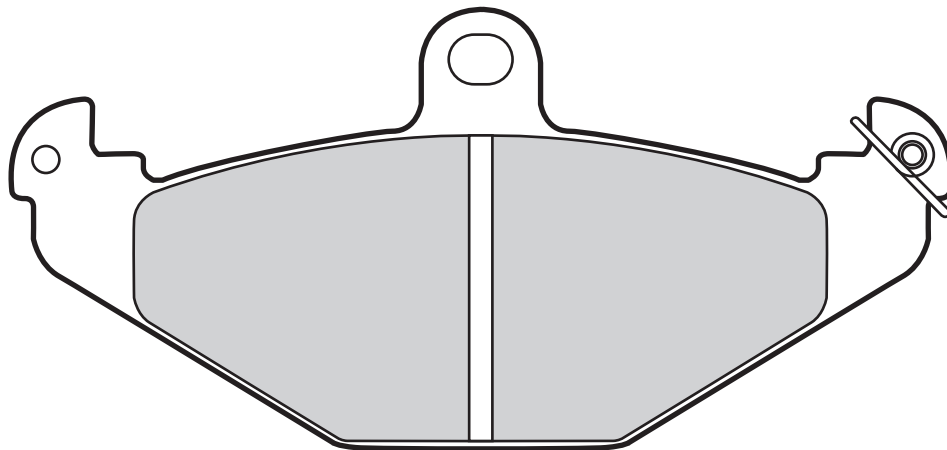

Valeo							
598055	0		126	58,3	15	BREMBO	RENAULT

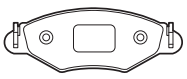

20359 (WVA)

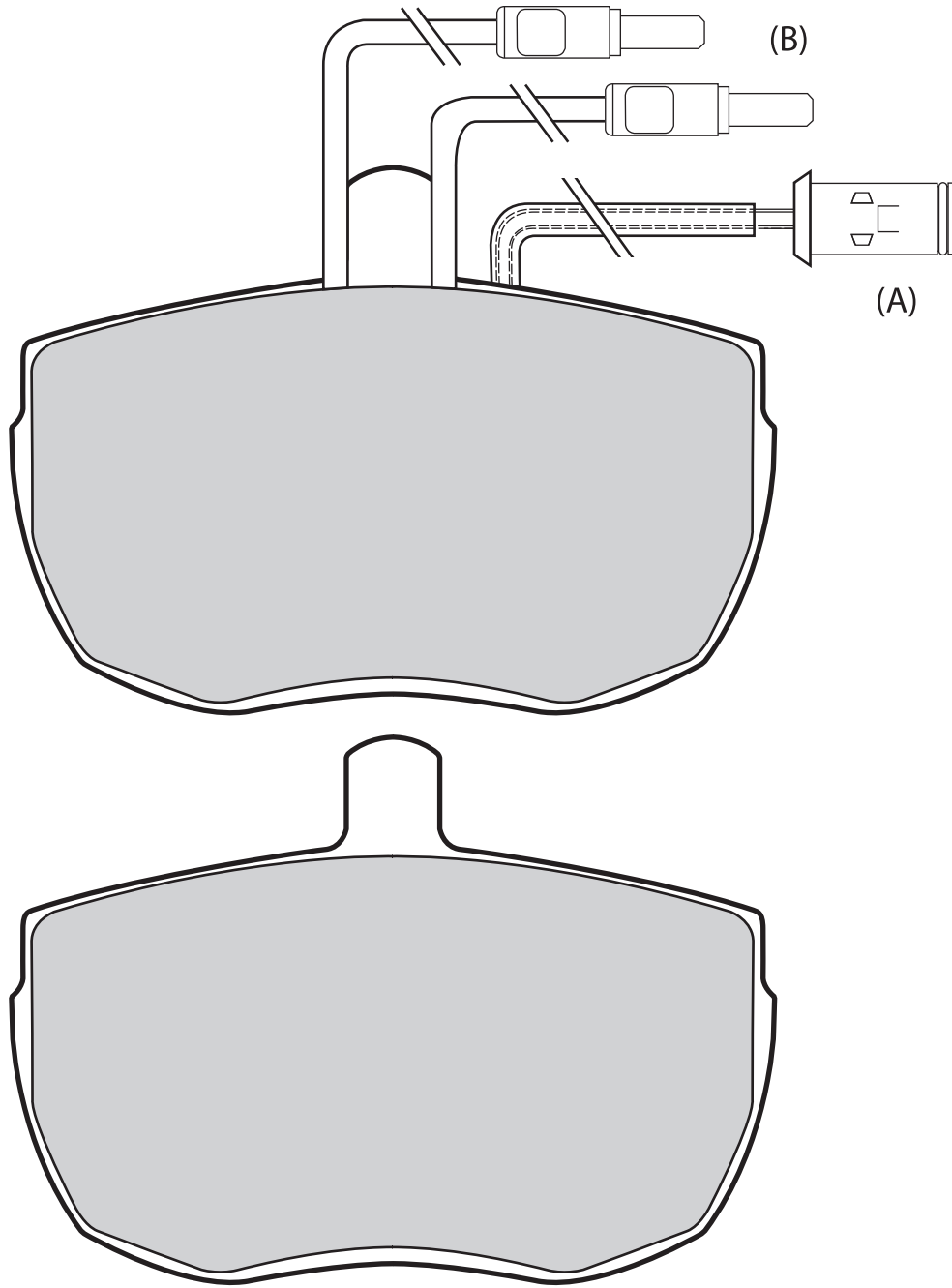

Valeo



Valeo



598129	4 (B)	195/145	105	74,7	18	AP	ALFA ROMEO, DAF, FORD, IVECO, LAND ROVER, LDV
598132	2 (A)	170	105	74,7	18	AP	IVECO
598380	2 (A)	210	104,7	74,7	18	AP	IVECO

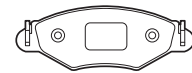

20366 (WVA)

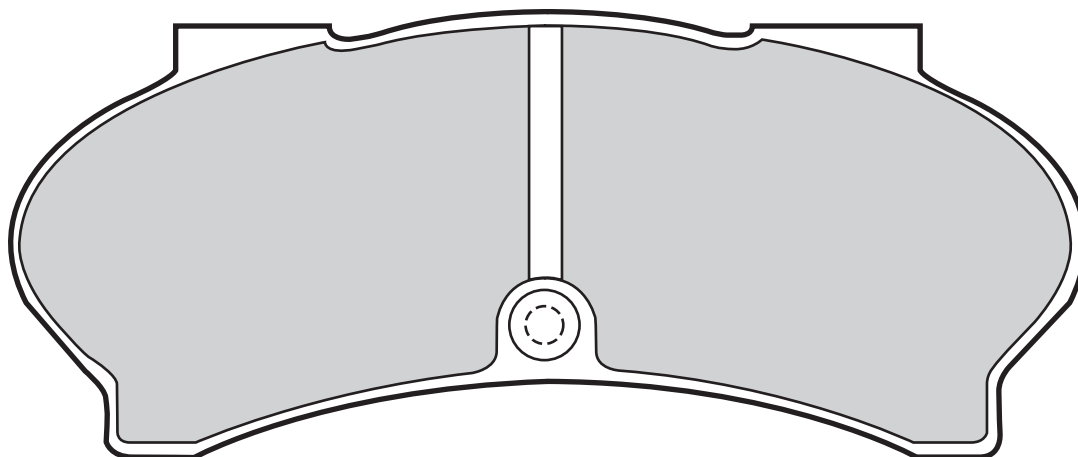

Valeo										
598593	2		144	57	15	BENDIX	PEUGEOT			
598594	2		144	57	18	BENDIX	PEUGEOT			

20371 (WVA)

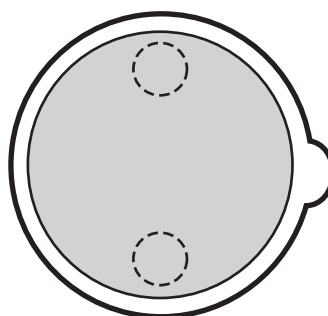

Valeo										
598364	0		39,4	39,4	7,5	CITROEN	CITROEN			

20375 (WVA)

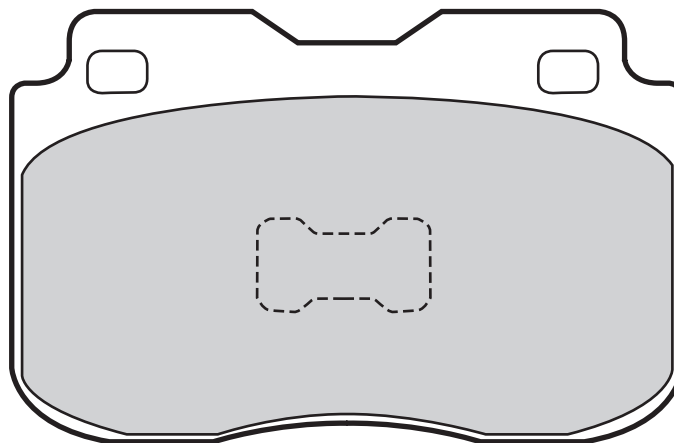

Valeo										
598371	0		89,8	57,5	16	TEVES	FIAT			



20380 (WVA)

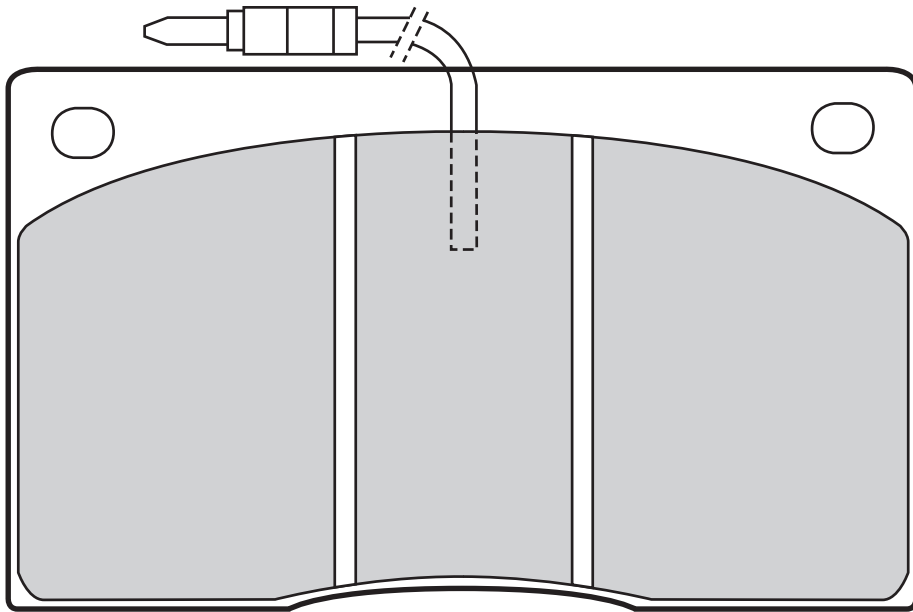

Valeo



Valeo



598374

1

140

119,9

71

15,5

LUCAS

JAGUAR, RENAULT

20387 (WVA)

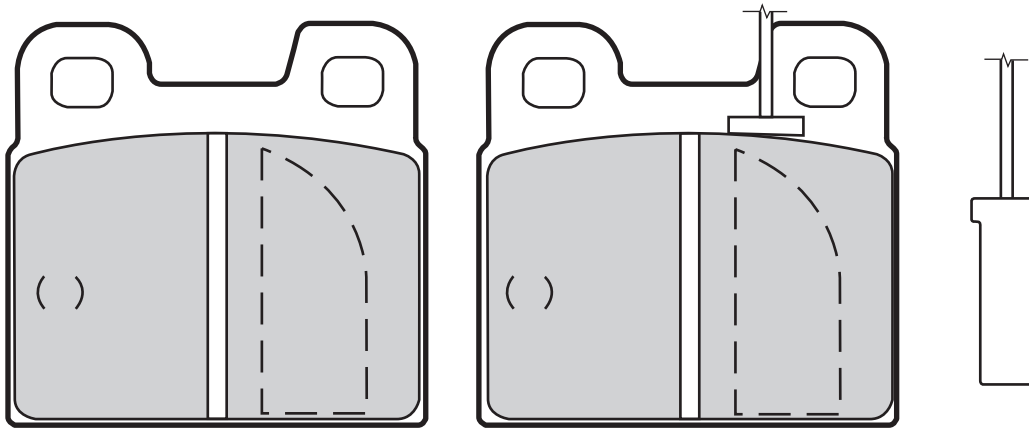

Valeo



Valeo



598351

0

56

53

15

TEVES

ALFA ROMEO

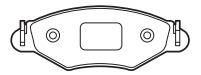

20389 (WVA)

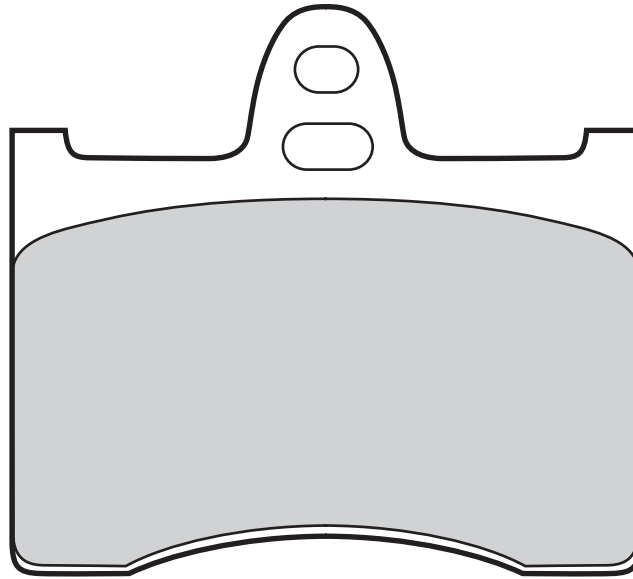

598207

0

83

75

16

CITROEN

CITROËN

20392 (WVA)

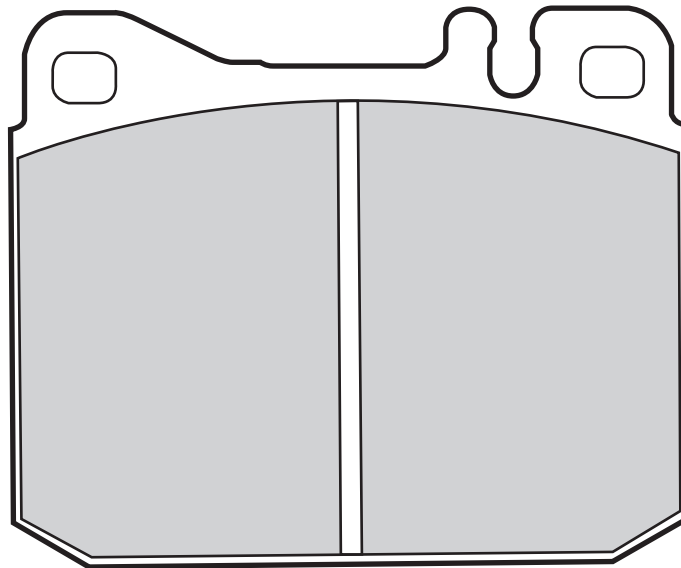

598109

0

90

73,8

15

TEVES

MERCEDES

598110

0

90

73,8

17,5

TEVES

MERCEDES, VOLKSWAGEN



20422 (WVA)

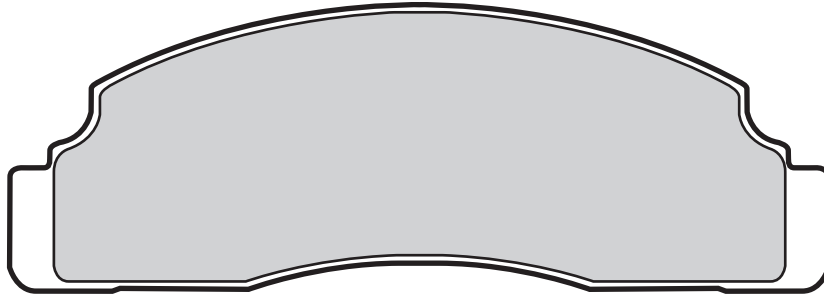

598165

0

108,3

38

17,5

BENDIX

FORD

20437 (WVA)

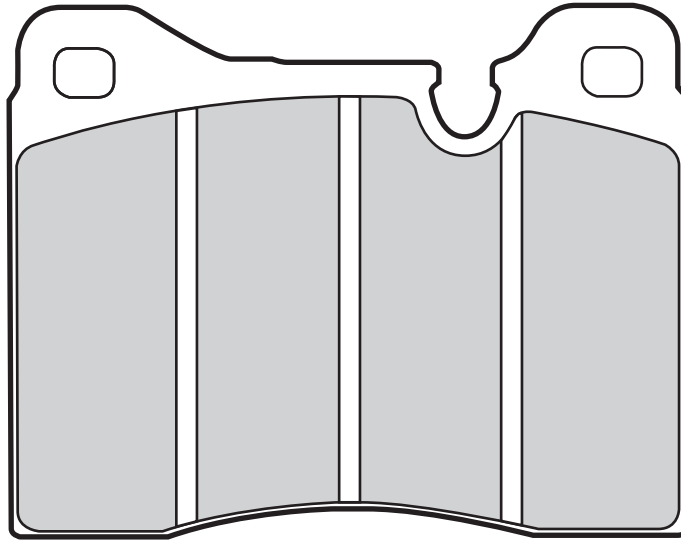

598107

0

89,8

70,7

19

TEVES

ALFA ROMEO, BMW

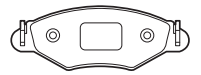

20454 (WVA)

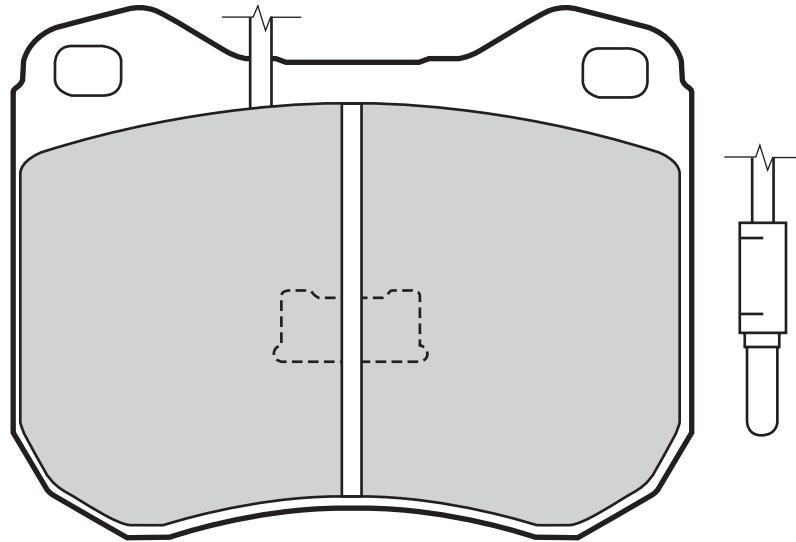

Valeo



Valeo



598178

2

95

89,5

70

19

TEVES

PEUGEOT, TALBOT

20467 (WVA)

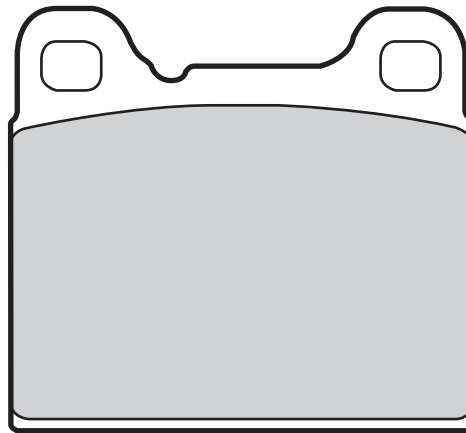

Valeo



Valeo



598270

0

61,5

56,5

15

TEVES

VOLVO



20480 (WVA)

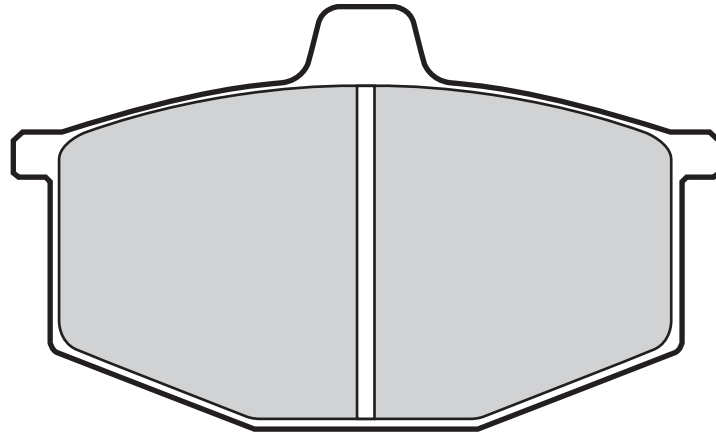

598076

0

93,4

56,3

15,8

LUCAS

RENAULT

20488 (WVA)

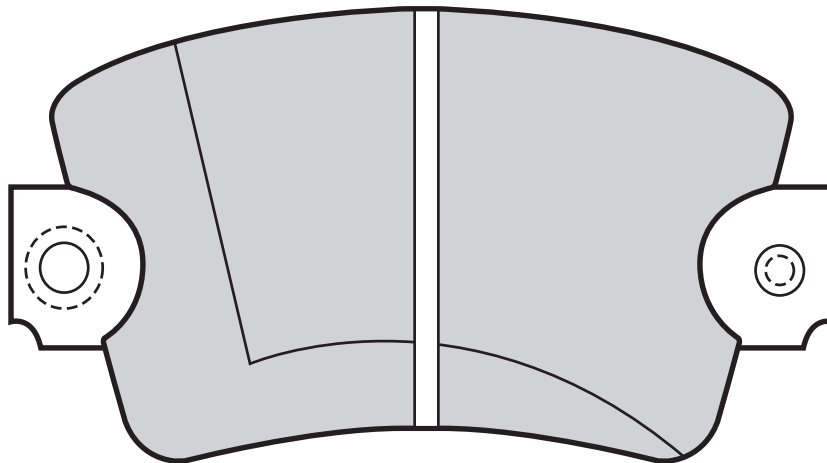

598366

2

108,5

60

18,5

BENDIX

RENAULT



20491 (WVA)

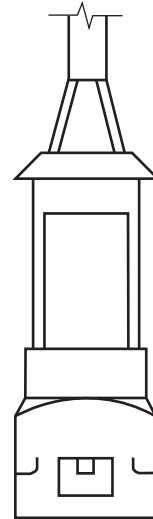
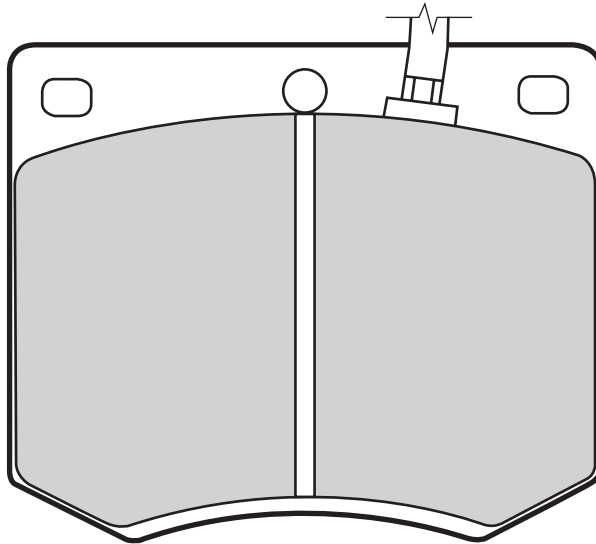

Valeo



2

Valeo



265



78,4



66,2



15,1



LUCAS



FORD, HYUNDAI

598168

20512 (WVA)

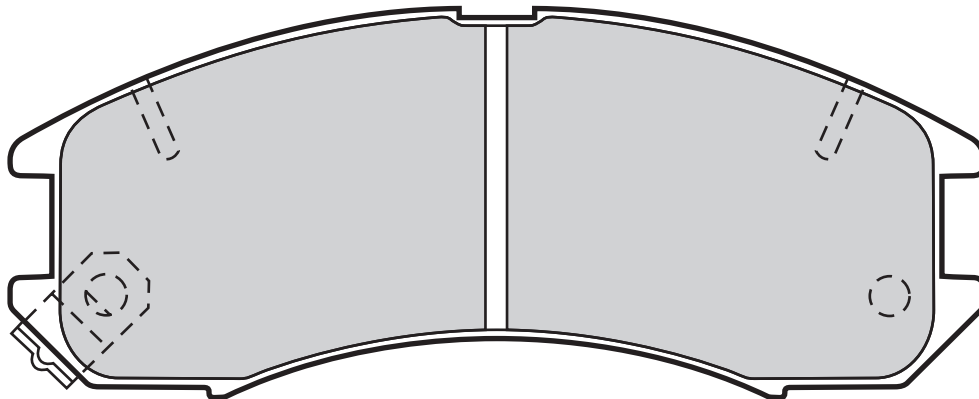

Valeo



2

Valeo



Leaf



128



57



16,5



AKEBONO



mitsubishi

598597



20566 (WVA)

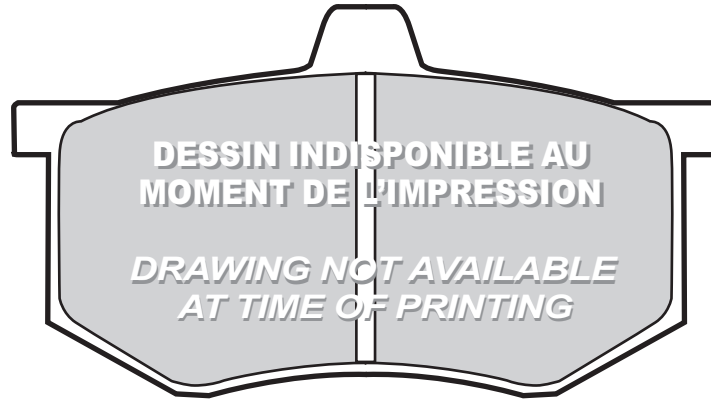

Valeo



0

Valeo



200



107



65,7



15,5



SUMITOMO



TOYOTA



20573 (WVA)

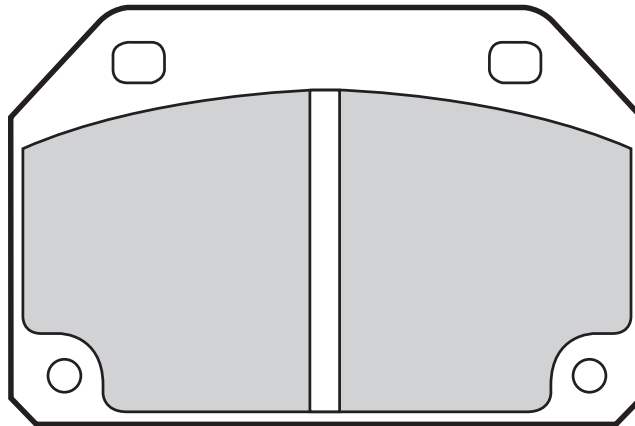

Valeo



2

Valeo



200



83,7



55



15



BENDIX



TALBOT



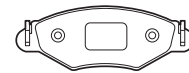

20574 (WVA)

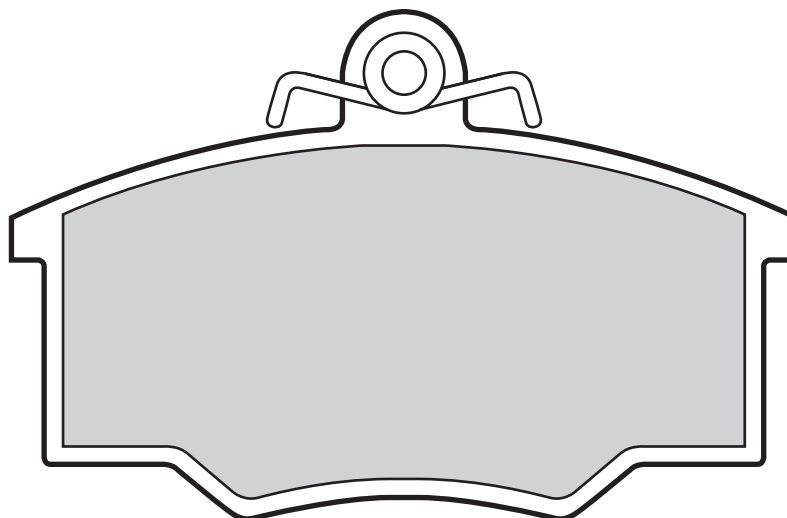

Valeo							
598205	0		104,4	66,5	19,6	LUCAS	AUDI, VOLKSWAGEN, VOLVO
598214	0		104,4	66,5	15,3	LUCAS	AUDI

20575 (WVA)

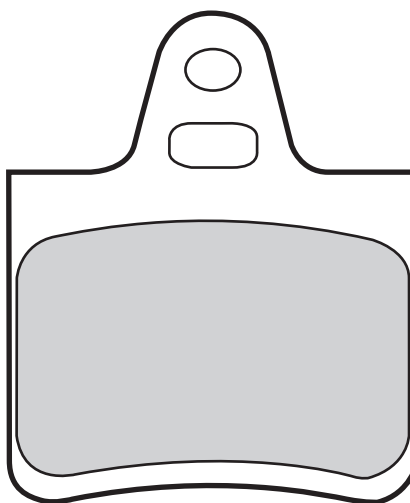

Valeo							
598148	0		54,2	64,9	16,8	CITROEN	CITROËN
598292	0		54	65	15,4	CITROEN	CITROËN



Valeo

20576 (WVA)

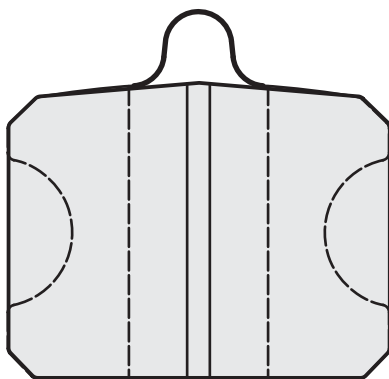

Valeo



0

Valeo



195



50,4



48,5



15,4



BENDIX



SKODA



20579 (WVA)

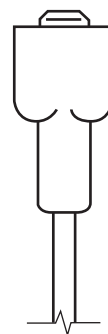
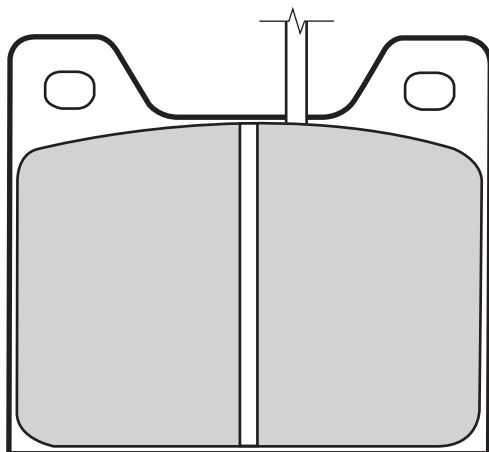

Valeo



2

Valeo



195



63,5



55,2



14,4



LUCAS



TALBOT

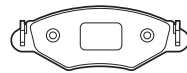

20588 (WVA)

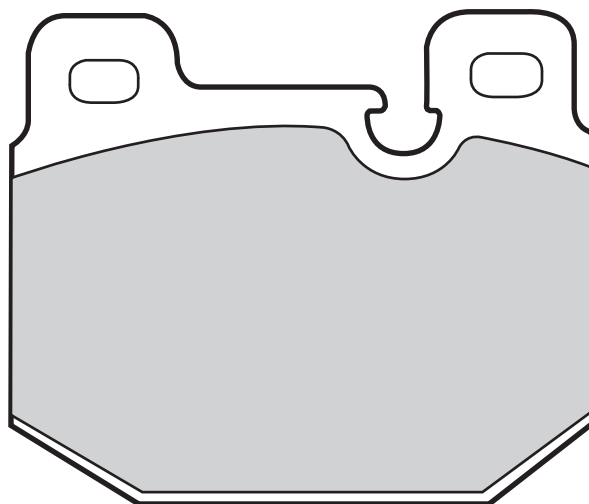

598108

0

77

65,5

16,5

TEVES

ALFA ROMEO, BMW, OPEL, VAUXHALL

20594 (WVA)

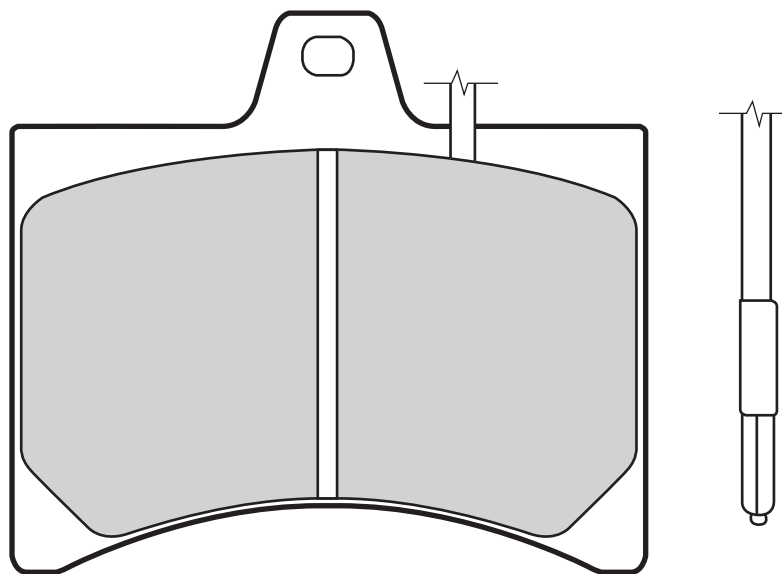

598150

4

150

84,1

74,4

13

CITROEN

CITROËN, PEUGEOT



20629 (WVA)

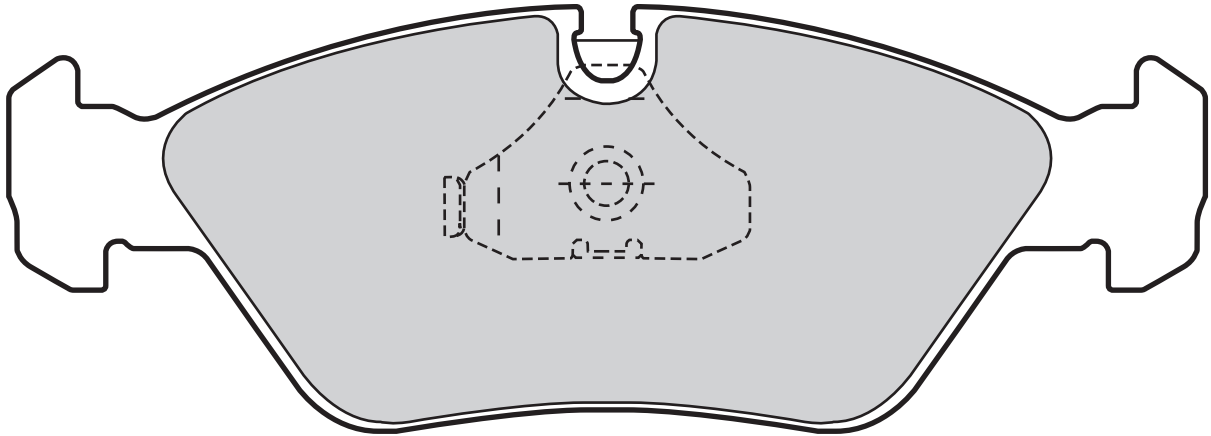

598104

0

158,3

57

20

TEVES

BMW

20631 (WVA)

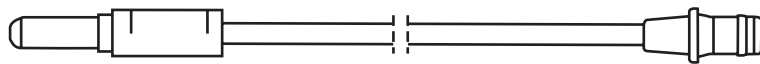
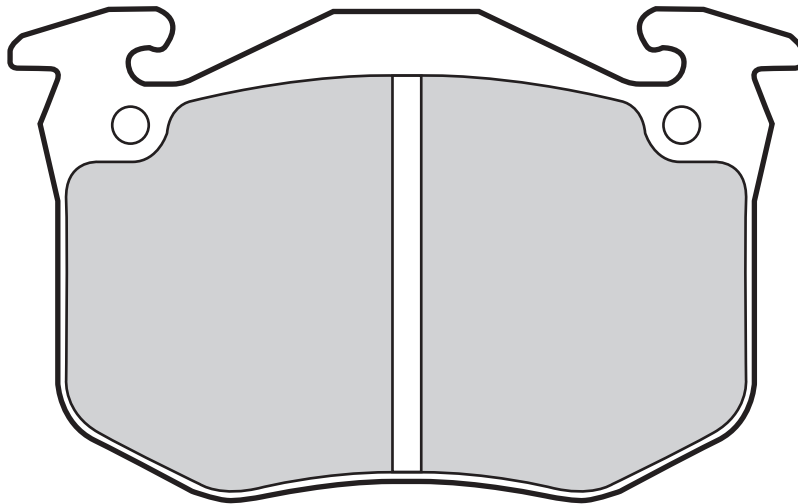

598175

2

130

105

65

18

BENDIX

PEUGEOT, RENAULT

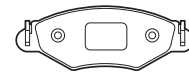

20635 (WVA)

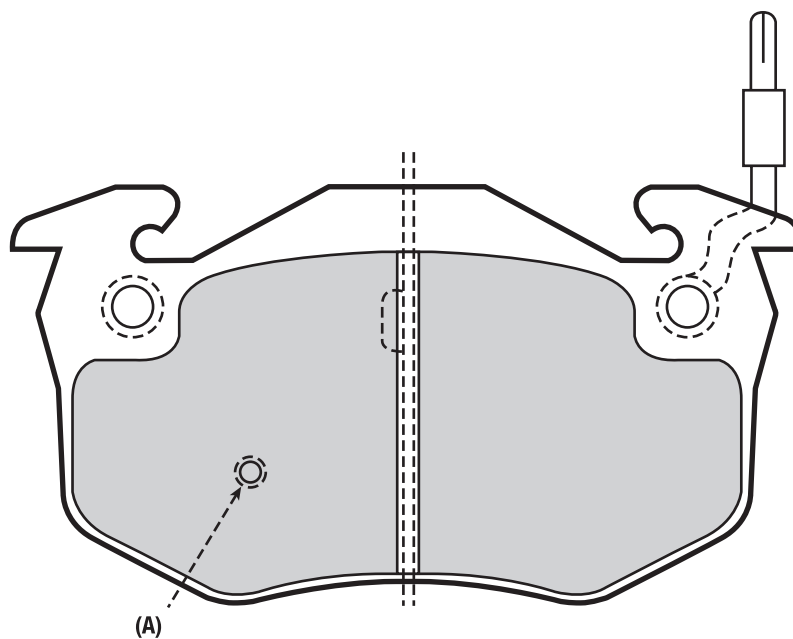

Valeo								
598080	2	210	105	54,7	15	BENDIX	RENAULT	
598151	4	160/245	105	54,7	18	BENDIX	CITROËN, RENAULT	
598158	0		105	54,7	11	BENDIX	RENAULT	
598177	2		105	54,7	18	BENDIX	PEUGEOT, TOYOTA	
598396	0		105	54,7	11	BENDIX	CITROËN, PEUGEOT, RENAULT	

20647 (WVA)

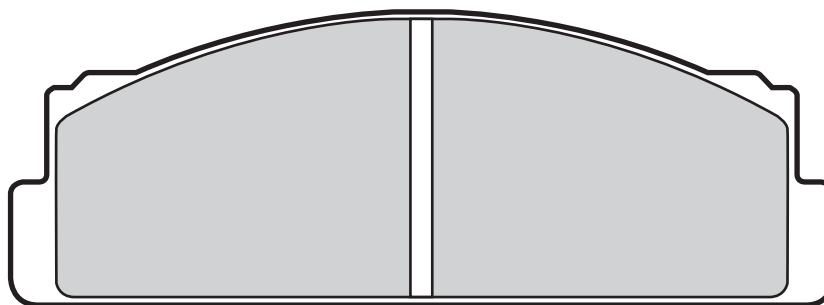

Valeo								
598088	0		109	39	10	BENDIX	FIAT, FSO POLSKI, SEAT, TALBOT, YUGO/ZASTAVA	
598090	2		109	39	17,3	BENDIX	FIAT, INNOCENTI, LANCIA, SEAT	
598603	0		109	39	17,5	BENDIX	AUTOBIANCHI, FSO POLSKI, SEAT, YUGO/ZASTAVA	



Valeo

20652 (WVA)

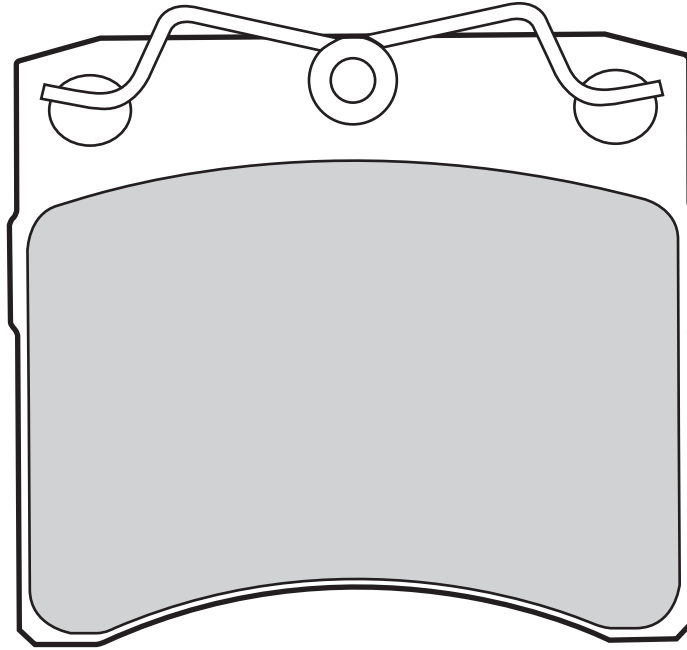

Valeo



Valeo



598048

0

91,5

80

18,3

LUCAS

VOLKSWAGEN

20655 (WVA)

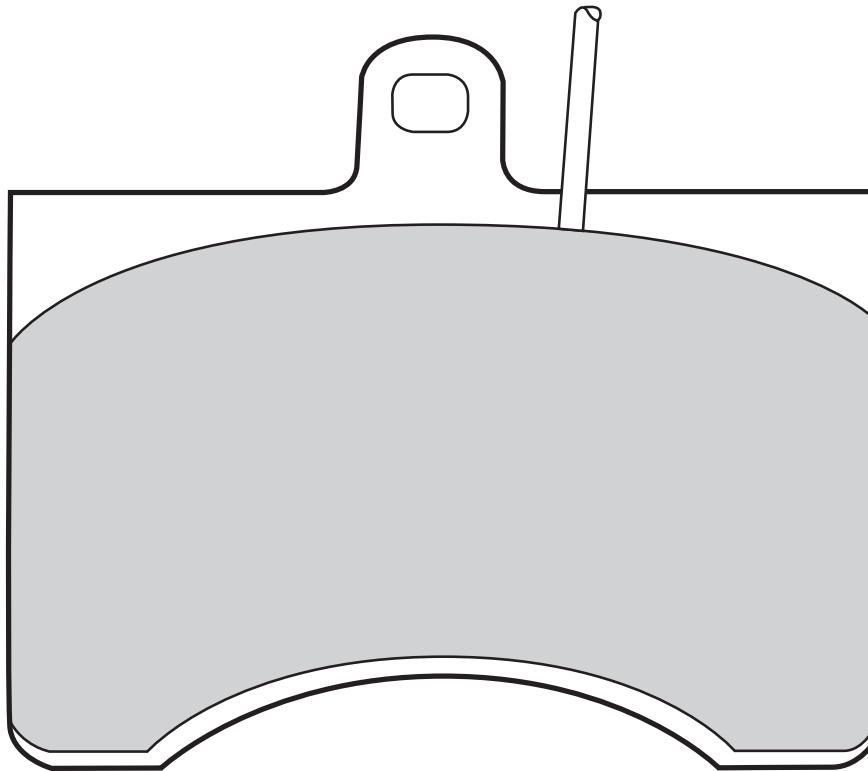

Valeo



Valeo



598591

4

145

114

97

19,5

CITROEN

CITROËN



20660 (WVA)

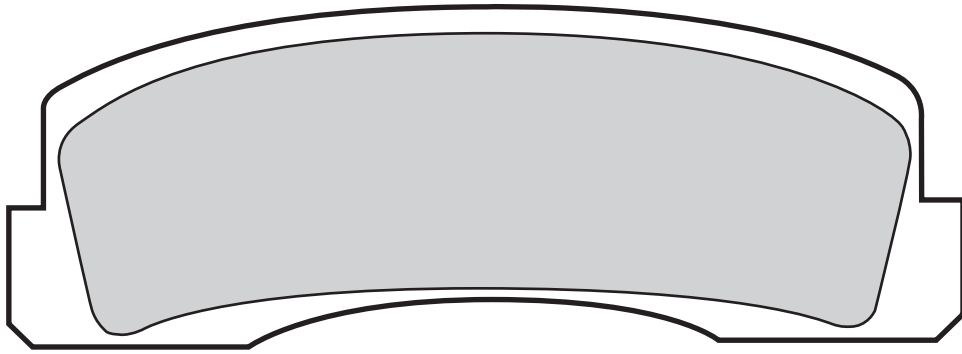

Valeo



Valeo



598389

0

126

45

16

BENDIX

LADA

20661 (WVA)

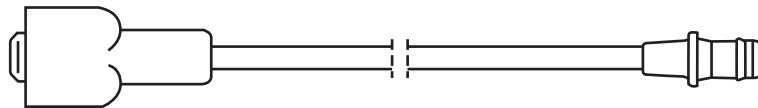
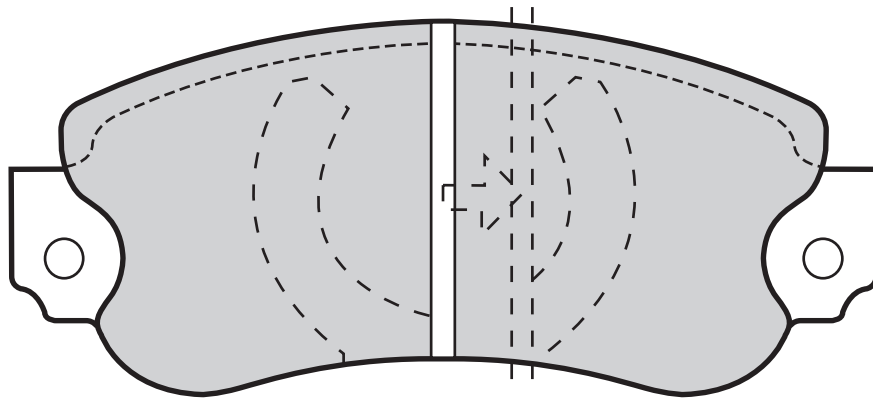

Valeo



Valeo



598162

2

200

114,8

49,8

18

BENDIX

TALBOT



20668 (WVA)

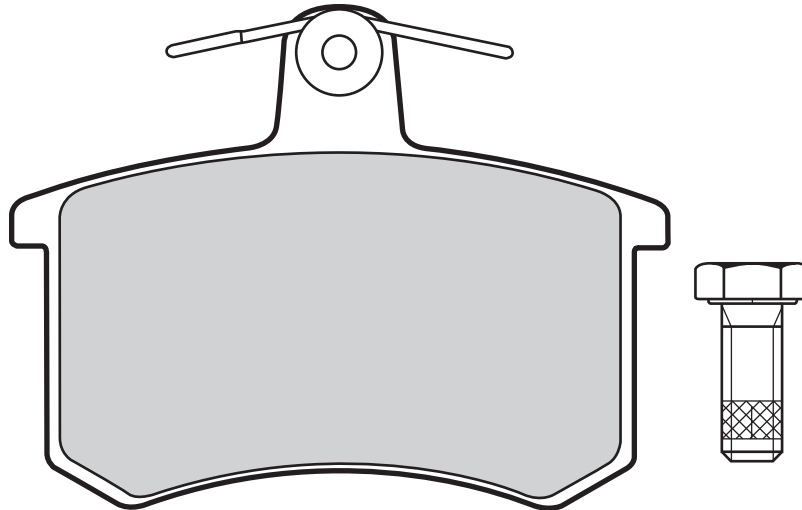

598125

0

87

66,9

16,6

LUCAS

ALFA ROMEO, AUDI, FIAT, LANCIA

20671 (WVA)

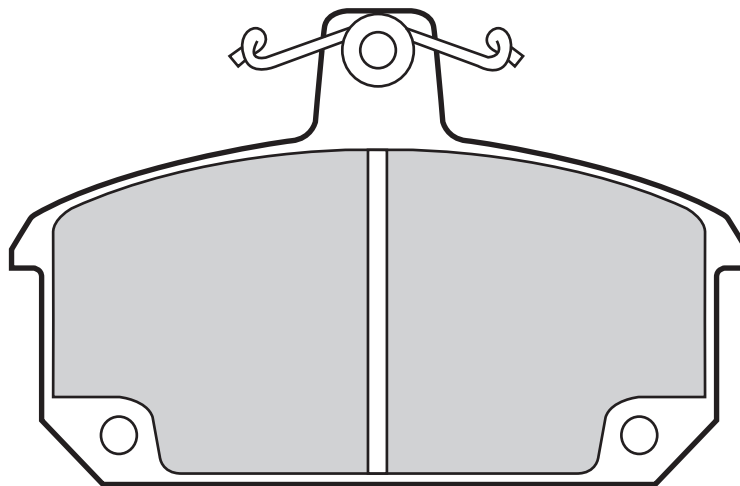

598377

2

98

64

16,2

LUCAS

RENAULT

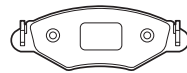

20675 (WVA)

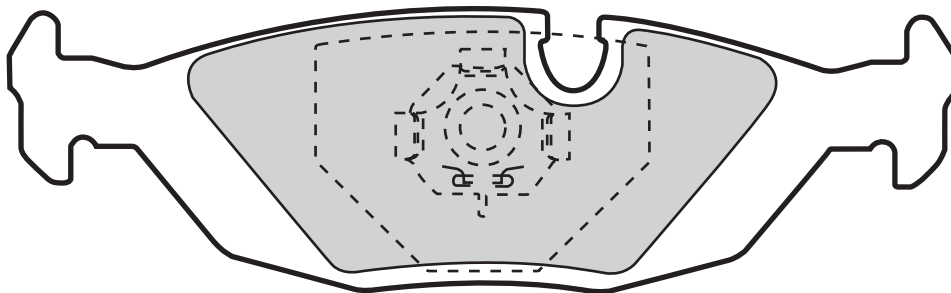

Valeo



Valeo



598103

0

125,2

37,6

17,3

TEVES

BMW

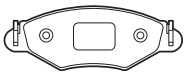

20676 (WVA)

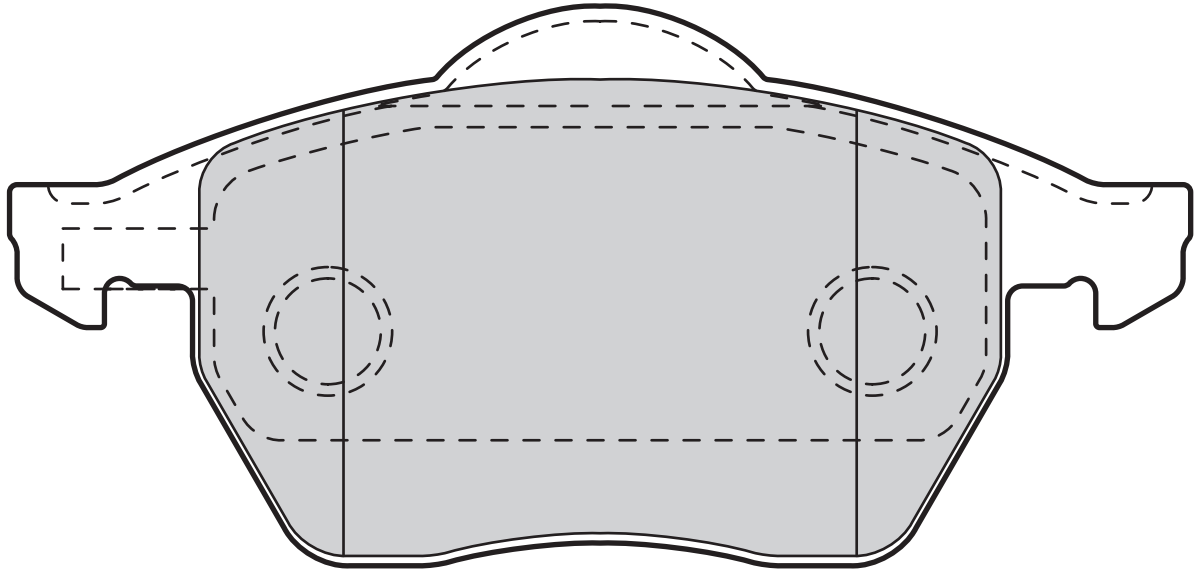
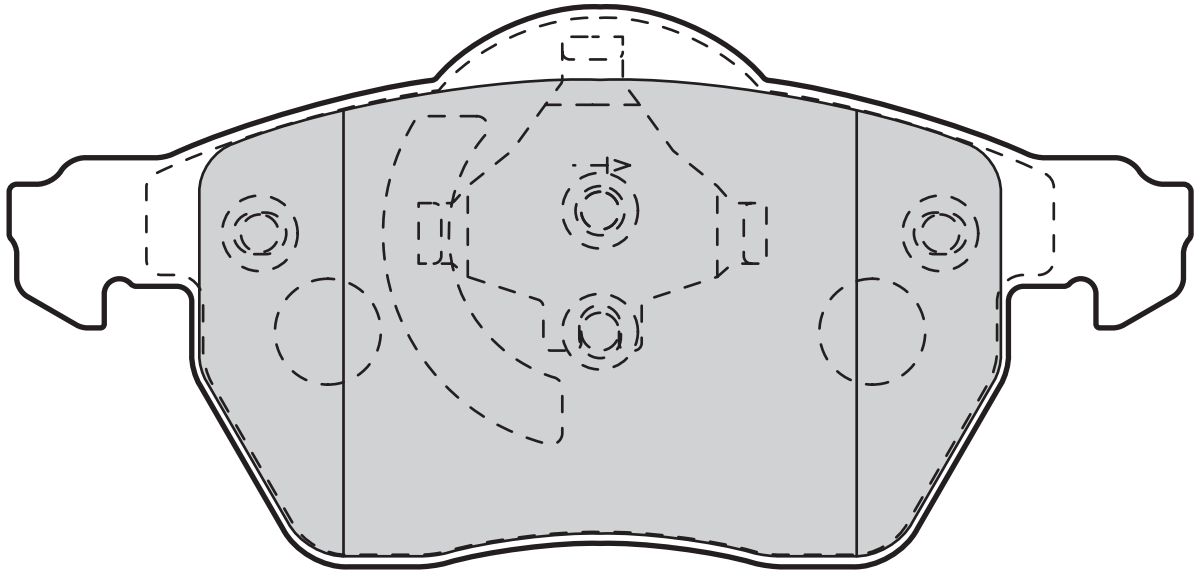

Valeo



Valeo



598067
598483
598489
598751
601006

0
2 (A)
1 (A)
2 (A)
0

210
210
210

156,3
156,4
156,4
156,4
156,2

74
74,2
74,2
74,2
74/74,1

19,8
20,3
19,5
19,2
19,9

TEVES
TEVES
TEVES
TEVES
TEVES

FORD, SEAT, VOLKSWAGEN
AUDI, SEAT, SKODA, VOLKSWAGEN
FORD, SEAT, VOLKSWAGEN
AUDI, SKODA, VOLKSWAGEN
SAAB

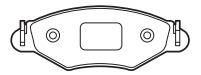

20687 (WVA)

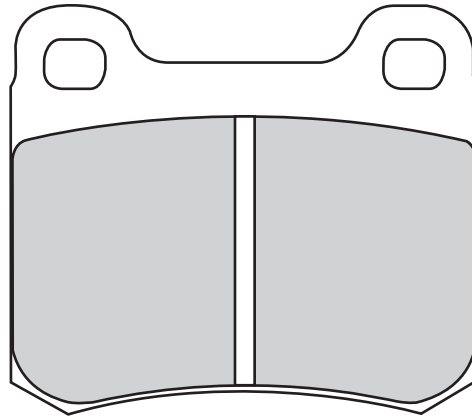

Valeo



Valeo



598105
598345

0
0

61,8
61,7

54,3
54,3

13
15,5

TEVES
TEVES

MERCEDES
MERCEDES

20690 (WVA)

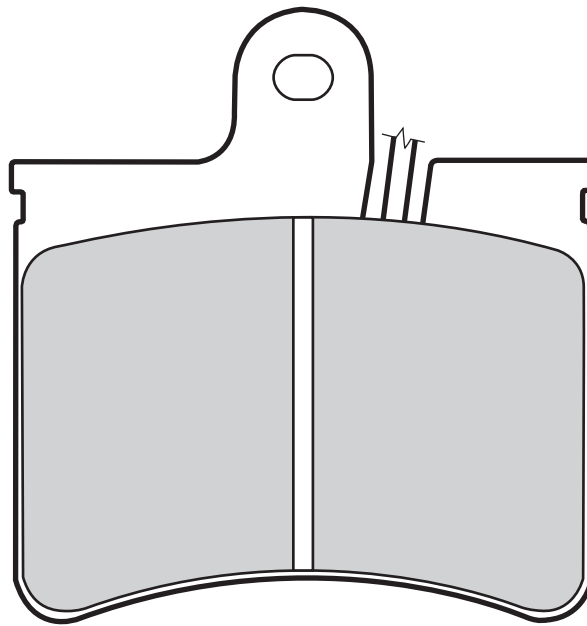

Valeo



Valeo



598149

4

90

78

81,4

16

CITROEN

CITROËN



20706 (WVA)

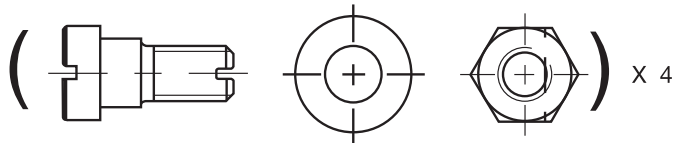
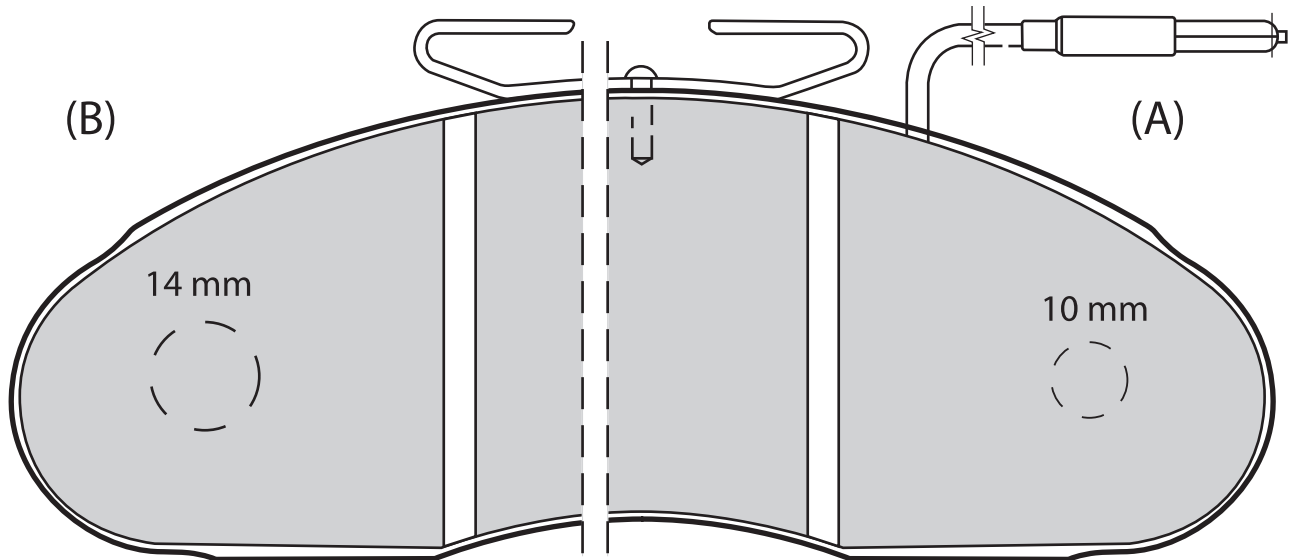

Valeo									
598001	2 (A)	166	166,5	62	17	BENDIX	NISSAN		
598112	0 (B)		166,5	62	17	BENDIX	MERCEDES, NISSAN		

20708 (WVA)

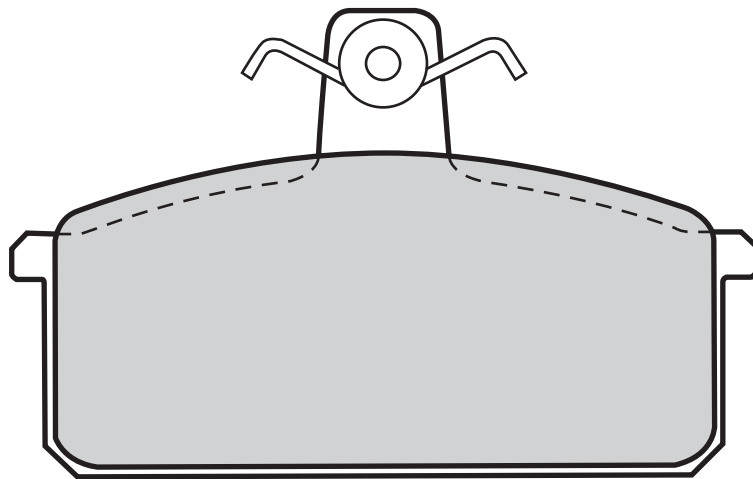

Valeo									
598093	2	120	98,8	61,5	16	LUCAS	LANCIA, SEAT		
598531	0		99	61,5	14,5	LUCAS	SANTANA, SUZUKI		



20718 (WVA)

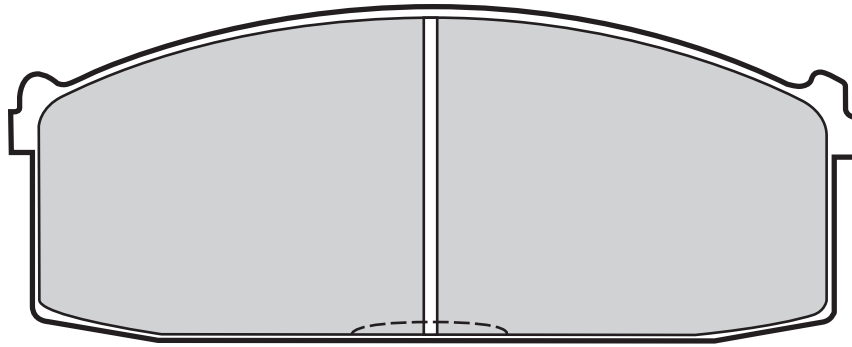

Valeo



Valeo



598379

0

112

44,5

14,5

AKEBONO

NISSAN

20729 (WVA)

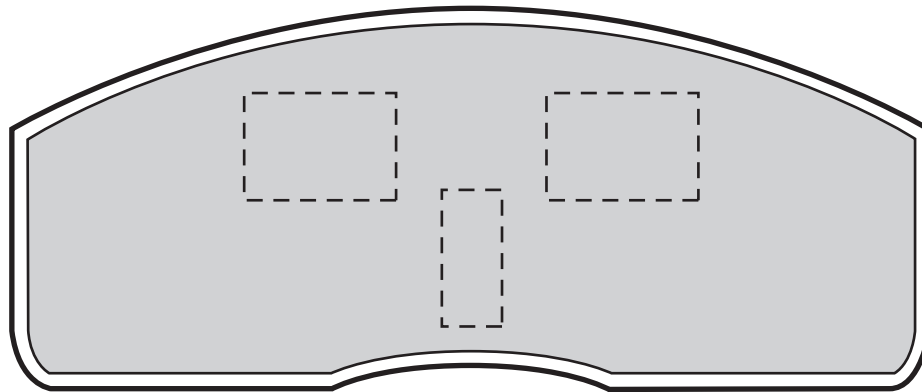
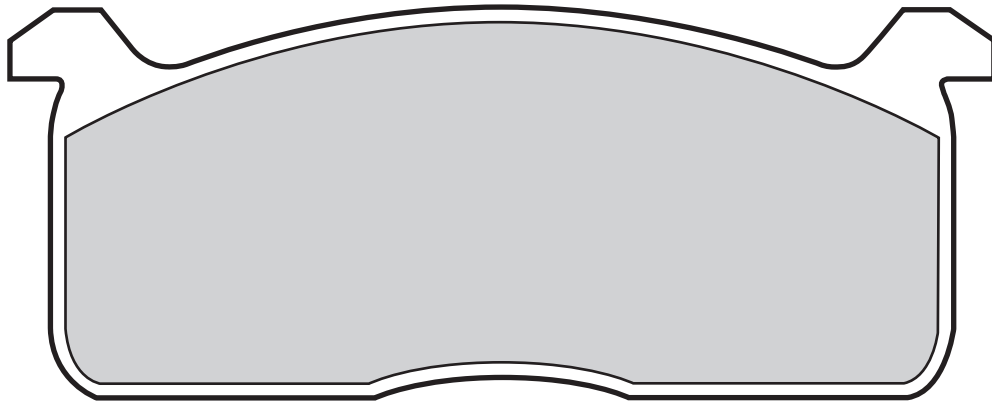

Valeo



Valeo



598614

0

132/120

51/50,3

15

AKEBONO

TOYOTA



20731 (WVA)

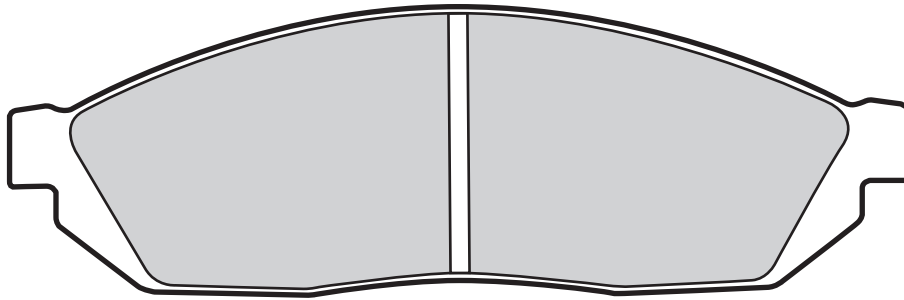

598185	0		119,5	38	15,5	SUMITOMO	HONDA, MARUTI, ROVER, SUZUKI		

20735 (WVA)

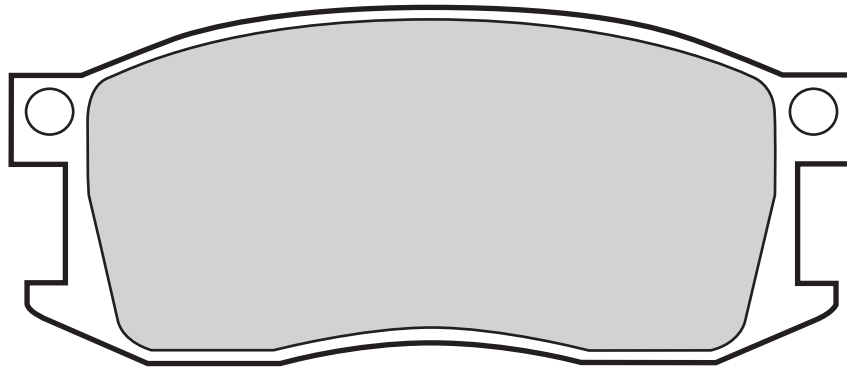

598208	0		111,4	47	15,4	SUMITOMO	HONDA		

20740 (WVA)

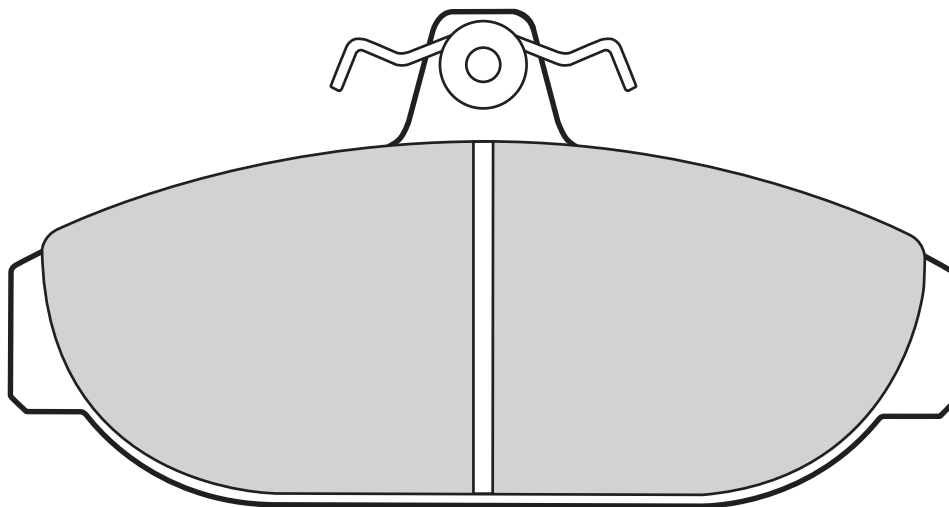

598221	0		124,9	65	17,5	LUCAS	VOLVO		



20741 (WVA)

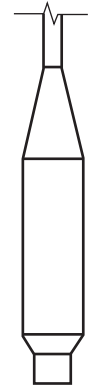
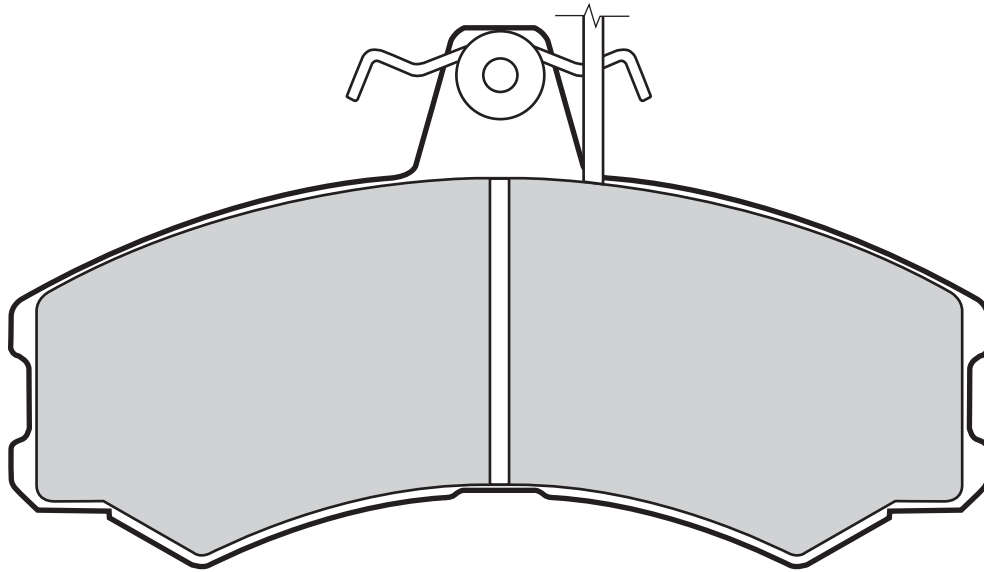

Valeo



Valeo



598153

2

130

130

71

19,2

LUCAS

AUVERLAND, CITROËN, FIAT, PEUGEOT

20754 (WVA)

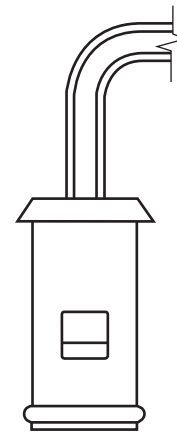
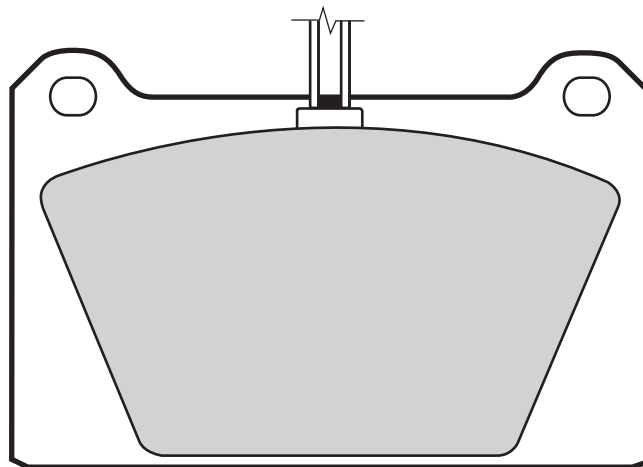

Valeo



Valeo



598116

2

152

84

55

15

AP

RELIANT, ROVER



20756 (WVA)

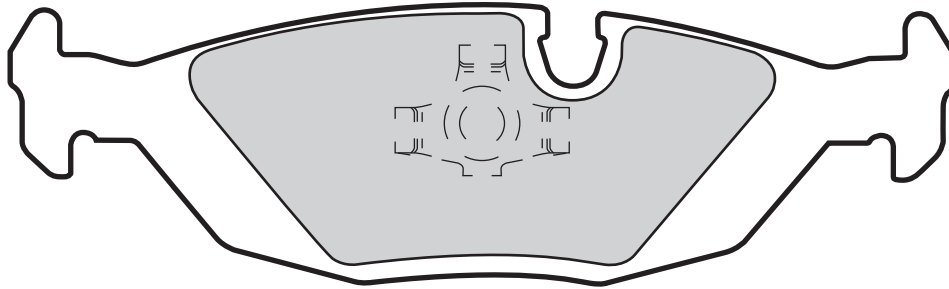

598291	0	125	37,4	15	TEVES	SAAB, VOLVO		

20760 (WVA)

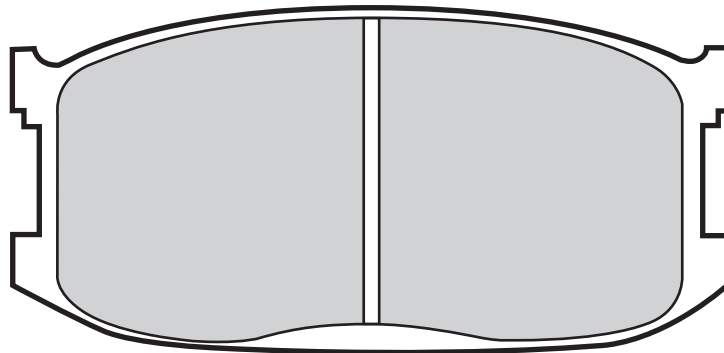

598612	0	95	45,3	14,3	SUMITOMO	MAZDA		

20761 (WVA)

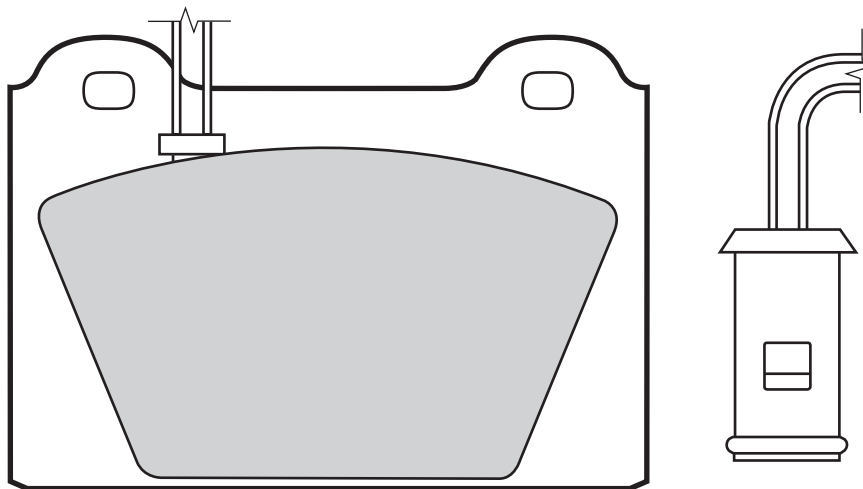

598117	2	83,8	59,2	14,5	TEVES	ROVER		

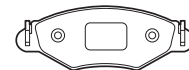

20772 (WVA)

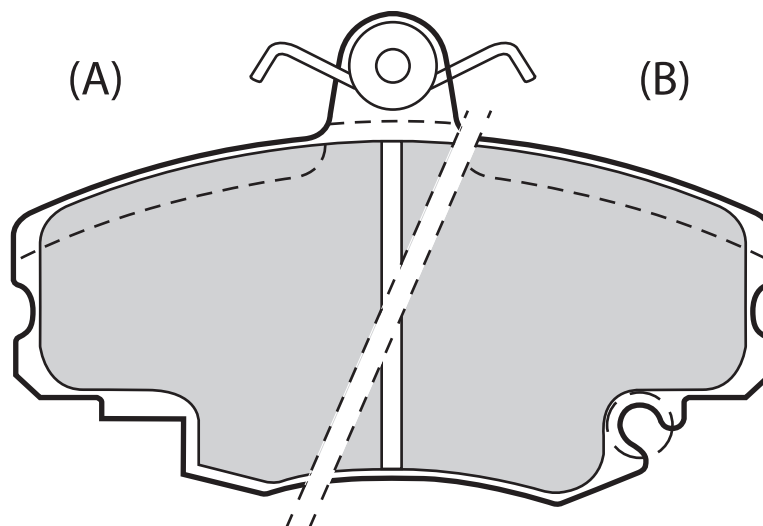

Valeo								
598002	2 (B)	218	100,2	64,9	18,2	LUCAS	DACIA, RENAULT	
598084	2 (A)	200	100	63,5	18,2	LUCAS	PEUGEOT, RENAULT	
598154	4 (A)	375	100	63,5	18,2	LUCAS	CITROËN	

20775 (WVA)

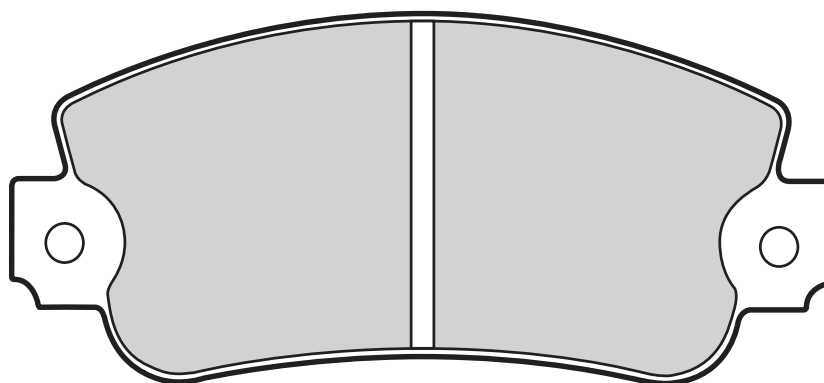

Valeo								
598091	2	Plugs	108,8	47,4	18	BENDIX	AUTOBIANCHI, FIAT, LANCIA, SEAT	
598126	2	750	108,8	47,4	15	BENDIX	ALFA ROMEO	
598141	0		109	46,8	12	BENDIX	FIAT, LANCIA	
598160	0	750	108,8	47,4	15	BENDIX	ALFA ROMEO	



20783 (WVA)

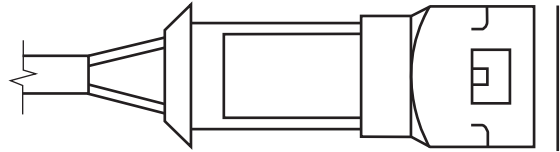
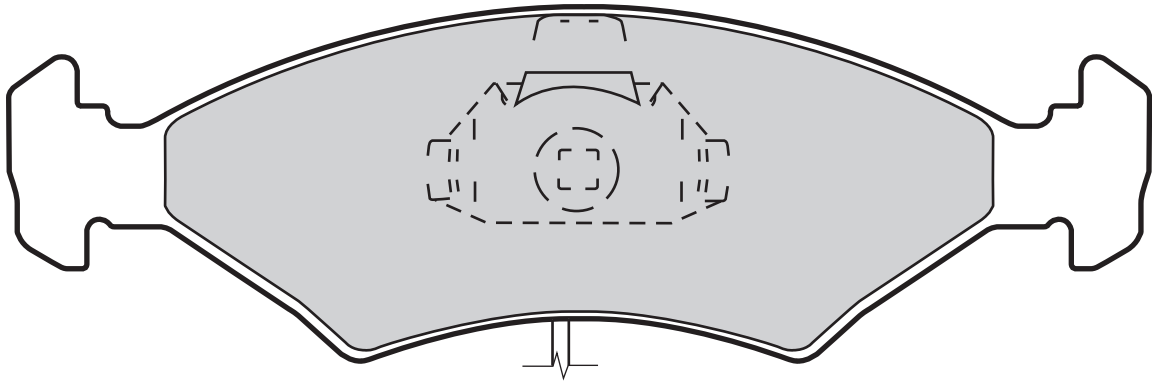

Valeo		Valeo						
598166	2	270	151,5	46,4	18	TEVES	FORD	
598212	0		151,3	46,4	18	TEVES	FORD, MAZDA	
598334	2	155	151,3	46,4	18	TEVES	FORD	

20784 (WVA)

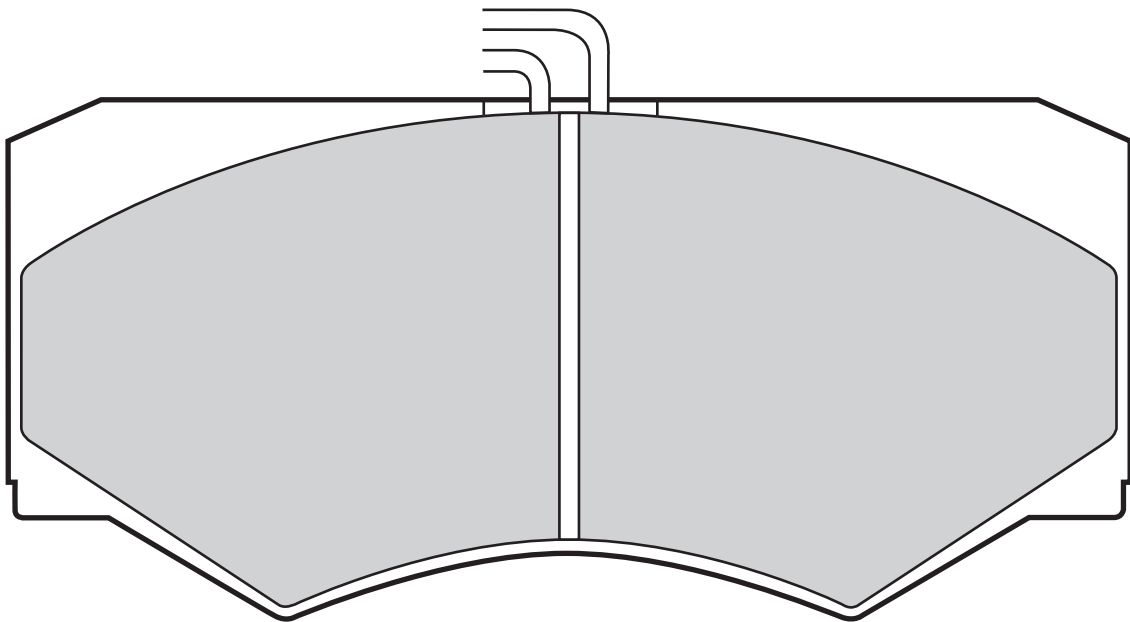

Valeo		Valeo						
598369	2	195/145	149	69	18	PERROT	IVECO	
598613	0		149	77	18	PERROT	MERCEDES, PEUGEOT, VOLKSWAGEN	



20788 (WVA)

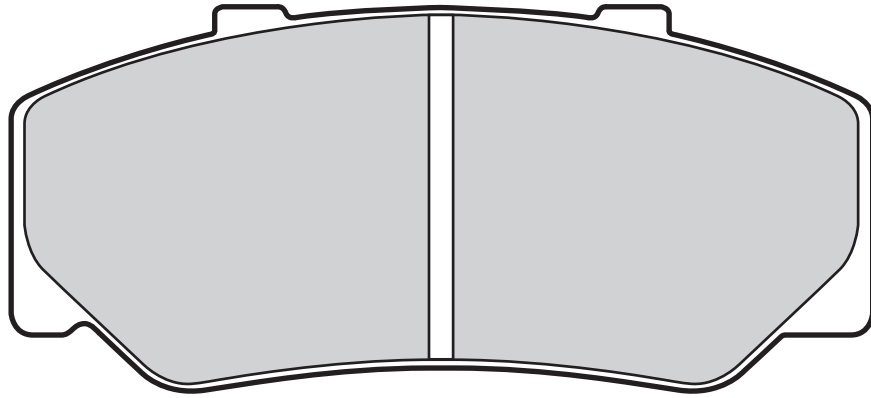

Valeo



Valeo



598222

0

113,9

51,5

17

BENDIX

U.M.M.

20789 (WVA)

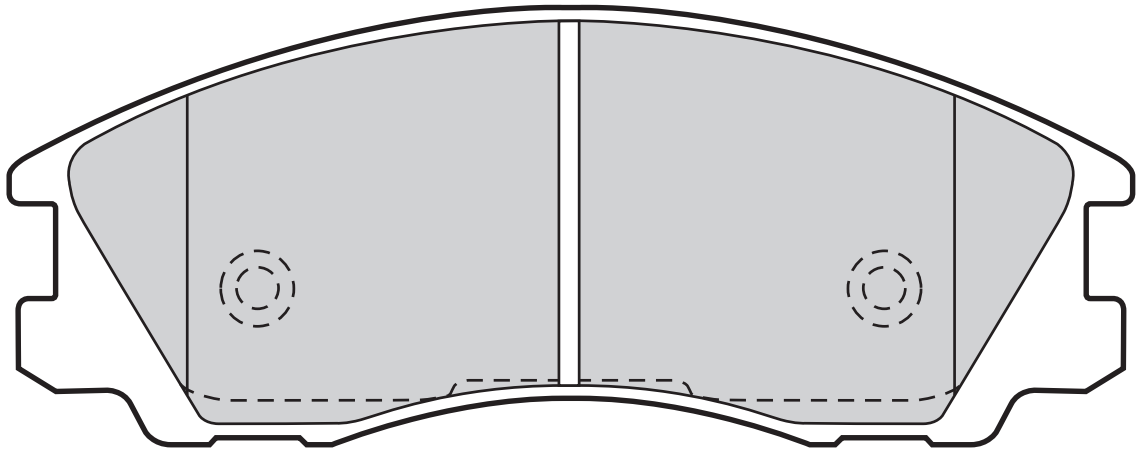

Valeo



Valeo



598506

0

149

58

16,6

LUCAS

HYUNDAI



20838 (WVA)

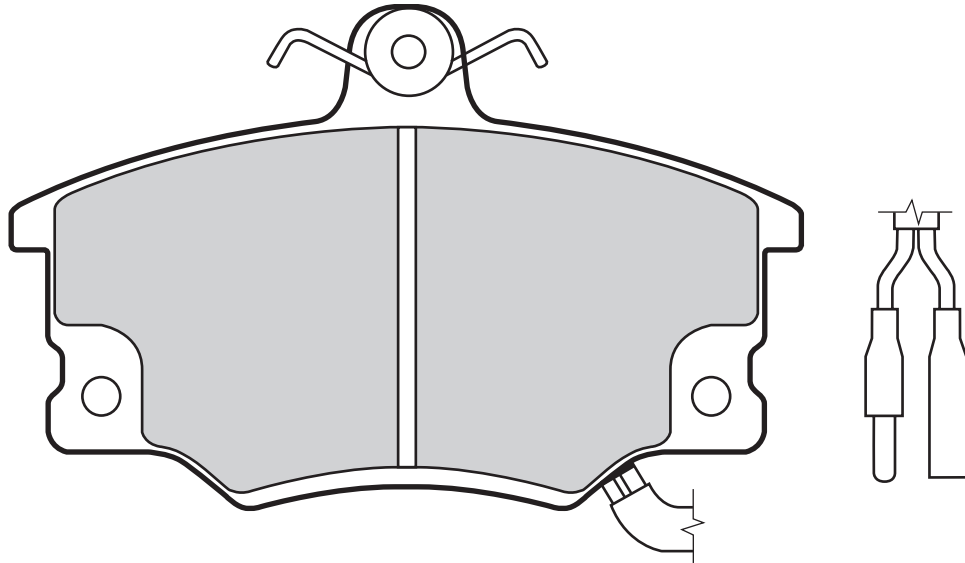

Valeo



Valeo



598133

2

711

104,2

66,3

17,2

LUCAS

LANCIA

598134

2

130

104,5

66,6

17,2

LUCAS

FIAT, LANCIA

598219

4

104,5

66,6

17,2

LUCAS

ALFA ROMEO, AUTOBIANCHI, FIAT, LANCIA

20845 (WVA)

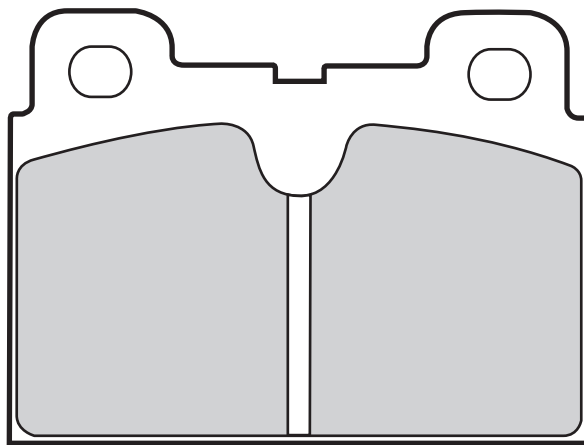

Valeo



Valeo



598163

2

76,8

56,9

16,5

TEVES

TALBOT

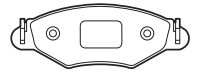

20857 (WVA)

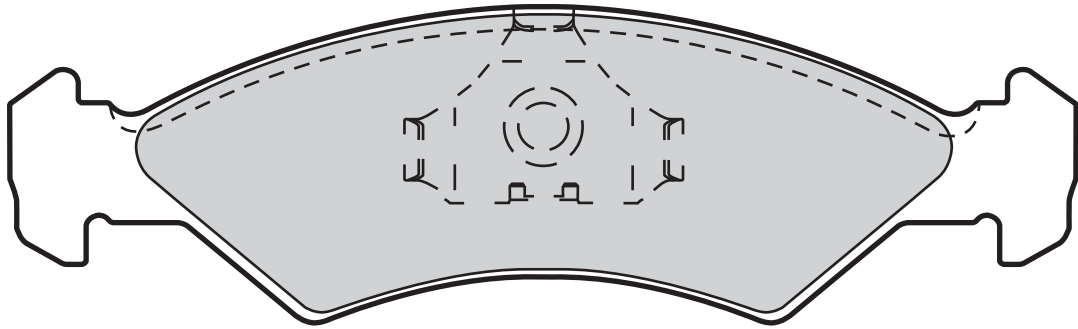

Valeo



0

Valeo



141,3



42



17,5



TEVES



FORD



598167

20862 (WVA)

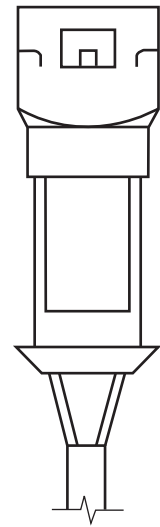
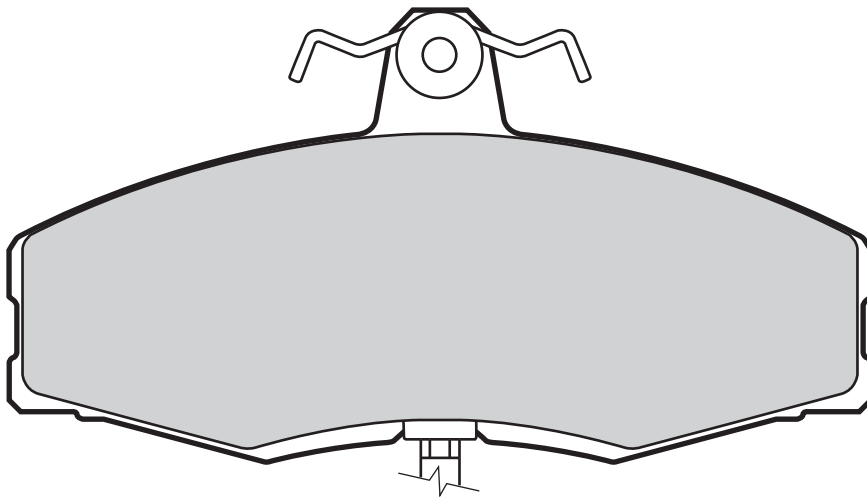

Valeo



2
0

Valeo



265



114,9



60,3



17,7



LUCAS



FORD

FORD, SKODA, VOLKSWAGEN

598169
598217



20863 (WVA)

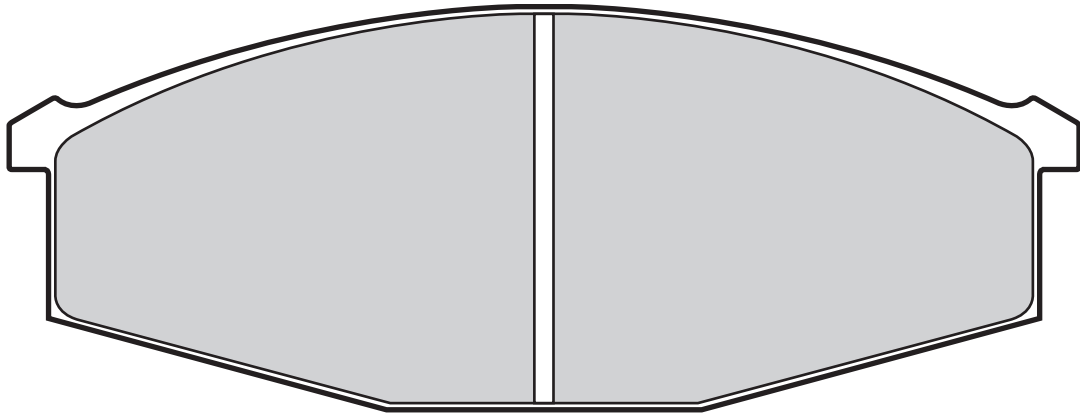

Valeo



0

Valeo



142

53,5



17,2



SUMITOMO



NISSAN

598122

20867 (WVA)

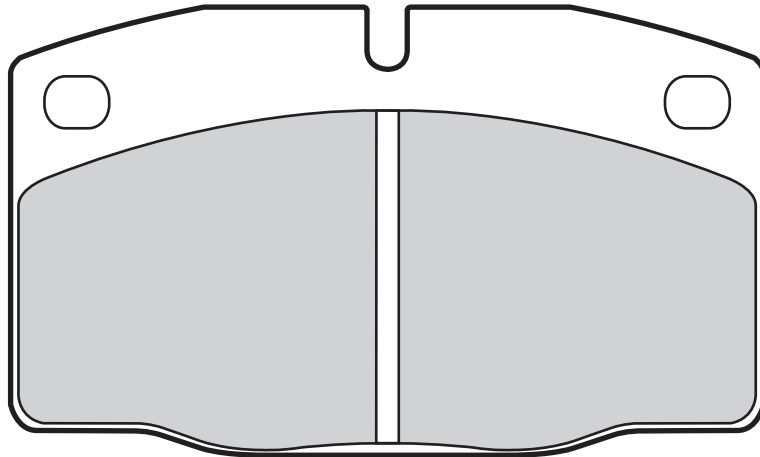

Valeo



0

Valeo



100

59



15,4



G.M.E



BEDFORD, OPEL, VAUXHALL

598182

20870 (WVA)

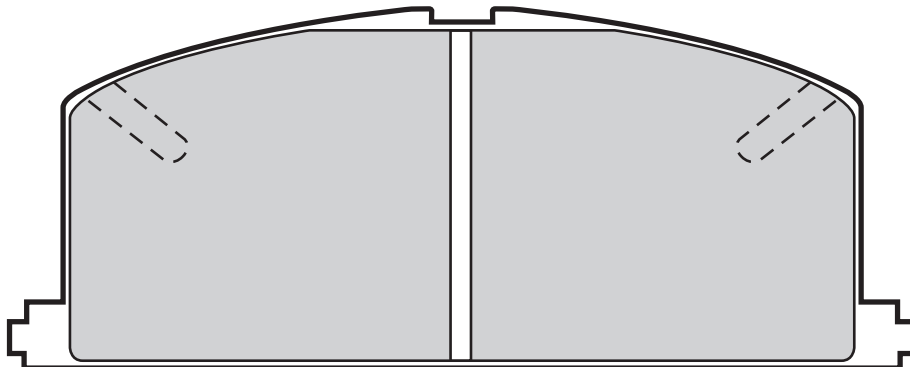

Valeo



4

Valeo



119,7

47,5



15



AKEBONO



TOYOTA

598266

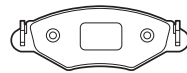

20880 (WVA)

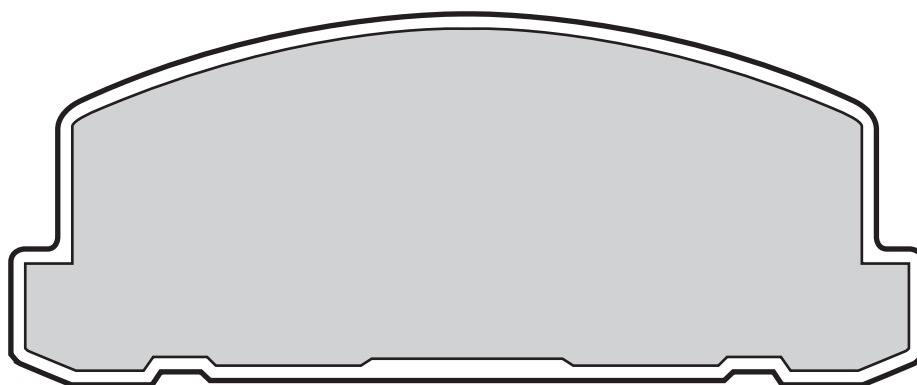
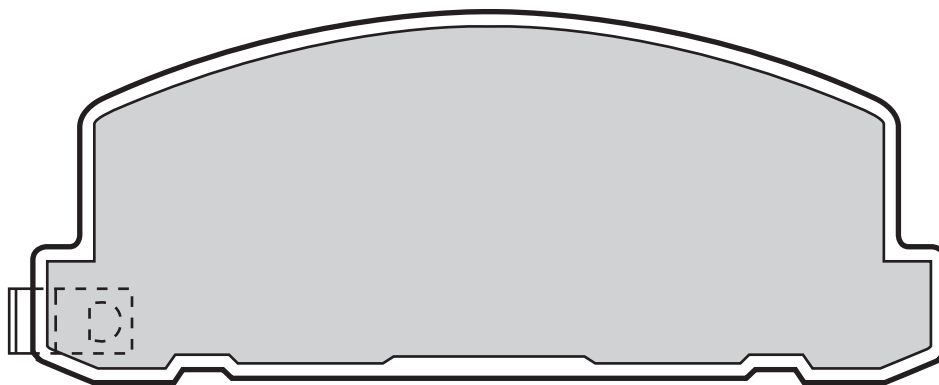

Valeo



Valeo



598615

0

121

48,5

15,5

AKEBONO

ISUZU

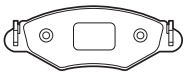

20887 (WVA)

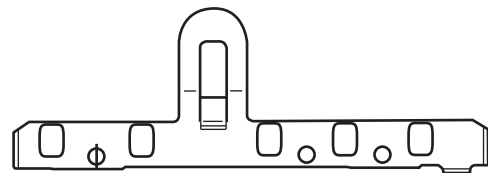
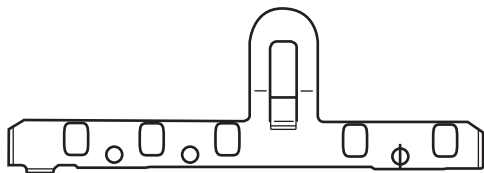
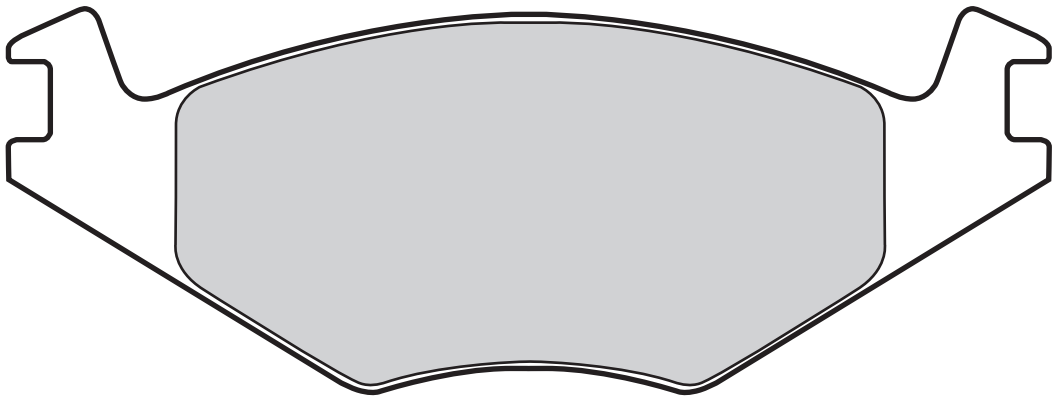
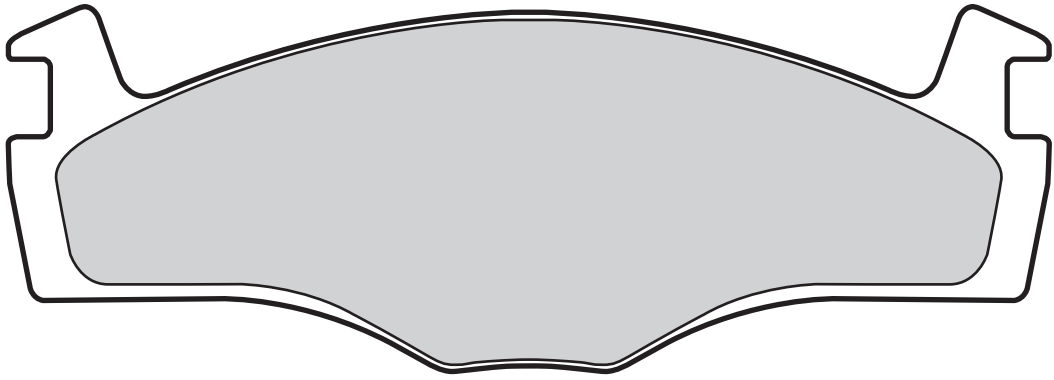

Valeo



Valeo



598124
598128
598258

0
0
0

137,8
137,8
137,8

51,1
51,1
51,1

15,3
19,7
17,2

VW
VW
VW

SEAT, VOLKSWAGEN
SEAT, VOLKSWAGEN
SEAT, VOLKSWAGEN



20889 (WVA)

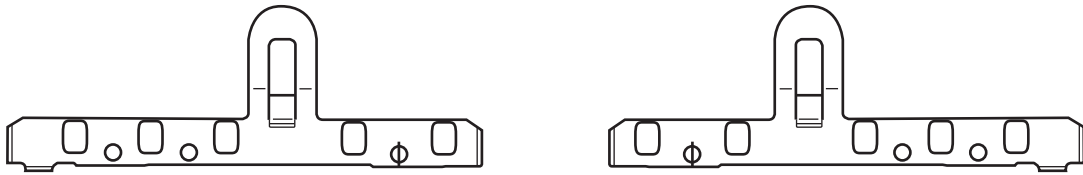
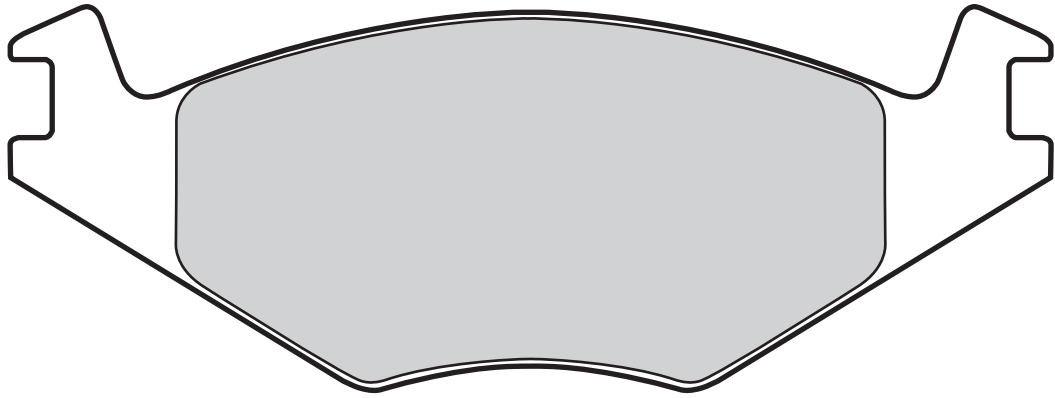

Valeo



Valeo



598127

0

137,8

51,3

17,3

VW

SEAT, VOLKSWAGEN

20894 (WVA)

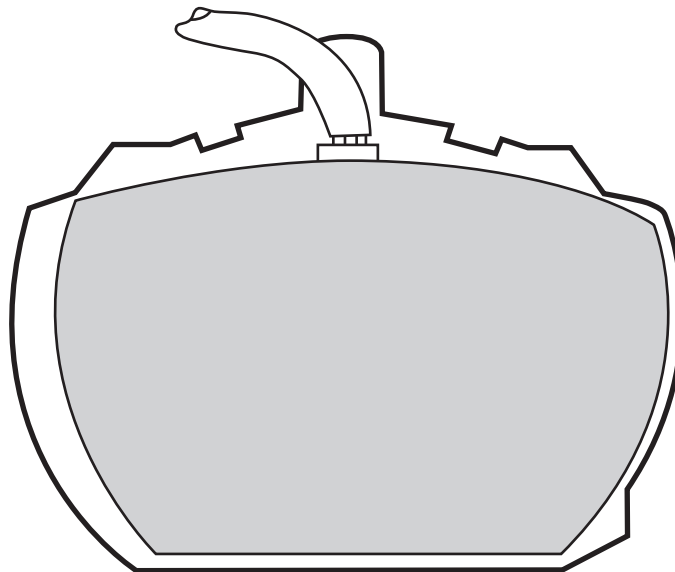

Valeo



Valeo



598391

2

88,5

70,8

15

AP

FORD, RELIANT, ROVER



20895 (WVA)

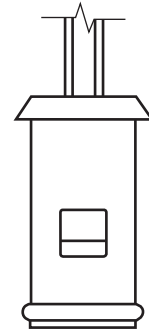
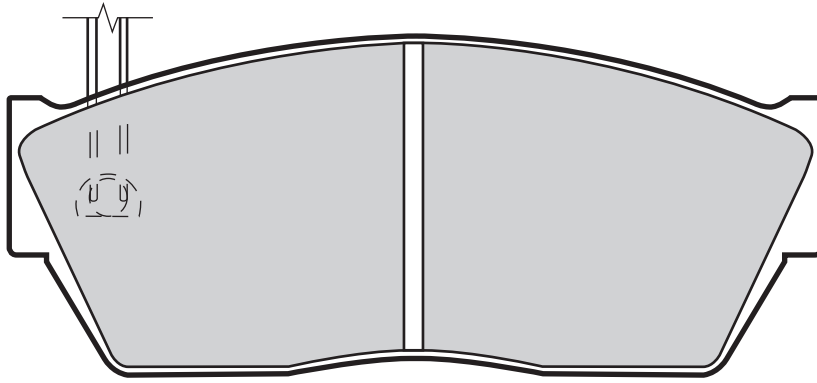

Valeo										
598131	2	210	107,2	44,9	14,5	SUMITOMO		HONDA, ROVER		

20901 (WVA)

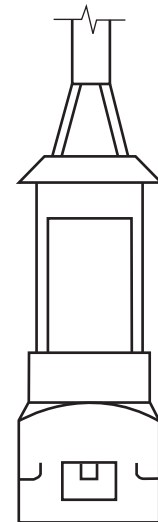
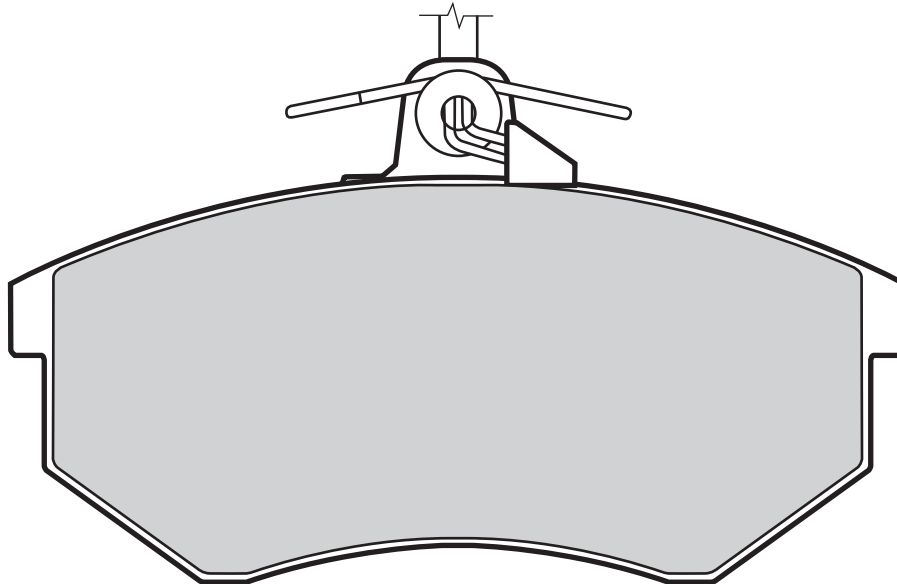

Valeo										
598004	0		119	69,5	15,7	LUCAS		AUDI		
598016	2	225	119	69,5	15,7	LUCAS		AUDI, SEAT, VOLKSWAGEN		
598017	2	225	119	69,5	19,1	LUCAS		AUDI, VOLKSWAGEN		
598252	0		119	69,5	19,6	LUCAS		SEAT, VOLKSWAGEN		



20905 (WVA)

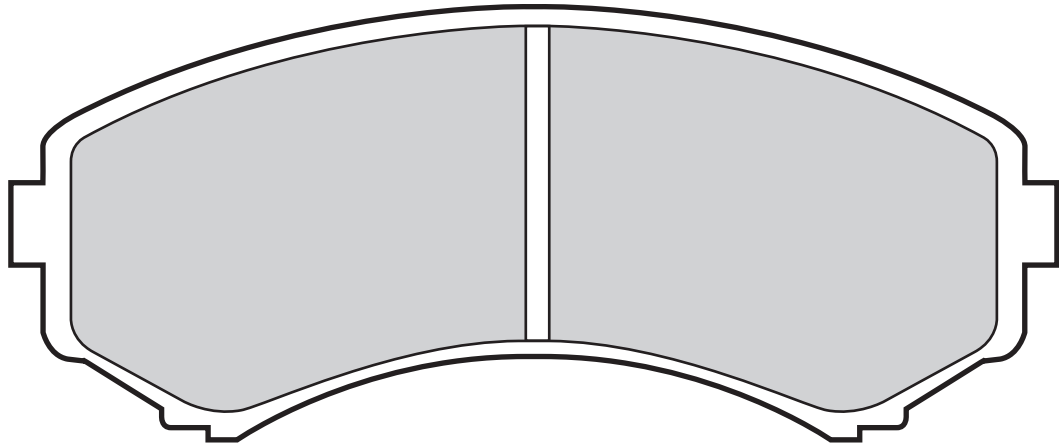

598515

2

139

58,5

16

SUMITOMO

MAZDA

20907 (WVA)

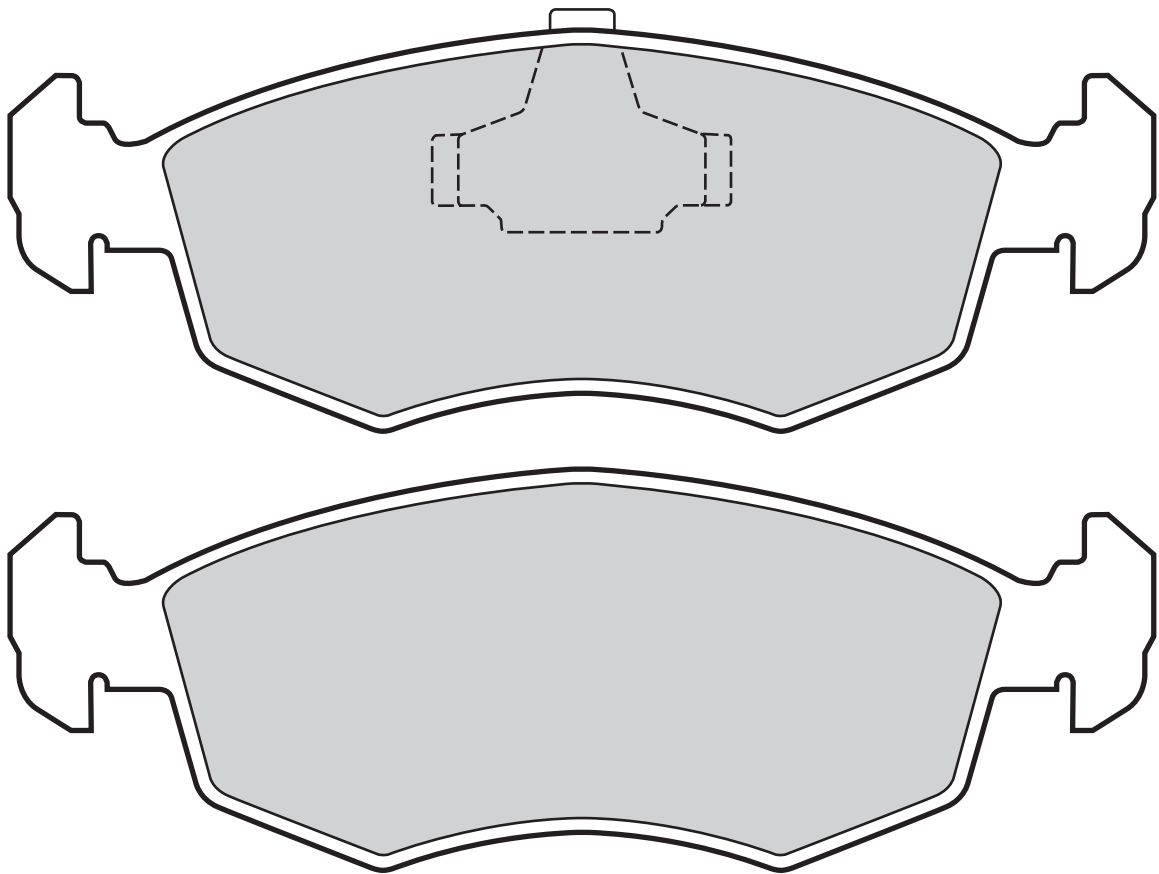

598120

2

260

151,3

52,6

18

TEVES

FORD

598422

0

151,4

52,5

17,8

TEVES

FIAT

598424

2

180

151,4

52,5

17,8

TEVES

FIAT



20908 (WVA)

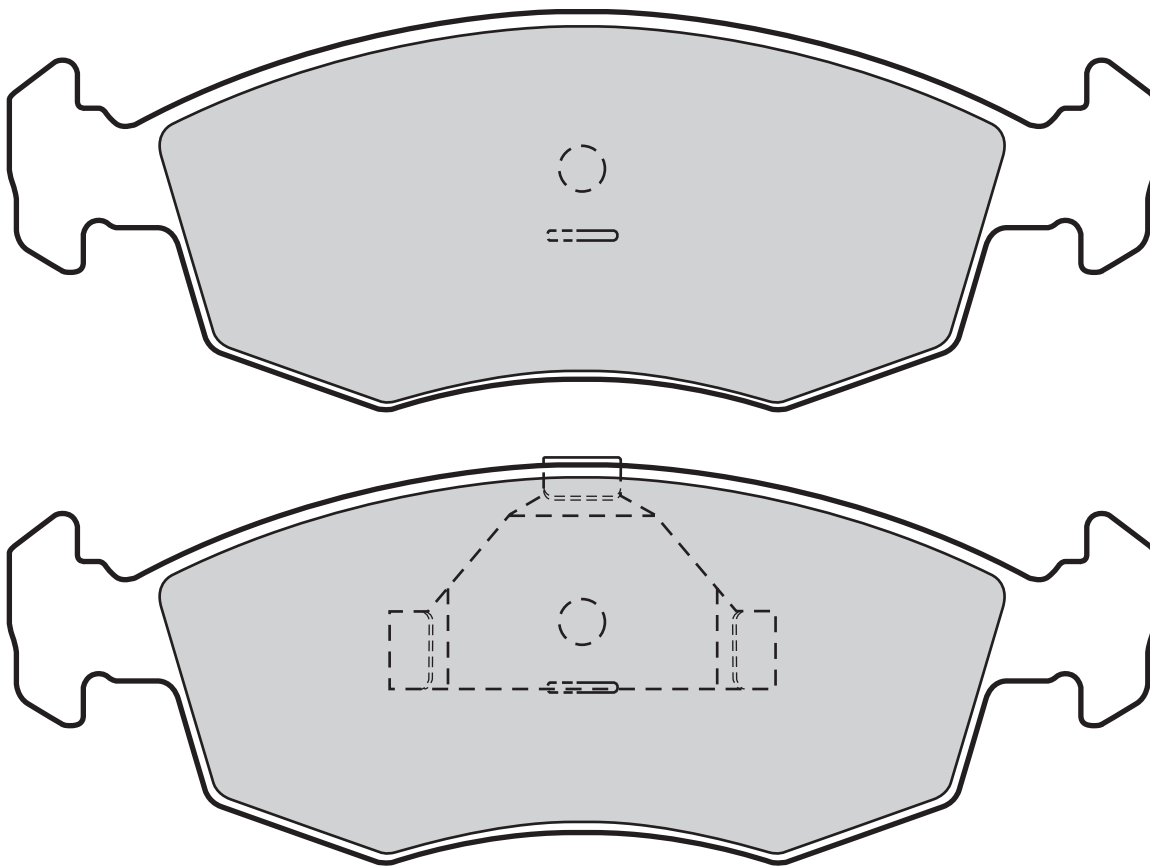

Valeo



Valeo



598335

0

151,3

52,5

18

TEVES

FORD

20911 (WVA)

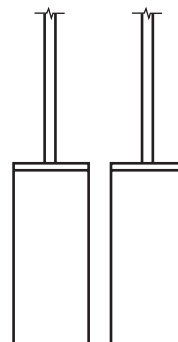
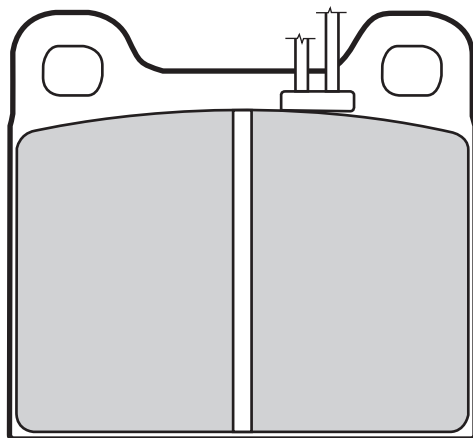

Valeo



Valeo



598113

1

700

61,8

56,5

15

TEVES

ALFA ROMEO, TALBOT

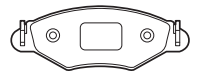

20913 (WVA)

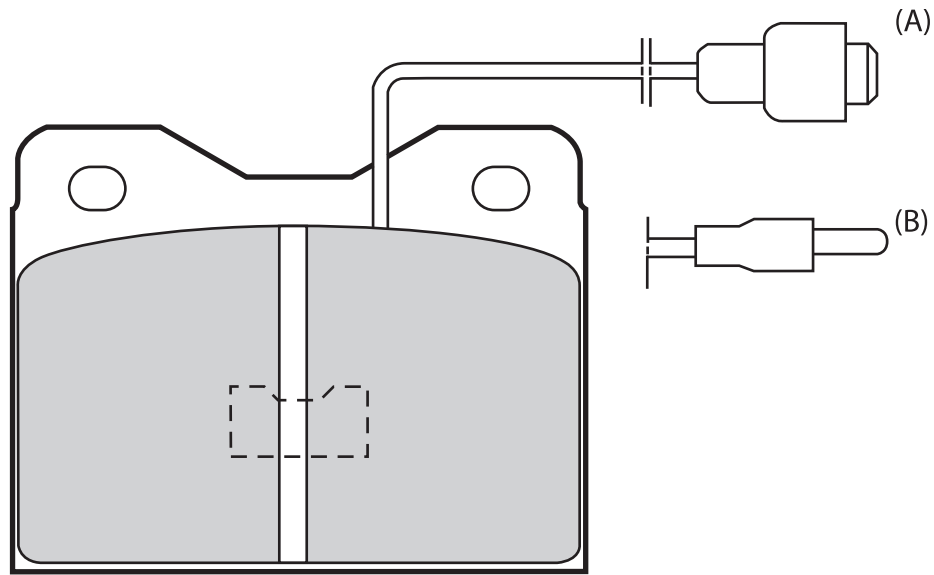

598375

2 (A)

195

76,8

58,8

15,2

TEVES

AUDI, BMW, CITROËN, PEUGEOT, RENAULT, TALBOT

20916 (WVA)

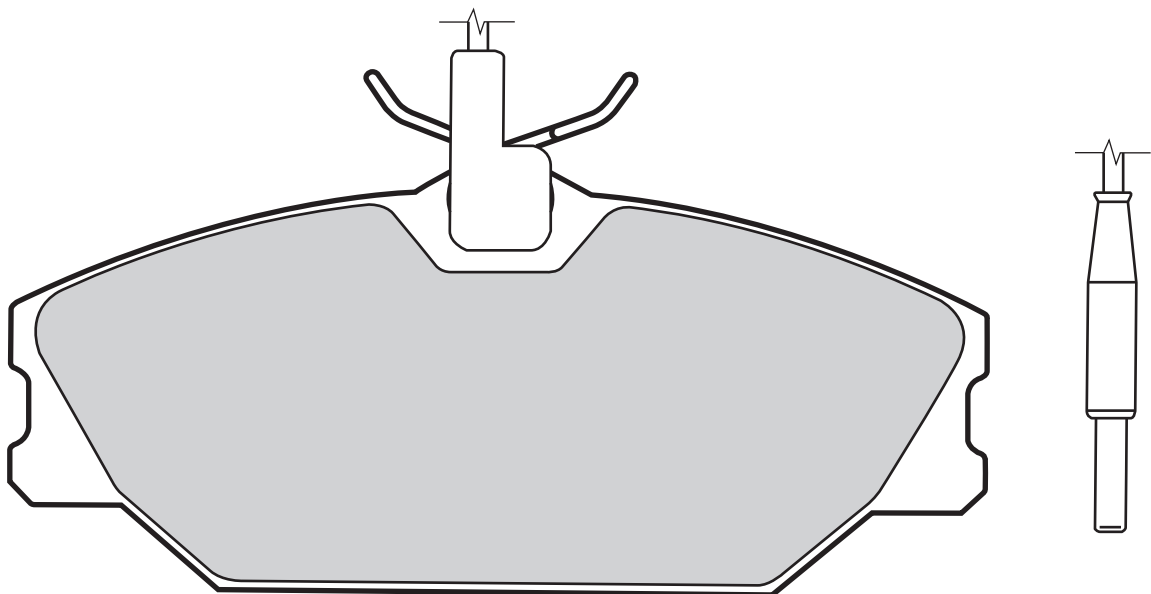

598061

2

260

130

55

18

LUCAS

DAEWOO, RENAULT

598473

0

129

55,6

18

LUCAS

RENAULT

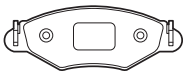

20920 (WVA)

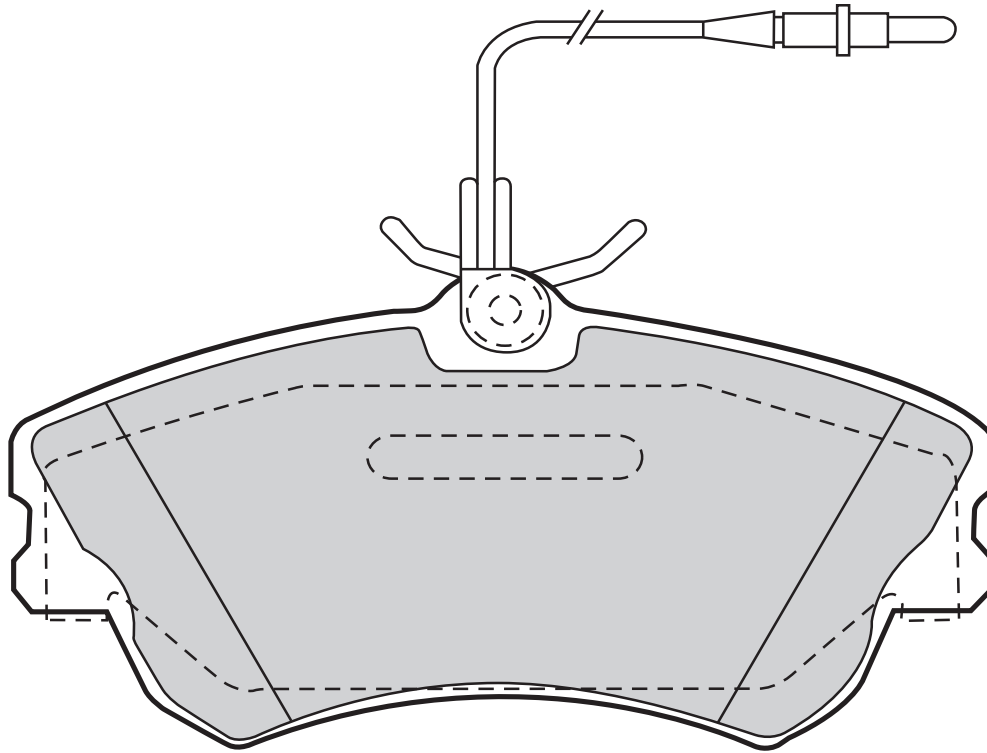

Valeo



Valeo



598470

2

280

129,9

63

18

LUCAS

RENAULT

20928 (WVA)

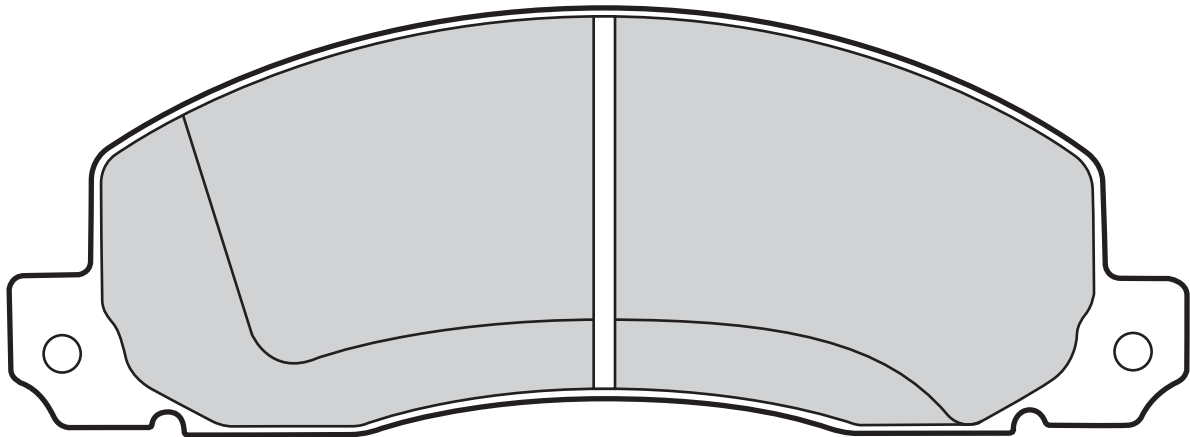

Valeo



Valeo



598086

0

156

56,5

18,5

BENDIX

OPEL, RENAULT, VAUXHALL



20944 (WVA)

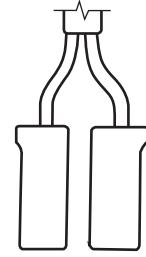
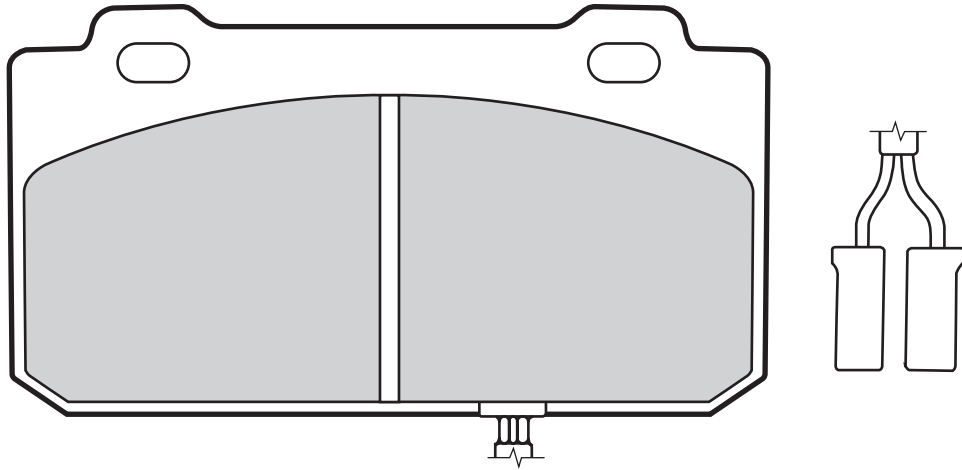

598130

2

100

54

15

TEVES

ALFA ROMEO

20955 (WVA)

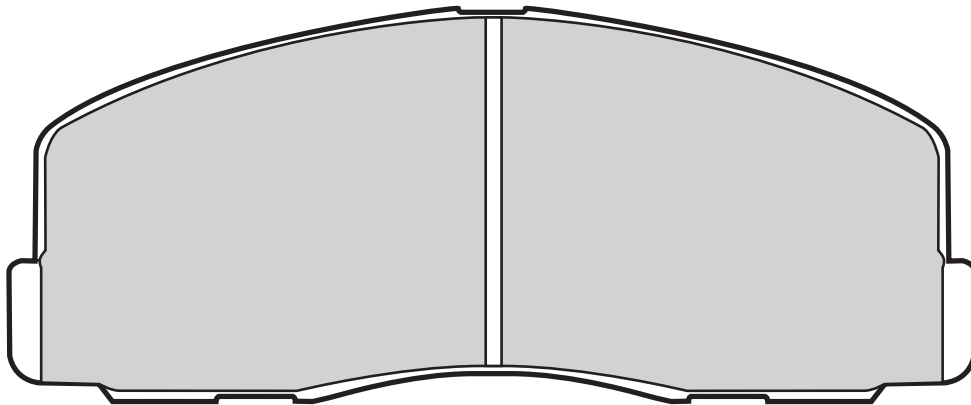

598220

0

127,8

52,5

15

AKEBONO

mitsubishi

20957 (WVA)

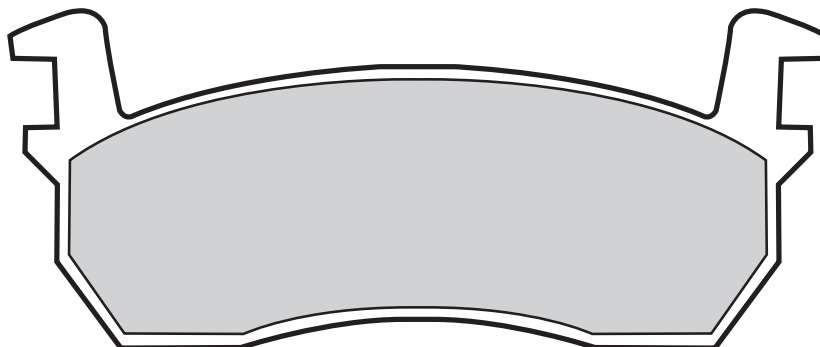

598384

0

108

45

16

SUMITOMO

NISSAN



20958 (WVA)

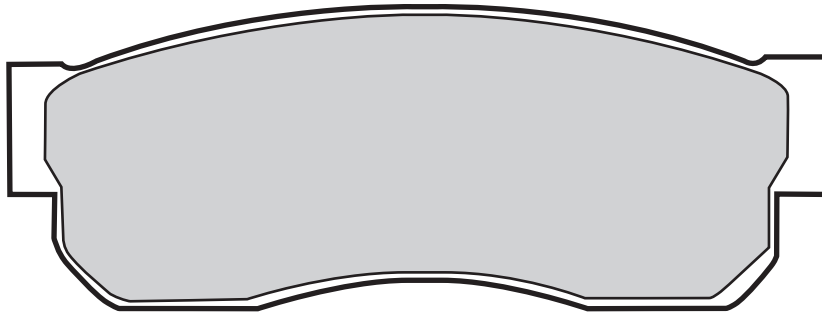

598278	0	108,5	40,3	14,7	SUMITOMO	NISSAN, SUBARU	

20959 (WVA)

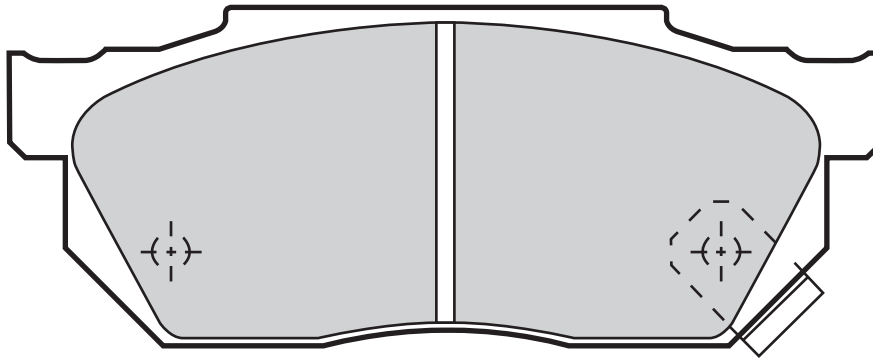

598047	2	116	45	15	AKEBONO	HONDA



20960 (WVA)

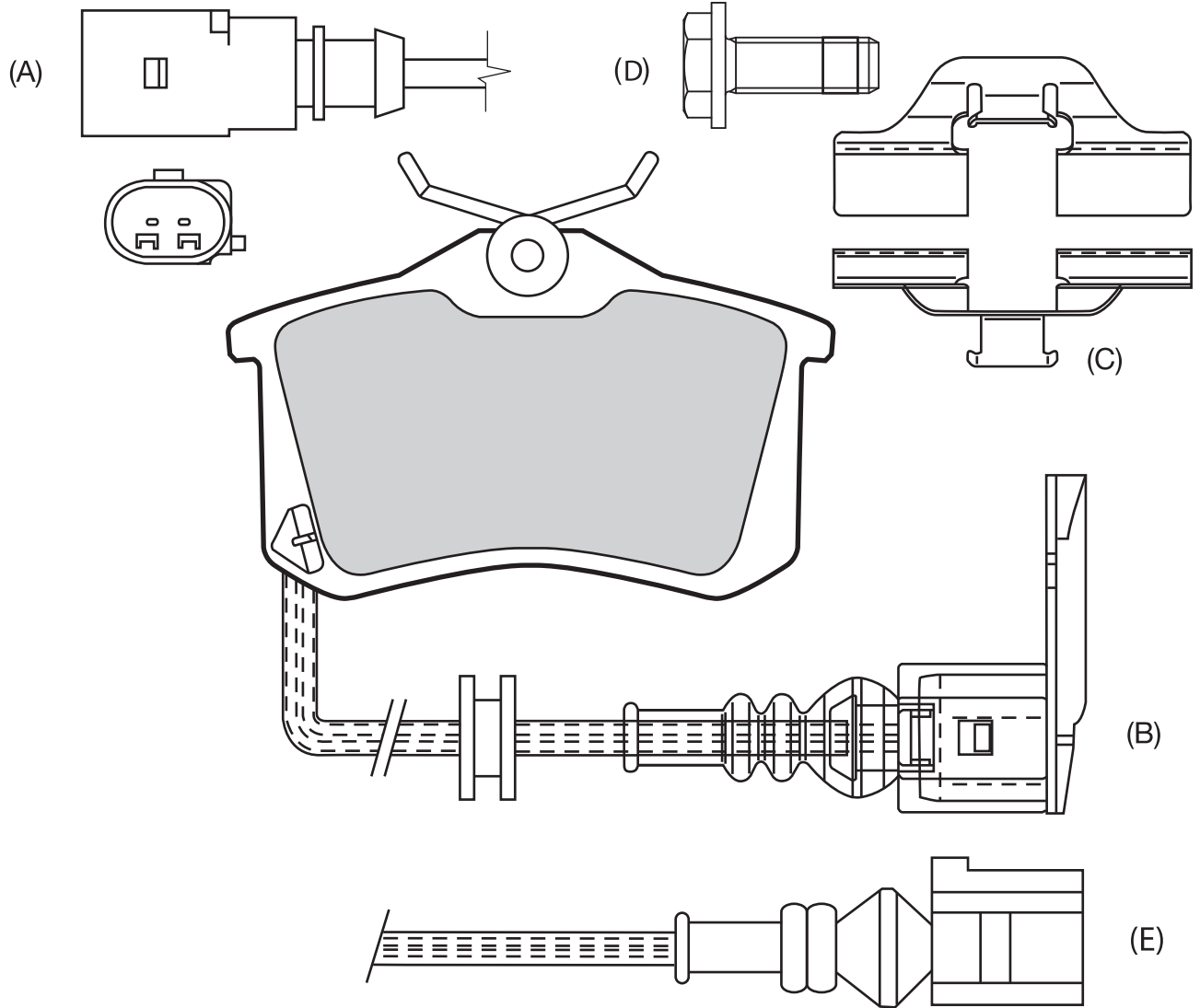

Valeo



Valeo



598180	0 (D)		87	53	15,2	LUCAS	AUDI, LANCIA, PEUGEOT, RENAULT, SEAT, SKODA, VOLKSWAGEN
598463	0 (D)		87	53	17	LUCAS	AUDI, CITROËN, FIAT, FORD, LANCIA, PEUGEOT, SEAT, SKODA, VOLKSWAGEN
598474	0 (D+C)		87	53	16	LUCAS	AUDI, CITROËN, PEUGEOT, RENAULT, SEAT
598674	1 (E)	260	87	53	17	LUCAS	SEAT, SKODA, VOLKSWAGEN
598681	1 (A+D)	205	87	53	17,2	LUCAS	FORD, SEAT, VOLKSWAGEN



20979 (WVA)

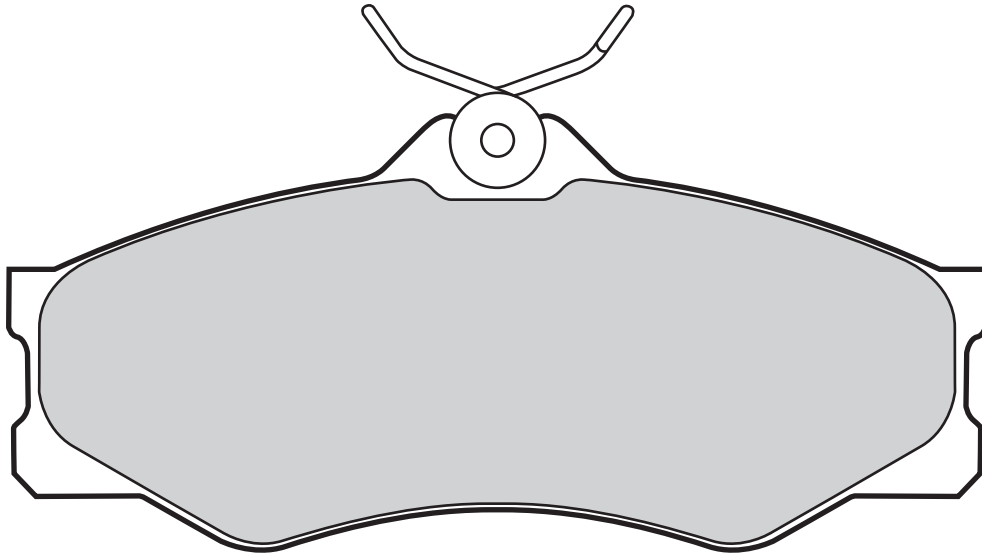

598027	0	130	58	19,2	LUCAS	VOLKSWAGEN		

20981 (WVA)

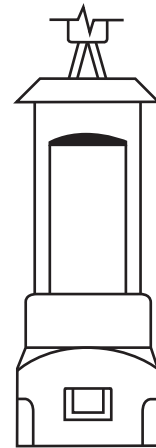
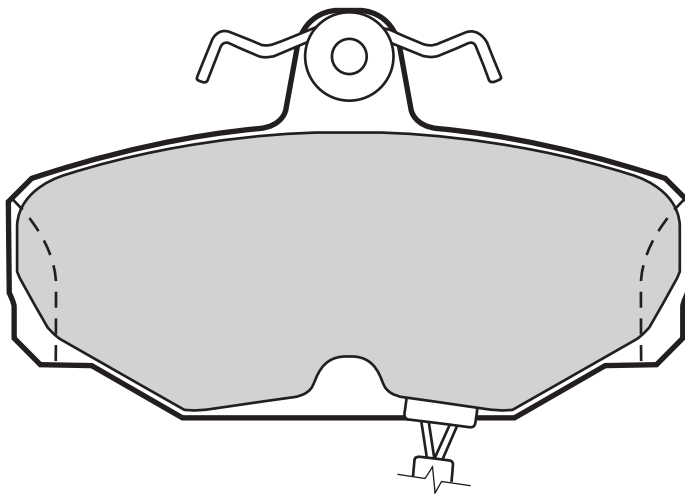

598121	2	265	90	54	13,7	LUCAS	FORD	
598240	0		90	54	13,7	LUCAS	FORD	

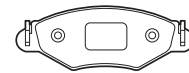

20989 (WVA)

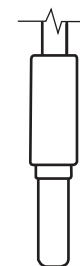
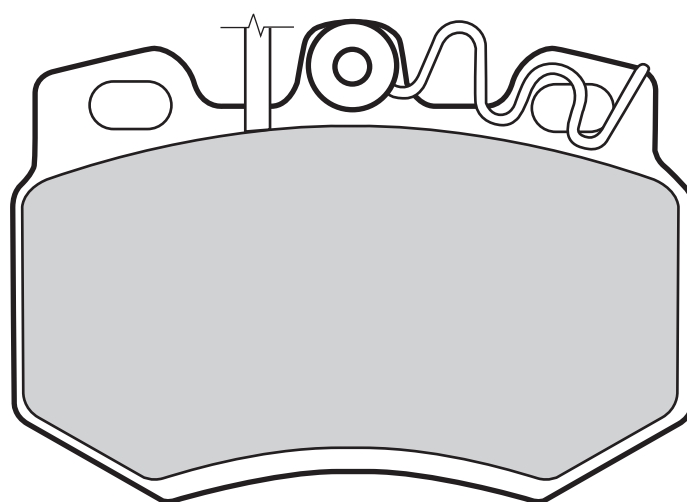
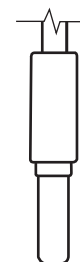
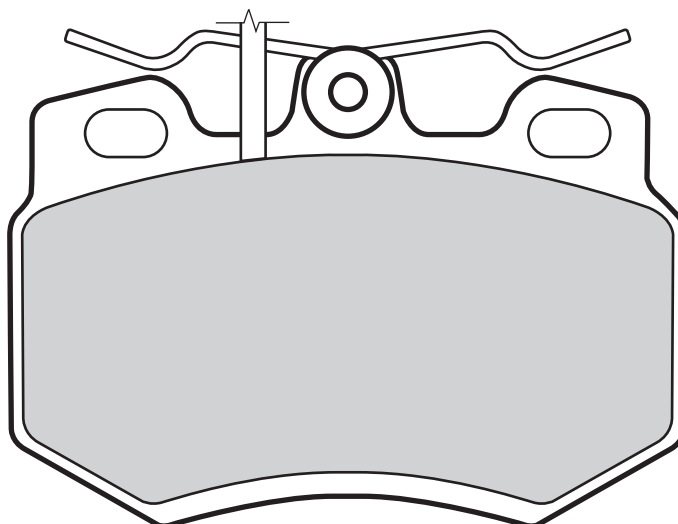

Valeo								
598119	4	225	90	62,9	17,5	LUCAS	CITROËN	
598176	2	200	90	63	17,5	LUCAS	PEUGEOT	
598714	4	350/350	90	63	17,7	LUCAS	CITROËN	

20996 (WVA)

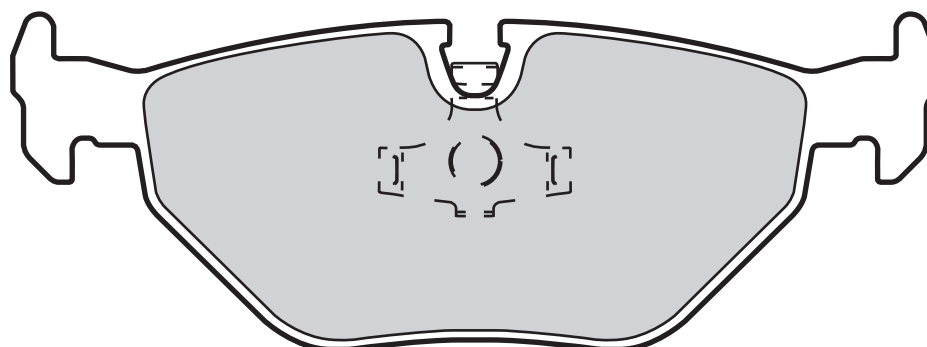

Valeo								
598259	0	123	45	17,3	TEVES	BMW		



20998 (WVA)

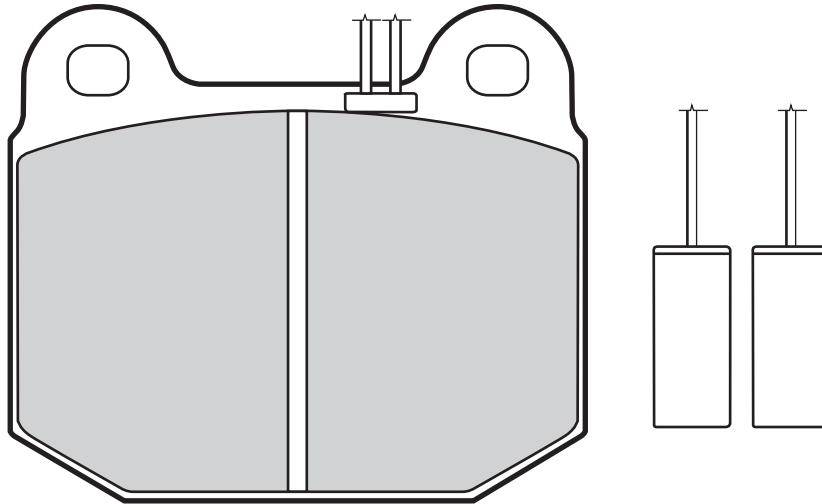

598115

1

700

76,6

65,5

16,5

TEVES

ALFA ROMEO

21010 (WVA)

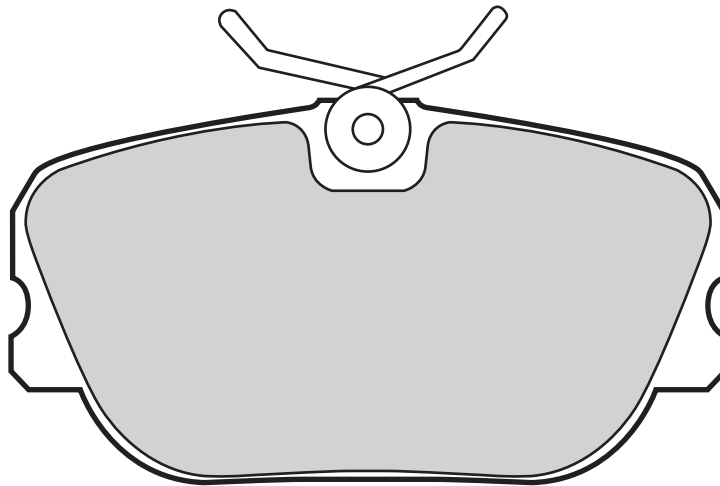

598102

0

95

53

16

LUCAS

VOLVO

598237

0

94,8

53

17,7

LUCAS

SAAB

598241

0

95

52,7

17,9

LUCAS

MERCEDES

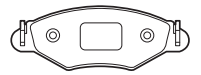

21012 (WVA)

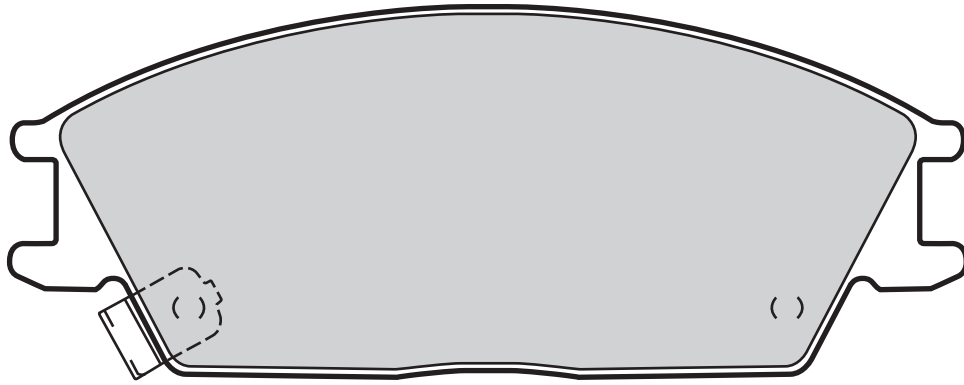

Valeo



2

Valeo



14,8



AKEBONO



HONDA, HYUNDAI

598052

127,4

49

21016 (WVA)

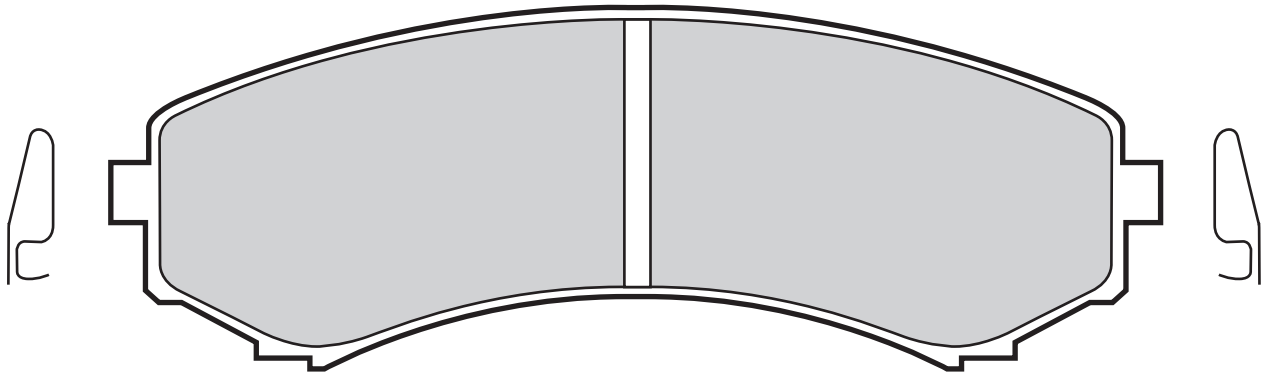

Valeo



2

Valeo



16



SUMITOMO



139

58,5

MITSUBISHI

598518

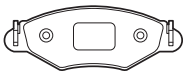

Valeo

21028 (WVA)

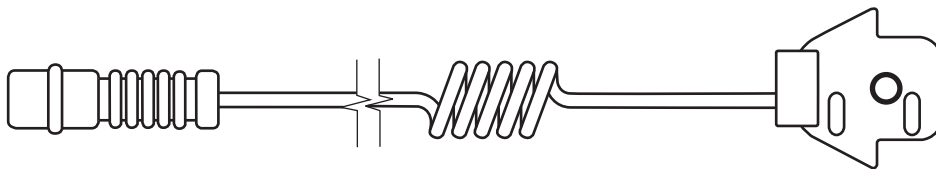
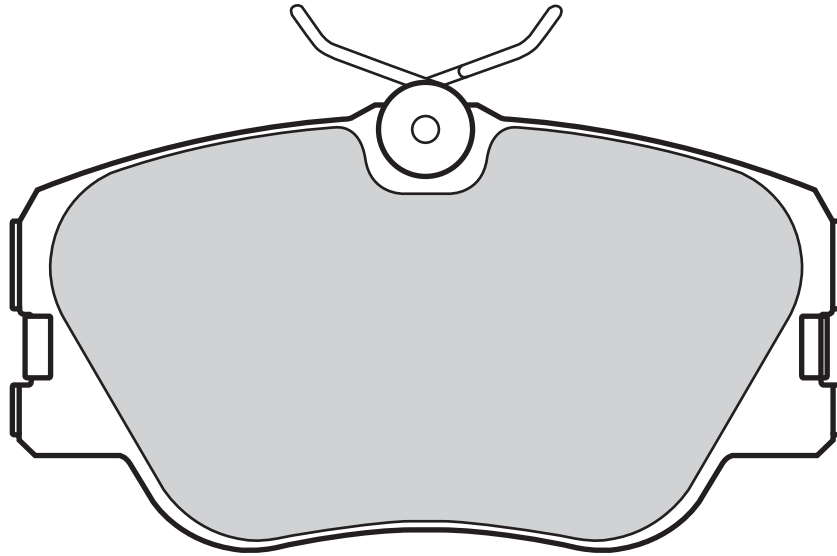

Valeo



0

Valeo



110



59,7



18,8



LUCAS



MERCEDES

598315

21041 (WVA)

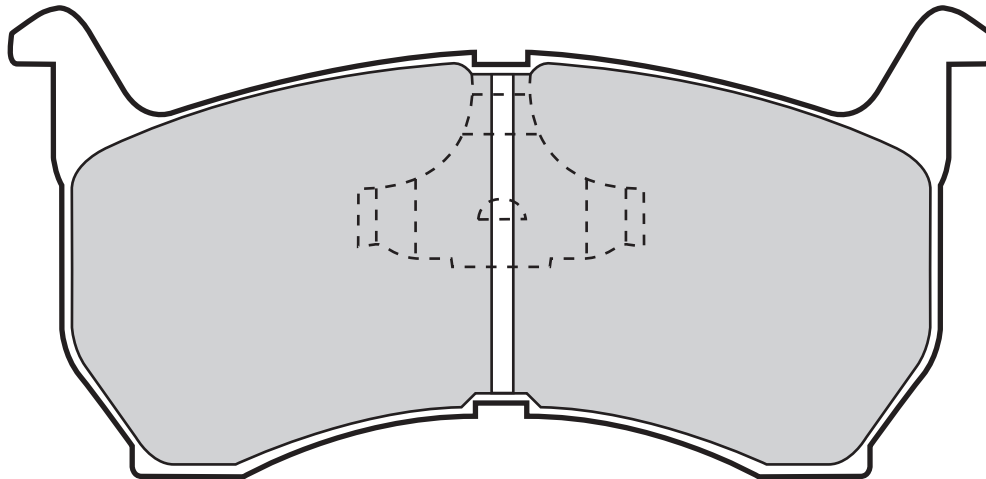

Valeo



0

Valeo



130



61,1



15



AKEBONO



MAZDA

598239



21049 (WVA)

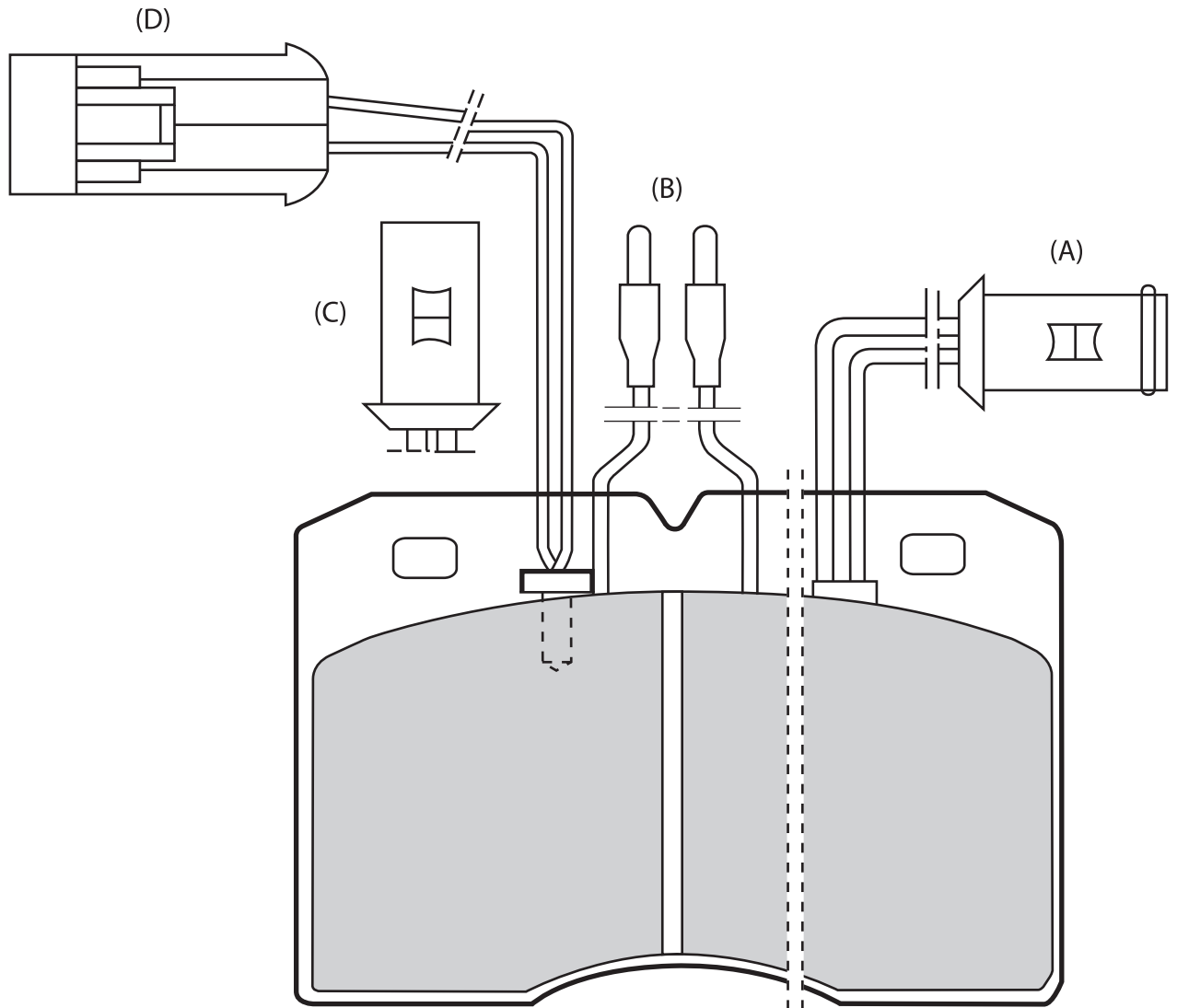

Valeo



Valeo



598007	4 (B)	135/180	109,5	73	18	BREMBO	ALFA ROMEO, IVECO
598139	2 (C)	150	109,5	73	18	BREMBO	IVECO
598585	2 (D)	170	109,7	73	18,3	BREMBO	IVECO
598596	2 (A)	170	109,7	73	18,3	BREMBO	IVECO



21051 (WVA)

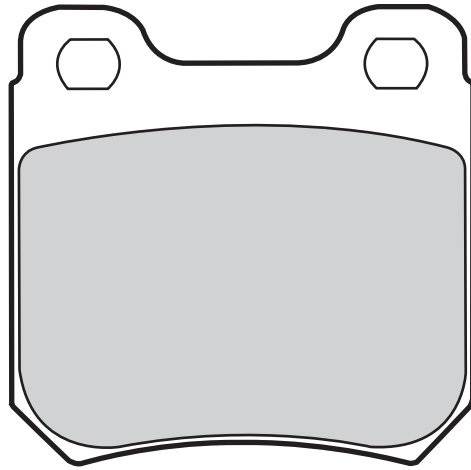

Valeo		Valeo								
598183	0		61,7	61,2	15,7	TEVES		OPEL, SAAB, VAUXHALL		
598243	0		61,7	61,2	15,3	TEVES		OPEL, VAUXHALL		

21061 (WVA)

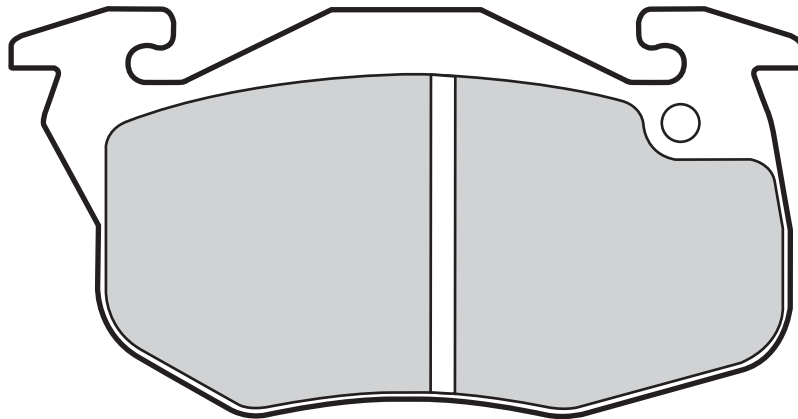

Valeo		Valeo								
598075	0		105	51,9	18	BENDIX		CITROËN, PEUGEOT		
598081	2	205	105	51,9	18	BENDIX		PEUGEOT, RENAULT, TALBOT		
598155	4	365/280	105	51,9	18	BENDIX		CITROËN		
598181	4	180/305	105	51,9	18	BENDIX		PEUGEOT		



21064 (WVA)

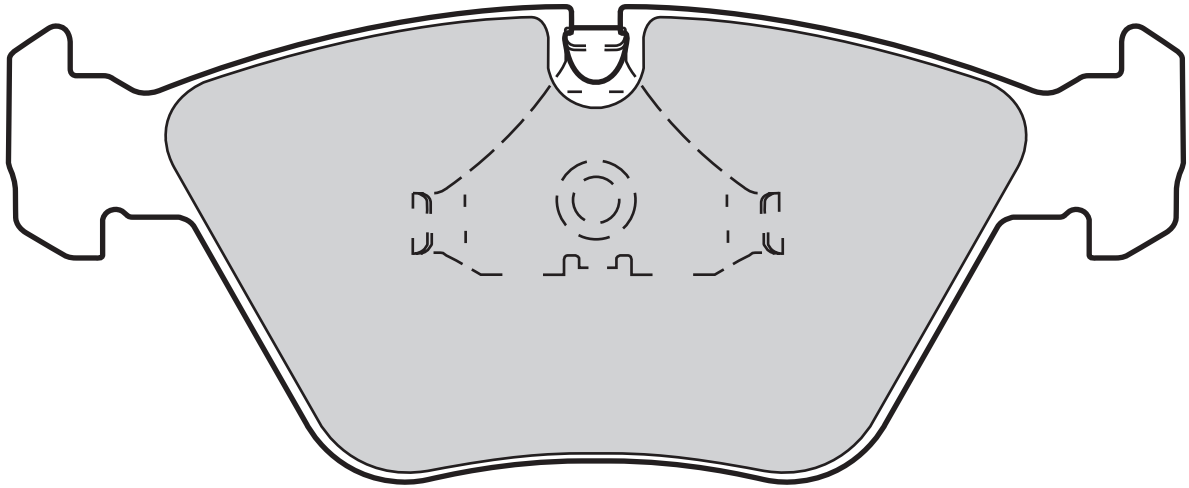

Valeo



Valeo

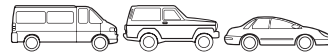

598231
598409
598440

0
0
0

156,3
155,4
156,4

64
63,6
63,6

20
20
17,5

TEVES
TEVES
TEVES

BMW
BMW
JAGUAR

21084 (WVA)

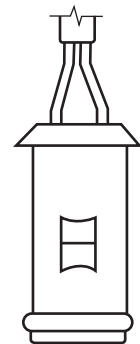
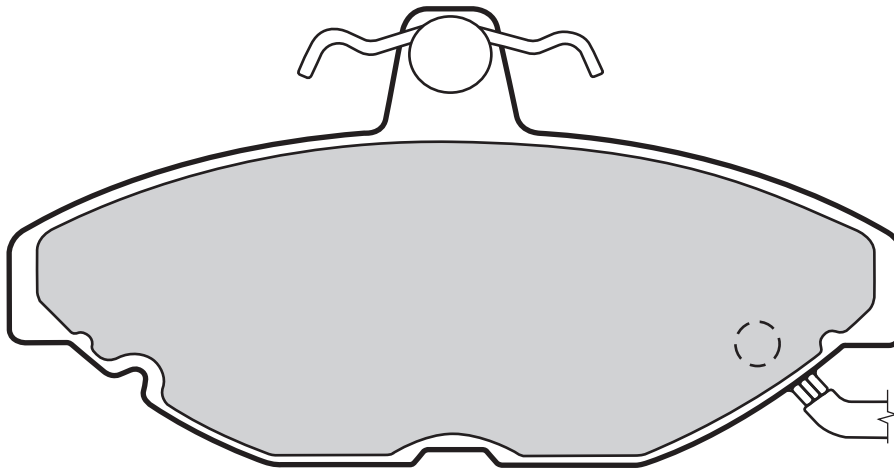

Valeo



Valeo



598118

2

118

61

17,3

LUCAS

RELIANT, ROVER



Valeo

21087 (WVA)

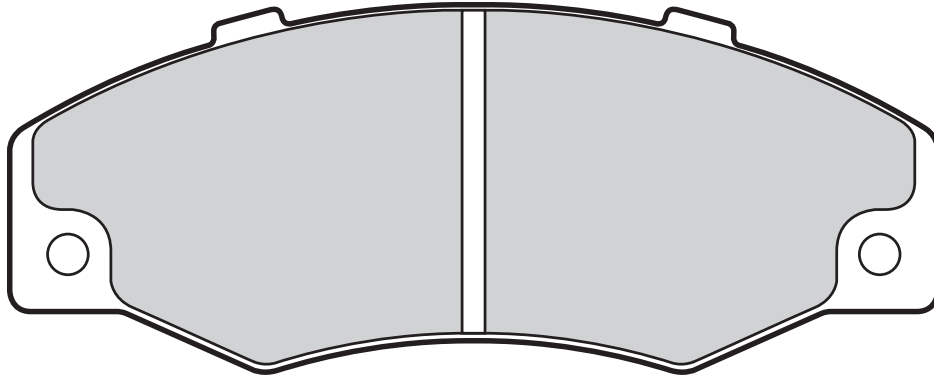

Valeo



2

Valeo



163



122,9



48,6



17



BENDIX



RENAULT

598082

21099 (WVA)

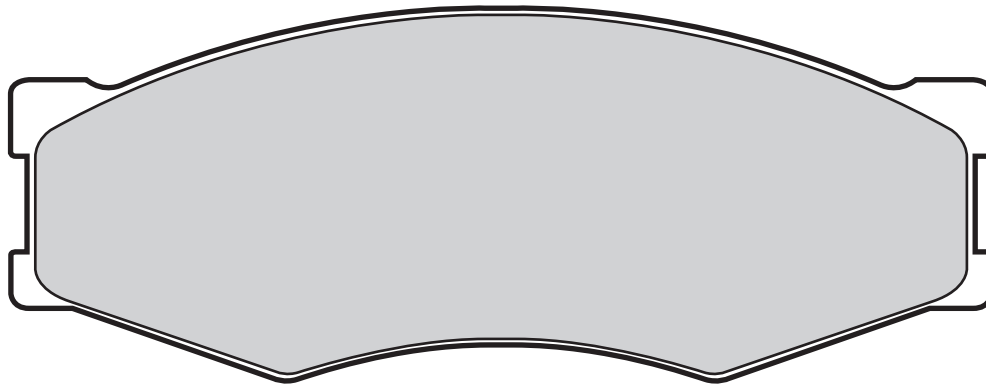

Valeo



2

Valeo



Leaf



130



49



16,4



AKEBONO



NISSAN

598123



21103 (WVA)

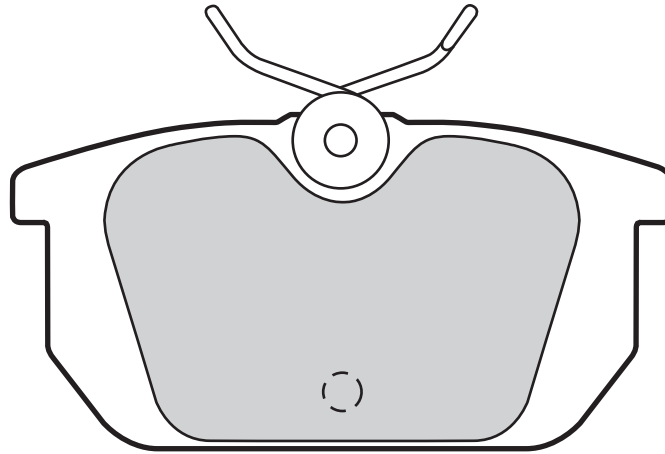

598142

0

87,3

44,4

14,4

LUCAS

ALFA ROMEO, FIAT, LANCIA

21105 (WVA)

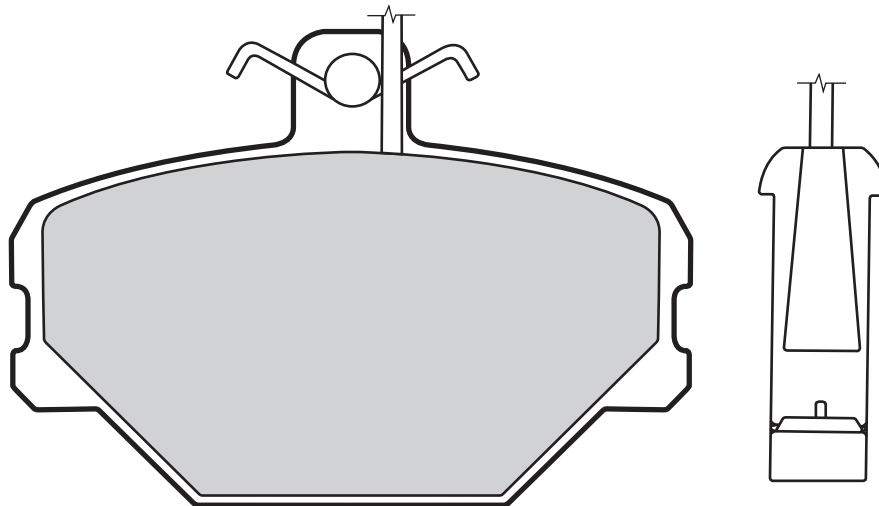

598095

1

255

90

63

17

LUCAS

FIAT, FSO POLSKI, LANCIA

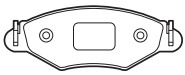

21125 (WVA)

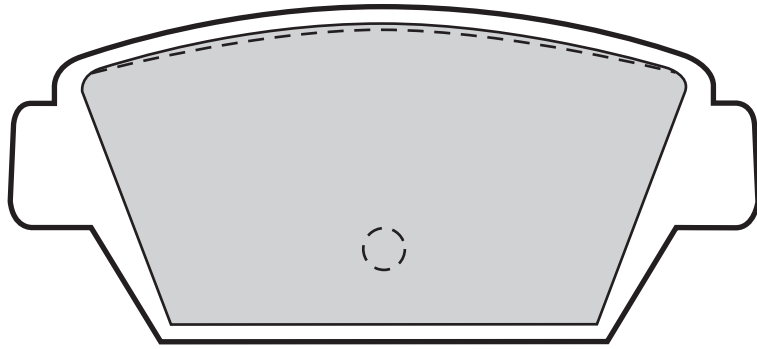

598964	0	97,9	44,5	14,5	AKEBONO	MITSUBISHI				

21126 (WVA)

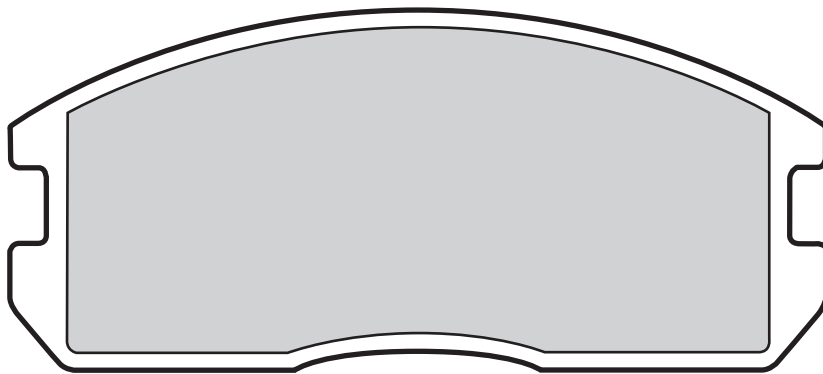

598224	0	108	47,9	15	SUMITOMO	MITSUBISHI				

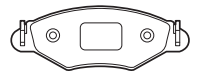

21138 (WVA)

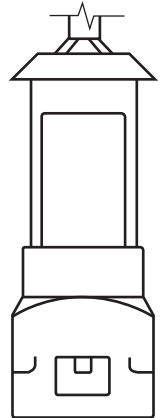
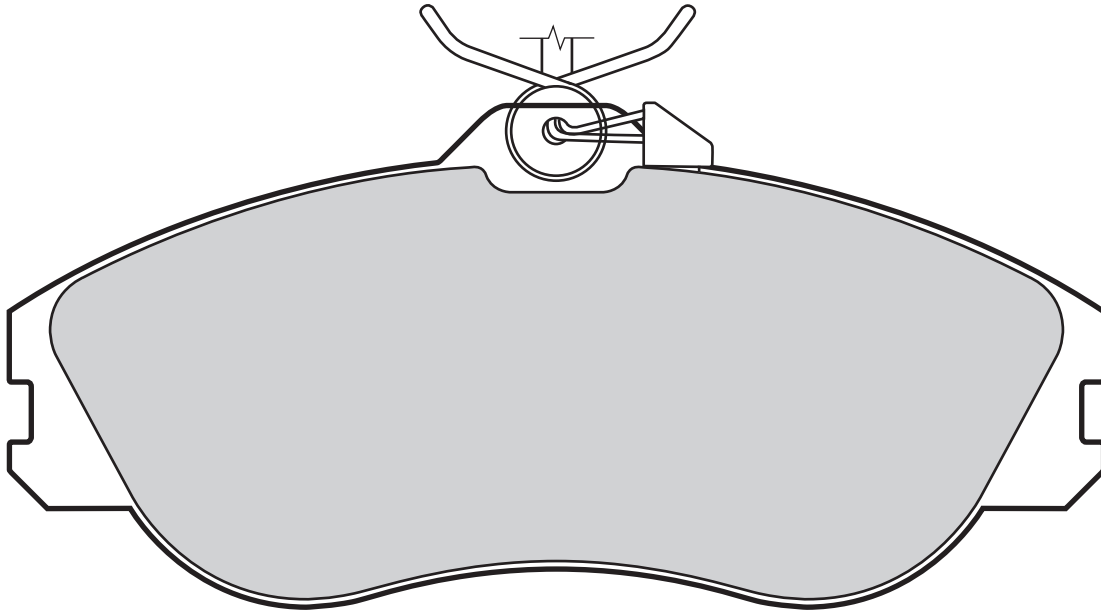

598230

2

145

67

19

LUCAS

AUDI

21140 (WVA)

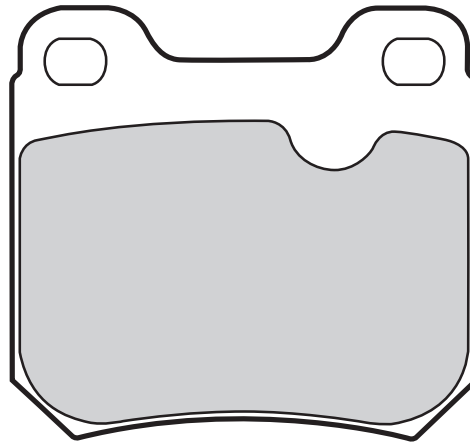

598253

0

61,8

57,2

15,3

TEVES

OPEL, SAAB, VAUXHALL



21141 (WVA)

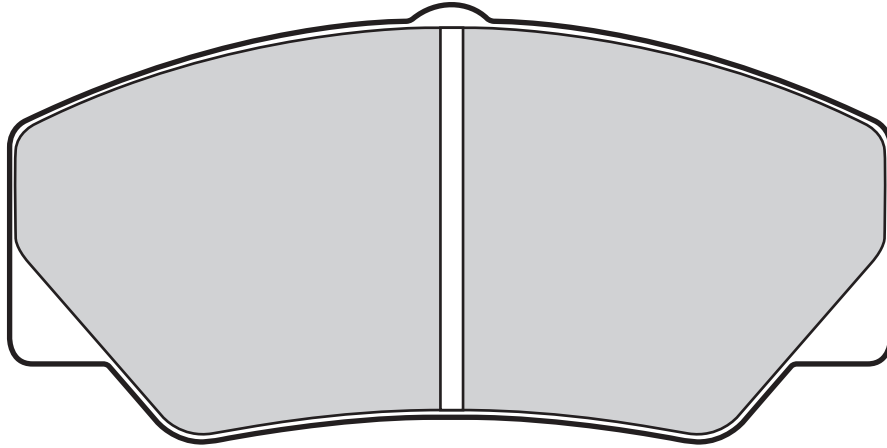

598032

0

117

58

18,3

BENDIX

FORD

21142 (WVA)

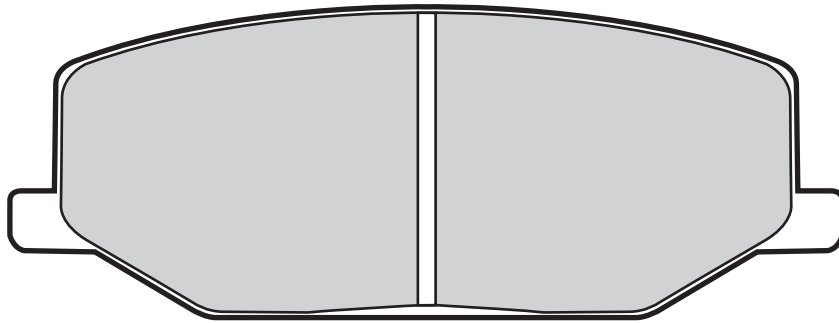

598021

0

110,3

41,5

15

AKEBONO

SUZUKI

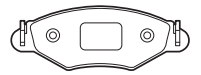

21145 (WVA)

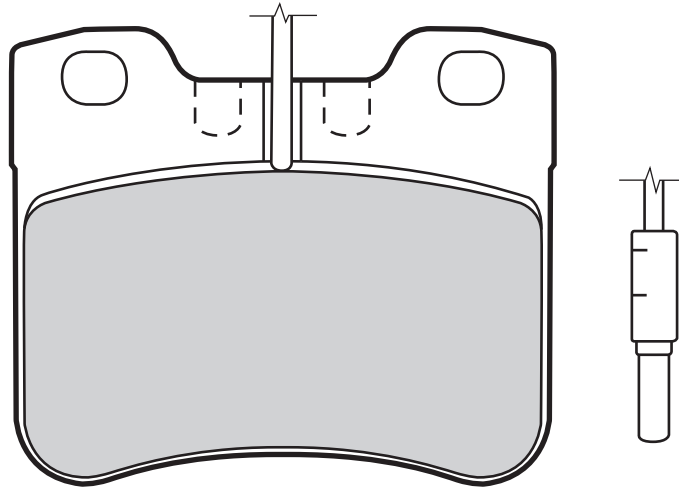

Valeo



Valeo



598030
598156
598360

4
4
0

170
170

71,9
71,9
71,9

60,6
60,6
60,6

16,8
17,1
17,1

TEVES
TEVES
TEVES

CITROËN
CITROËN, PEUGEOT
CITROËN

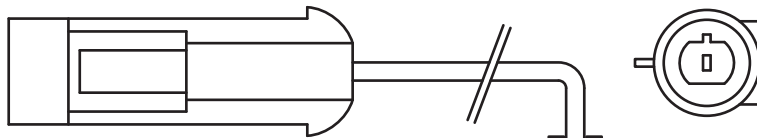
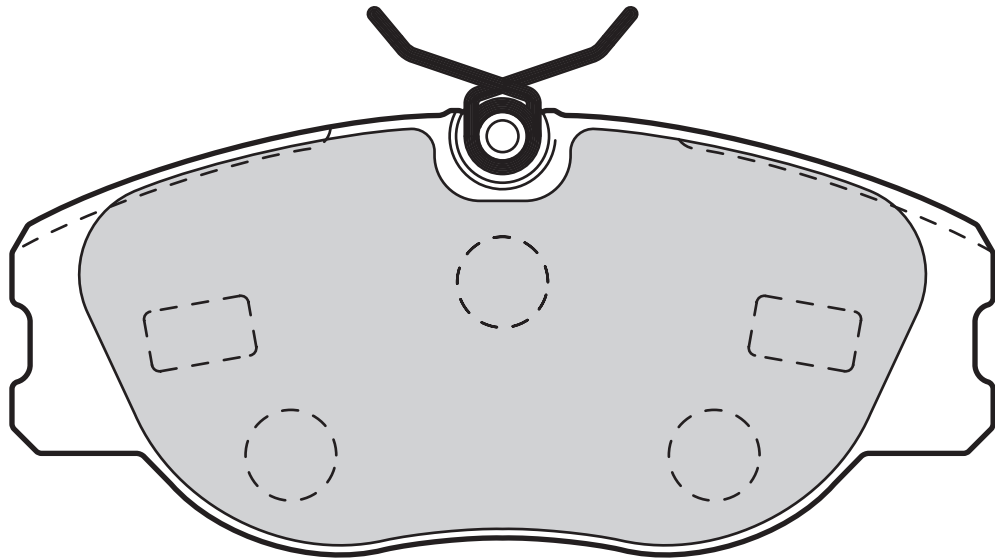
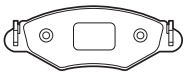

L= 215 mm.

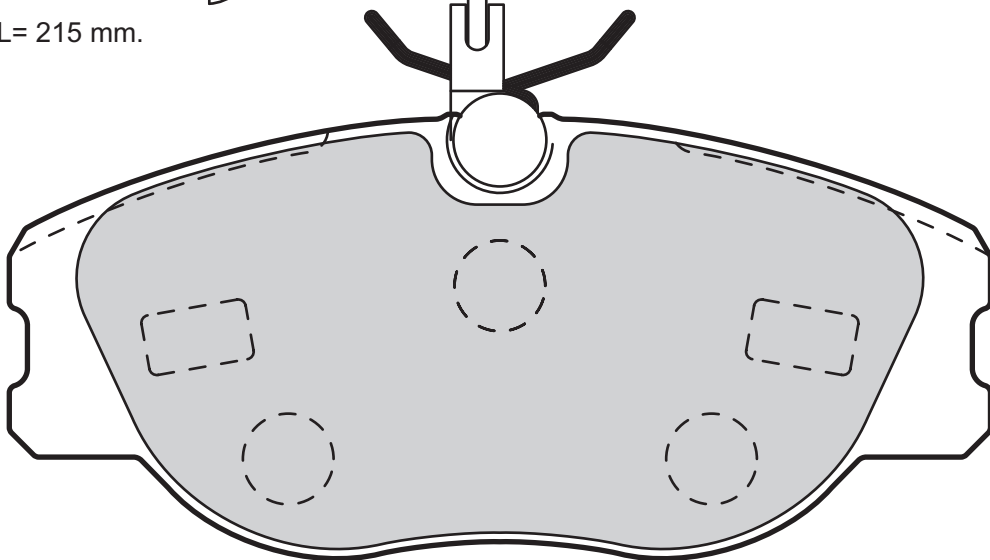

Valeo



Valeo



598985

2

215

129,8

58,7

19

LUCAS

ALFA ROMEO, FIAT, LANCIA



21153 (WVA)

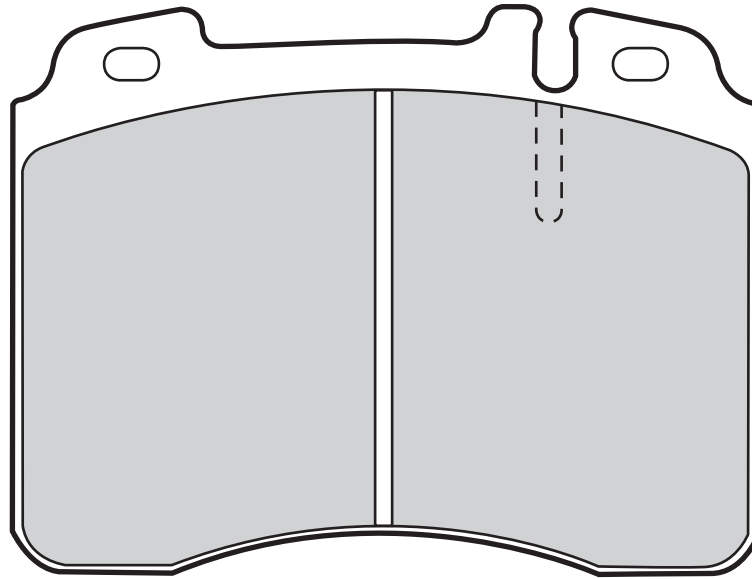

598601

0

98,8

73,5

16

TEVES

MERCEDES

21154 (WVA)

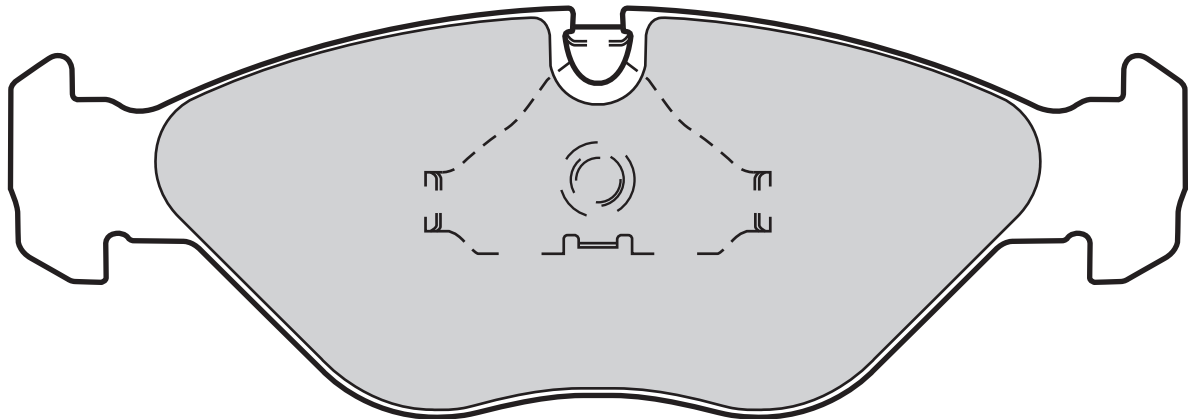

598269

0

156,3

55

19

TEVES

SAAB



21156 (WVA)

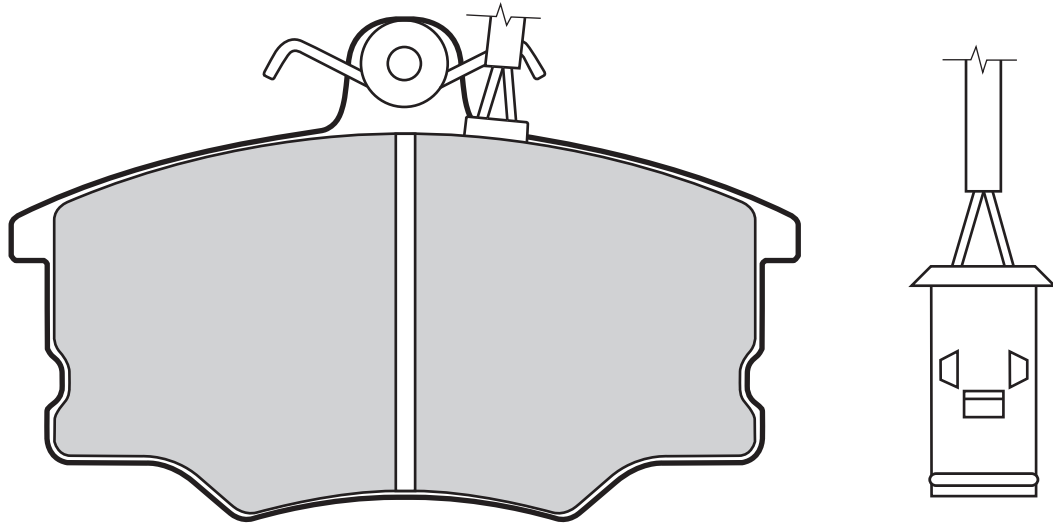

598003	2	440	104,5	66,3	17,4	LUCAS	ALFA ROMEO		

21158 (WVA)

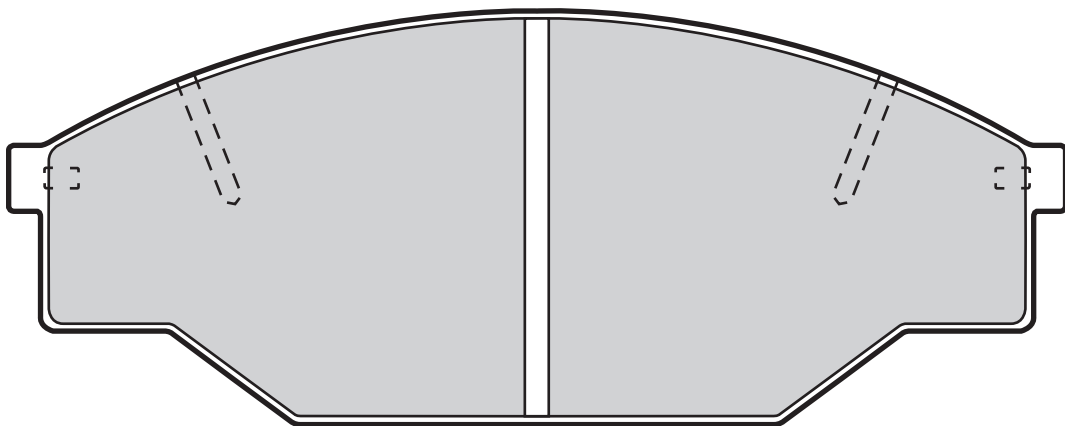

598402	0	140	55,5	15	AKEBONO	TOYOTA			



21165 (WVA)

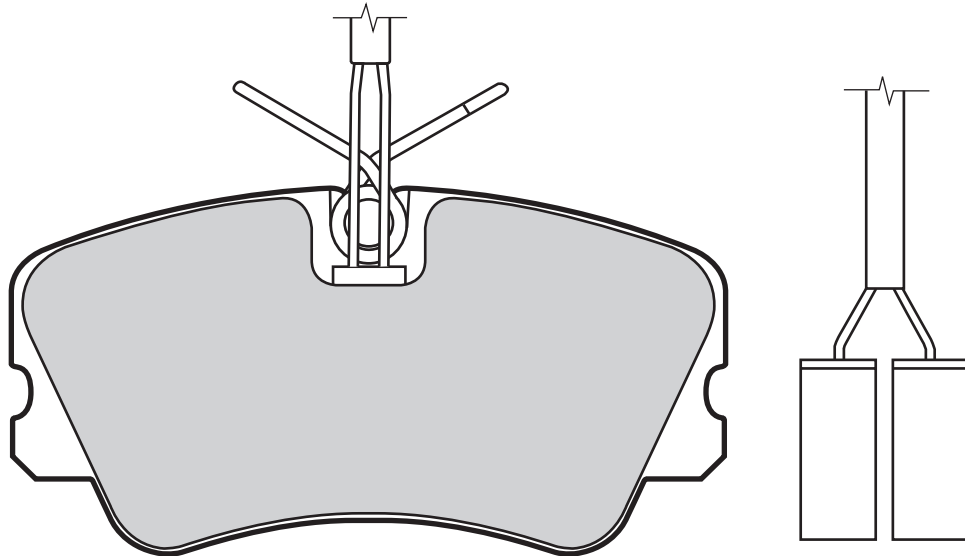

Valeo



Valeo



598008
598289

2
2

720
765

95
95

48,5
48,5

16,5
16,5

TEVES
TEVES

ALFA ROMEO
ALFA ROMEO

21170 (WVA)

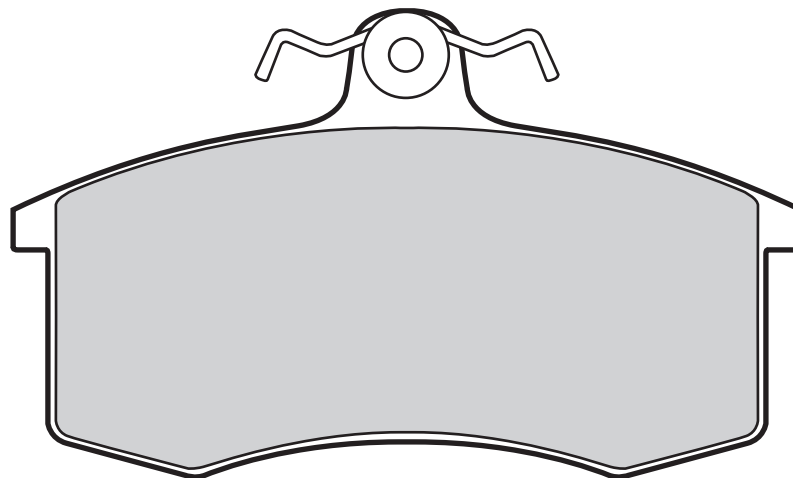

Valeo



Valeo



598406
598660

0
1

170

104,3
104,3

62
62

17,3
17,3

LUCAS
LUCAS

LADA
LADA



21185 (WVA)

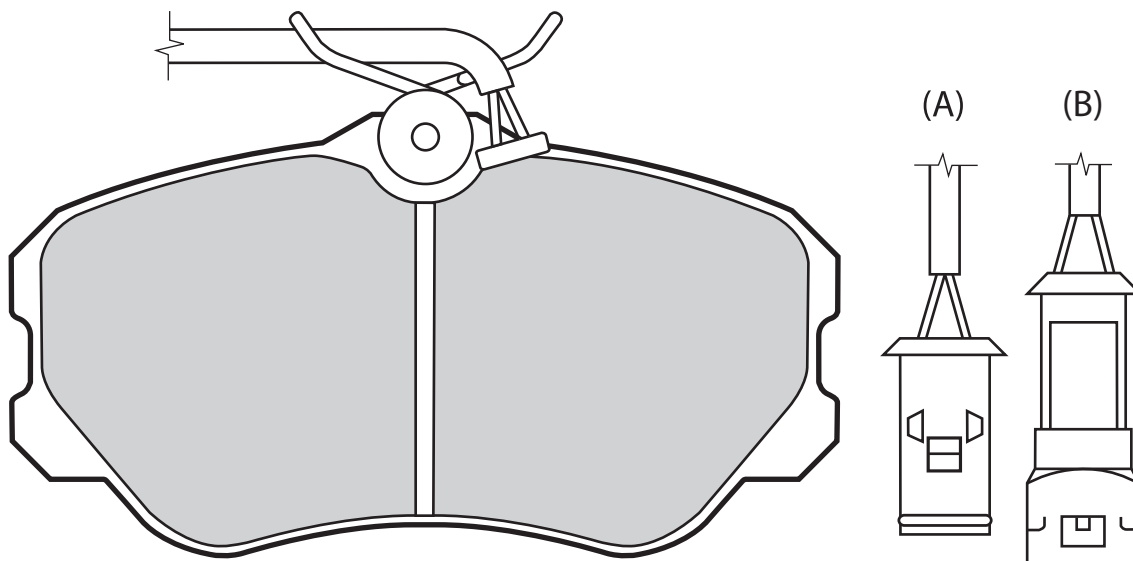

598135	2 (B)	110	59	18,9	LUCAS			ALFA ROMEO, FIAT, LANCIA

21193 (WVA)

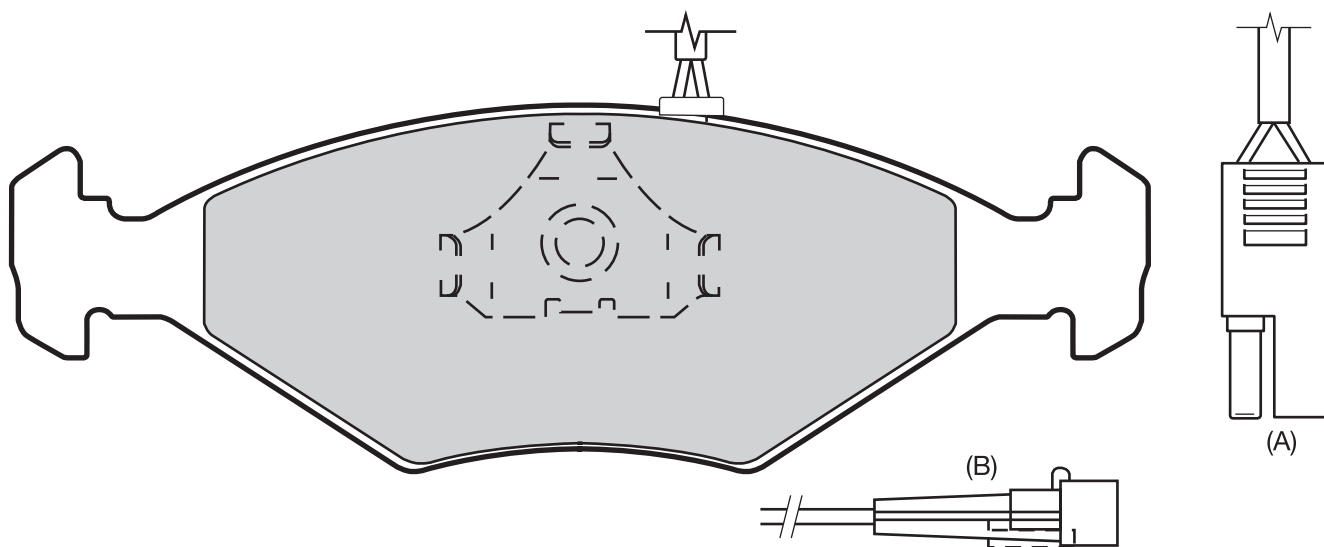

598271	2 (A)	790	151,3	49	18	TEVES		FIAT, INNOCENTI
598423	2 (B)	200	151,4	49	18	TEVES		FIAT

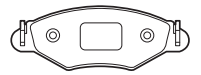

21195 (WVA)

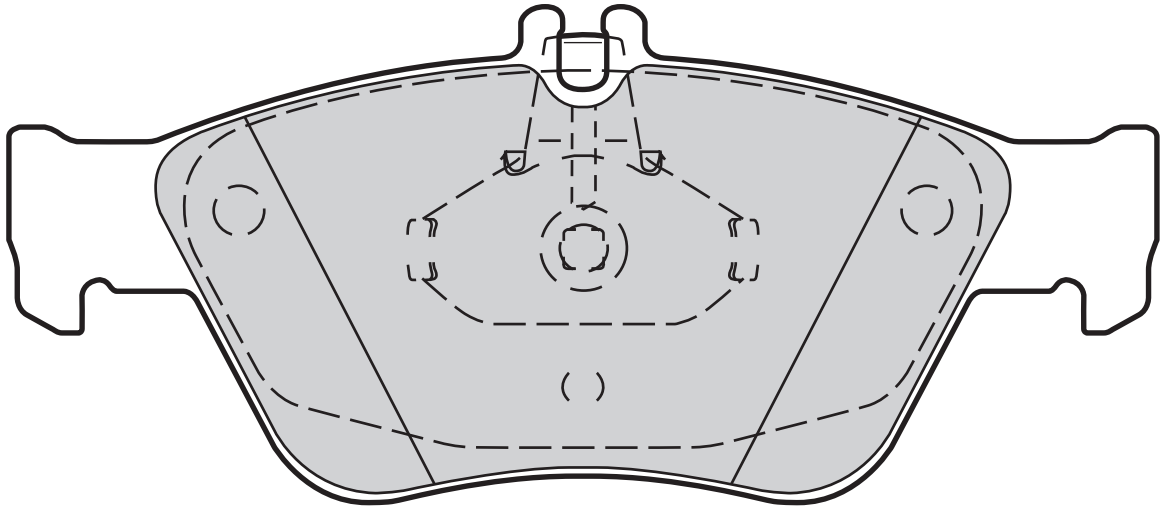

598357

0

151,4

66,2

19,3

TEVES

MERCEDES

21197 (WVA)

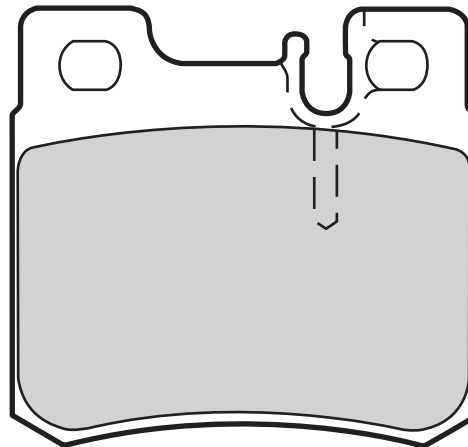

598272

0

61,6

58,6

15

TEVES

MERCEDES



21201 (WVA)

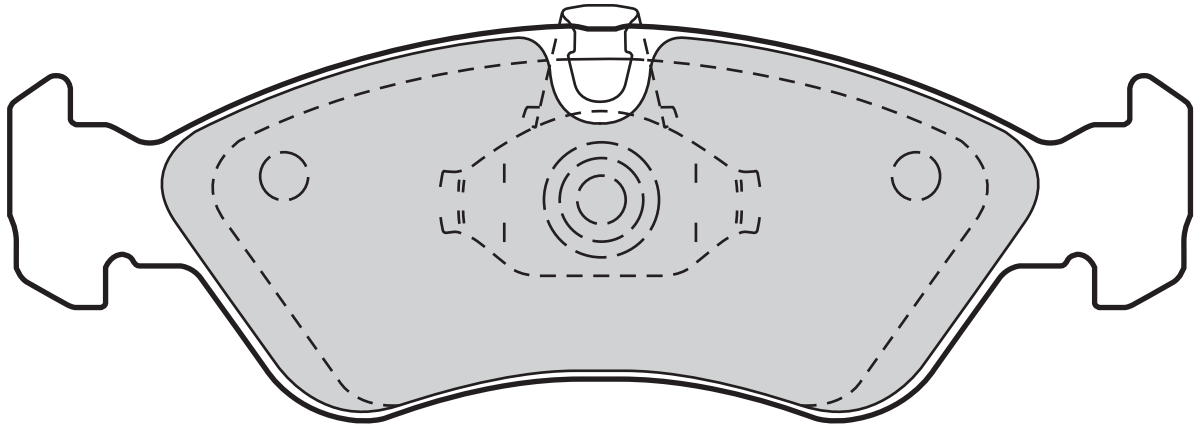

Valeo



0

Valeo



156,3



52,6



17



TEVES



DAEWOO, OPEL, VAUXHALL

598184

21203 (WVA)

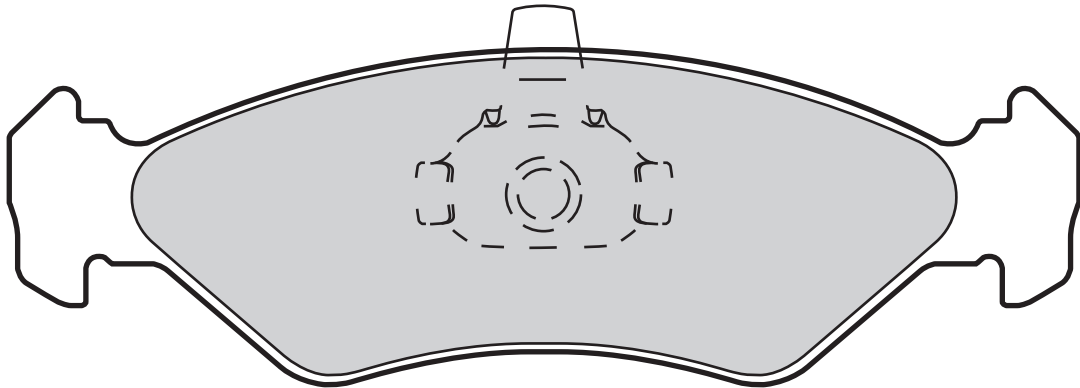

Valeo



0

Valeo



141,5



44,5



17,8



TEVES



FORD

598043

598171

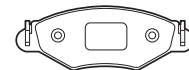

21206 (WVA)

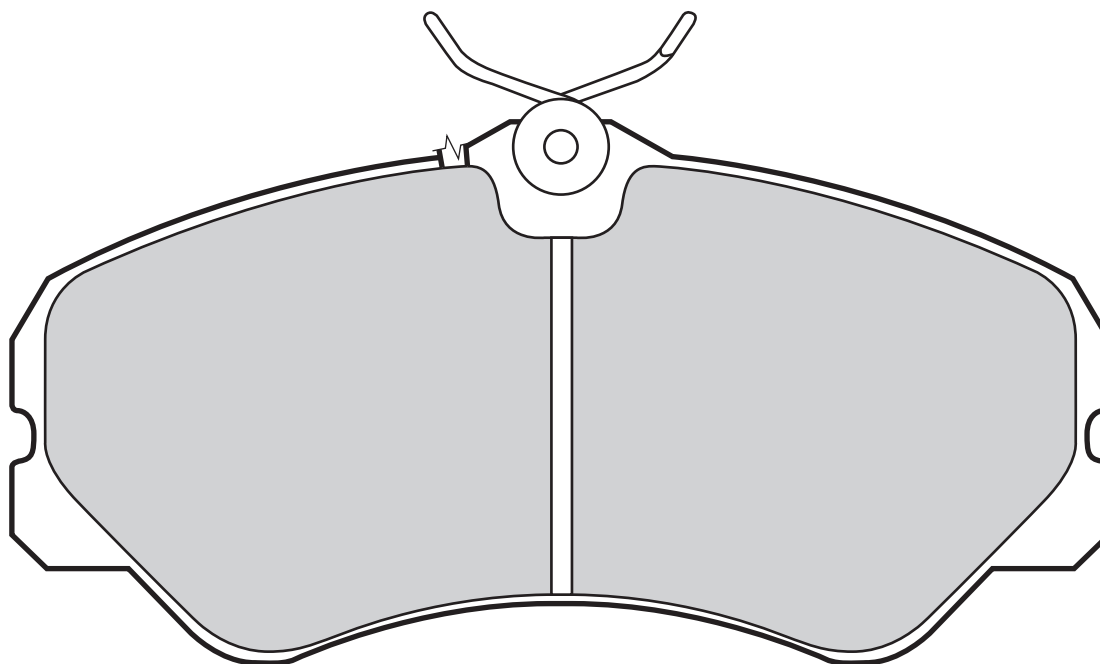

Valeo



2

Valeo



210



145



71,6



19,4



LUCAS



AUVERLAND, CITROËN, FIAT, PEUGEOT

598138

21209 (WVA)

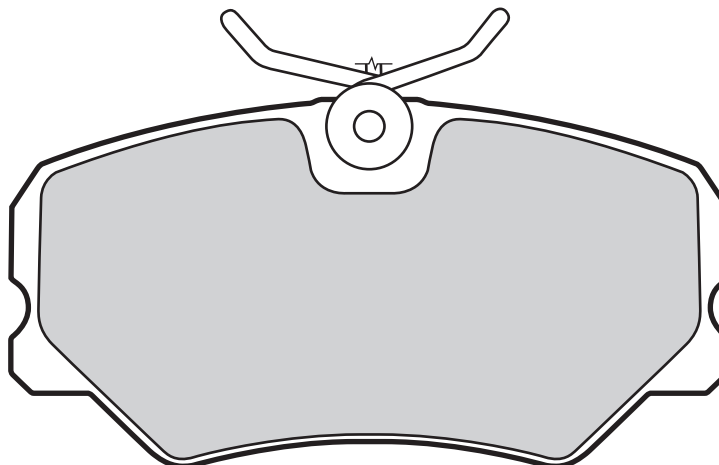

Valeo



2

Valeo



190/310



95



49



18,6



LUCAS



PEUGEOT
CITROËN, PEUGEOT

598179

598353

4

280/315

95

49,5

18,5

LUCAS



21211 (WVA)

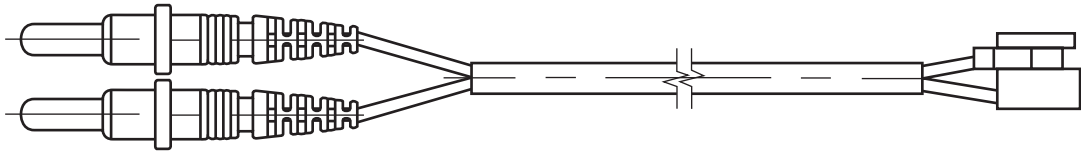
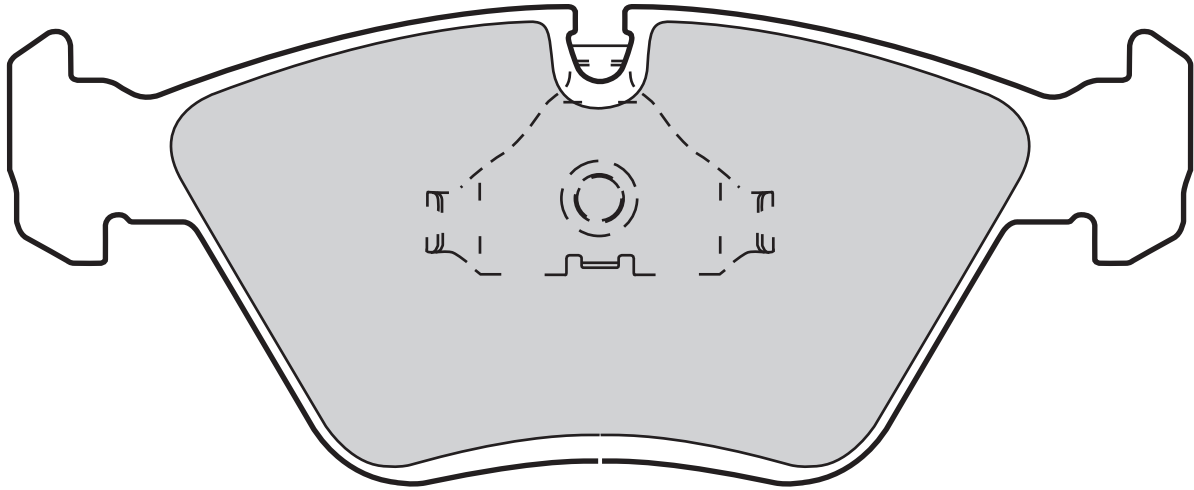

Valeo



2

Valeo



265



156,3



63,8



18,7



TEVES



PEUGEOT

598281

21217 (WVA)

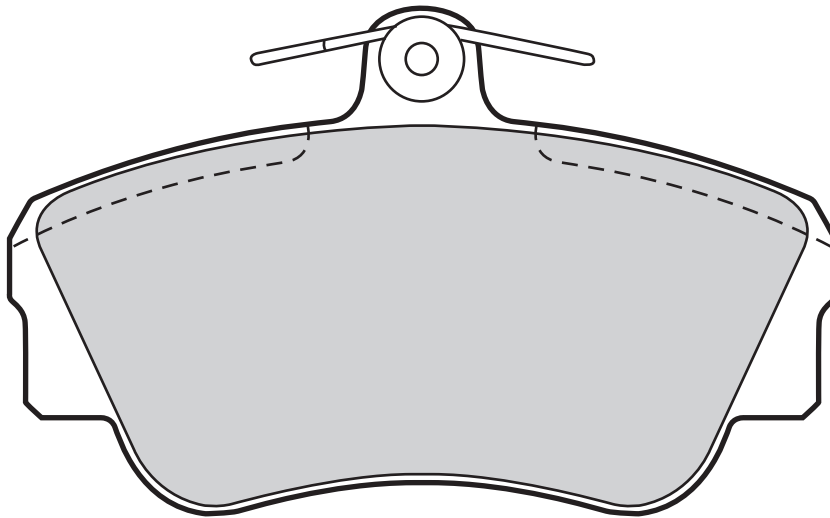

Valeo



0

Valeo



110



67,5



17,2



LUCAS



VOLVO

598015



21226 (WVA)

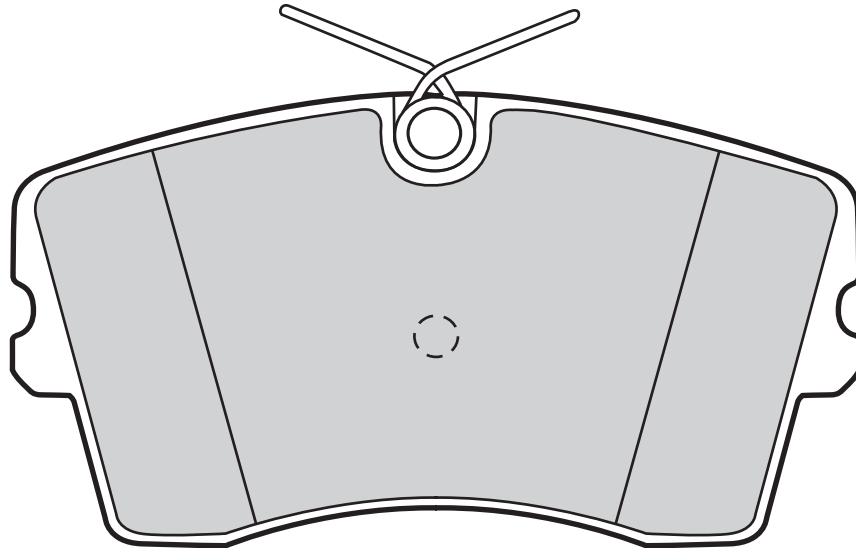

598186

0

112

60

17

TEVES

OPEL, VAUXHALL

21227 (WVA)

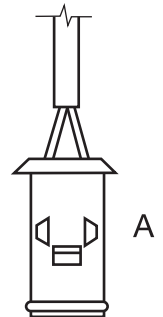
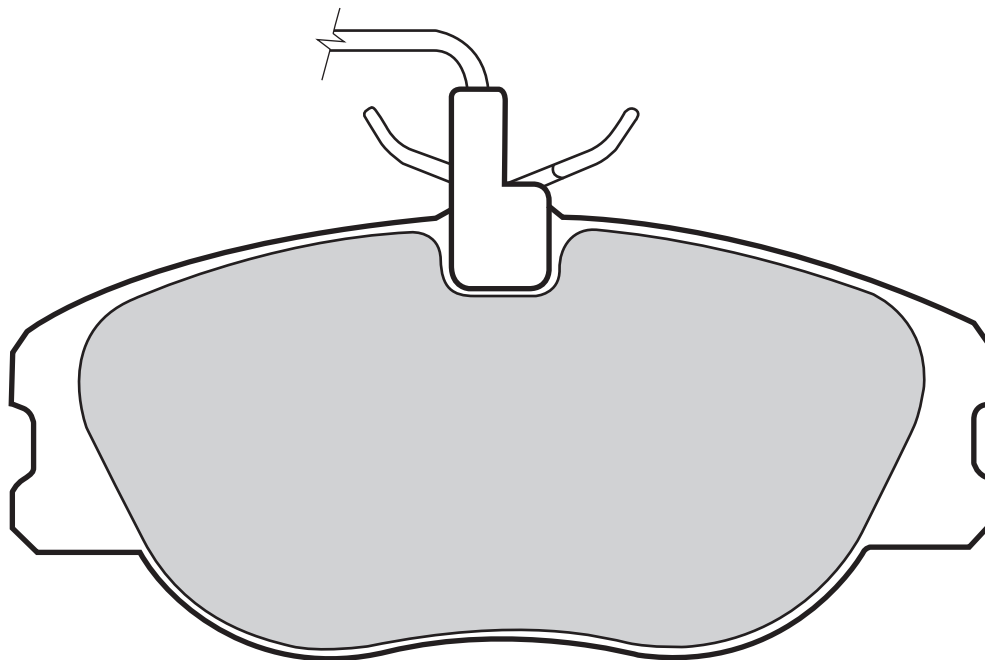

A



B



C



598006

2 (A)

440

130

58,8

19,3

LUCAS

ALFA ROMEO

598010

2 (C)

185

130

57,4

18,8

LUCAS

ALFA ROMEO



Valeo

21233 (WVA)

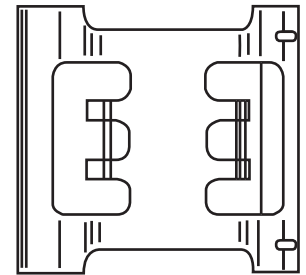
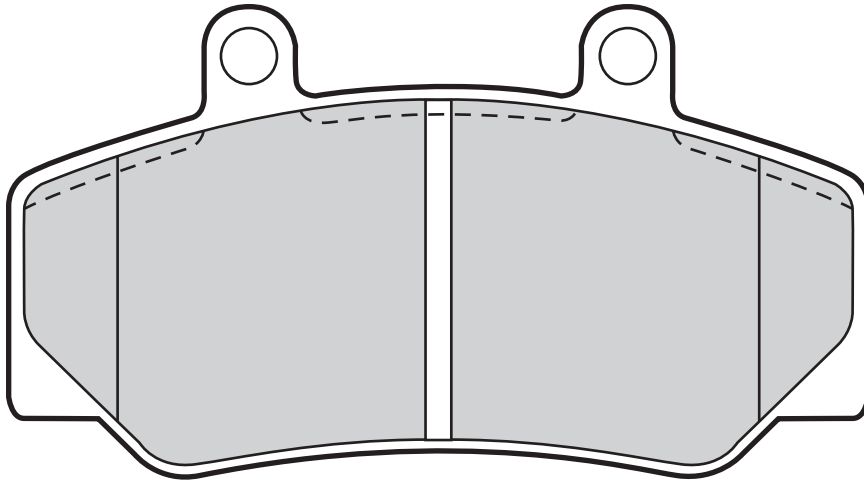

Valeo



Valeo



598257

0

113,9

62

16,7

BENDIX

VOLVO

21237 (WVA)

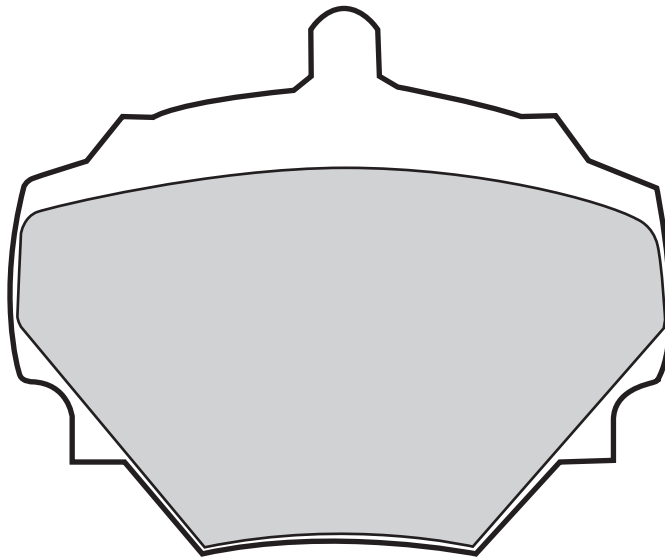

Valeo



Valeo



598497

1

88,6

72

15,5

AP

LAND ROVER



21245 (WVA)

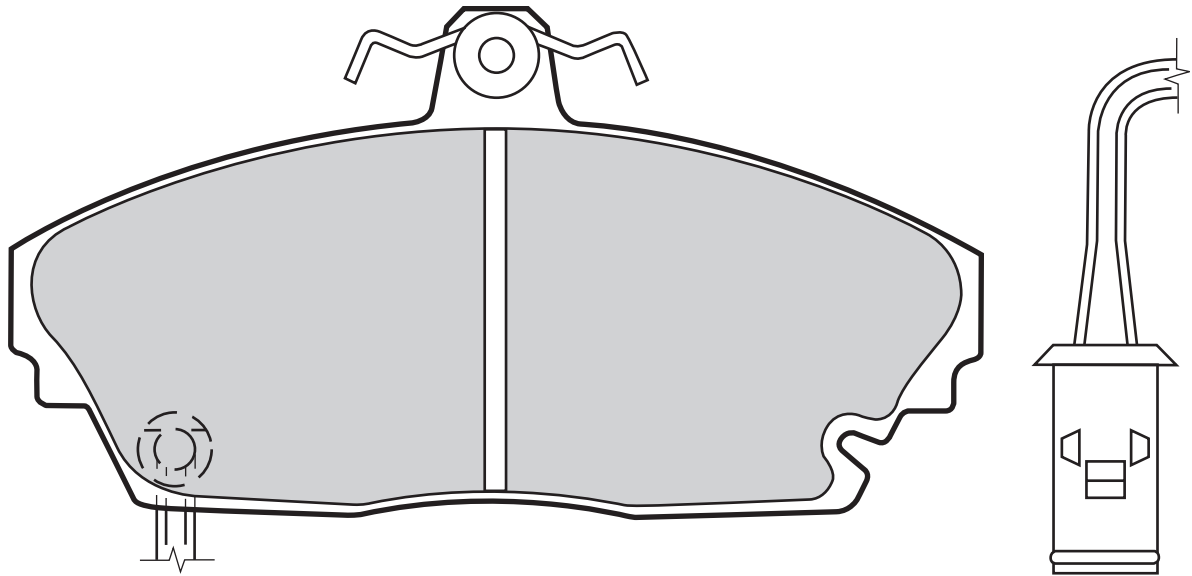

Valeo



Valeo



598227

1

129,3

68

17,5

LUCAS

HONDA, ROVER

21272 (WVA)

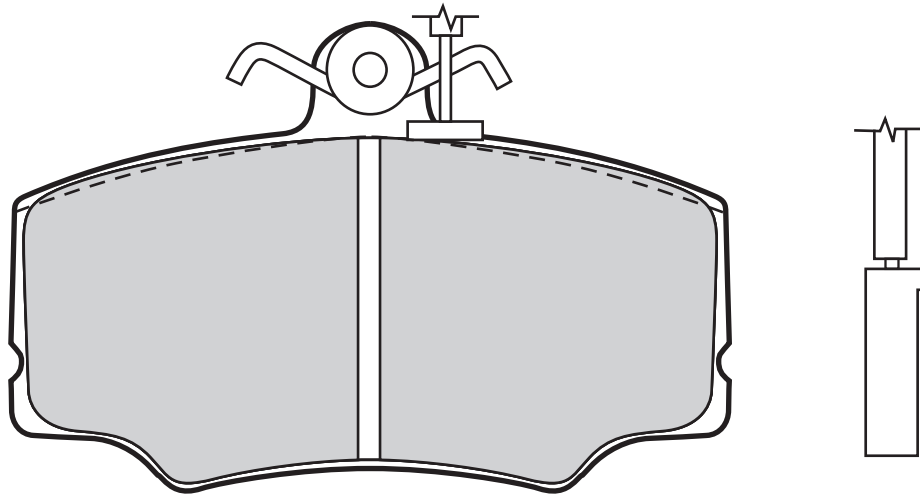

Valeo



Valeo



598005

2

900

95

61,8

17

BENDIX

ALFA ROMEO

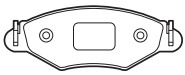

Valeo

21273 (WVA)

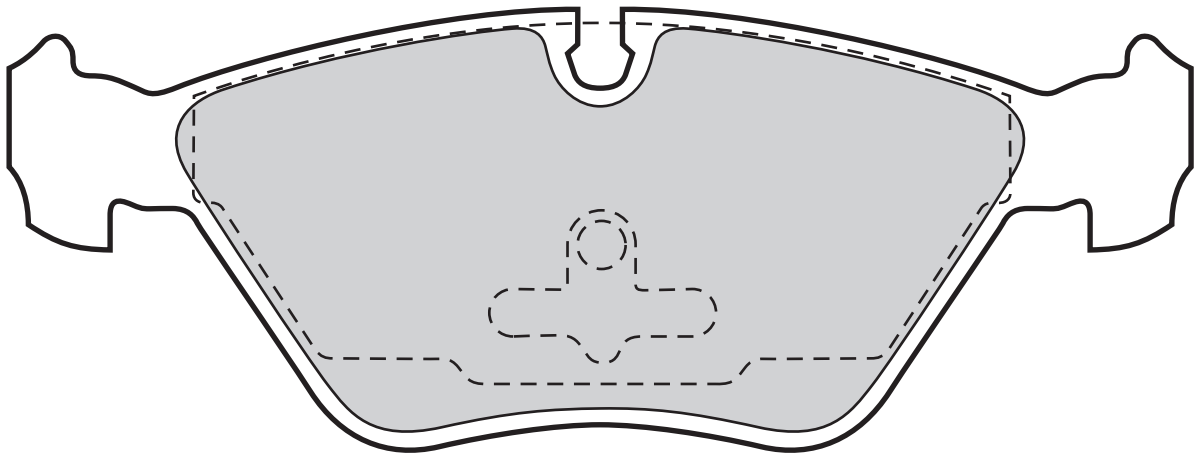
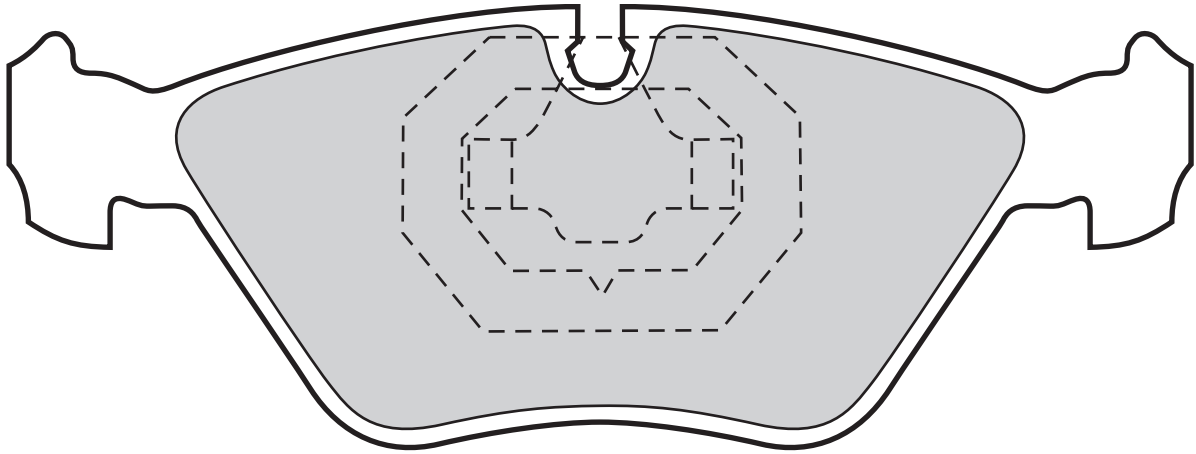

Valeo



Valeo



598616

2

156,3

58,3

19,5

TEVES

VOLVO

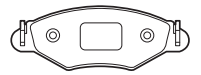

21275 (WVA)

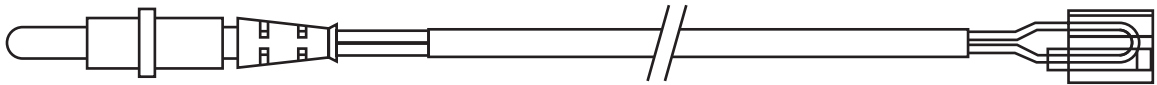
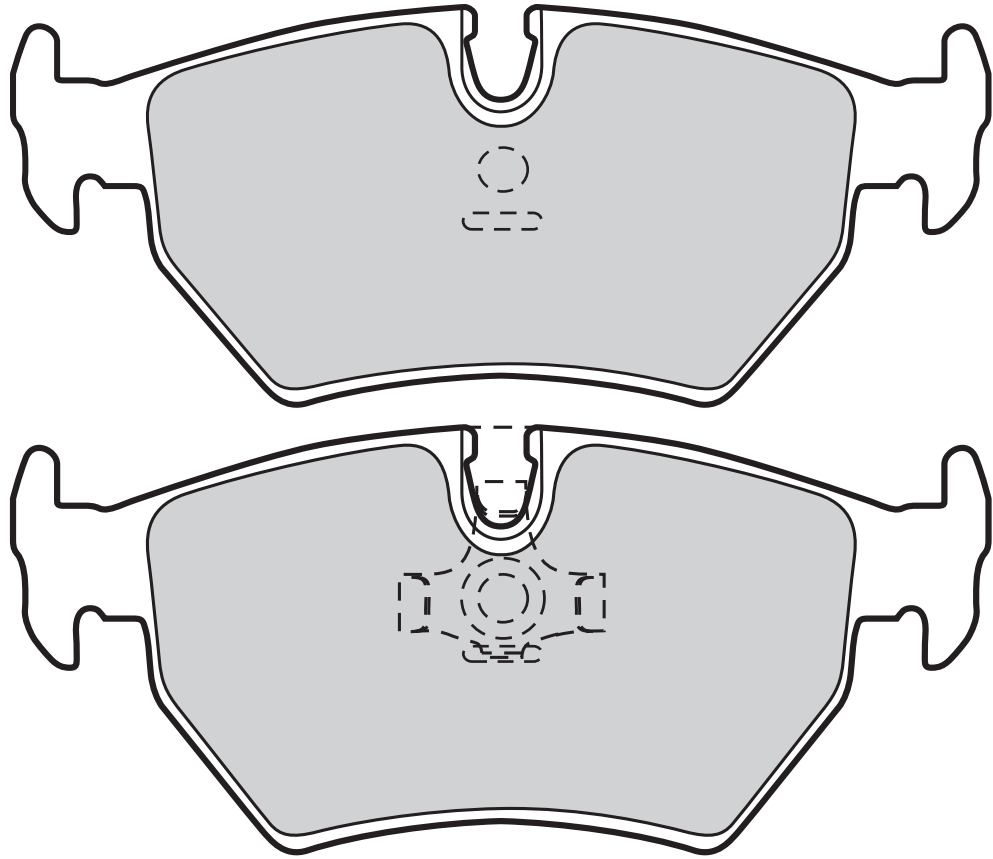

Valeo



0

Valeo



129



56,2



17



TEVES



CITROËN, FIAT, LANCIA, PEUGEOT

598502

21277 (WVA)

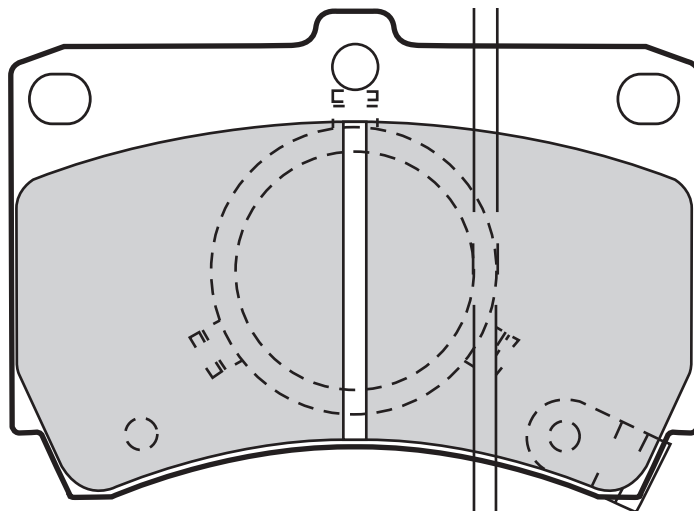

Valeo



2

Valeo



91,5



64



15



SUMITOMO



MAZDA

598293



21279 (WVA)

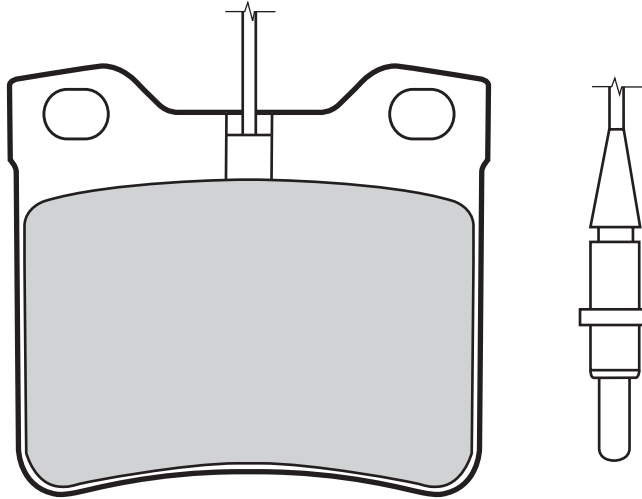

Valeo



Valeo



598062
598063
598295

2
0
2

130

130

63,5
63,5
63,5

57
57
57

16,9
16,4
17

TEVES
TEVES
TEVES

MERCEDES
PEUGEOT
PEUGEOT

21280 (WVA)

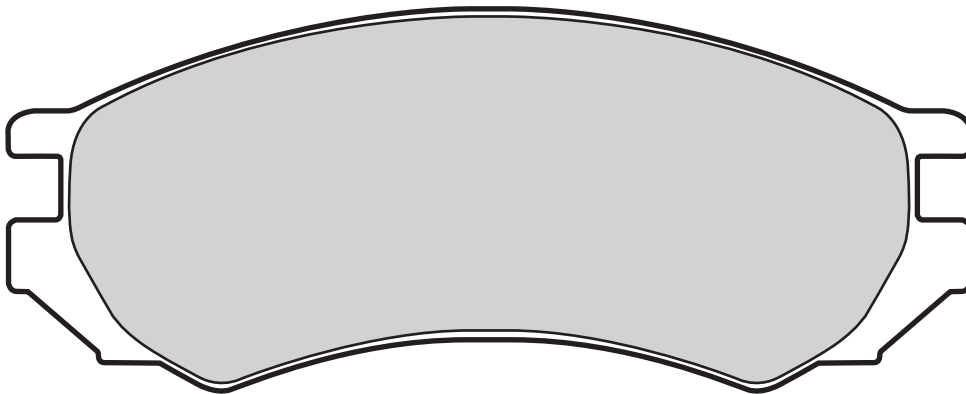

Valeo



Valeo



598024

0

128,1

51

16

AKEBONO

NISSAN



21282 (WVA)

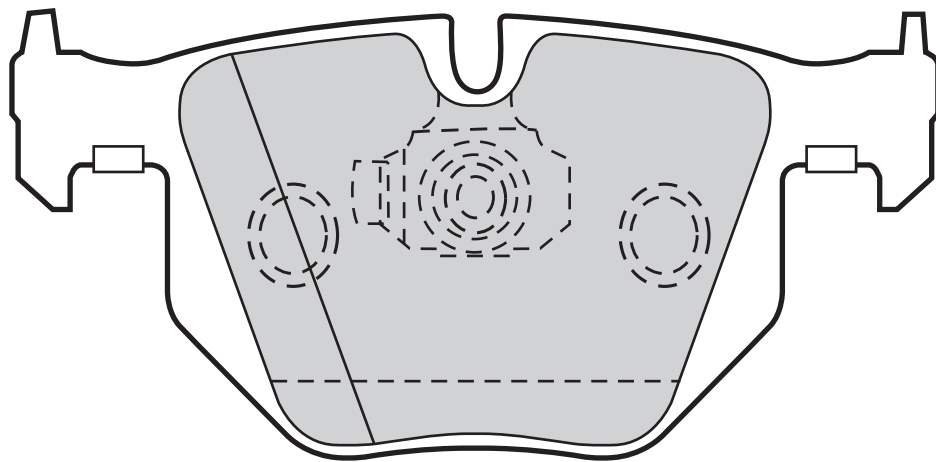
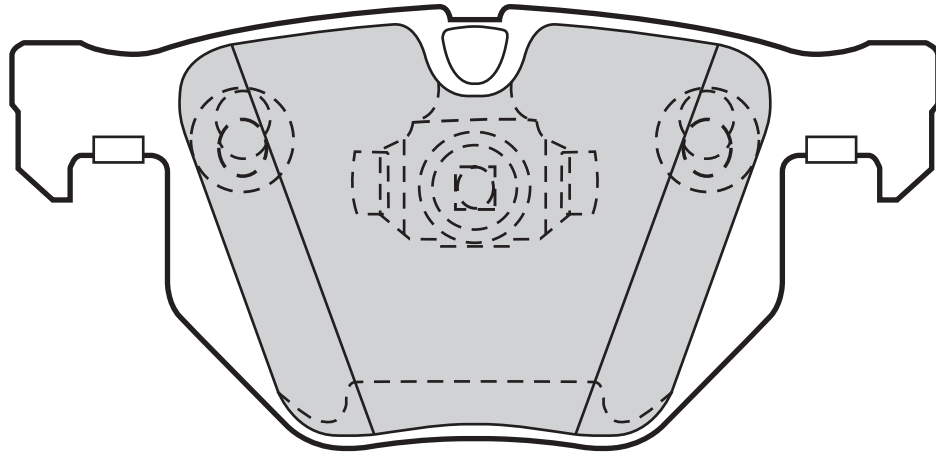

Valeo



Valeo



598411

0

123,1

58,2

17

TEVES

BMW

21292 (WVA)

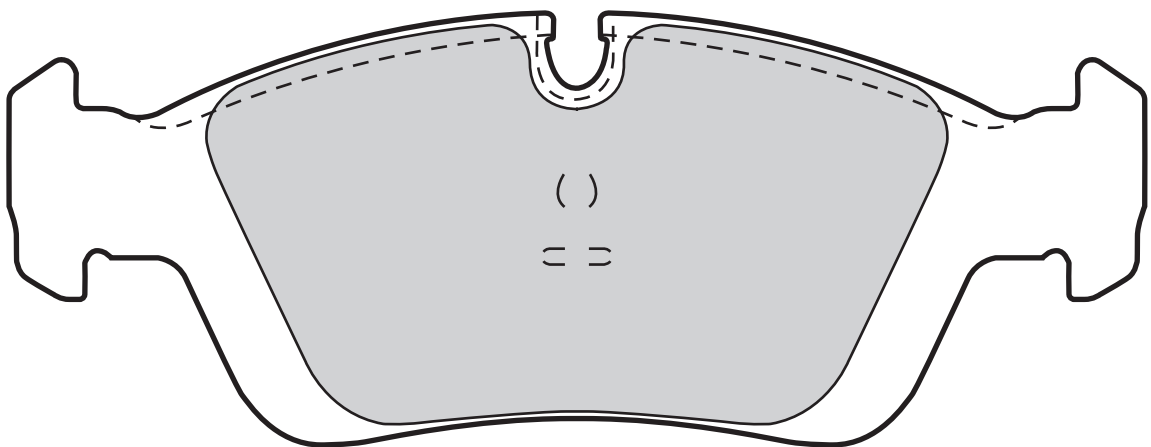

Valeo



Valeo



598018

0

151,3

57

17,3

TEVES

BMW



21295 (WVA)

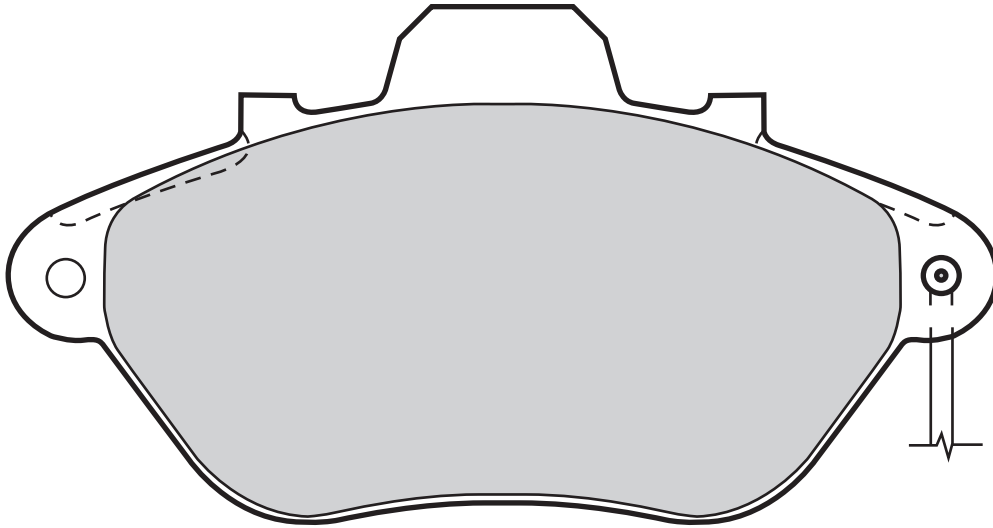

Valeo									
598029	4	340/120	131	68,5	17	BENDIX	CITROËN		
598294	4	340/120	131	68,5	17	BENDIX	PEUGEOT, RENAULT		

21305 (WVA)

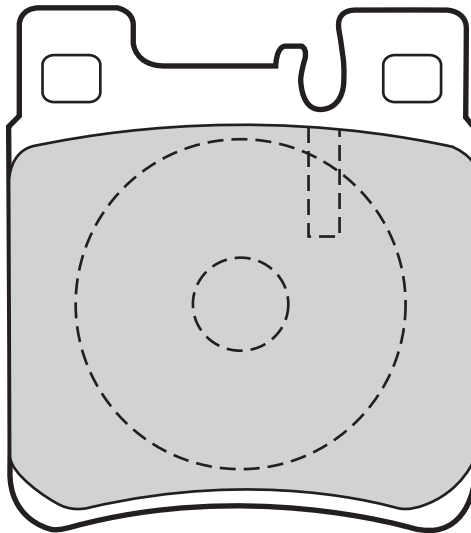

Valeo									
598617	0		61,7	69,6	15,5	TEVES	MERCEDES		



21312 (WVA)

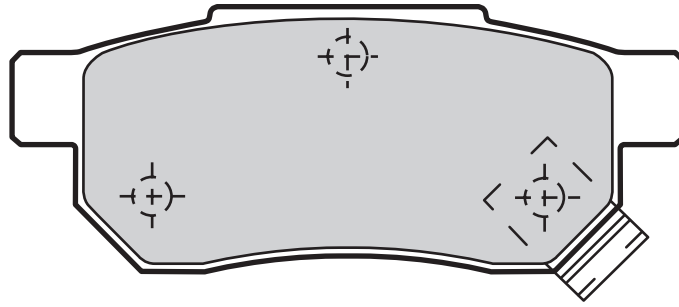

598053

2

89

35

13

AKEBONO

HONDA, MG, ROVER

21322 (WVA)

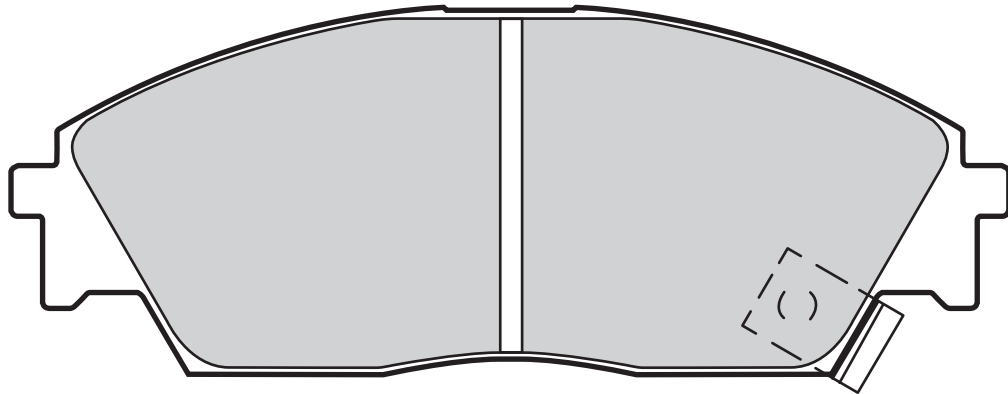

598248

2

132,1

49,4

15

AKEBONO

HONDA

21333 (WVA)

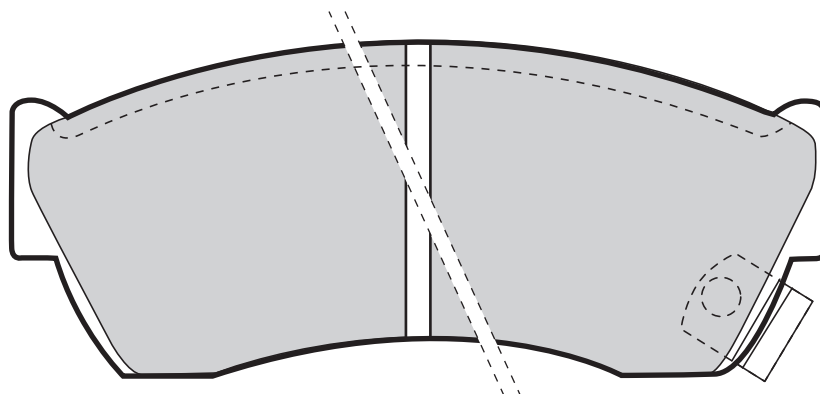

598666

2

107,3

44,6

14,5

AKEBONO

SUBARU, SUZUKI



21336 (WVA)

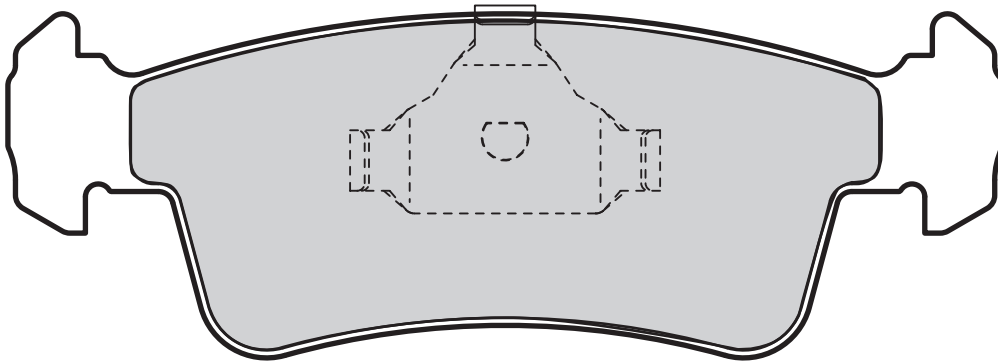
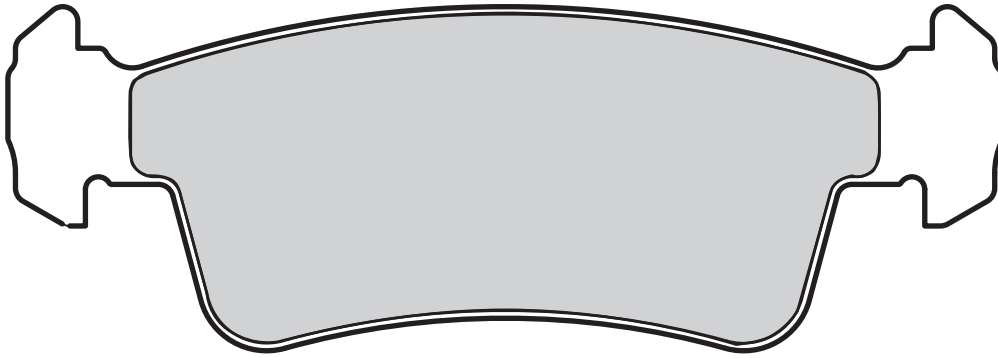

598532

0

131,5

45,5

15

TEVES

SUZUKI

21344 (WVA)

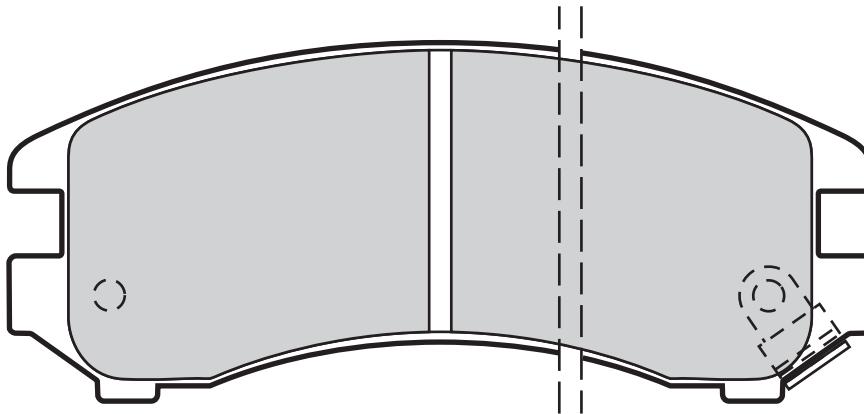

598296

2

114,8

47,5

16

AKEBONO

NISSAN, SUZUKI



21347 (WVA)

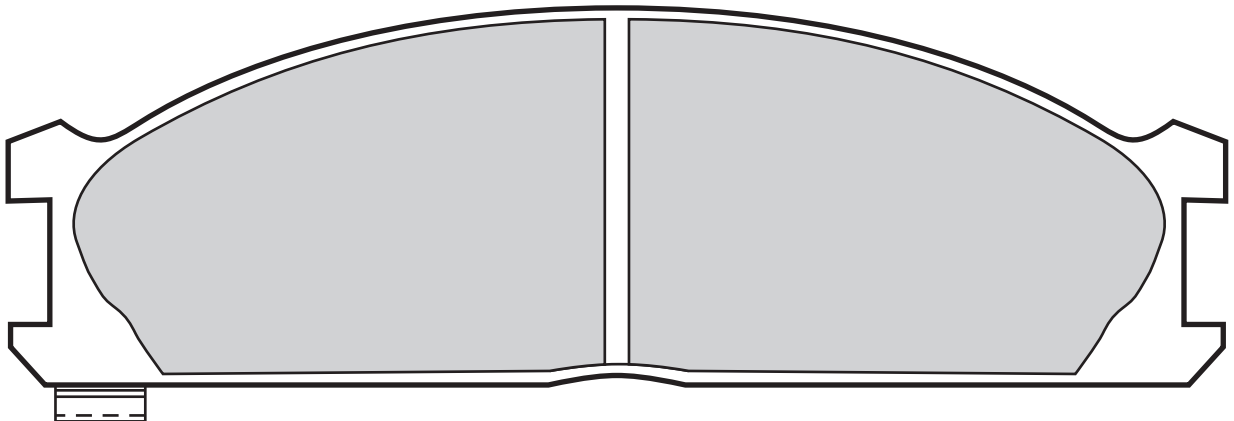
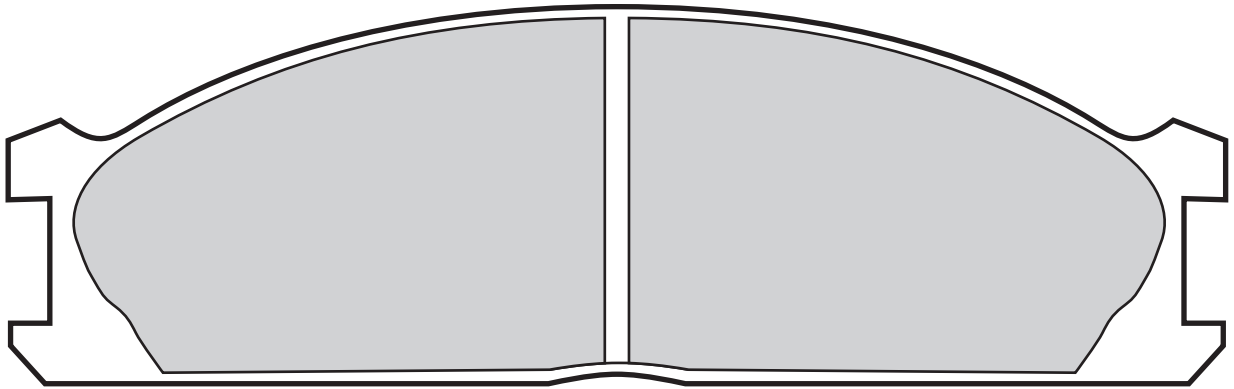

Valeo



Valeo



598618

2

161

49,8

17

AKEBONO

NISSAN

21353 (WVA)

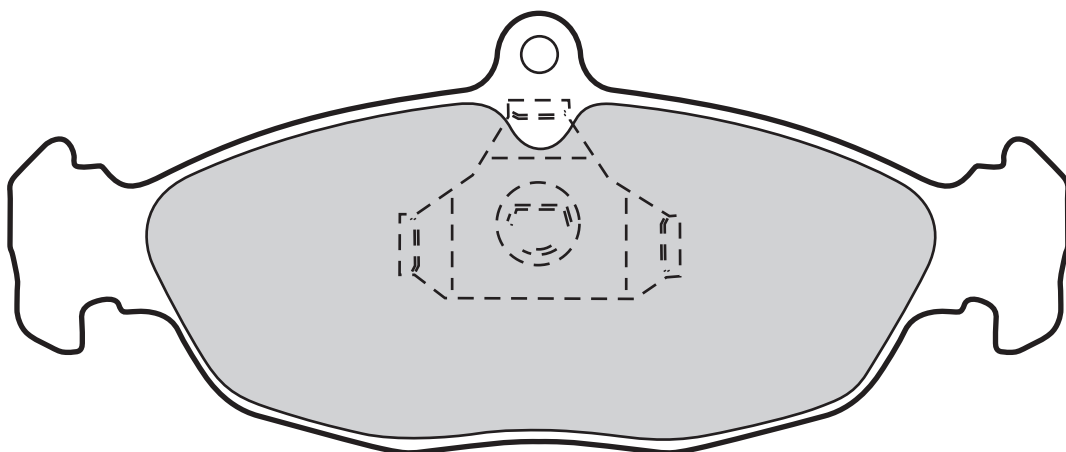

Valeo



Valeo



598039

0

140,1

48,5

16,8

TEVES

DAEWOO, JAGUAR

598356

2

140,1

48,5

16,8

TEVES

OPEL, VAUXHALL



Valeo

21355 (WVA)

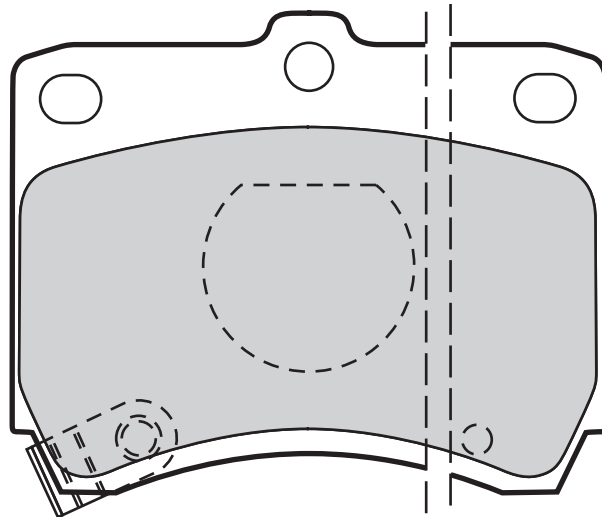

Valeo



4



78,7



63,3



14,4



SUMITOMO



KIA, MAZDA

598268

21363 (WVA)

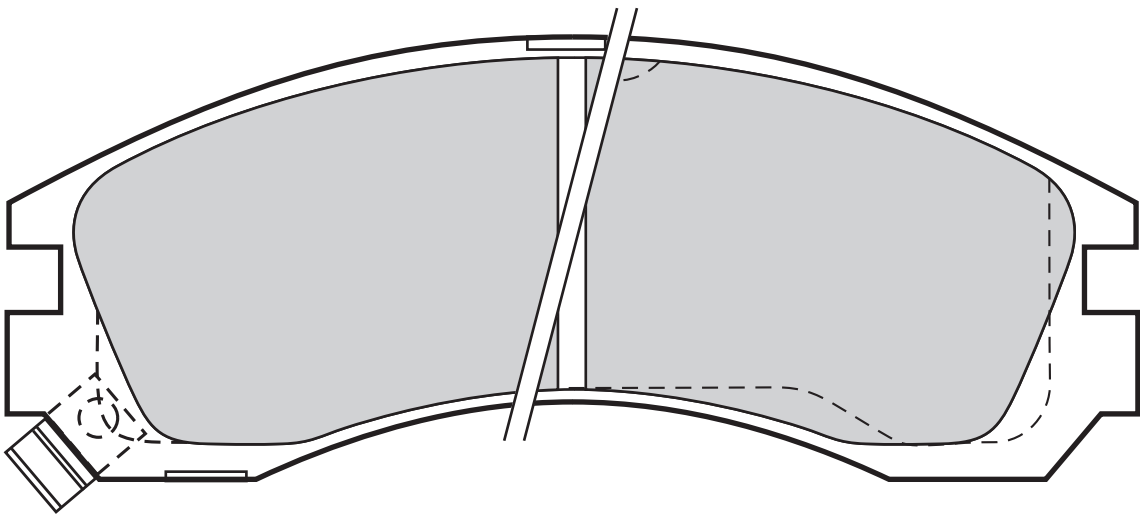

Valeo



2



150



59



15,7



AKEBONO



MITSUBISHI

598517



21365 (WVA)

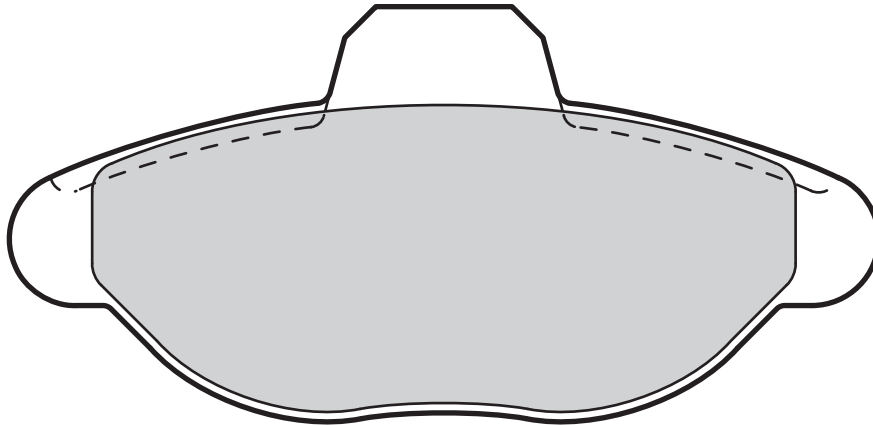

Valeo



Valeo



598011
598012
601021

1
0
0

475

115
115
114,9

55,3
55,3
54,8

17
17
16,2

BENDIX
BENDIX
BOSCH

FIAT
FIAT, LANCIA
FIAT



21366 (WVA)

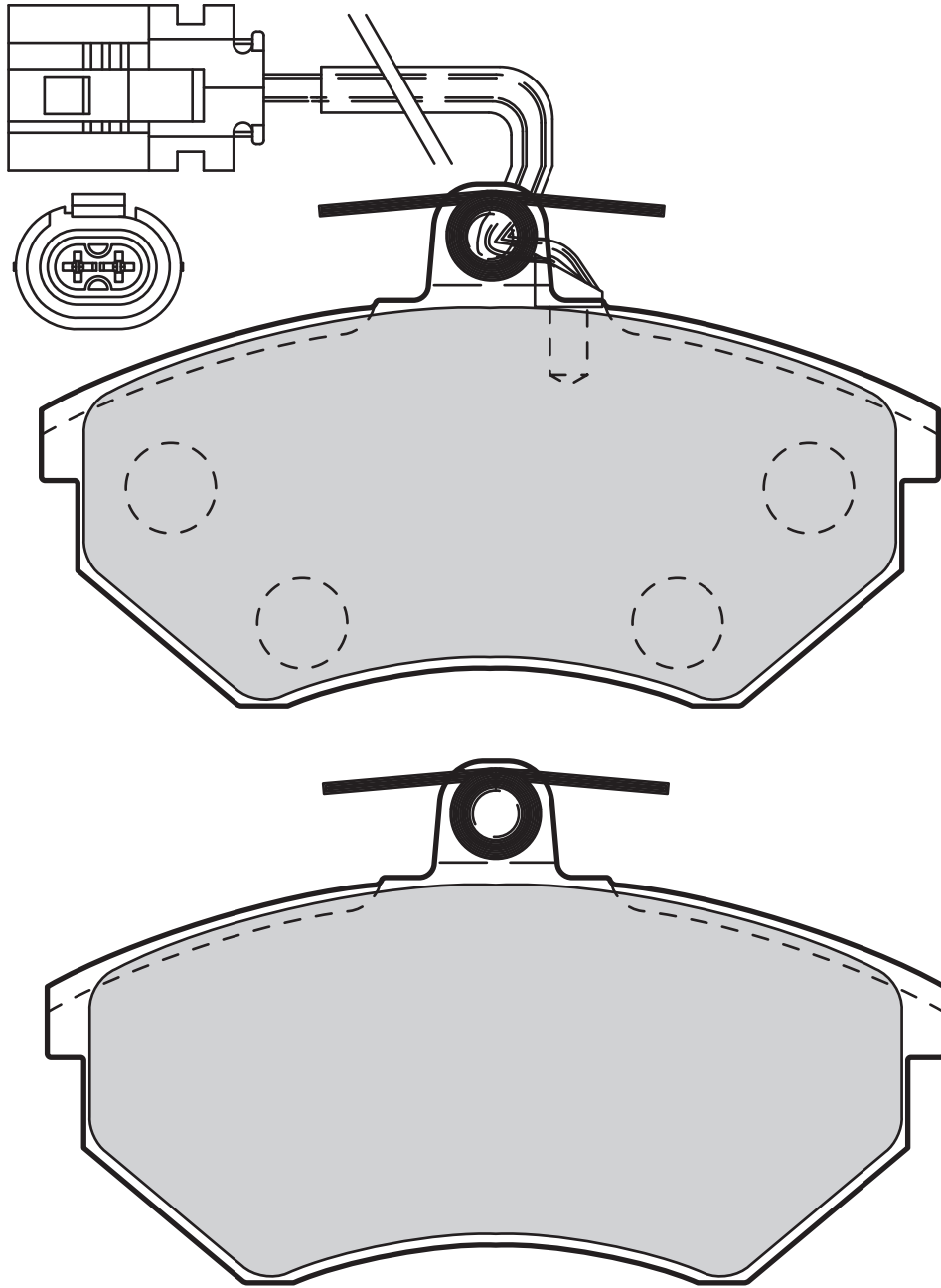

Valeo		Valeo					
598484	2	210	119	69,5	19,4	LUCAS	AUDI, SEAT, VOLKSWAGEN
598982	2	220	118,9	69,5	16,3	LUCAS	VOLKSWAGEN



21368 (WVA)

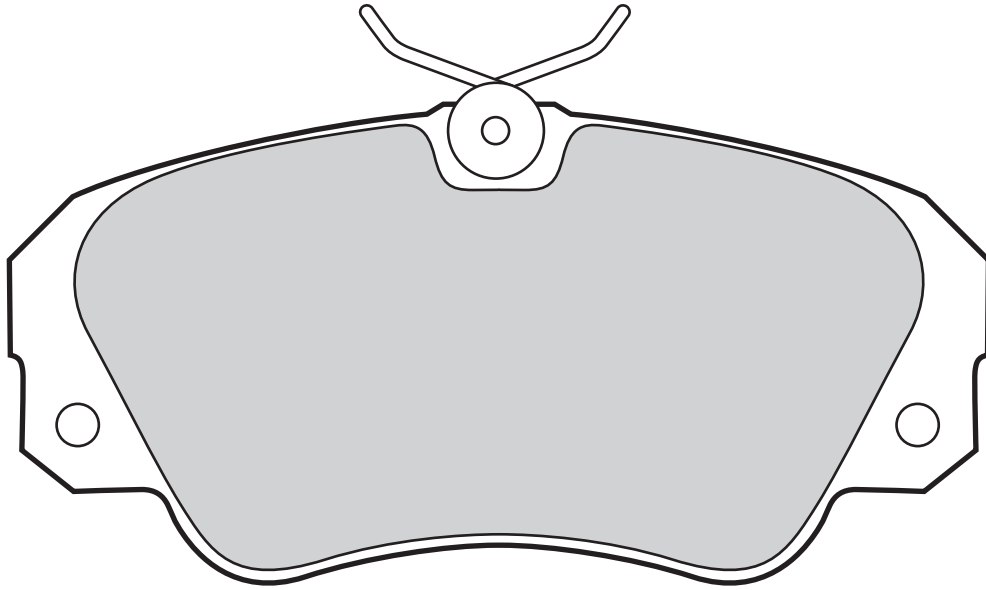

598256

0

129,8

63,9

18,6

LUCAS

OPEL, VAUXHALL

21370 (WVA)

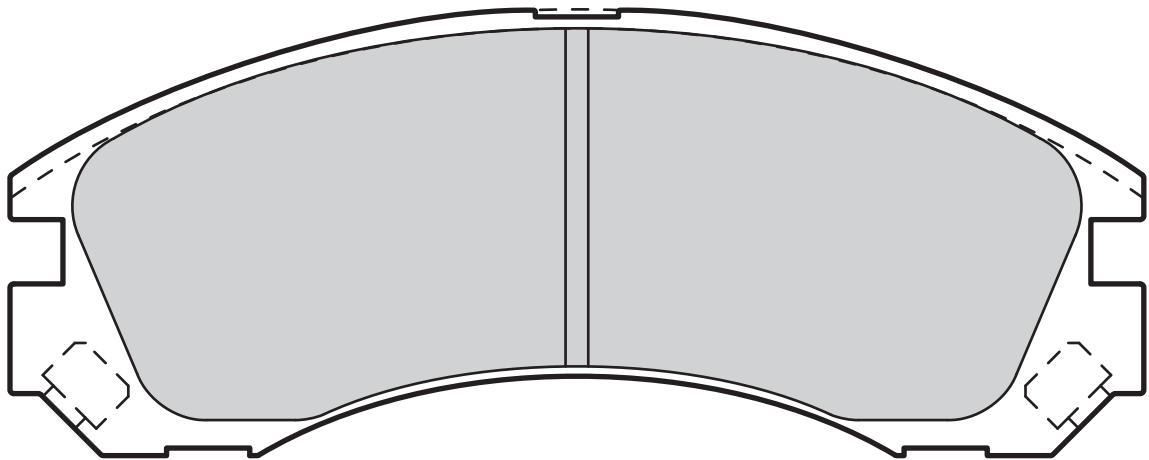

601020

2

Leaf

149,9

59

15,7

AKEBONO

mitsubishi



21373 (WVA)

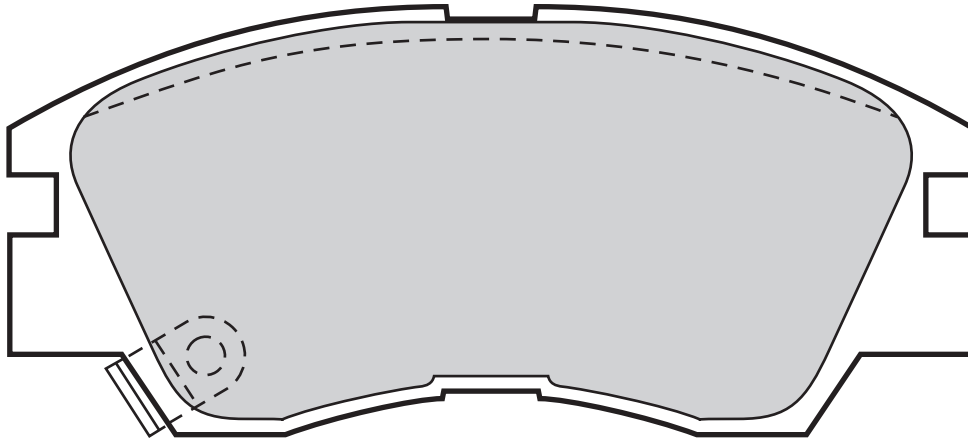

598620

0

128

57

15,5

AKEBONO

mitsubishi

21378 (WVA)

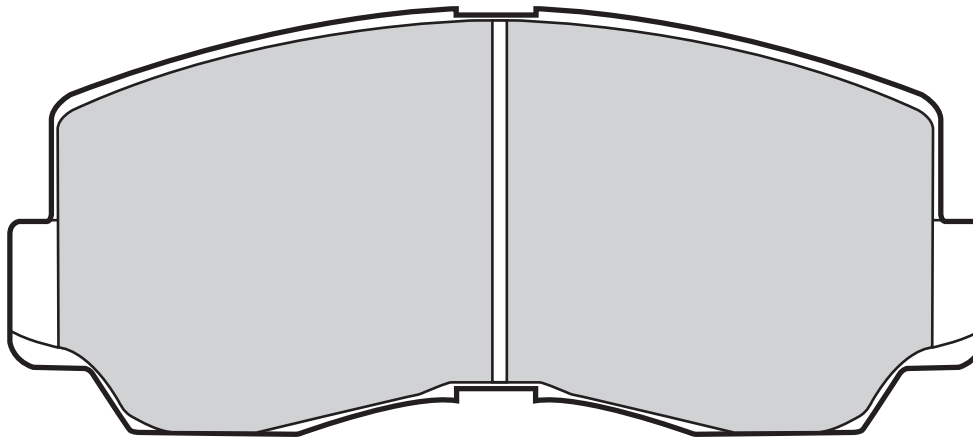

598250

2

130

52,3

15

SUMITOMO

FORD, MAZDA



21381 (WVA)

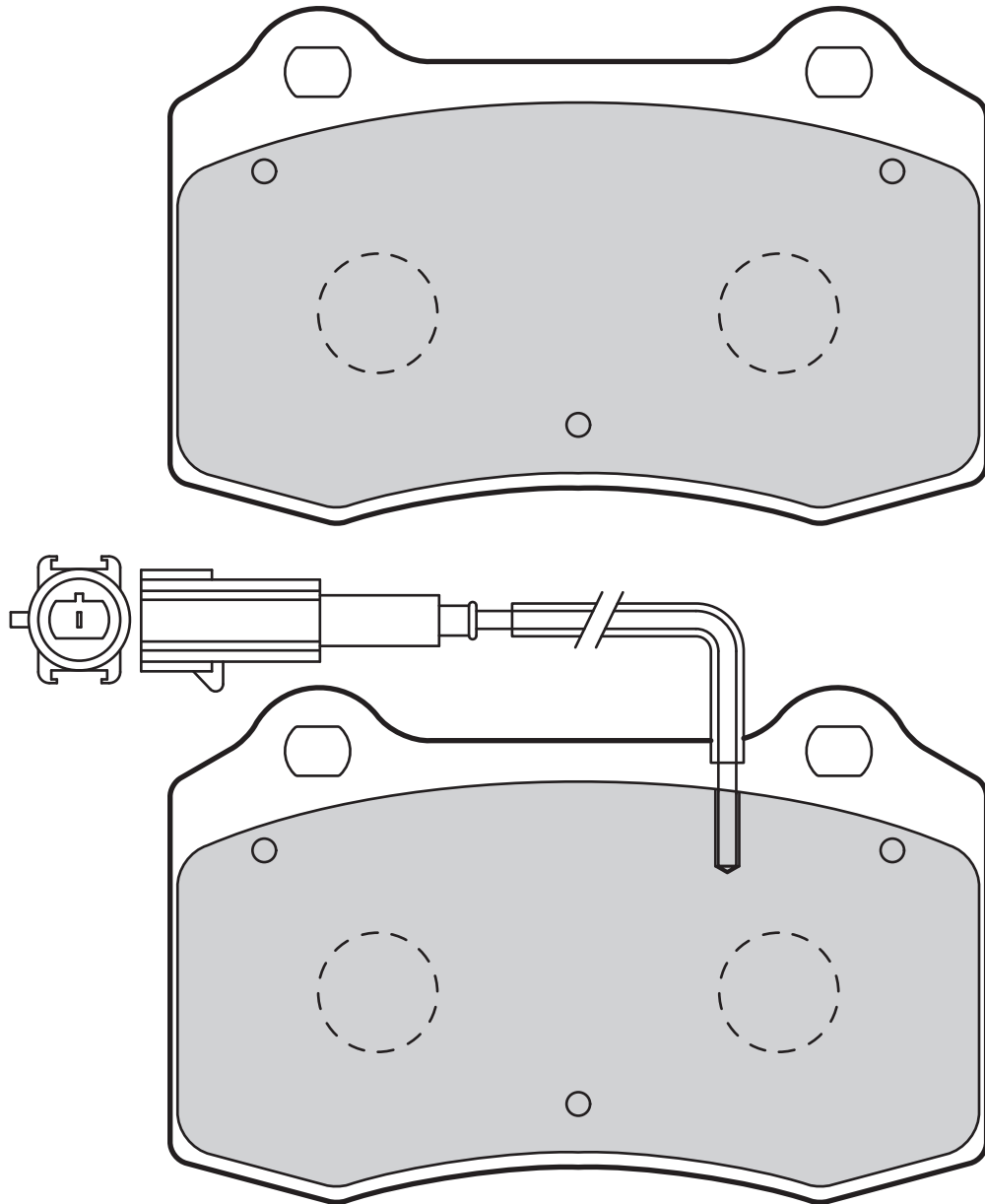

Valeo



Valeo



598466
598859
598988

4
1
2

370/290
330
305

109,7
109,6
109,6

69,3
69
69,1

17,8
14,7
17

BREMBO
BREMBO
BREMBO

PEUGEOT
LANCIA, SEAT
ALFA ROMEO, FIAT



21385 (WVA)

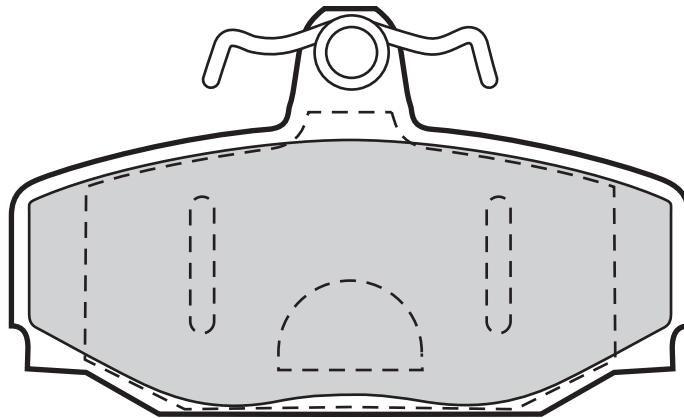

Valeo



0

Valeo



90



53,5



13,3



LUCAS



VOLVO



598621

21394 (WVA)

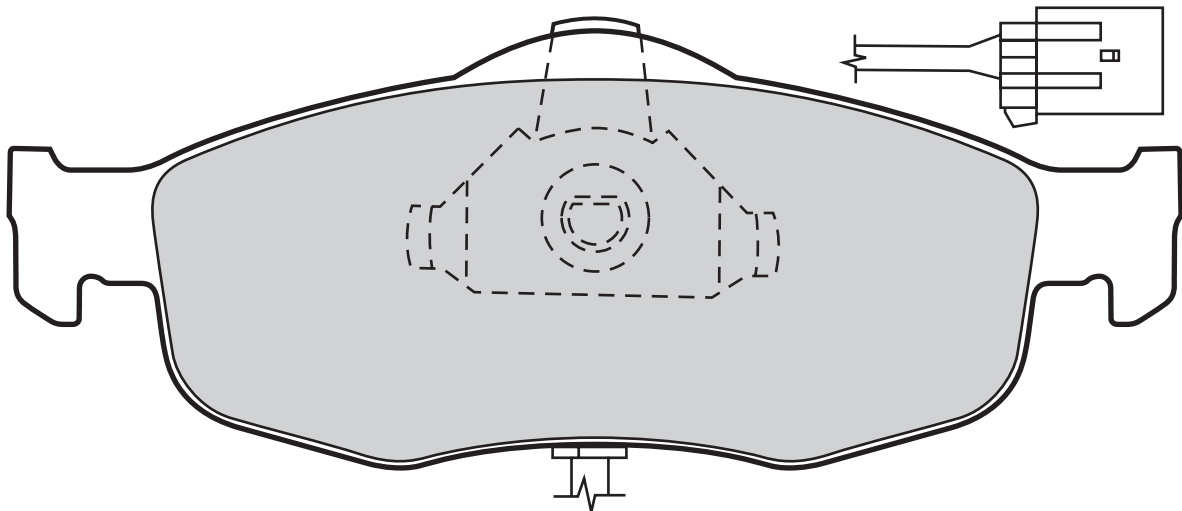

Valeo



2
0

Valeo



220



155,2



58,7



18



TEVES



FORD



598033

598034



21411 (WVA)

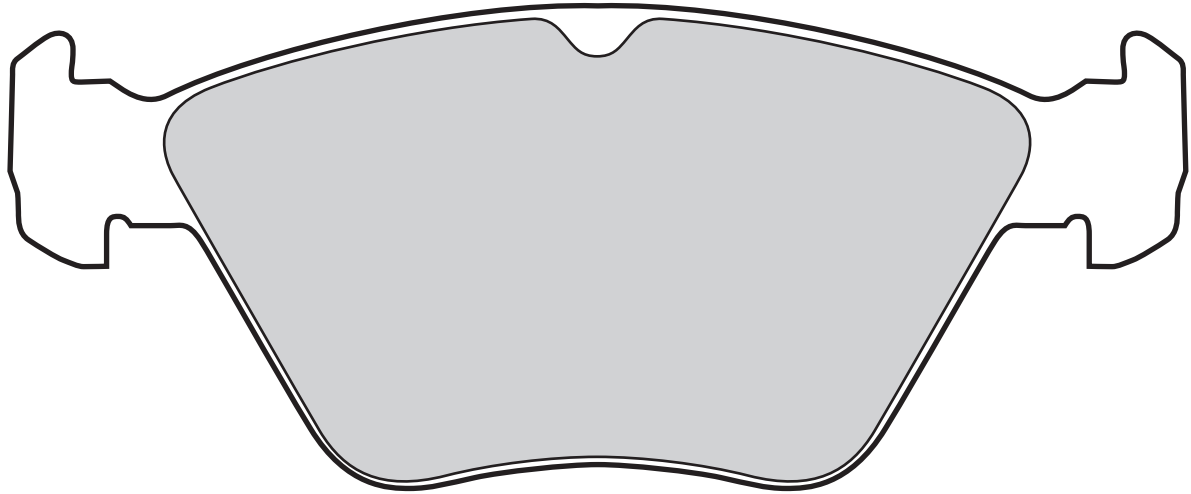
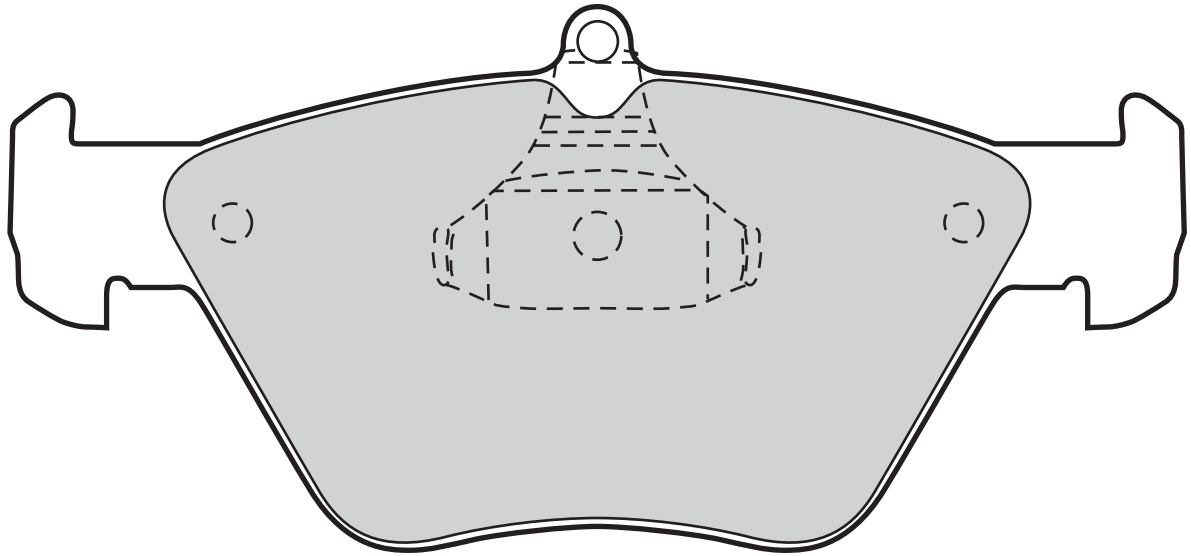

Valeo



Valeo



598050

0

156,3

70,7

18,3

TEVES

OPEL, SAAB, VAUXHALL



21430 (WVA)

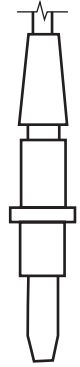
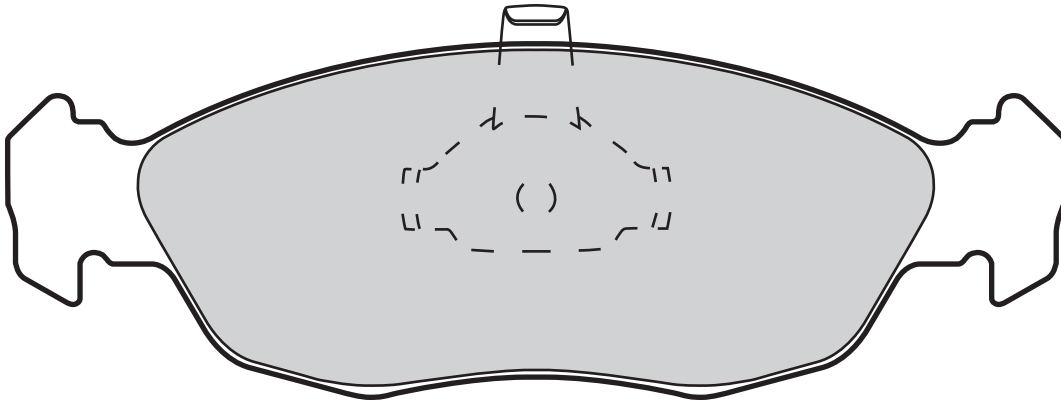

Valeo										
598038	2	275	140,3	47,5	17	TEVES	PEUGEOT			
598074	0		140,3	47,5	17	TEVES	CITROËN, PEUGEOT			

21436 (WVA)

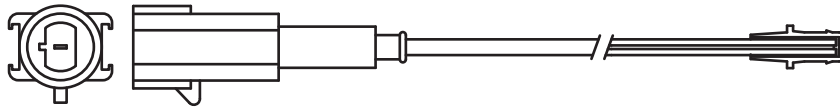
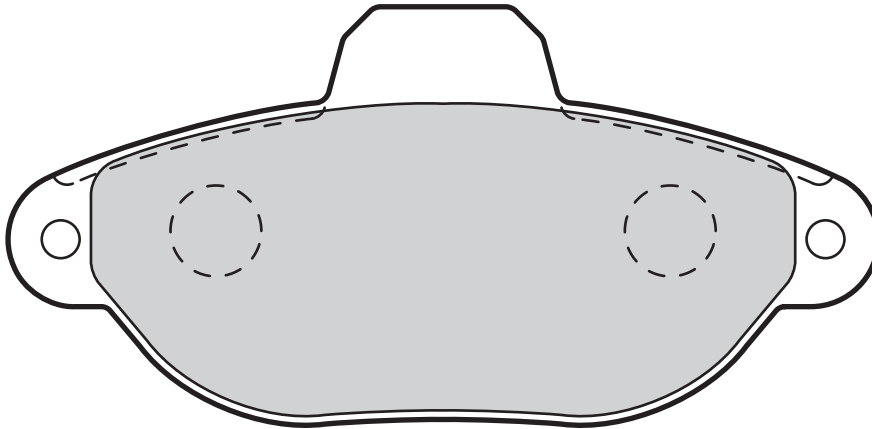

Valeo										
598987	1	210	114,9	55,2	17	BOSCH	FIAT, FORD			

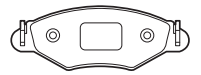

21439 (WVA)

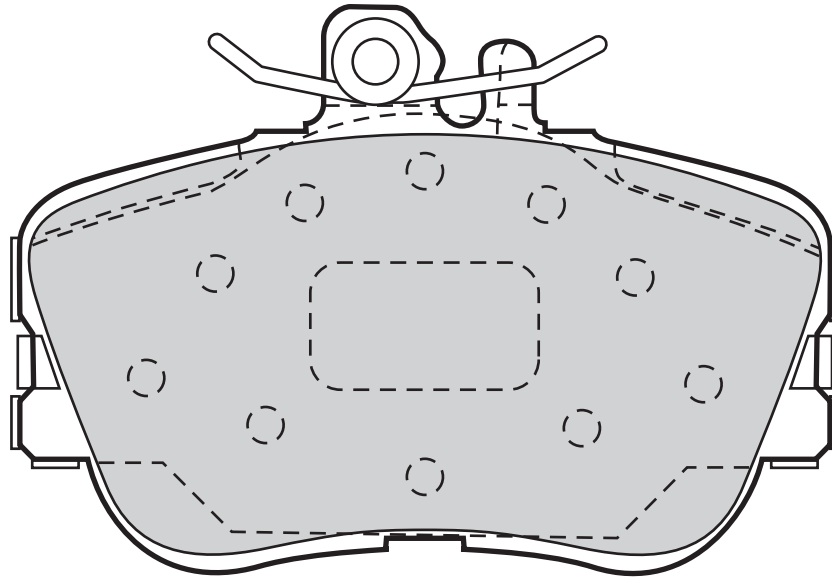

Valeo



0

Valeo



110



75



20,3



LUCAS



MERCEDES

598013

21468 (WVA)

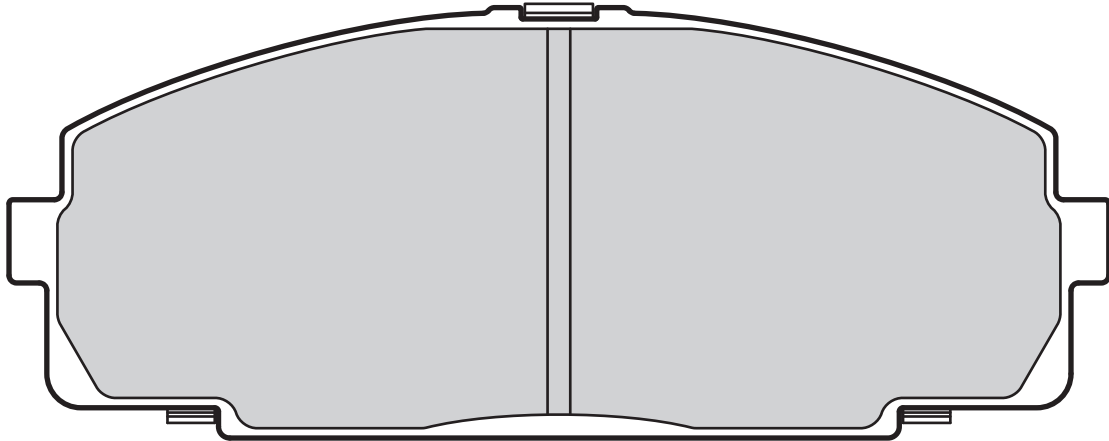

Valeo



0

Valeo



145



57



15



AKEBONO



TOYOTA

598947

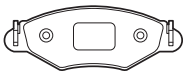

21469 (WVA)

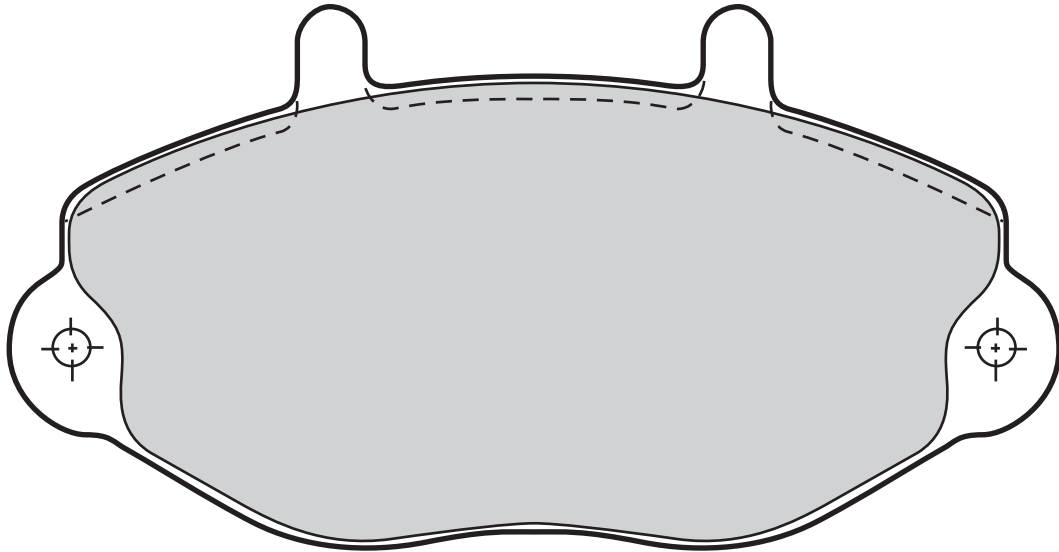

598037	0	138,9	72	18,3	BENDIX	FORD			

21470 (WVA)

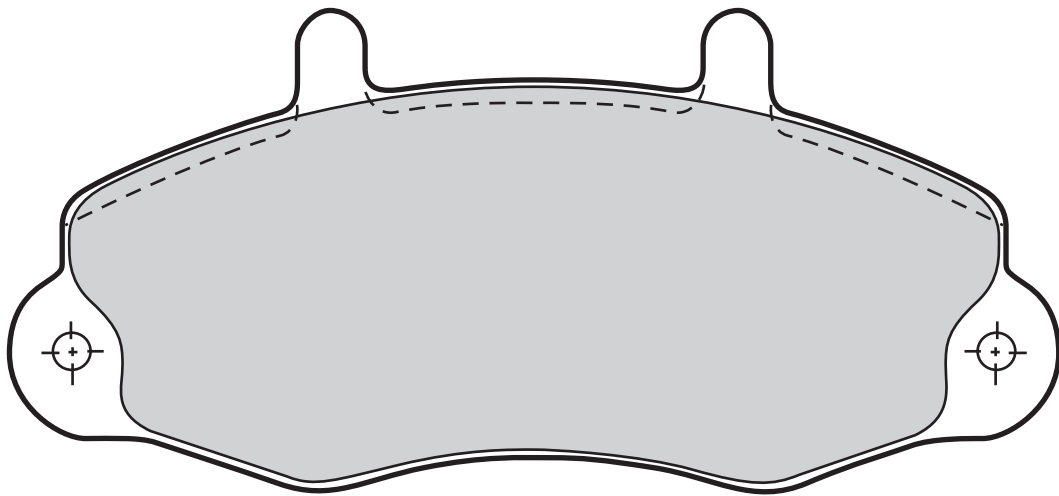

598036	0	138,9	64,1	18,3	BENDIX	FORD			



21479 (WVA)

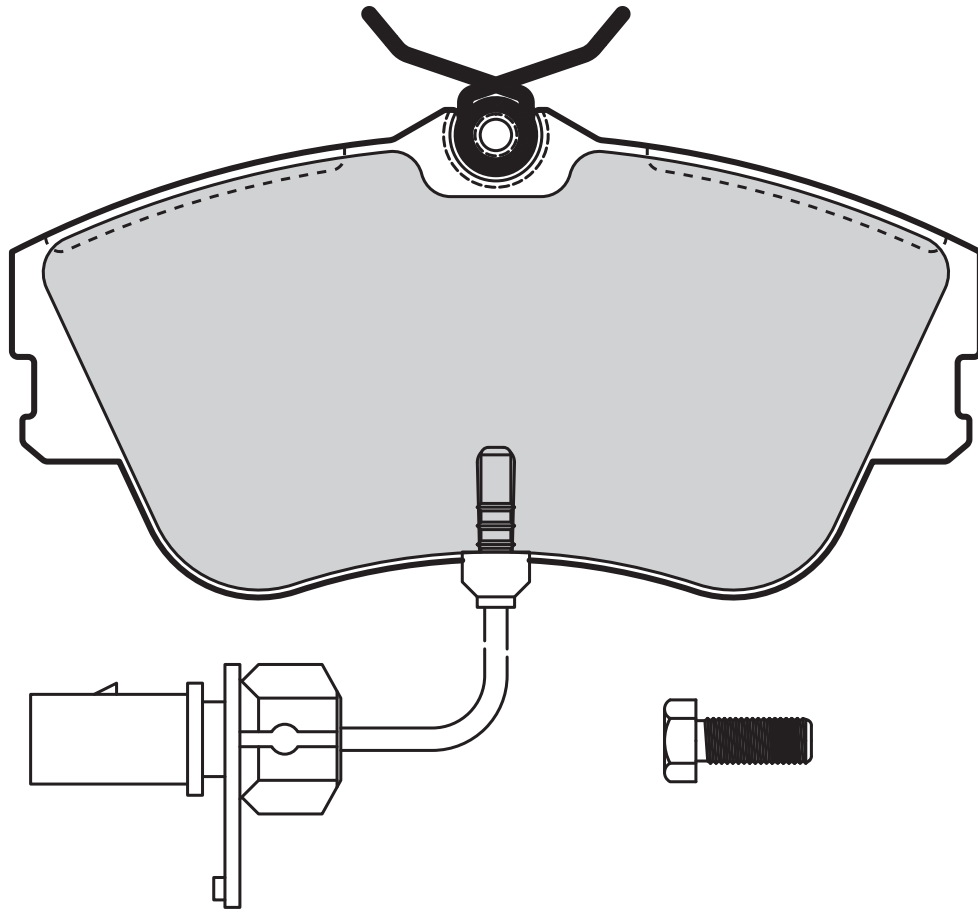

Valeo



Valeo



598622
598814

0
1

210

128
129,5

65
65,2

19,2
19,2

LUCAS
LUCAS

VOLKSWAGEN
VOLKSWAGEN

21481 (WVA)

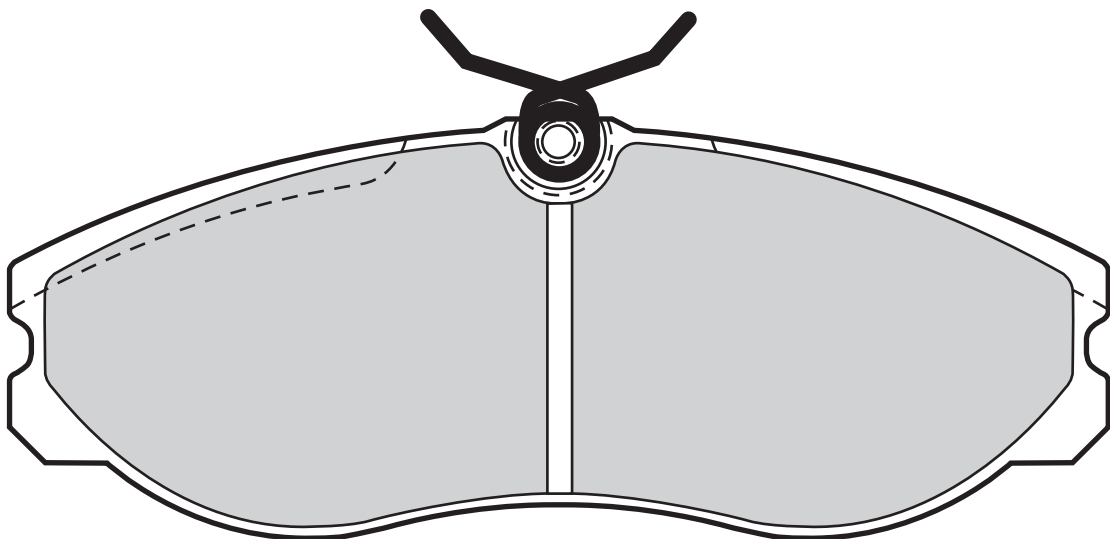

Valeo



Valeo



598602

0

144,8

55,5

15,5

LUCAS

FORD, NISSAN

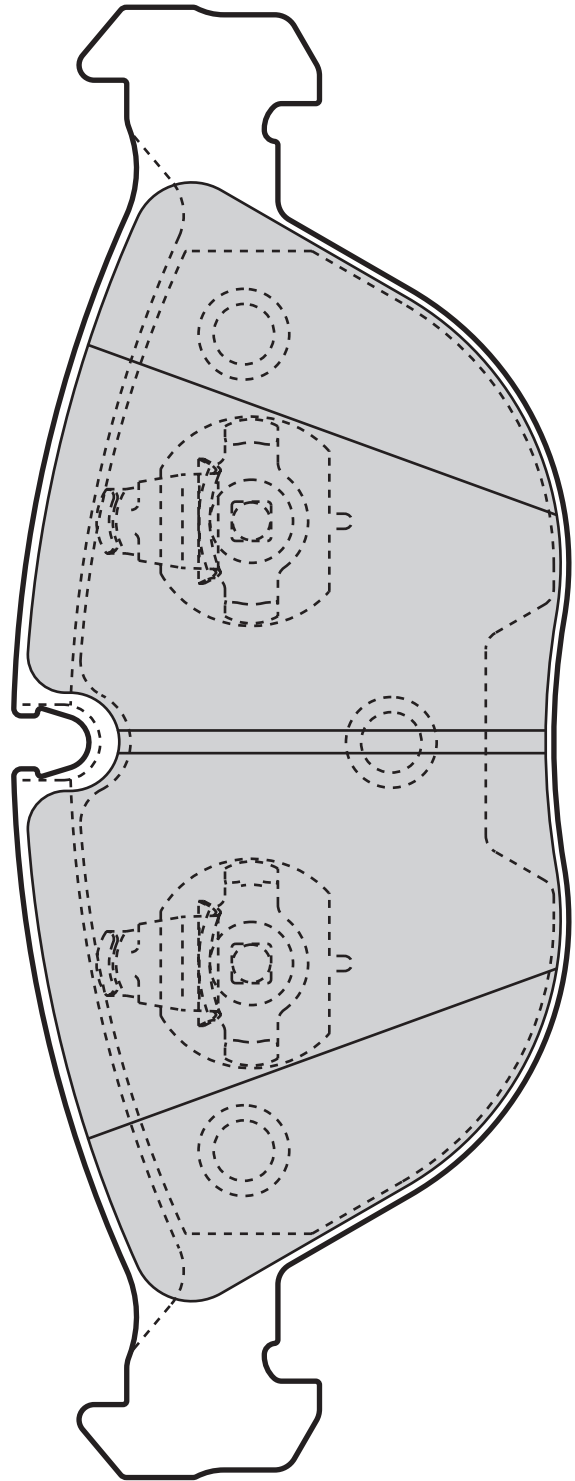
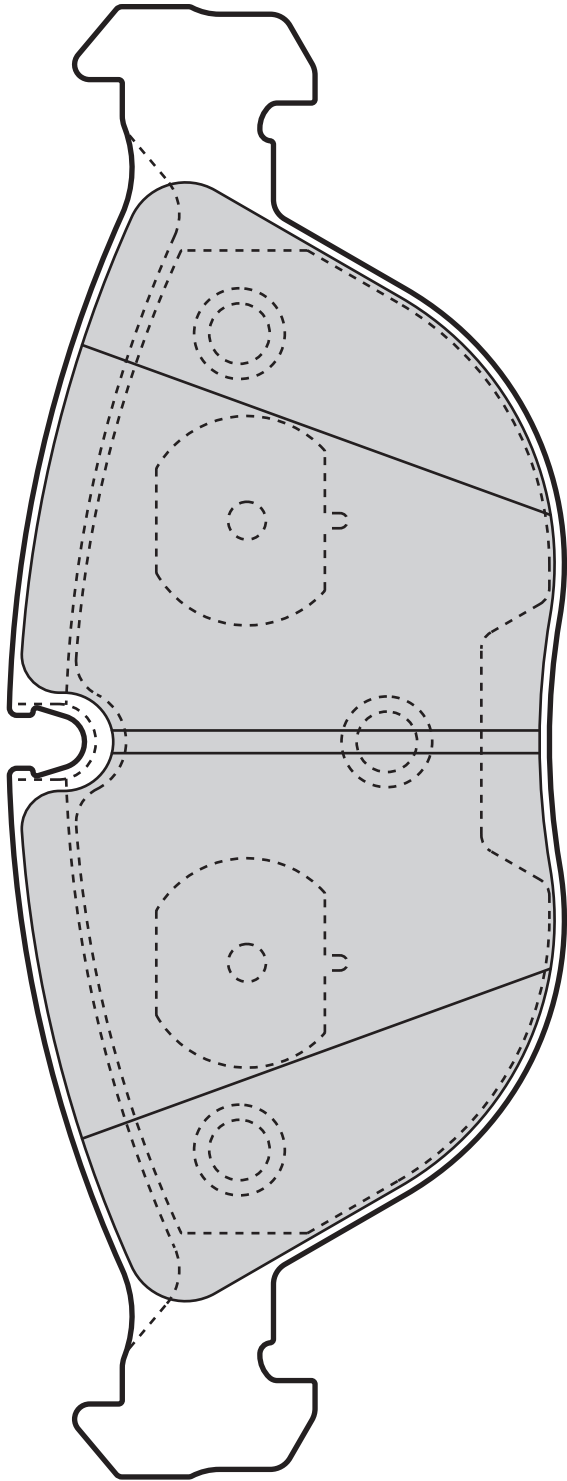
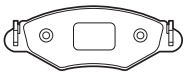

598712

1

194,5

73,5

20,5

TEVES

AUDI, BMW, MERCEDES, VOLKSWAGEN



21487 (WVA)

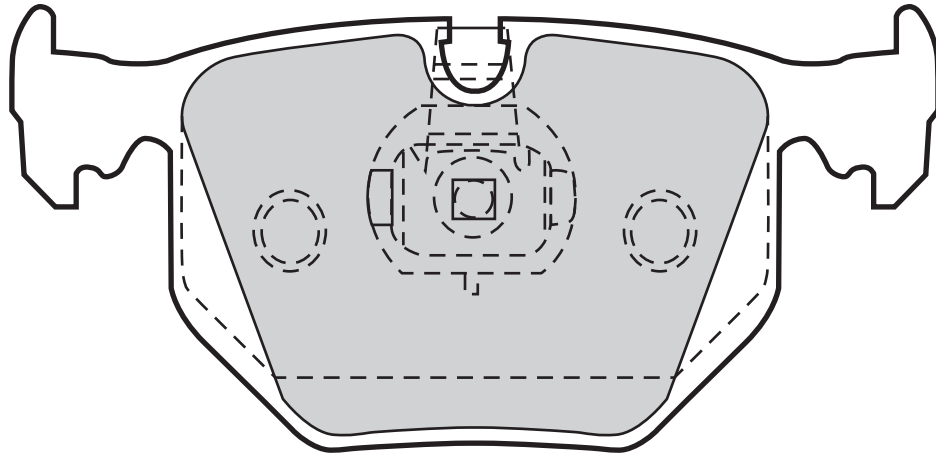

Valeo



Valeo



598580

0

123,1

59,2

17

TEVES

BMW, LAND ROVER

21490 (WVA)

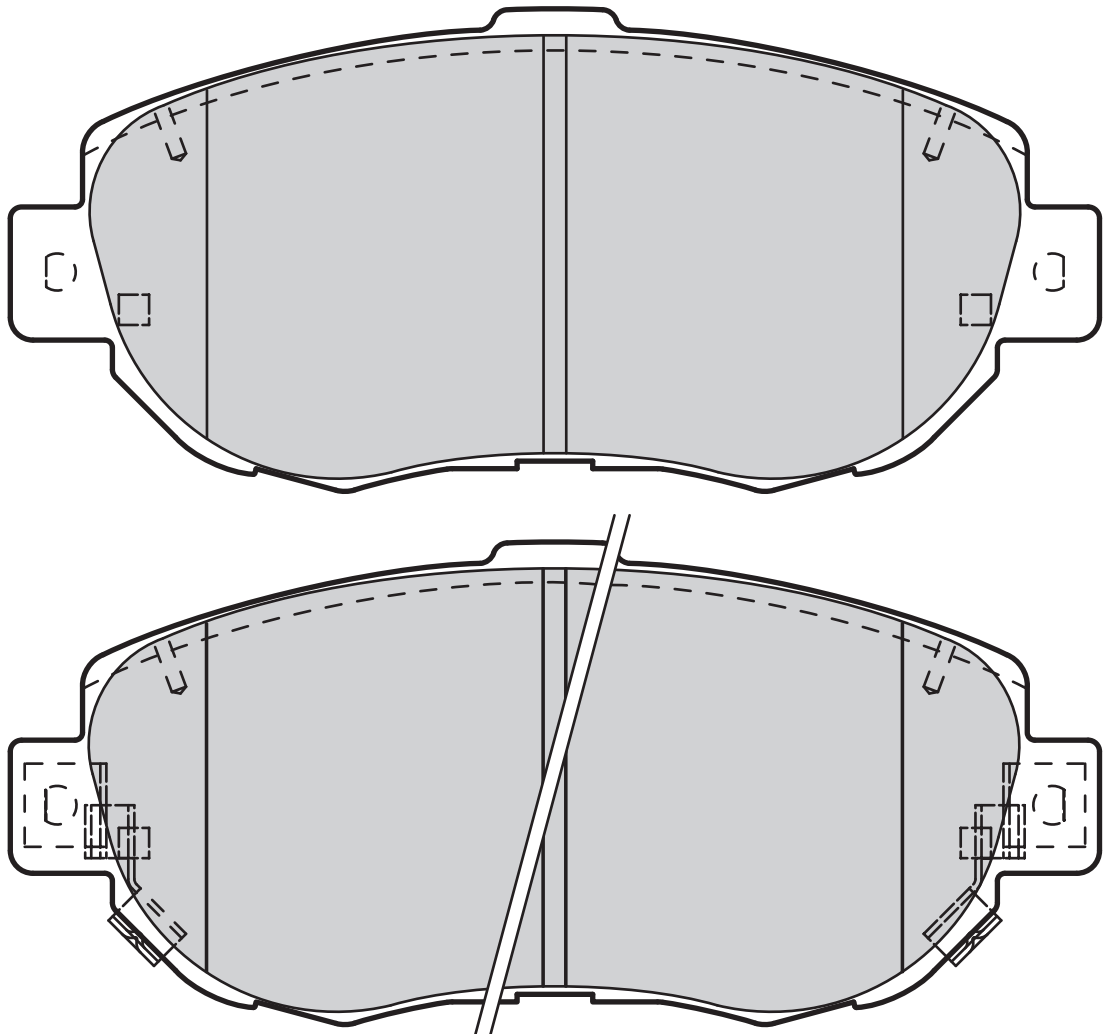

Valeo



Valeo



601023

2

Leaf

144

63,8

17

SUMITOMO

LEXUS, TOYOTA



21495 (WVA)

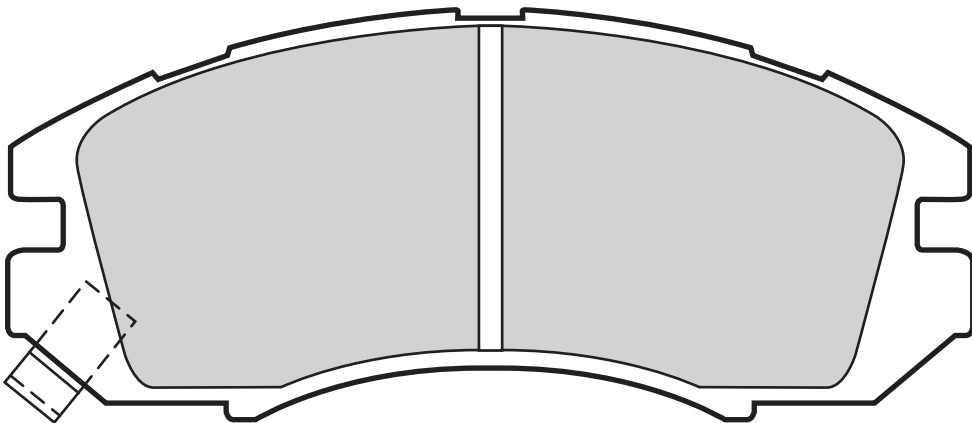
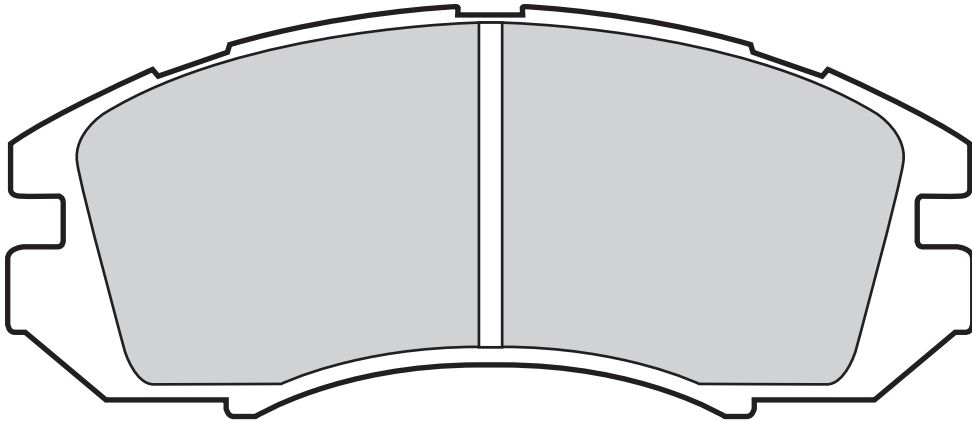

Valeo



2

Valeo



127,4

54,3



17



SUMITOMO



SUBARU

598691

21497 (WVA)

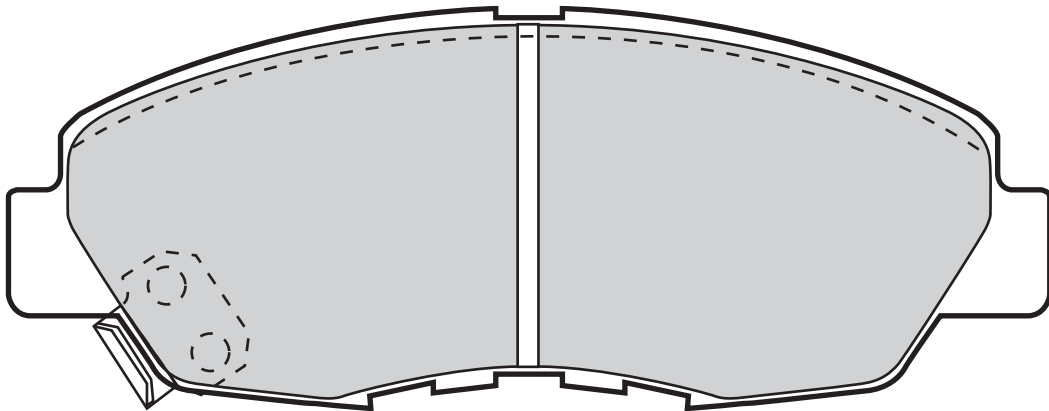

Valeo



2

Valeo



137,7

52,5



18



AKEBONO



HONDA

598788

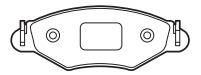

21500 (WVA)

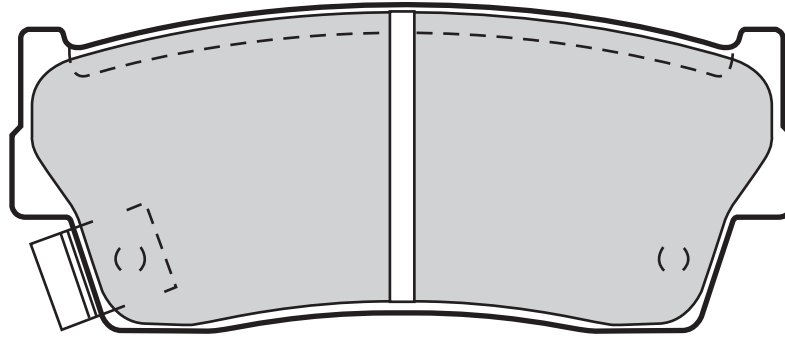

Valeo



2

Valeo



103,5



43,8



15,3



AKEBONO



SANTANA, SUZUKI

598023

21507 (WVA)

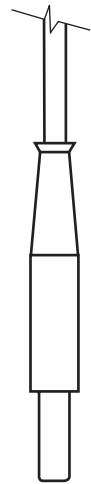
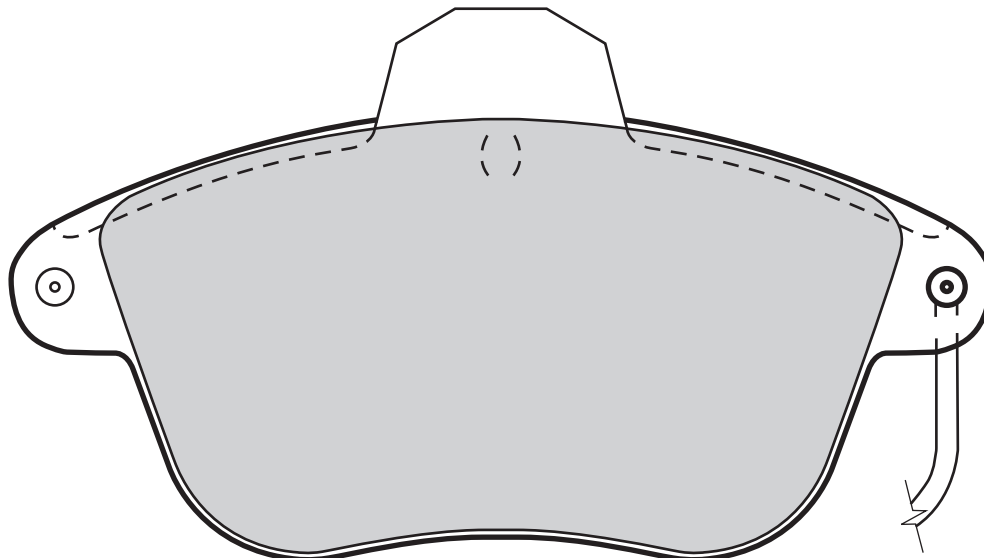

Valeo



4
4

Valeo



340/120
340/120



131
131



73
73



17
17



BENDIX
BENDIX



CITROËN
PEUGEOT

598028
598280

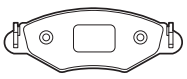

21515 (WVA)

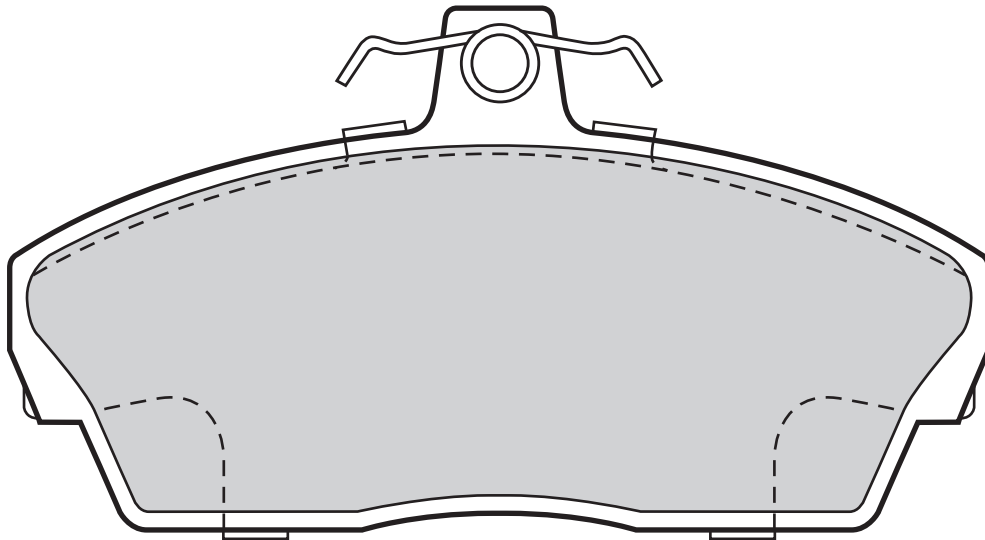
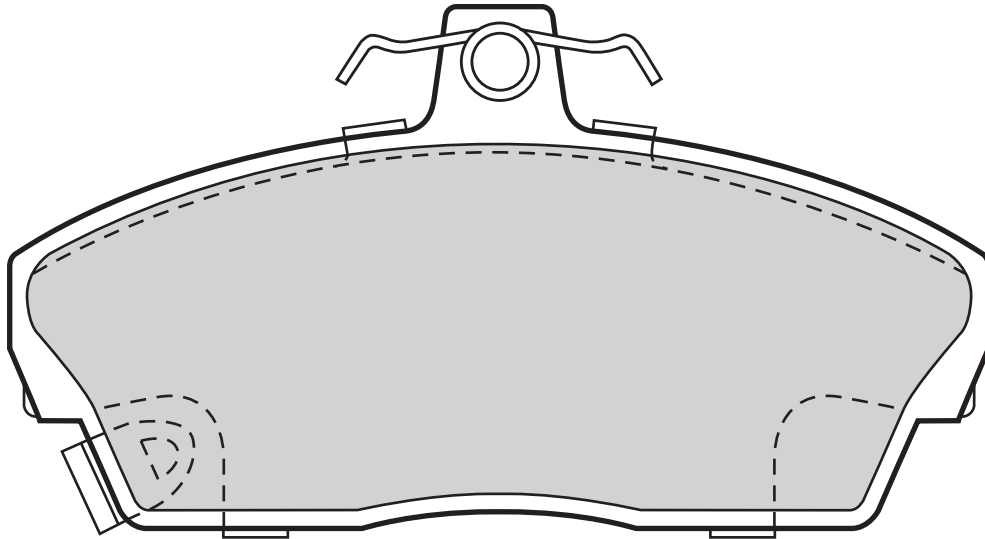

Valeo



Valeo



598022
598512

2
0

129
129

69
68,6

18
18

LUCAS
LUCAS

HONDA, MG, ROVER
LAND ROVER

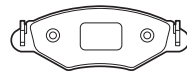

21518 (WVA)

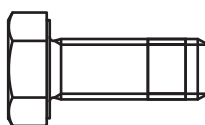
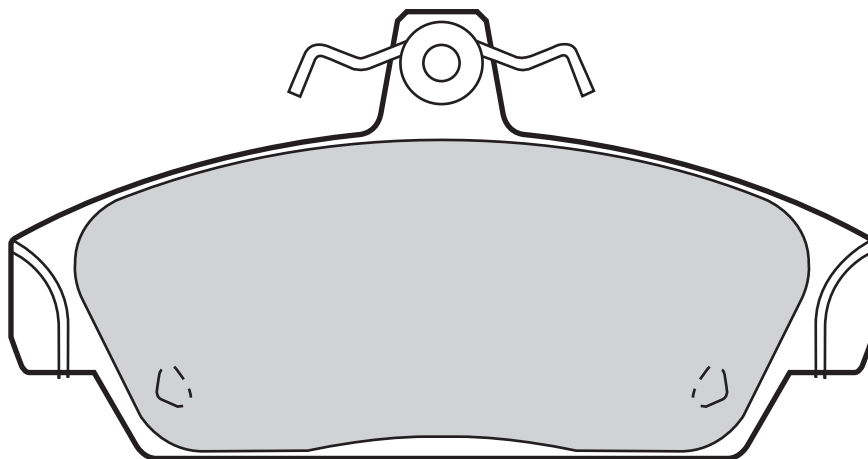

598254

0

114,9

60

17,3

LUCAS

MG, ROVER

21519 (WVA)

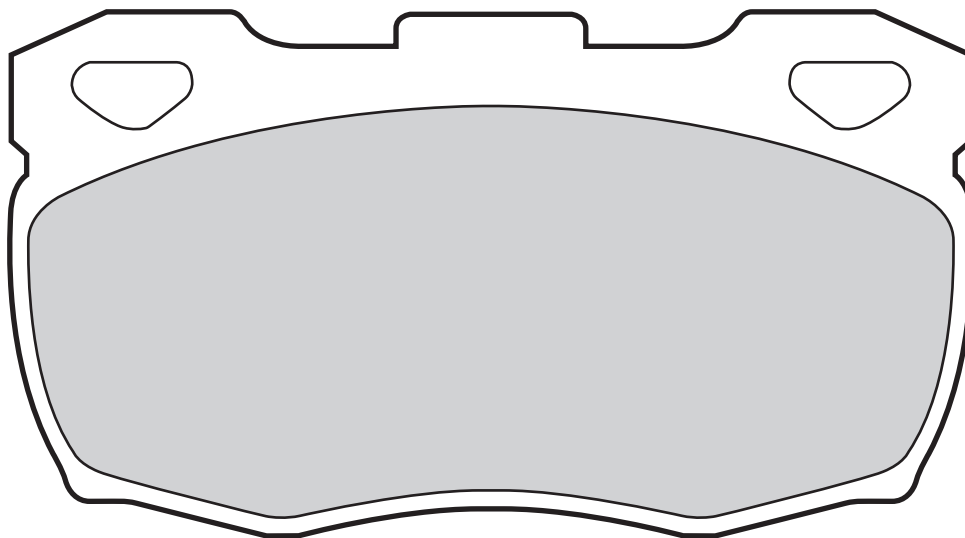

598623

0

127

68,6

18

AP

LAND ROVER



21539 (WVA)

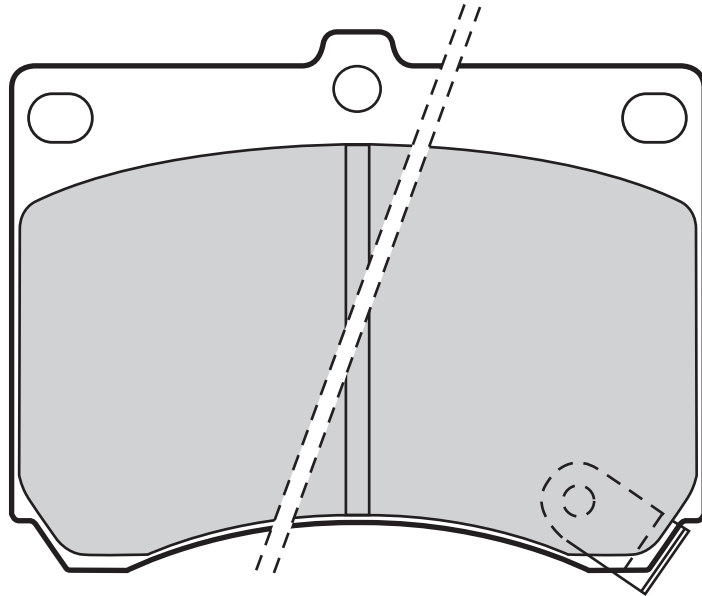

Valeo



2

Valeo



91,7



71



15



SUMITOMO



MAZDA

598646

21543 (WVA)

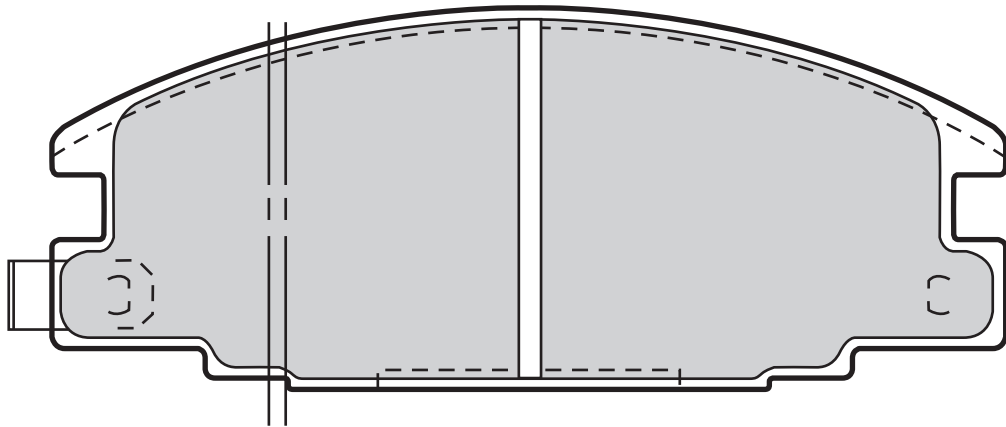

Valeo



4

Valeo



127



51



16,5



AKEBONO



BEDFORD, ISUZU, OPEL, VAUXHALL

598020



21545 (WVA)

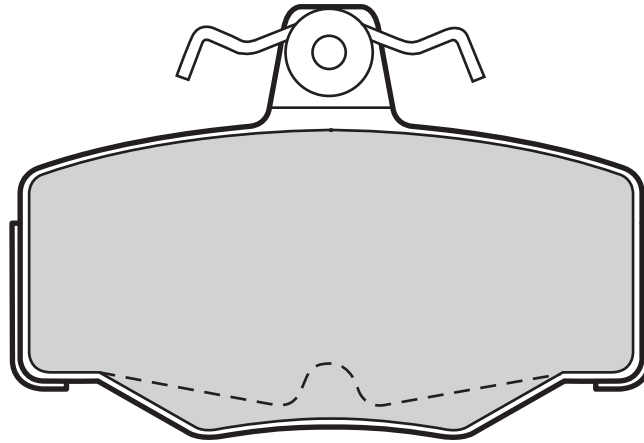

598057

0

84

56,3

15,8

LUCAS

NISSAN

21546 (WVA)

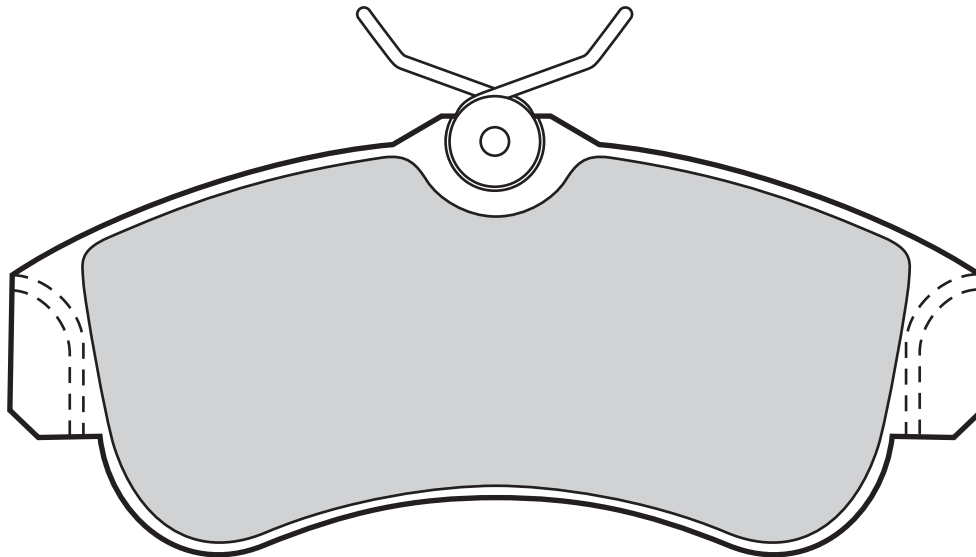

598054

0

129

57,3

17

LUCAS

NISSAN



21553 (WVA)

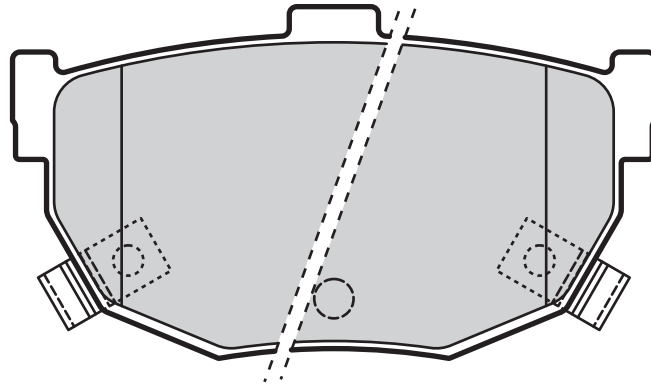

Valeo



2

Valeo



85



46,5



14



SUMITOMO



HYUNDAI, KIA, NISSAN

598817

21558 (WVA)

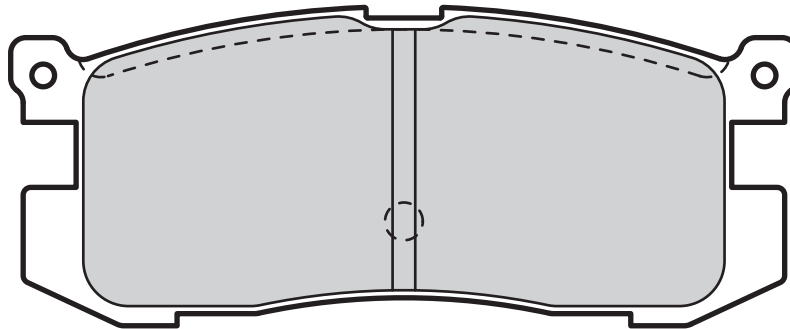

Valeo



0

Valeo



104



42,2



13



SUMITOMO



FORD, MAZDA

598846

21561 (WVA)

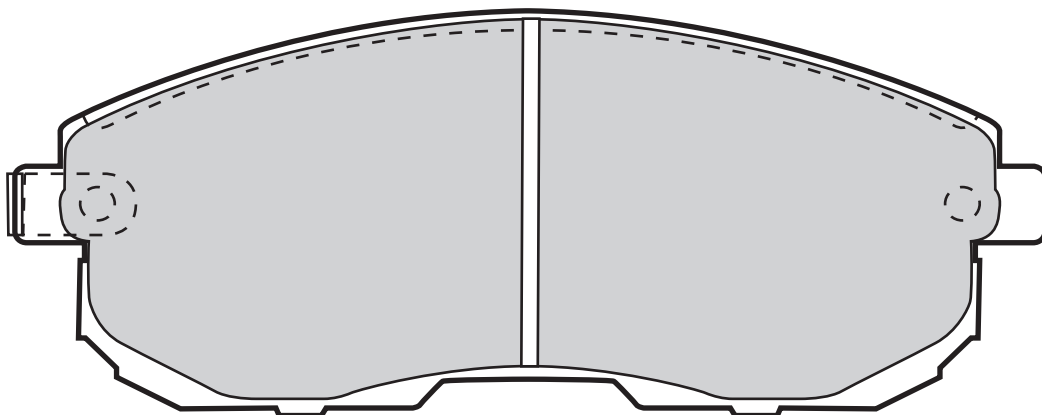

Valeo



2

Valeo



137,2



53



17



TOKICO



NISSAN

598787



Valeo

21573 (WVA)

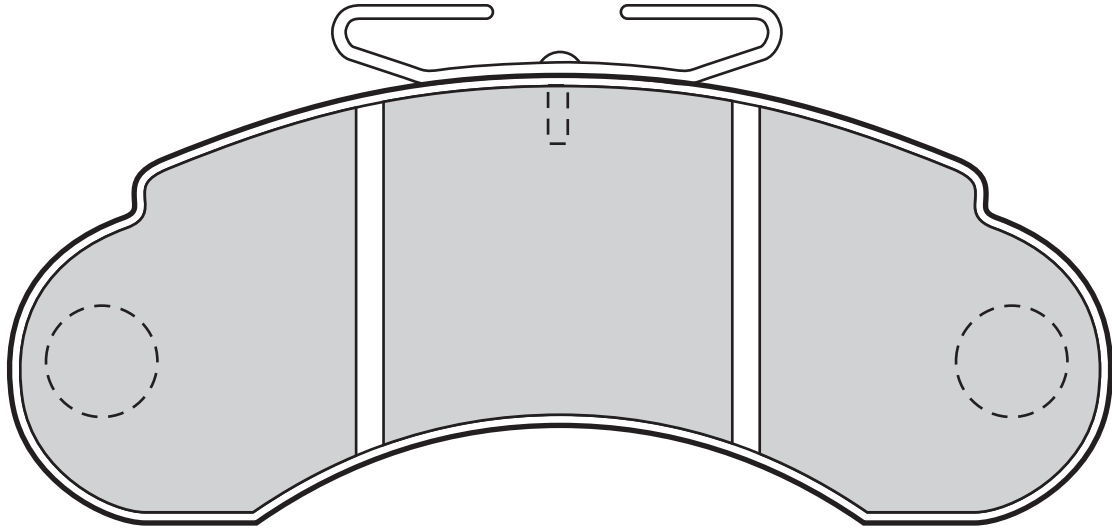

598000	0	145,4	60	14	BENDIX	MERCEDES		

21574 (WVA)

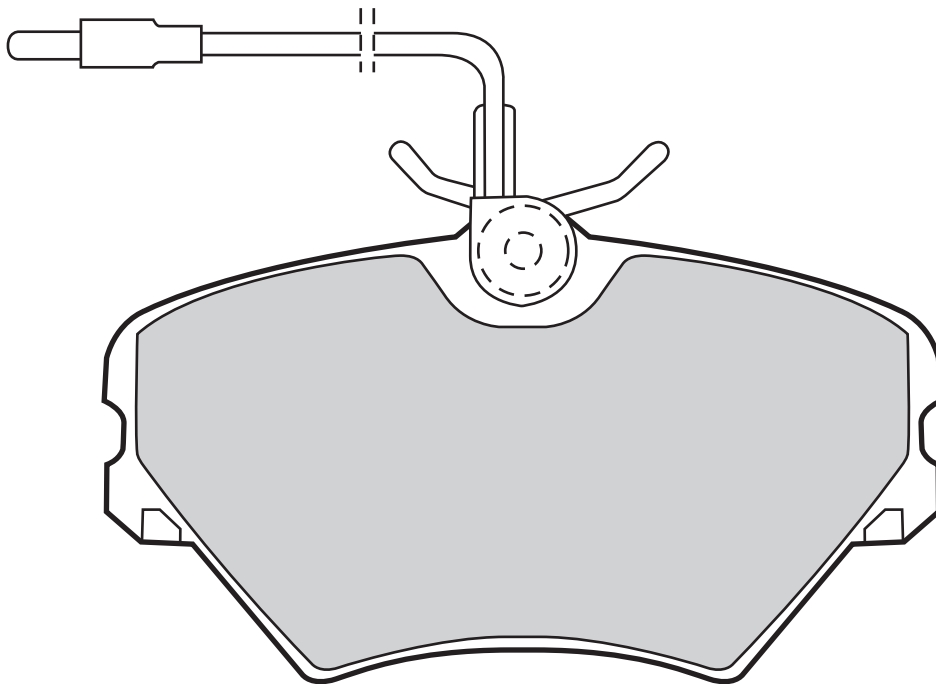

598599	2	280	111	61	18,3	LUCAS	RENAULT

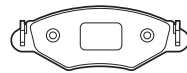

21576 (WVA)

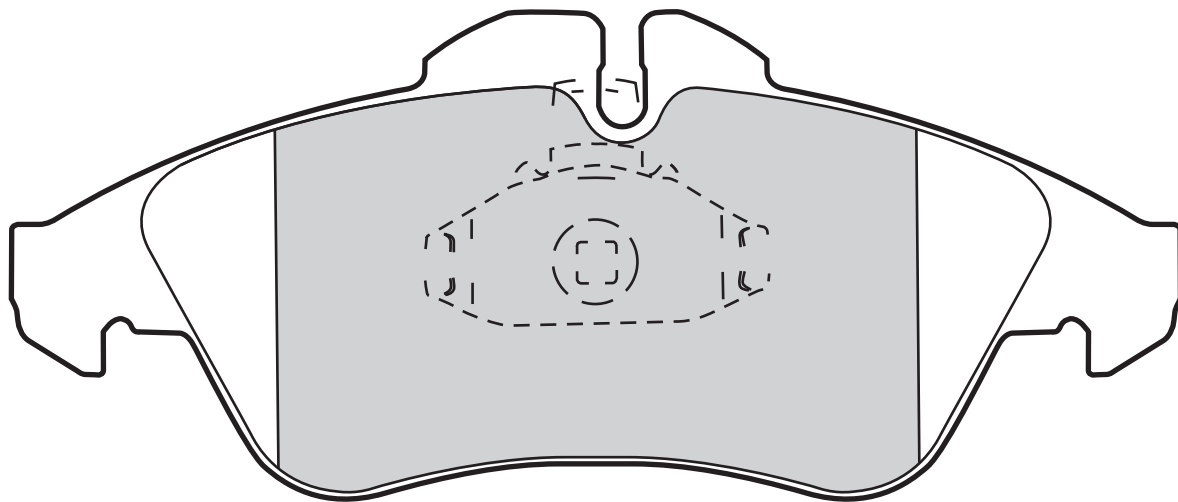

Valeo



Valeo



598044

0

156,3

64,8

20,5

TEVES

MERCEDES, VOLKSWAGEN



21580 (WVA)

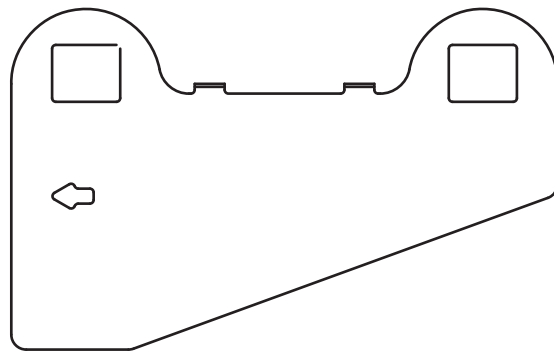
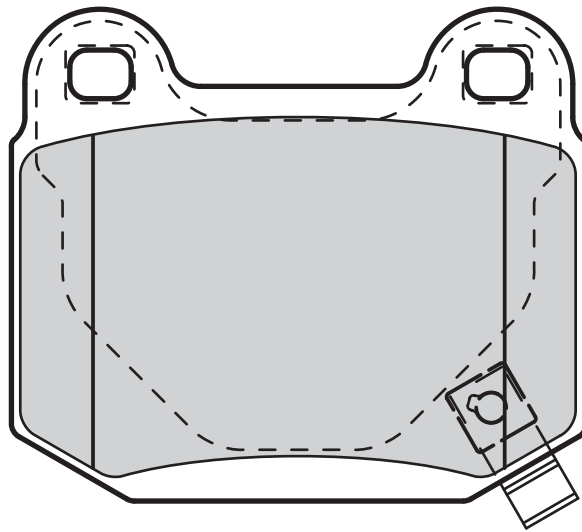
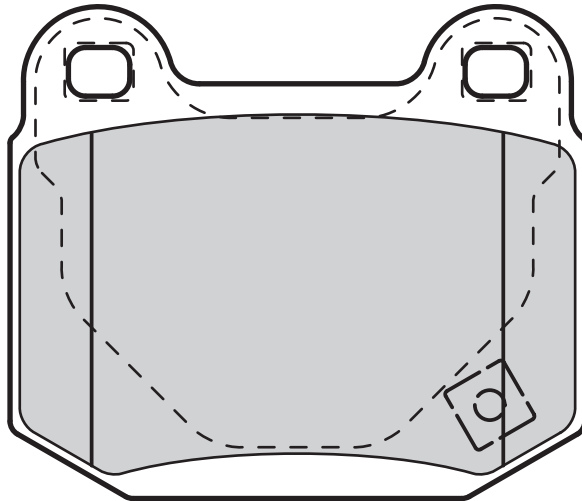

Valeo



Valeo



598914

2

Leaf

76,5

65,5

14,6

BREMBO

mitsubishi, nissan, subaru

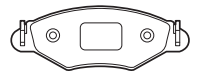

21586 (WVA)

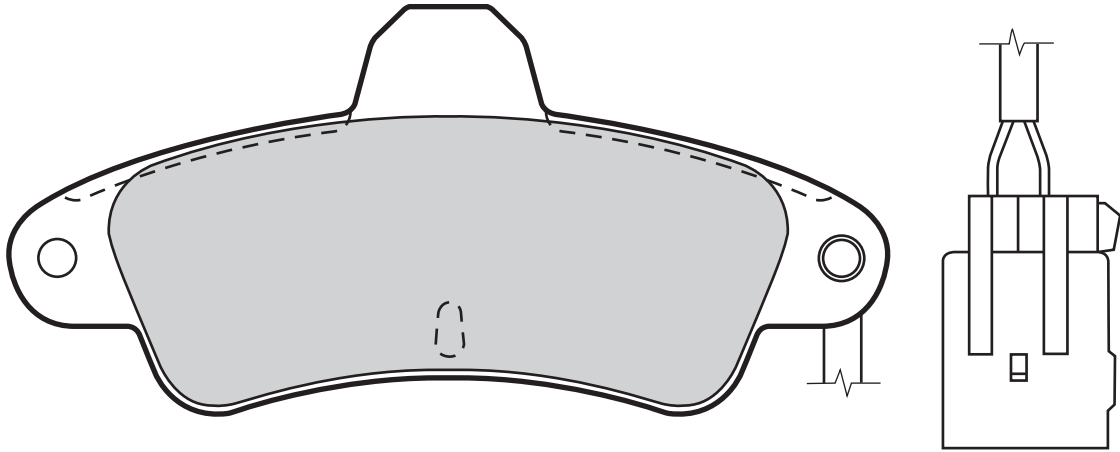

Valeo



2

Valeo



116



54



15



BENDIX



FORD

598035

21601 (WVA)

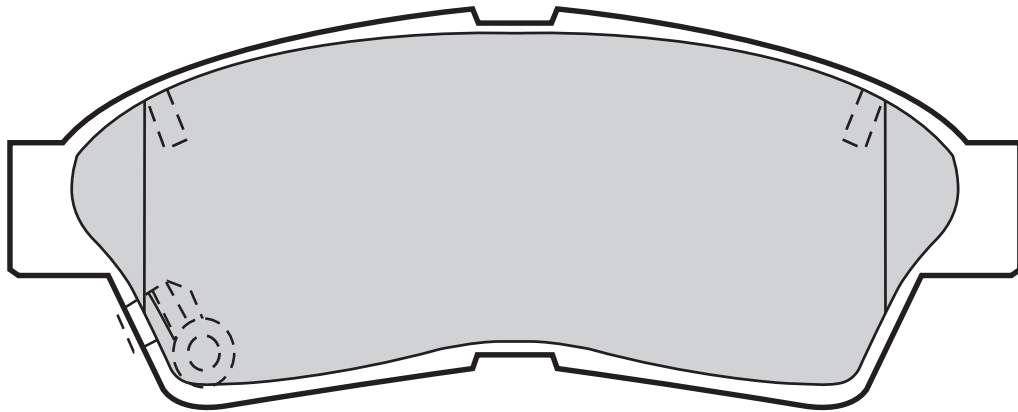

Valeo



2

Valeo



133,2



53



17,5



AKEBONO



TOYOTA

598551



21606 (WVA)

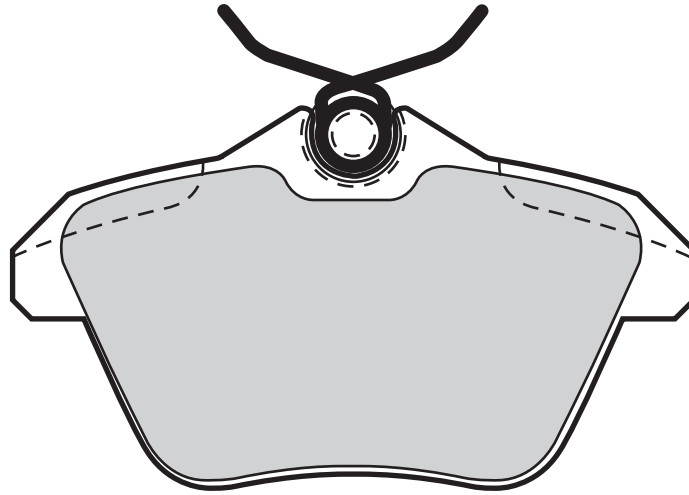

598581	0		89,8	50	16,4		LUCAS		ALFA ROMEO, LANCIA

21621 (WVA)

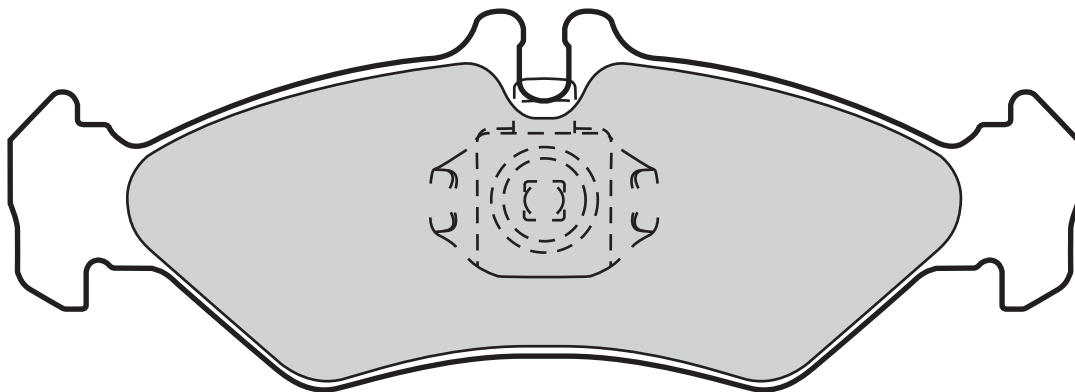

598045	0		141,5	50	16,8		TEVES		MERCEDES, VOLKSWAGEN

21626 (WVA)

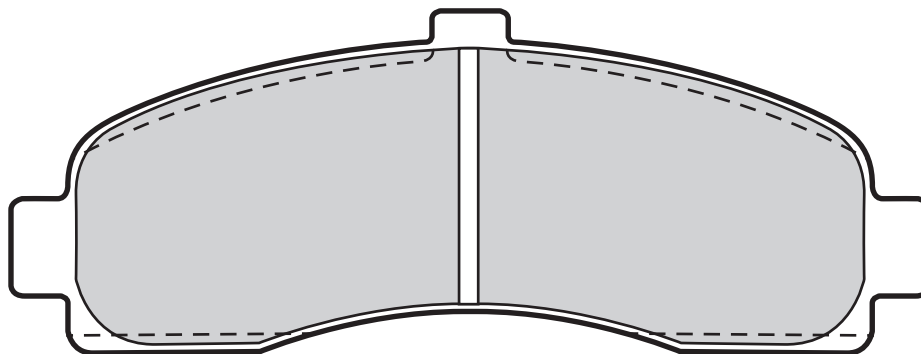

598014	0		120,9	45	15,5		AKEBONO		NISSAN



21631 (WVA)

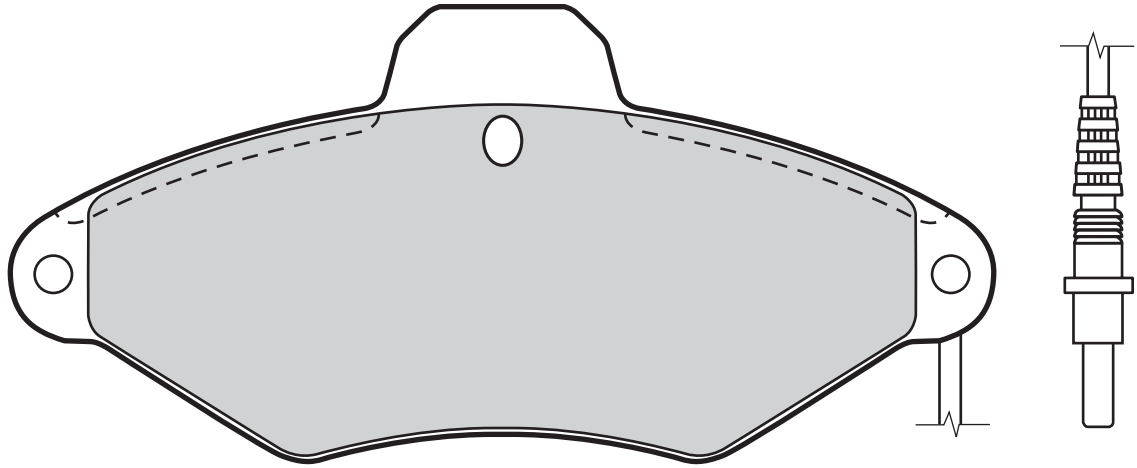

Valeo



Valeo



598031

4

365/150

131

60,5

16

BENDIX

CITROËN

21632 (WVA)

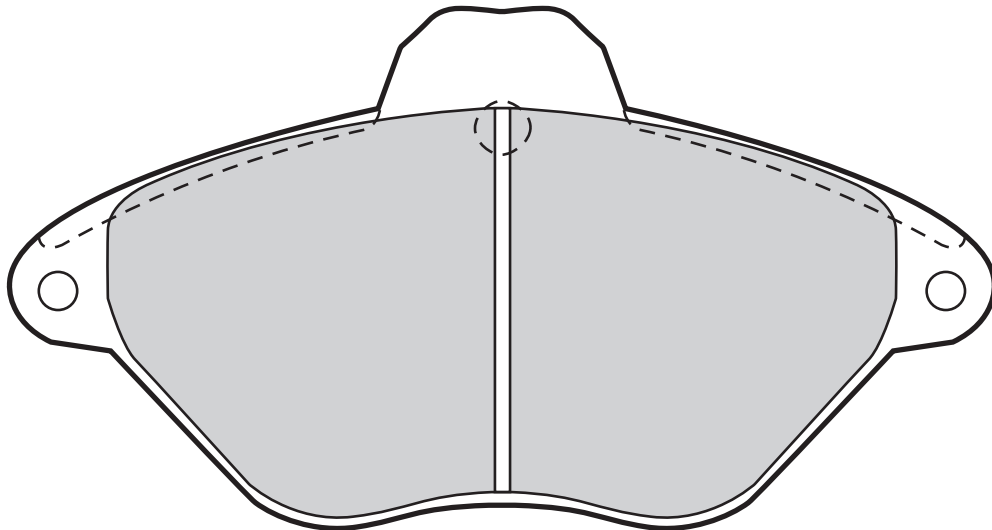

Valeo



Valeo



598383

4

365/150

131

69

16

BENDIX

CITROËN

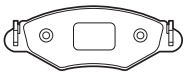

21636 (WVA)

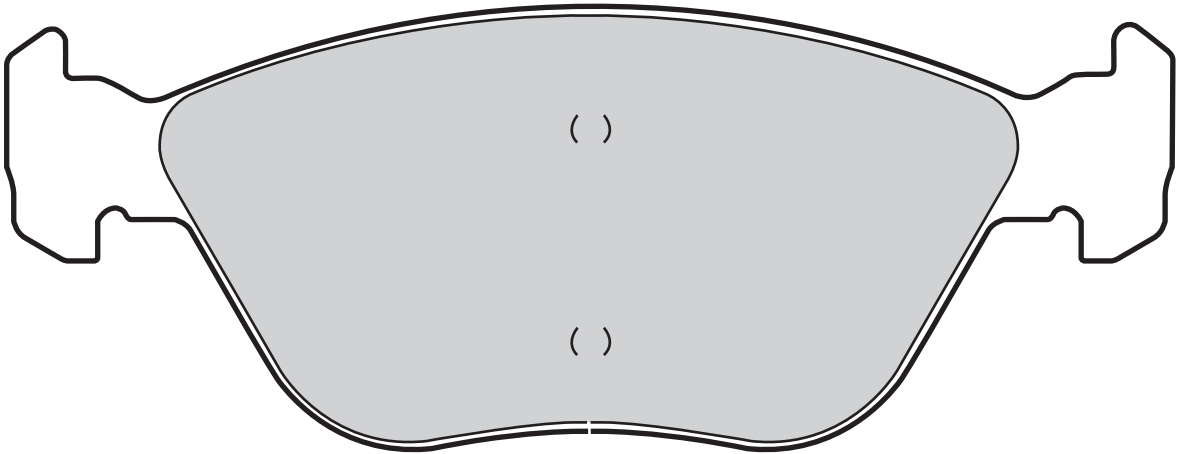
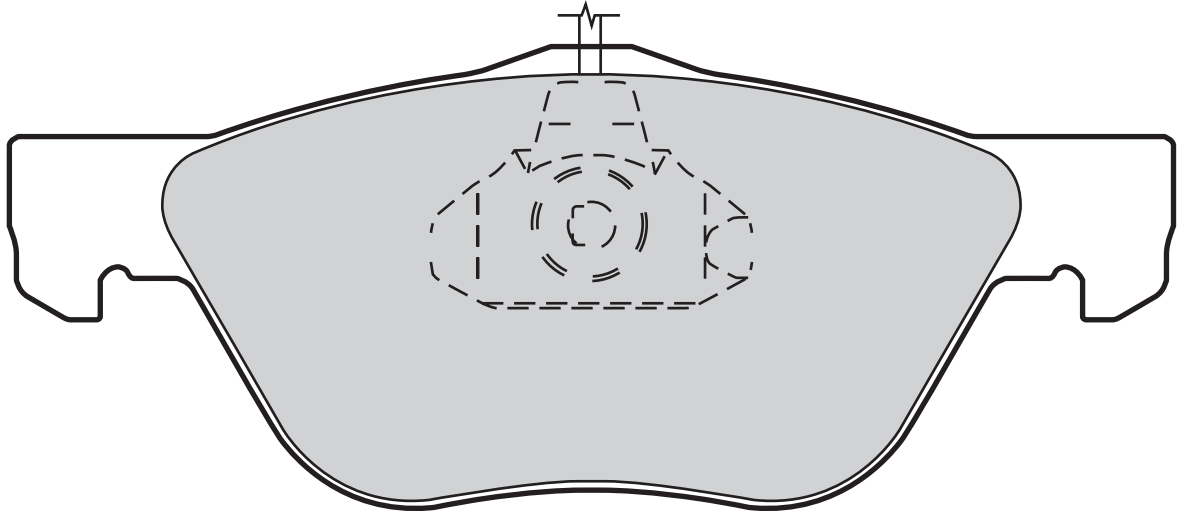

Valeo



Valeo



598065
598308

2
2

200
216

155,3
156,3

58,9
61,7

19
19

TEVES
TEVES

ALFA ROMEO, FIAT, LANCIA
ALFA ROMEO, FIAT, LANCIA

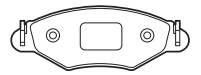

21637 (WVA)

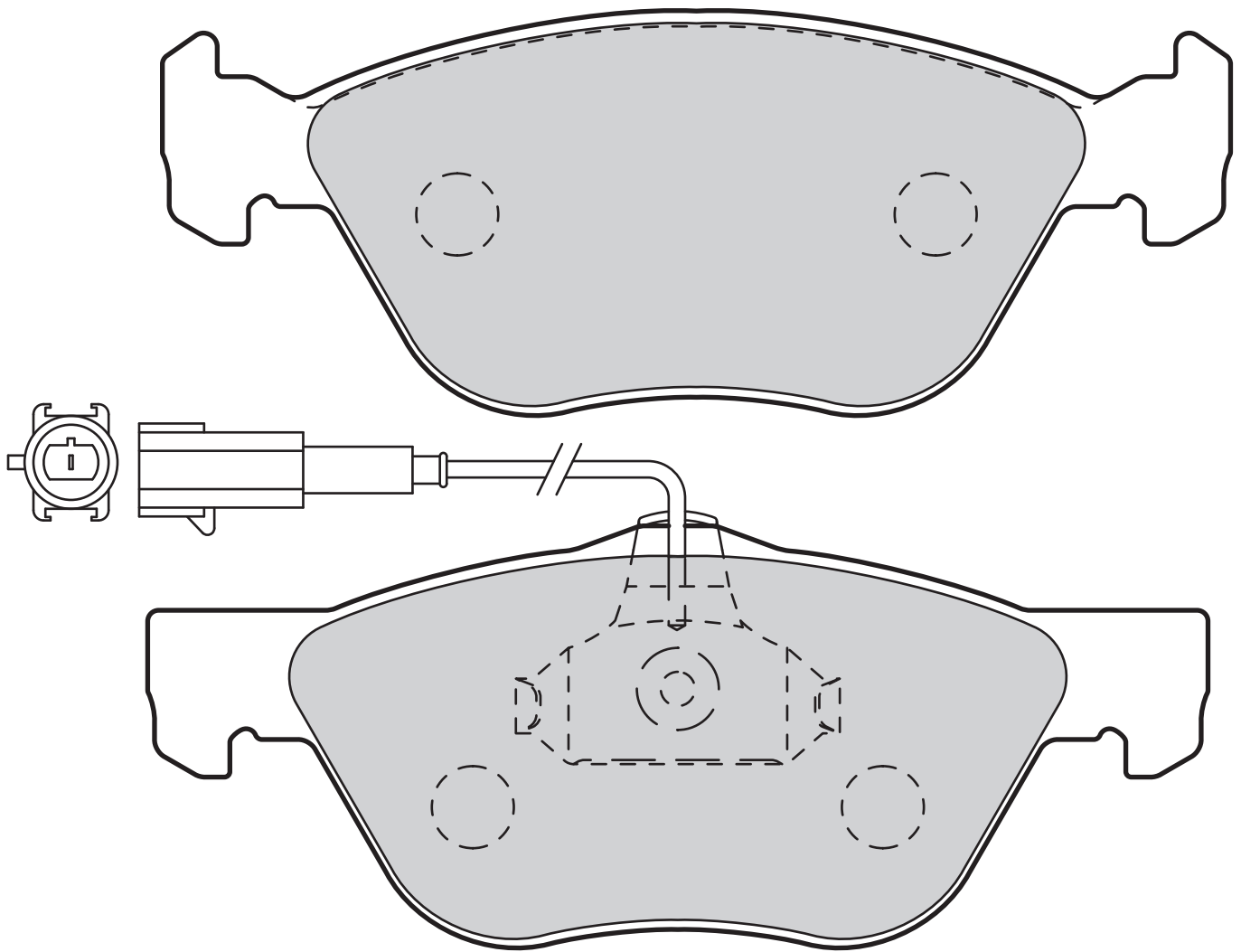

Valeo



Valeo



598990

1

215

155,2

61,9

19,3

TEVES

ALFA ROMEO, FIAT, LANCIA

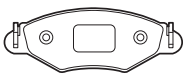

21647 (WVA)

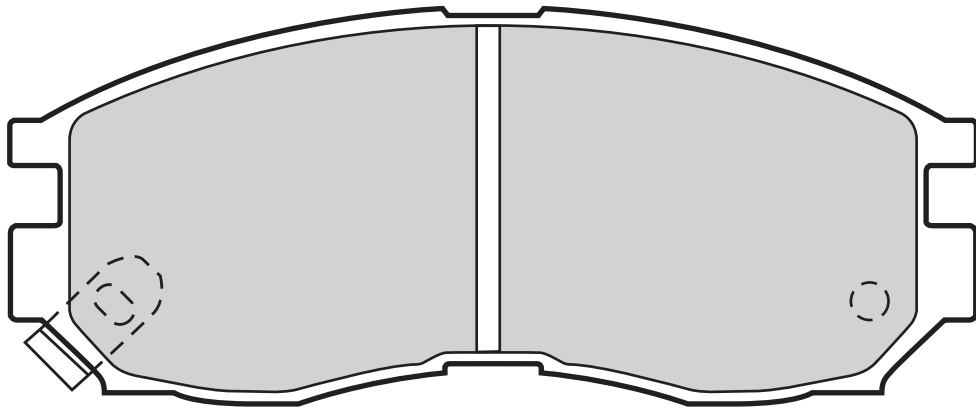
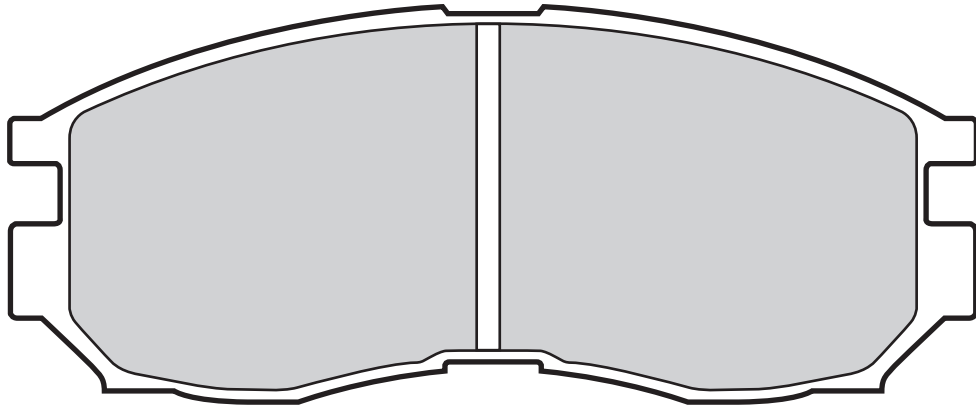

598625	0	127,7	51,7	16	SUMITOMO	GALLOPER, HYUNDAI, MITSUBISHI, PROTON		

21650 (WVA)

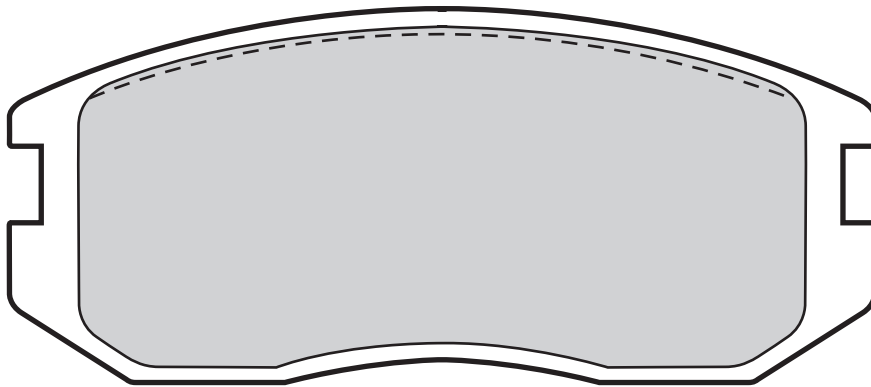

598626	0	114,1	49,9	15	SUMITOMO	MITSUBISHI, PROTON		



21651 (WVA)

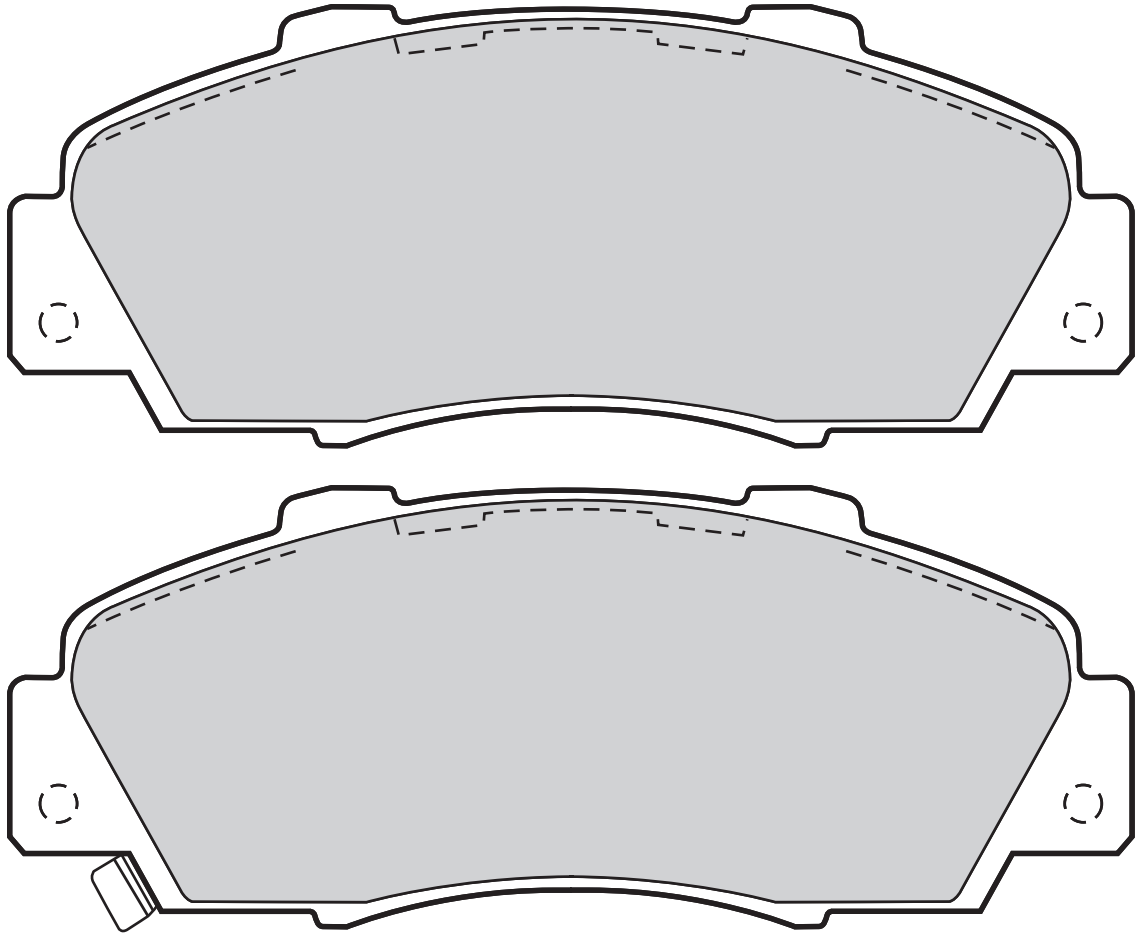

Valeo



Valeo



598627

0

148,6

57,7

17,5

AKEBONO

HONDA, ROVER

21654 (WVA)

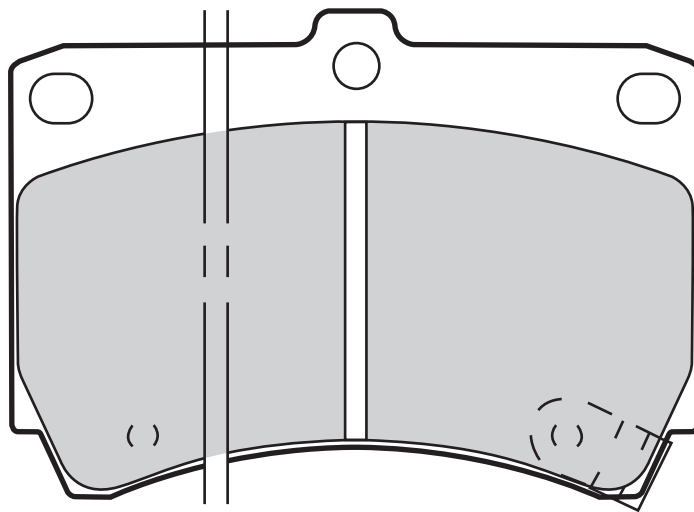

Valeo



Valeo



598274

2

91,5

64

15

SUMITOMO

KIA, MAZDA



Valeo

21655 (WVA)

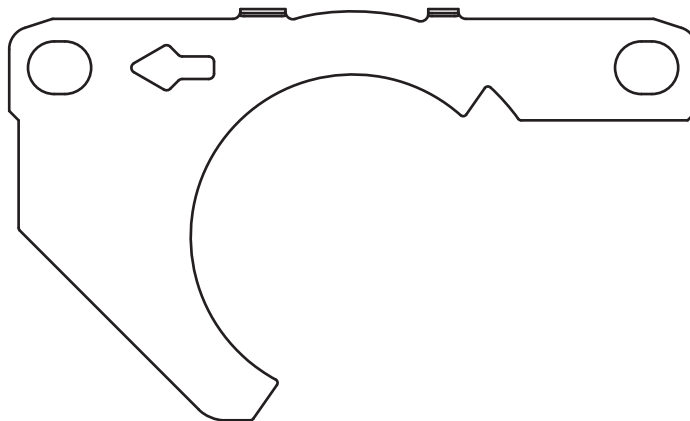
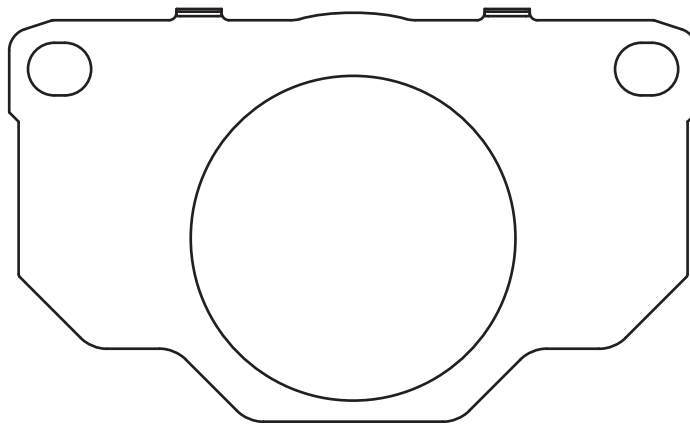
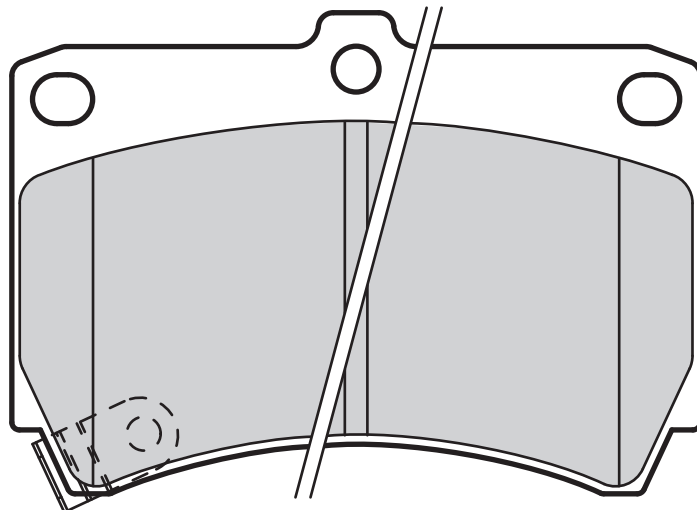

Valeo



Valeo



601018

2

Leaf

91,6

64

15,5

SUMITOMO

MAZDA

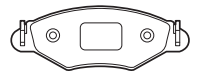

21657 (WVA)

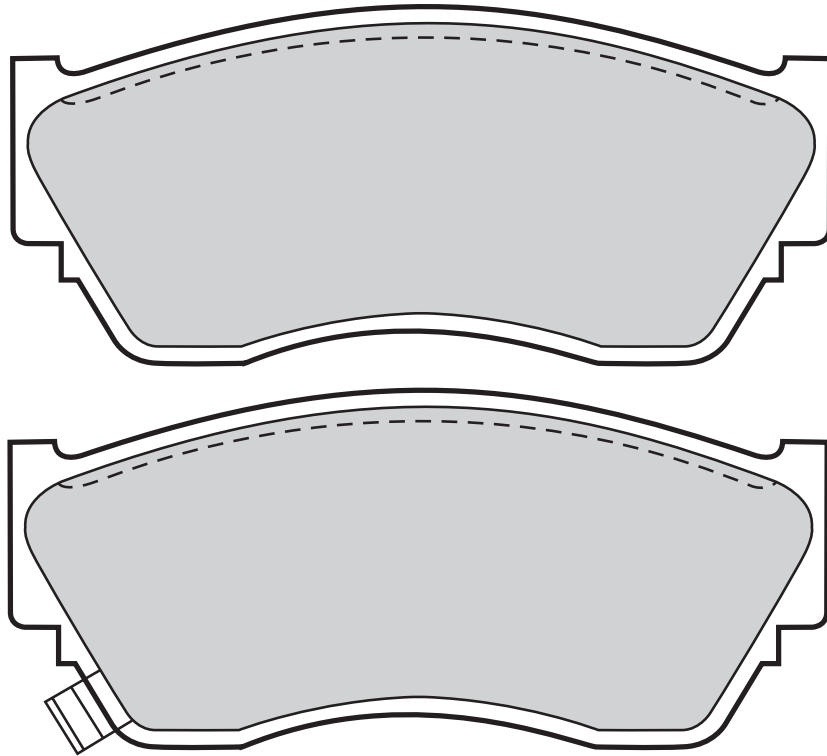

Valeo



0

Valeo



108,3



47,7



16,5



BENDIX



NISSAN

598628

21661 (WVA)

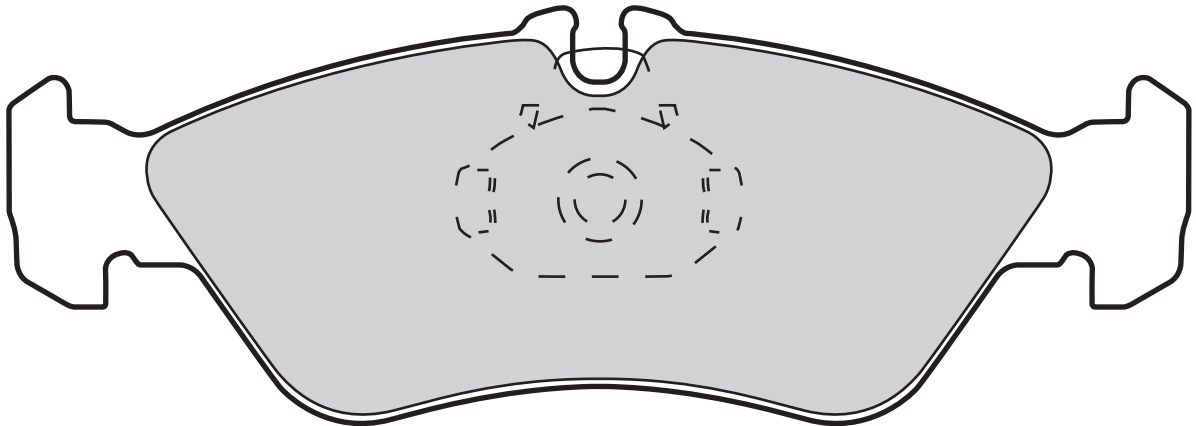

Valeo



0

Valeo



156,4



54,6



18,5



TEVES



MERCEDES, VOLKSWAGEN

598046

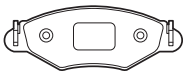

Valeo

21670 (WVA)

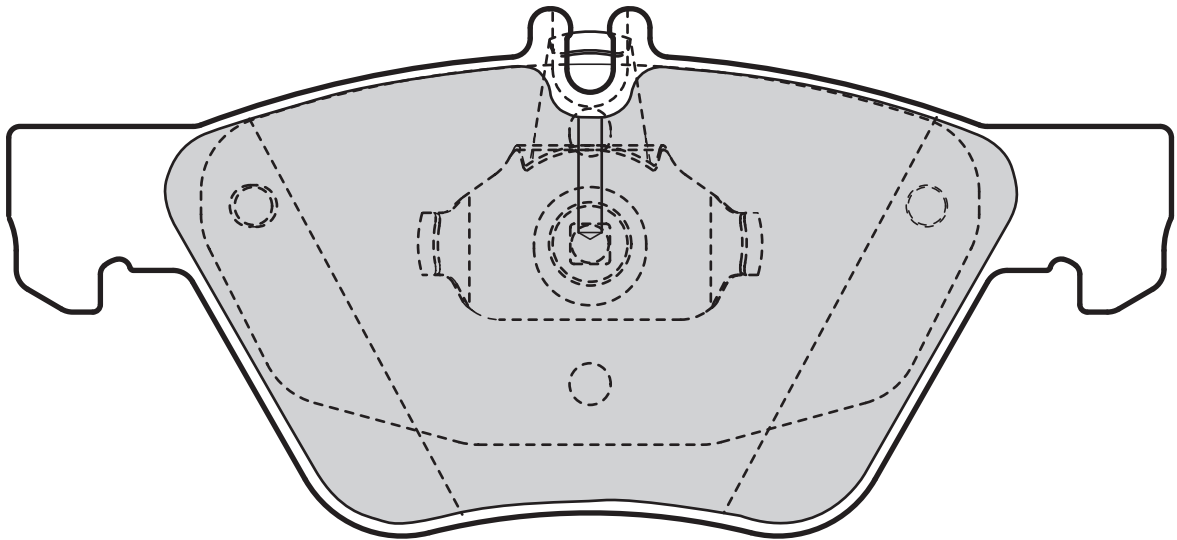
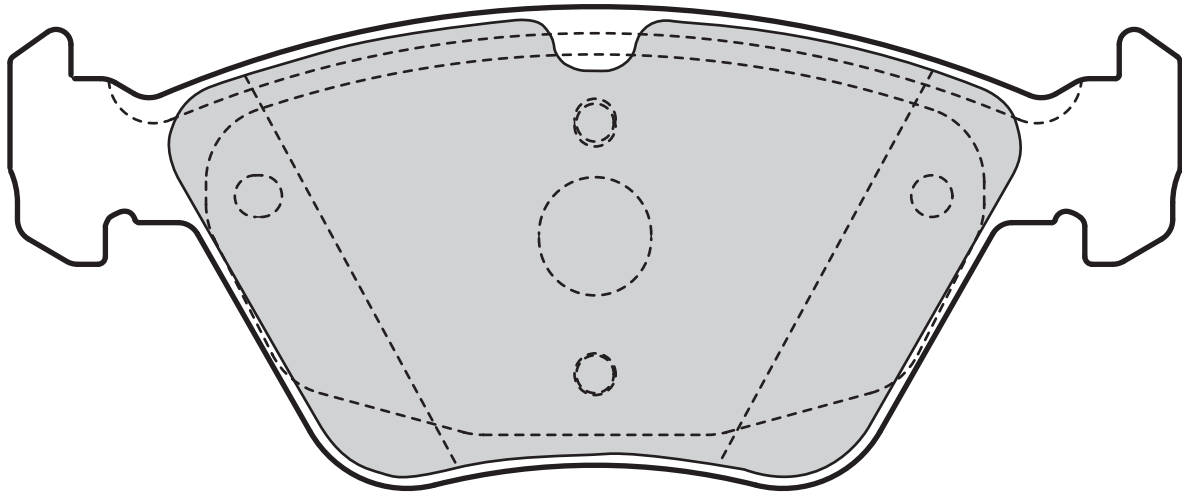

Valeo



0

Valeo



156,3



69,6



20,3



TEVES



CHRYSLER, MERCEDES

598636

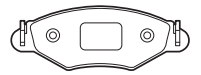

21674 (WVA)

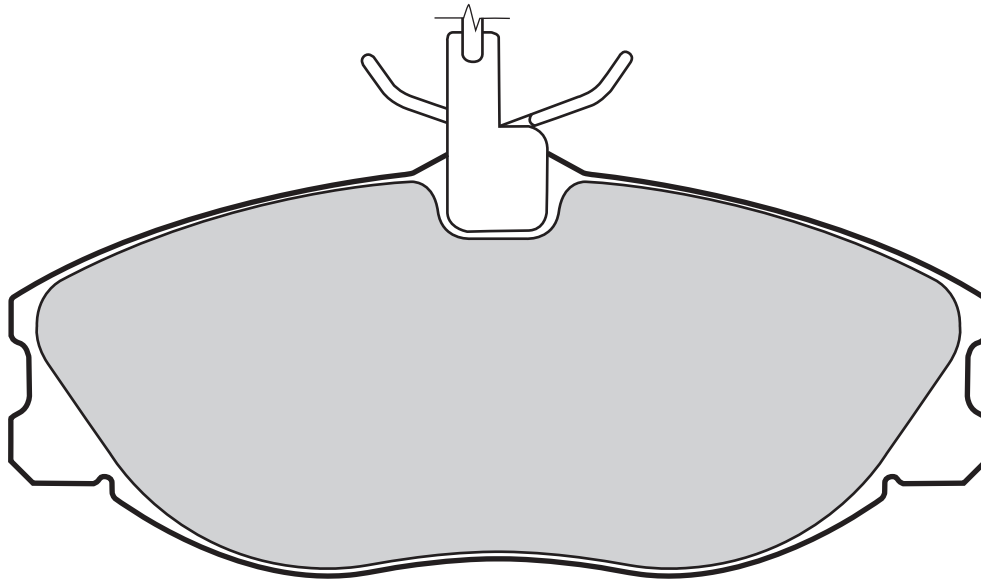

Valeo



Valeo



598069
598467

4
4

310
280/310

130
130

56,5
56,7

19
19

LUCAS
LUCAS

CITROËN, PEUGEOT
PEUGEOT

21677 (WVA)

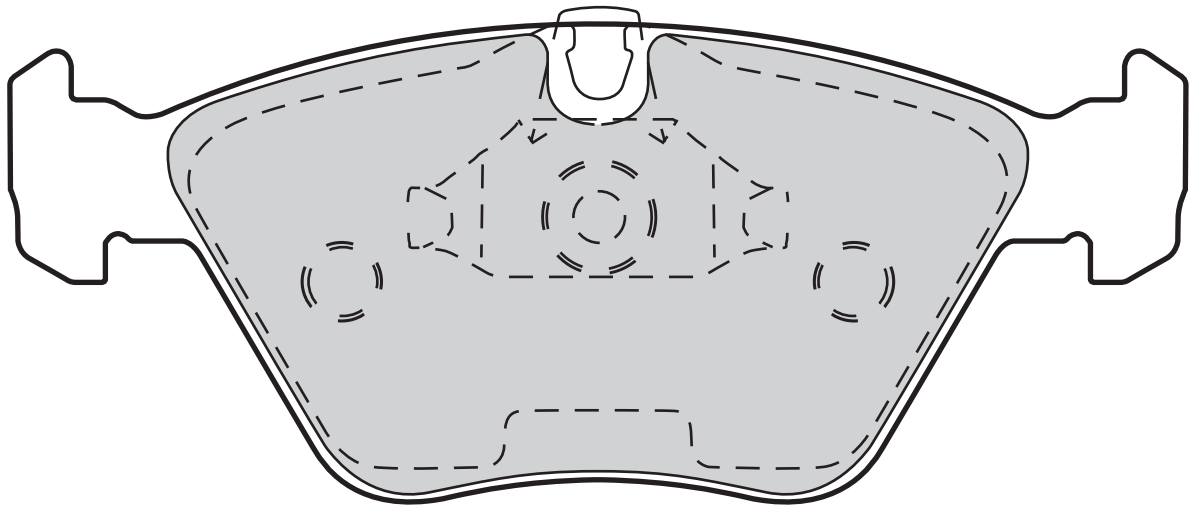

Valeo



Valeo



598310

0

156,4

64

20,3

TEVES

BMW



21682 (WVA)

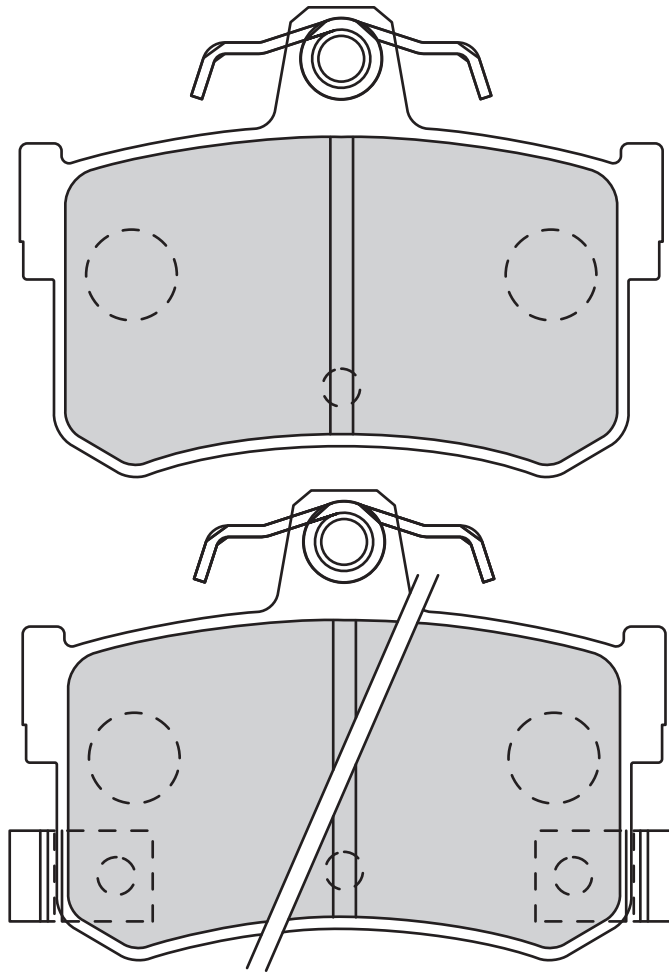

Valeo



2

Valeo



Leaf



85



62



14,5



LUCAS



MG, ROVER

598903

21691 (WVA)

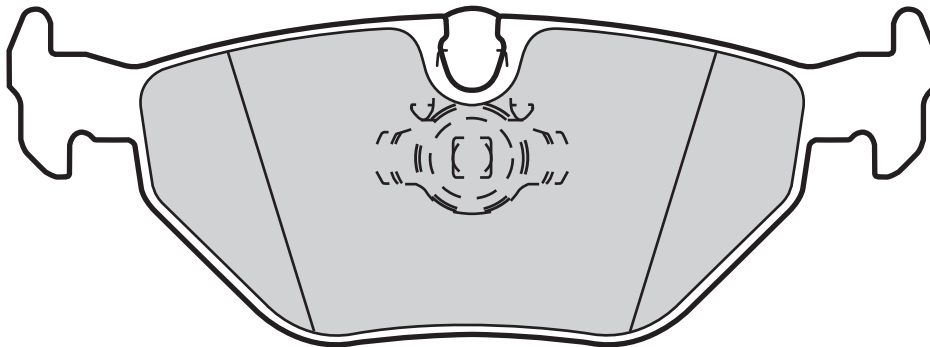

Valeo



0

Valeo



122



45



17,3



TEVES



BMW

598311



21694 (WVA)

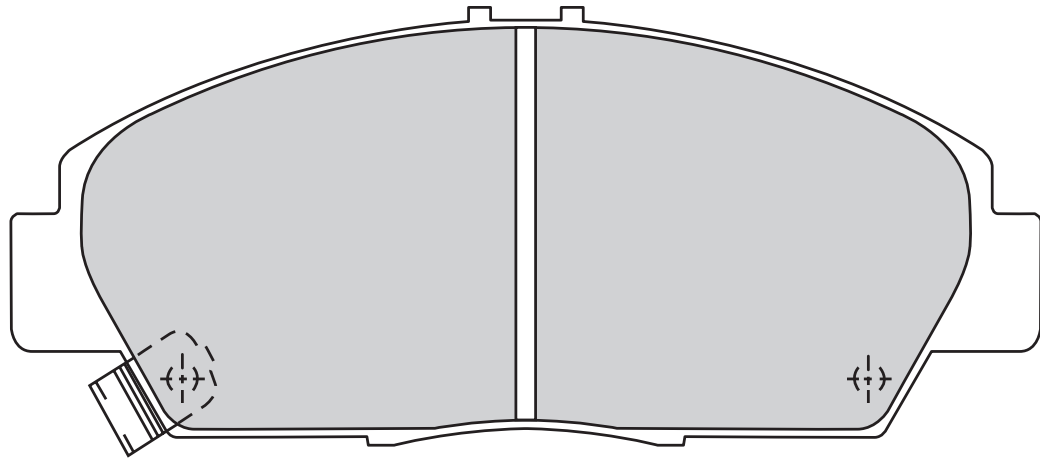

Valeo



Valeo



598494

0

136,5

57,8

17,3

SUMITOMO

HONDA

21697 (WVA)

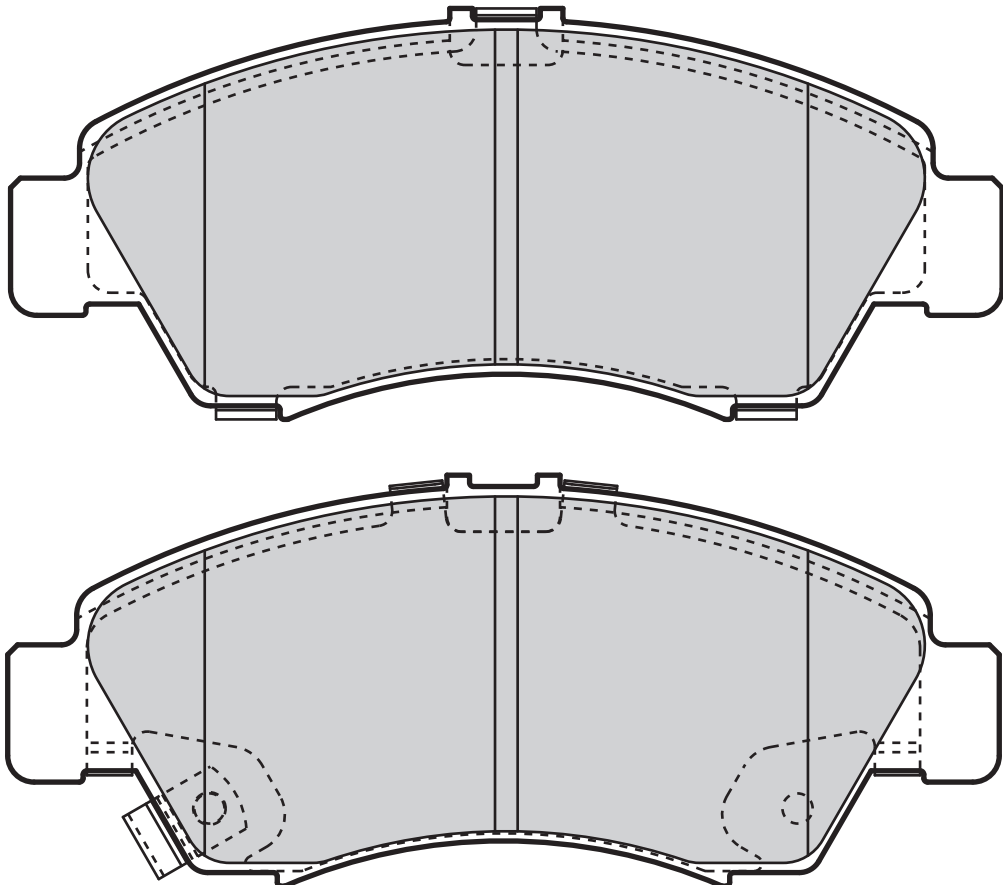

Valeo



Valeo



598495

2

Leaf

131,5

54,5

15

SUMITOMO

HONDA

598760

2 (B)

Leaf

131,5

54,5

15,6

SUMITOMO

HONDA



21703 (WVA)

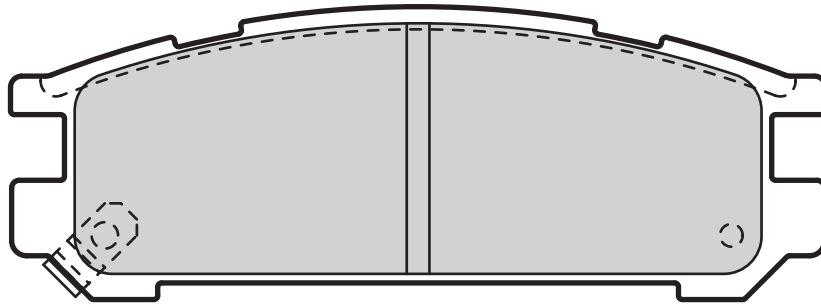

598828	2		107,8	38,5	15	SUMITOMO		SUBARU	

21706 (WVA)

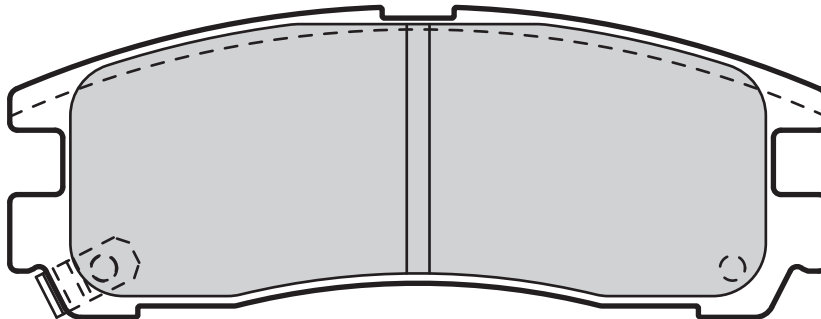

598834	2		108	41	15,5	AKEBONO		GALLOPER, HYUNDAI, MITSUBISHI	

21715 (WVA)

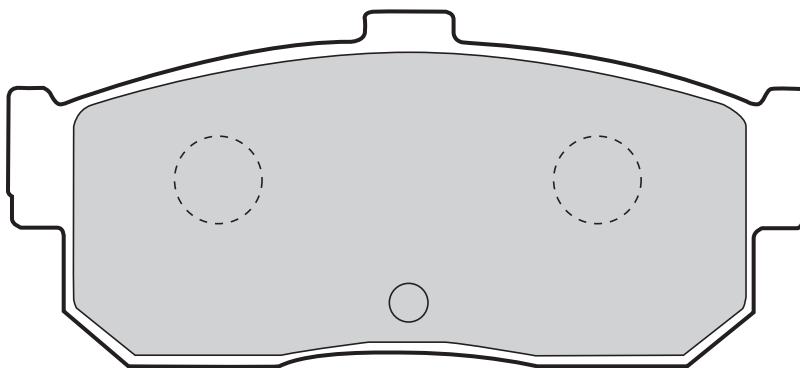

598668	2		105,2	46,8	16	SUMITOMO		NISSAN	

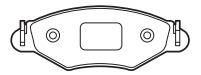

21716 (WVA)

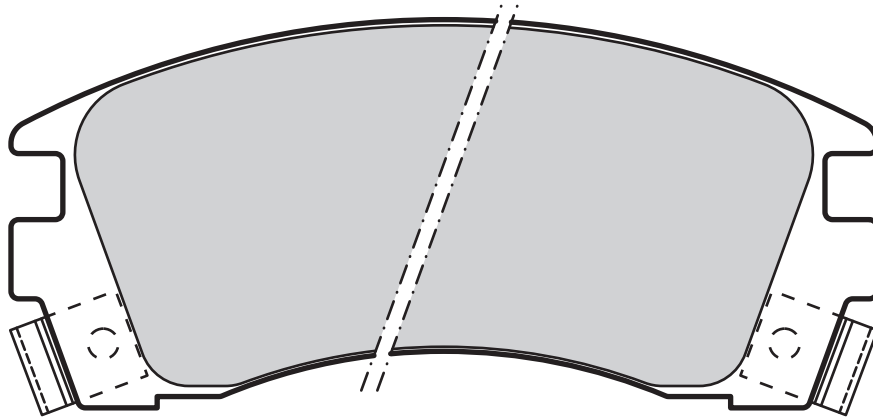

598840

2

114,7

51,5

16

AKEBONO

NISSAN

21719 (WVA)

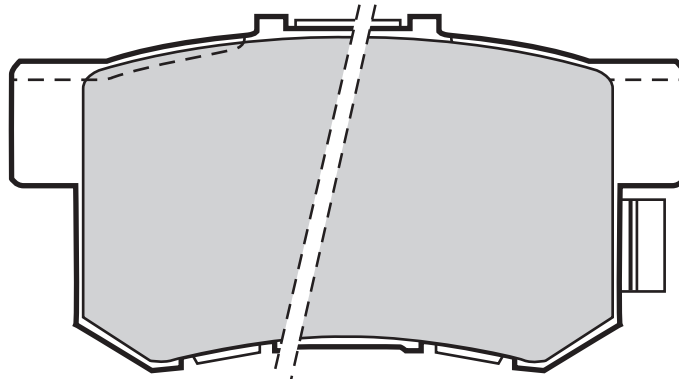

598682

2

88,9

47,5

15,4

AKEBONO

HONDA, MG, ROVER

598911

2

Leaf

89

47,5

14,6

AKEBONO

HONDA



Valeo

21724 (WVA)

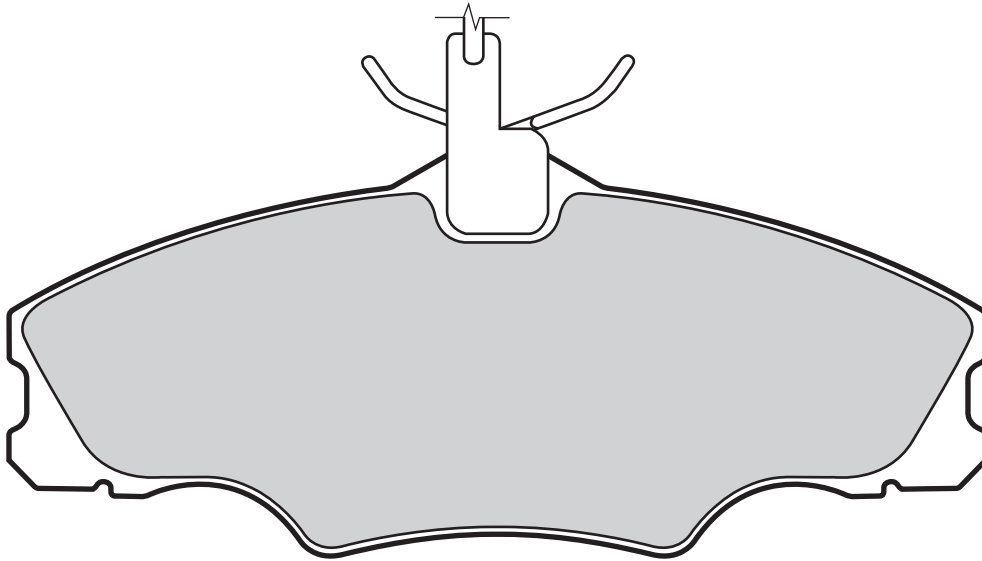

Valeo



Valeo



598068

4

310

130

53

19

LUCAS

PEUGEOT

21725 (WVA)

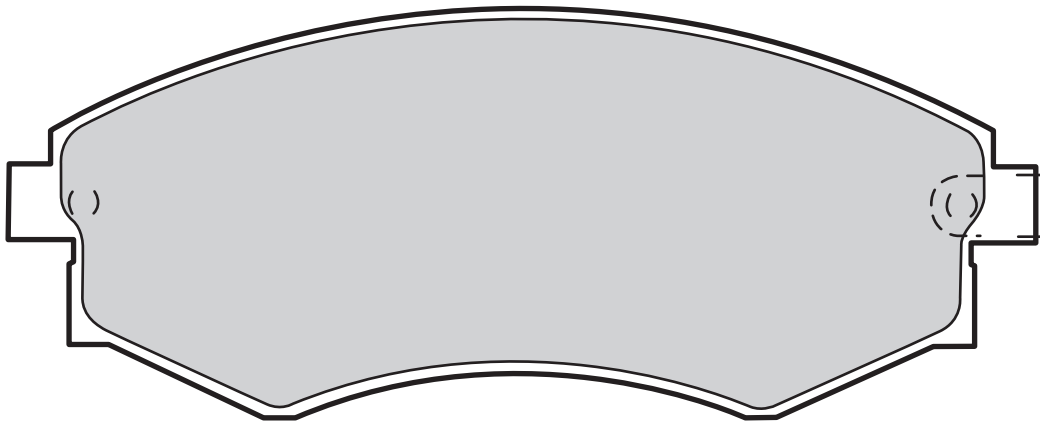

Valeo



Valeo



598051

2

137

54

17

AKEBONO

HYUNDAI

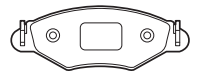

21727 (WVA)

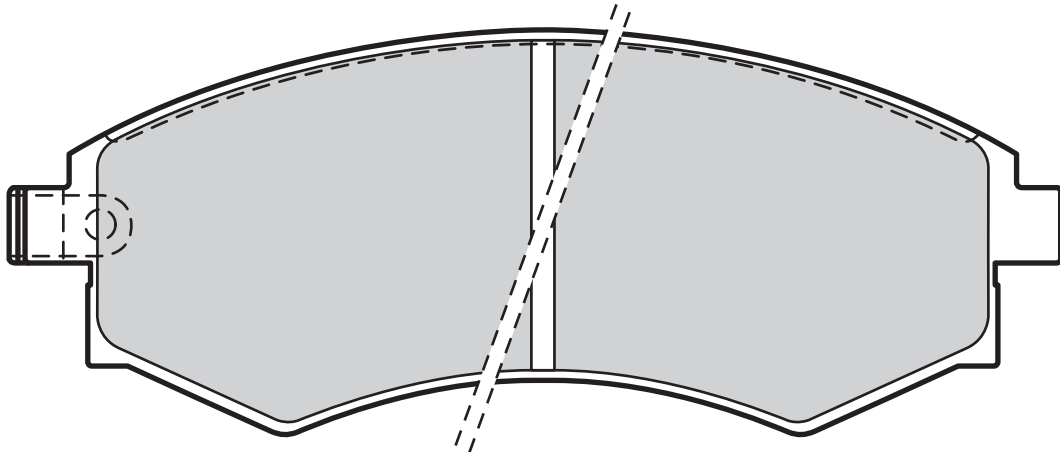

Valeo



Valeo



598574

2

137

53,4

17,5

AKEBONO

HYUNDAI, KIA

21729 (WVA)

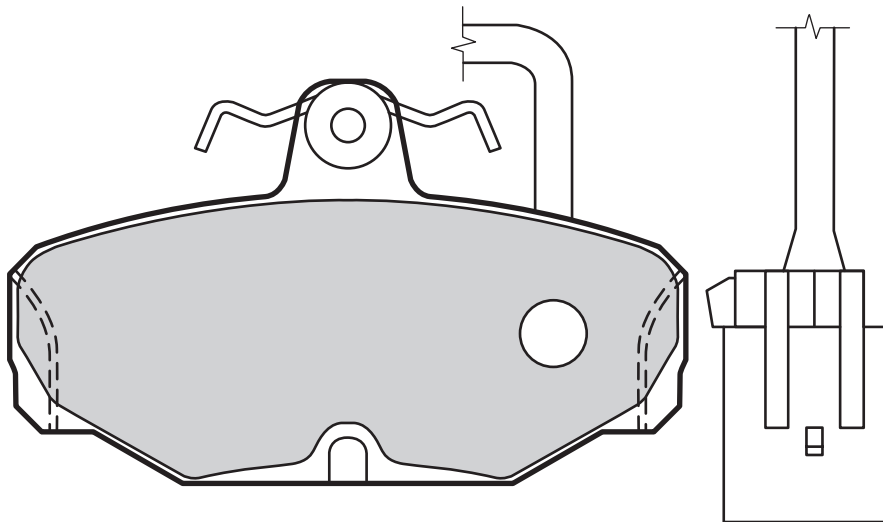

Valeo



Valeo



598312

2

240

89,8

54

13,7

LUCAS

FORD



Valeo

21730 (WVA)

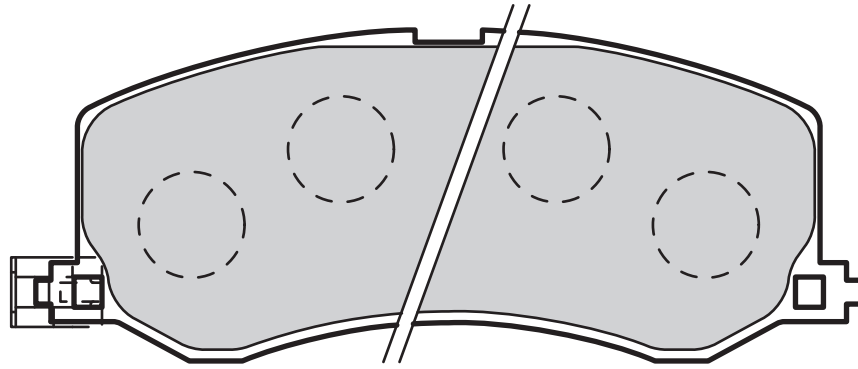

Valeo



Valeo



Leaf



109,2



43,8



14



AKEBONO



SUZUKI

598986

4

Leaf

109,2

43,8

14

AKEBONO

SUZUKI

21732 (WVA)

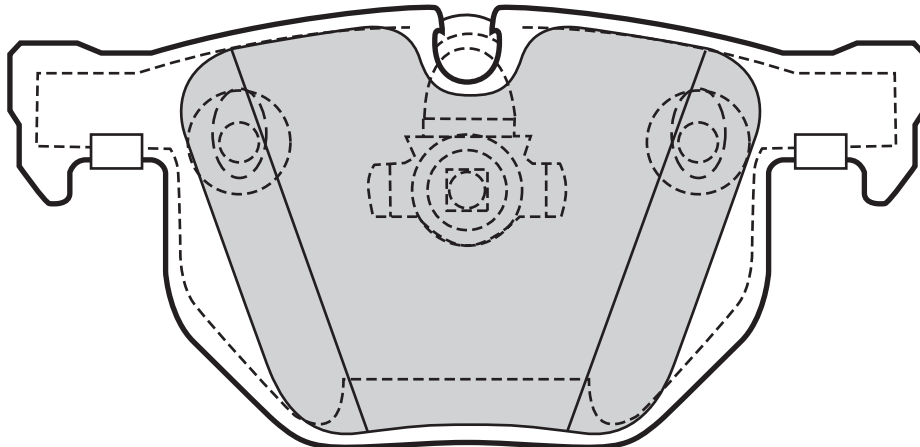
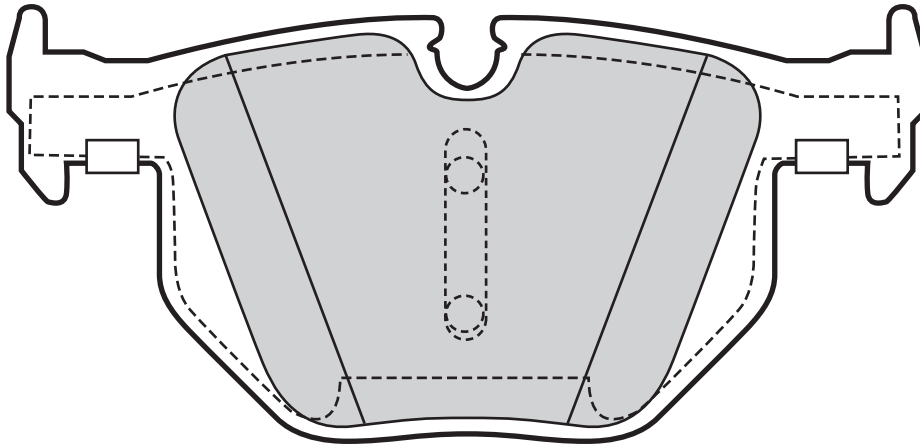

Valeo



Valeo



Leaf



121,8



59,3



17,3



TEVES



BMW

598754

0

Leaf

121,8

59,3

17,3

TEVES

BMW

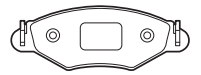

21734 (WVA)

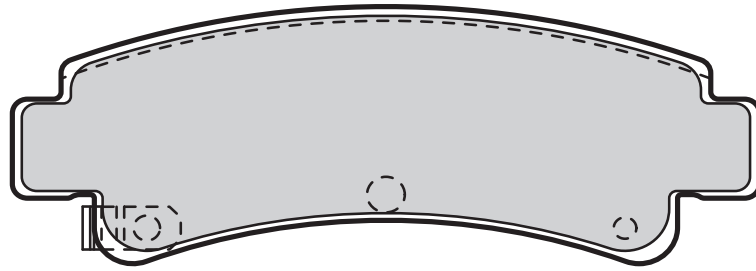

598826	0		98,8	33,5	14	SUMITOMO	NISSAN

21738 (WVA)

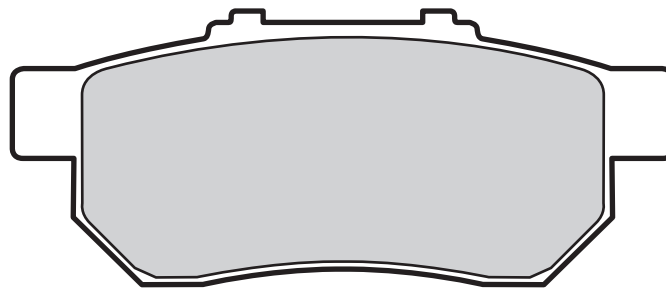

598437	2		88,8	36,8	12,6	AKEBONO	HONDA

21748 (WVA)

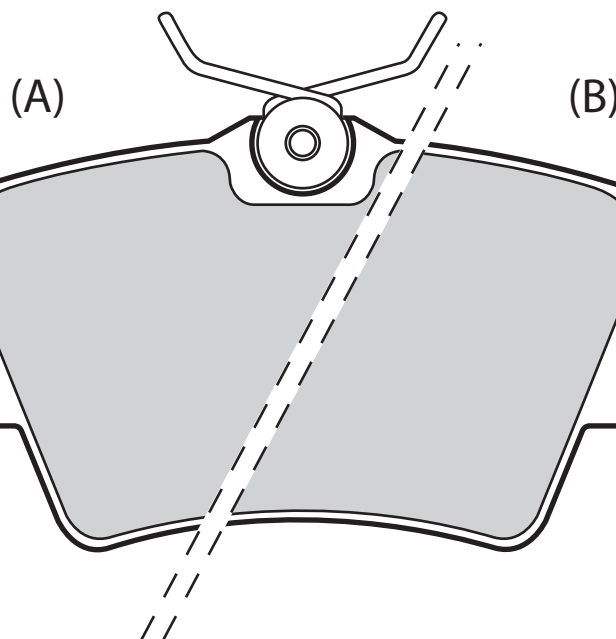

598482	0 (B)		94,9	57,4	17	LUCAS	VOLKSWAGEN
598546	0 (A)		95	57,4	17	LUCAS	NISSAN, OPEL, RENAULT, VAUXHALL



21754 (WVA)

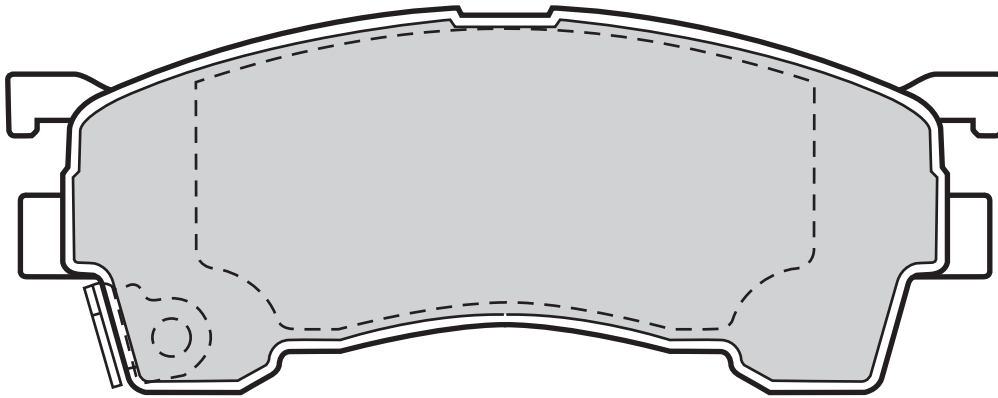
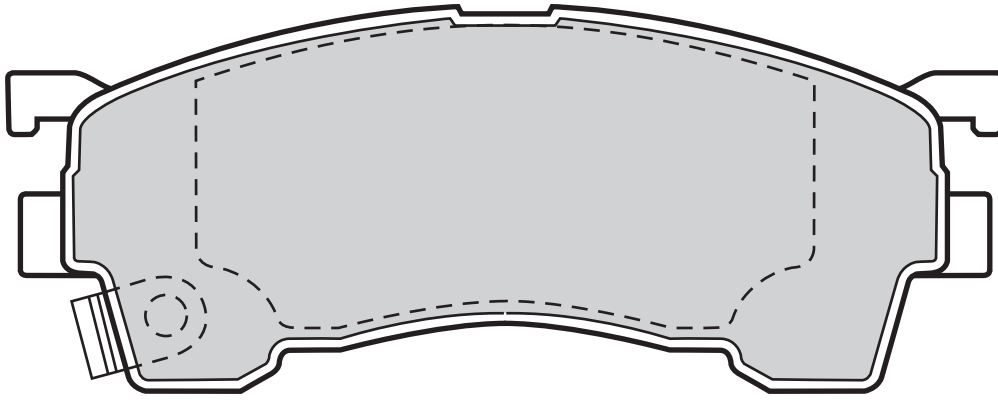

Valeo



Valeo



598629

2

132

51,5

15

SUMITOMO

FORD, MAZDA

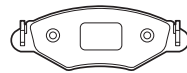

21755 (WVA)

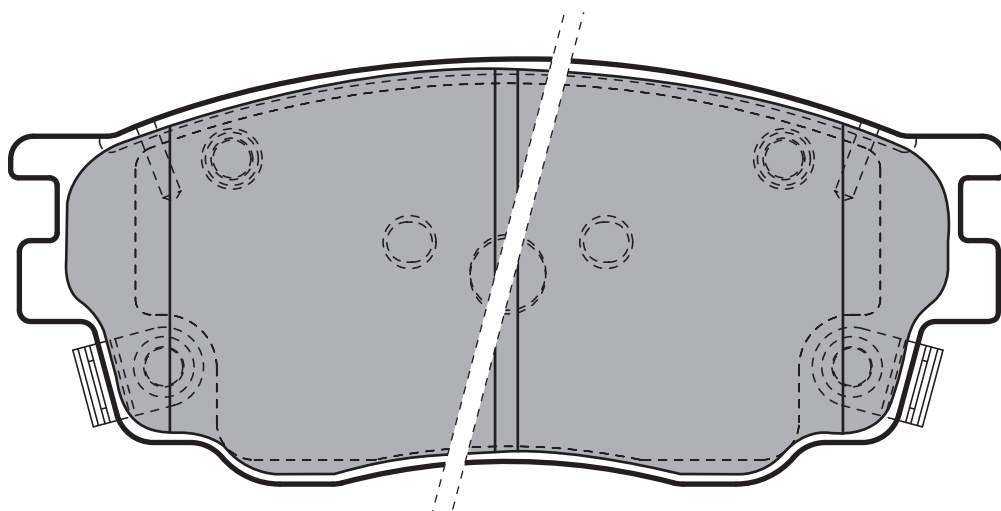
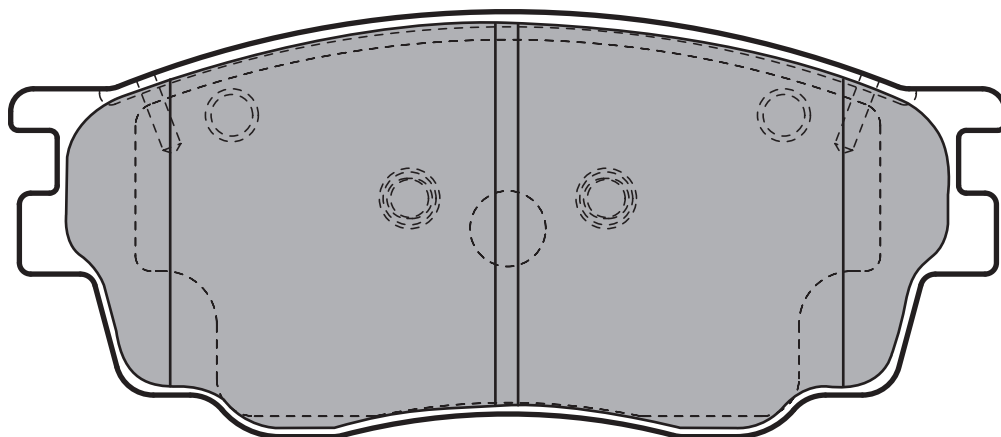

Valeo



Valeo



598647

2

131,8

56,2

16

SUMITOMO

MAZDA



Valeo

21759 (WVA)

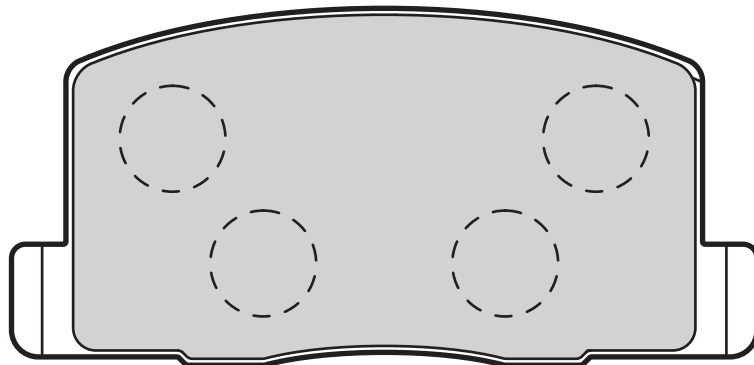
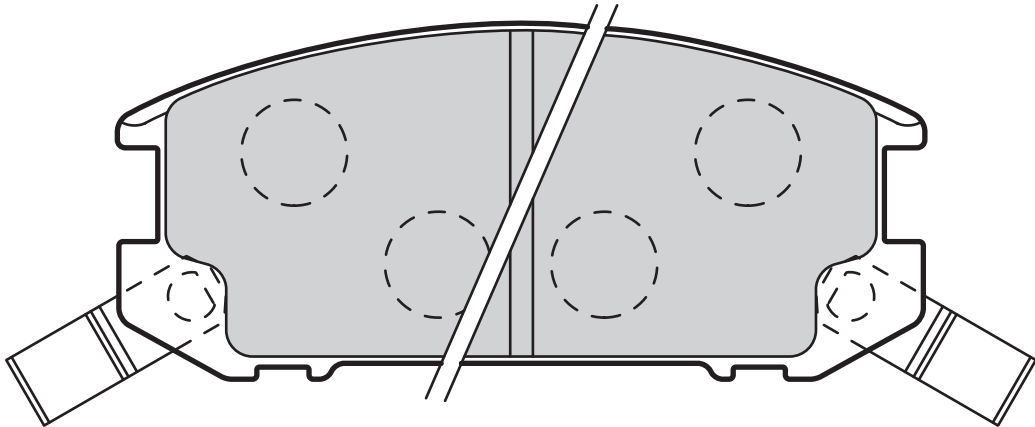

Valeo



Valeo



598983

0

98,6

47,2

16/15

AKEBONO

TOYOTA

21766 (WVA)

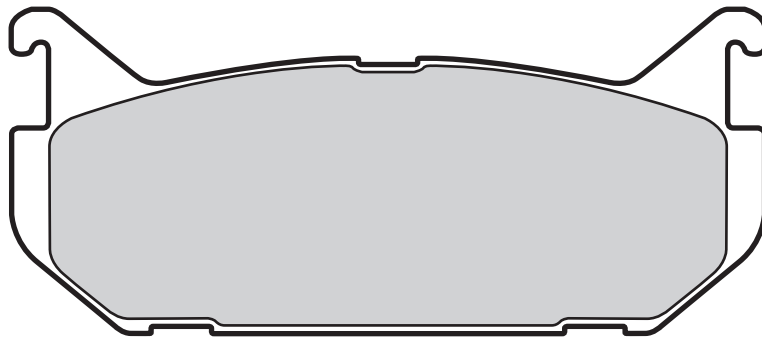

Valeo



Valeo



598290

0

100

43,5

14

SUMITOMO

FORD, MAZDA

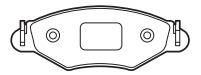

21775 (WVA)

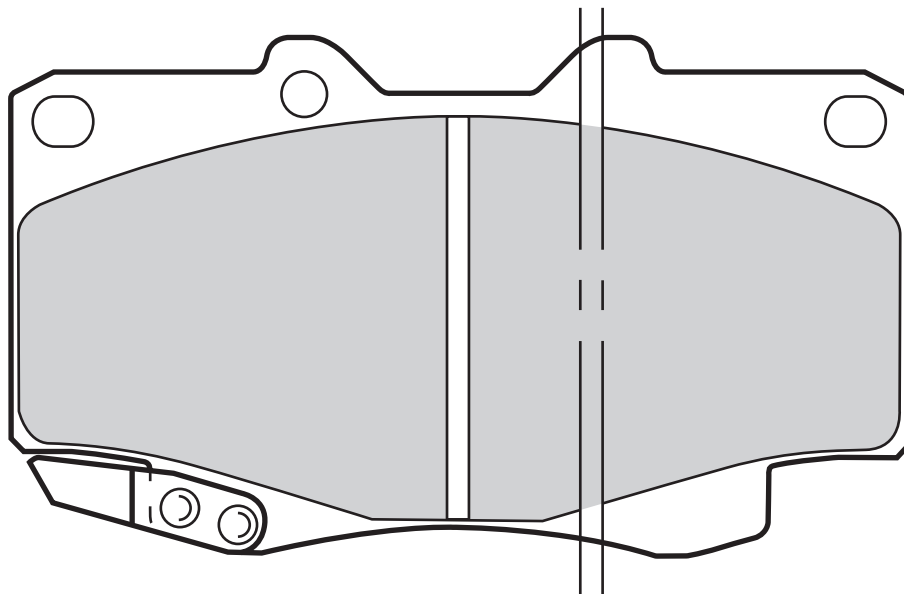
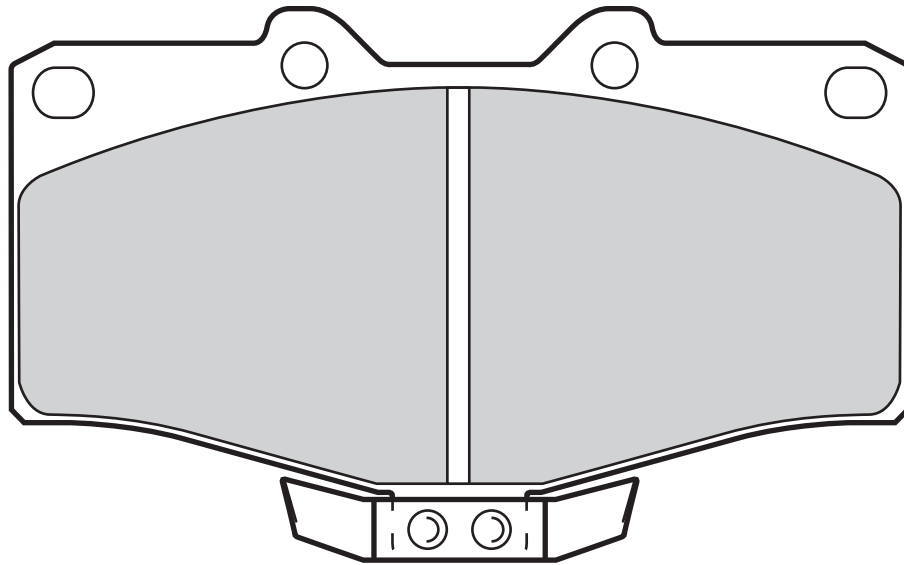

Valeo



Valeo



598393

4

119,2

71,7

15

SUMITOMO

TOYOTA

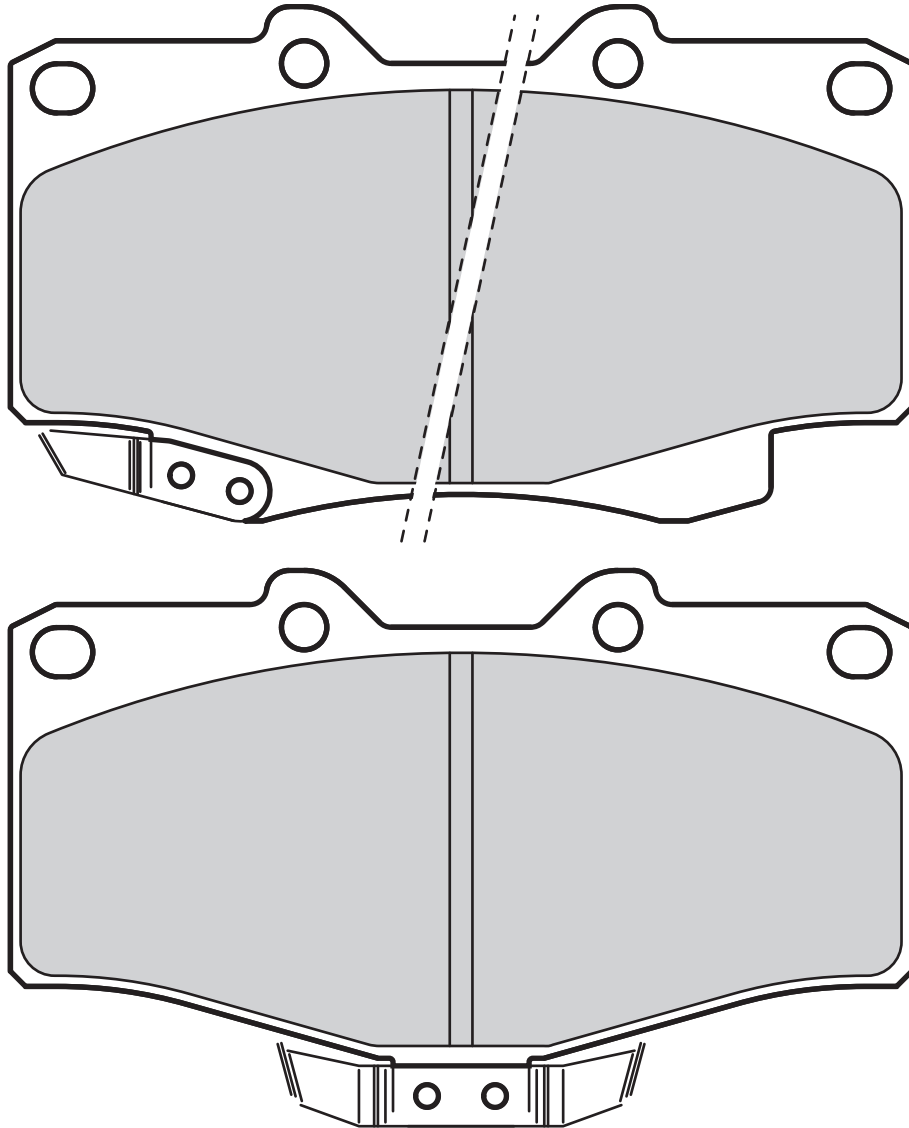
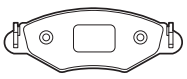

Valeo



Valeo



598897

4

Leaf

119,2

68

15

SUMITOMO

TOYOTA, VOLKSWAGEN

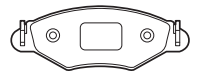

21792 (WVA)

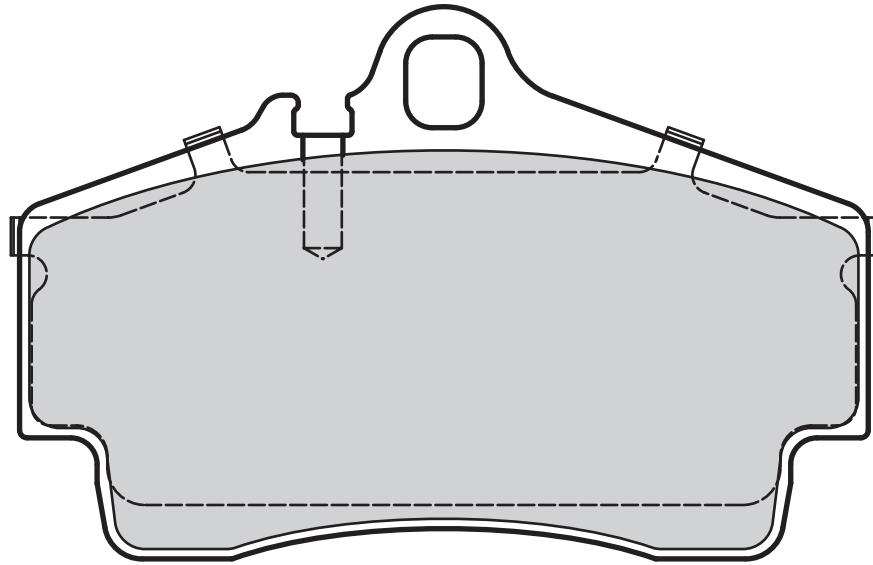

Valeo



Valeo



598768

0

112,2

73,2

16

BREMBO

PORSCHE

21797 (WVA)

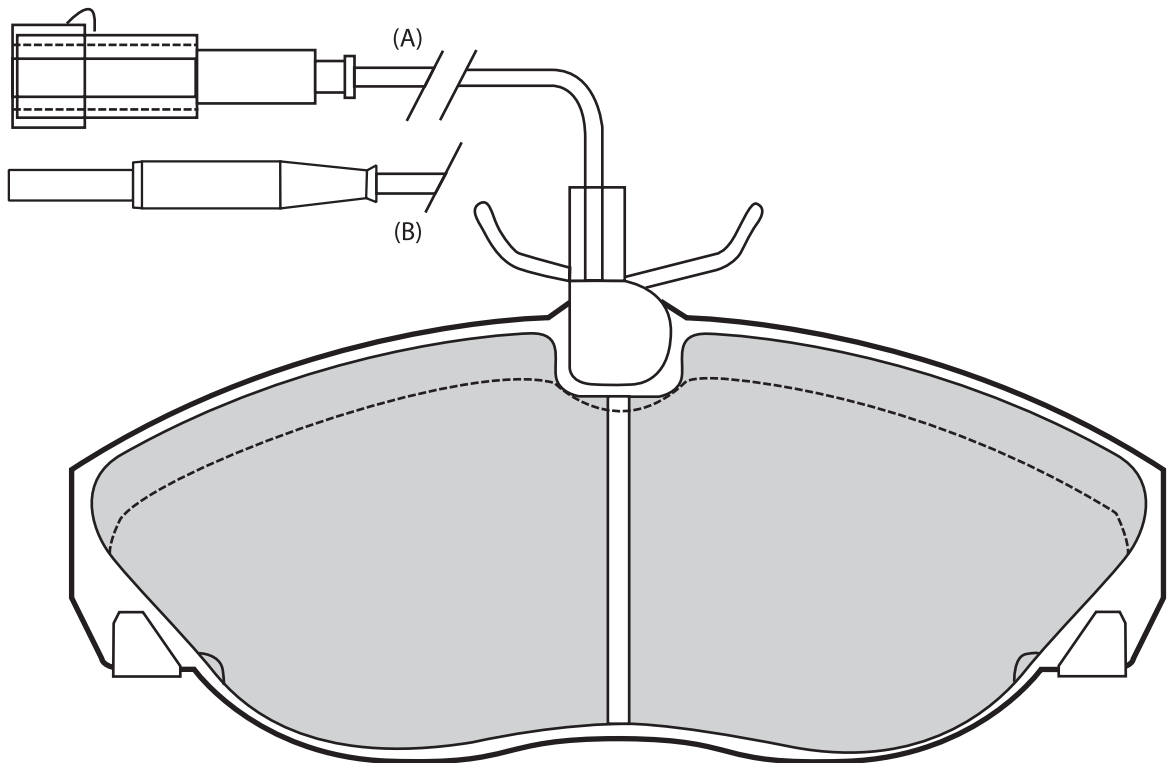

Valeo



Valeo



598070

2 (B)

145

60,8

19,2

LUCAS

CITROËN, FIAT, PEUGEOT

598429

1 (A)

300

145

60,9

19,5

LUCAS

CITROËN, FIAT, PEUGEOT



21799 (WVA)

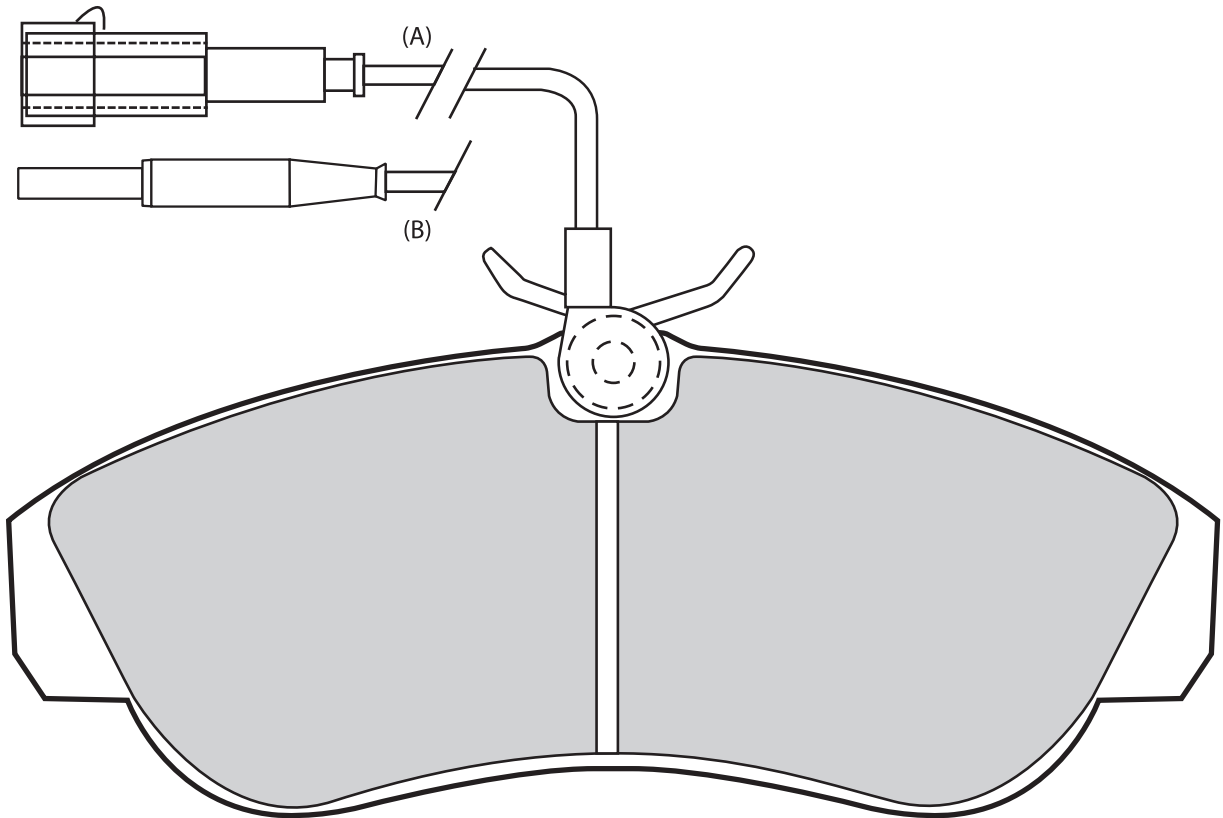

Valeo



Valeo

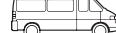

598430

1 (B)

200

160

64,1

19,5

LUCAS

CITROËN, FIAT, PEUGEOT

598800

2 (A)

200

159,7

64,1

19,5

LUCAS

CITROËN, FIAT, PEUGEOT

21801 (WVA)

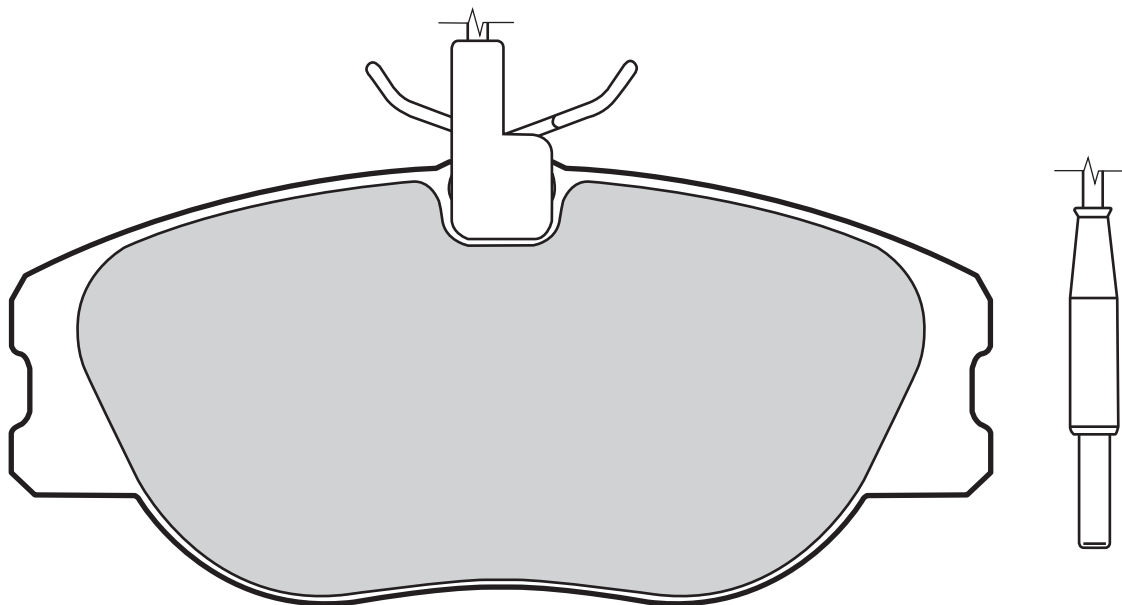

Valeo



Valeo

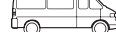

598064

4

240/195

130

57,4

18,8

LUCAS

CITROËN, FIAT, LANCIA, PEUGEOT

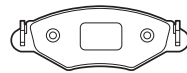

21815 (WVA)

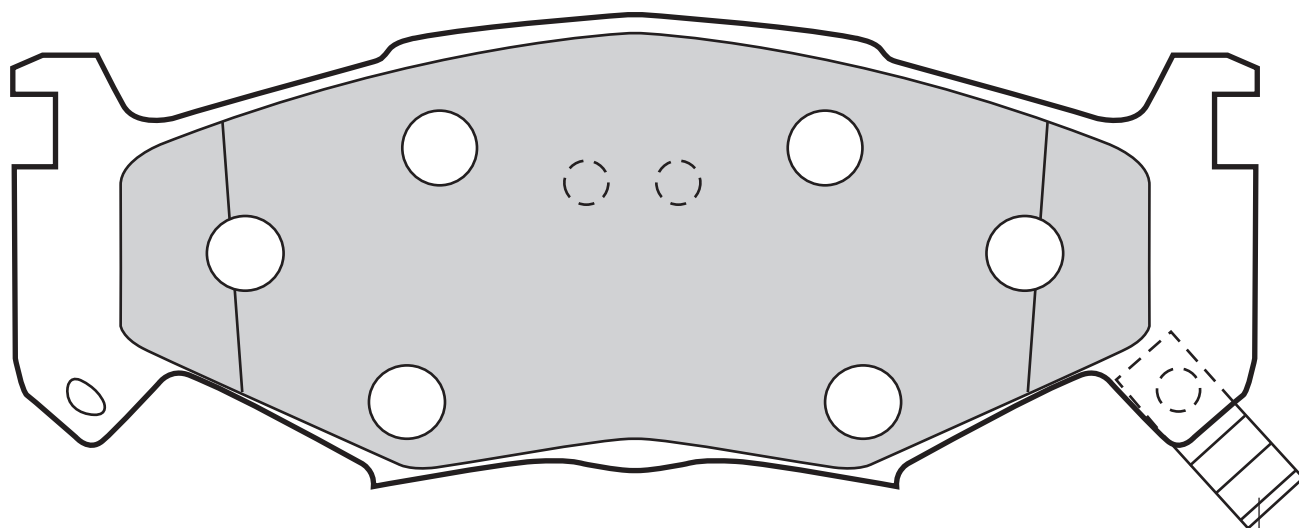
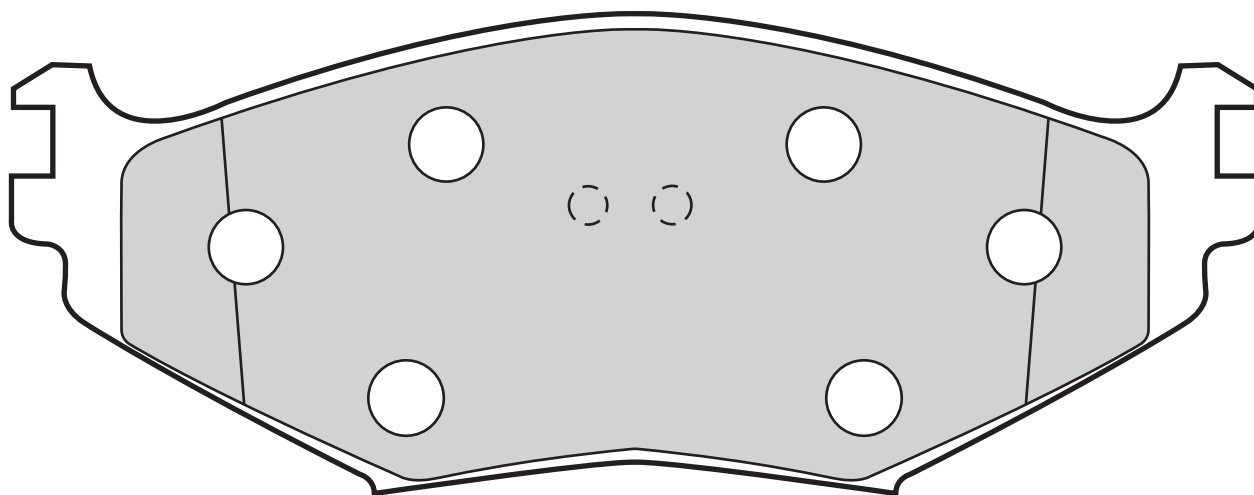

Valeo



Valeo



598600

0

164,5

60,6

19

KELSEY

CHRYSLER

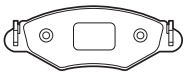

21820 (WVA)

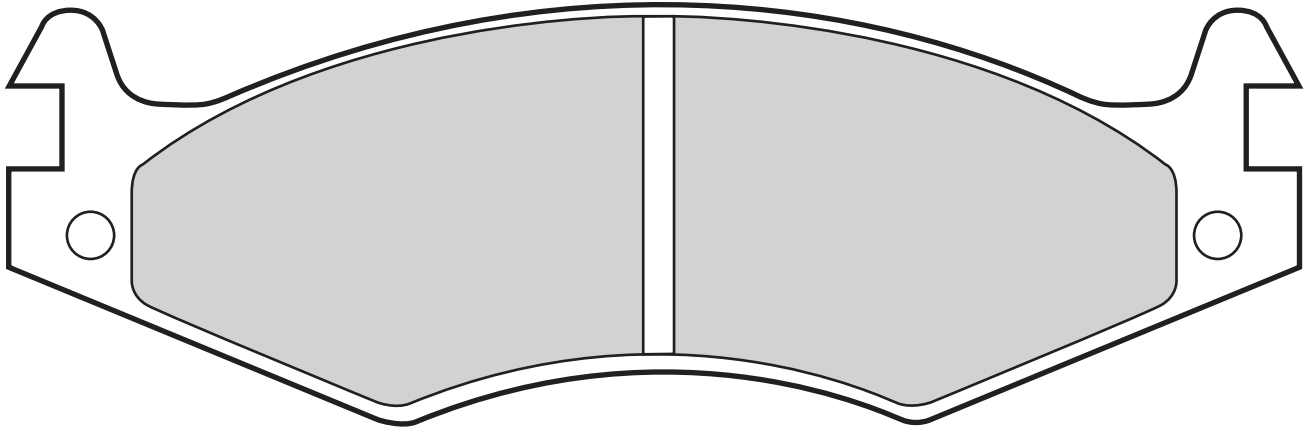

598595

0

176,8

56/55

16

KELSEY

RENAULT

21822 (WVA)

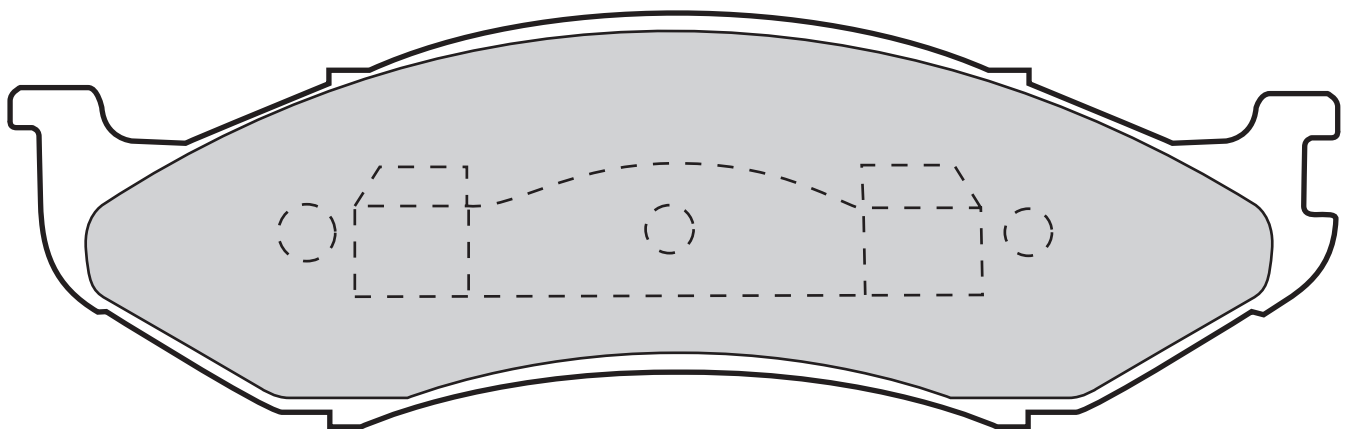
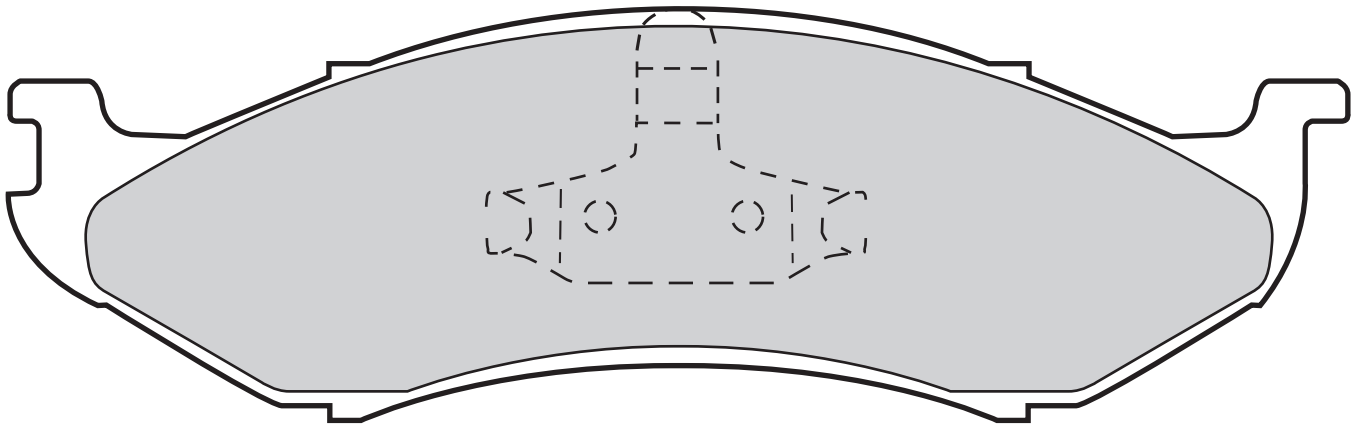

598491

0

177

55

17,1

KELSEY

JEEP, KIA, RENAULT



21829 (WVA)

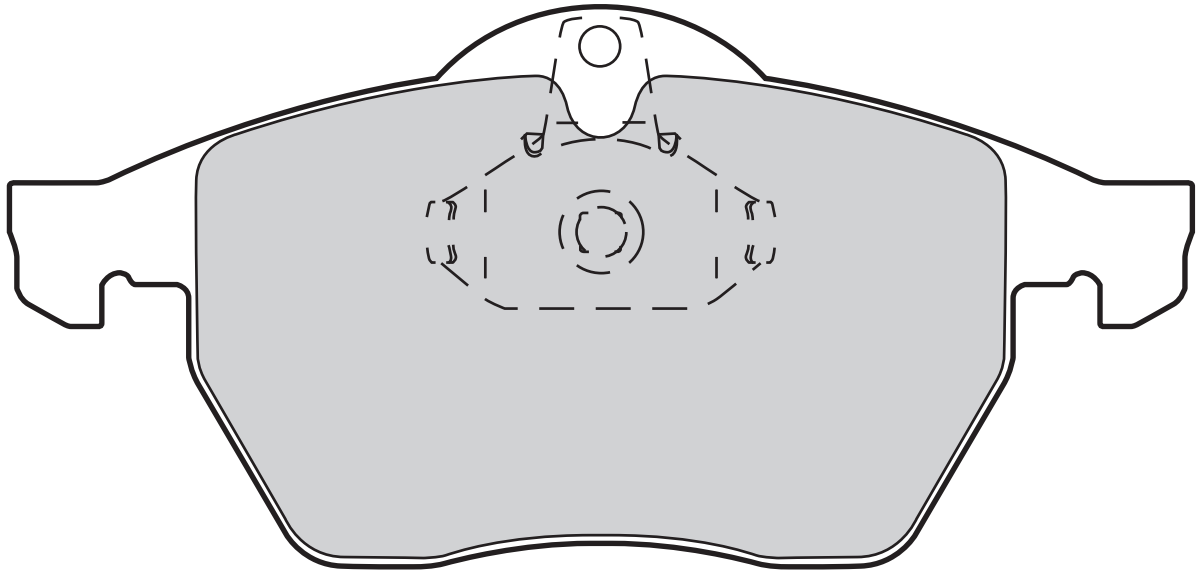

Valeo



0

Valeo



156,3



74,2



20,3



TEVES



OPEL, SAAB, VAUXHALL

598305

21833 (WVA)

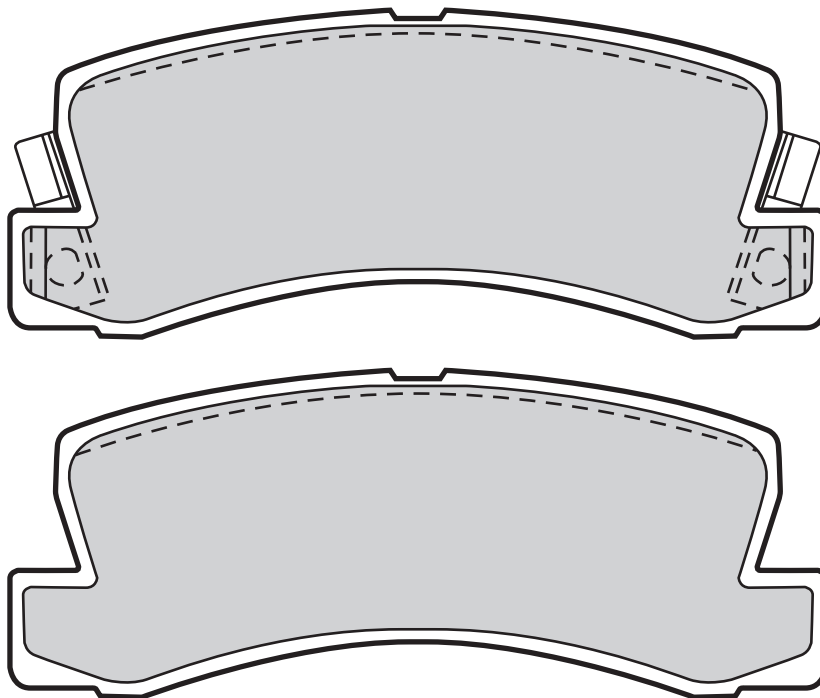

Valeo



0

Valeo



107,6



42,5



15



AKEBONO



TOYOTA

598540

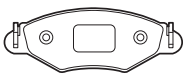

21835 (WVA)

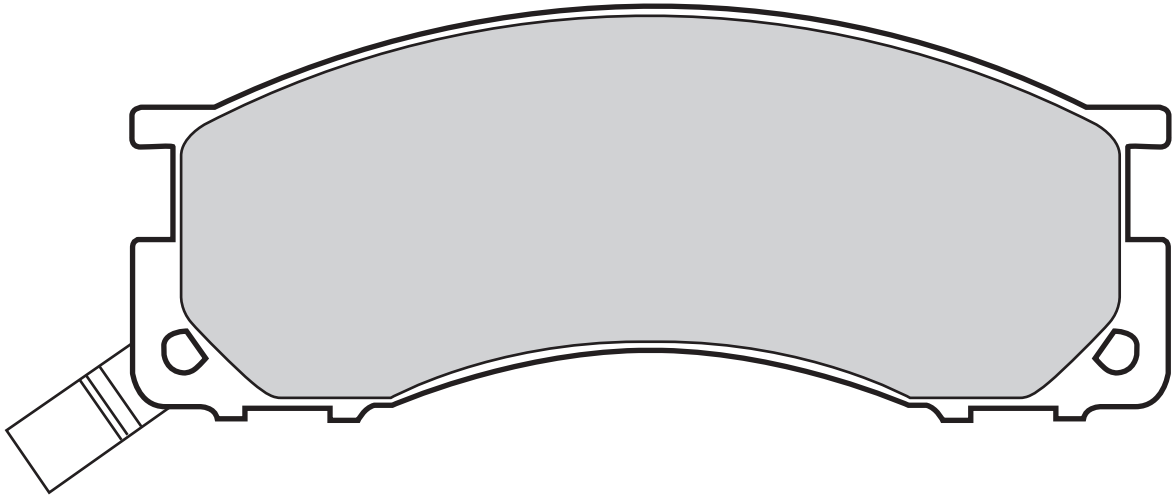
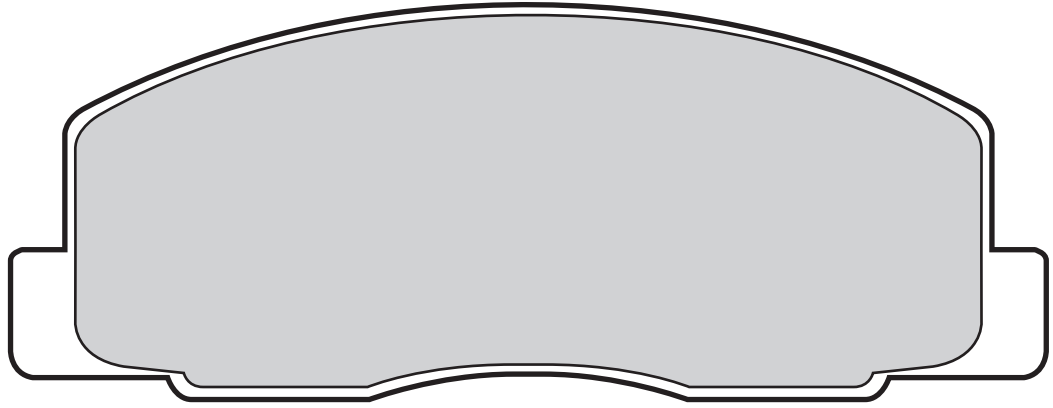

598496

0

127/128,5

52/55

15,5

AKEBONO

TOYOTA

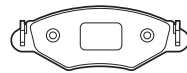

21840 (WVA)

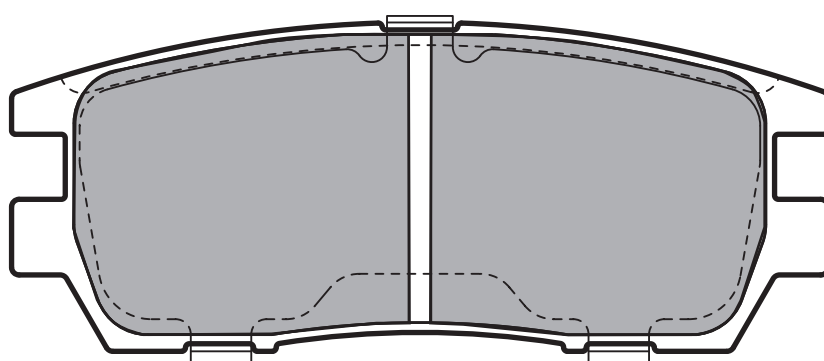
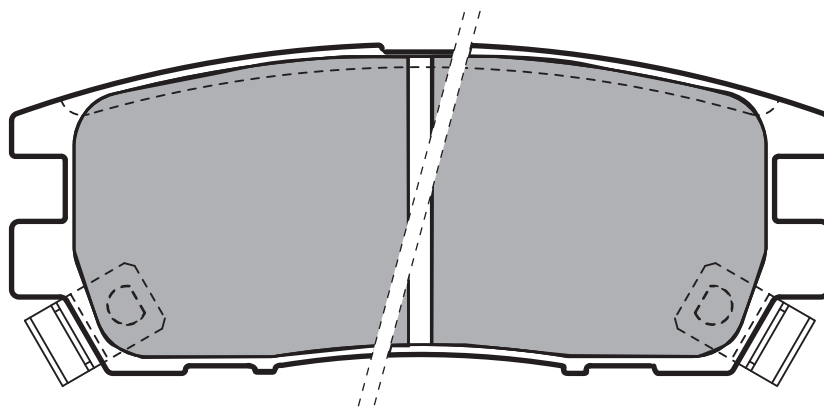

Valeo



Valeo



598519

2

108

43,5

14

AKEBONO

MITSUBISHI

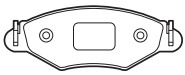

21845 (WVA)

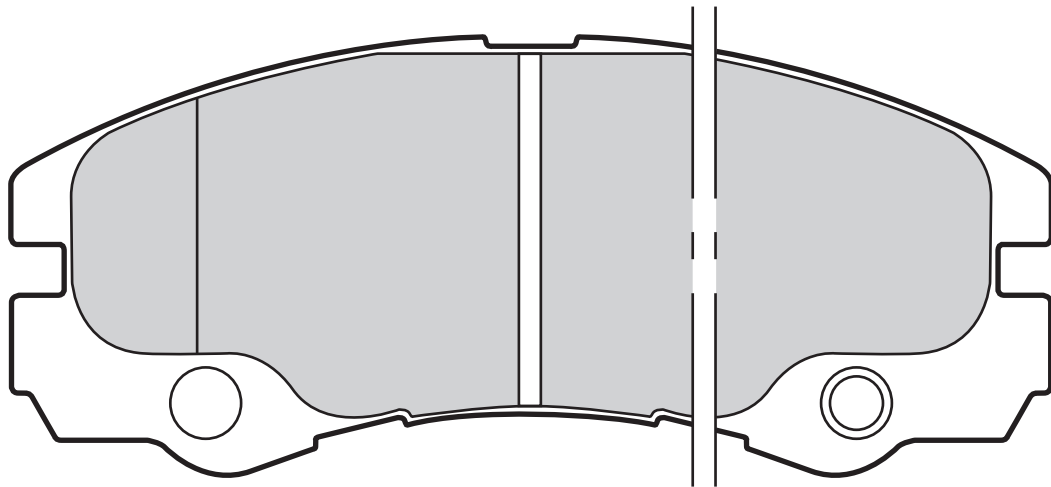
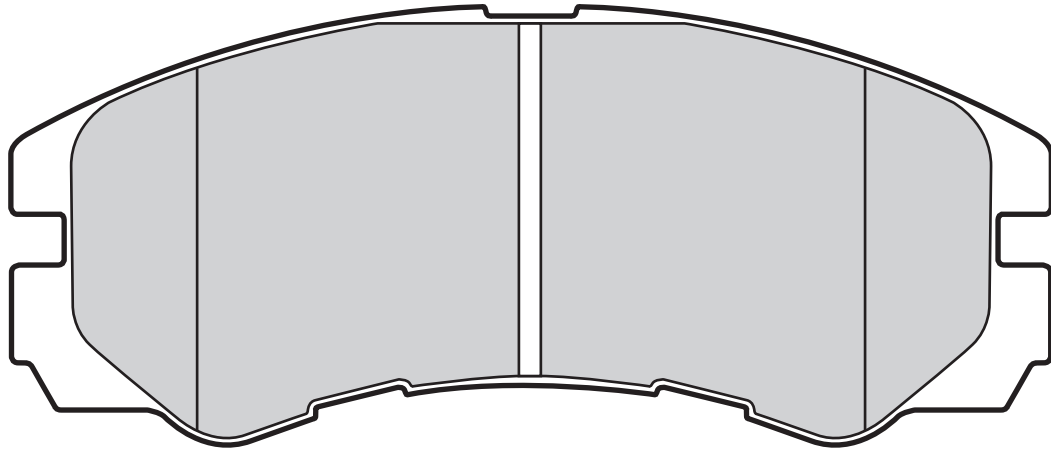

598460	1	137,8	58,8	17,1	AKEBONO	ISUZU, OPEL, VAUXHALL			

21854 (WVA)

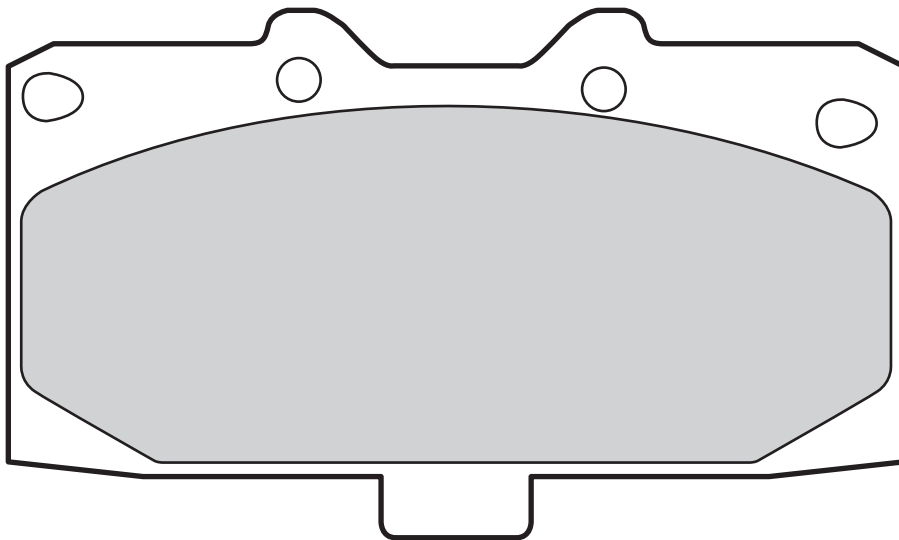

598476	4	119,2	70	14,5	SUMITOMO	NISSAN, SUBARU			



21861 (WVA)

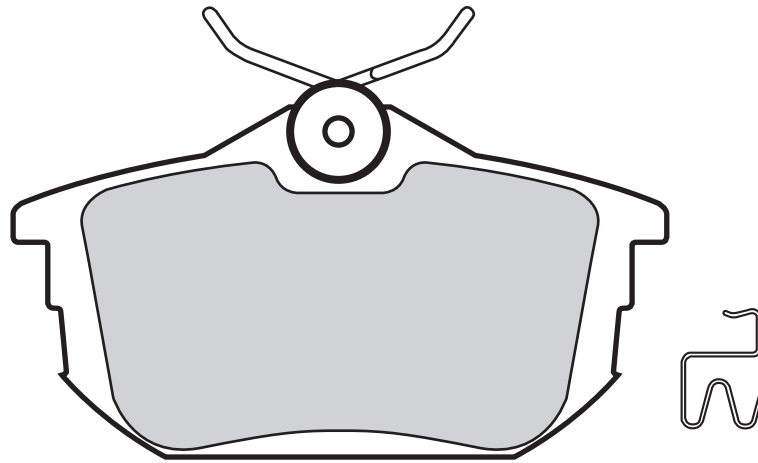

Valeo



2

Valeo



87,3



47



15,3



LUCAS



mitsubishi, smart MCC, volvo

598319

21865 (WVA)

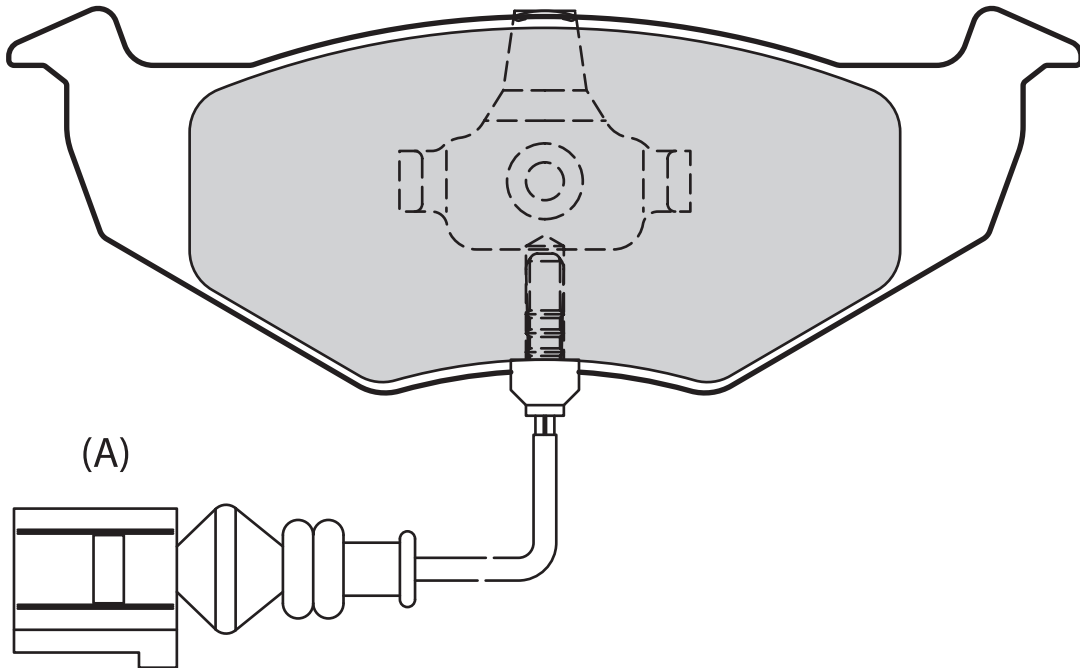

(A)

Valeo



0

Valeo



180



141,8



50,7



17,3



TEVES



SEAT, SKODA, VOLKSWAGEN

598488

598805

1 (A)

141,8

50,6

17

TEVES

SKODA, VOLKSWAGEN



21866 (WVA)

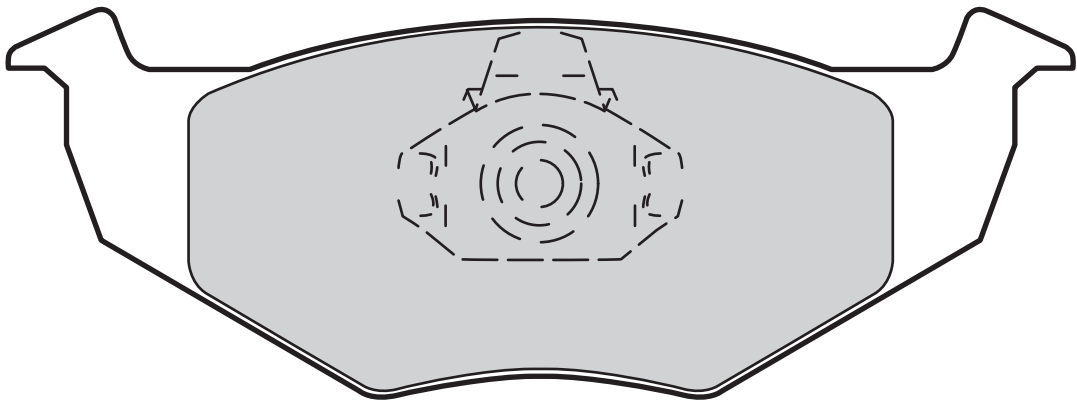
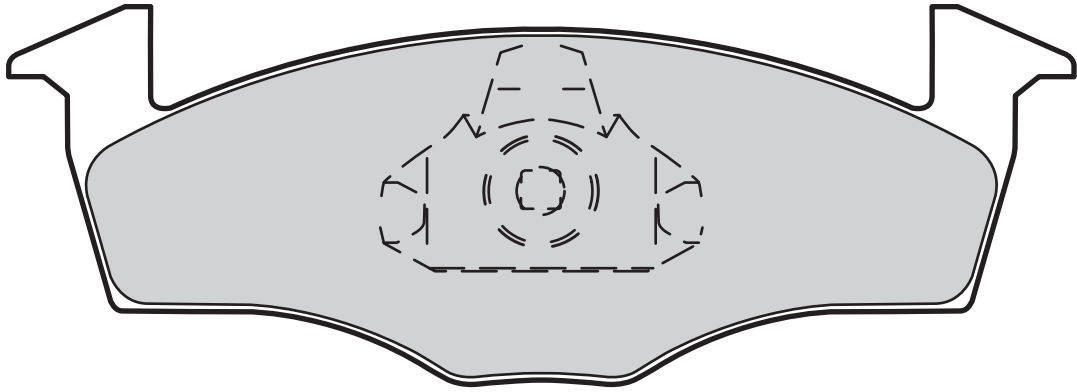

Valeo



Valeo



598066

0

141,8

50,5

19,7

TEVES

SEAT, VOLKSWAGEN

598403

0

141,8

51,3

15

TEVES

SEAT, VOLKSWAGEN

21872 (WVA)

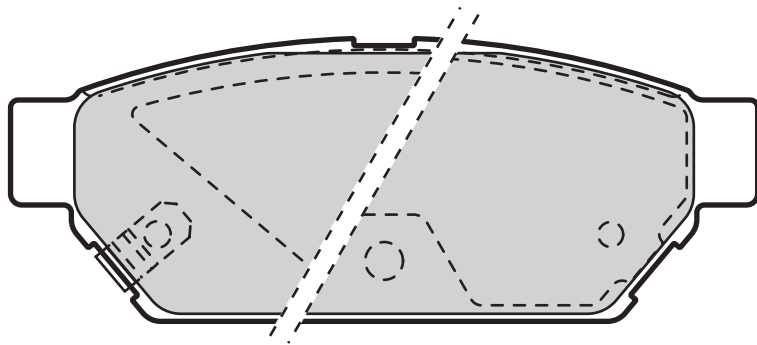

Valeo



Valeo



598844

2

98,8

37,6

14,5

AKEBONO

mitsubishi, proton



21875 (WVA)

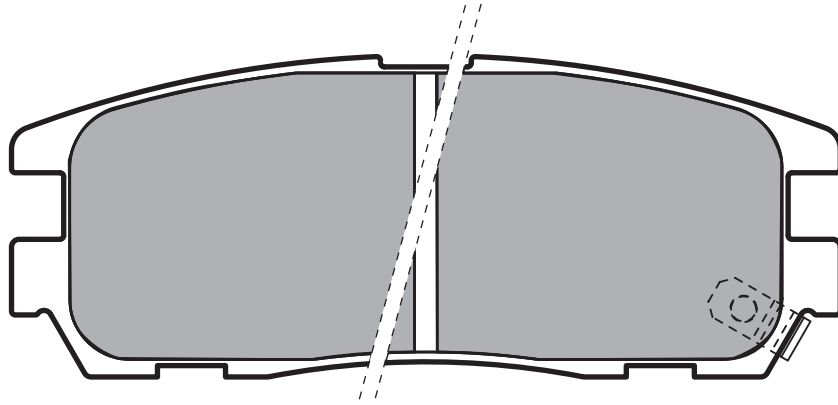

Valeo



2

Valeo



109,6



42,5



15,8



SUMITOMO



ISUZU, OPEL, VAUXHALL

598507

21880 (WVA)

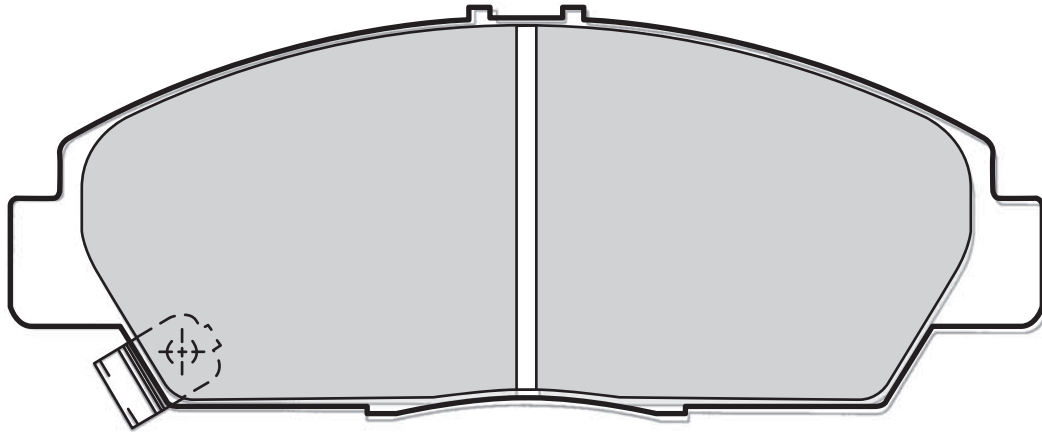

Valeo



2

Valeo



137,8



50,5



18,8



AKEBONO



HONDA, ROVER

598056

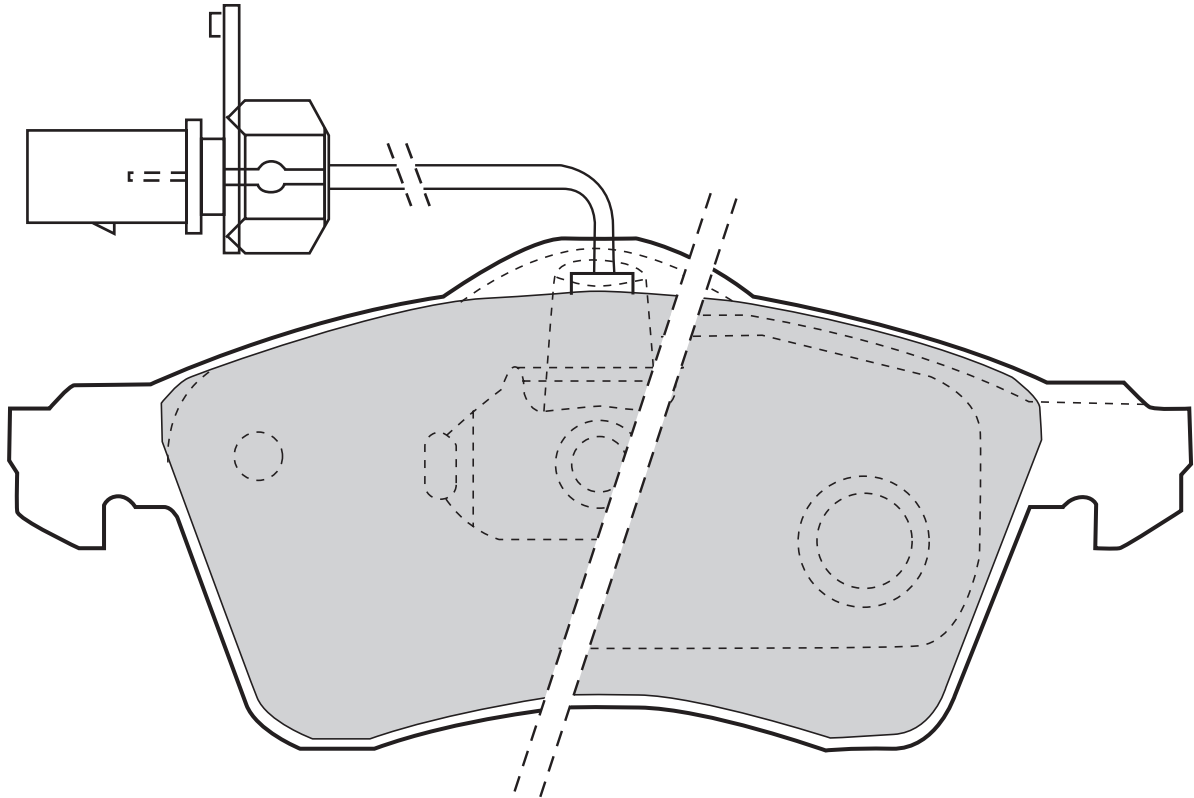

Valeo



Valeo



598675

0

156,4

68,5

19,5

TEVES

VOLKSWAGEN

598676

1 (A)

156,3

68,5

19,5

TEVES

VOLKSWAGEN



21892 (WVA)

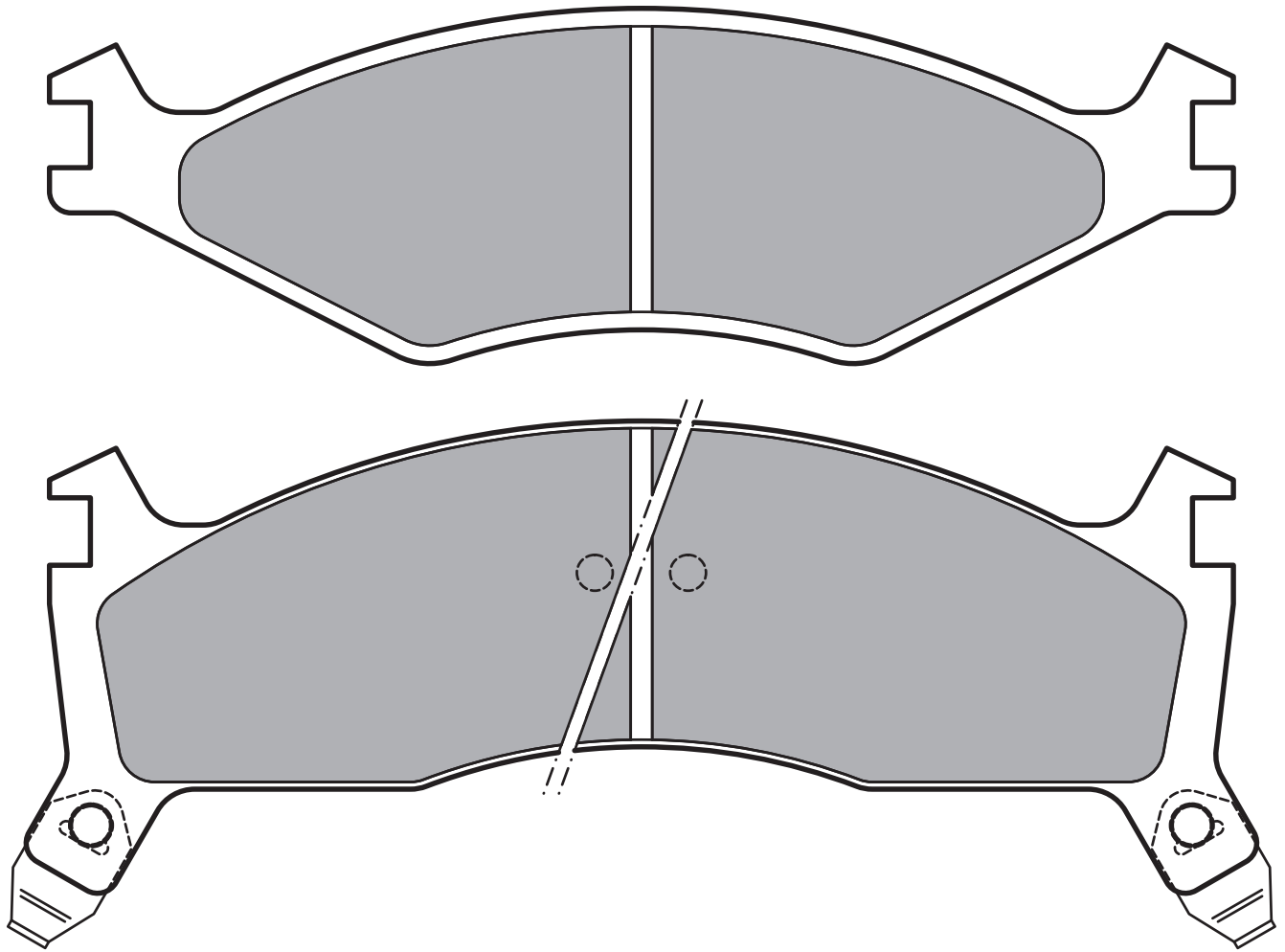

Valeo



Valeo



598838

2

171,5

49,6

17

KELSEY



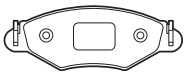



KIA

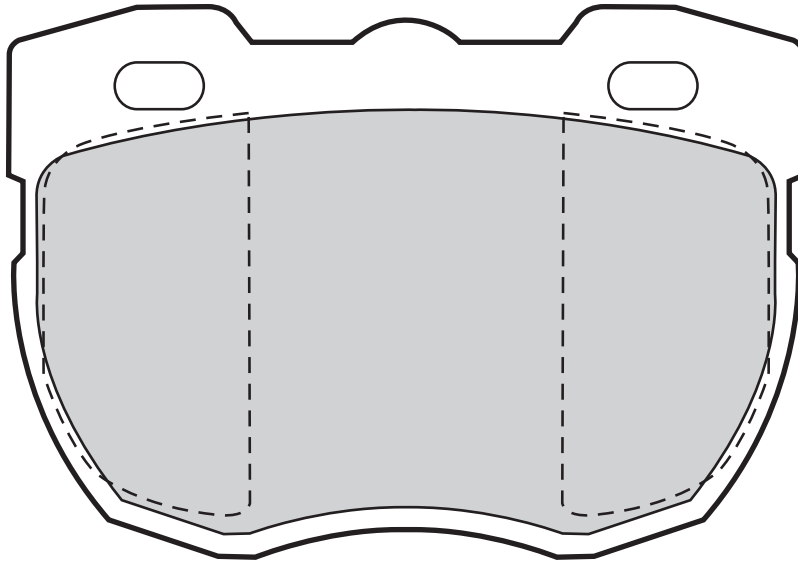

Valeo

21897 (WVA)







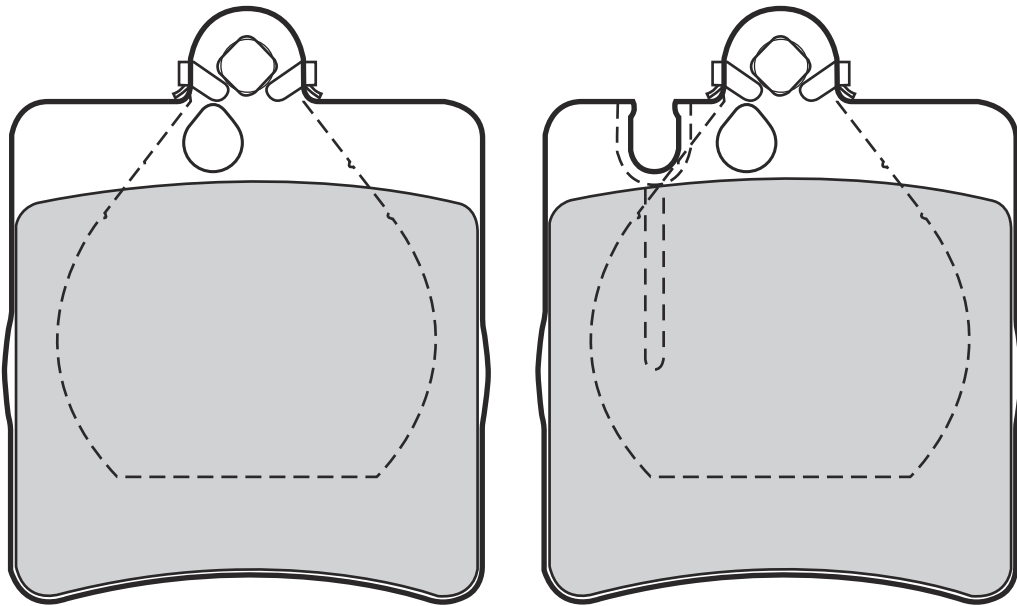

598498 1 105 72,5 18,5 AP LAND ROVER

21899 (WVA)



598447 0 63,7 78,2 15,3 TEVES MERCEDES

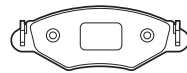

21900 (WVA)

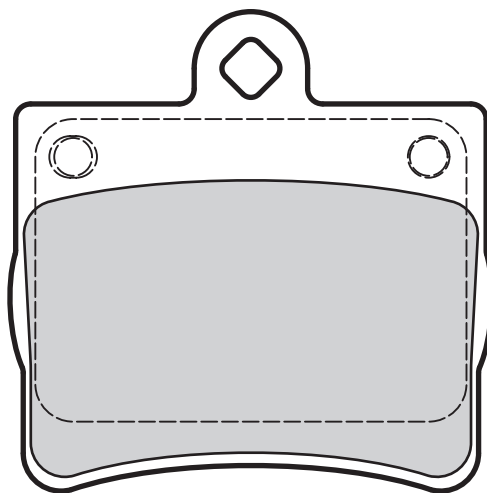

Valeo



0

Valeo



63,7



63,4



15,5



TEVES



MERCEDES

598763

21907 (WVA)

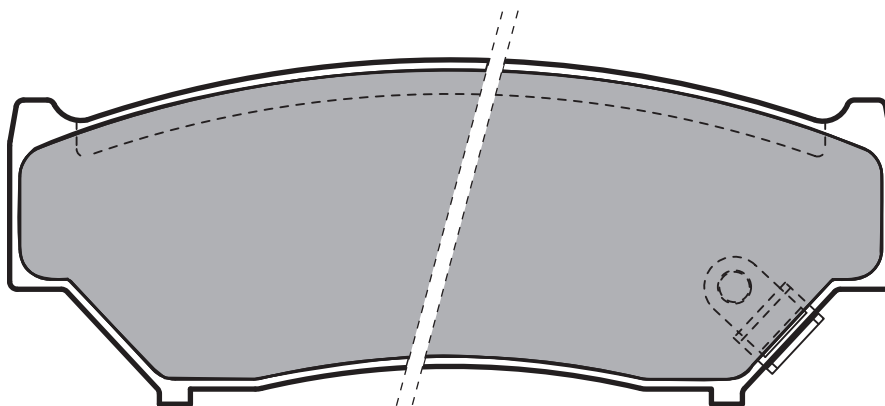

Valeo



2

Valeo



116,7



45,5



15,4



AKEBONO



SANTANA, SUZUKI

598533

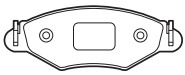

21910 (WVA)

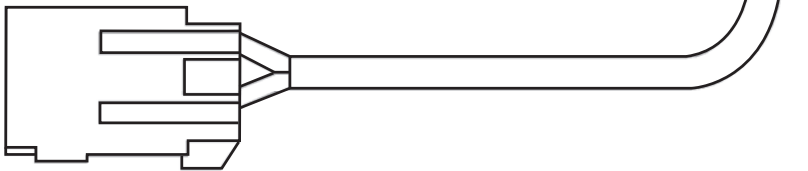
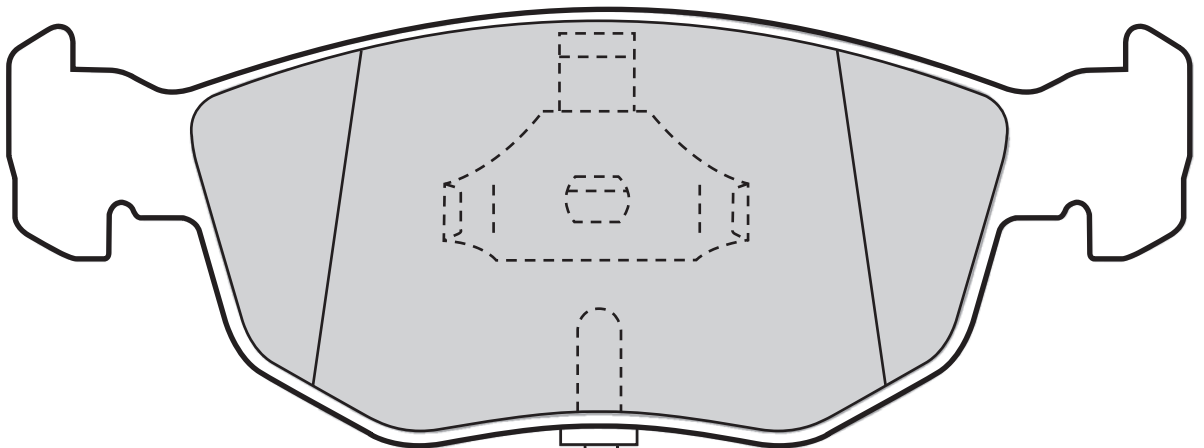
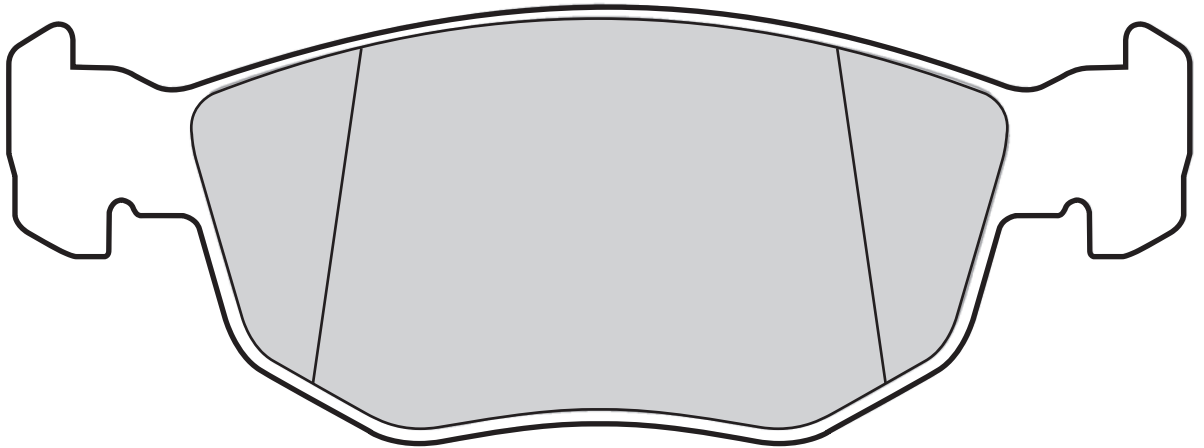

Valeo		Valeo								
598619	0		156,3	60,6	19,8	TEVES		FORD		
598630	2	220	156,3	60,6	19,8	TEVES		FORD		

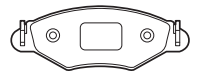

21911 (WVA)

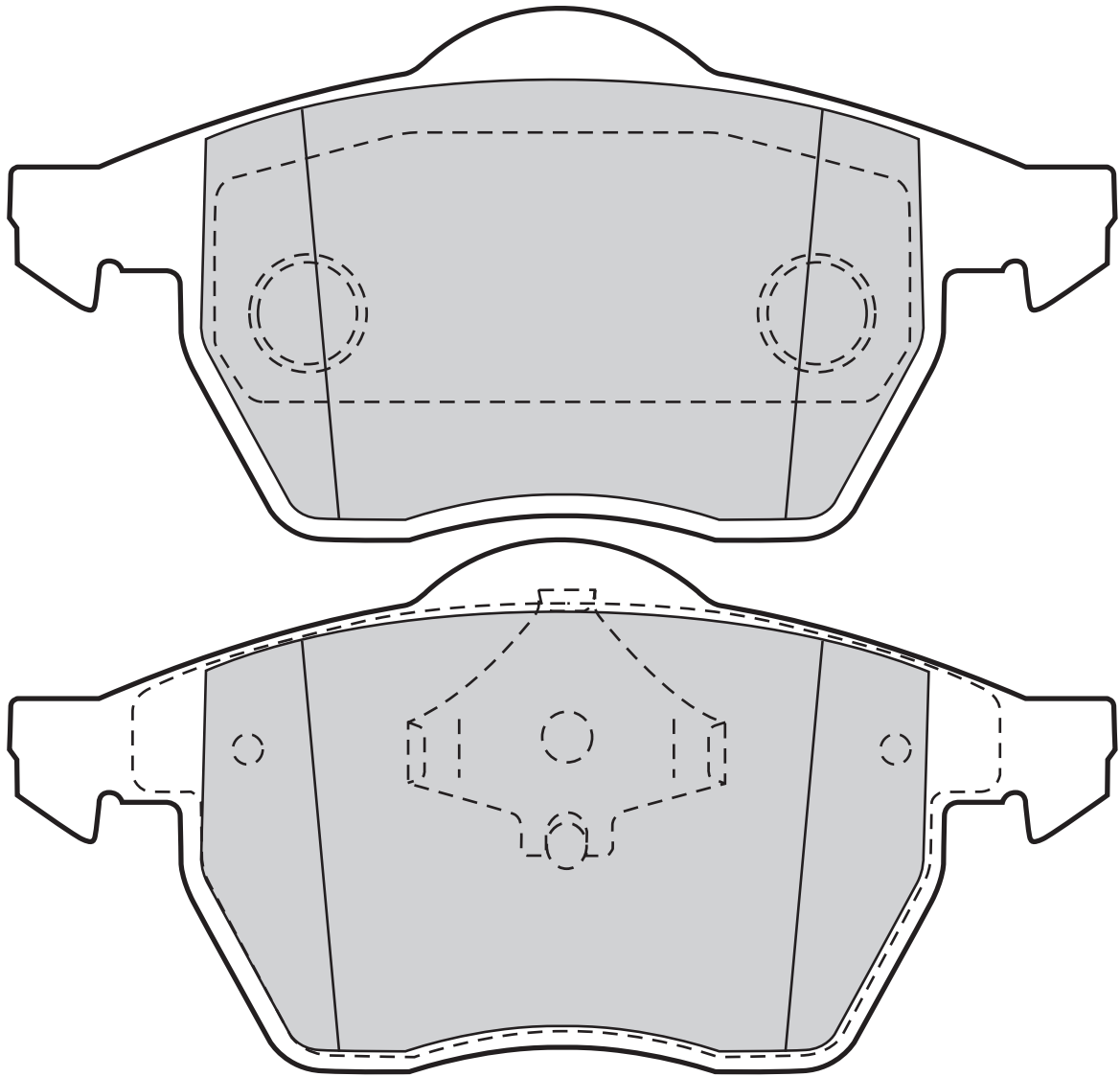

Valeo



Valeo



598303	0		156,3	74	19,8	TEVES	AUDI, SEAT, SKODA, VOLKSWAGEN
598355	0		156,3	74	19,8	TEVES	AUDI, VOLKSWAGEN
598481	0		156,4	74,2	18,8	TEVES	VOLVO
598486	1	155	156,4	74,2	20,3	TEVES	AUDI, SEAT, SKODA, VOLKSWAGEN



21919 (WVA)

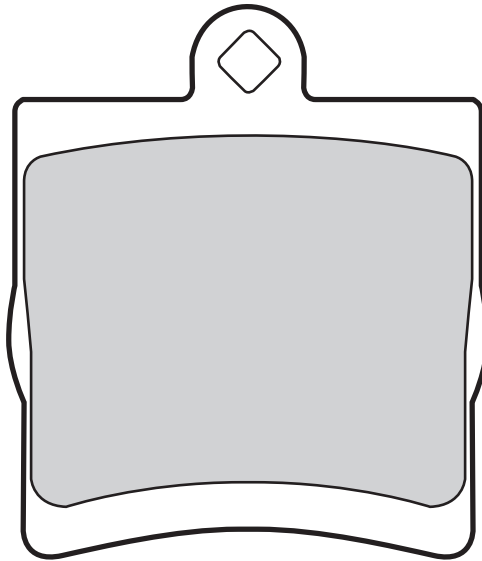

598444	0	63,7	73	15,3	TEVES	CHRYSLER, MERCEDES		

21920 (WVA)

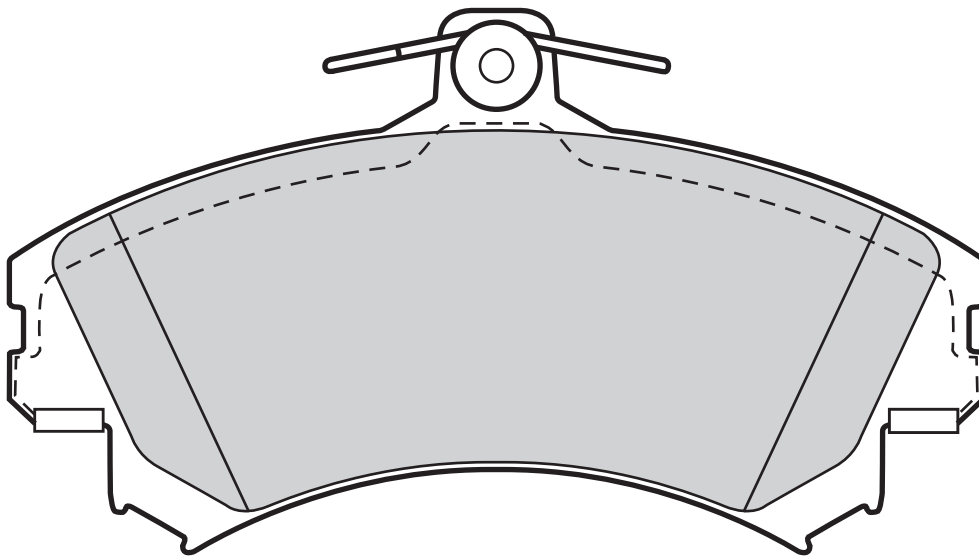

598318	2	130	72,6	15,1	LUCAS	MITSUBISHI, SMART MCC, VOLVO	



21927 (WVA)

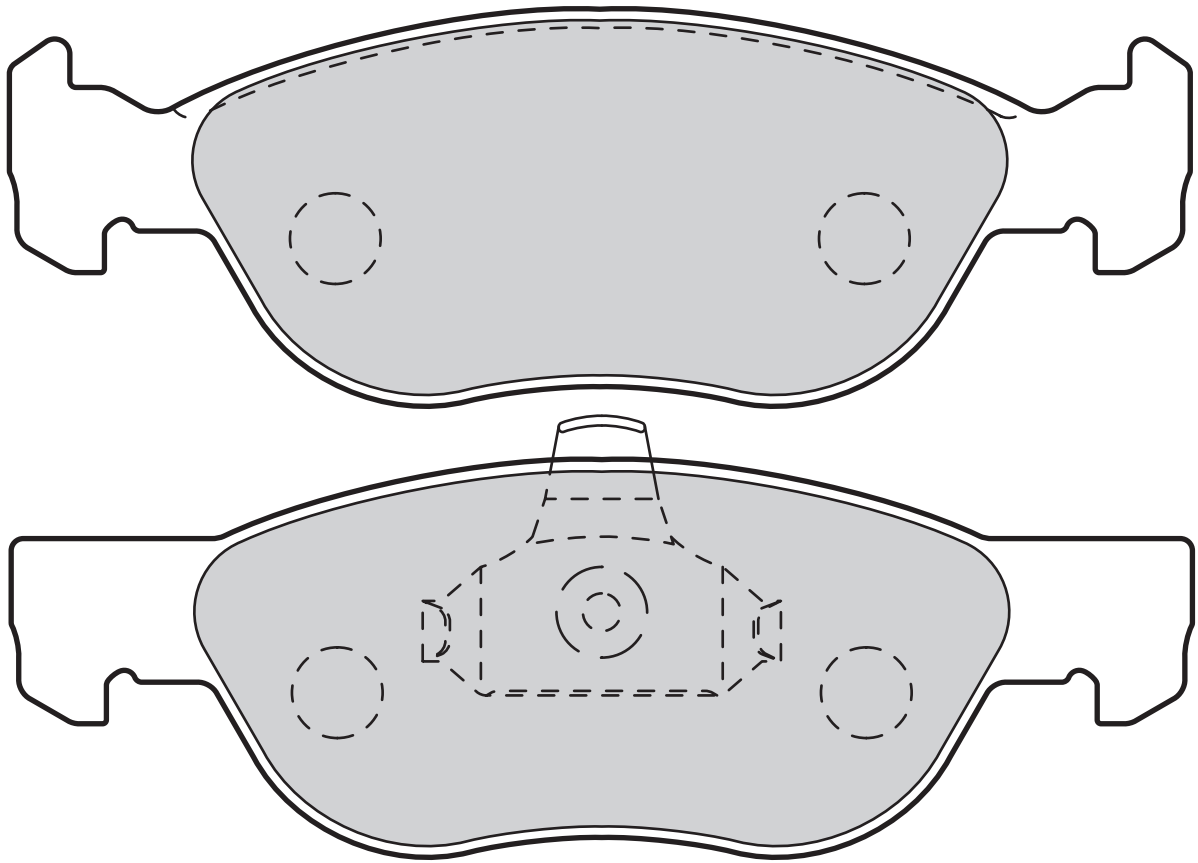

Valeo



Valeo



598041
601003

2 (A+B)
0

200

156,5
156,4

52,5
52,5

17,6
17,9

TEVES
TEVES

FIAT, LANCIA
FIAT



21930 (WVA)

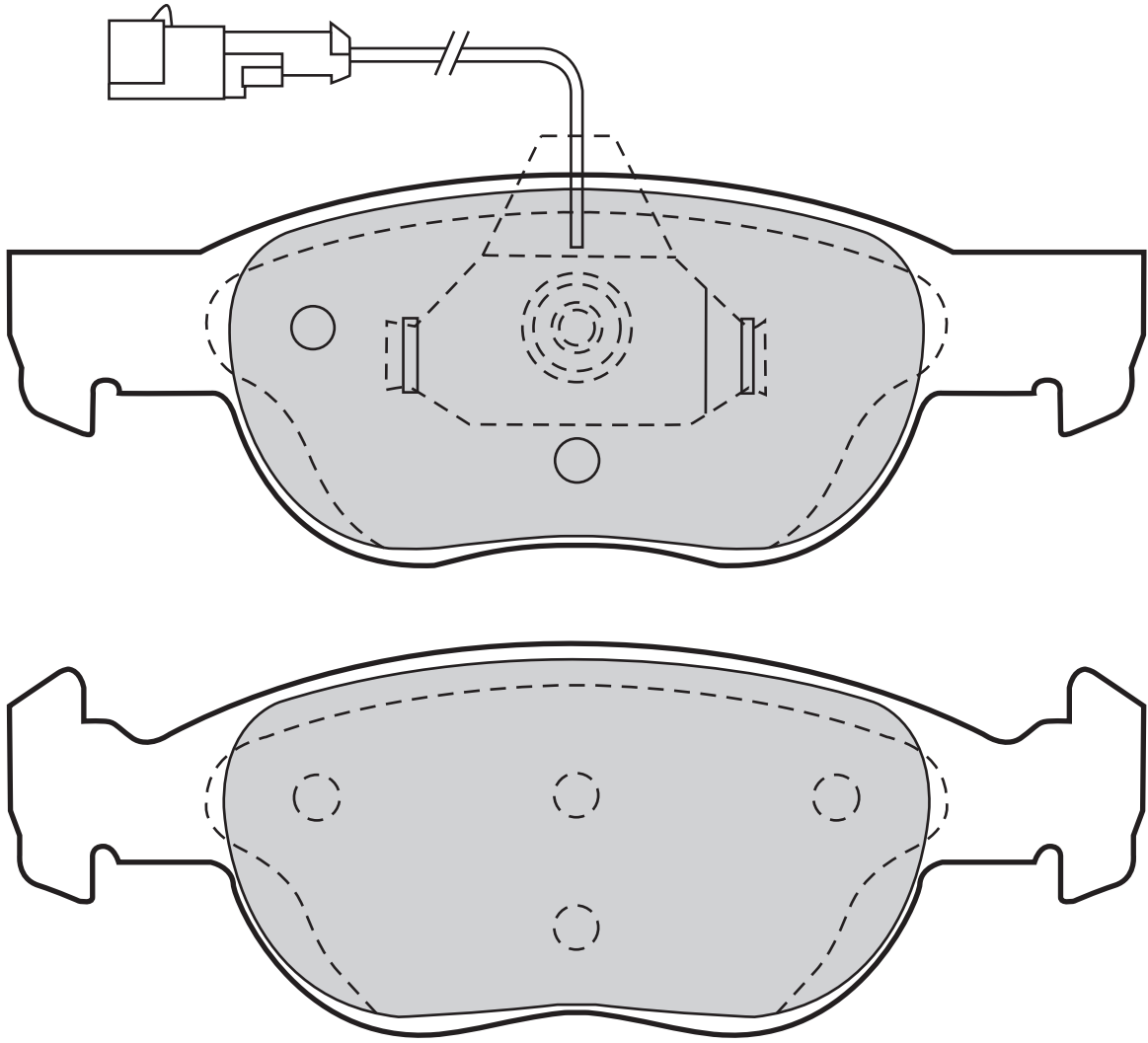

Valeo



Valeo



598040
598605
598607

1
0
0

200

151,5
151,3
151,3

52,5
52
52

17,4
17,9
17,9

TEVES
TEVES
TEVES

ALFA ROMEO, FIAT, LANCIA
FIAT, LANCIA
FIAT

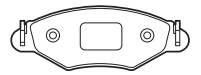

21934 (WVA)

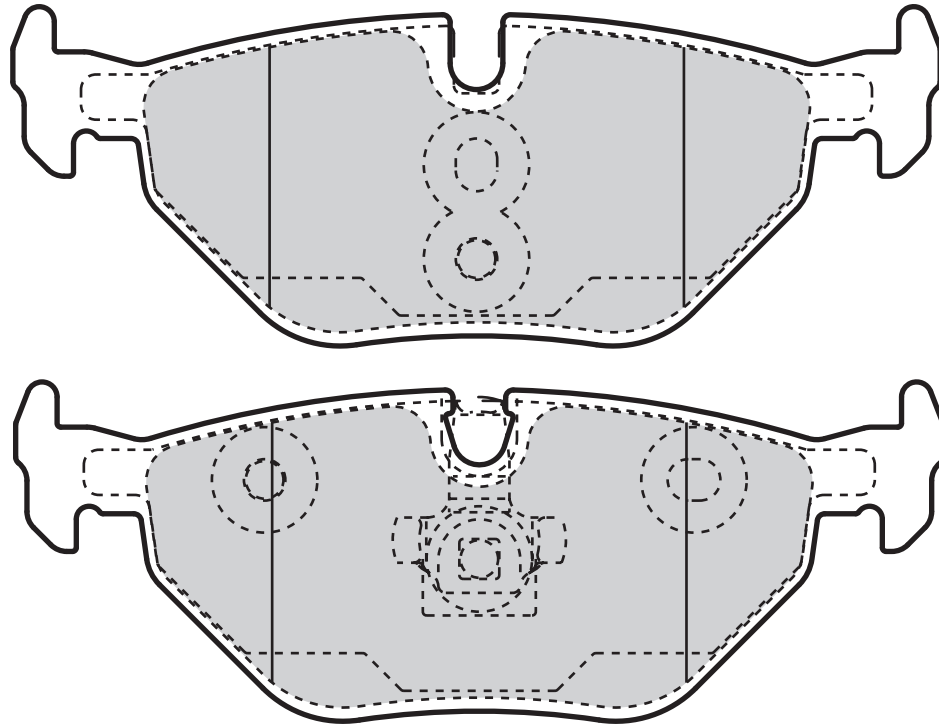

Valeo



0

Valeo



123



45



17



TEVES



BMW, MG, ROVER, SAAB

598753

21937 (WVA)

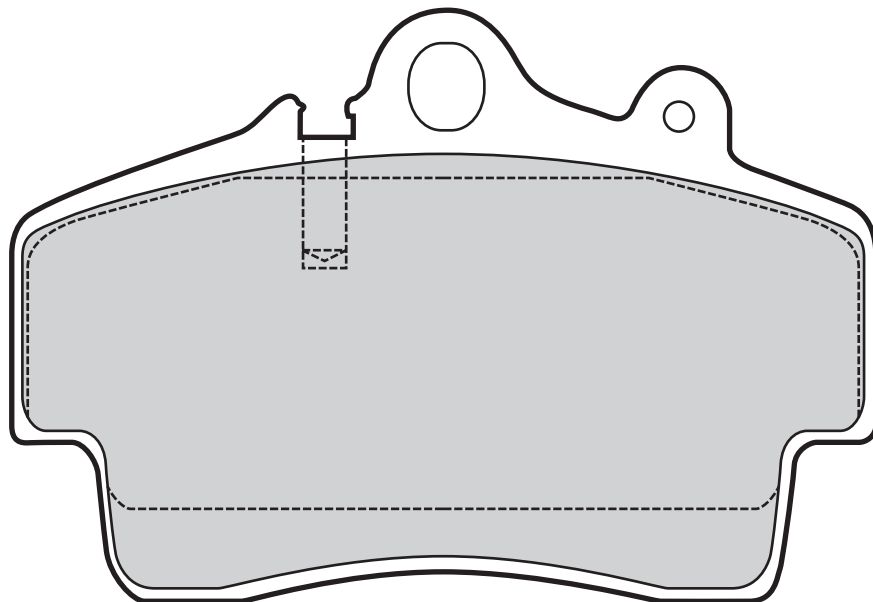

Valeo



0

Valeo



114



78



16



BREMBO



PORSCHE

598766

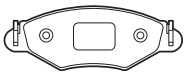

21945 (WVA)

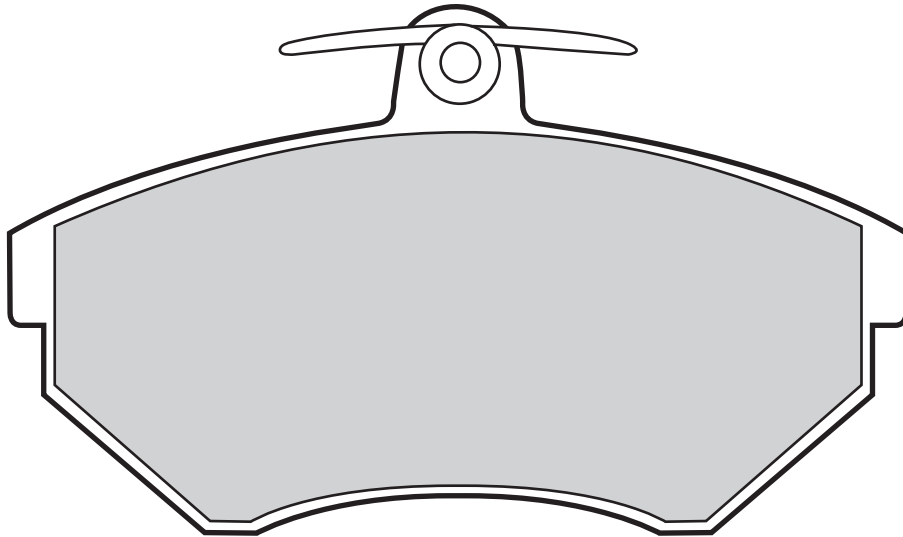

598330	0	119	69,5	16,3	LUCAS	SEAT, VOLKSWAGEN			

21947 (WVA)

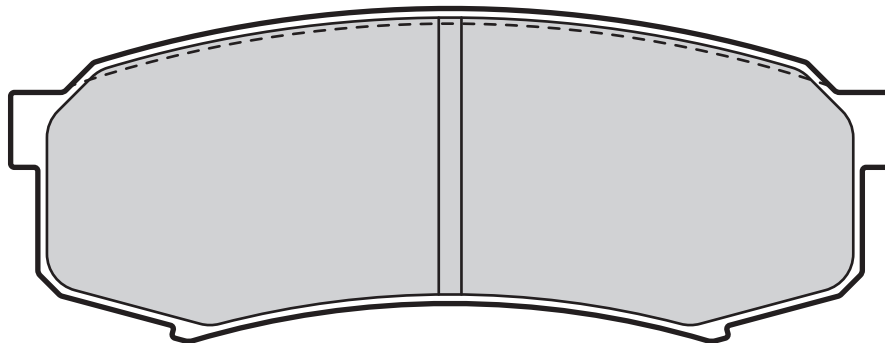

598777	0	116,2	44	15,2	SUMITOMO	MITSUBISHI, TOYOTA			

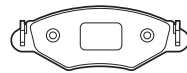

21948 (WVA)

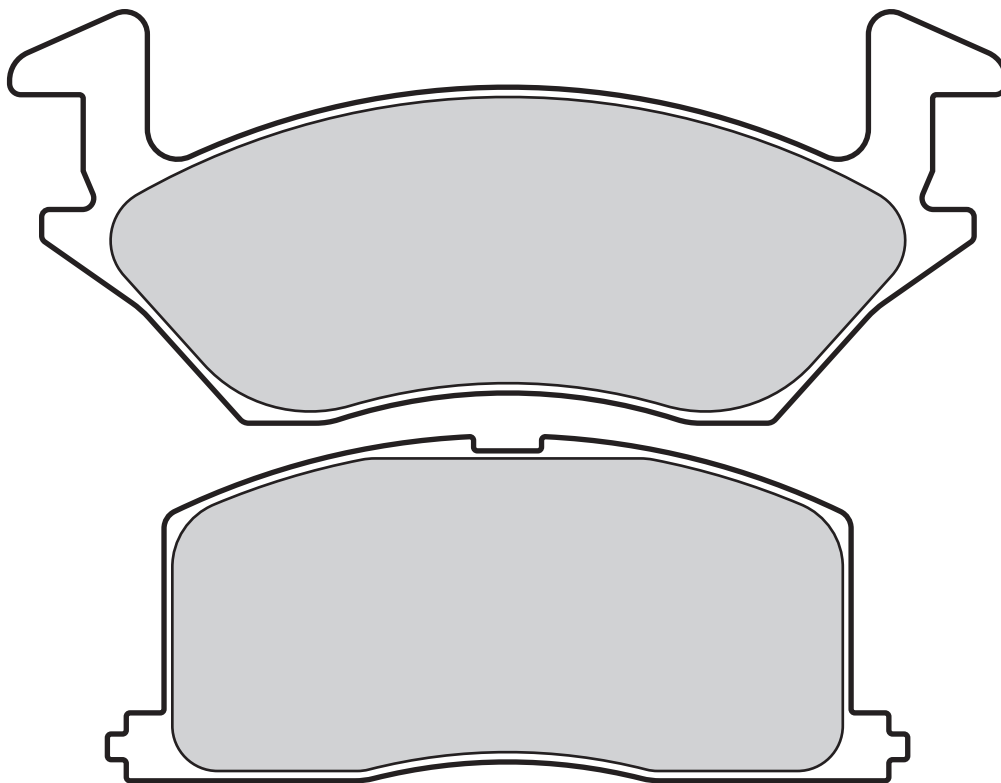

598815	2		131,8	45,8	13,6	AKEBONO				TOYOTA

21952 (WVA)

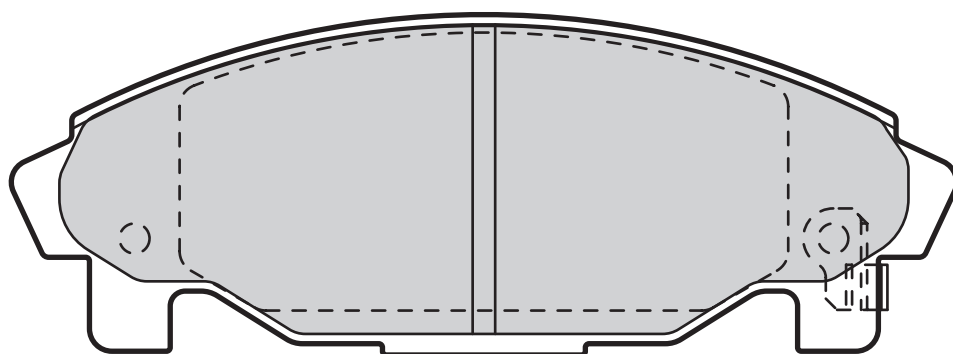

598850	2		125,5	45,3	15,6	AKEBONO				DAIHATSU

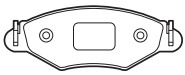

Valeo

21961 (WVA)

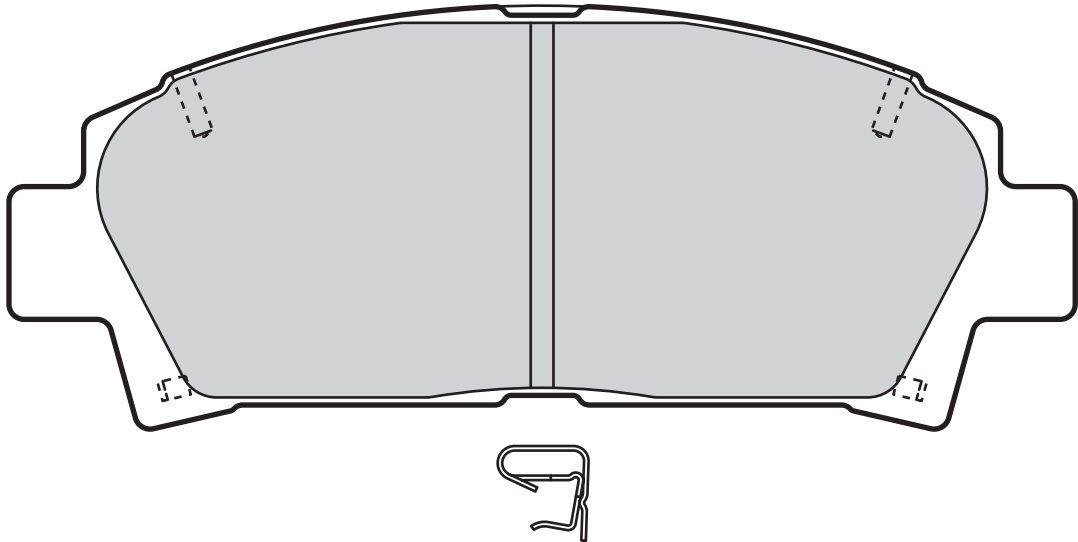

Valeo



Valeo



598541

2

141

56,5

15,5

SUMITOMO
AKEBONO

TOYOTA
TOYOTA

598809

0

140,7

55,9

15,5

21965 (WVA)

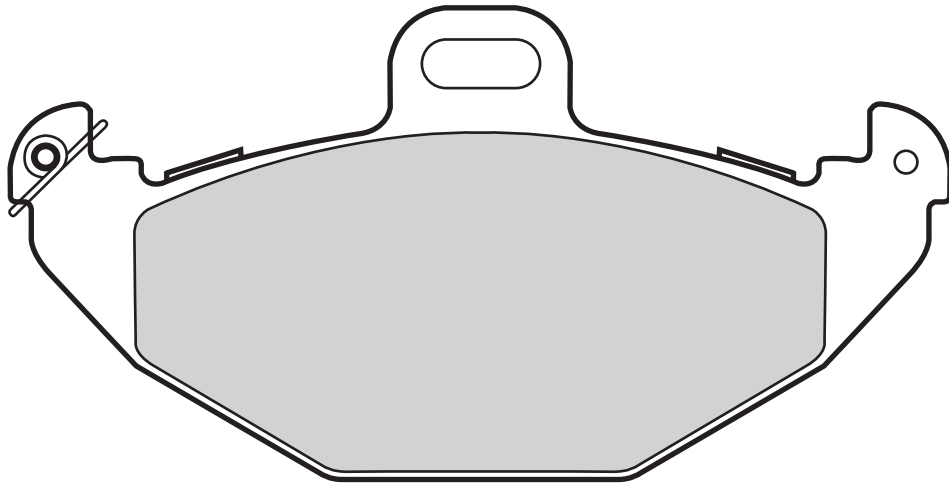

Valeo



Valeo



598328

0

126

63

14,5

BREMBO

RENAULT

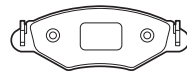

21969 (WVA)

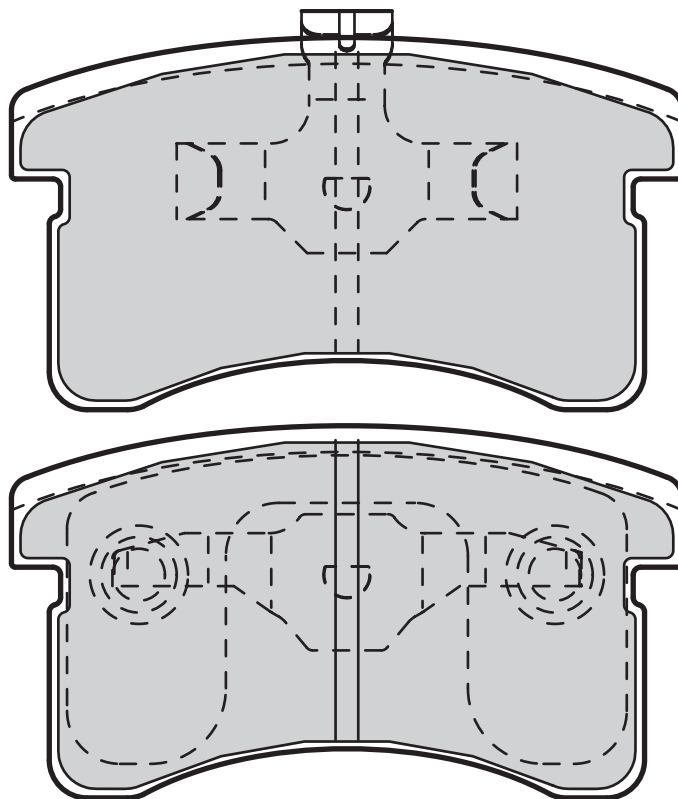

Valeo



Valeo



601024

0

88,7

49,2

14

SUMITOMO

DAIHATSU



21974 (WVA)

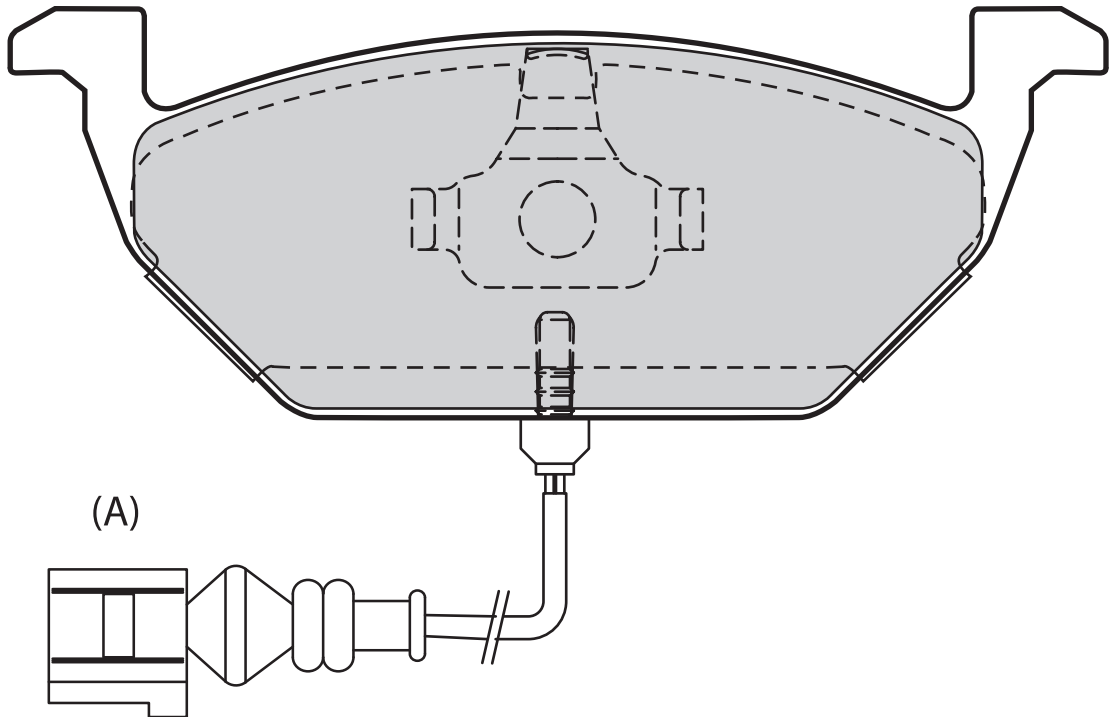

Valeo		Valeo					
598332	0		146	54,7	19,8	TEVES	AUDI, SEAT, SKODA, VOLKSWAGEN
598408	1	155	146	54,7	19,3	TEVES	AUDI, SEAT, SKODA, VOLKSWAGEN

21976 (WVA)

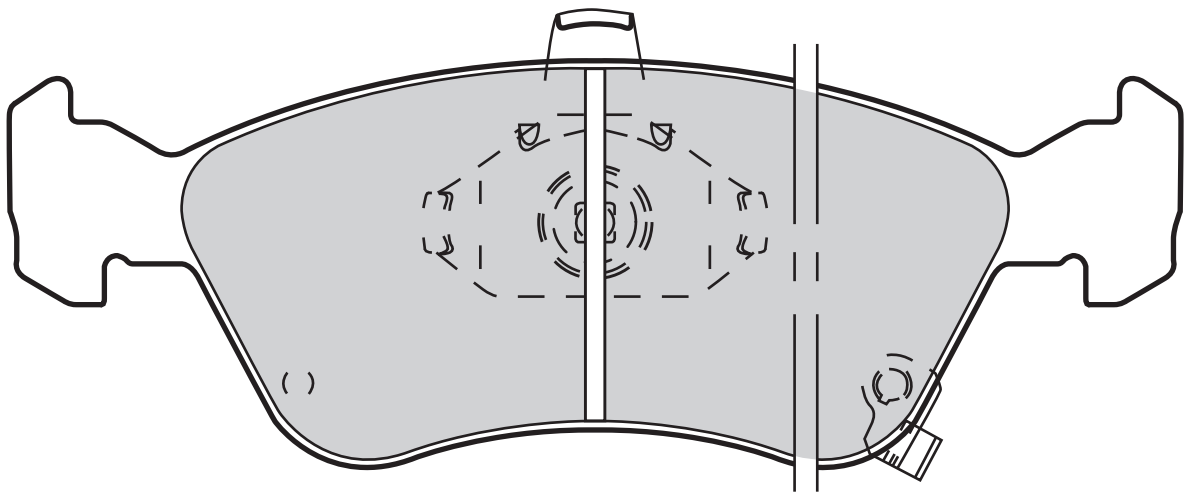

Valeo		Valeo					
598478	2		156,4	54,8	18,2	TEVES	TOYOTA



21980 (WVA)

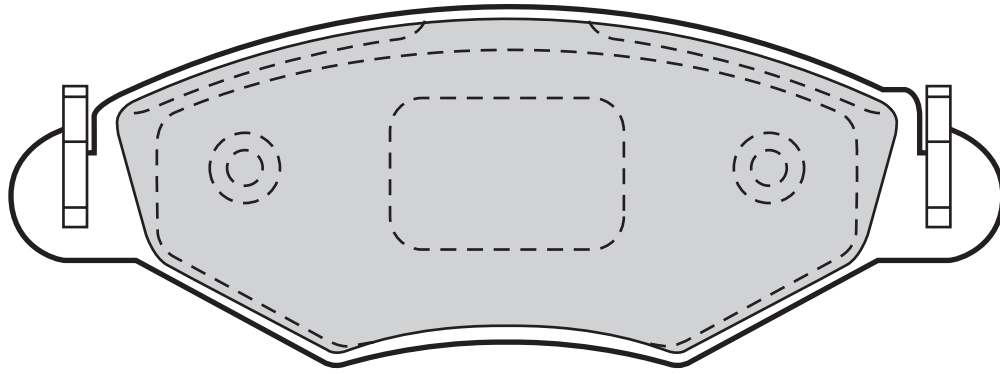

Valeo



Valeo



598461
598726

0 (A)
1

131
130,8

47,5
47,4

18
18

BOSCH
BOSCH

CITROËN, PEUGEOT
NISSAN, RENAULT

21983 (WVA)

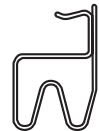
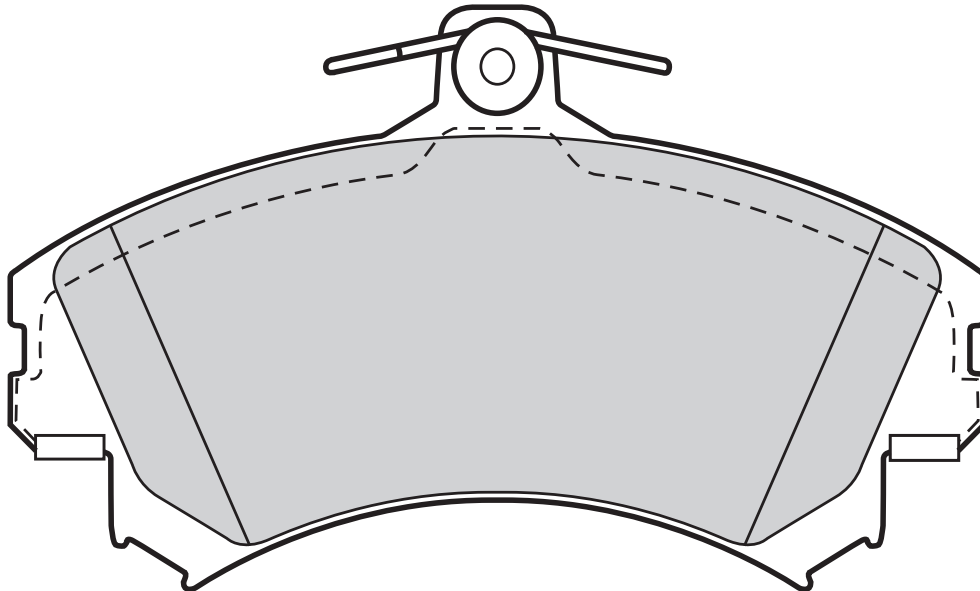

Valeo



Valeo



598493

0

130

77

17

LUCAS

MITSUBISHI, SMART MCC, VOLVO

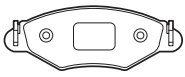

21999 (WVA)

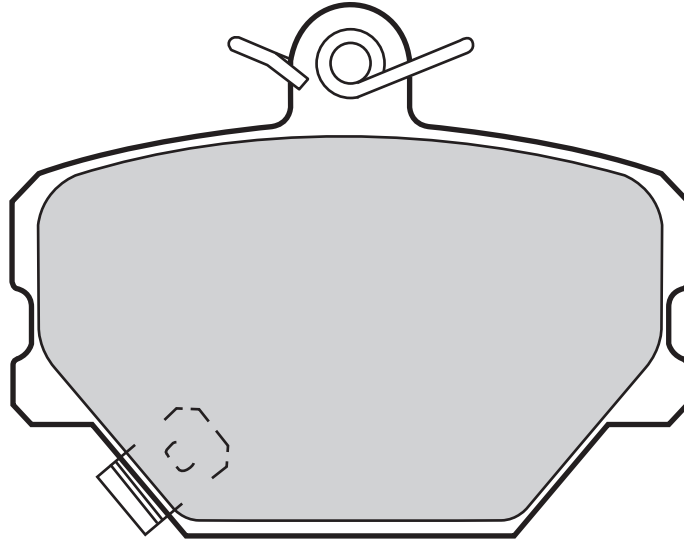

598329	2		90	70,1	15,3		BOSCH	SMART MCC	

23004 (WVA)

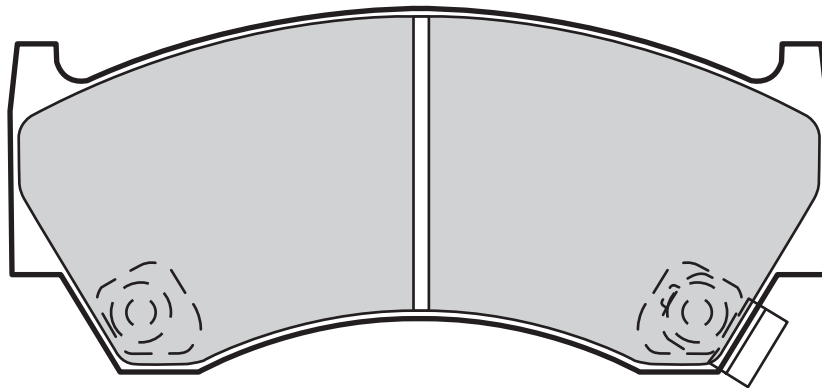

598071	2		108,7	47,8	16		AKEBONO	NISSAN	

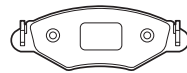

23020 (WVA)

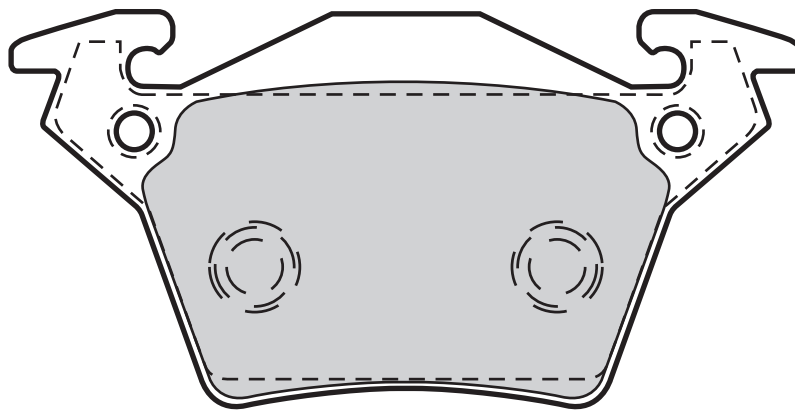

598301

0

105

52,9

17,9

BOSCH

MERCEDES

23021 (WVA)

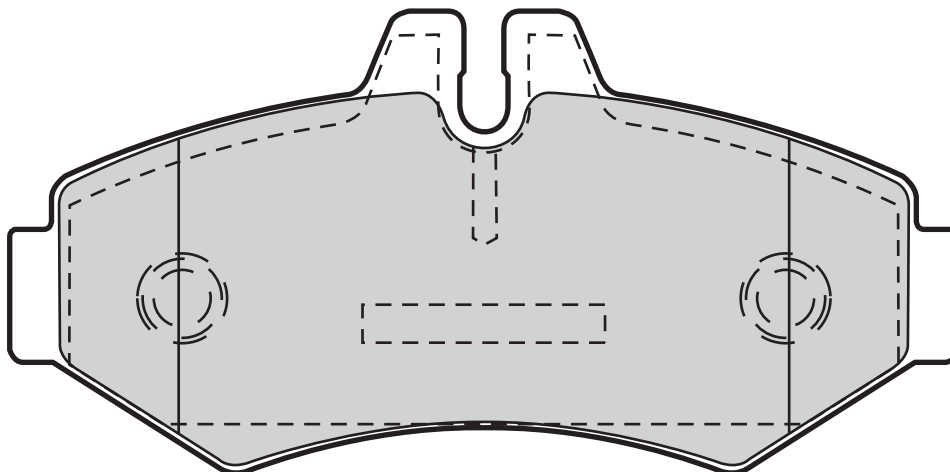

598300

0

125,7

61,8

18,4

BOSCH

MERCEDES, VOLKSWAGEN



Valeo

23022 (WVA)

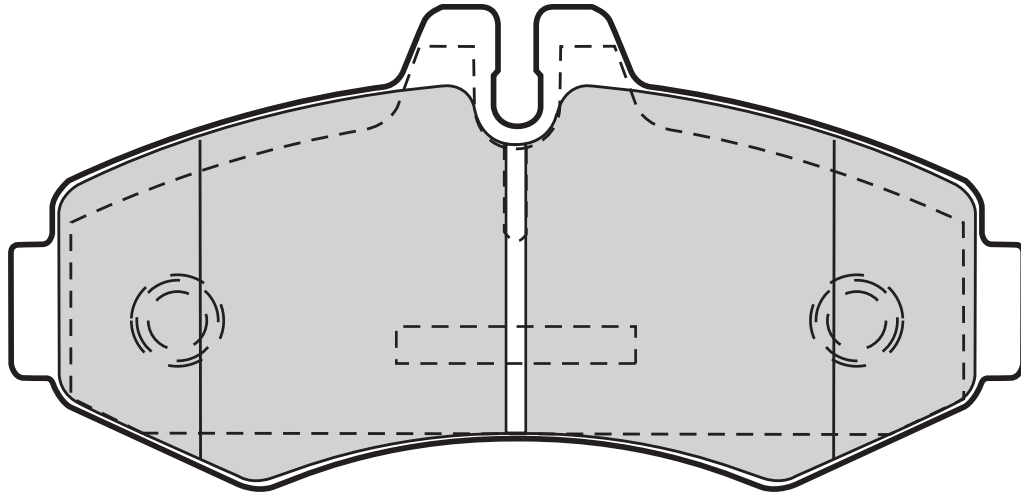

Valeo



Valeo



598299

0

134,3

64,3

20,4

BOSCH

MERCEDES

23023 (WVA)

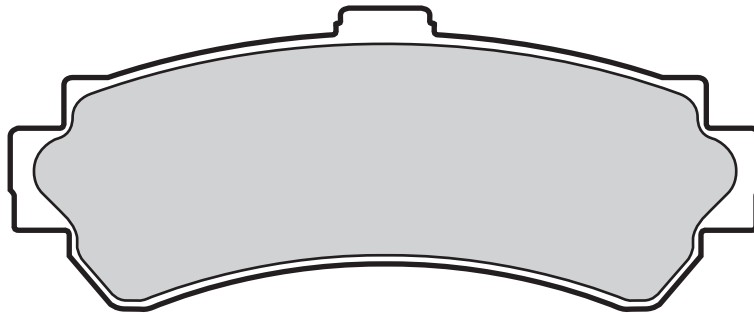

Valeo



Valeo



598449

2

99,5

40

15

AKEBONO

NISSAN



23034 (WVA)

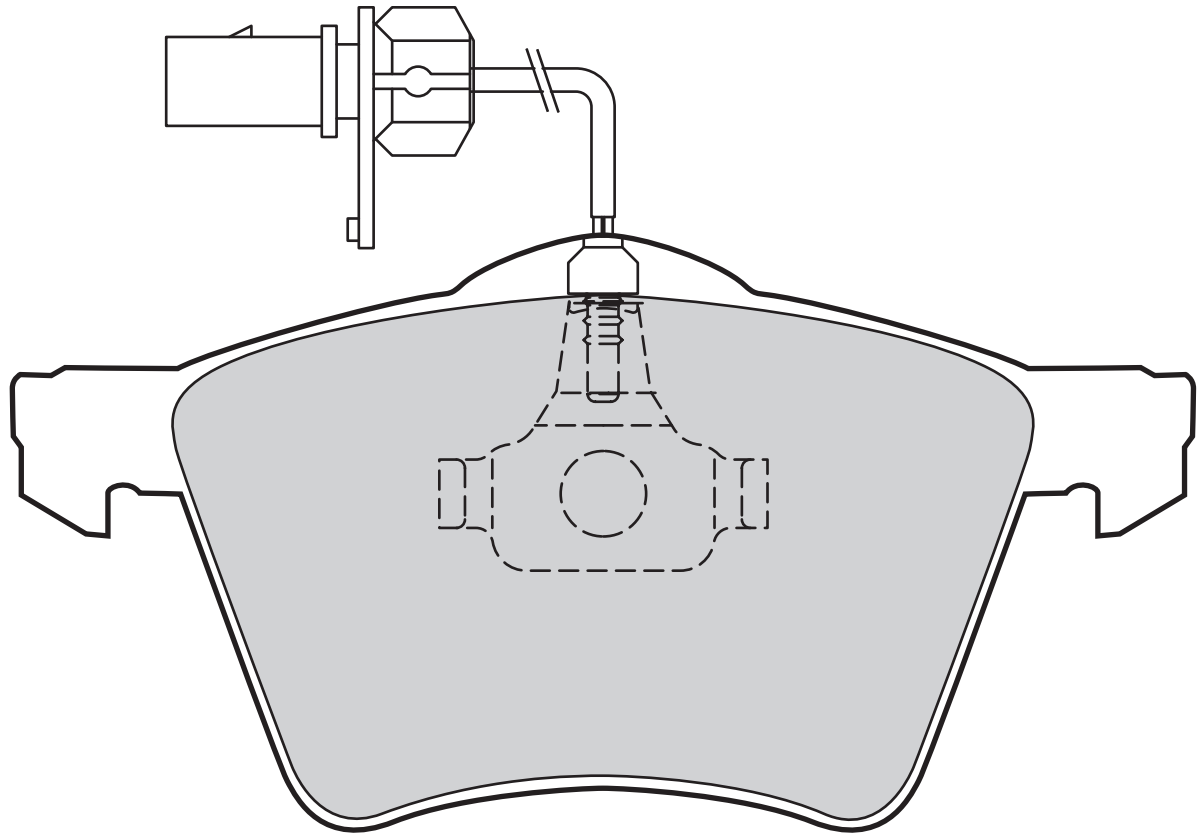

Valeo



Valeo



598801
598858

2
1

280
210

156,2
156,2

78,4
78,4

19,6
19,6

TEVES
TEVES

FORD, SEAT, VOLKSWAGEN
VOLKSWAGEN

23042 (WVA)

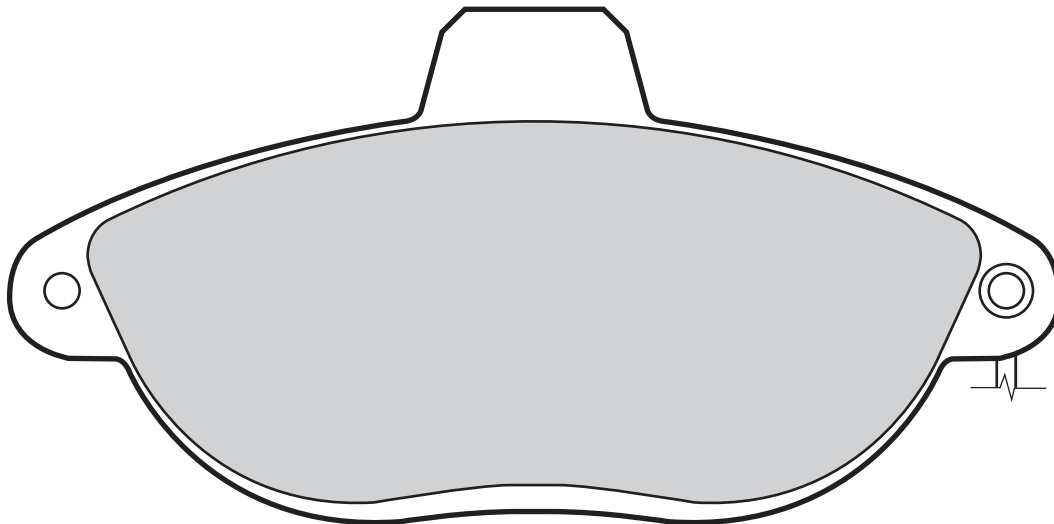

Valeo



Valeo



598073

2

280

140

68,7

18,5

BENDIX

CITROËN, FIAT, PEUGEOT



23043 (WVA)

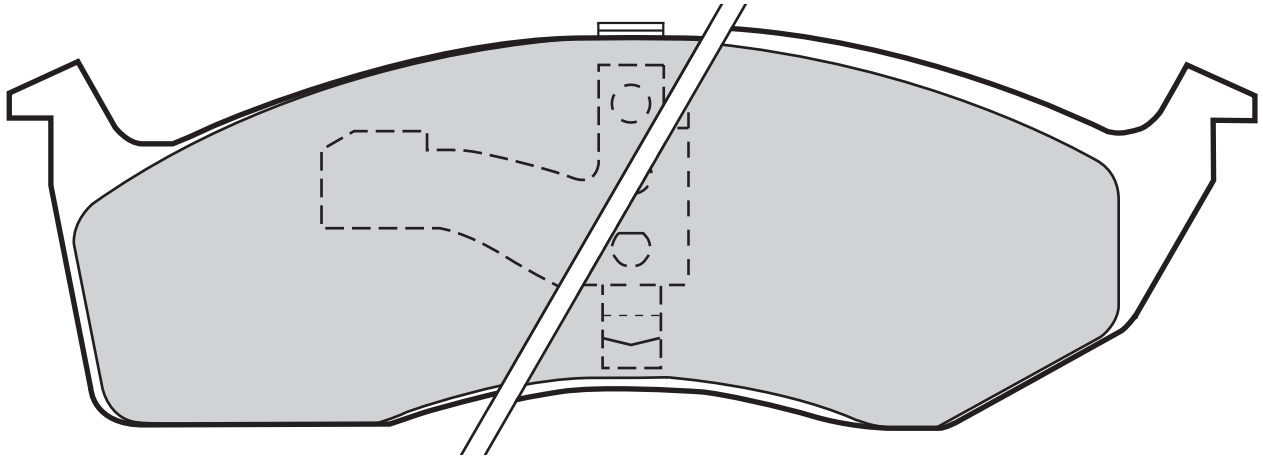

598556

0

164,1

51,6

19

KELSEY

CHRYSLER

23046 (WVA)

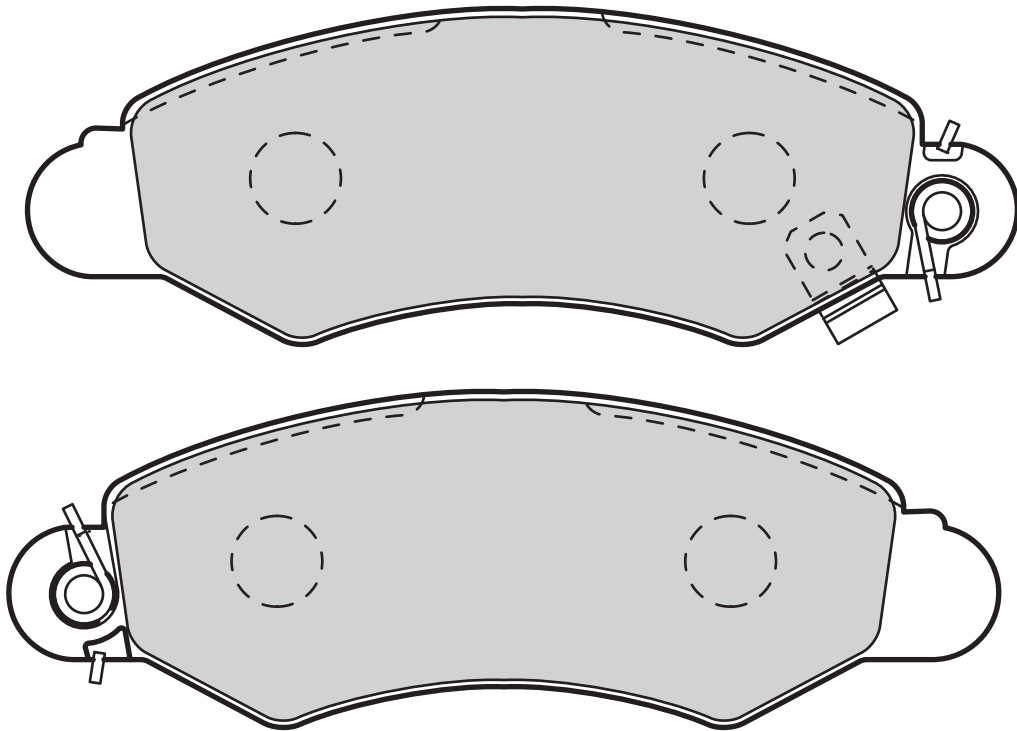

598991

1

Leaf

130,9

44,4

15,5

BOSCH

SUBARU, SUZUKI

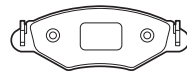

23062 (WVA)

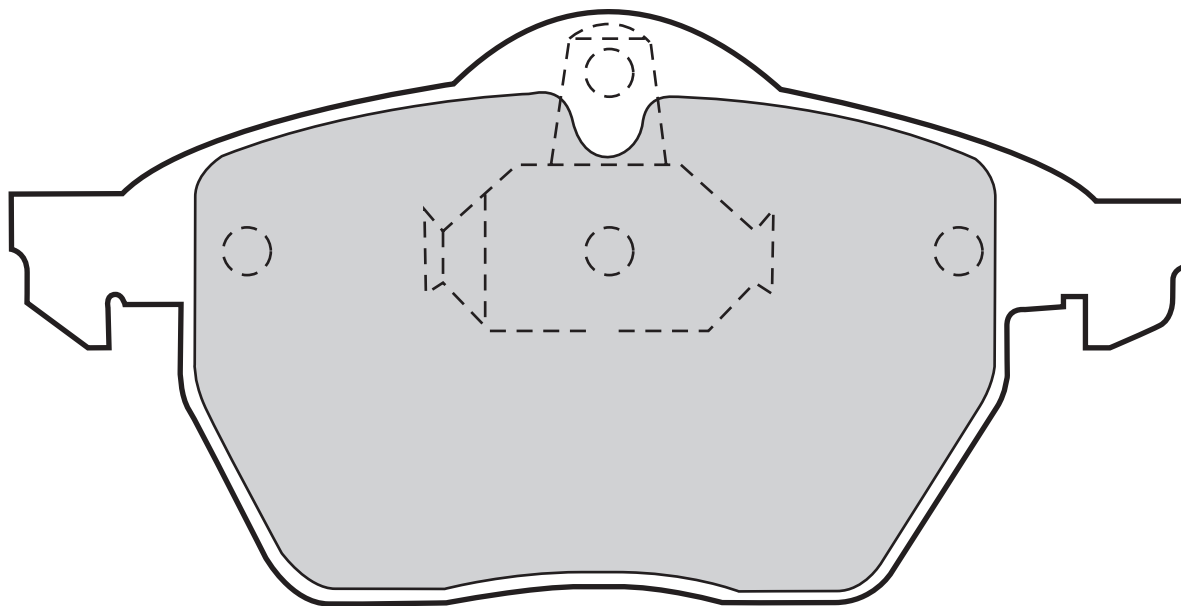

598454

2

Leaf

156,4

71,6

20

TEVES

OPEL, VAUXHALL

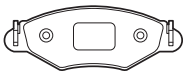

Valeo

23063 (WVA)

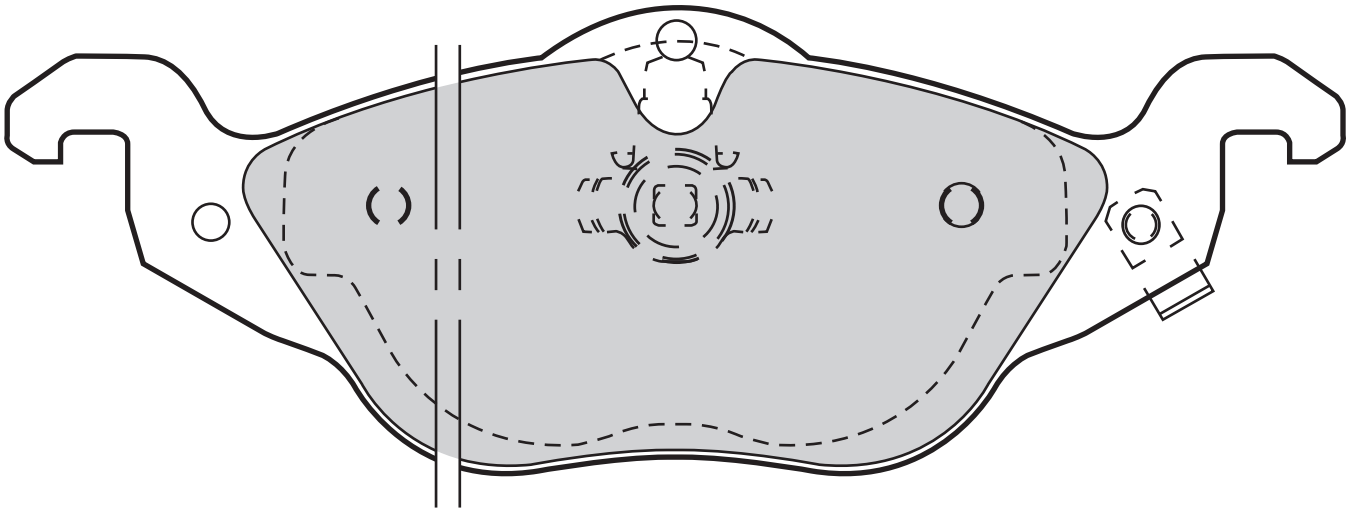
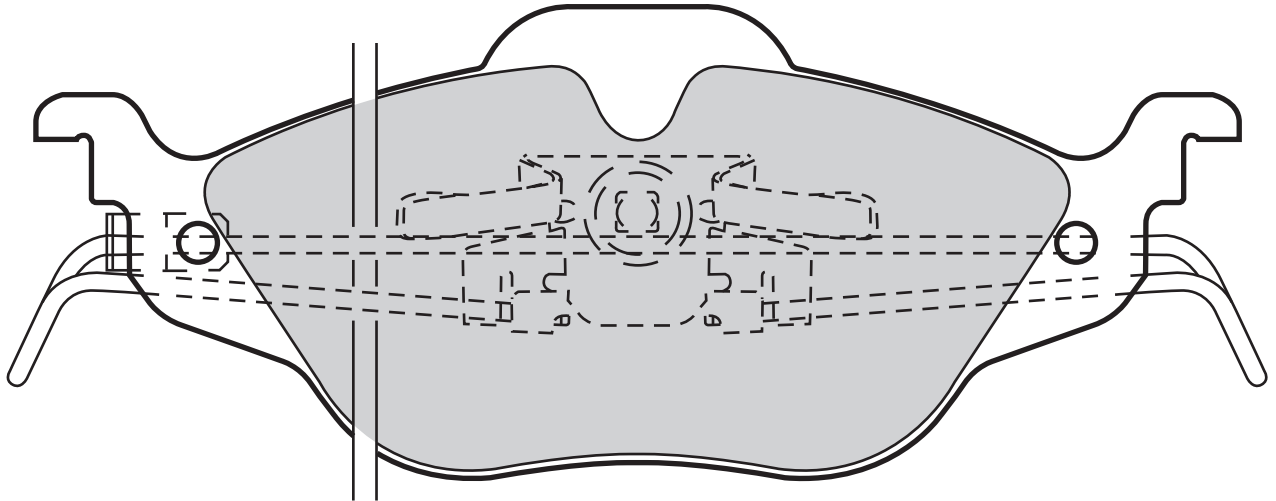

Valeo



Valeo



598322

4

160/177,6

62,2

18

TEVES

OPEL, VAUXHALL

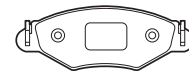

23070 (WVA)

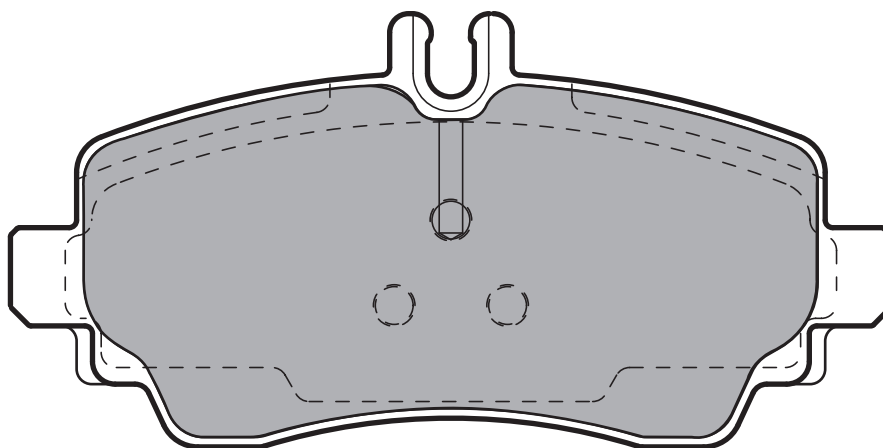

Valeo									
598549	0		116,5	57,3	17	LUCAS	MERCEDES		
598582	0		116,5	57,2	19	LUCAS	MERCEDES		

23072 (WVA)

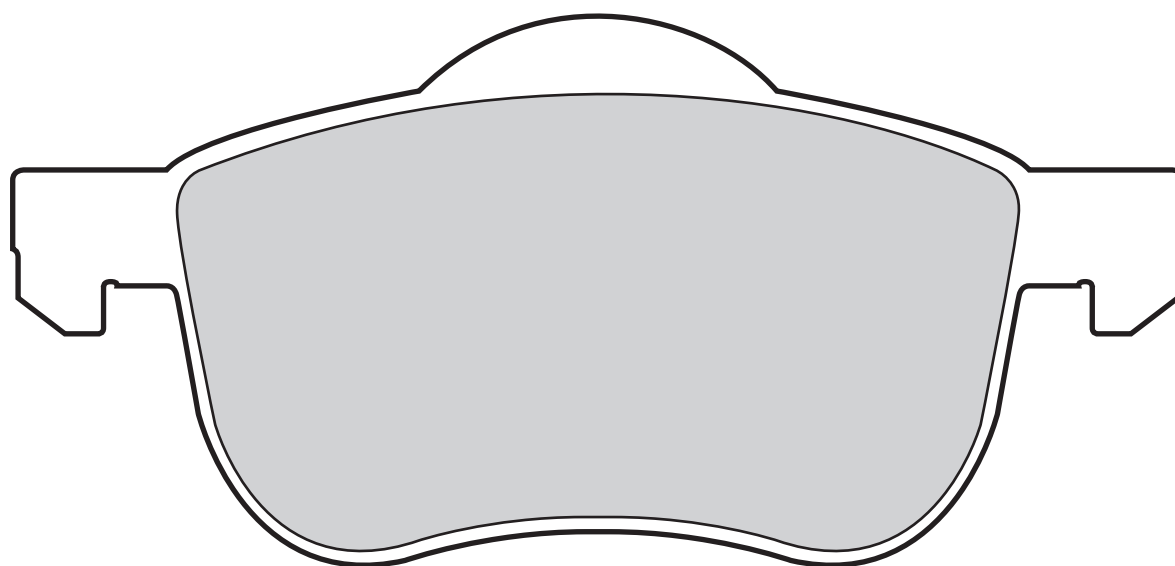

Valeo									
598479	0		155,4	69/72,5	18,5	TEVES	VOLVO		



Valeo

23075 (WVA)

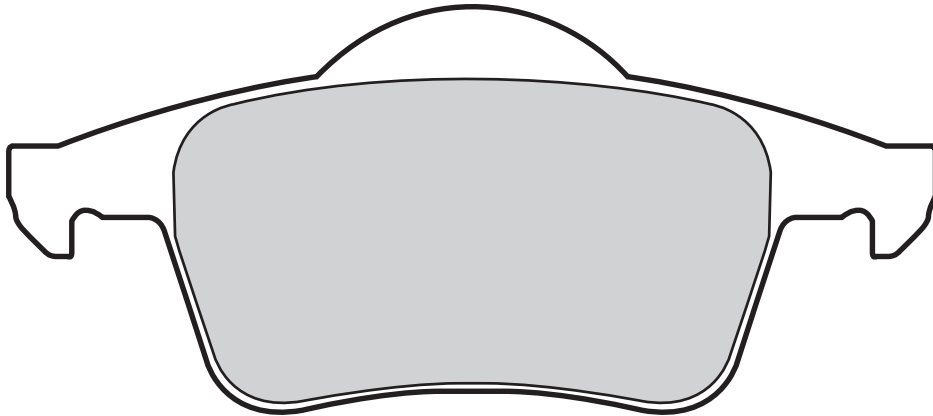

Valeo



0

Valeo



122,6



53,8



17



TEVES



VOLVO

598480

23078 (WVA)

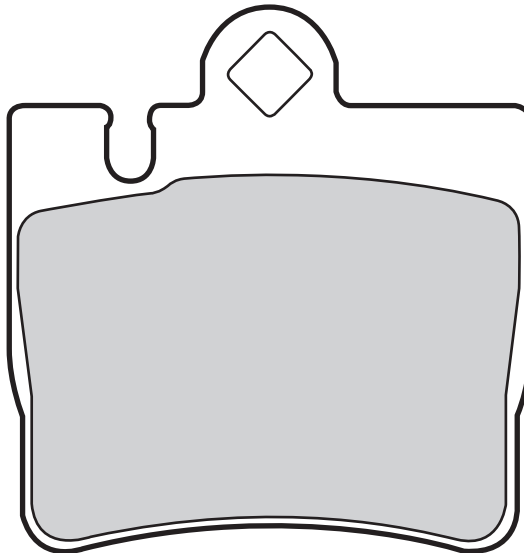

Valeo



0

Valeo



69



72



16



TEVES



MERCEDES

598446



23080 (WVA)

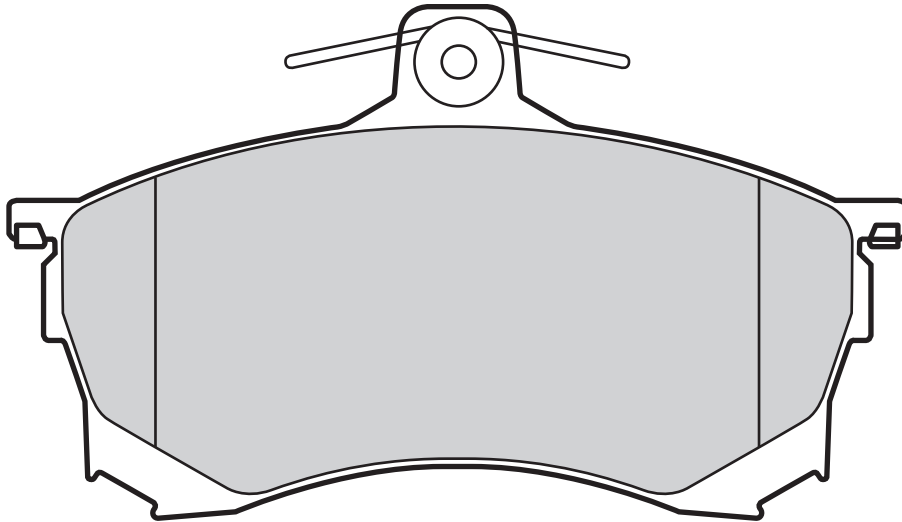

Valeo



Valeo



598320

2

119,2

68,5

15,8

LUCAS

MITSUBISHI

23081 (WVA)

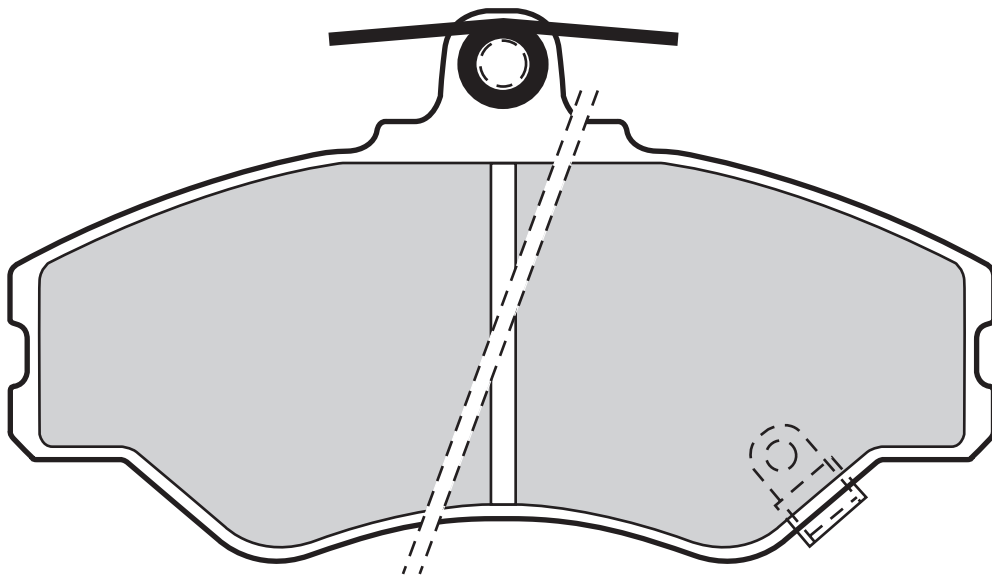

Valeo



Valeo



598634

2

130

73

18,1

LUCAS

HYUNDAI



23092 (WVA)

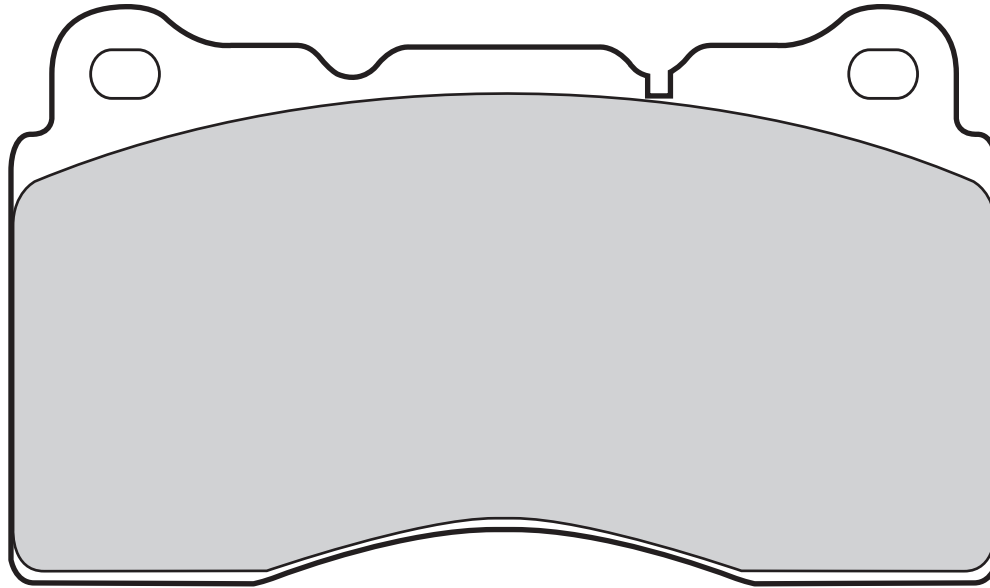

Valeo



Valeo



598468

4

295

131,8

77,3

15,8

BREMBO

CITROËN, FIAT, LANCIA, PEUGEOT

598772

2

170

131,8

77,3

15,8

BREMBO

ALFA ROMEO, LANCIA

598919

1

Leaf

131,7

77

16

BREMBO

MINI, MITSUBISHI, SUBARU

23093 (WVA)

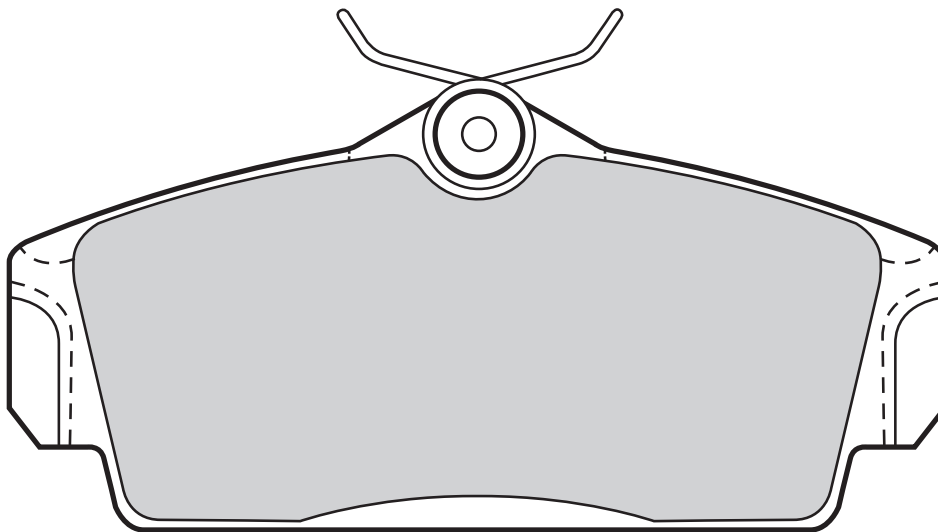

Valeo



Valeo



598450

0

124,2

57,3

16,6

LUCAS

NISSAN



23095 (WVA)

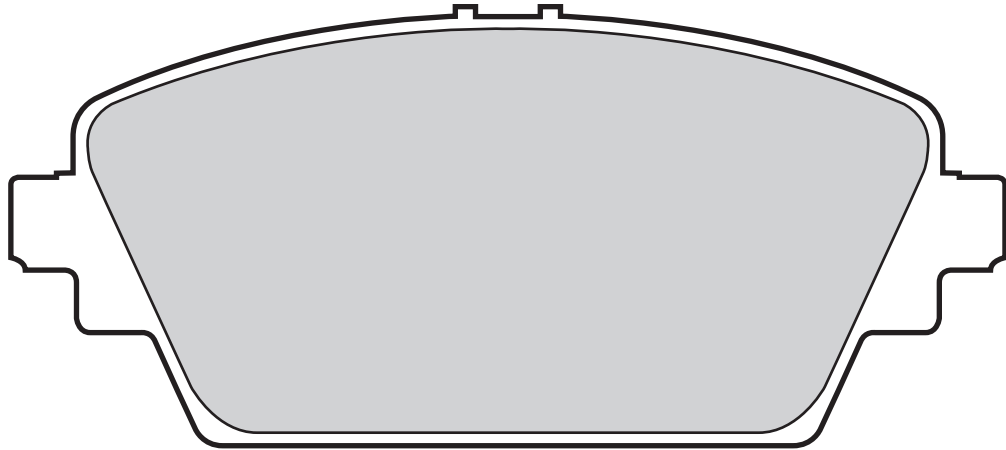

Valeo										
598436	2	Leaf	131,7	58,5	17,2	LUCAS	HONDA, MG			
598451	0		131,7	58,5	17,2	LUCAS	NISSAN			

23097 (WVA)

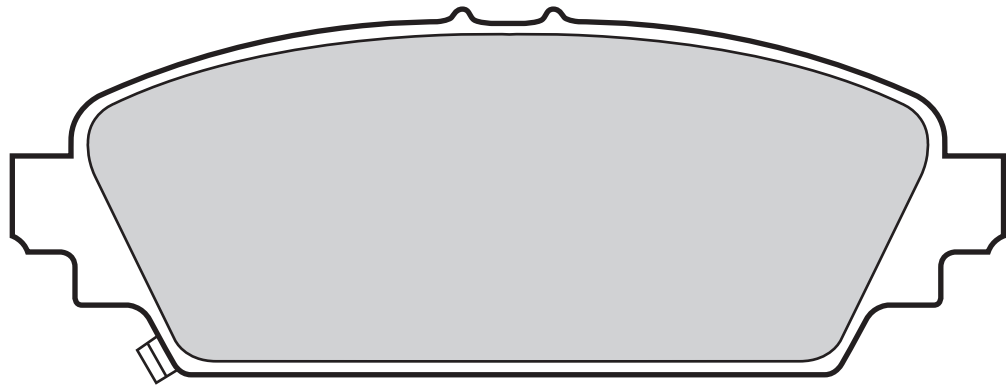

Valeo										
598435	0		131,7	49,2	17,2	LUCAS	HONDA			

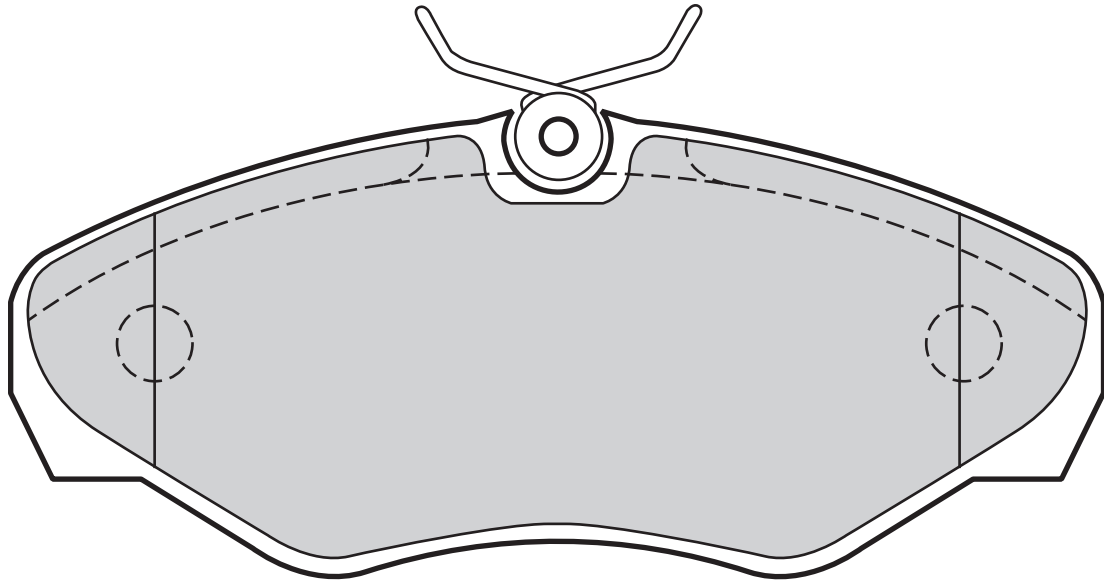
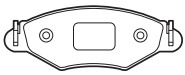

Valeo



Valeo



598545
598669

0
0

145
144

62,5
62

18
18

LUCAS
LUCAS

NISSAN, OPEL, RENAULT, VAUXHALL
RENAULT

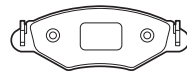

23114 (WVA)

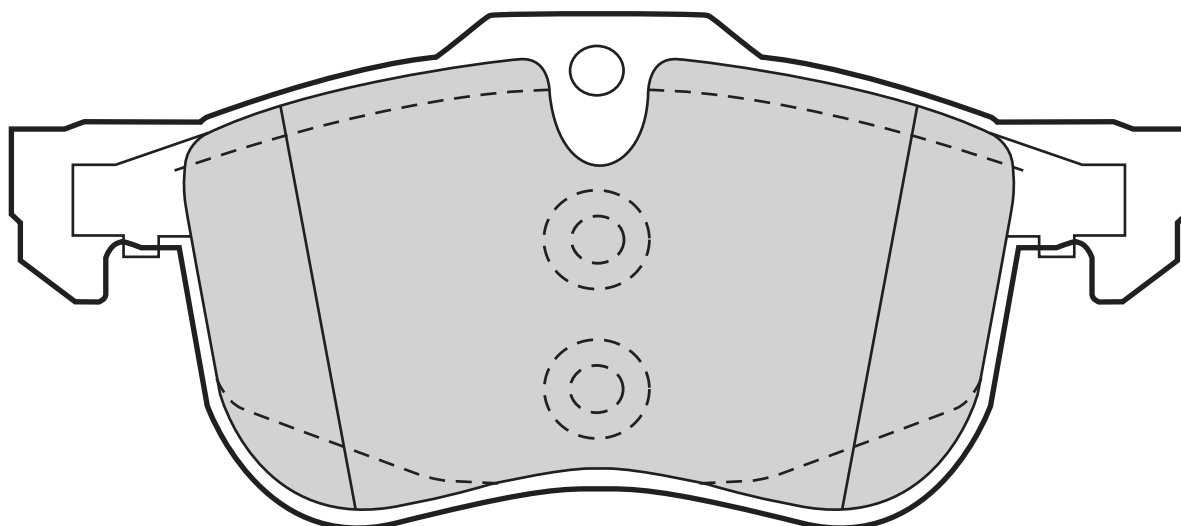
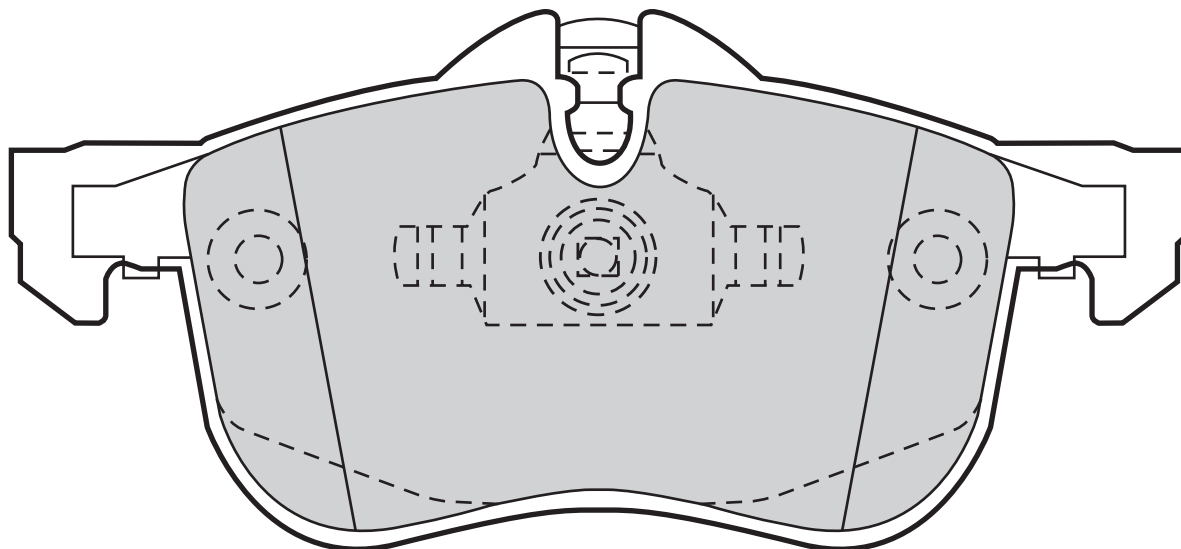

Valeo



Valeo



598632

0

156,4

70,6

19

TEVES

MG, ROVER



23116 (WVA)

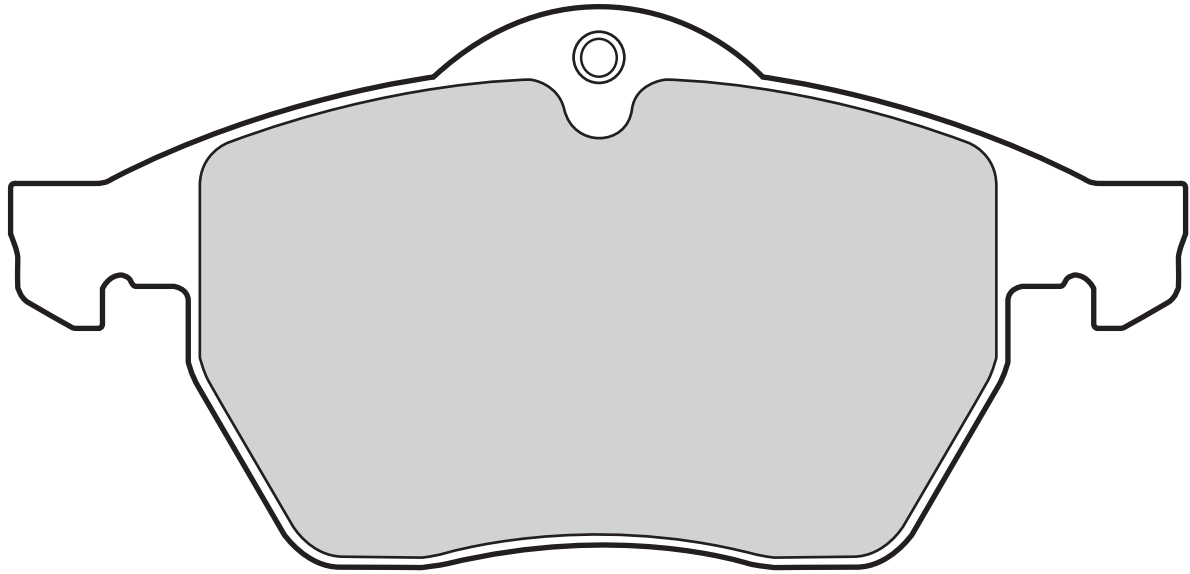

Valeo



2

Valeo



156,4



74,2



20,3



TEVES



OPEL, SAAB, VAUXHALL

598475

23118 (WVA)

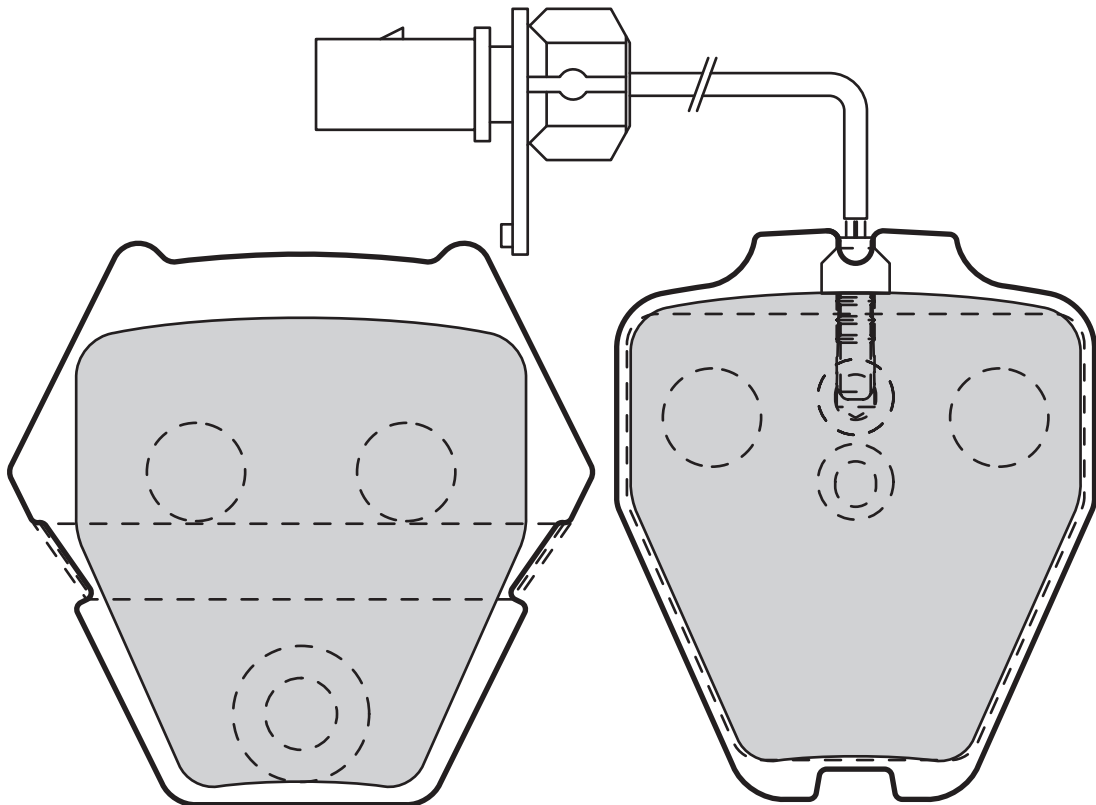

Valeo



2

Valeo



280



63,3



75,3



17,5



LUCAS



AUDI, VOLKSWAGEN

598992



23124 (WVA)

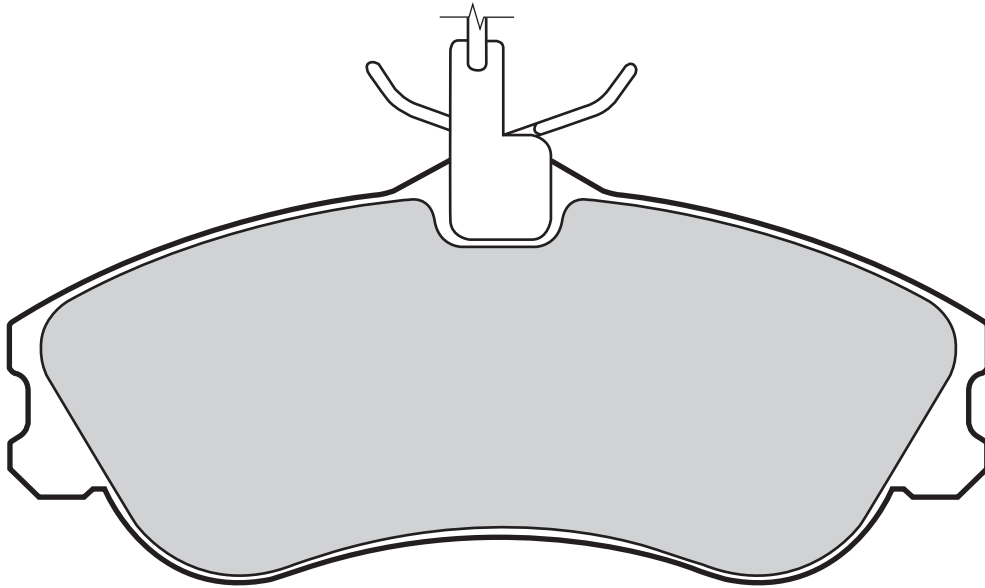

Valeo



Valeo



598326
598398

4
0

275/310

130
130

56,2
56,2

18,5
19

LUCAS
LUCAS

CITROËN, PEUGEOT
CITROËN, PEUGEOT

23129 (WVA)

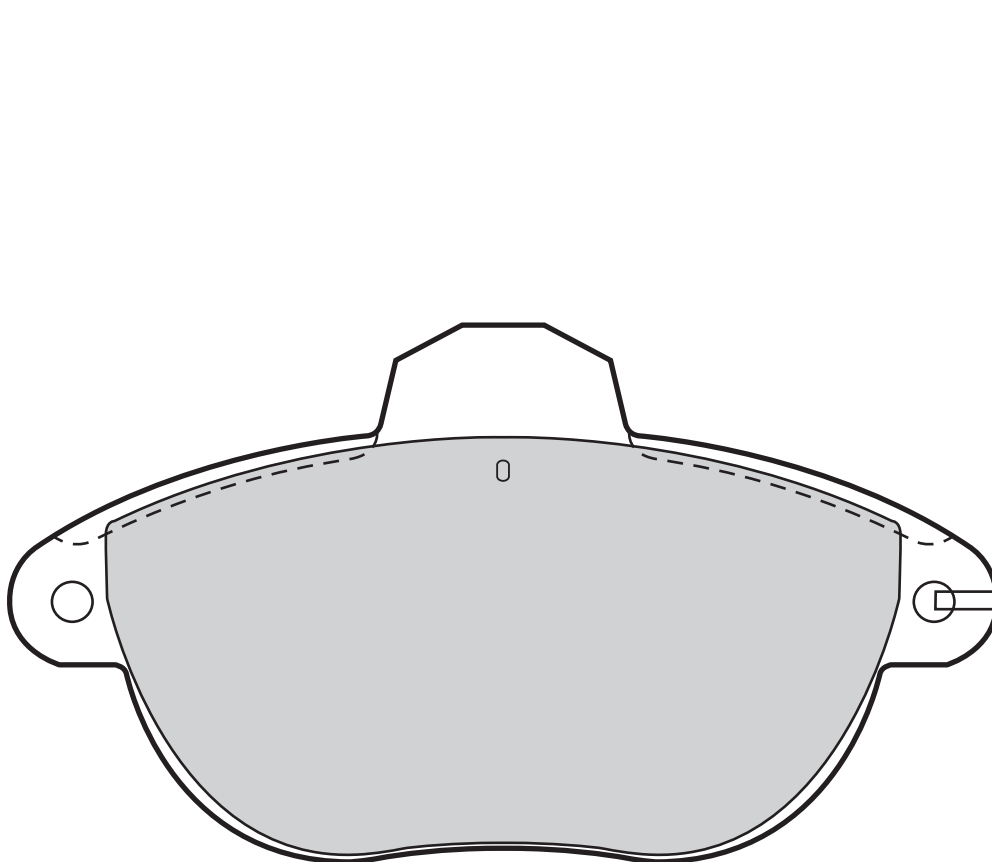

Valeo



Valeo



598385

4

365/150

130,9

71,4

17

BENDIX

CITROËN



23134 (WVA)

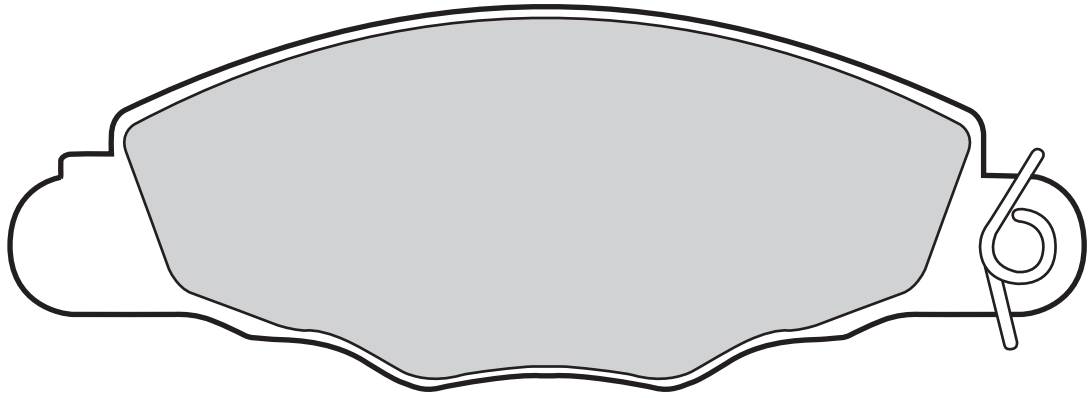

598420	4	405/180	169	61,2	18	BOSCH	CITROËN		

23138 (WVA)

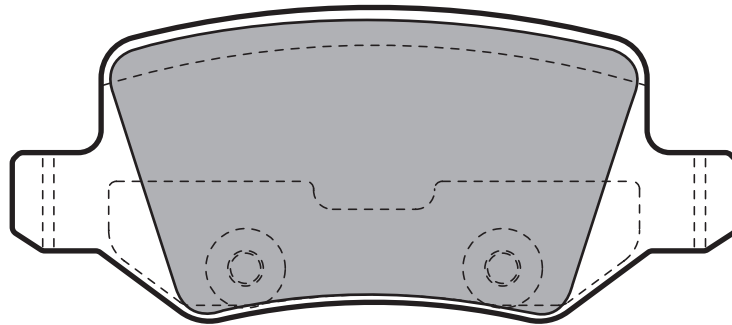

598583	0	95,8	41,5	14,3	LUCAS	MERCEDES		



23140 (WVA)

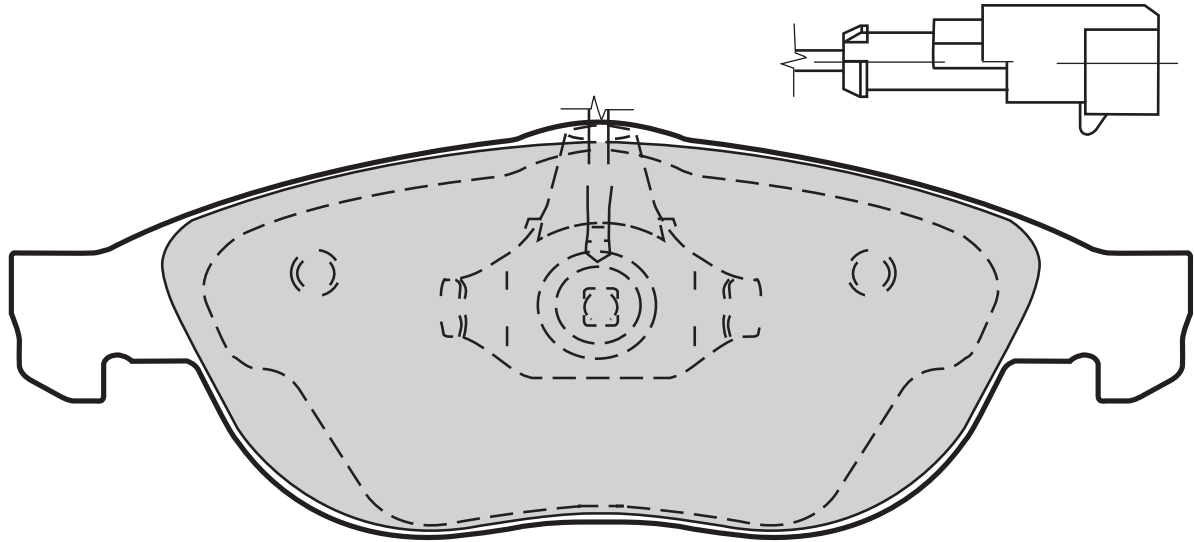

Valeo



2

Valeo



19,3



TEVES



ALFA ROMEO, LANCIA

598880

156,3

59,4

23144 (WVA)

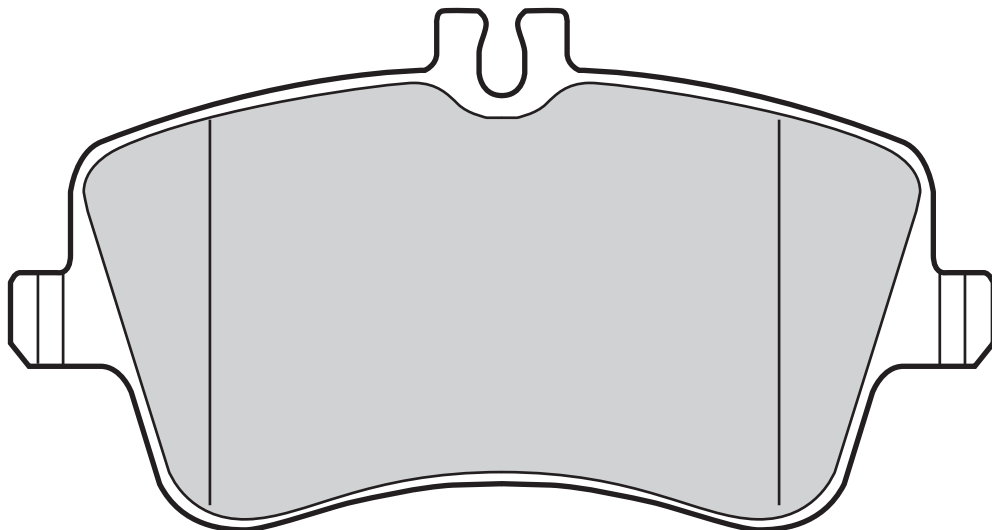

Valeo



0

Valeo



19,5



LUCAS



MERCEDES

598448

131,1

69,8



23154 (WVA)

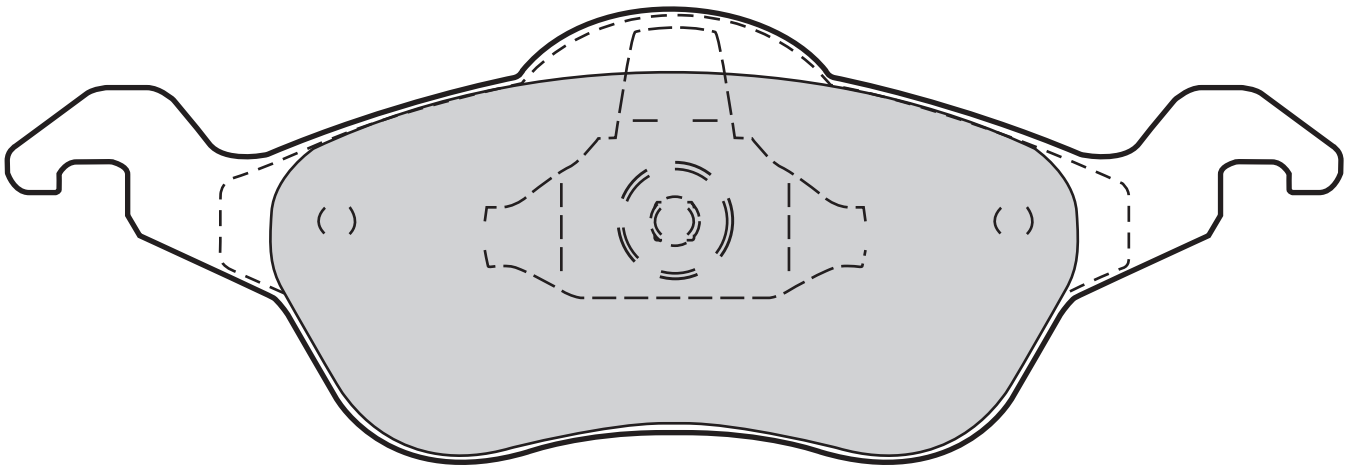
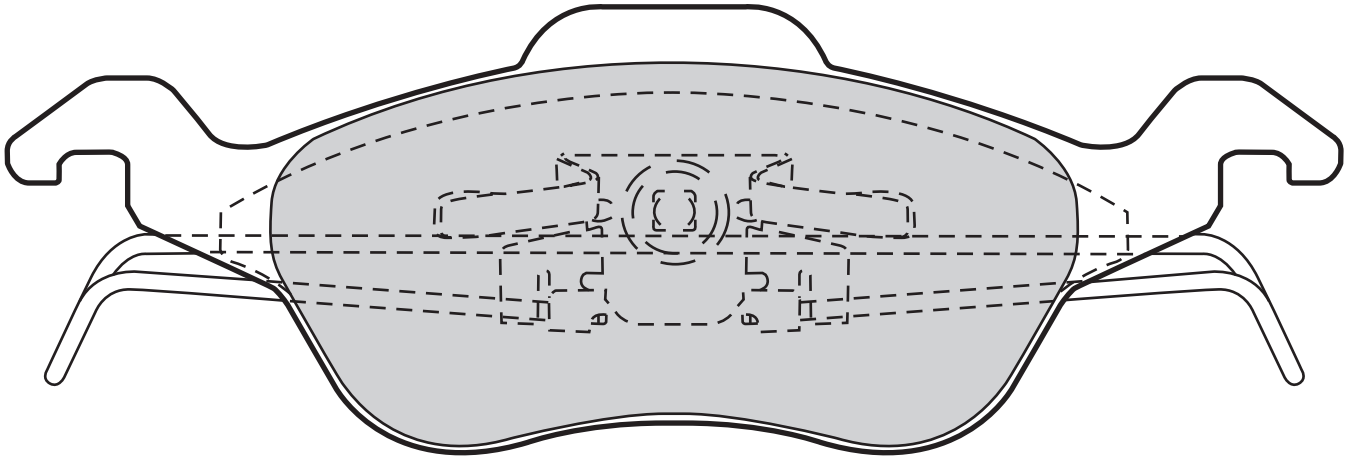

Valeo



0

Valeo



177,6



60/58



18,8



TEVES



FORD

598317

23157 (WVA)

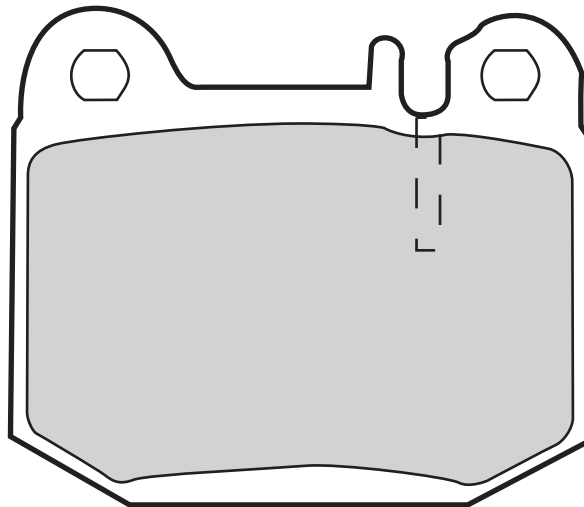

Valeo



0

Valeo



76,5



65,5



16,8



BREMBO



MERCEDES

598719

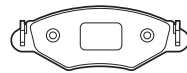

23176 (WVA)

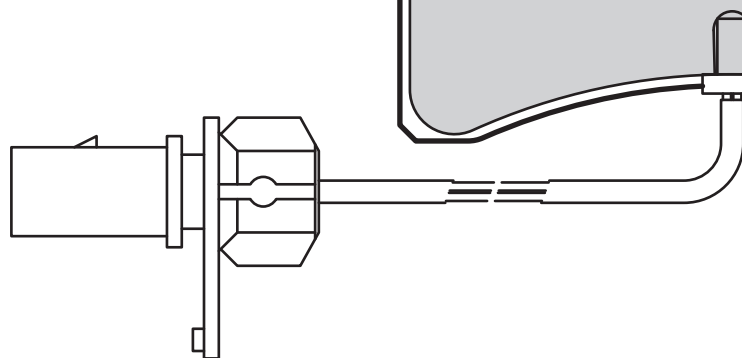
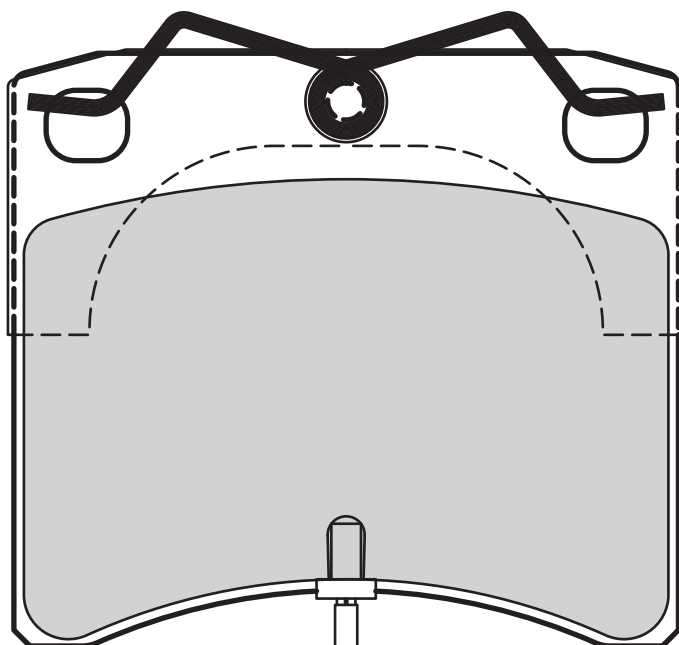
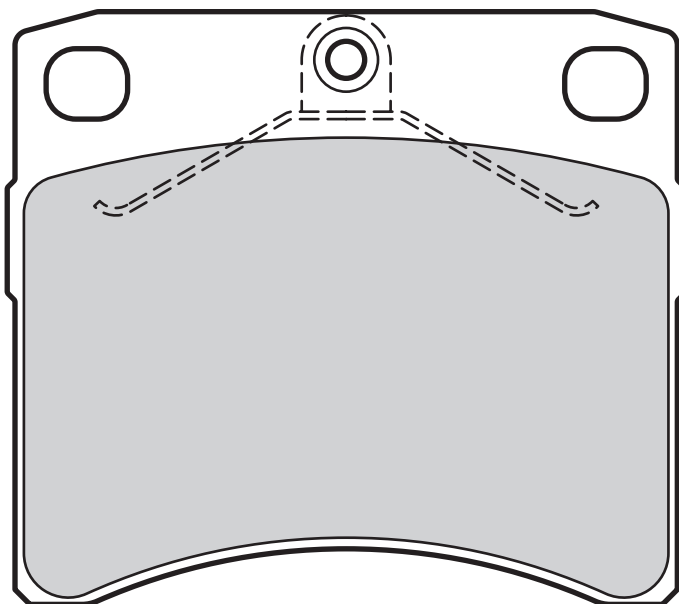

Valeo



Valeo



598807

2

210

91,7

80

18,1

LUCAS

VOLKSWAGEN



23177 (WVA)

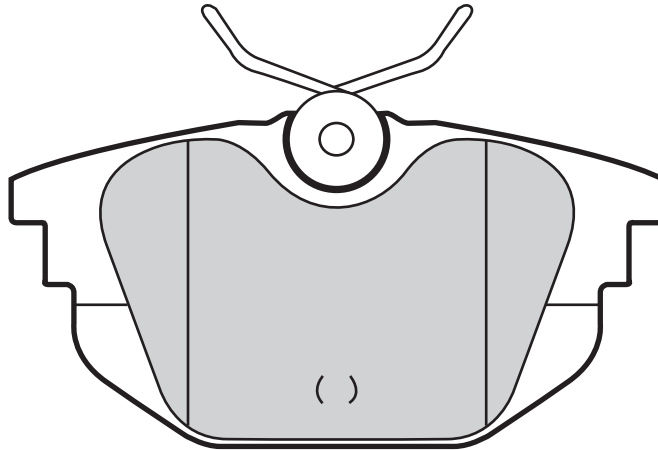

598331	0		86,8	44,6	14,7		LUCAS	ALFA ROMEO, FIAT, LANCIA

23183 (WVA)

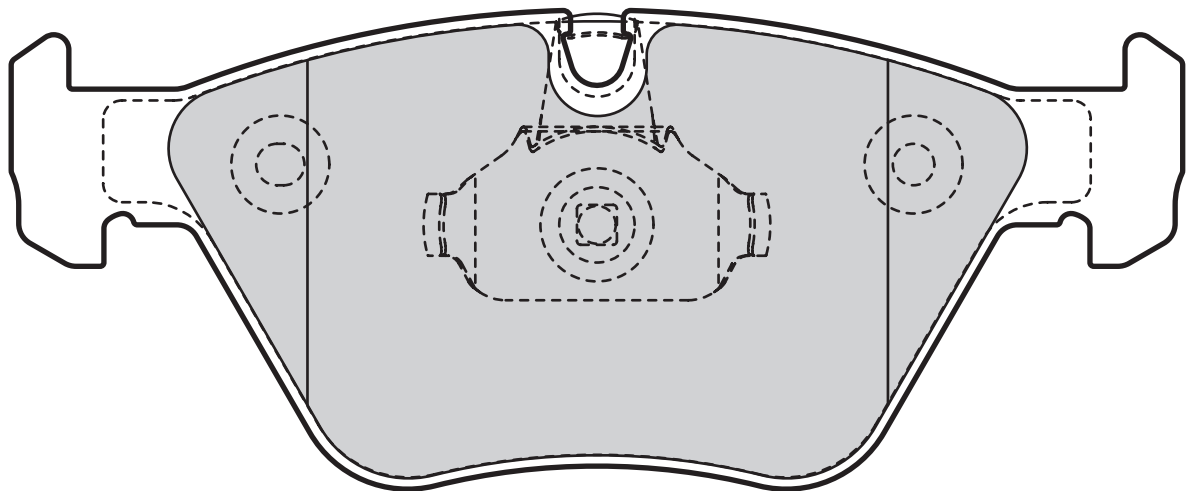
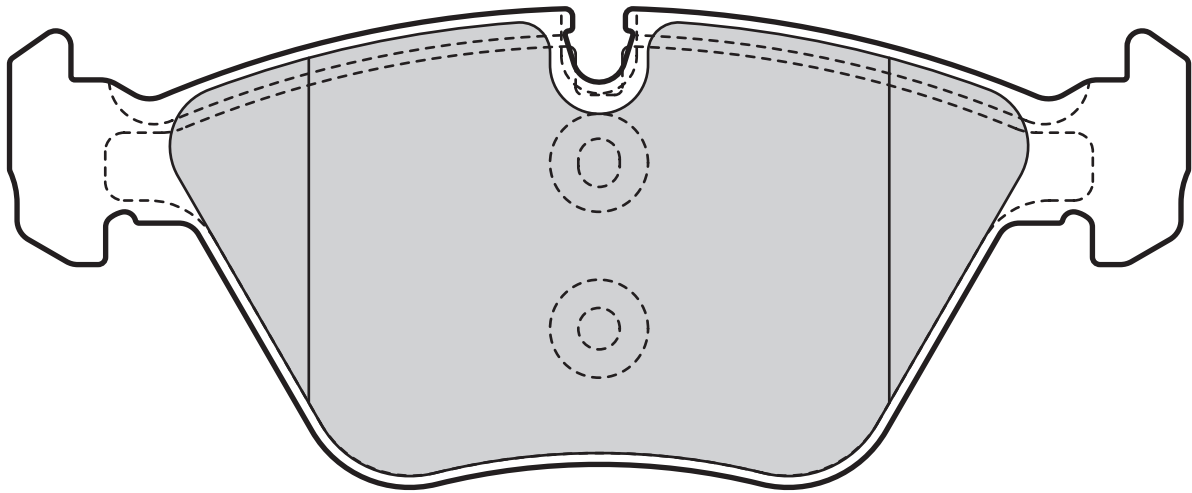

598811	0		156,2	63,5	20,3		TEVES	BMW, MG

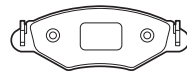

23184 (WVA)

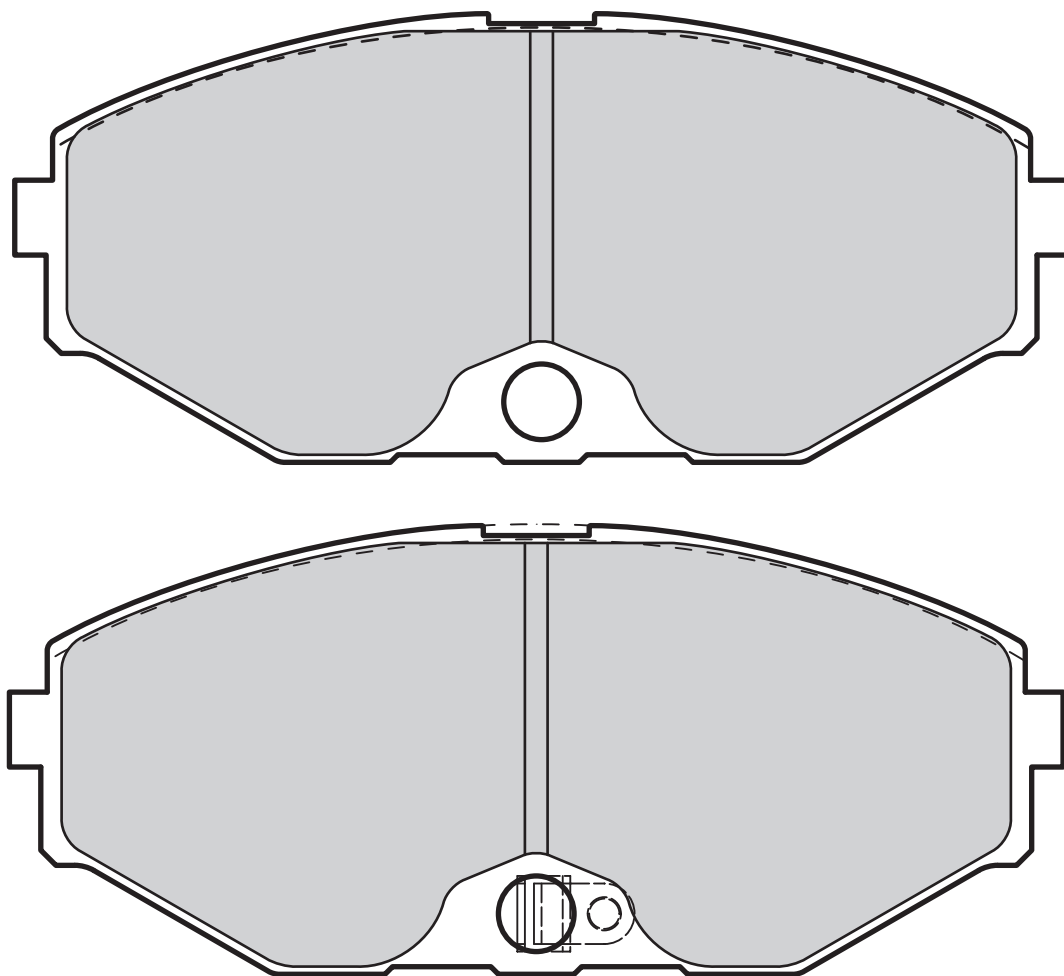

598912

2

Leaf

139

56,7

14,8

AKEBONO

NISSAN

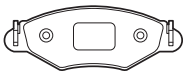

23189 (WVA)

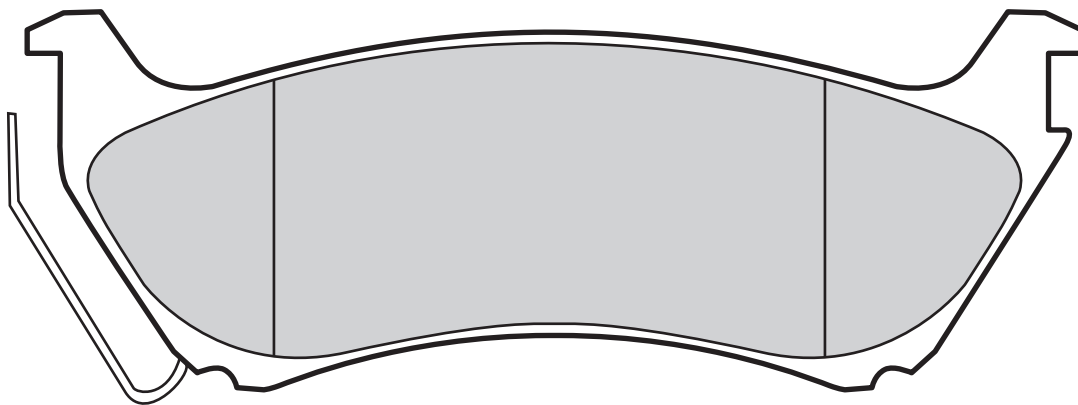
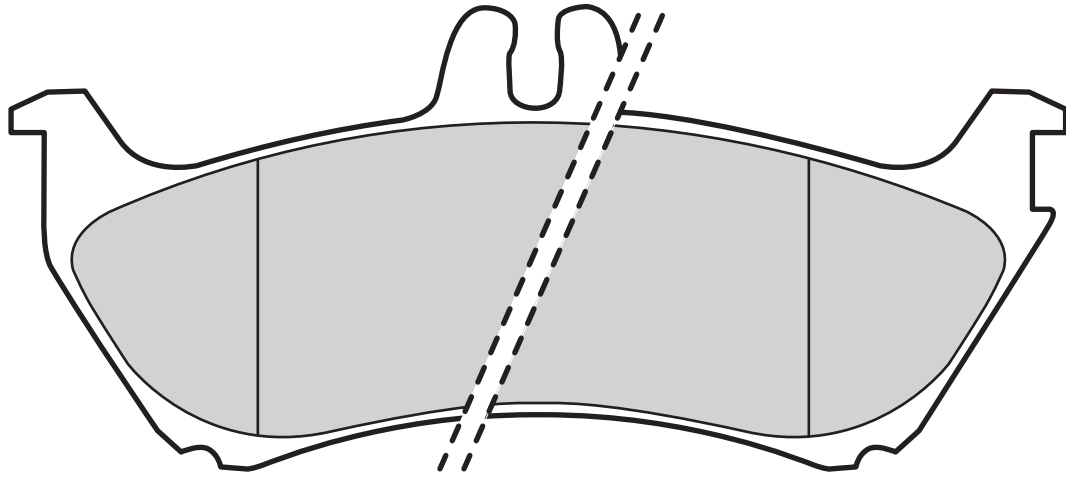

Valeo



Valeo



598443
598813

1
1

310

140,3
140

50,1
50/61

16,6
16,7

KELSEY
BOSCH

MERCEDES
MERCEDES

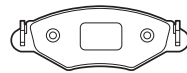

23193 (WVA)

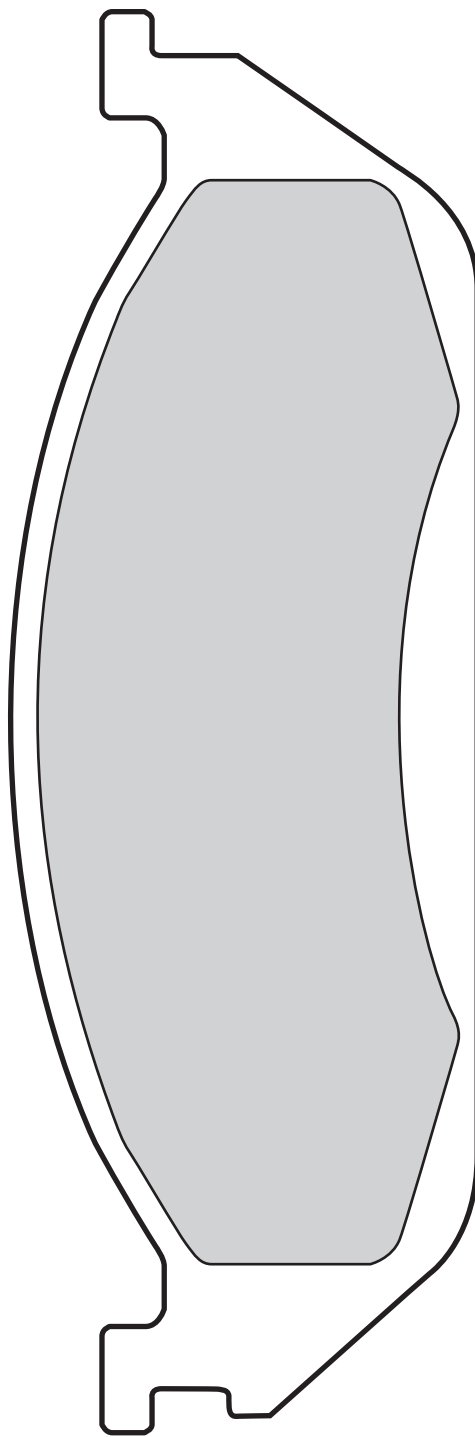

598442

1

190

188

58,9

17

KELSEY

MERCEDES

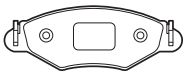

Valeo

23200 (WVA)

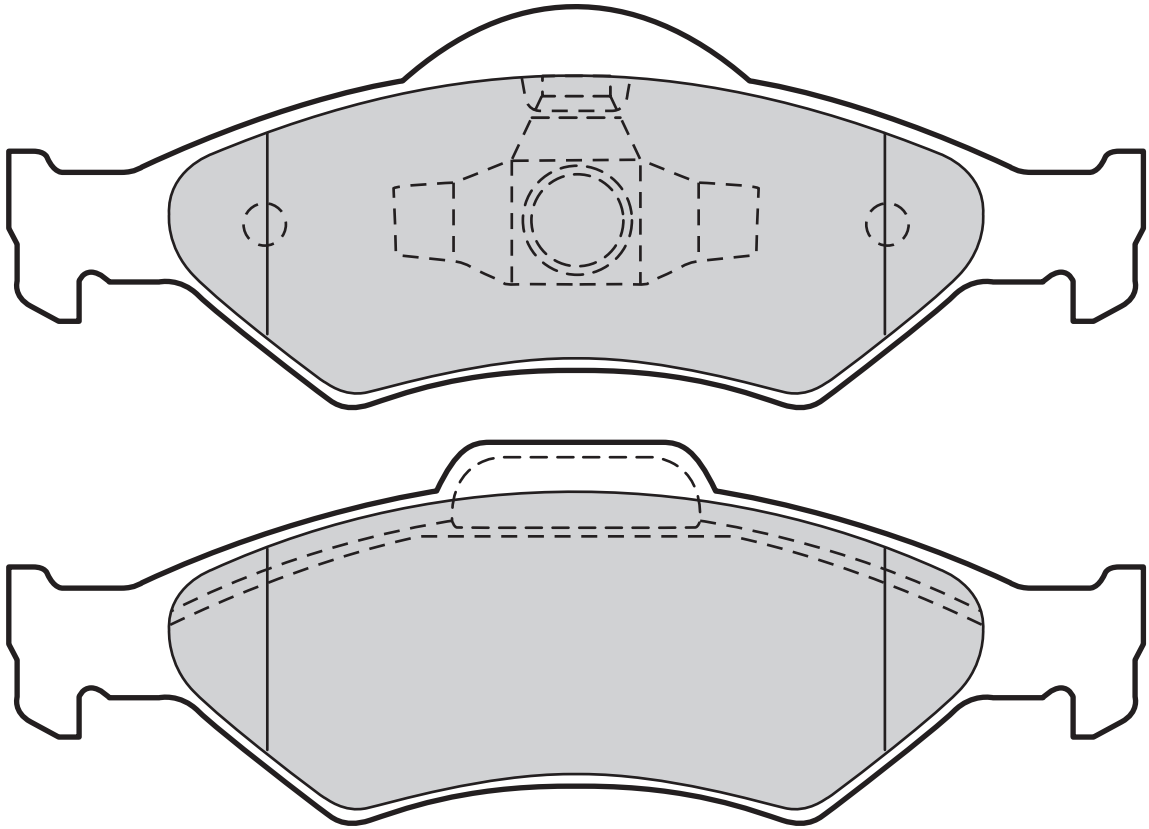

Valeo



Valeo



598563

0

150,2

54,1

18,6

TEVES

FORD

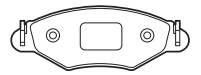

23202 (WVA)

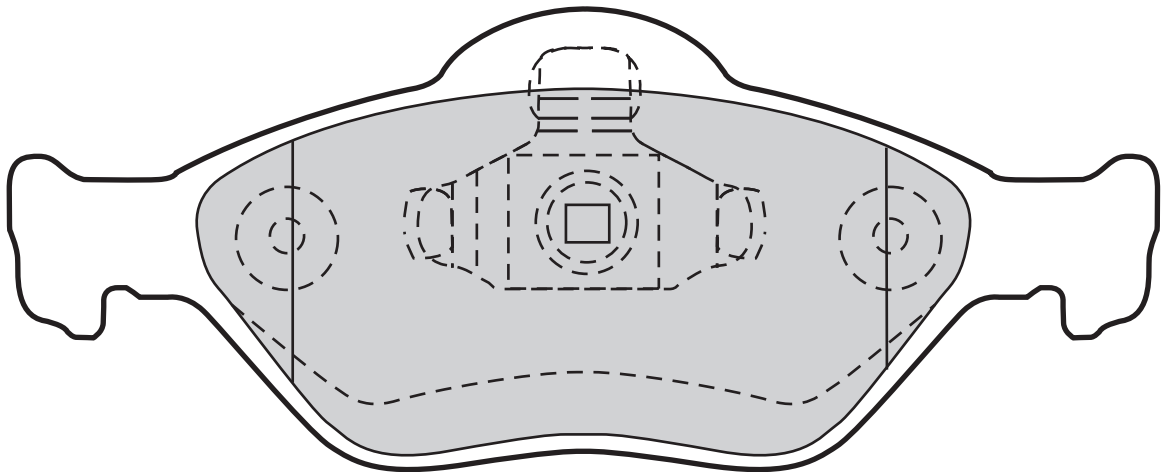
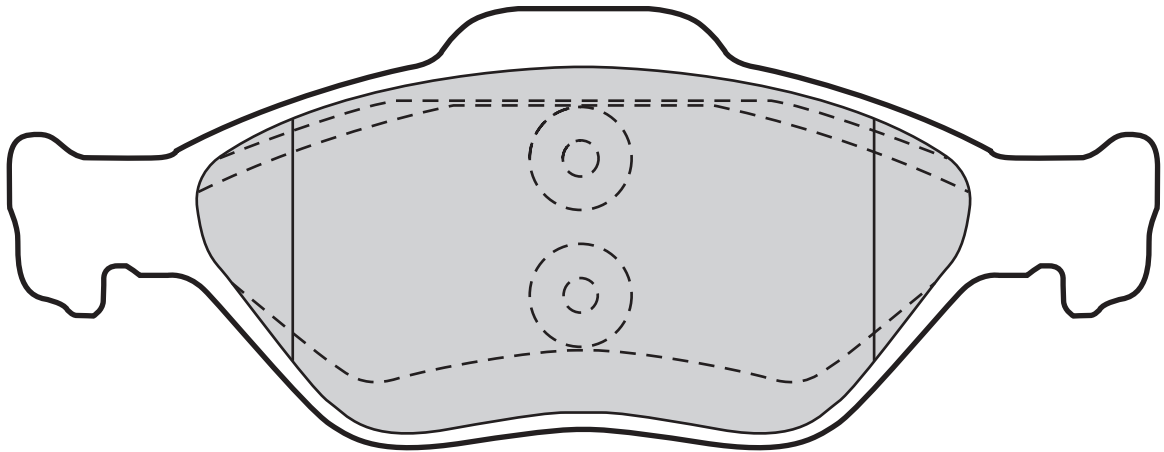

Valeo



Valeo



598564

0

150,4

61,6

18,5

TEVES

FORD, MAZDA

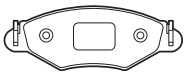

Valeo

23225 (WVA)

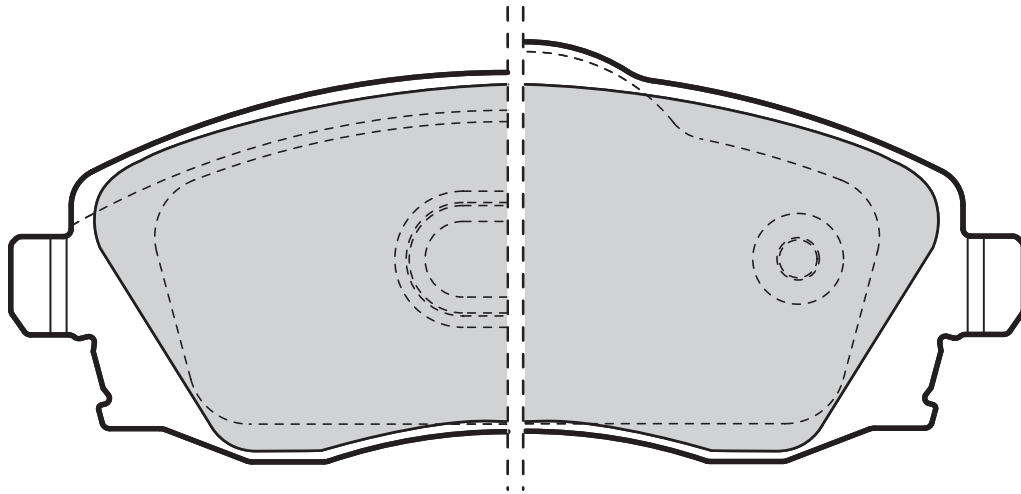

Valeo



2

Valeo



131,6



55,6



16,8



LUCAS



OPEL, VAUXHALL

598456



23230 (WVA)

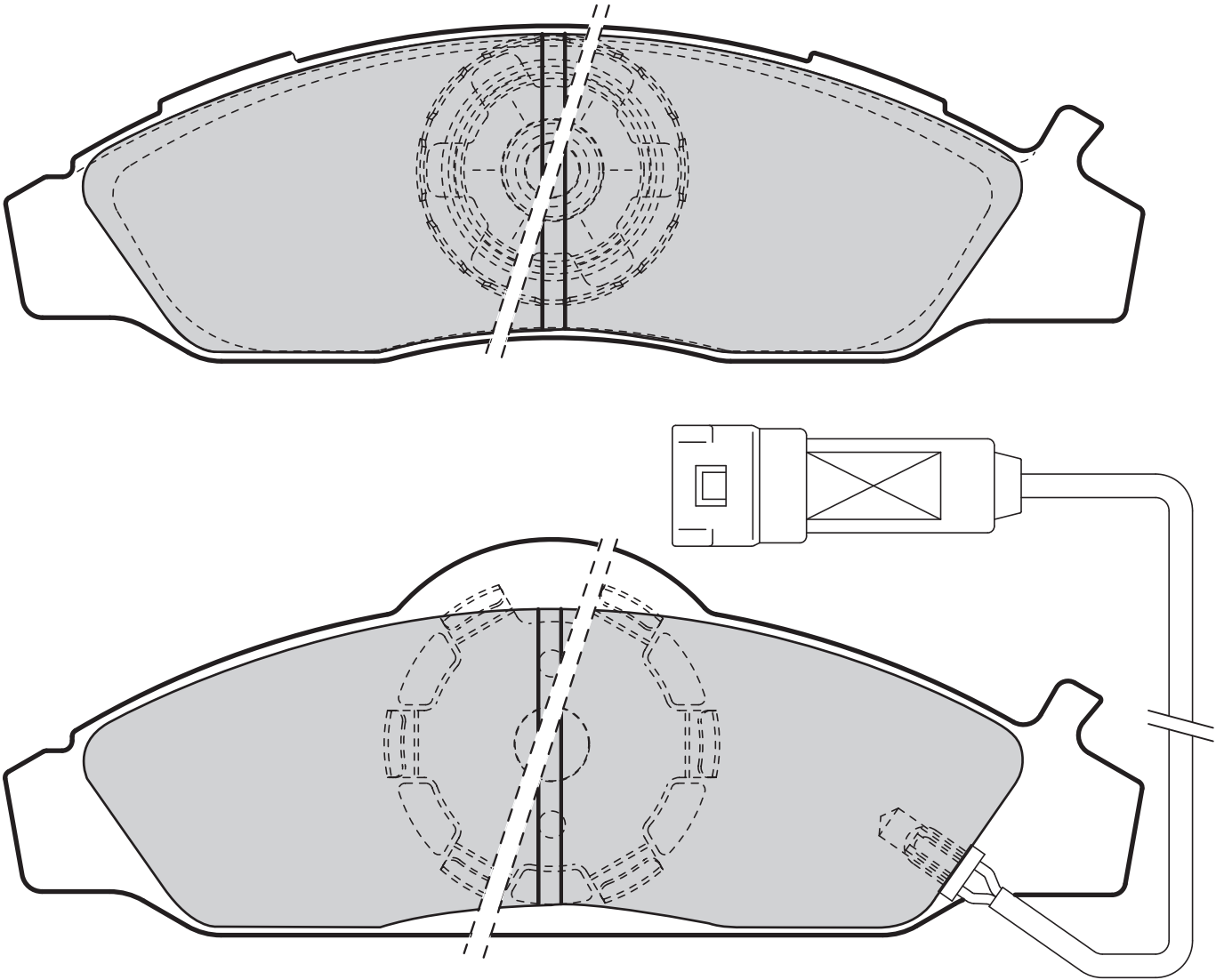

Valeo



Valeo



598528

2

220

169,5

59/50

16

LUCAS

SSANGYONG

23235 (WVA)

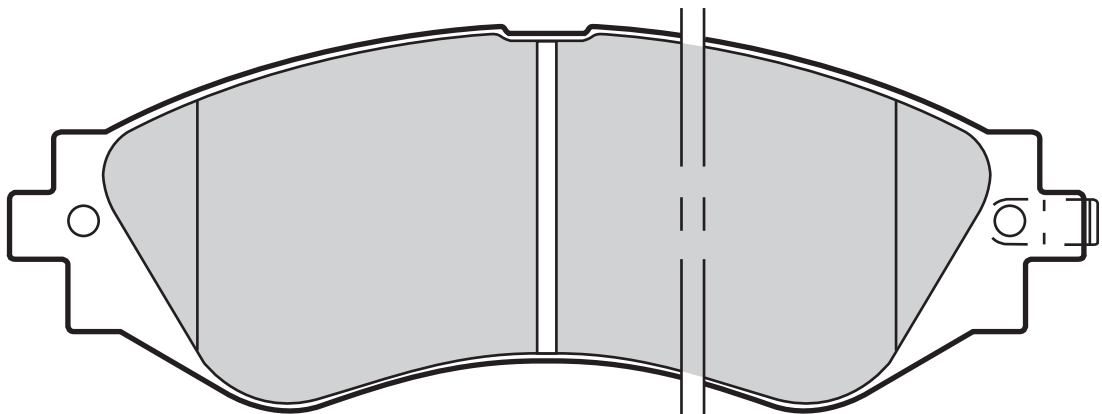

Valeo



Valeo



598361

2

143

51,4

18

AKEBONO

CHEVROLET, DAEWOO



23237 (WVA)

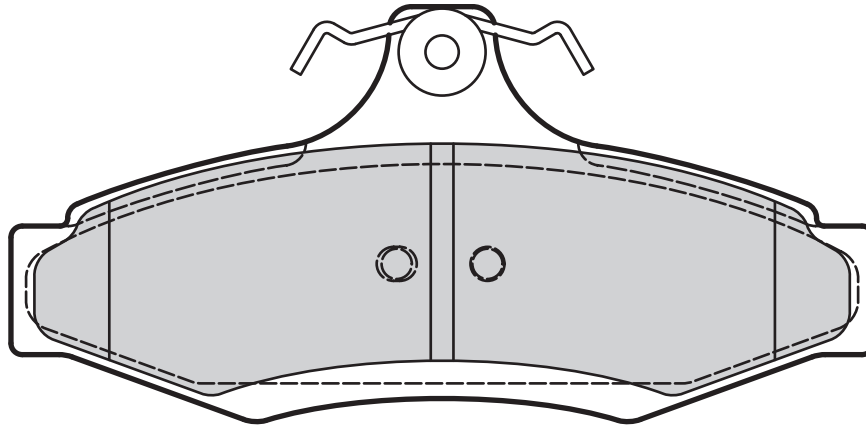

Valeo



0

Valeo



114



55



14,5



LUCAS



DAEWOO

598902

23238 (WVA)

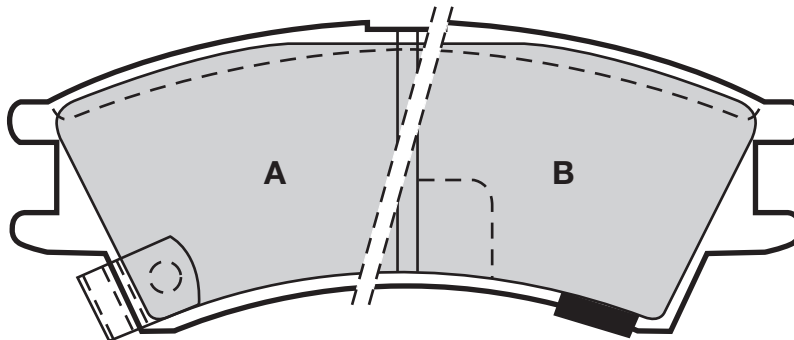

Valeo



2

Valeo



104,7



41,3



16



AKEBONO



HYUNDAI

598575

23241 (WVA)

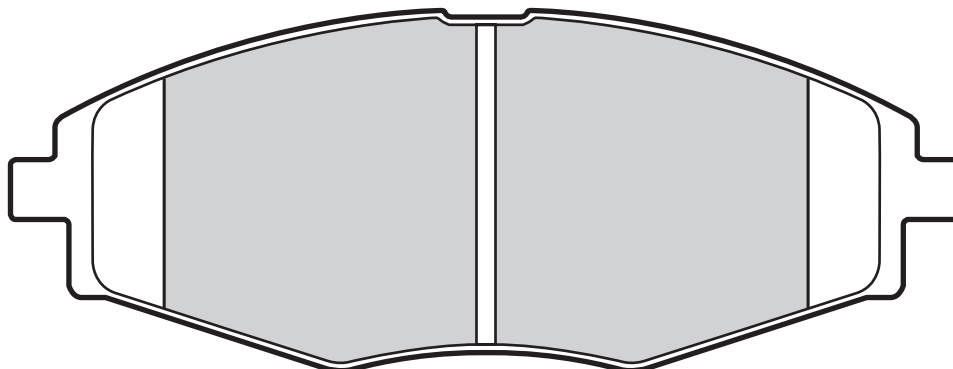

Valeo



0

Valeo



127



48,5



16,7



AKEBONO



CHEVROLET, DAEWOO

598316

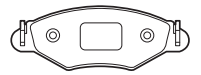

23242 (WVA)

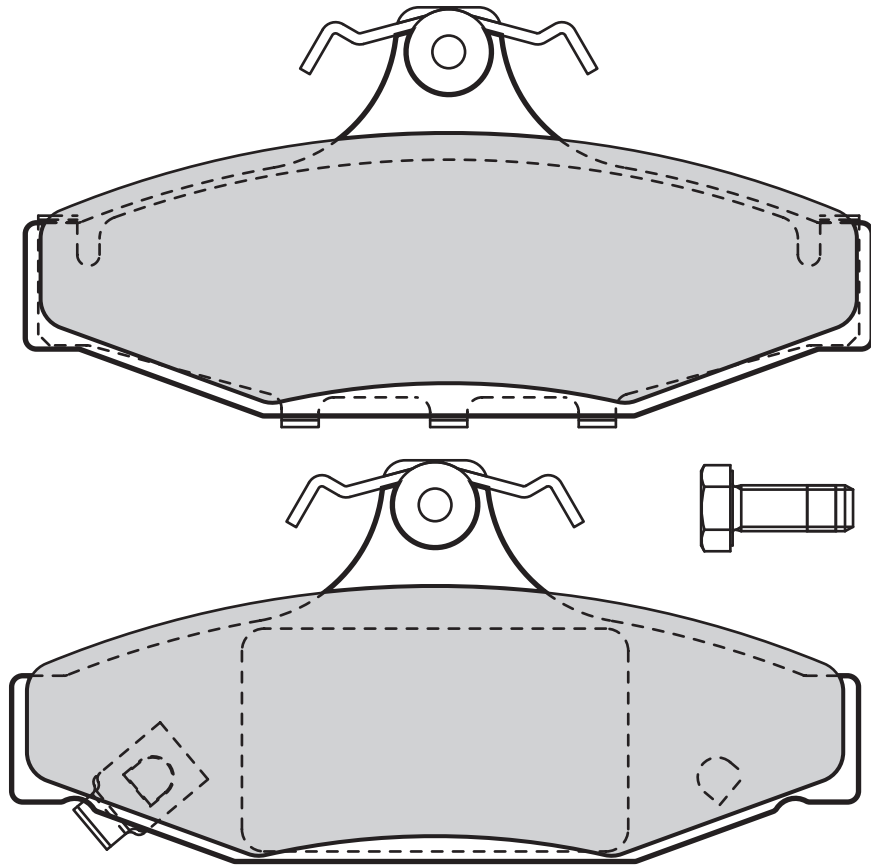

Valeo



Valeo



598854

2

113,8

55,2

14

LUCAS

DAEWOO, SSANGYONG

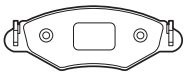

Valeo

23245 (WVA)

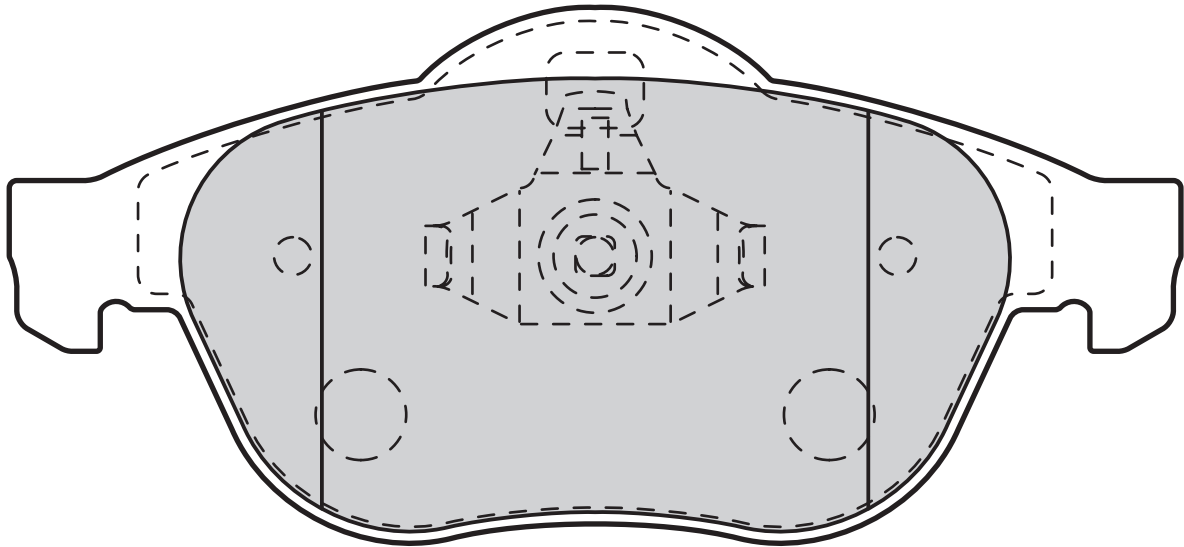
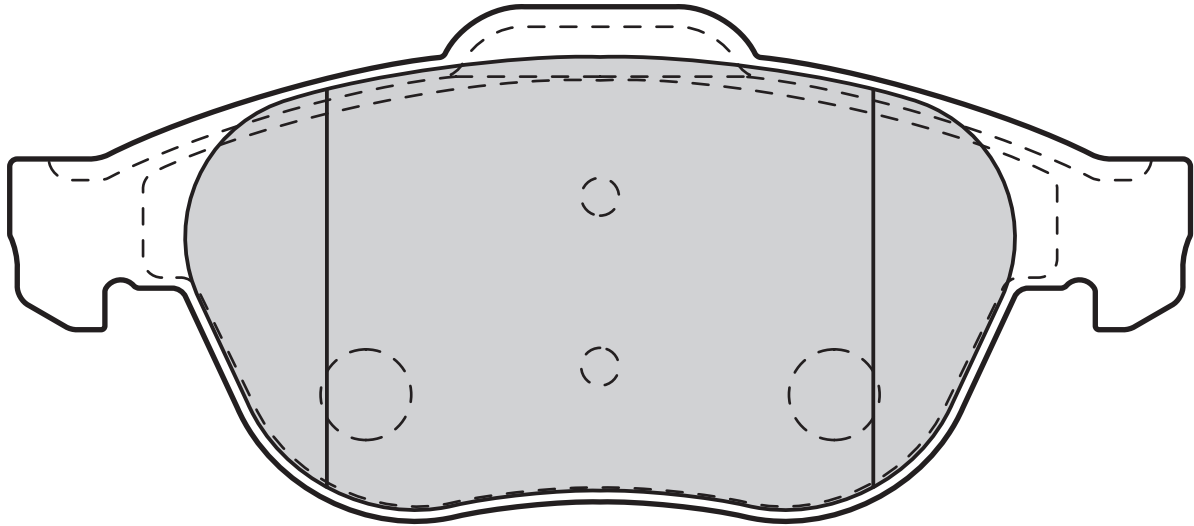

Valeo



Valeo



598993

0

155,2

71

18,3

TEVES

RENAULT



23250 (WVA)

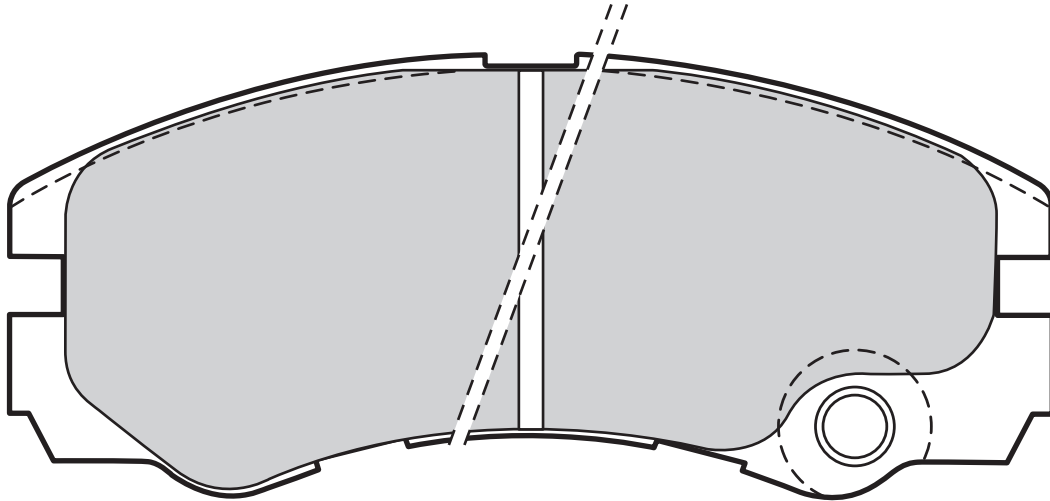

Valeo



2

Valeo



137,8



57,8



18,5



AKEBONO



OPEL, VAUXHALL

598661

23253 (WVA)

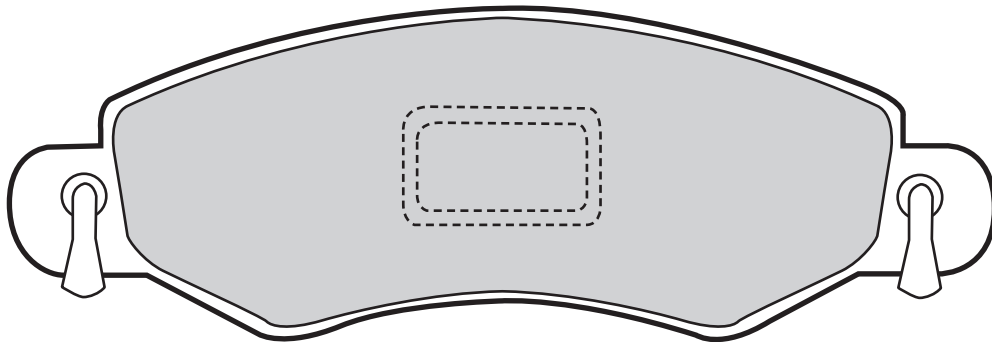

Valeo



2

Valeo



130,9



44,5



16



BOSCH



OPEL, SUBARU, SUZUKI, VAUXHALL

598453

23258 (WVA)

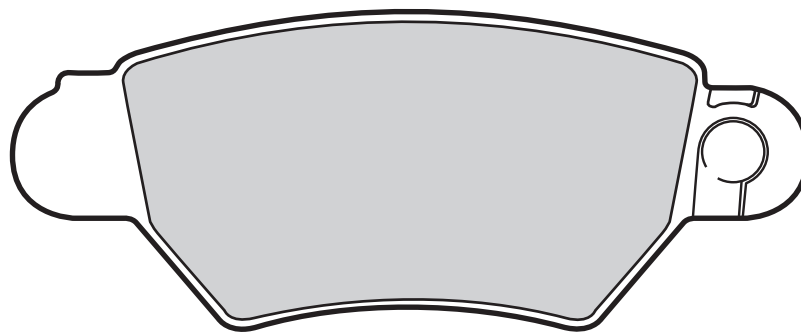

Valeo



2 (A)

Valeo



105



42,7



17



BOSCH



OPEL, VAUXHALL

598926

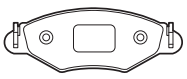

Valeo

23266 (WVA)

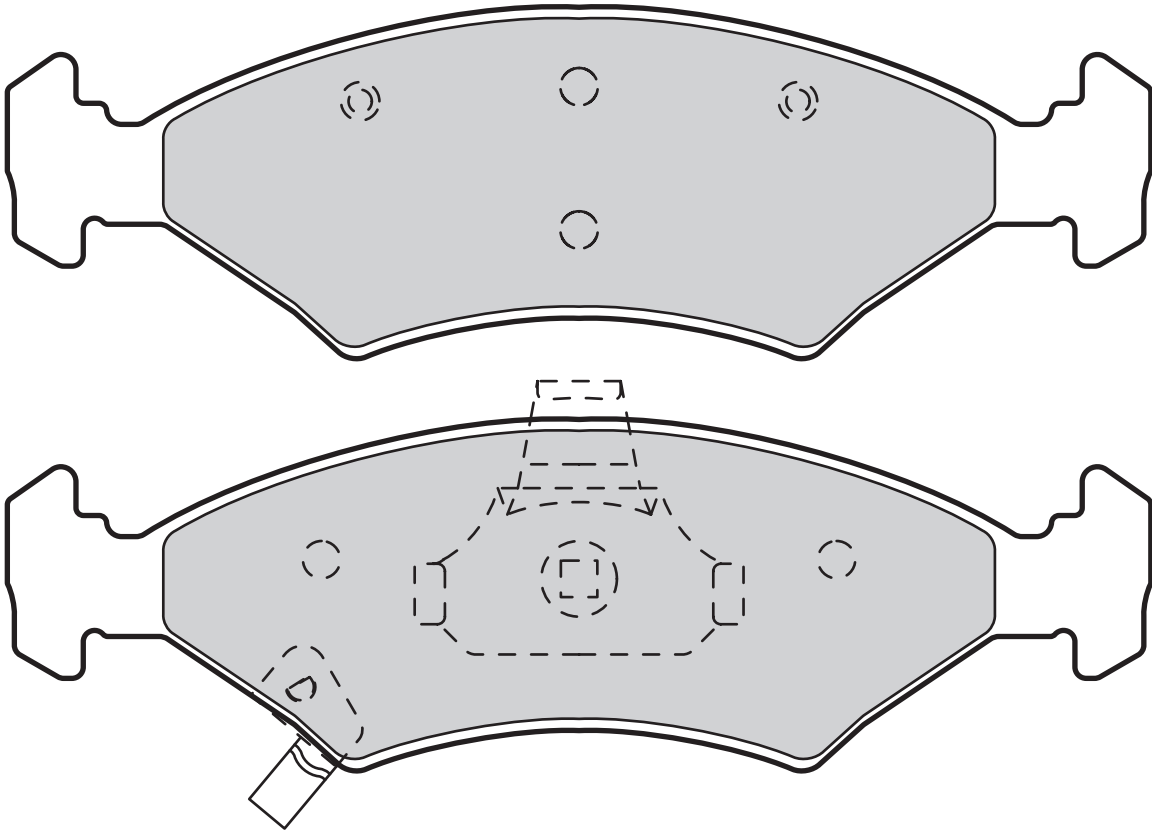

Valeo



Valeo



598989

2

Leaf

151,5

47,7

17,3

TEVES

KIA



23269 (WVA)

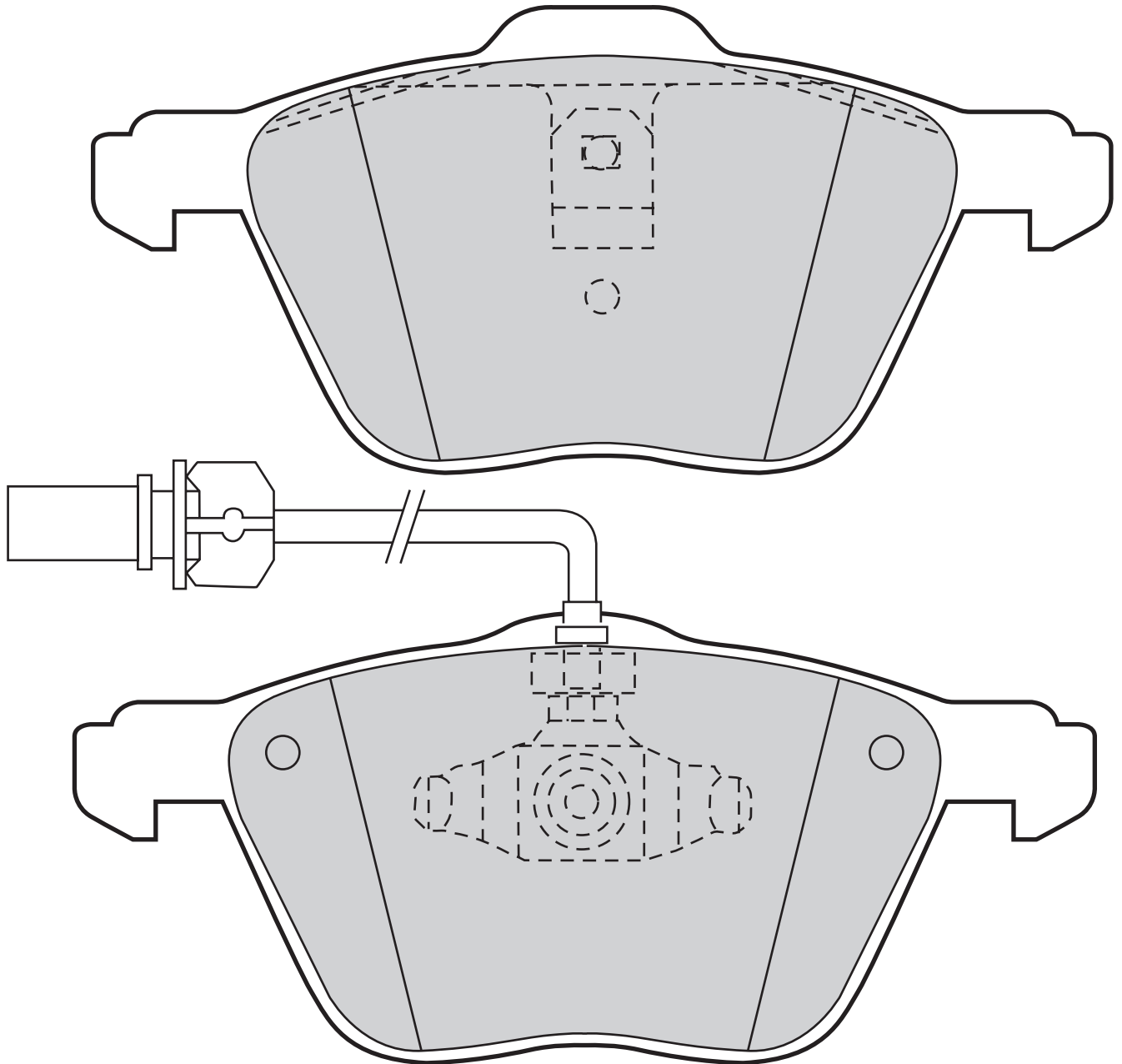

Valeo



Valeo



598565

2

270

161,4

74,6

19,6

TEVES

FORD, SEAT, VOLKSWAGEN



Valeo

23271 (WVA)

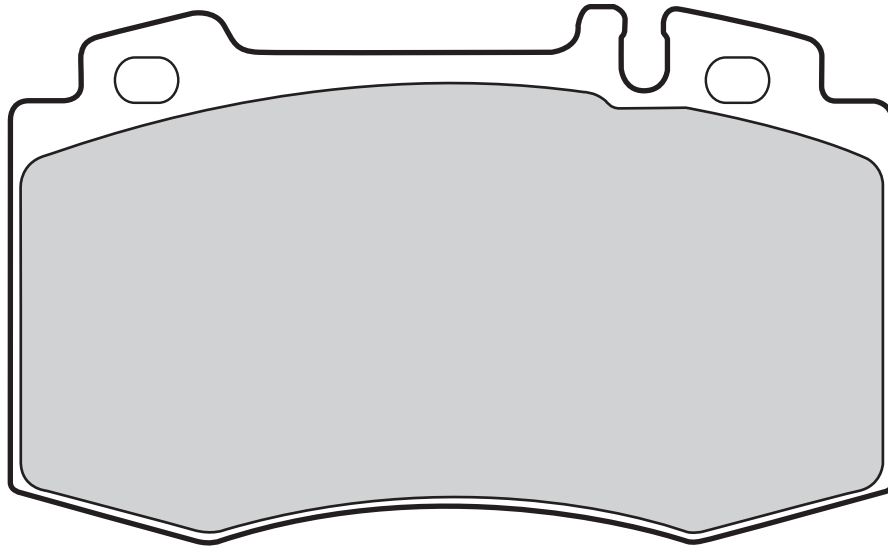

Valeo



0

Valeo



117,8

71,6



17,2



BREBBO



MERCEDES

598445

23273 (WVA)

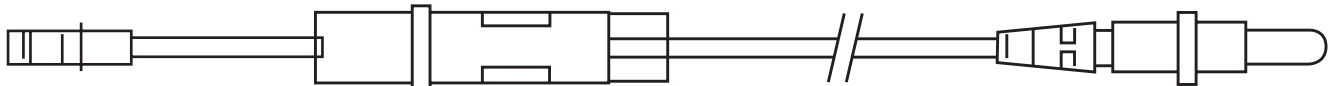
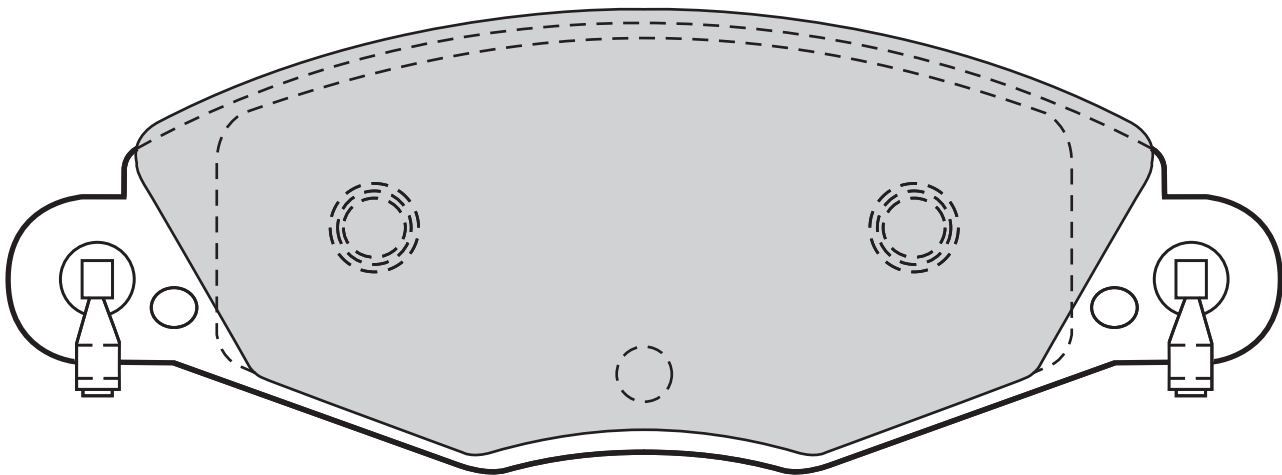

Valeo



4

Valeo



180/410

168,8

61,3



17,8



BOSCH



CITROËN

598416

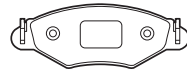

23276 (WVA)

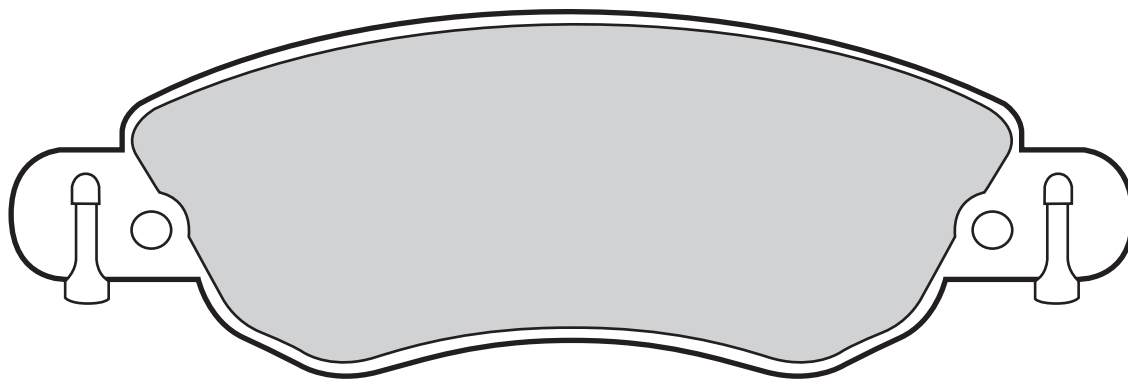

598417	4	180/410	148,8	49,5	17,5	BOSCH	CITROËN	

23277 (WVA)

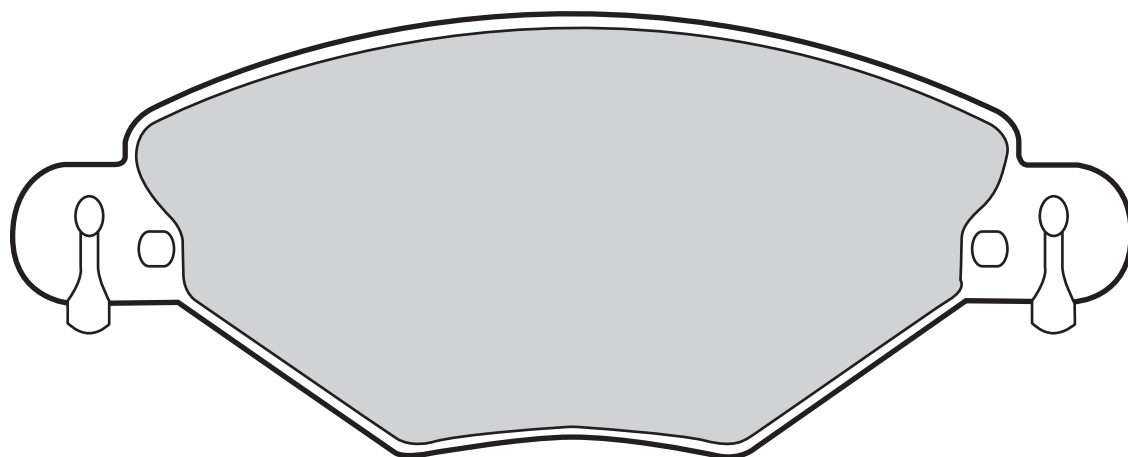

598419	4	180/410	148,8	59	17,8	BOSCH	CITROËN	



23279 (WVA)

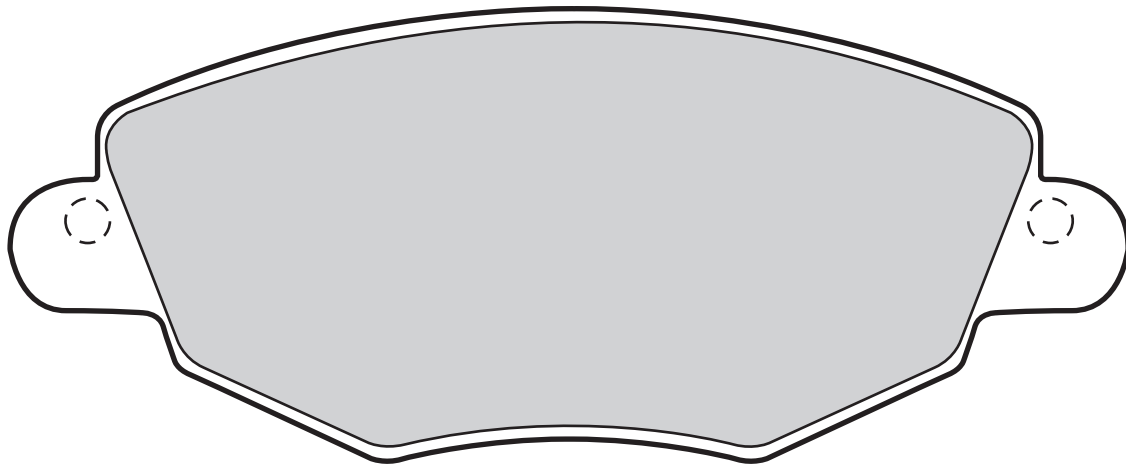

598433	0	149	60,5	18	BOSCH	FORD, JAGUAR		

23282 (WVA)

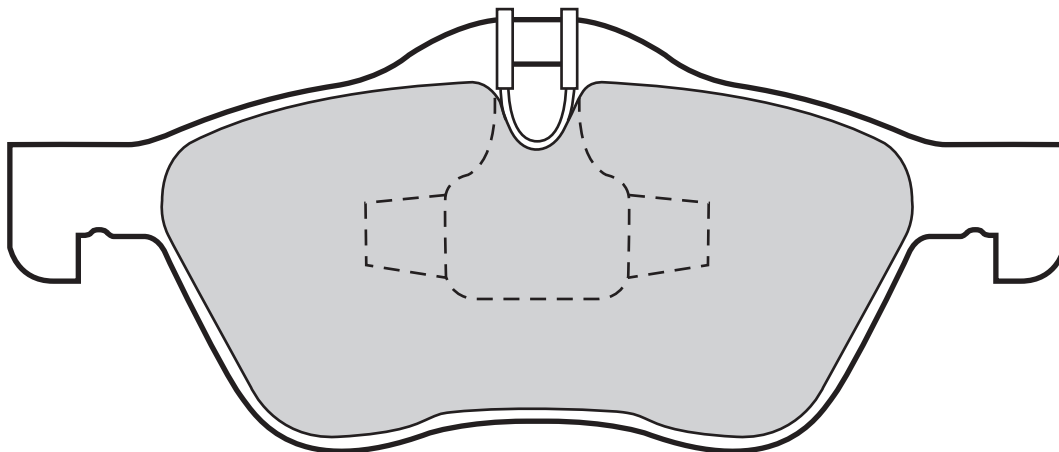

598413	0	140	59/60	18,3	TEVES	MINI	

23284 (WVA)

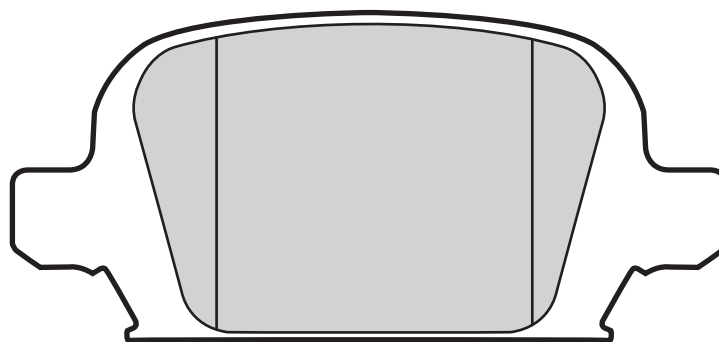

598457	2	95,5	43,9	13,8	LUCAS	OPEL, VAUXHALL	

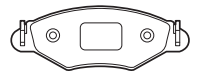

23290 (WVA)

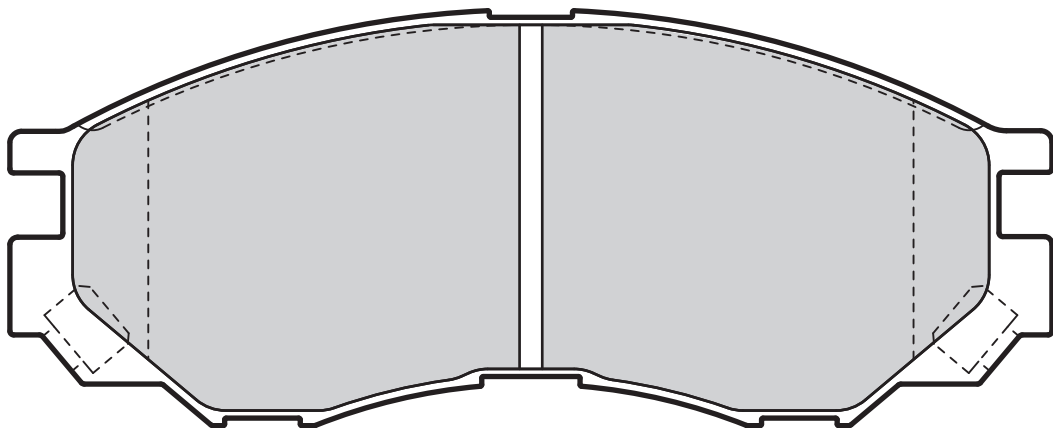
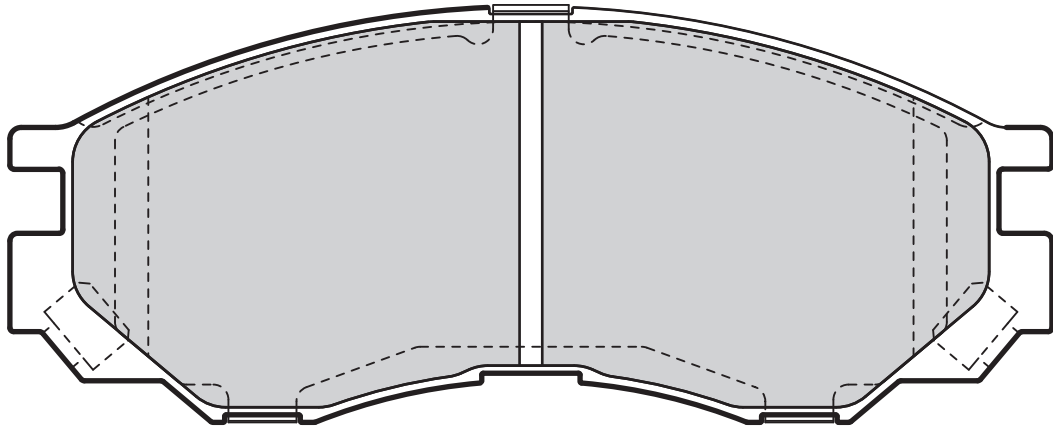

Valeo



Valeo



598522

2

137,8

55

15,7

AKEBONO

MITSUBISHI

23294 (WVA)

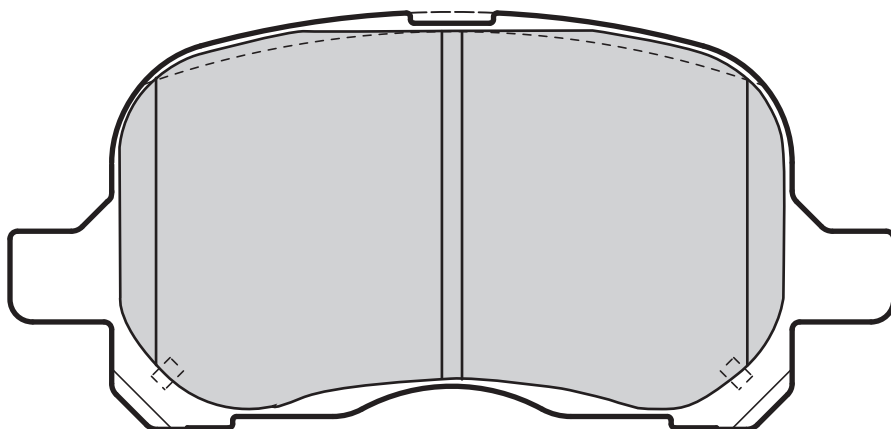

Valeo



Valeo



598579

0

116,8

55

16,5

AKEBONO

TOYOTA



23300 (WVA)

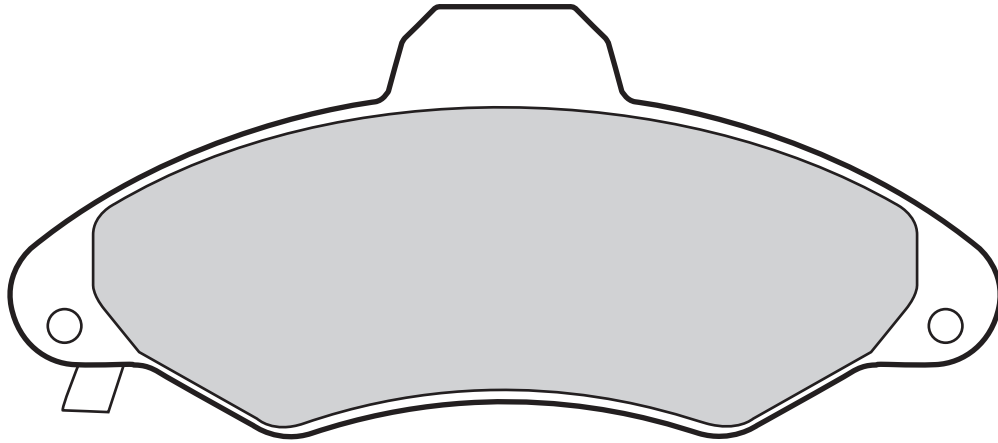

598172
598399

0
0

131
131,1

57,4
57,3

18,3
19

BENDIX
BENDIX

FORD
FORD

23302 (WVA)

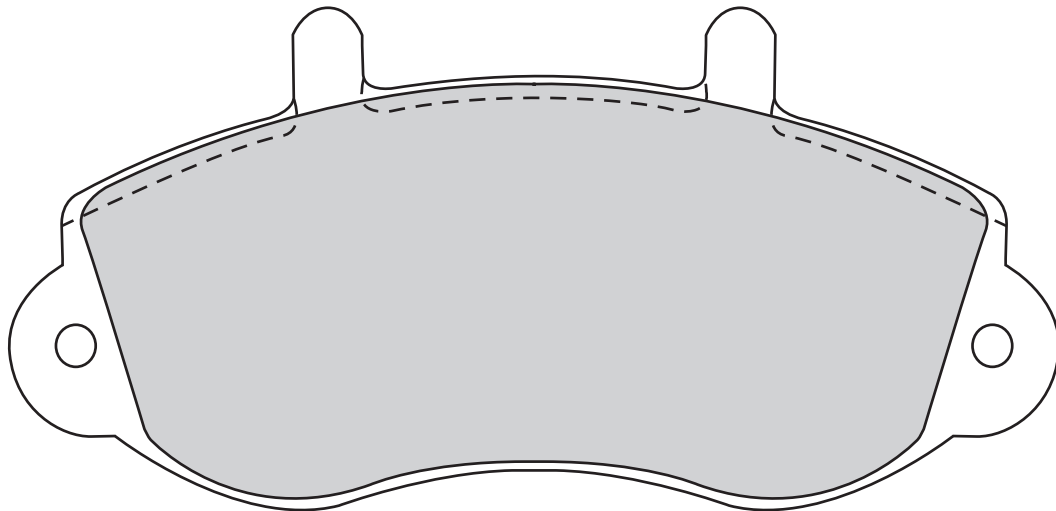

598490

0

138,8

66,4

18

BENDIX

OPEL, RENAULT, VAUXHALL

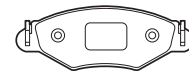

23305 (WVA)

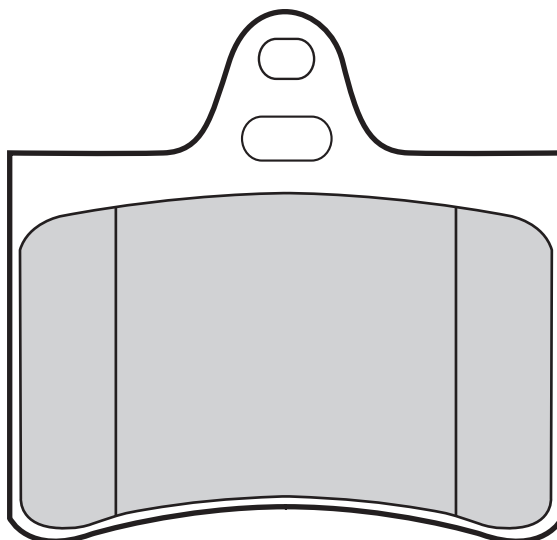

598418

0

73

70,8

15,2

CITROËN

CITROËN

23312 (WVA)

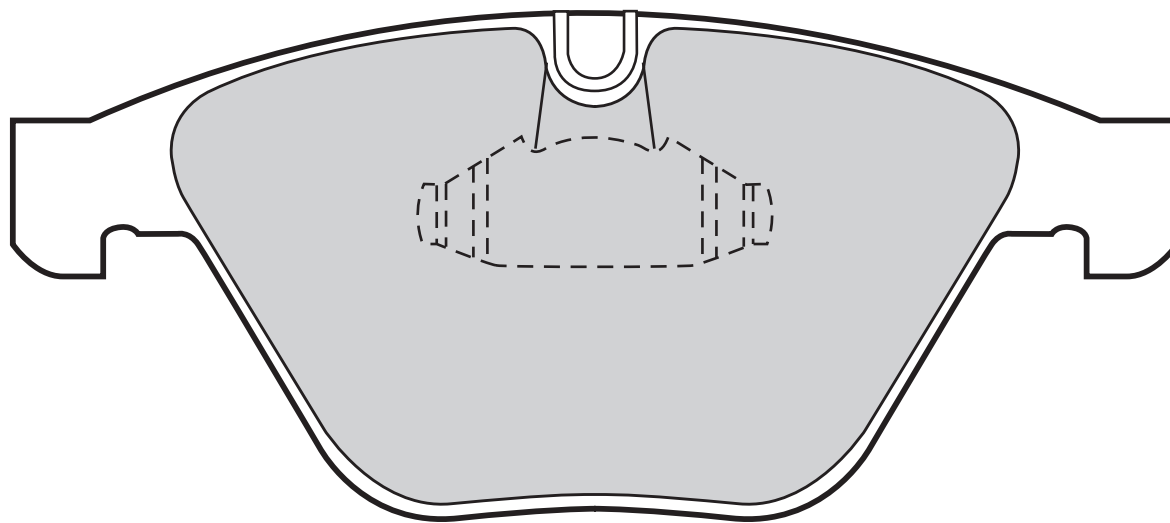

598410

0

155,3

68,5

19,8

TEVES

BMW

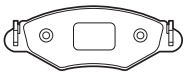

Valeo

23313 (WVA)

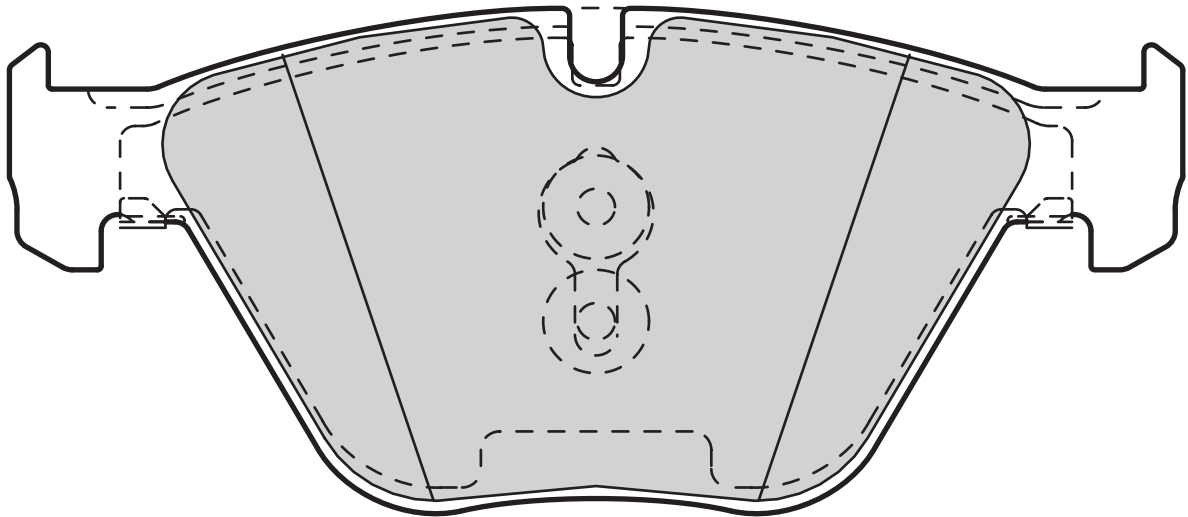
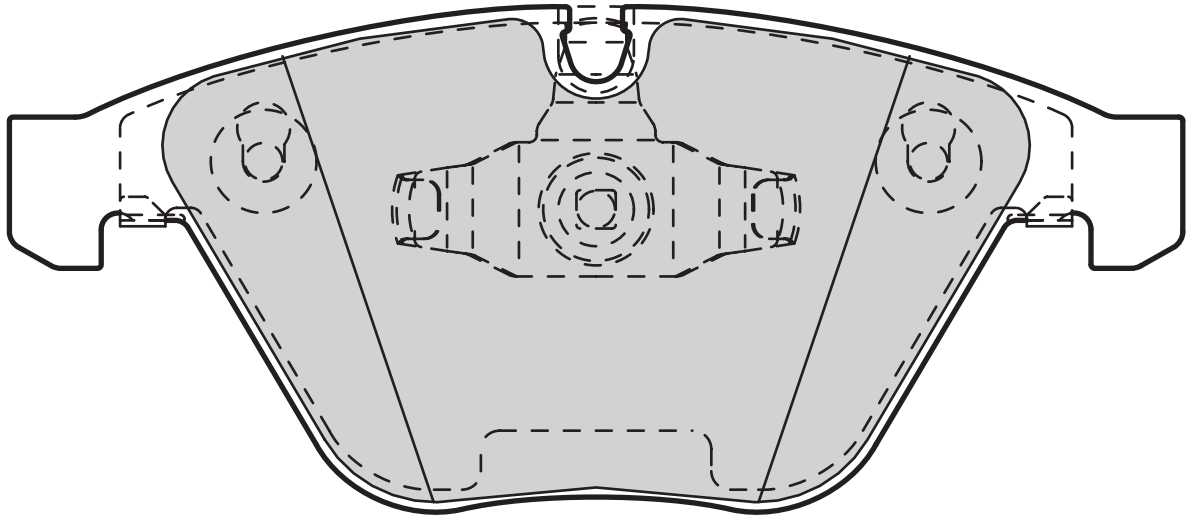

Valeo



0

Valeo



155,3



68,5



19,8



TEVES



BMW

601027

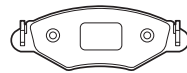

23314 (WVA)

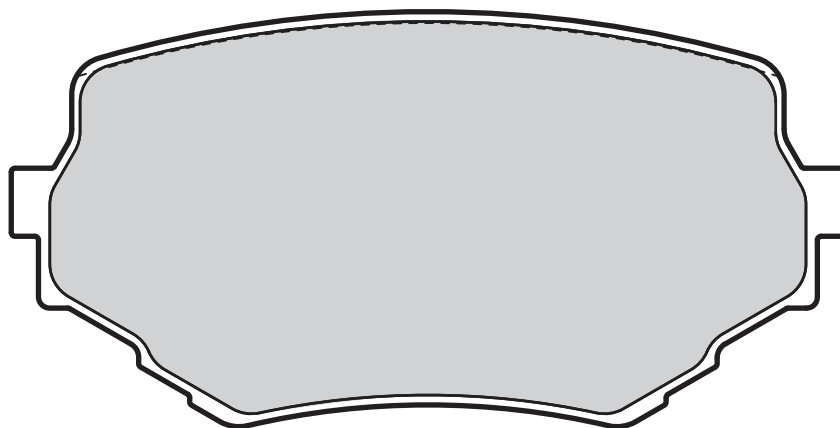

Valeo



Valeo



598534

2

110,2

54,9

14,5

AKEBONO

SUZUKI

23316 (WVA)

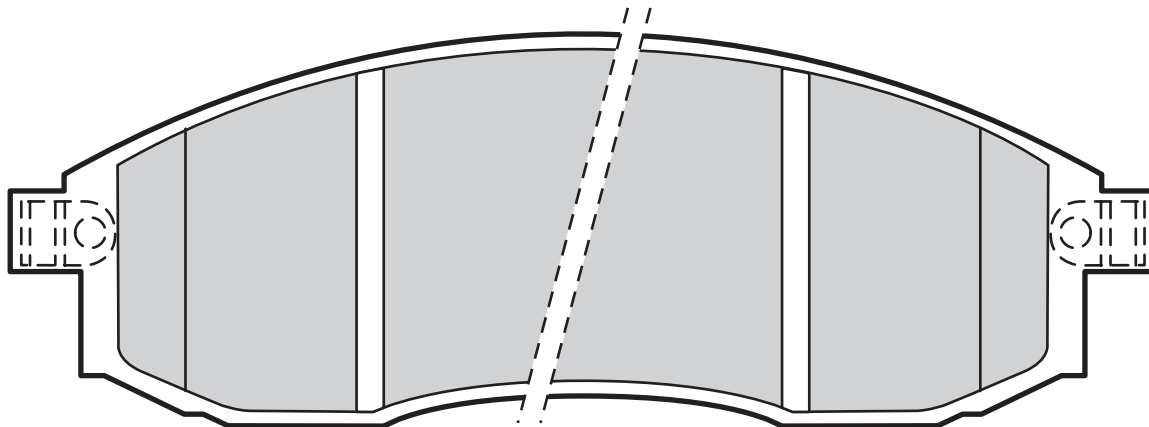

Valeo



Valeo



598523

2

151,3

52

16

AKEBONO

mitsubishi, nissan



23320 (WVA)

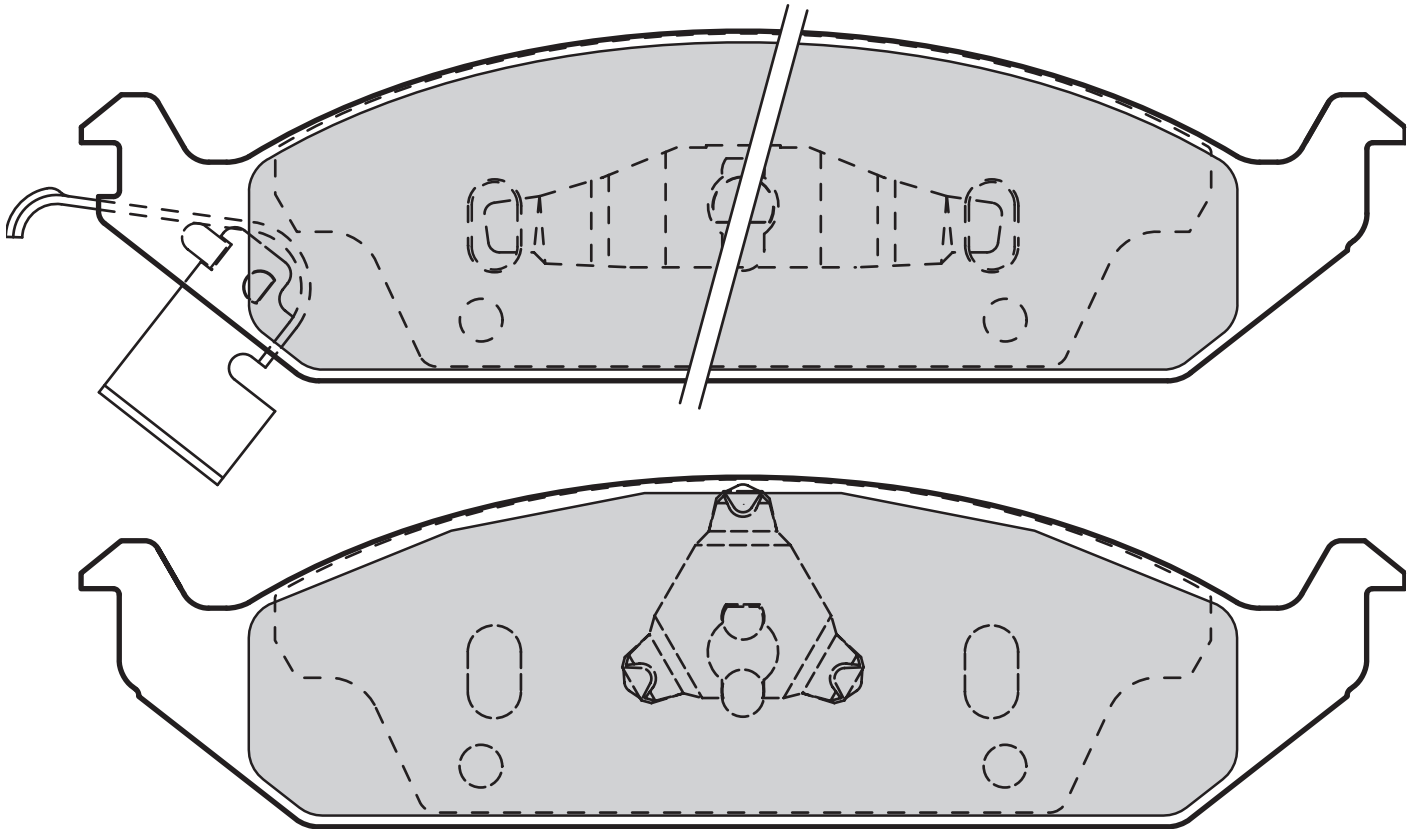

598904	4	Leaf	176,8	46,5	16/17	BENDIX	CHRYSLER	

23326 (WVA)

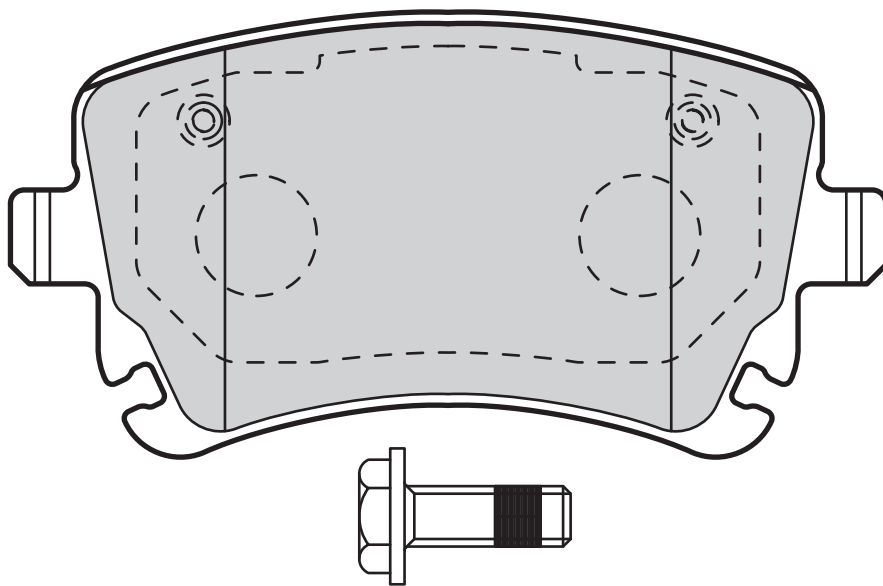

598671	1	170	116,2	59	17,5	LUCAS	VOLKSWAGEN	
601004	0		116	58,9	17,4	LUCAS	AUDI, VOLKSWAGEN	

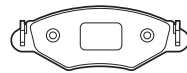

23329 (WVA)

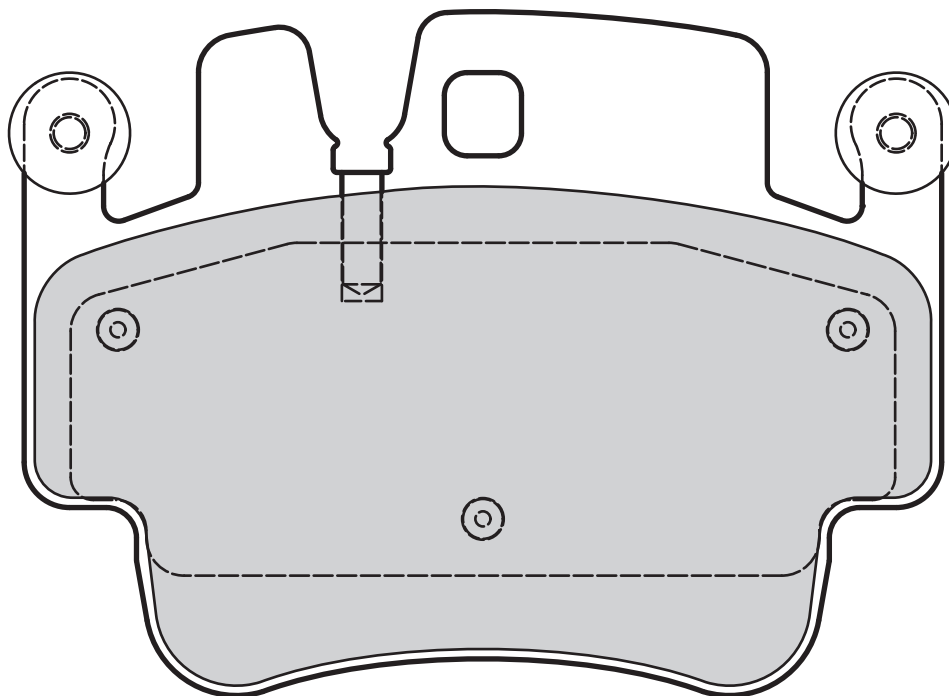

Valeo



Valeo



598767

0

125

90,2

17

BREMBO

PORSCHE

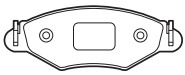

23334 (WVA)

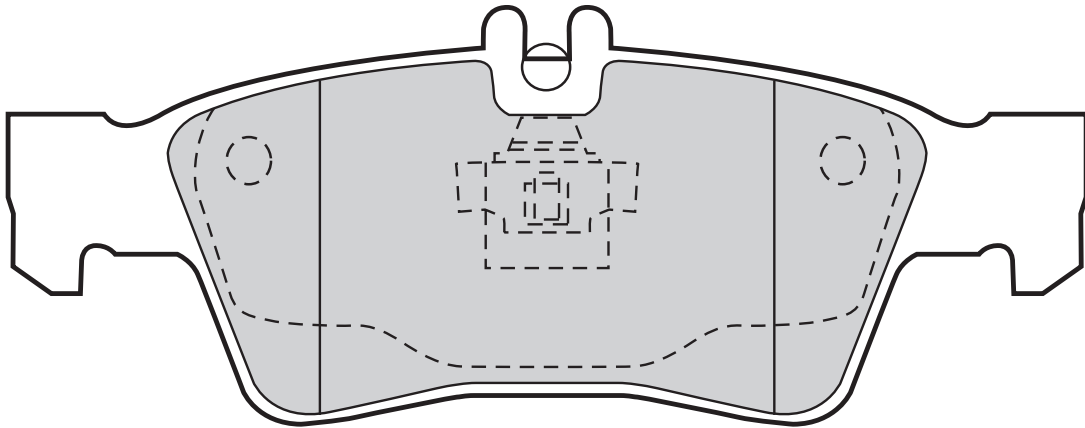
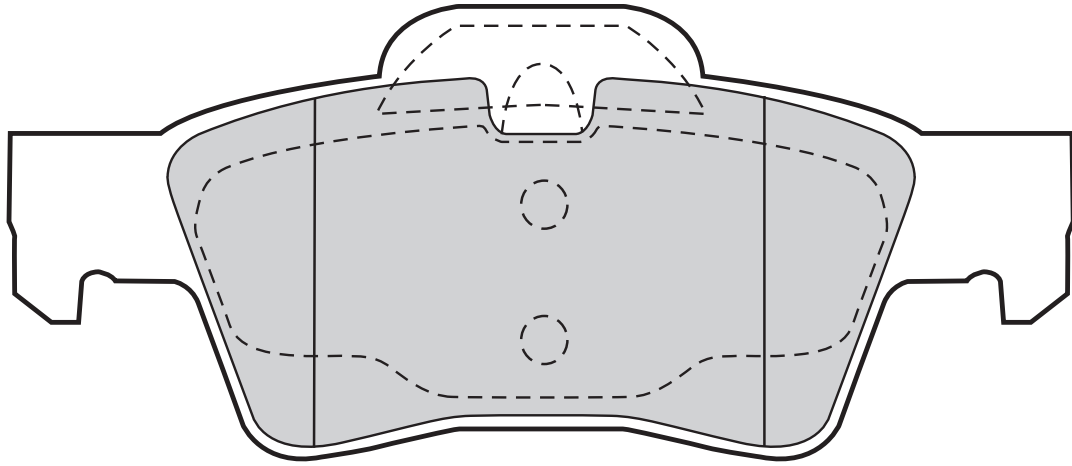

Valeo



Valeo



598637

0

141,5

57,5

16,5

TEVES

MERCEDES

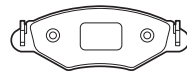

23339 (WVA)

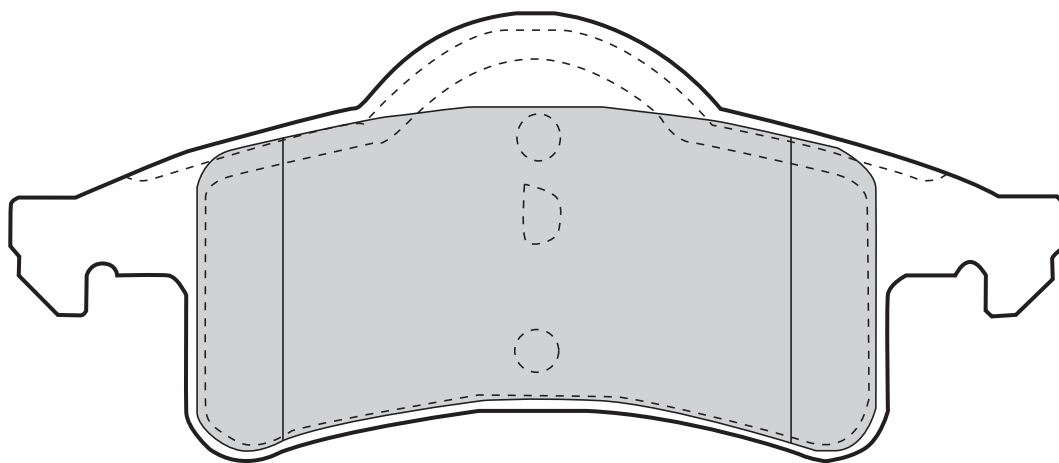
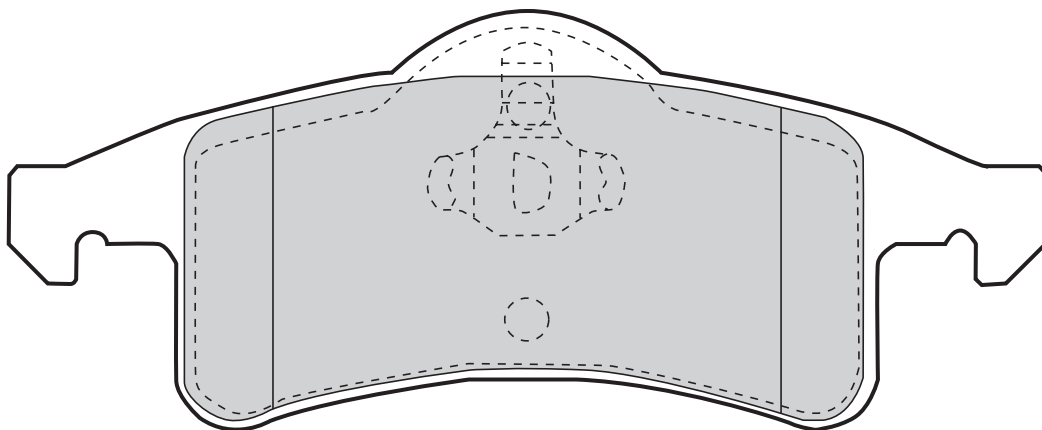

Valeo



Valeo



598677

0

141,4

59,2

17,8

TEVES

JEEP

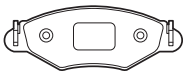

Valeo

23340 (WVA)

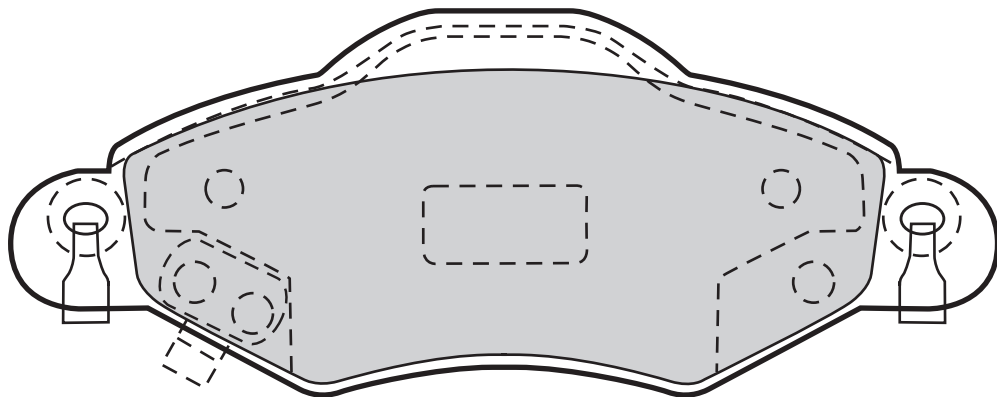
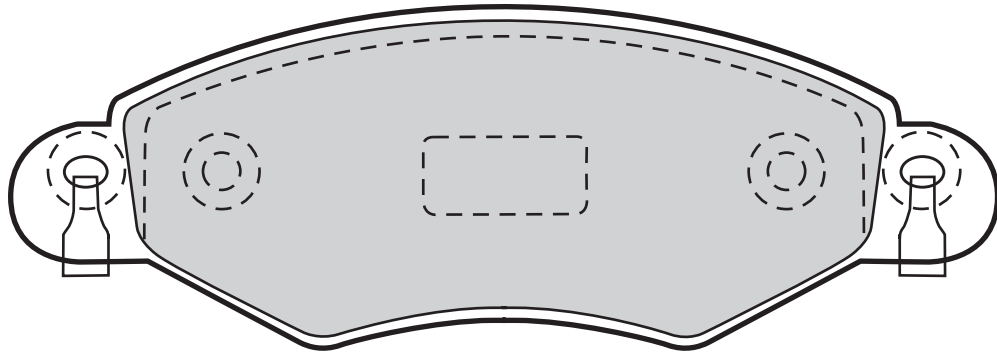

Valeo



Valeo



598736

2

130,6

51/44,9

16,8

BOSCH

TOYOTA

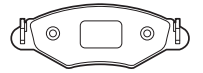

23347 (WVA)

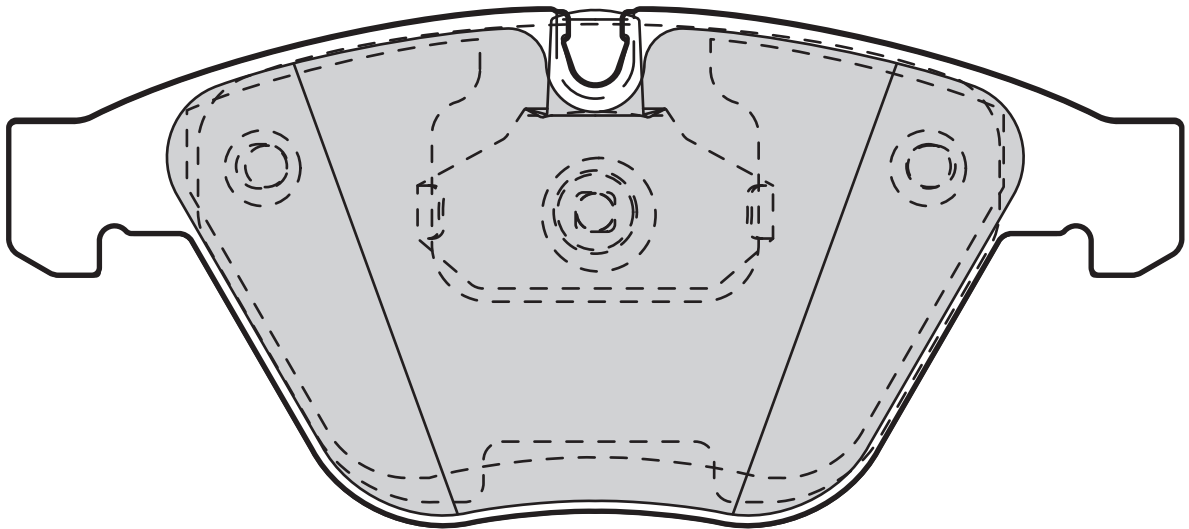
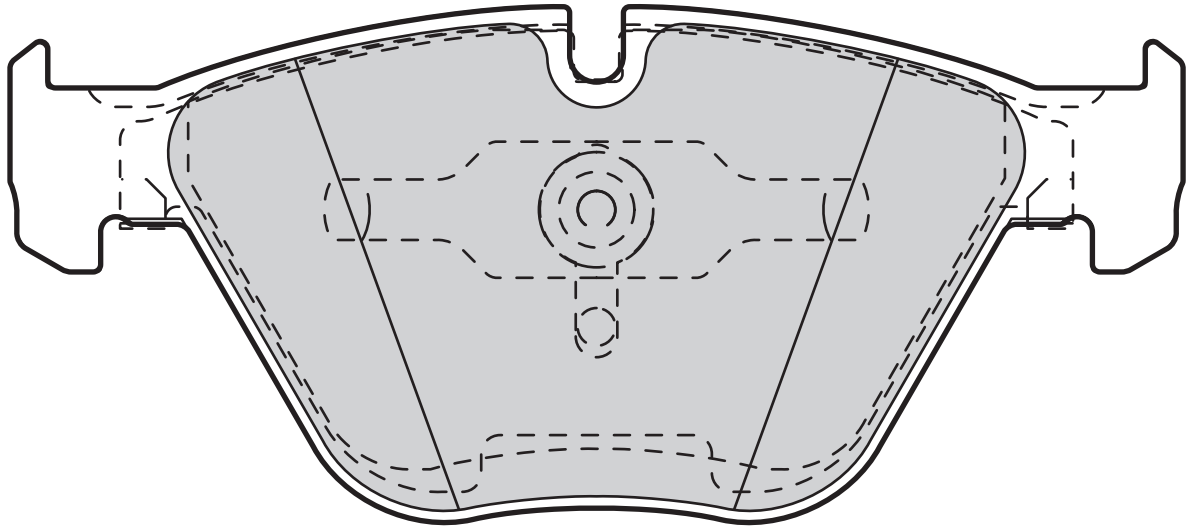

Valeo



Valeo



598898

0

155

68,3

20

TEVES

BMW

23348 (WVA)

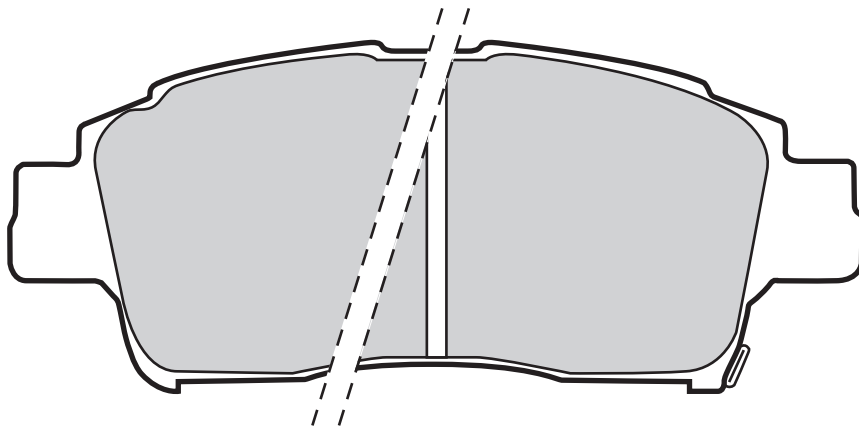

Valeo



Valeo



598606

2

112,5

46,8

16,5

AKEBONO

TOYOTA



23349 (WVA)

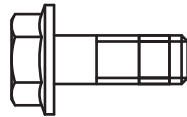
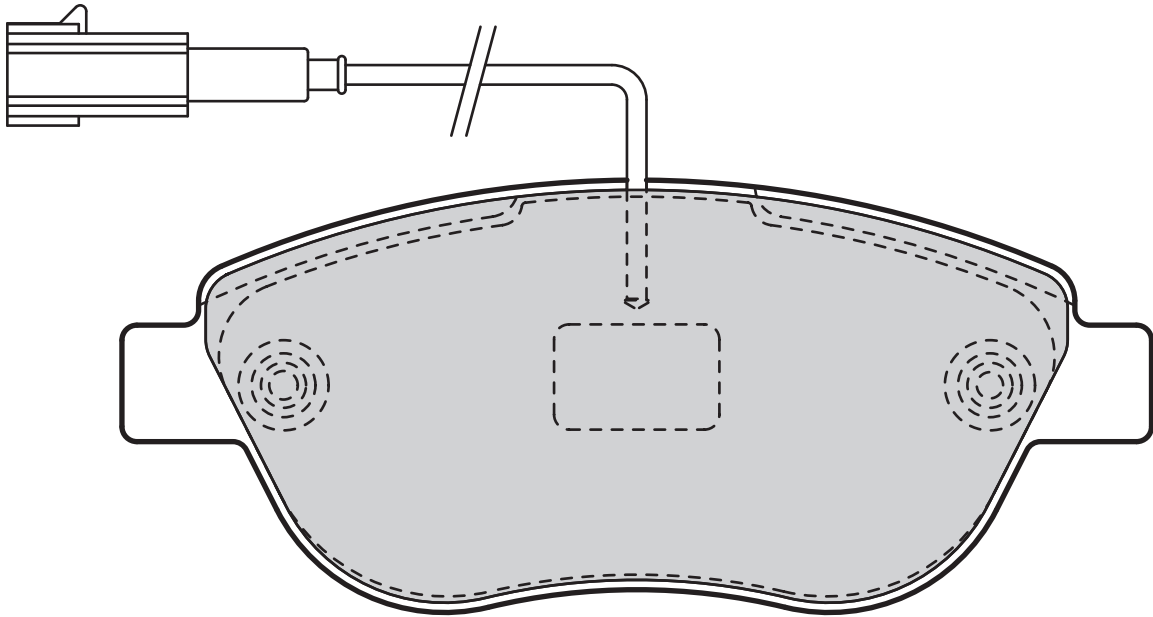

Valeo



Valeo



598721

1

215

137

57,4

19

BOSCH

ABARTH, FIAT

23353 (WVA)

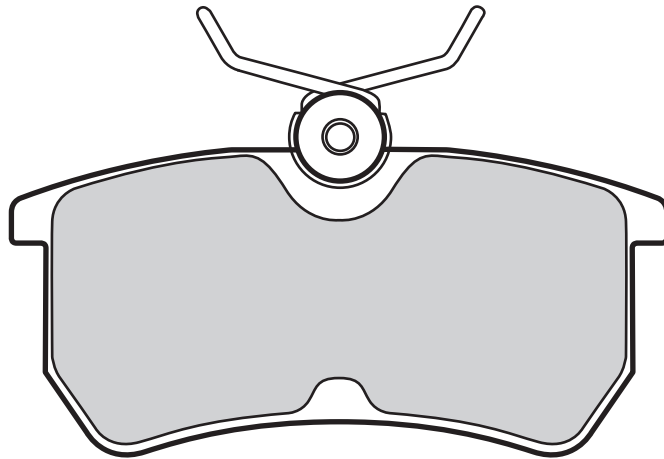

Valeo



Valeo



598431

1

300

87,2

42,5

14,5

LUCAS

FORD

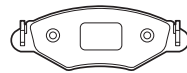

23354 (WVA)

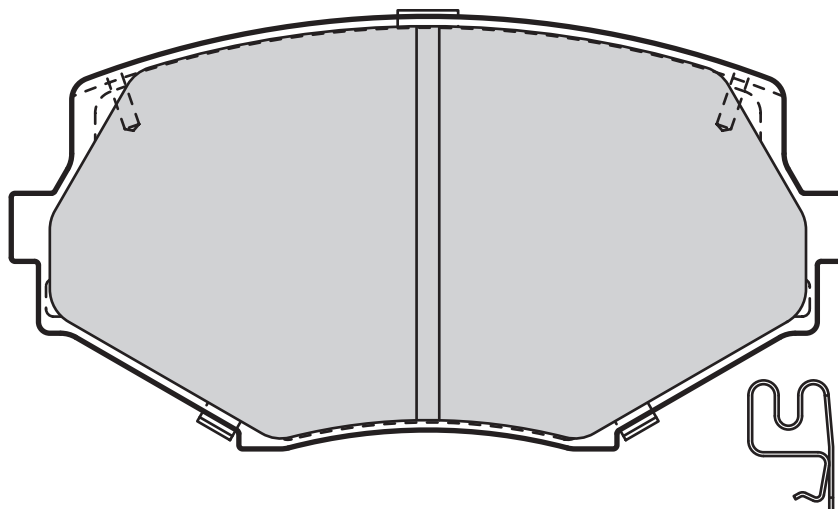

Valeo



Valeo



598836

2

110,2

57,2

13,8

SUMITOMO

MAZDA

23358 (WVA)

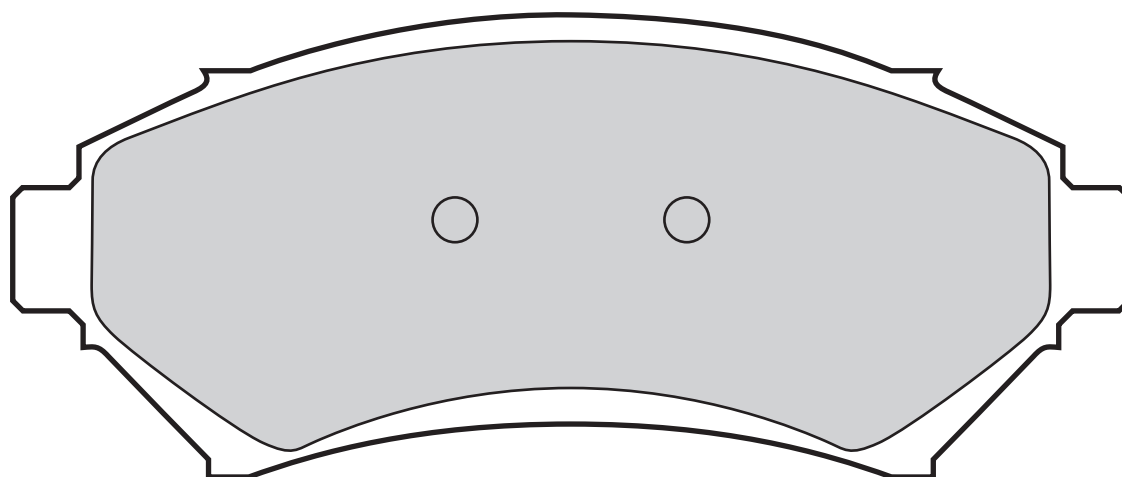

Valeo



Valeo



598458

2

148

61,5

18

G.M.E

OPEL, VAUXHALL



23361 (WVA)

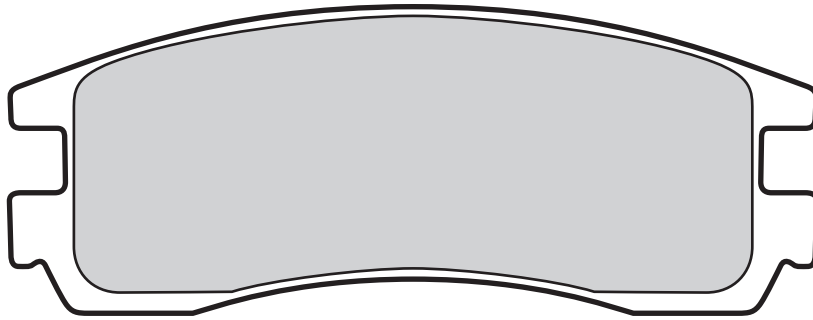

2



107,8



41



14,6



AKEBONO



OPEL, VAUXHALL

598459

23381 (WVA)

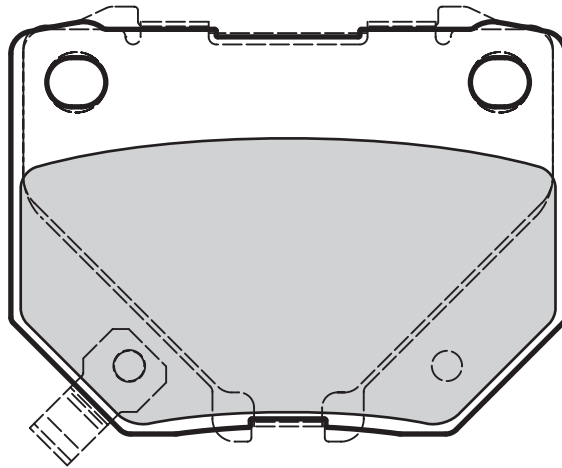
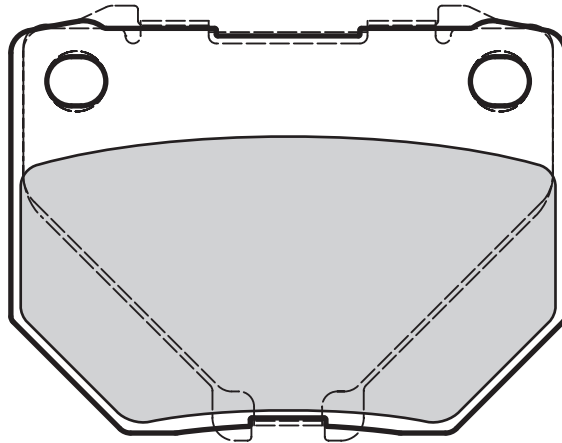

1



Leaf



73



54,5



17



AKEBONO



SUBARU

598916

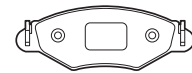

23395 (WVA)

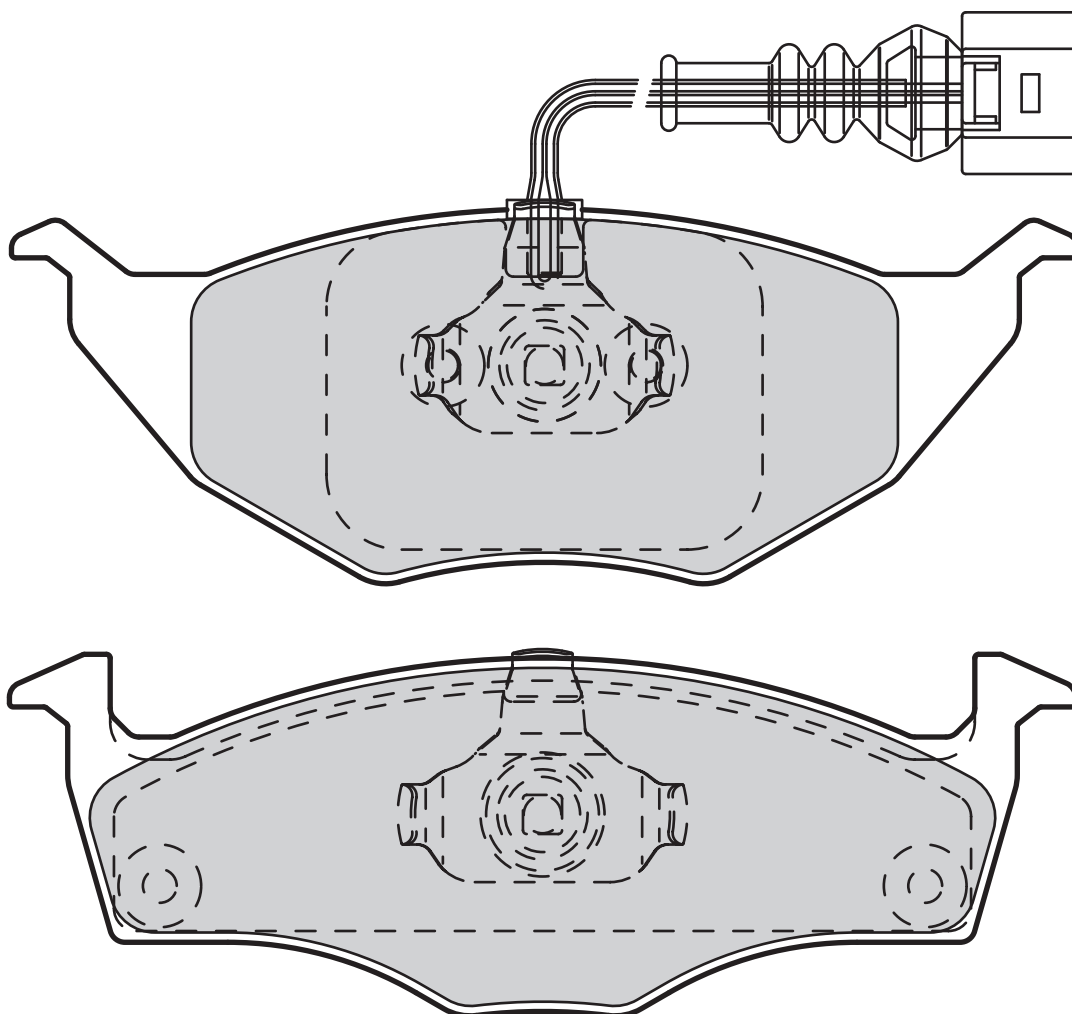

Valeo									
598734	1	235	141,8	48,1	14,3	KELSEY	AUDI		
598735	0		141,8	49,8	14,4	TEVES	VOLKSWAGEN		

23396 (WVA)

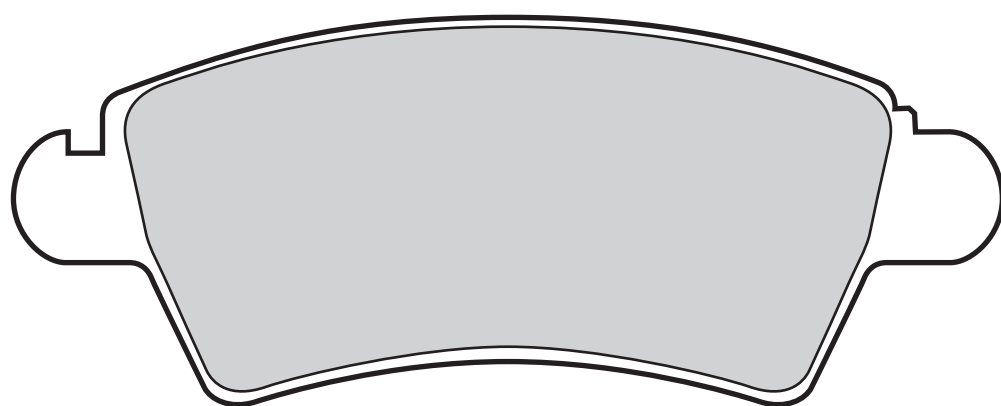

Valeo									
598462	0	131	52,2	17,8	BOSCH	CITROËN, PEUGEOT			

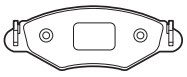

23399 (WVA)

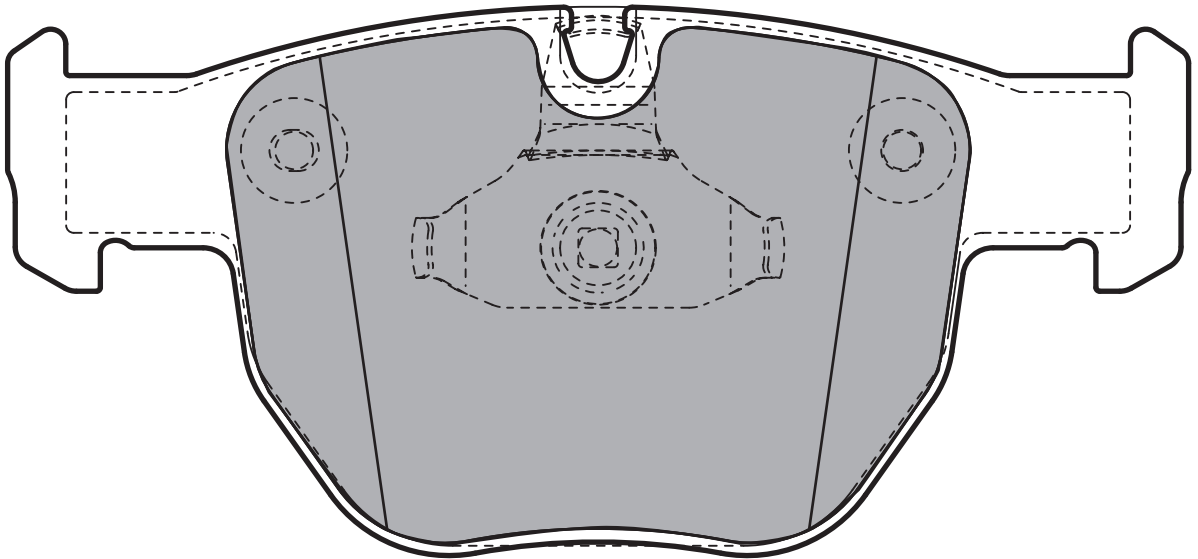
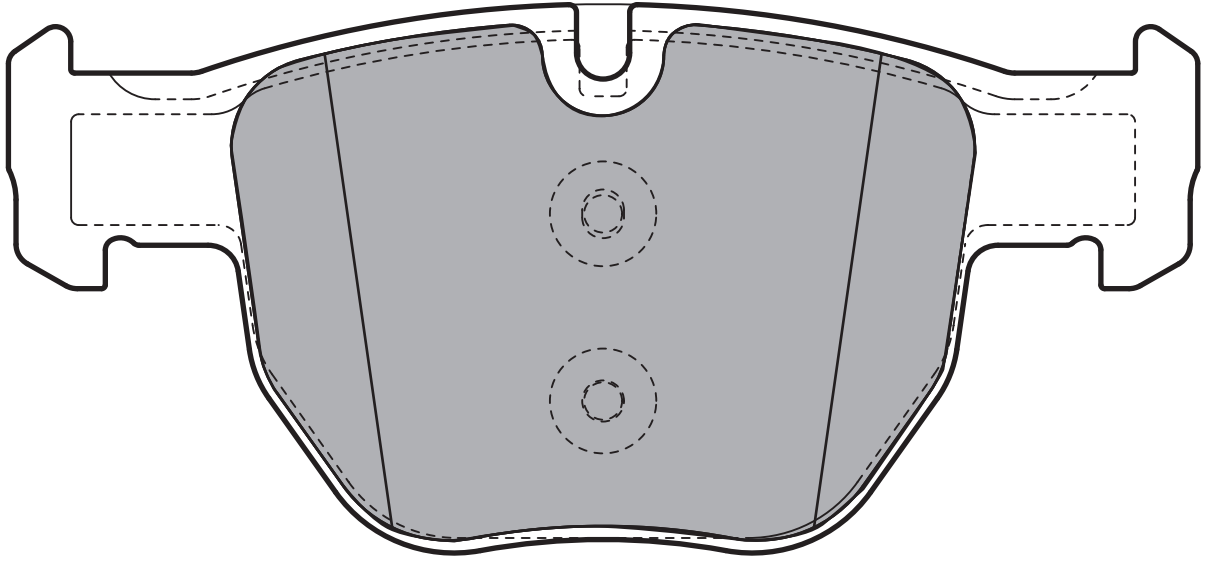

Valeo



Valeo



598658

0

156,3

73,5

19,4

TEVES

LAND ROVER

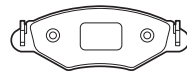

23400 (WVA)

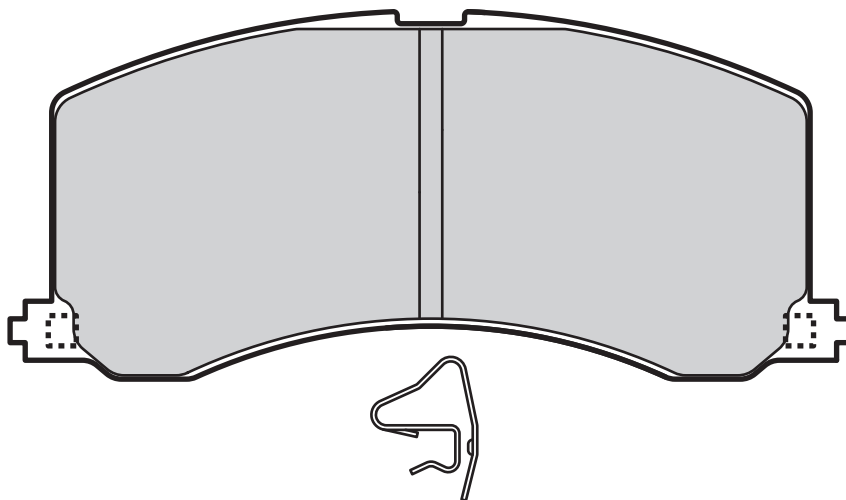

Valeo



4

Valeo



111,3



48,6



15



SUMITOMO



SUZUKI

598830

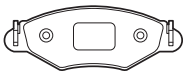

23402 (WVA)

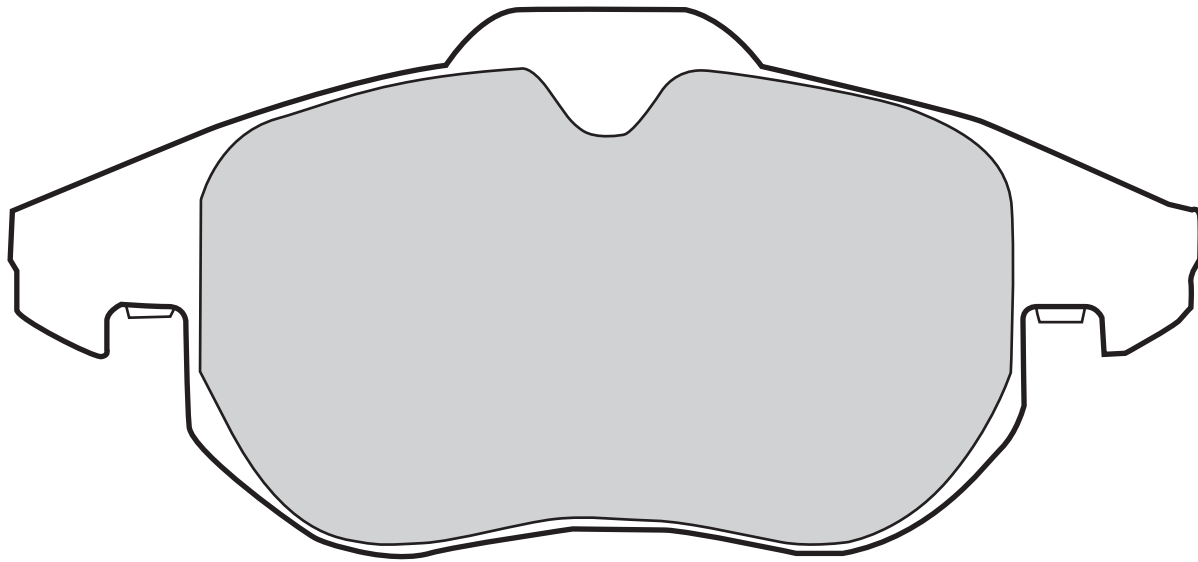
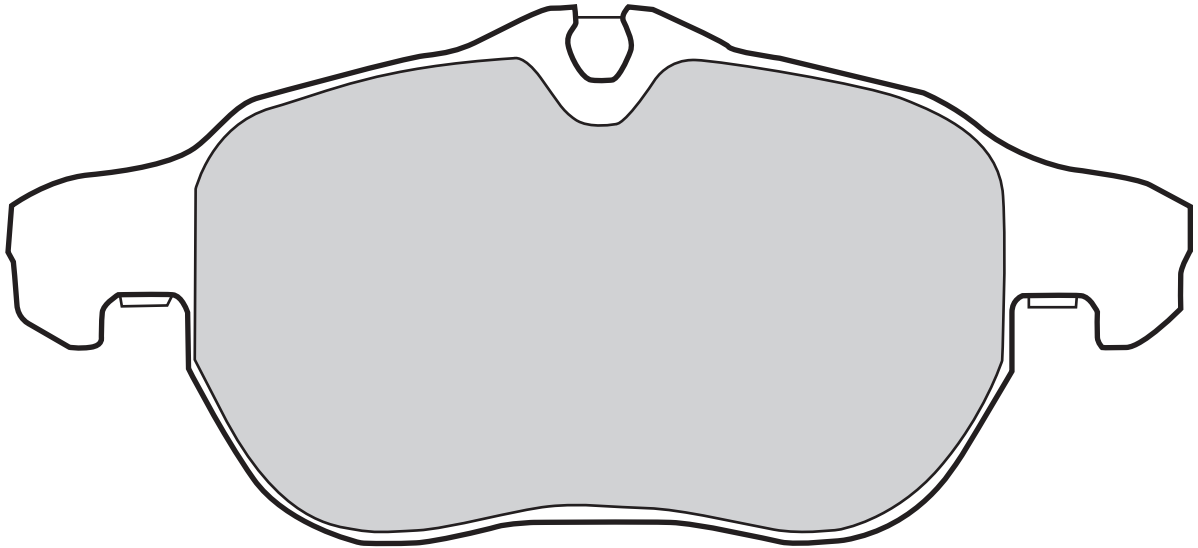

Valeo



0

Valeo



156,5



71



20,3



TEVES



CADILLAC, FIAT, OPEL, SAAB, VAUXHALL

598678

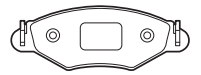

23407 (WVA)

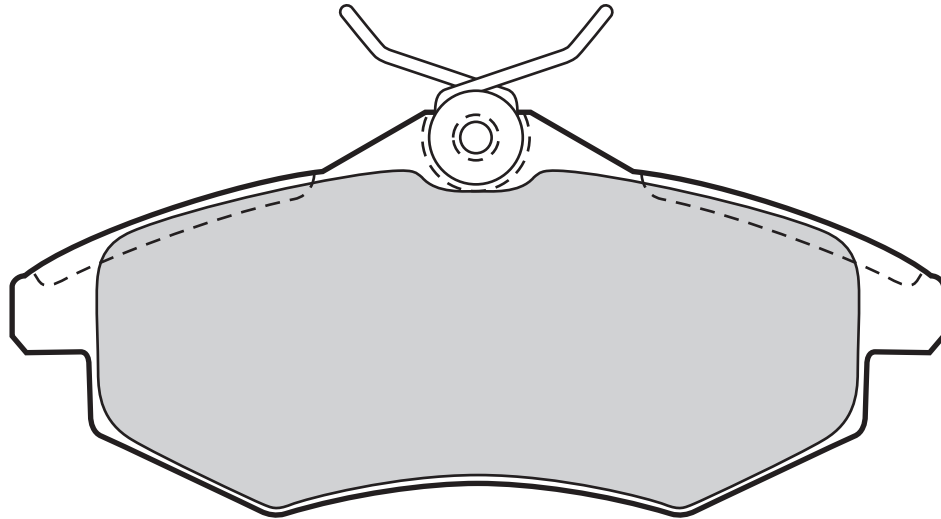

Valeo



Valeo



598500

0

122,8

53

19,3

LUCAS

CITROËN

23409 (WVA)

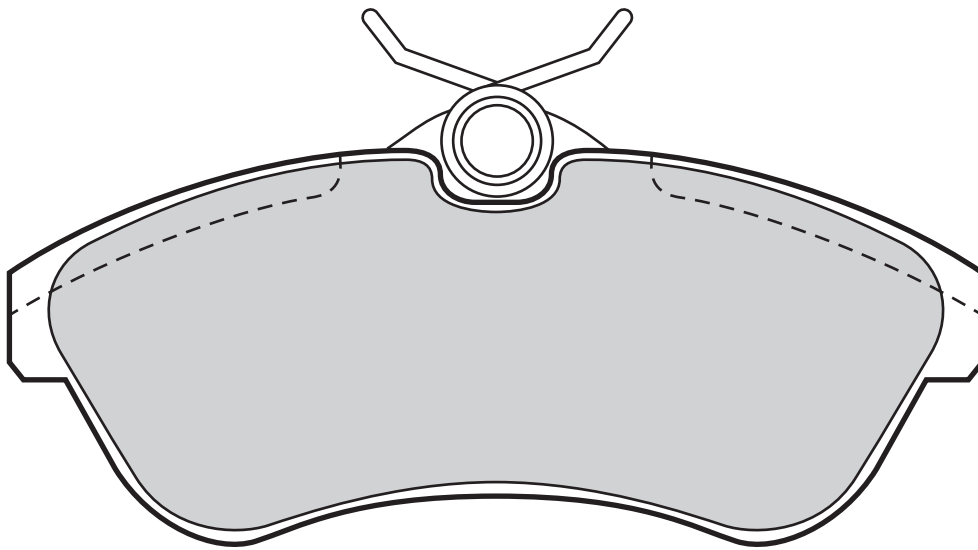

Valeo



Valeo



598501

0

129

56,2

19,3

LUCAS

CITROËN

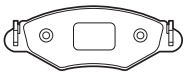

23417 (WVA)

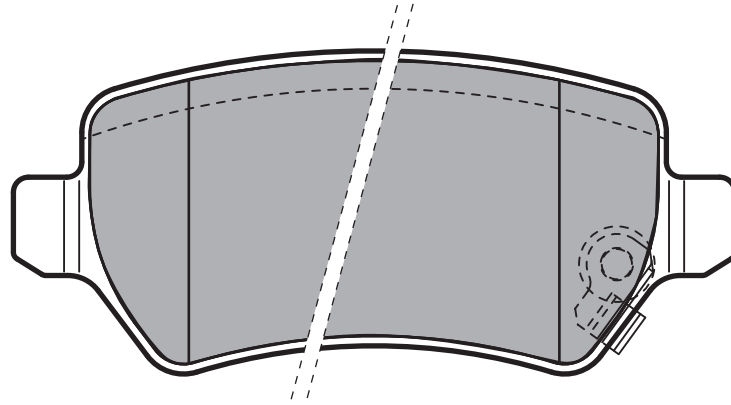

Valeo



2

Valeo



95,5



42,7



15,2



LUCAS



OPEL, VAUXHALL

598584

23420 (WVA)

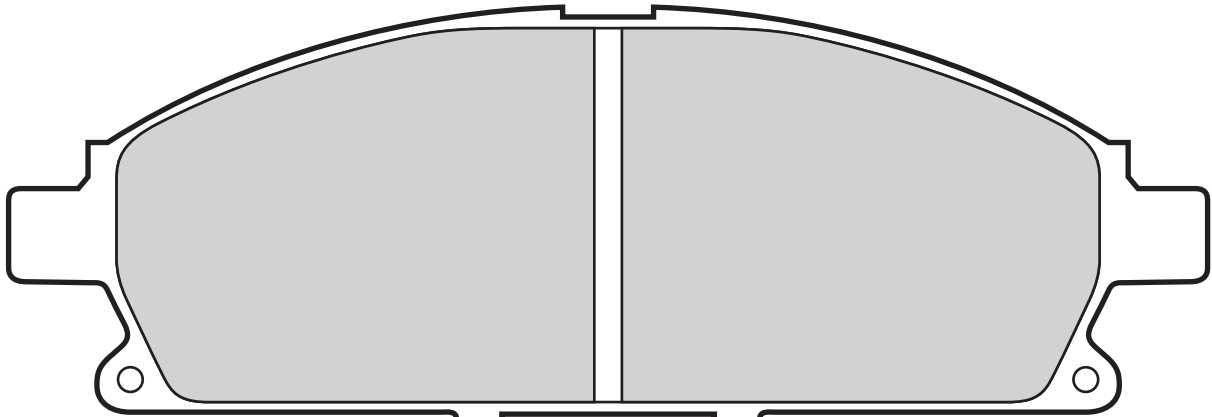

Valeo



0

Valeo



159



56



16



NISSIN



NISSAN

598452



23423 (WVA)

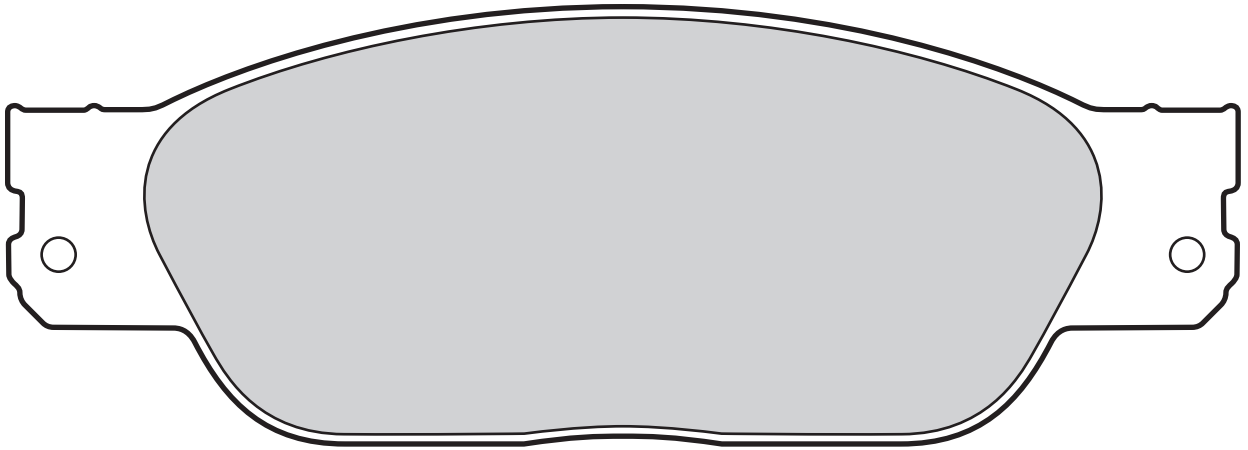

598439

0

163,3

58

17,8

LUCAS

JAGUAR

23424 (WVA)

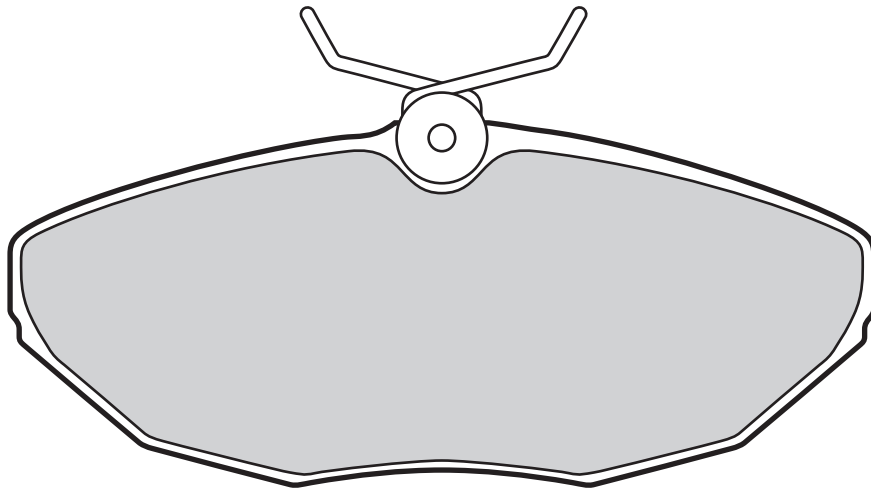

598438

0

114,3

49,6

17,8

LUCAS

JAGUAR



23425 (WVA)

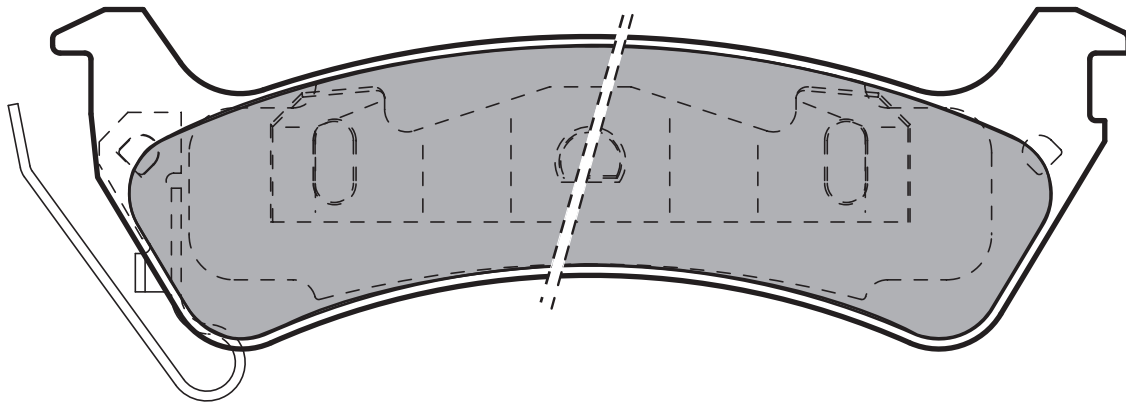
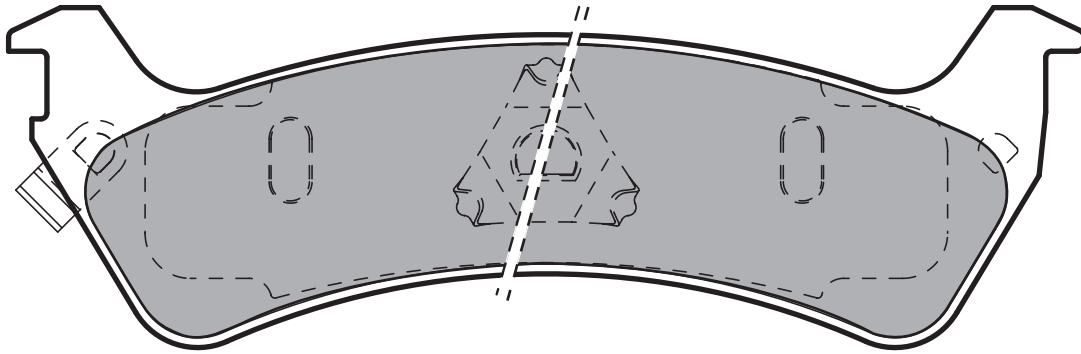

Valeo



Valeo



598509

2

141,1

45,3

15

KELSEY

JEEP

23429 (WVA)

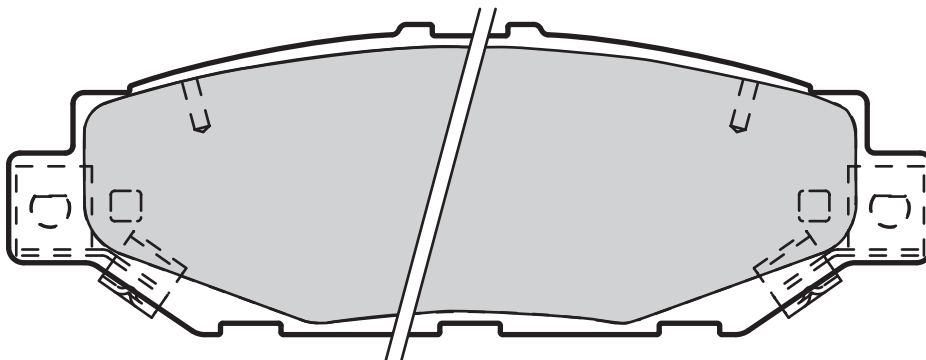

Valeo



Valeo



601022

4

Leaf

122

41

15,5

SUMITOMO

LEXUS, TOYOTA

601025

2

Leaf

57,2

63,8

15,5

SUMITOMO

LEXUS



23432 (WVA)

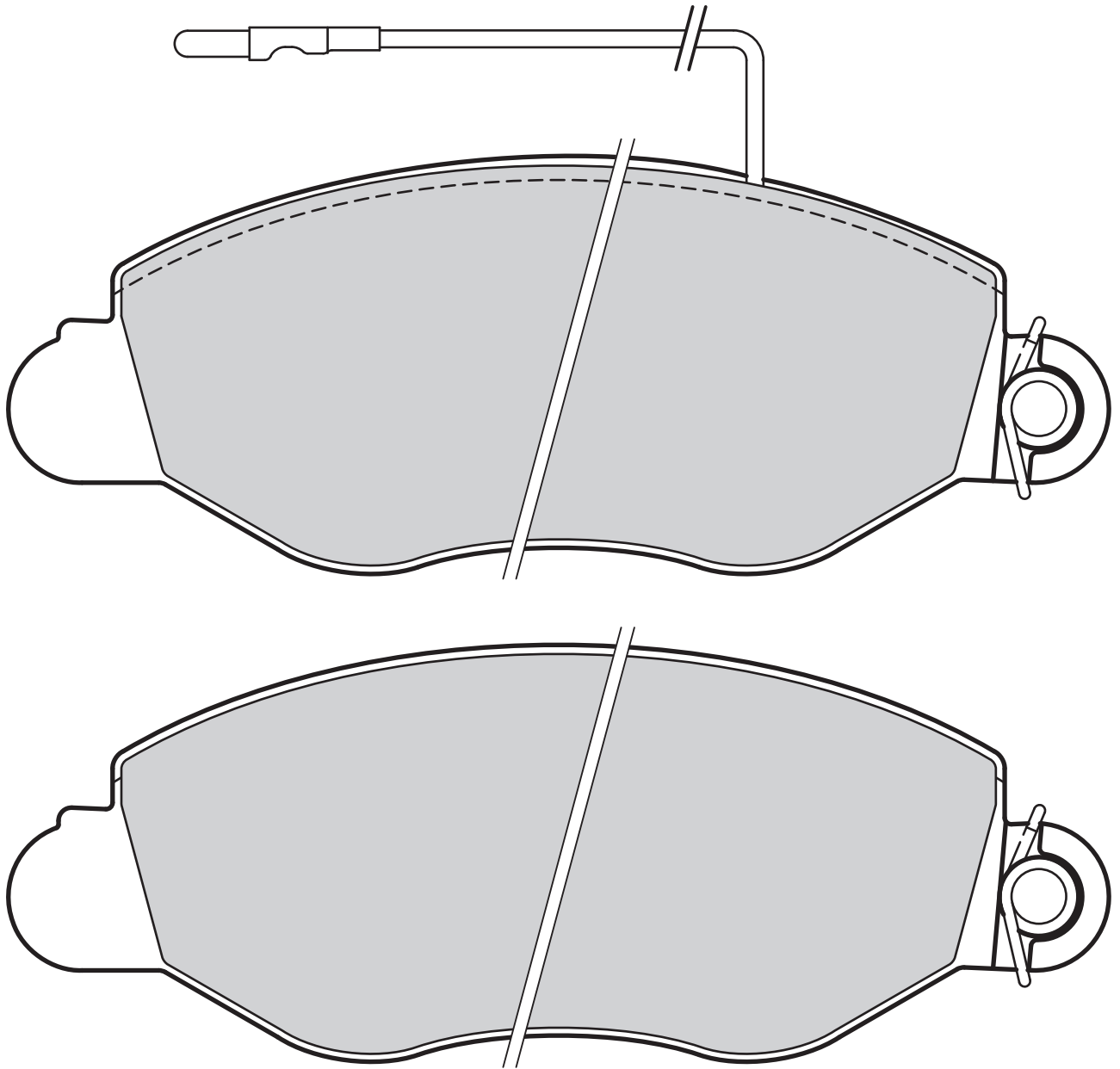

Valeo



Valeo



541733

2

Leaf

169

64

17,6

BOSCH

NISSAN

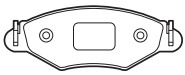

Valeo

23440 (WVA)

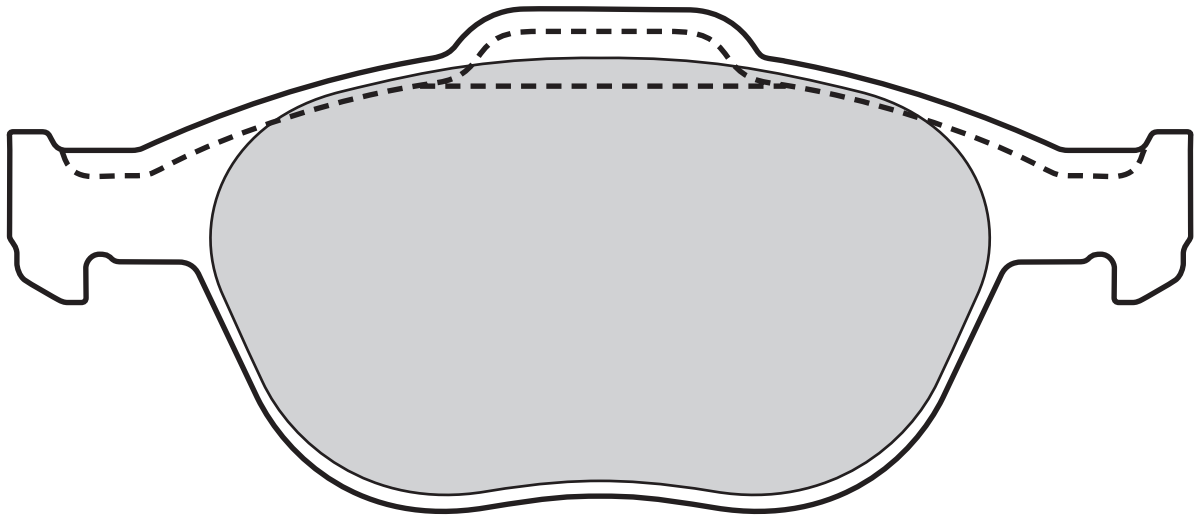
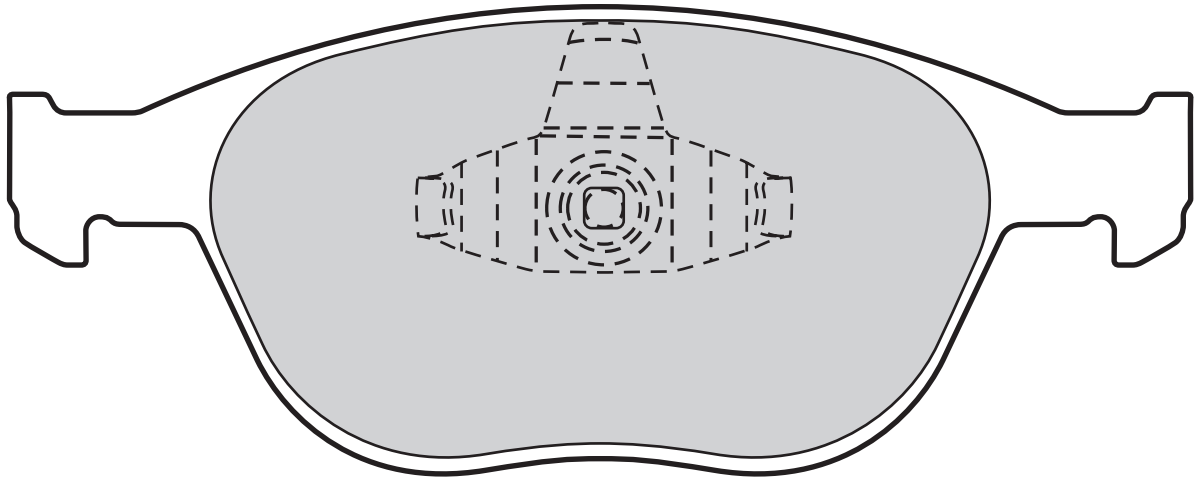

Valeo



Valeo



598639

0

156,3

67,2

18,1

TEVES

FORD

23442 (WVA)

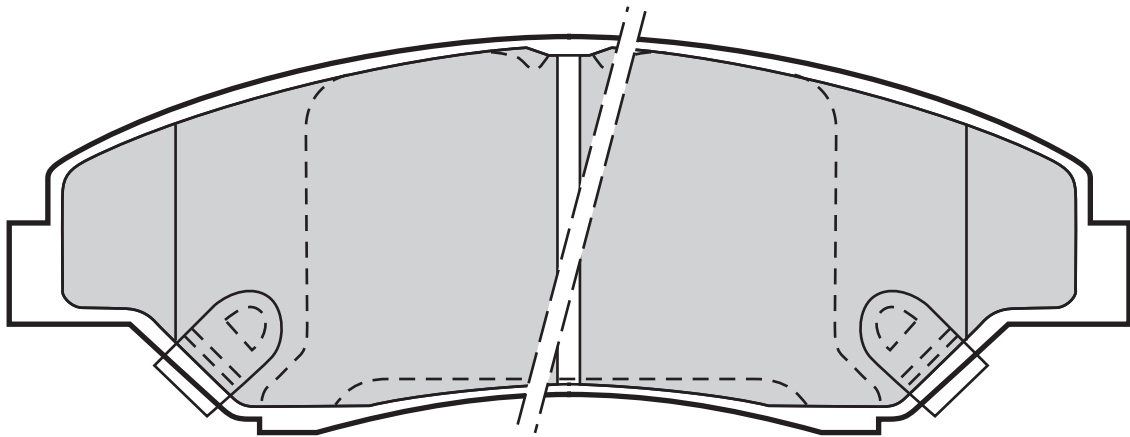

Valeo



Valeo



598511

2

149

53

16

MANDO

KIA

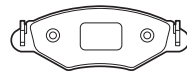

23446 (WVA)

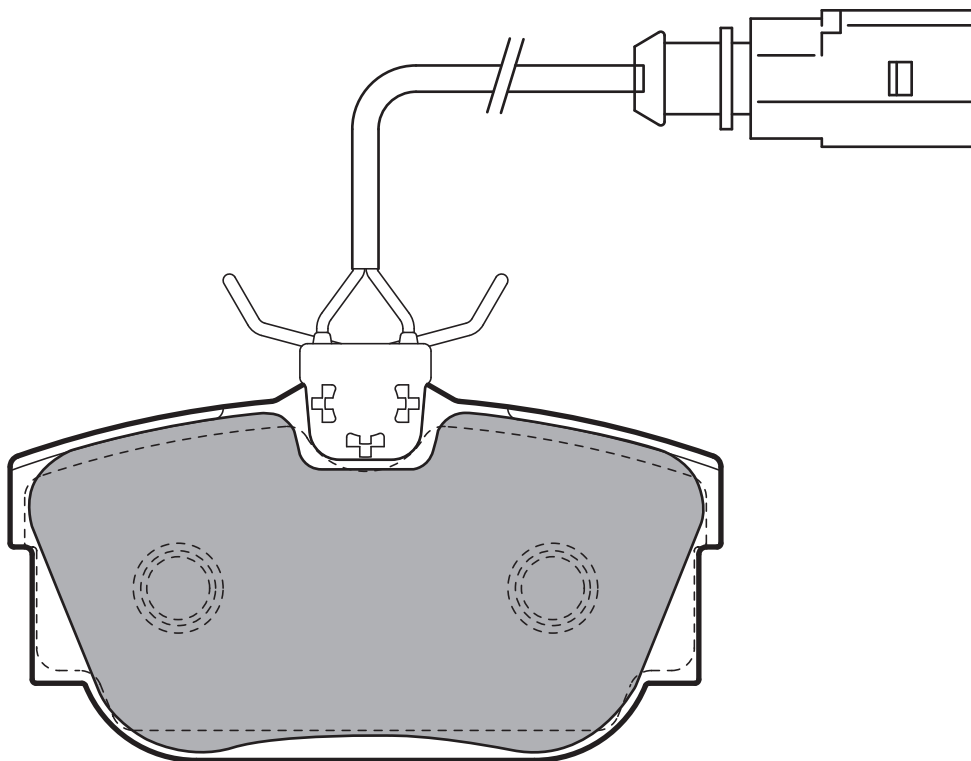

Valeo



Valeo



598650

2

205

95

51

16,2

LUCAS

SEAT, VOLKSWAGEN

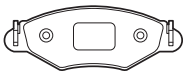

Valeo

23449 (WVA)

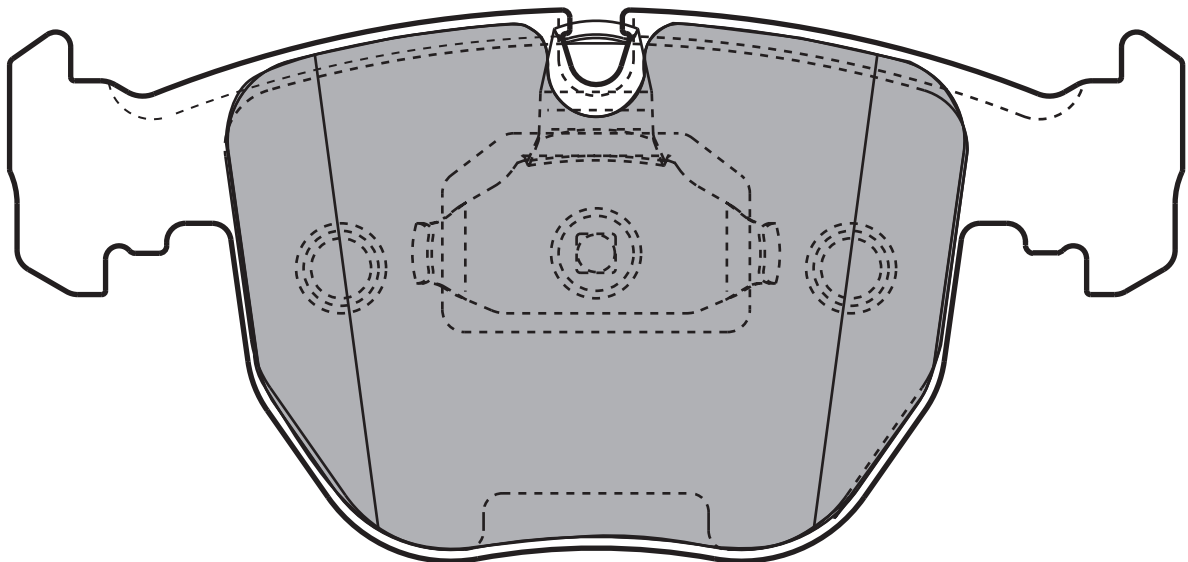
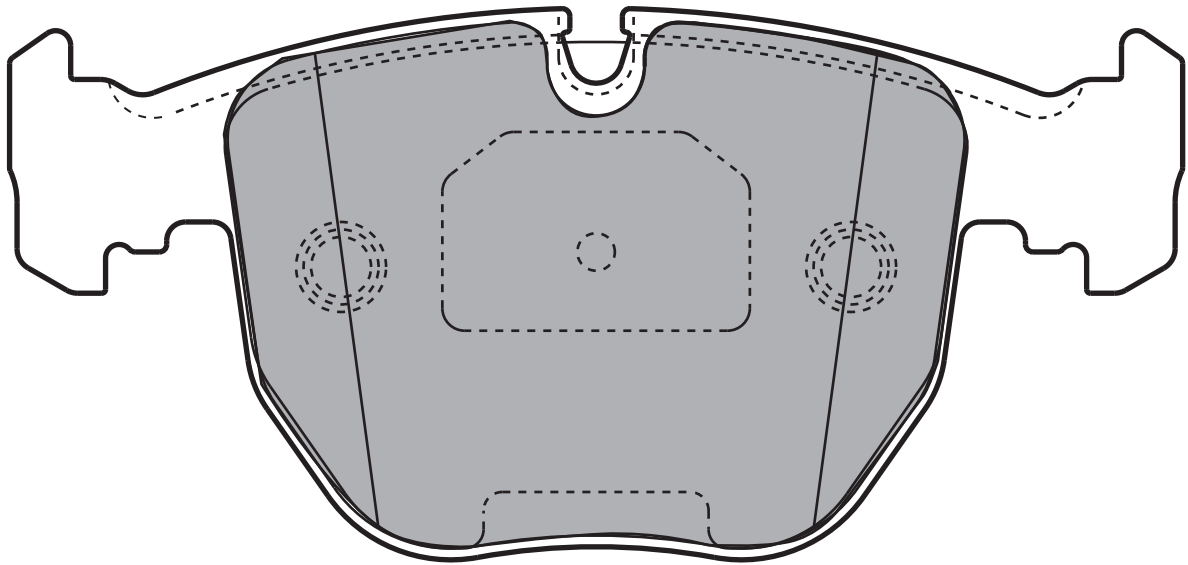

Valeo



Valeo



598412

0

156,4

73,6

19

TEVES

BMW

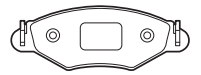

23452 (WVA)

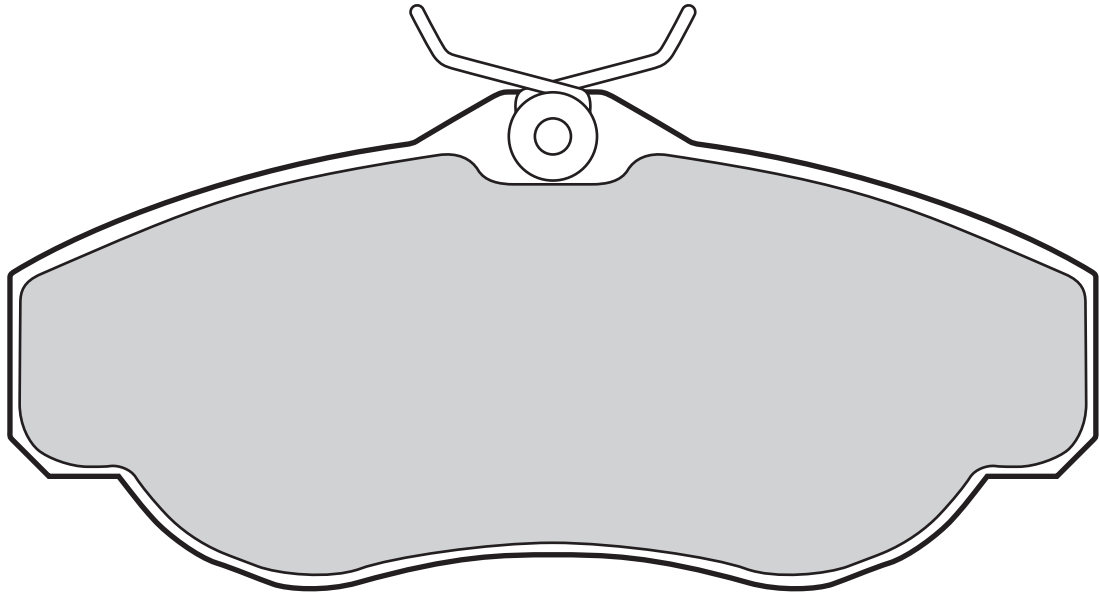

598441	0		144,9	66,4	19	LUCAS	LAND ROVER		

23454 (WVA)

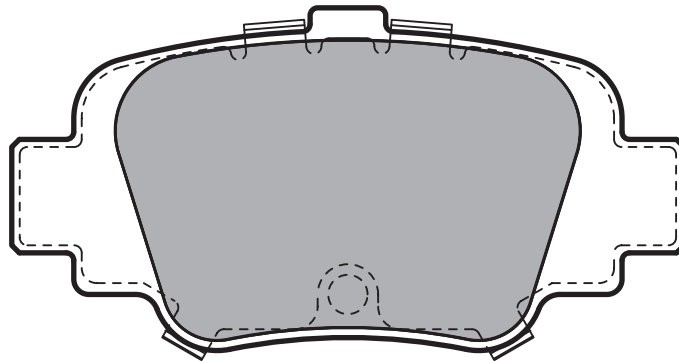

598642	0		88,9	45	15	AKEBONO	NISSAN		

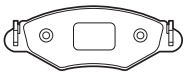

Valeo

23455 (WVA)

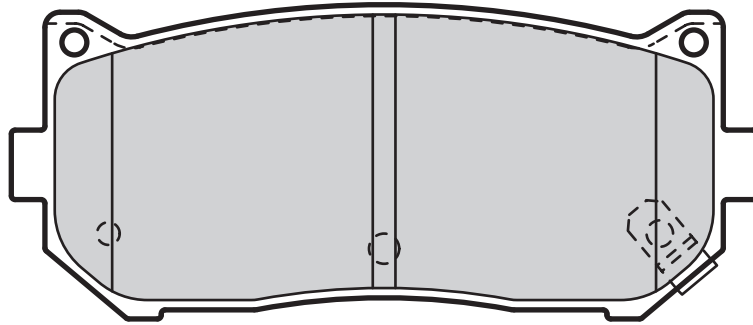

Valeo



Valeo

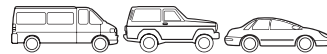

598841

2

98,6

41,6

13,7

SUMITOMO

KIA



23467 (WVA)

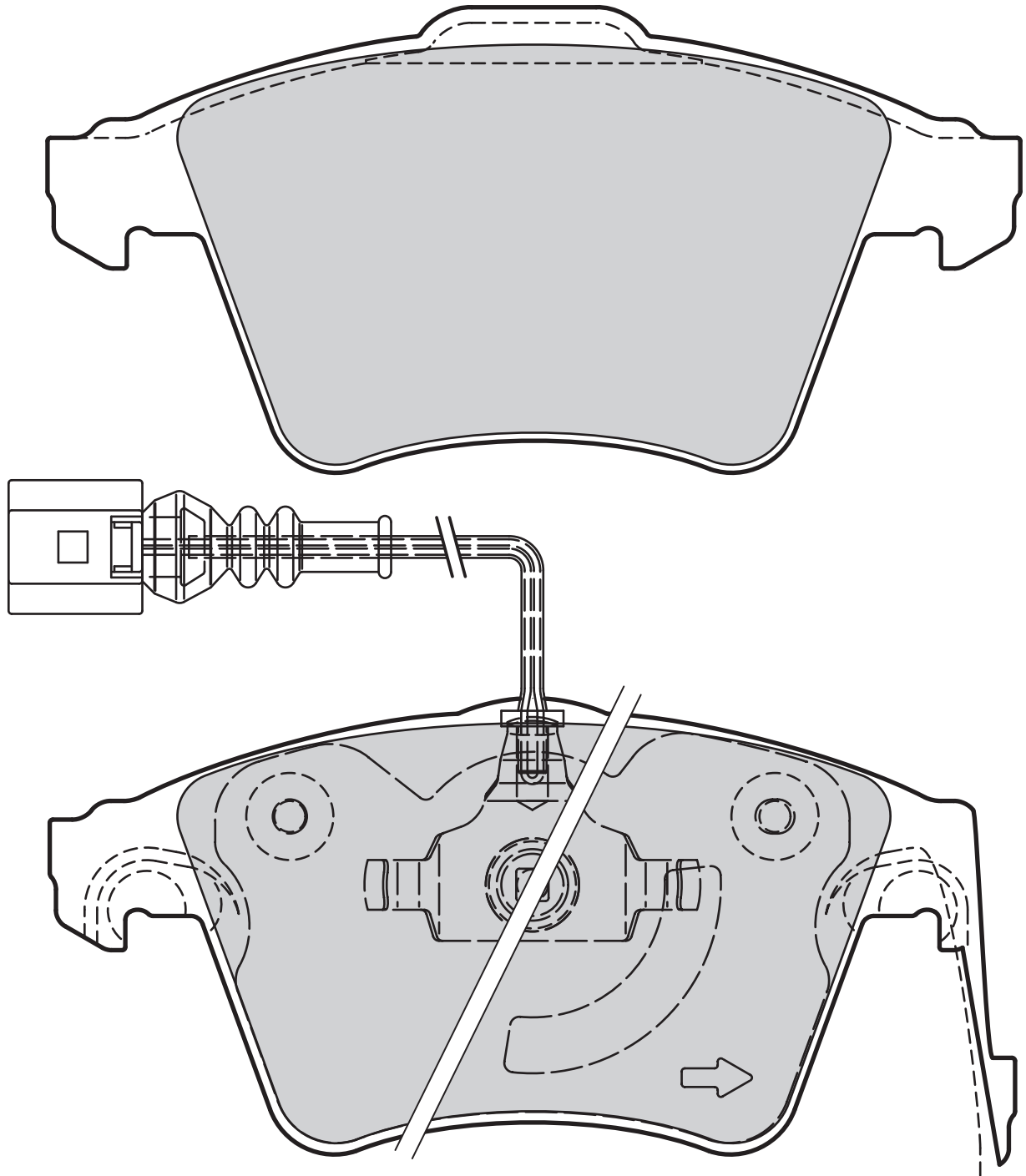

Valeo



Valeo



Leaf



155



73



20



TEVES



VOLKSWAGEN



598940

2



23471 (WVA)

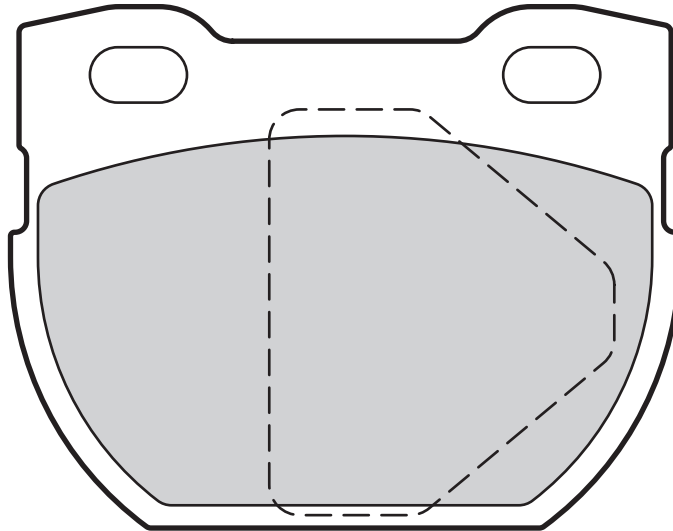

Valeo



Valeo



598762

88,5

68,8

14,5

AP

LAND ROVER

23472 (WVA)

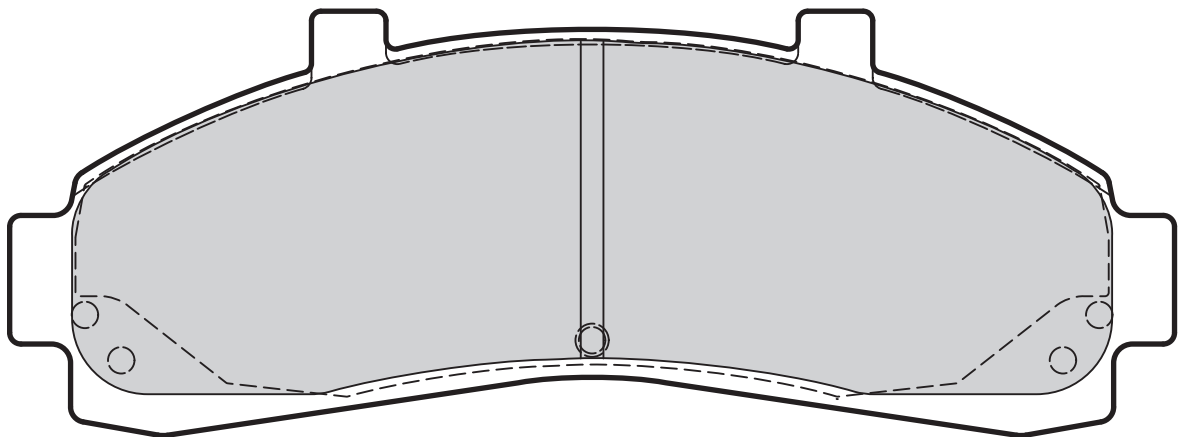
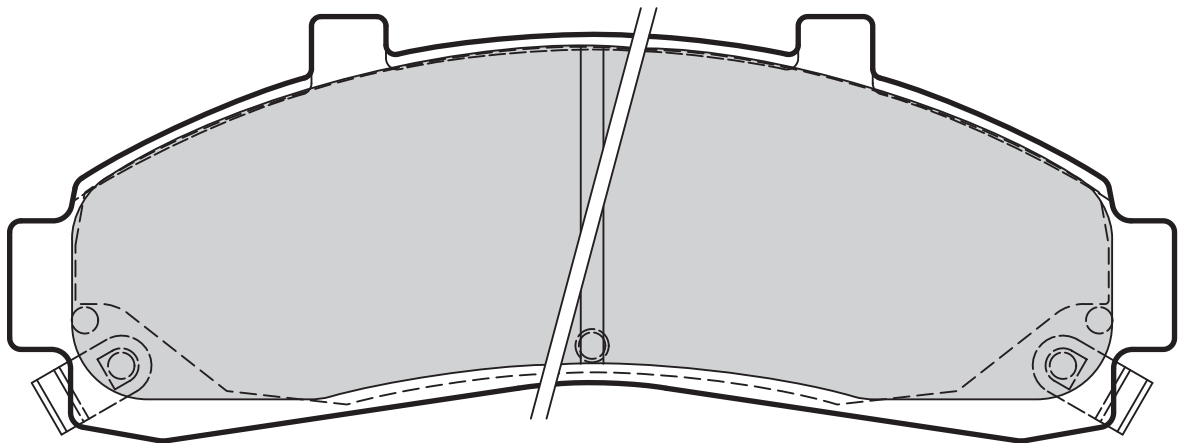

Valeo



Valeo



598906

2

Leaf

154

56,5

17

WAGNER

FORD

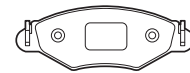

23482 (WVA)

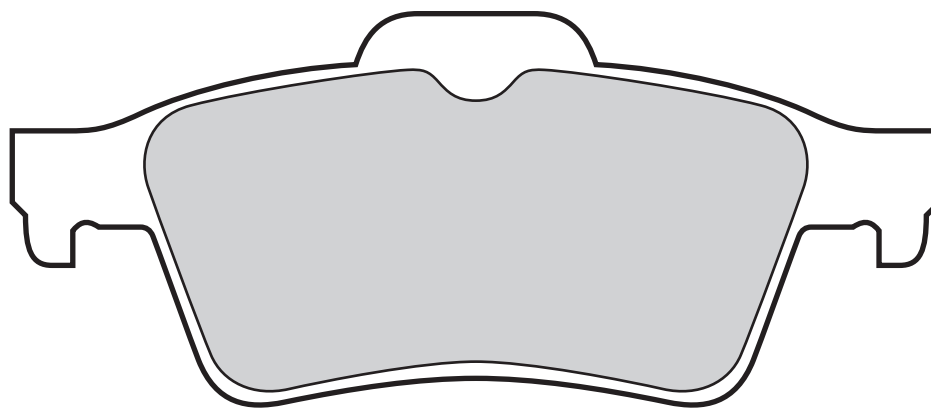

598472

0

123,1

52

16,6

TEVES

CADILLAC, FORD, NISSAN, OPEL, RENAULT, SAAB, VAUXHALL

23483 (WVA)

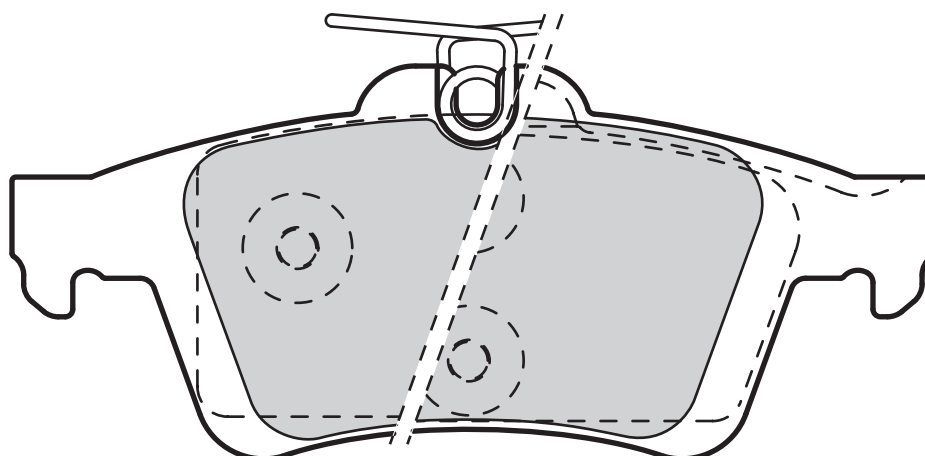

601044

0

123,1

52

16,6

TEVES

FORD, MAZDA, VOLVO

23487 (WVA)

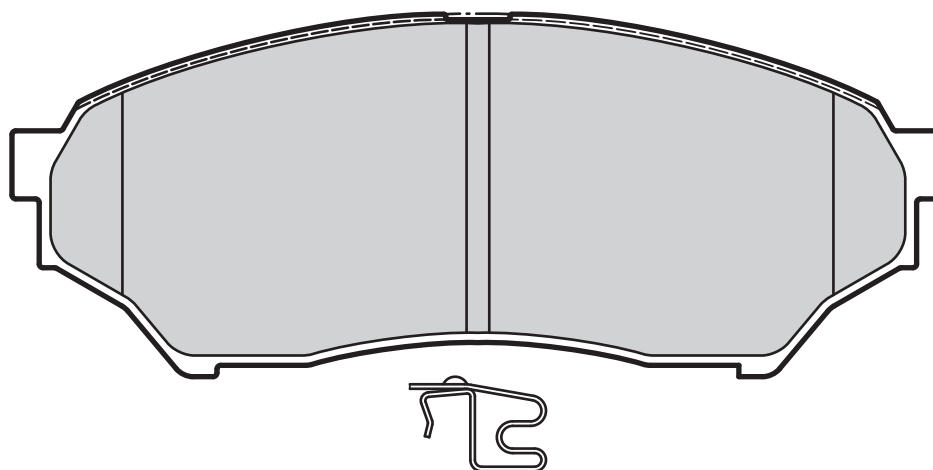

598521

1

123,2

48

15,5

AKEBONO

MINI, MITSUBISHI

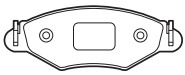

23490 (WVA)

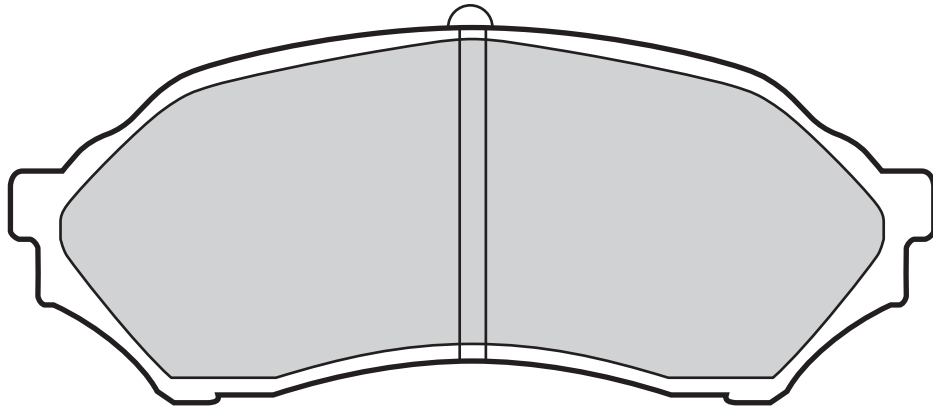

Valeo



2

Valeo



123



51,8



16



SUMITOMO



MAZDA

598548

23494 (WVA)

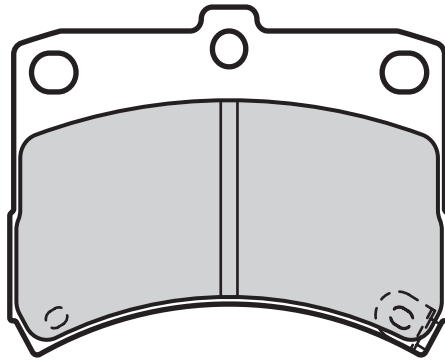

Valeo



2

Valeo



48,8



58



14,5



SUMITOMO



DAIHATSU

598883

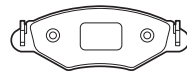

23497 (WVA)

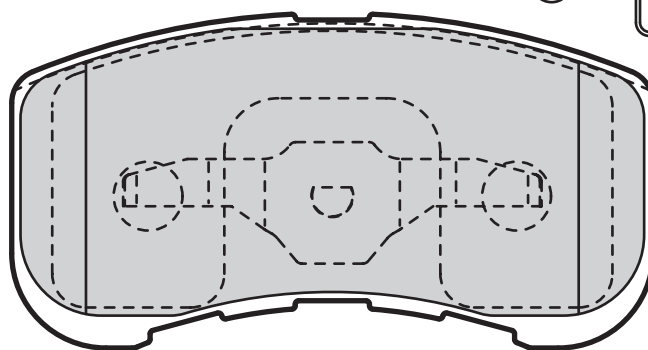
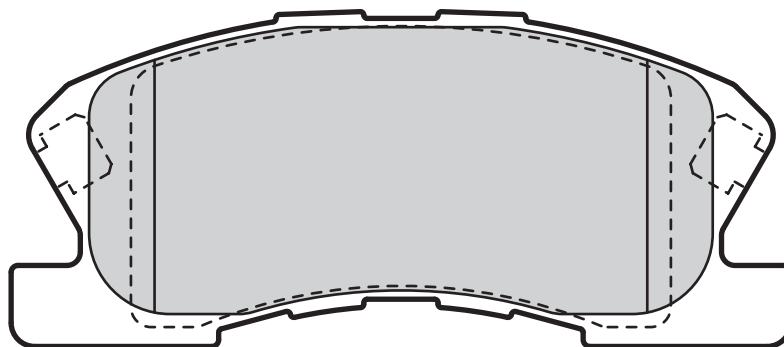

Valeo



Valeo



598856

0

104,5

45

14

AKEBONO

DAIHATSU



23501 (WVA)

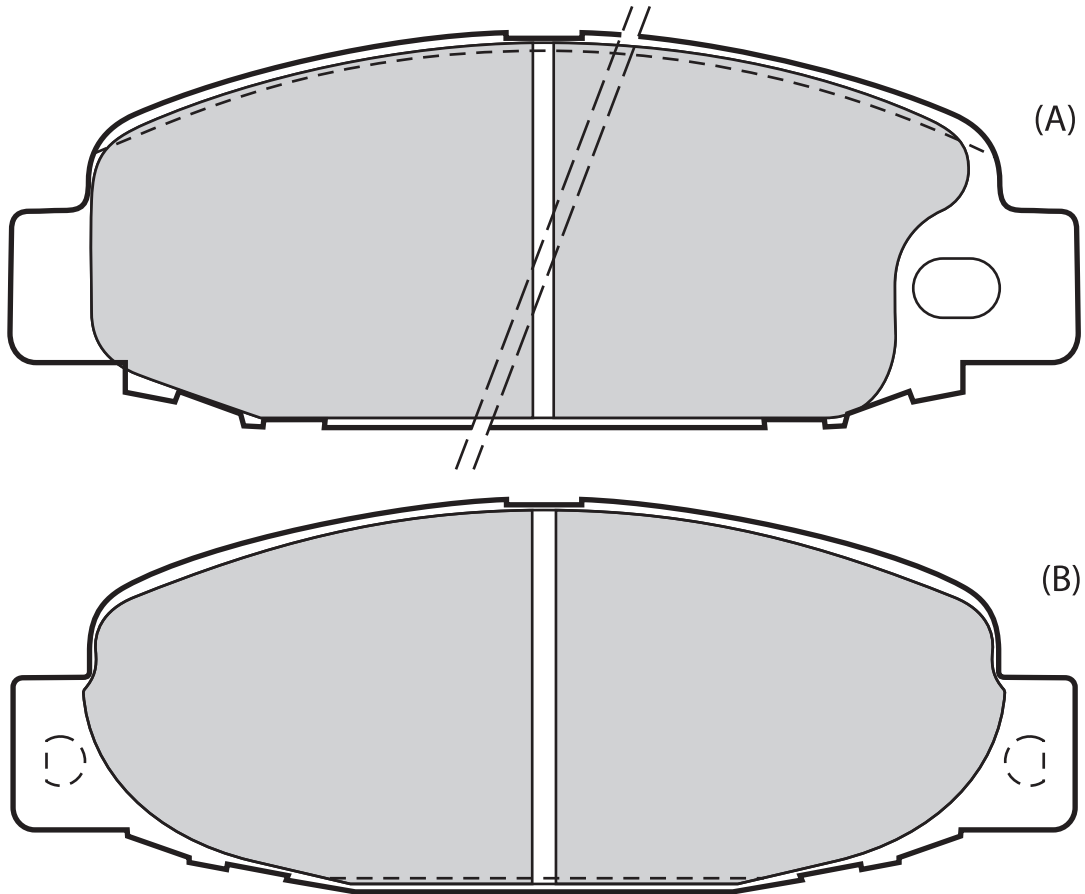

Valeo											
598589	2(A)+2(B)		133	53,2	17,5	SUMITOMO	MITSUBISHI				
598590	4 (B)		133	53,2	17,5	SUMITOMO	MITSUBISHI				

23502 (WVA)

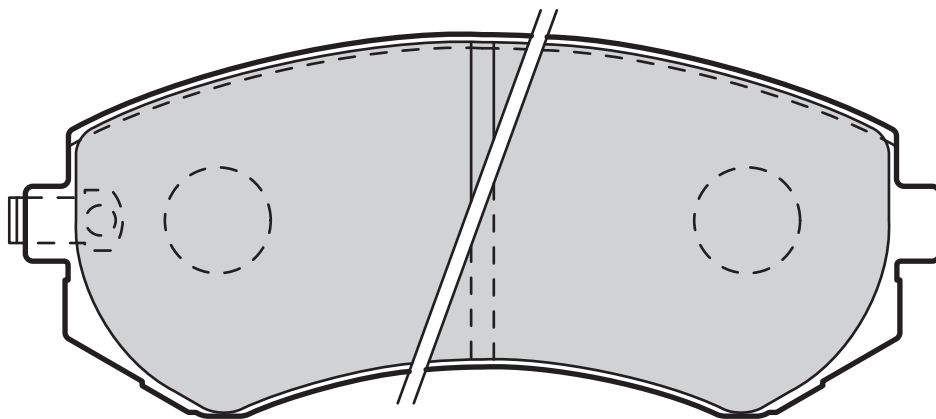

Valeo											
598806	2		121	50,4	16	AKEBONO	NISSAN				
601002	2	Leaf	120,9	50,5	16	SUMITOMO	NISSAN				

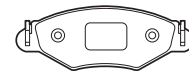

23507 (WVA)

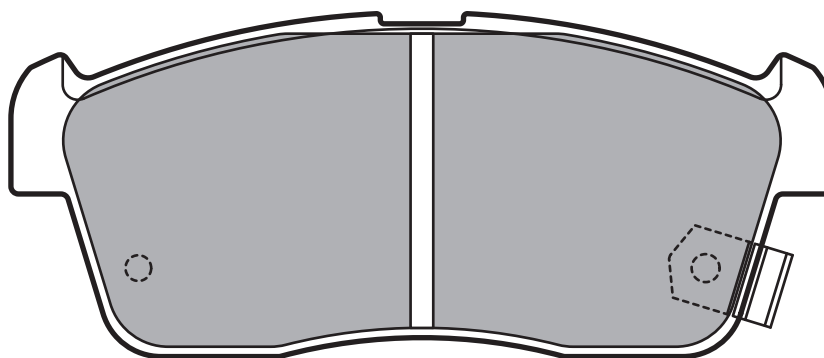

Valeo		Valeo					
598733	1		108,7	45,5	15	AKEBONO	DAIHATSU, NISSAN, SUZUKI
598832	2	Leaf	108,4	45,3	15	AKEBONO	SUZUKI

23510 (WVA)

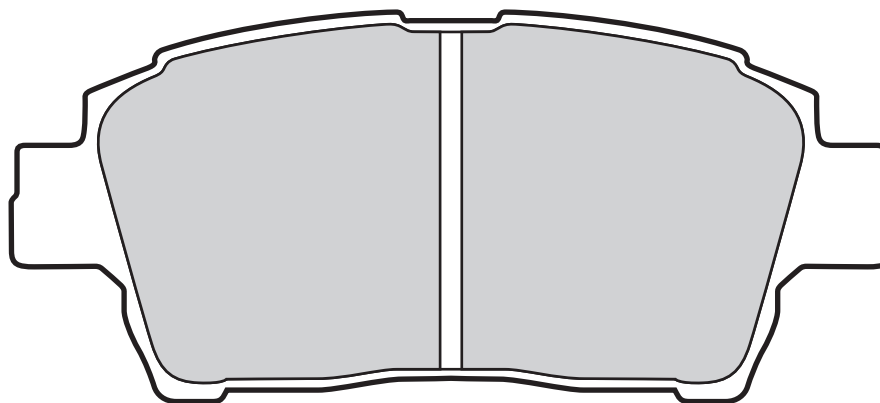

Valeo		Valeo					
598737	2		116,3	51,5	16,5	AKEBONO	TOYOTA
598917	2	Leaf	116,4	51,7	16,5	AKEBONO	TOYOTA

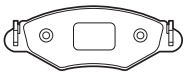

23514 (WVA)

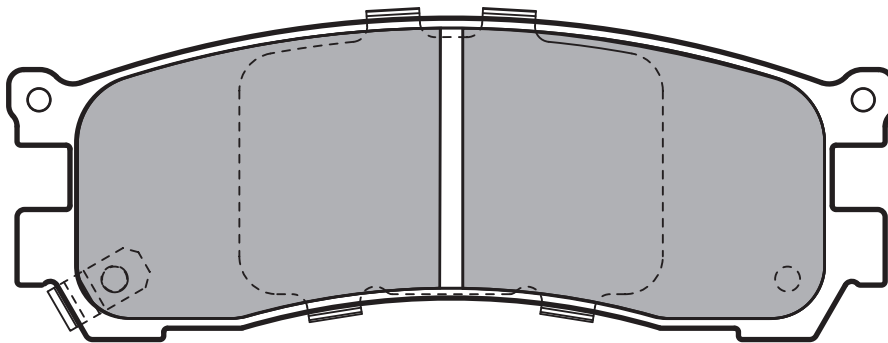
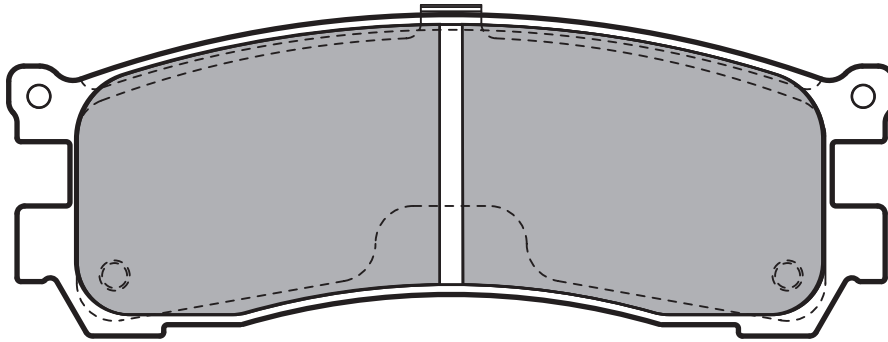

598516

1

117

42,5

15,5

AKEBONO

MAZDA

23518 (WVA)

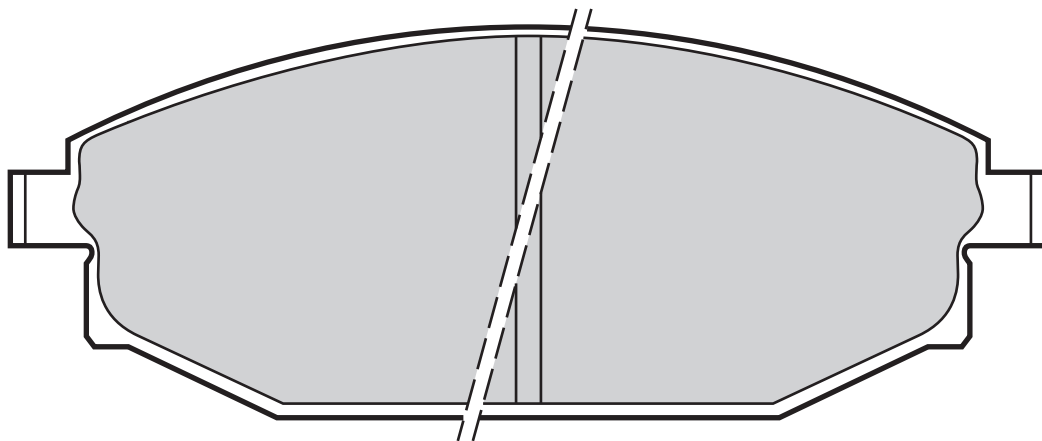

598504

2

137

52,5

17

SUMITOMO

GALLOPER, HYUNDAI

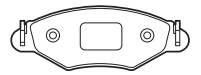

23521 (WVA)

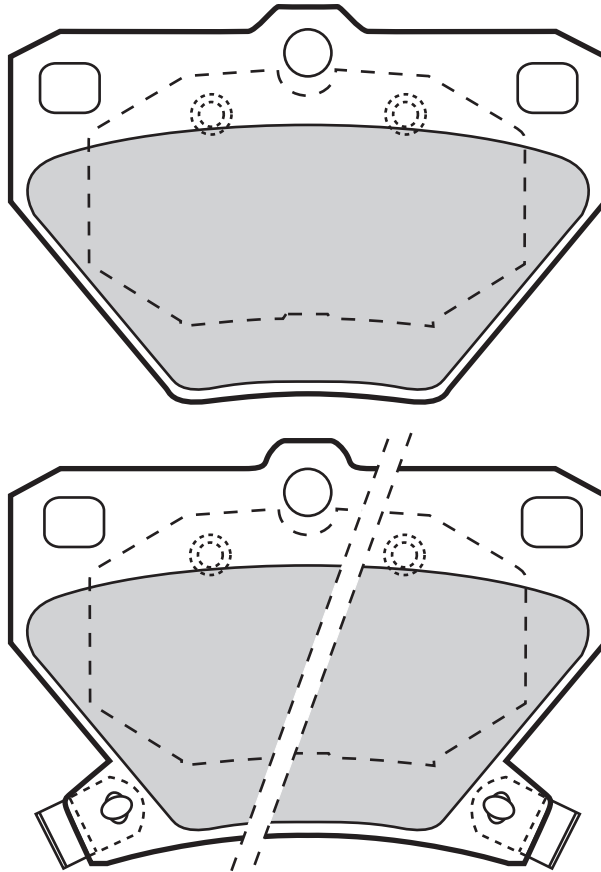

Valeo



Valeo



598577

2

78,5

55

14

SUMITOMO

TOYOTA

23524 (WVA)

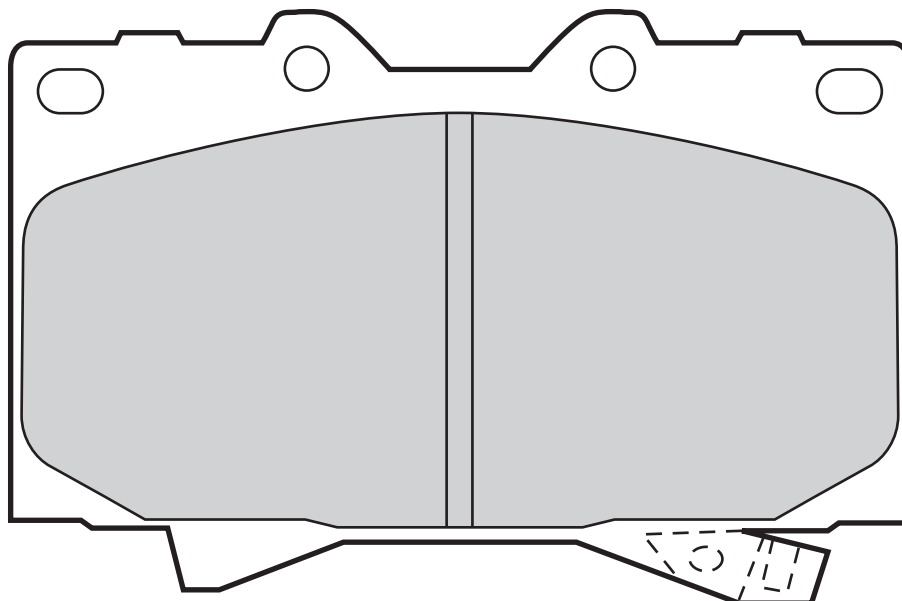

Valeo



Valeo



598535

2

119,6

78

15,5

SUMITOMO

LEXUS, TOYOTA



23526 (WVA)

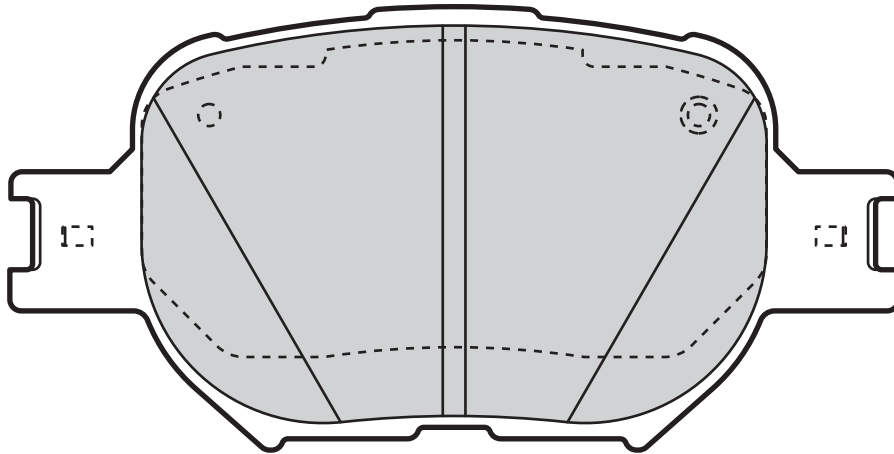

598827	0		117,5	58,6	17,4	AKEBONO		TOYOTA		

23527 (WVA)

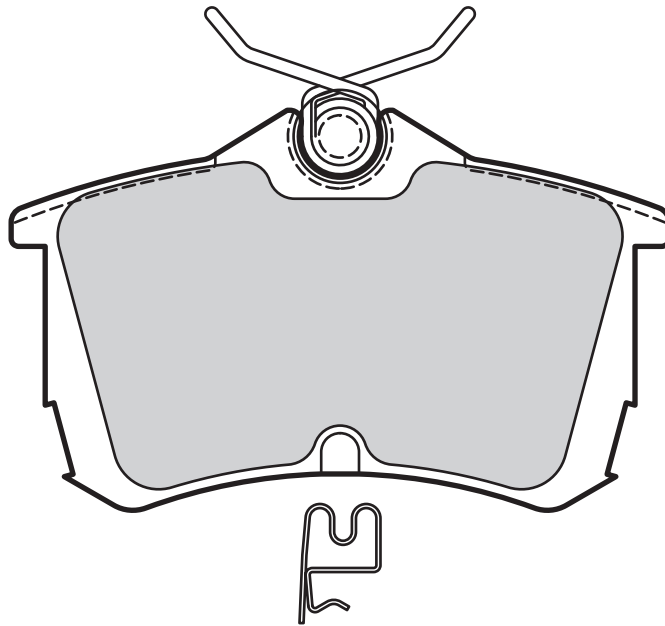

598758	2		87	53	15,3	LUCAS		HONDA		



23532 (WVA)

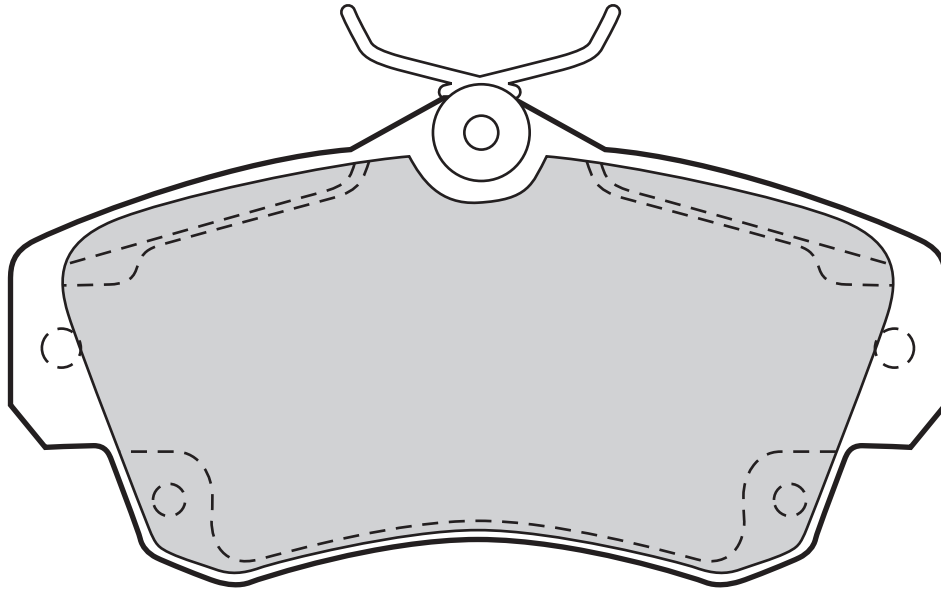

Valeo



Valeo



598543

0

124

64,6

20

LUCAS

CHRYSLER

23536 (WVA)

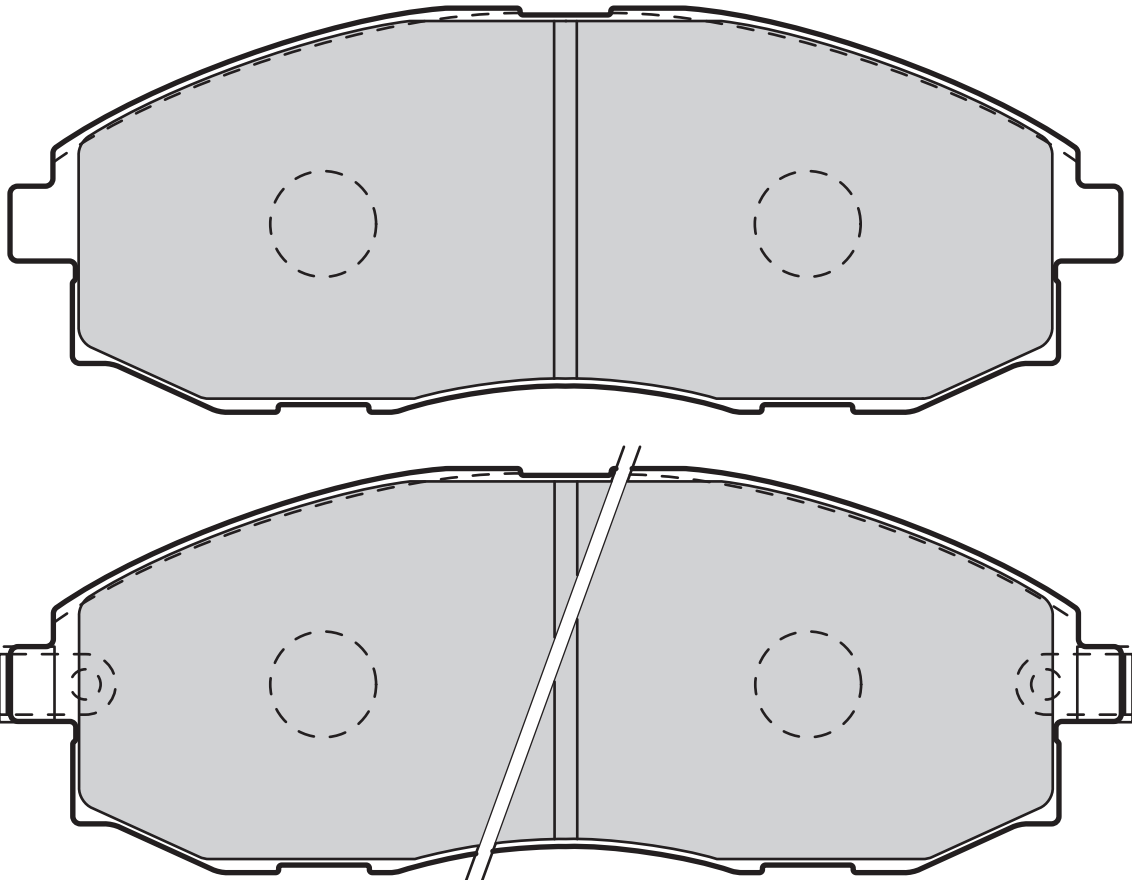

Valeo



Valeo



598908

2

Leaf

146,9

54,5

17

MANDO

HYUNDAI



23539 (WVA)

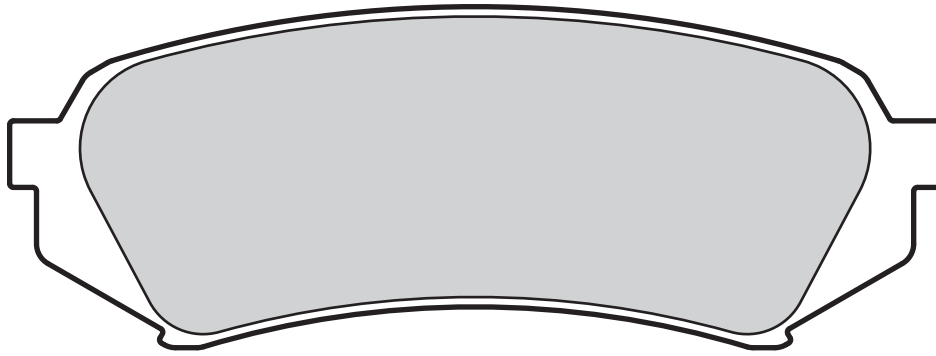

598865	0	123,1	45,1	17,5	AKEBONO	LEXUS, TOYOTA		

23540 (WVA)

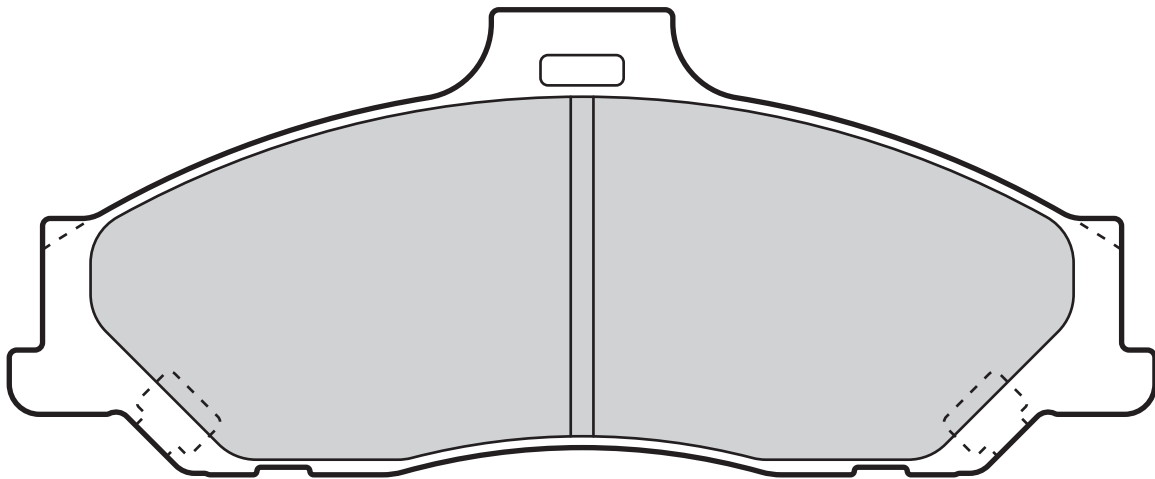

598784	1	151,5	61,5	17,2	KELSEY	FORD, MAZDA		



23543 (WVA)

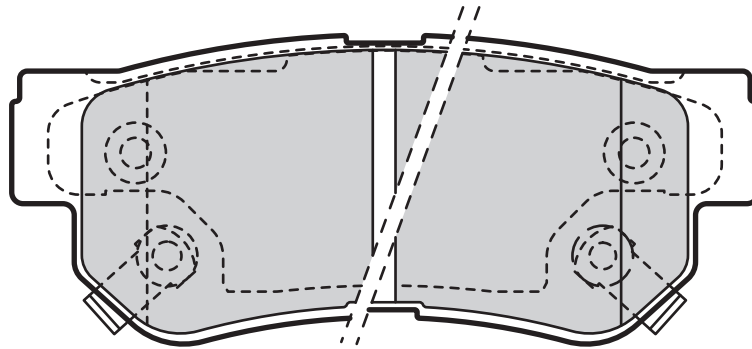

Valeo



2

Valeo



98,7



40,8



15,7



MANDO



HYUNDAI, KIA, SSANGYONG

598748

23550 (WVA)

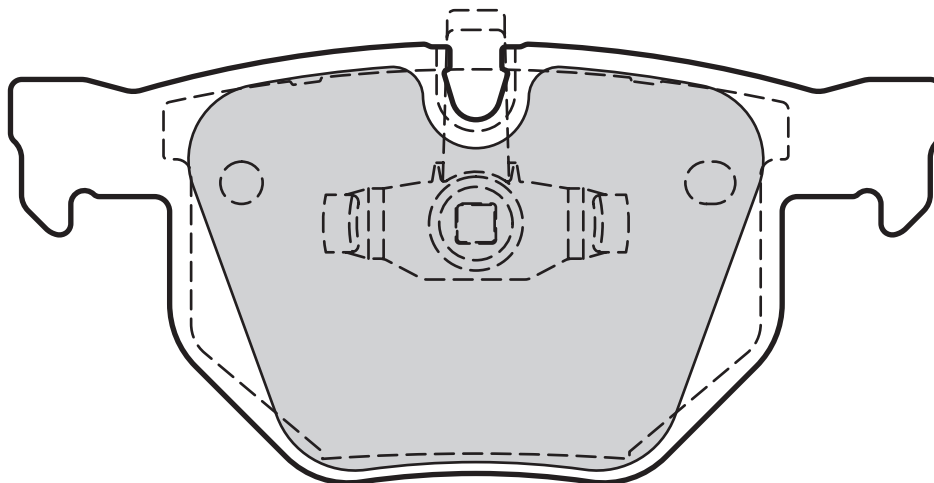
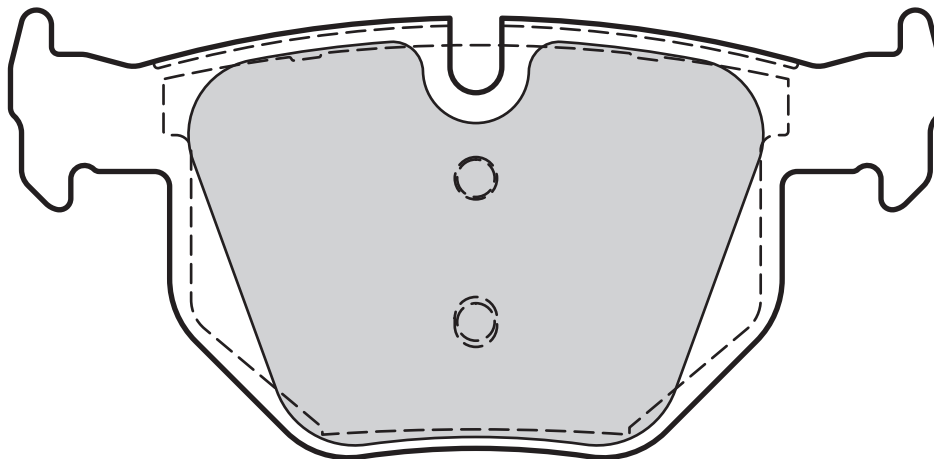

Valeo



0

Valeo



123,1



59,3



17,3



TEVES



BMW

598885

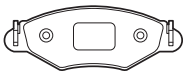

23557 (WVA)

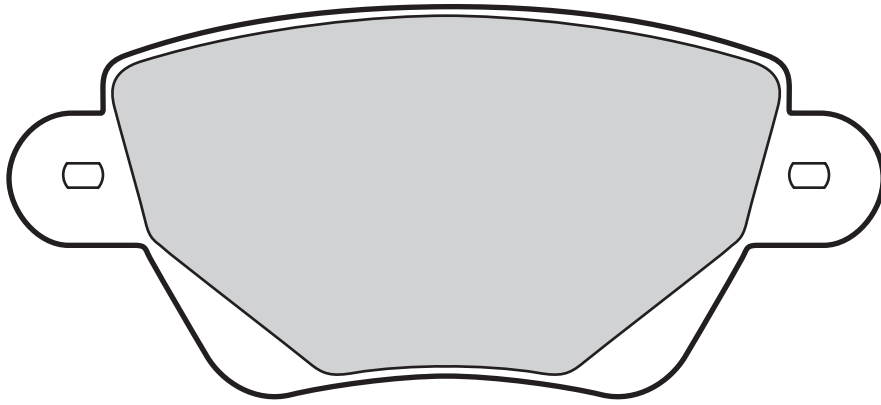

Valeo									
598434	0		115,9	51,9	16,8	BOSCH	FORD, JAGUAR		
598527	0		115,9	51,9	16,8	BOSCH	RENAULT		

23558 (WVA)

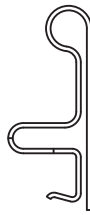
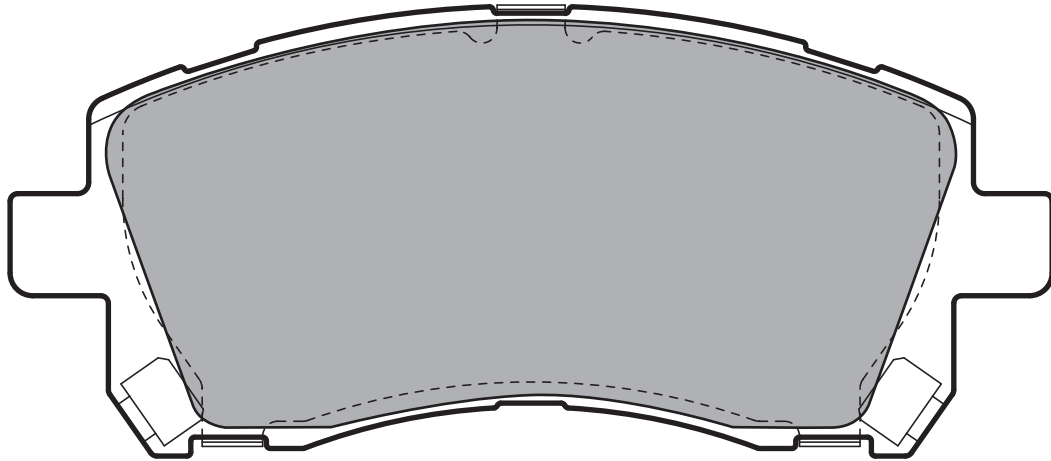

Valeo									
598530	2		137,5	59,5	17,8	AKEBONO	SUBARU		



23561 (WVA)

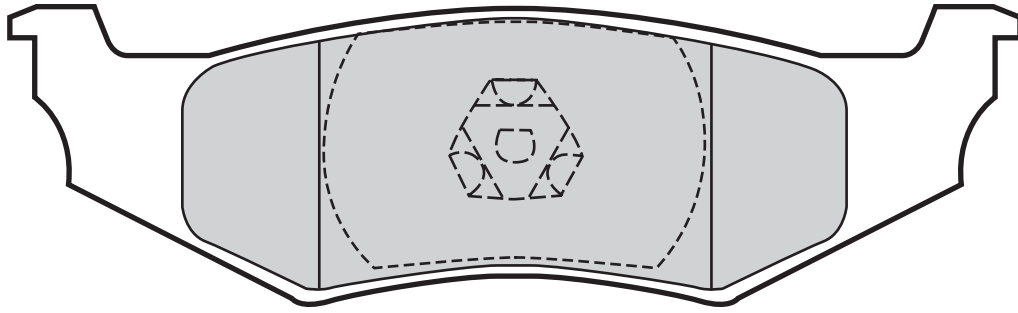

Valeo							
598544	0	133,6	39,9	18	KELSEY	CHRYSLER	
598965	0	133,6	39,7	17	KELSEY	CHRYSLER	

23569 (WVA)

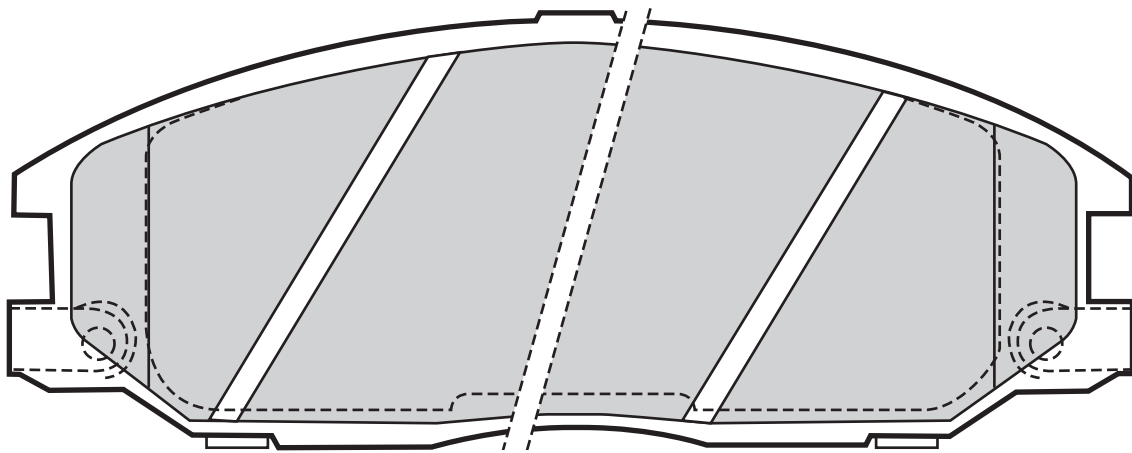

Valeo							
598505	2	149	58	17,4	AKEBONO	HYUNDAI, SSANGYONG	
598759		0	0			HYUNDAI	



23572 (WVA)

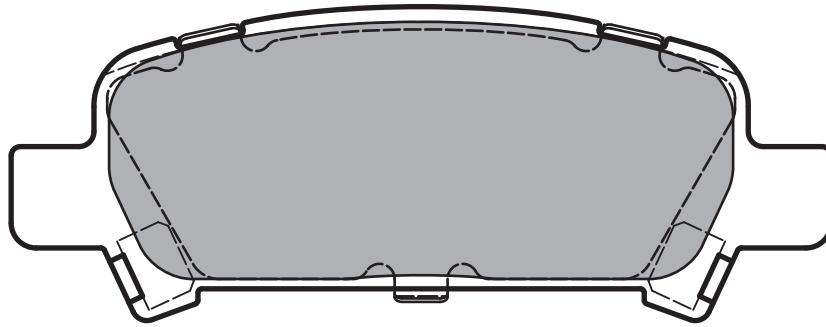

Valeo



1

Valeo



Leaf



108



41,7



14,5



AKEBONO



SUBARU



598895

23577 (WVA)

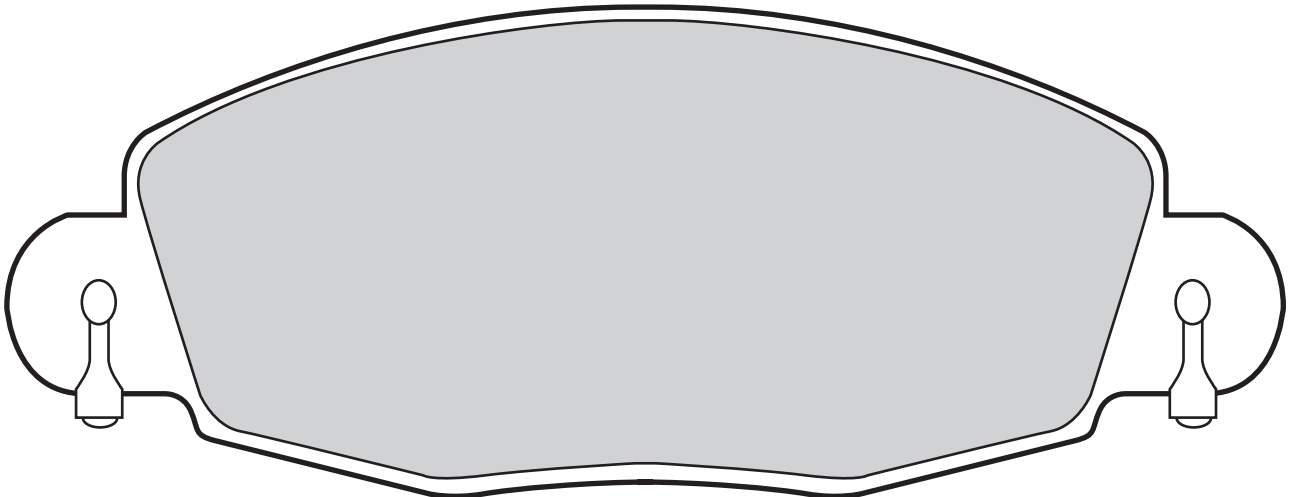

Valeo



2

Valeo



168,6



65,3



18,4



BOSCH



FORD



598432

598547

0

169

64

18,4

BOSCH

FORD



23581 (WVA)

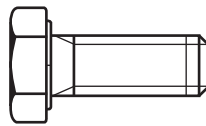
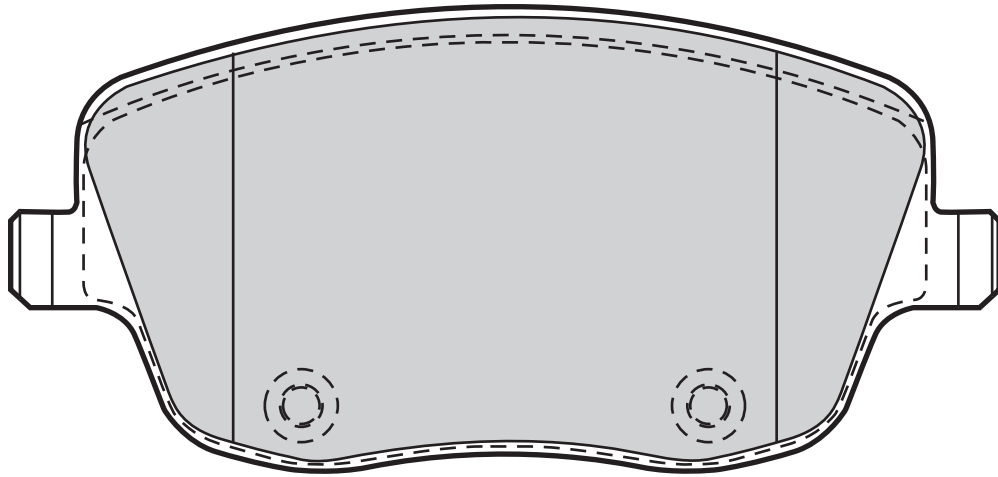

Valeo									
598667	0		131,4	62,3	18,7	LUCAS	SEAT, SKODA, VOLKSWAGEN		
598720	1	180	131,4	62,3	18,7	LUCAS	SEAT, SKODA, VOLKSWAGEN		

23582 (WVA)

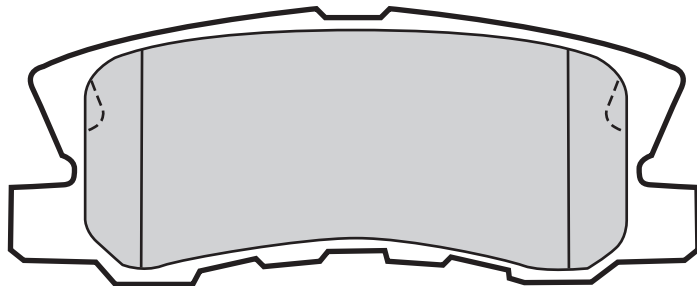
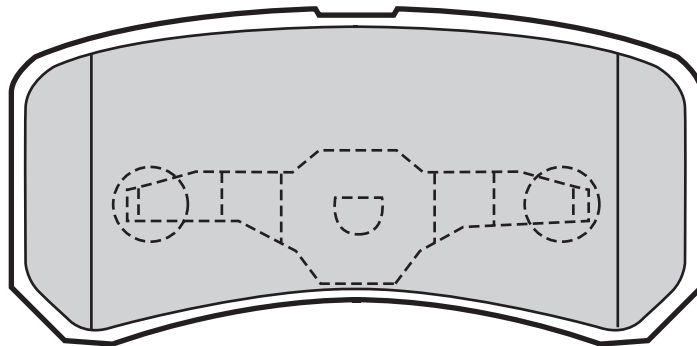

Valeo									
598520	2		111,6	45	15,5	AKEBONO	mitsubishi		



Valeo

23584 (WVA)

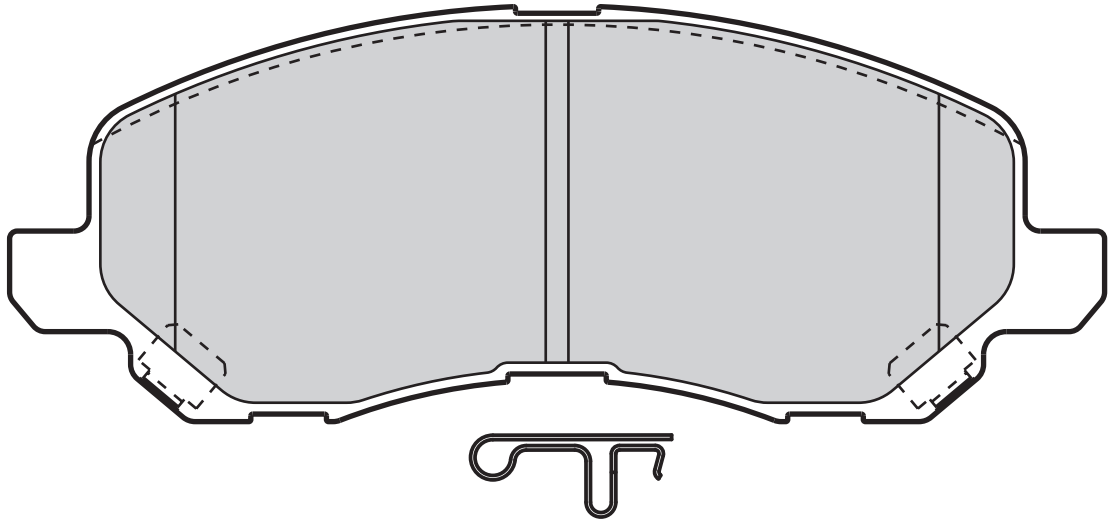

Valeo



Valeo



598886

2

144,8

55

16

AKEBONO

mitsubishi

23585 (WVA)

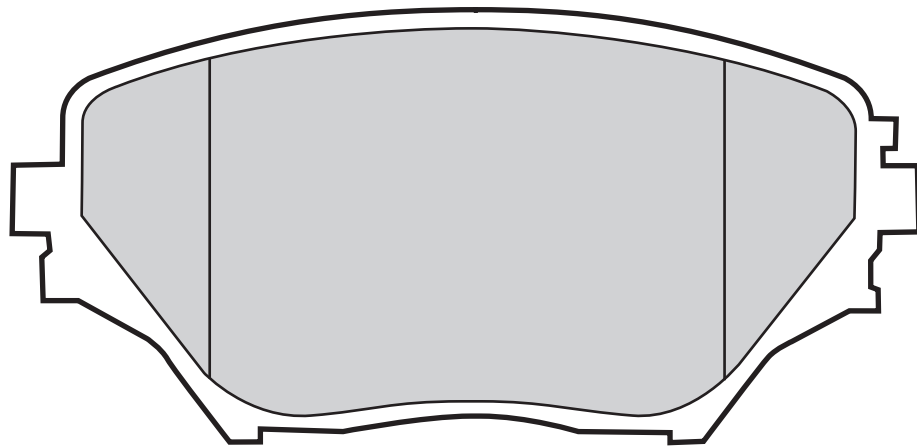
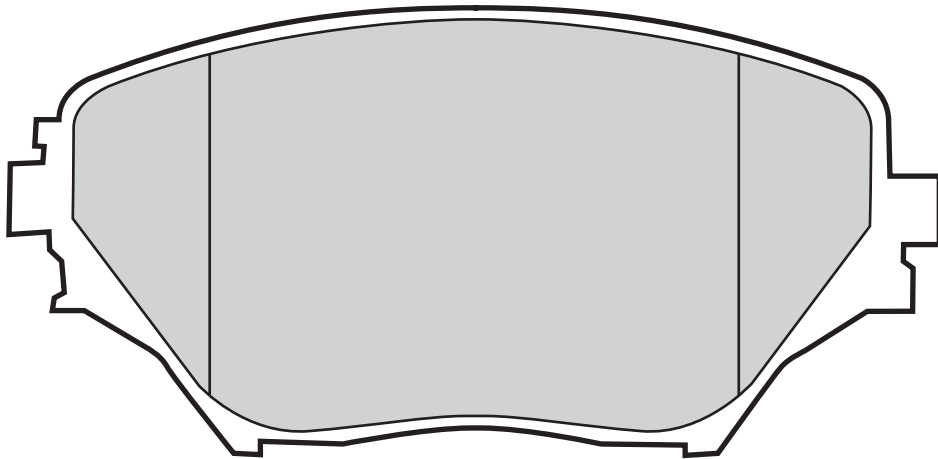

Valeo



Valeo



598536

0

123

60,3

17,5

AKEBONO

toyota



23587 (WVA)

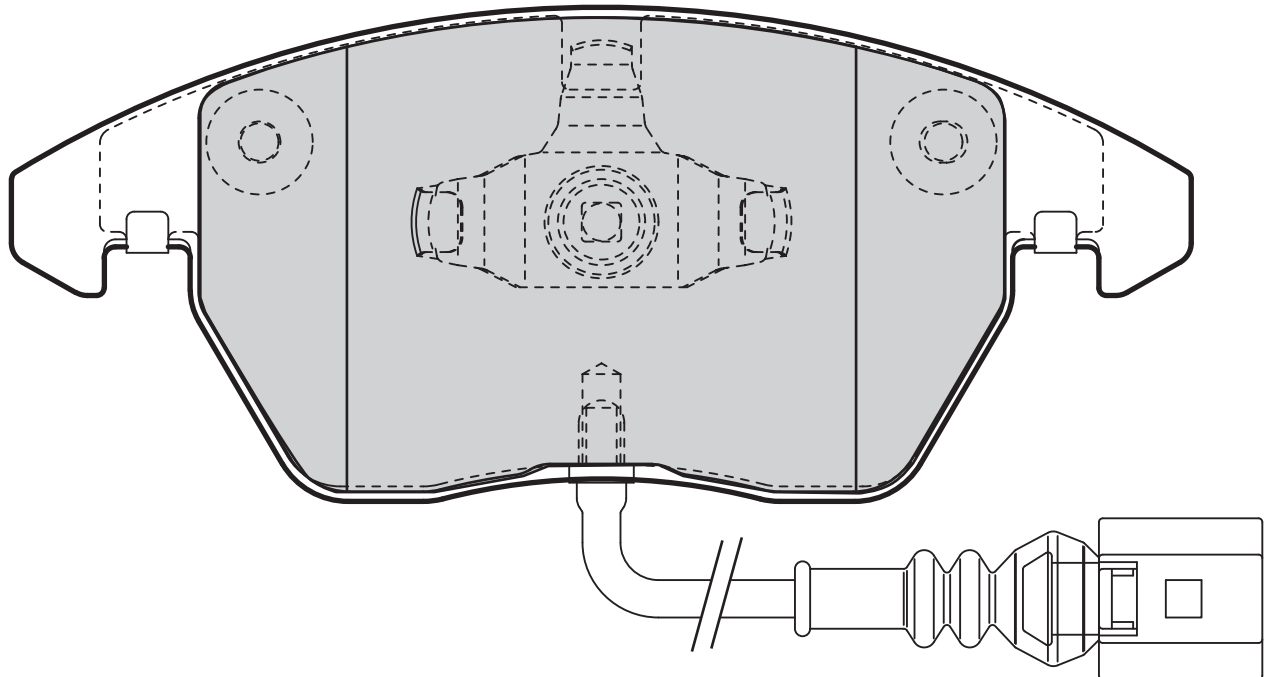
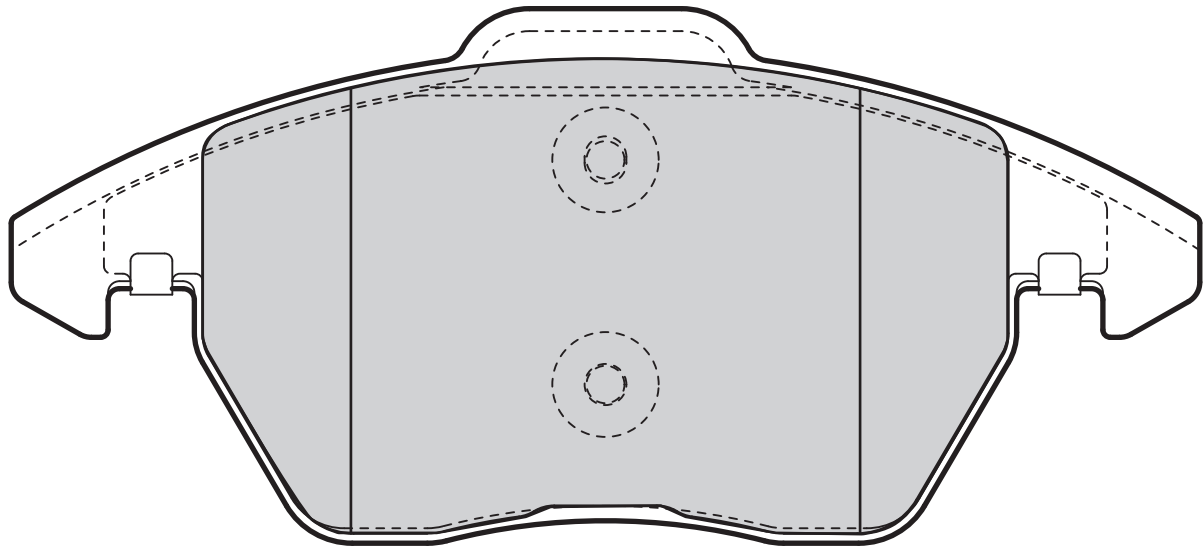

Valeo



Valeo



598635
598729

1
2

155
176

156,4
156,4

66/71,4
69

20,3
20

TEVES
TEVES

AUDI, SEAT, SKODA, VOLKSWAGEN
ALFA ROMEO

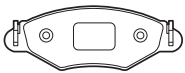

Valeo

23589 (MVA)

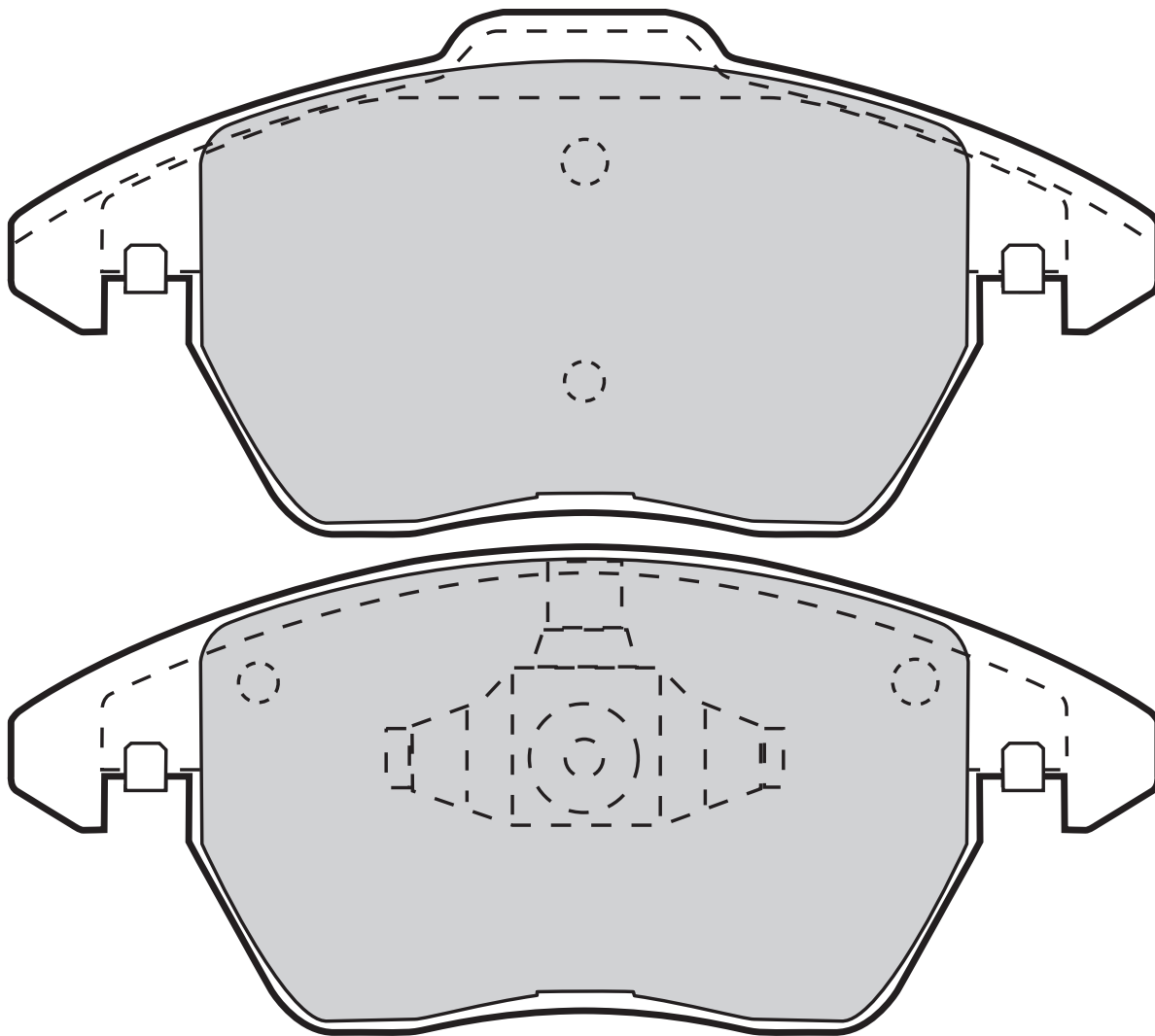

Valeo



0

Valeo



155/156



71,6



19



TEVES



CITROËN, PEUGEOT

598715

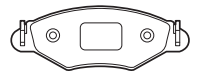

23590 (WVA)

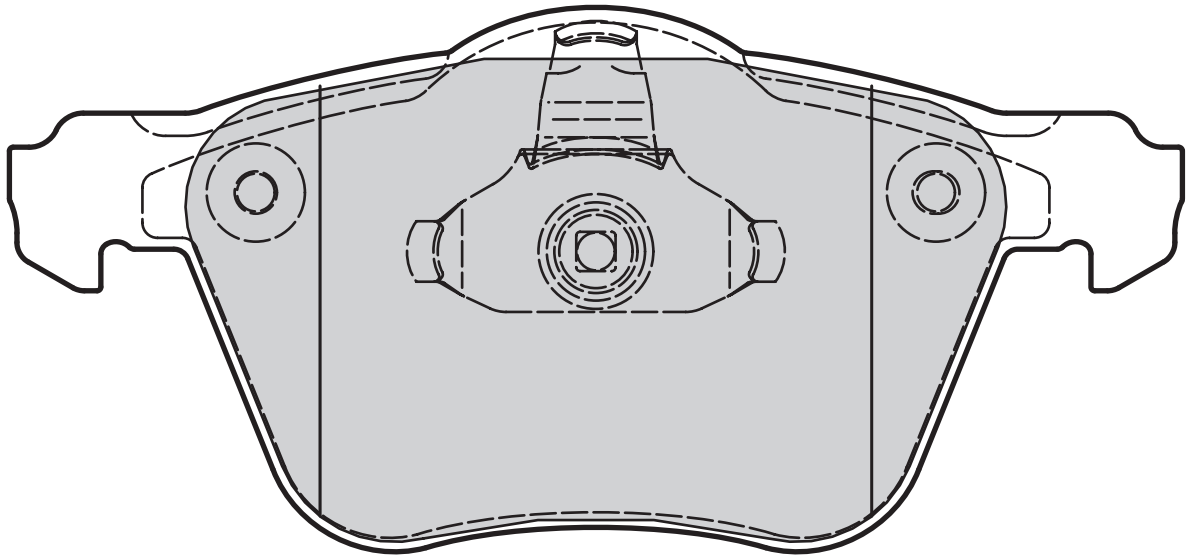
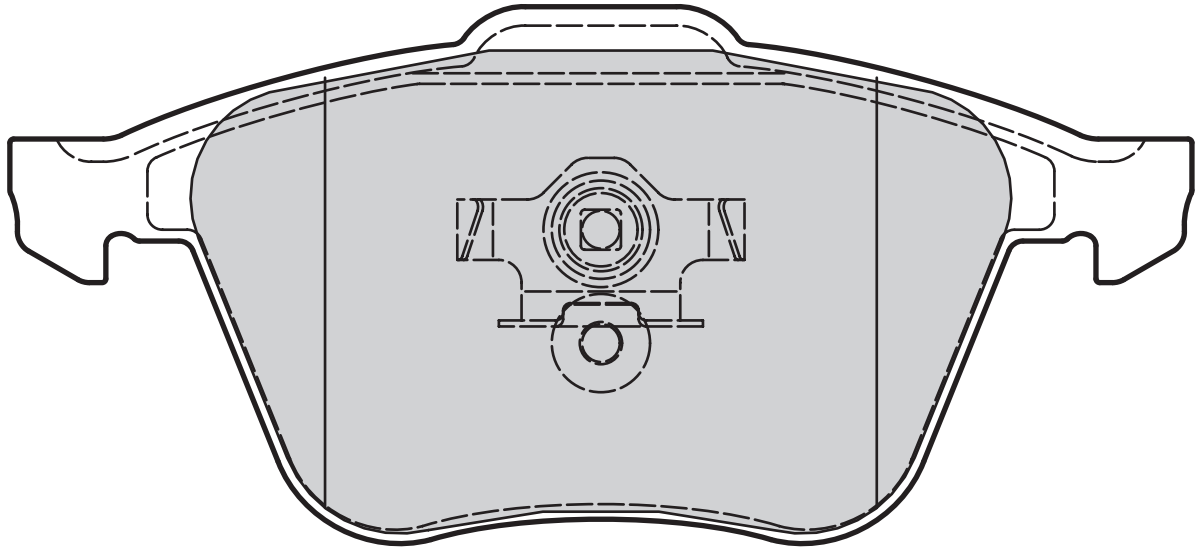

Valeo



Valeo



601030
601032

0
8

Leaf

156,4
150,5

71/72
56,5

18,2
18,8

TEVES
BOSCH

VOLVO
CHRYSLER



23593 (WVA)

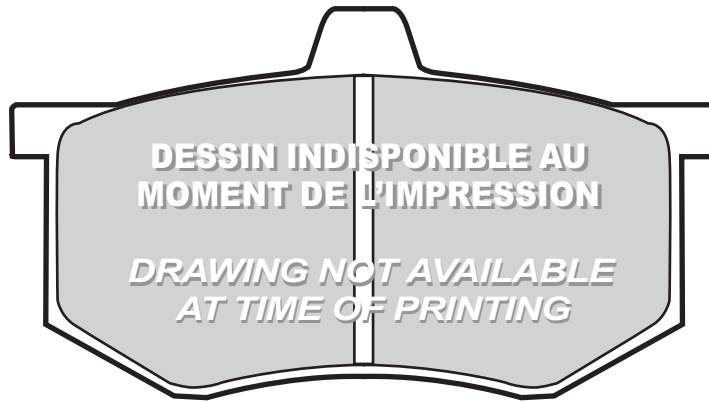

598778	2	78,8	58,9	15	SUMITOMO	MITSUBISHI			

23599 (WVA)

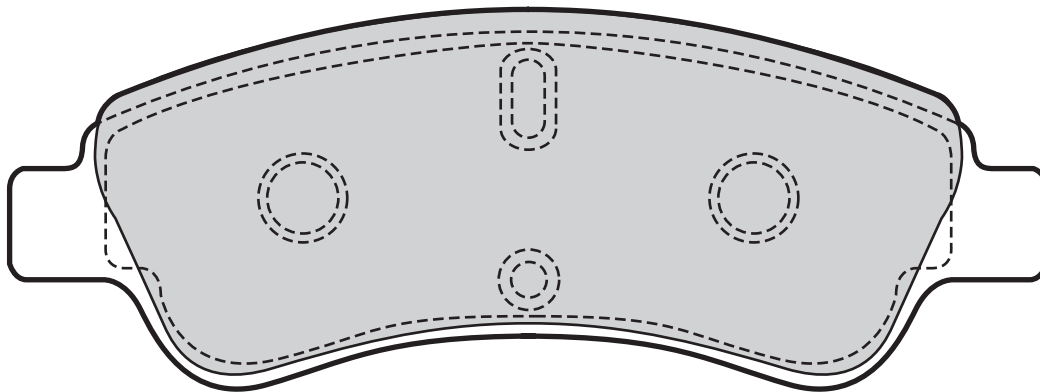

598464	0	137	50	19	BOSCH	CITROËN, PEUGEOT			

23600 (WVA)

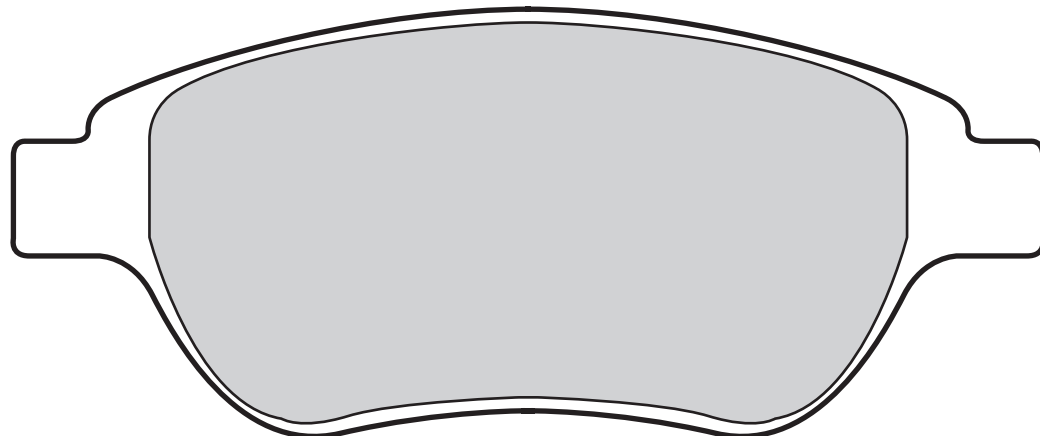

598465	0	137	57,3	19	BOSCH	CITROËN, PEUGEOT			



23608 (WVA)

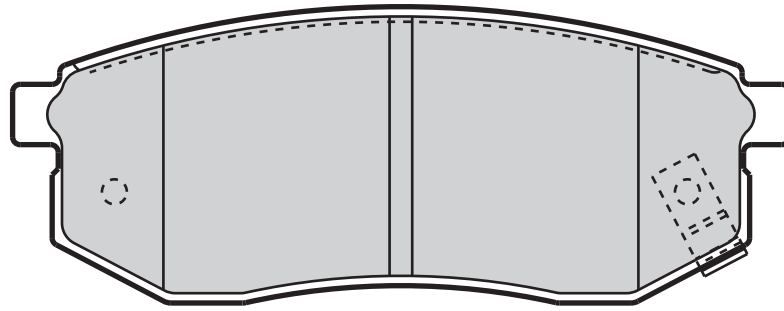

Valeo



2

Valeo



102,7



39,2



15



MANDO



KIA

598866

23611 (WVA)

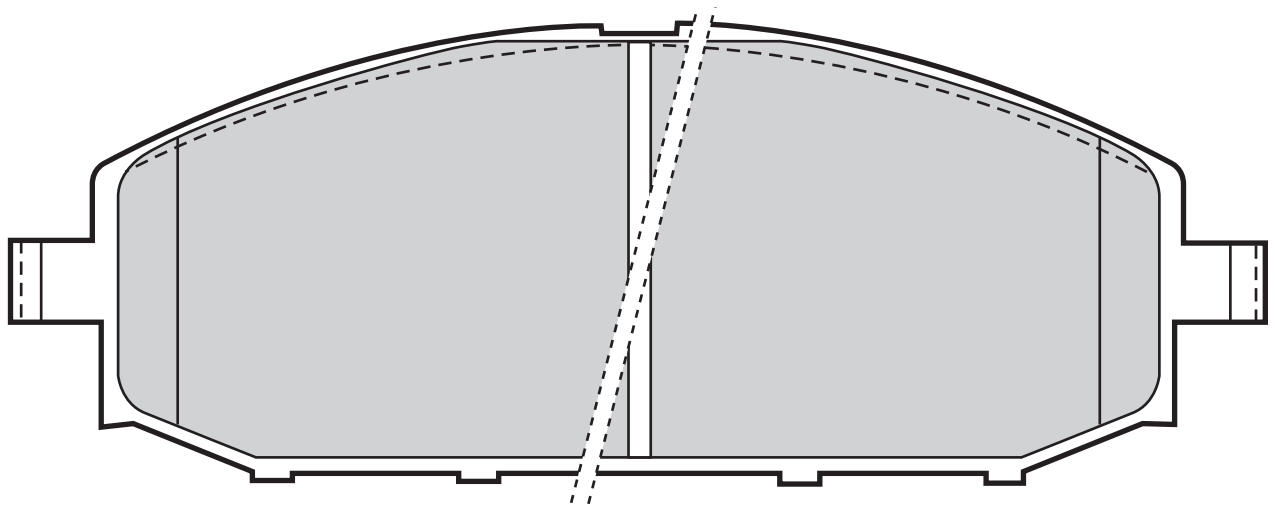

Valeo



2

Valeo



165,9



61,3



19



SUMITOMO



NISSAN

598524



23613 (WVA)

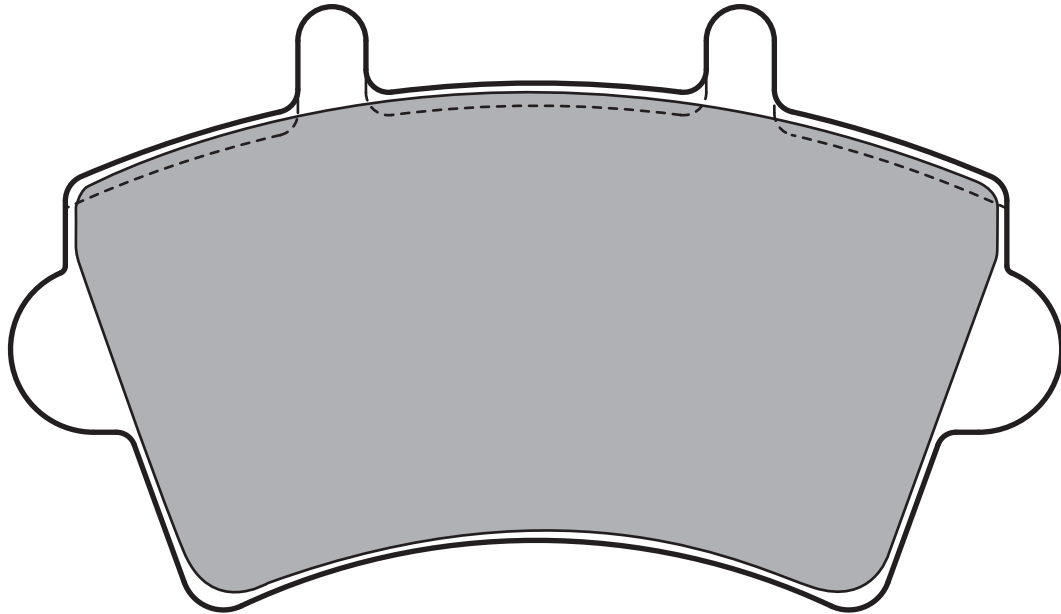

598537	0	139	79,8	17,8	BOSCH	NISSAN, OPEL, RENAULT, VAUXHALL		

23615 (WVA)

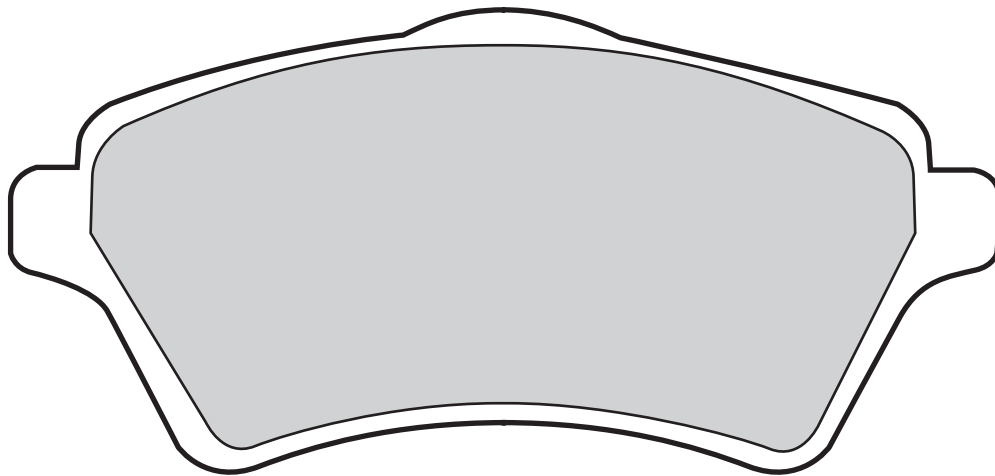

598514	0	131,5	62	18,2	LUCAS	LAND ROVER	



23620 (WVA)

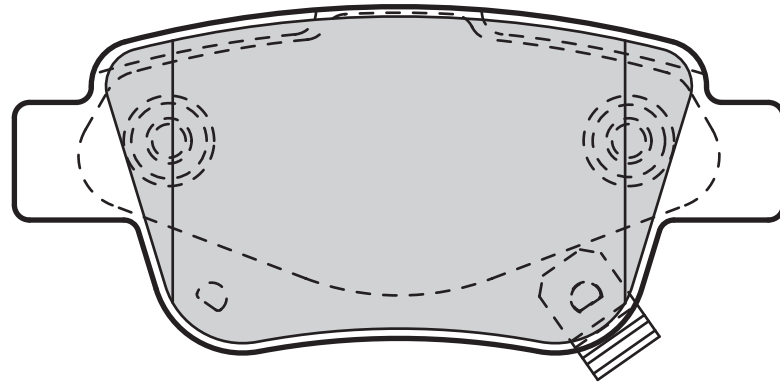

Valeo



Valeo



598812

2

101,7

45,8

16,7

BOSCH

TOYOTA

23623 (WVA)

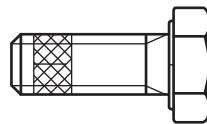
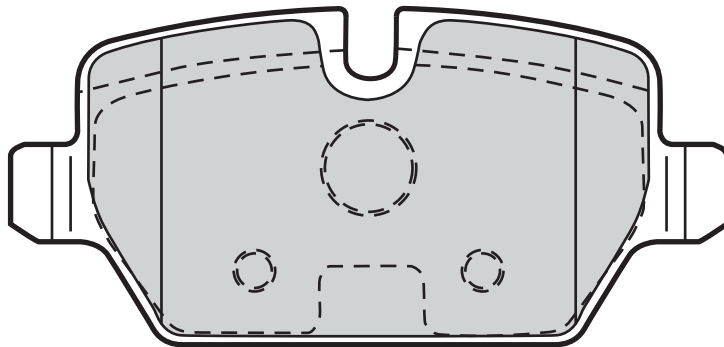
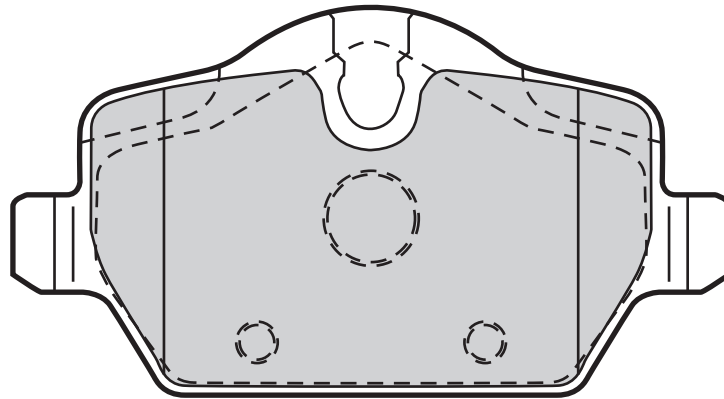

Valeo



Valeo



598701

0

95,2

44,7

17,5

LUCAS

BMW

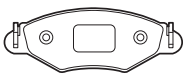

23631 (WVA)

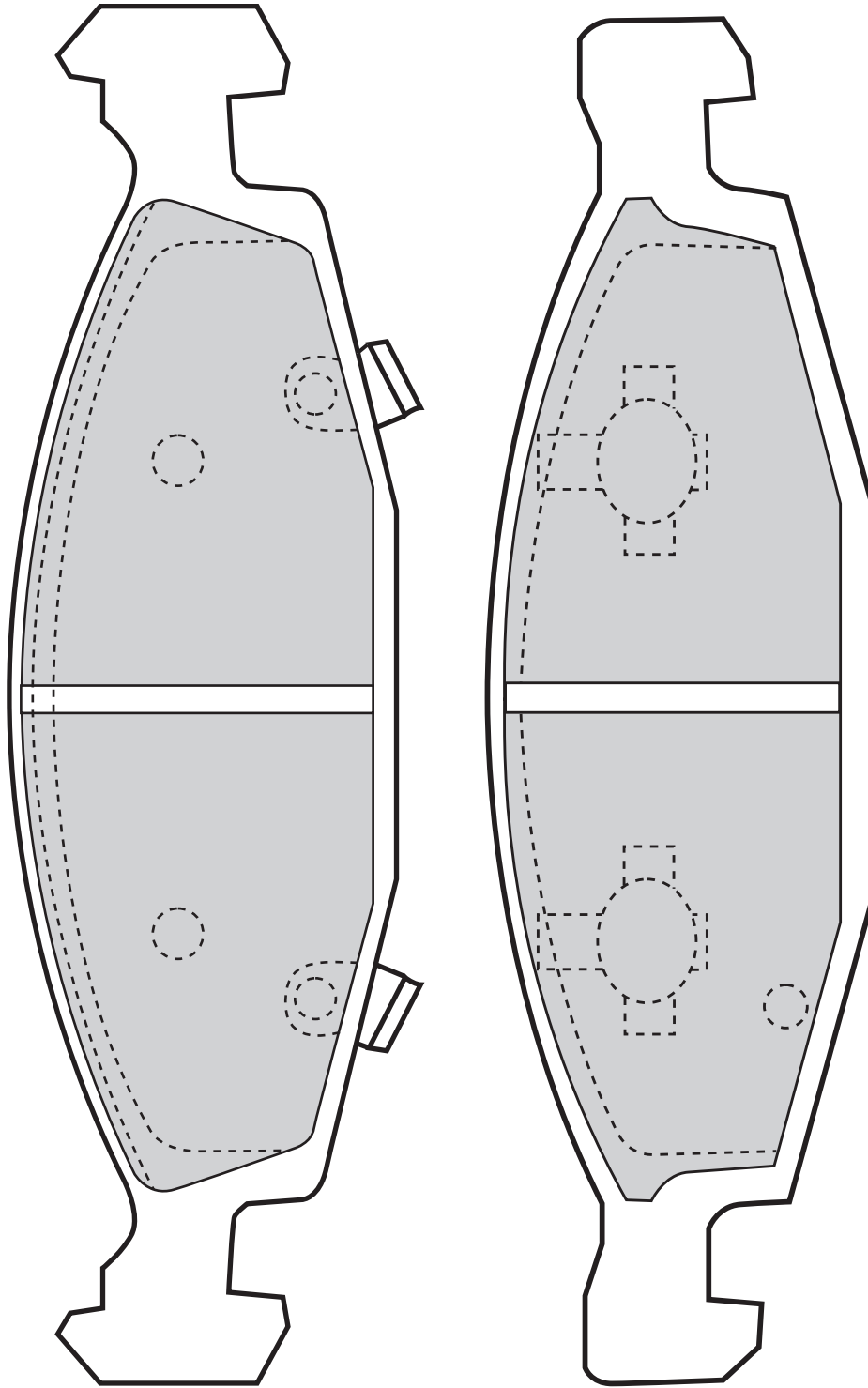

Valeo



Valeo



598510

4

194,4

55,4

17,8

KELSEY

JEEP



23638 (WVA)

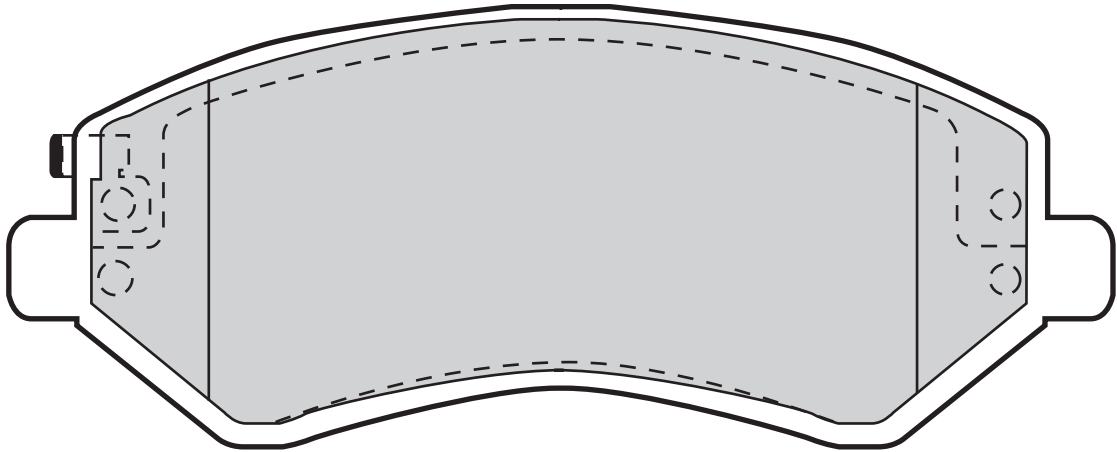

598414

2

146,8

59,7

18,5

LUCAS

JEEP

23640 (WVA)

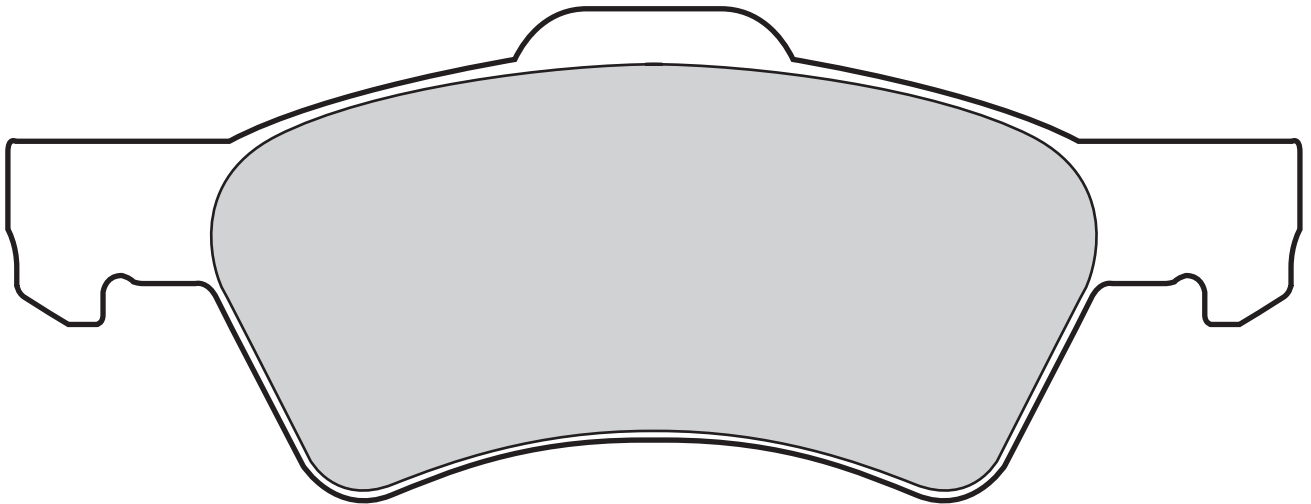

598415

2

172,5

65,7

18,8

TEVES

CHRYSLER

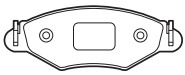

23646 (WVA)

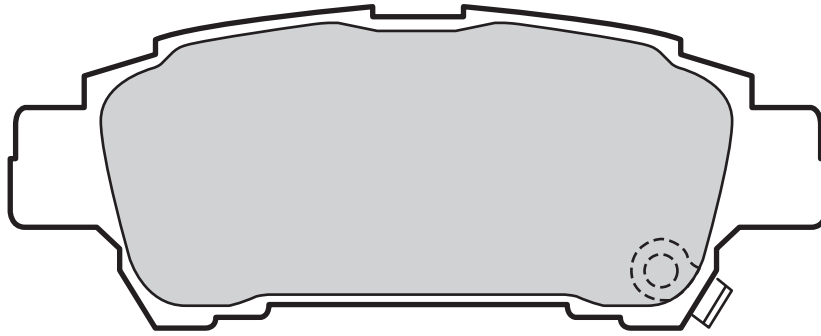

598542	2	111,3	43	16,5	SUMITOMO	TOYOTA	

23649 (WVA)

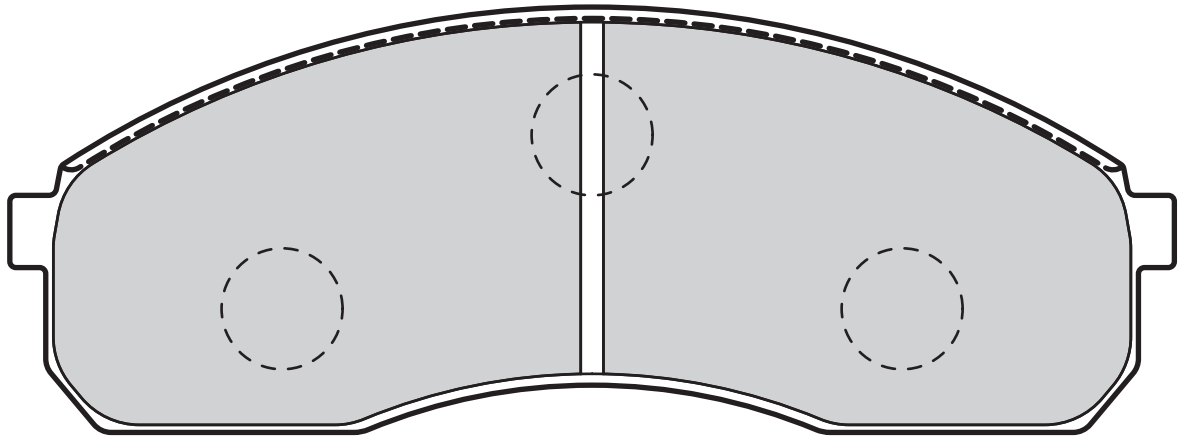

598821	2	154	56,2	16,5	SUMITOMO	KIA	

23656 (WVA)

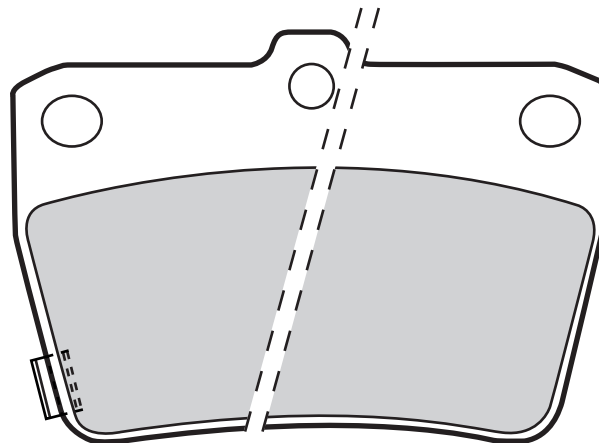

598673	2	78,4	54	14	AKEBONO	TOYOTA	

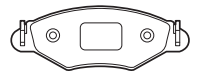

23659 (WVA)

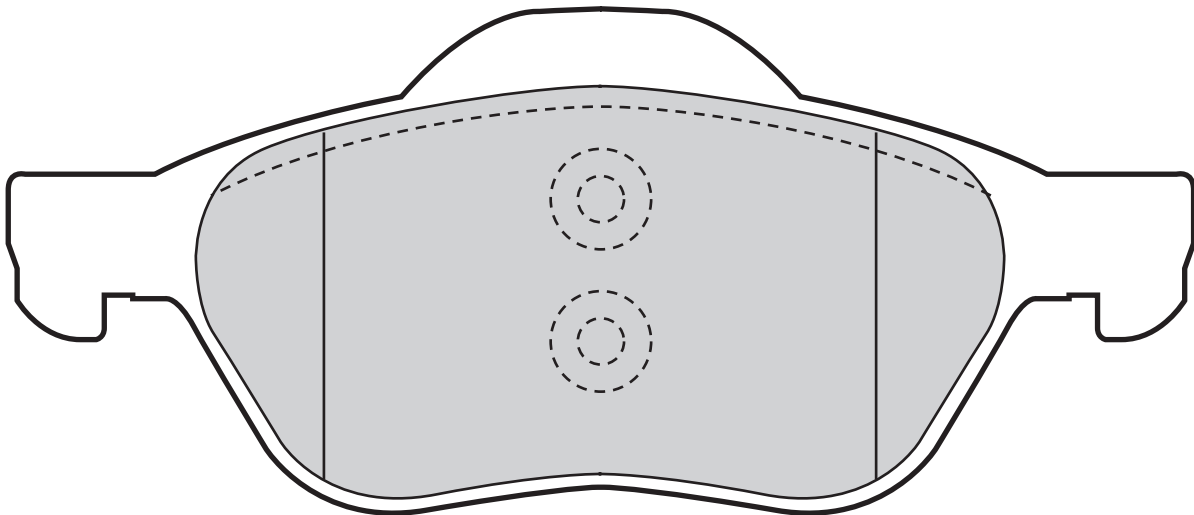
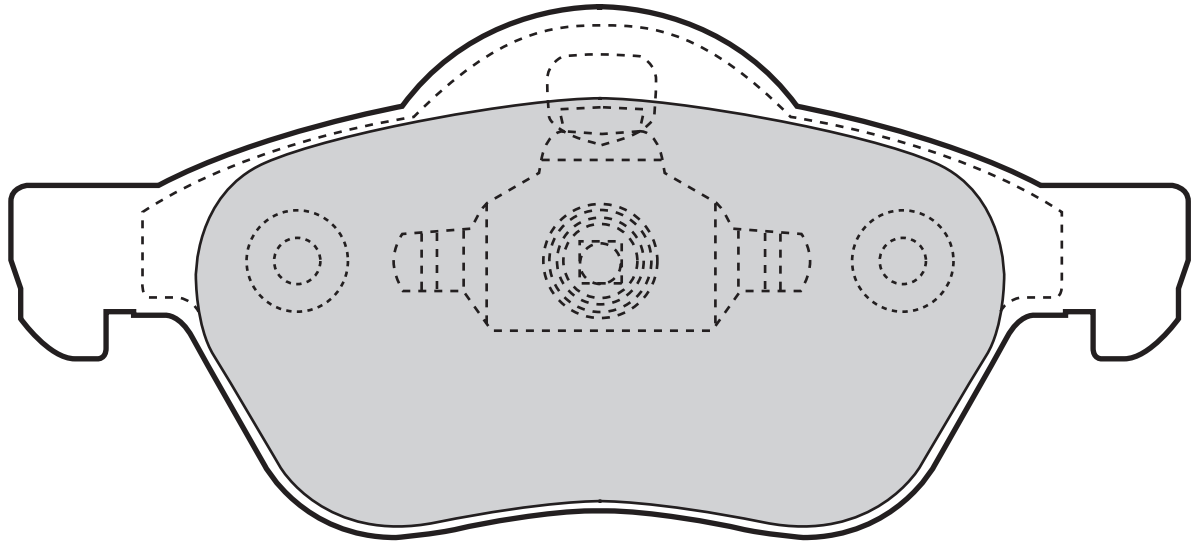

Valeo



Valeo



598471
598566

0
0

155,2
156,4

66,6
69/66,5

18
18

TEVES
TEVES

RENAULT
RENAULT

23661 (WVA)

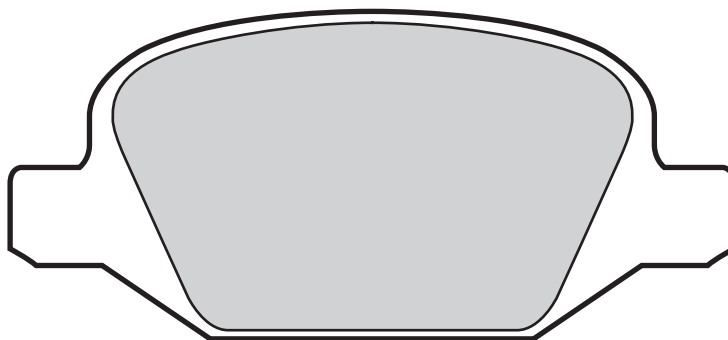

Valeo



Valeo



598407
598425

0
0

95,8
95,8

43,7
43,9

16,5
13,7

LUCAS
LUCAS

ALFA ROMEO, FIAT, LANCIA
ABARTH, FIAT, LANCIA



23662 (WVA)

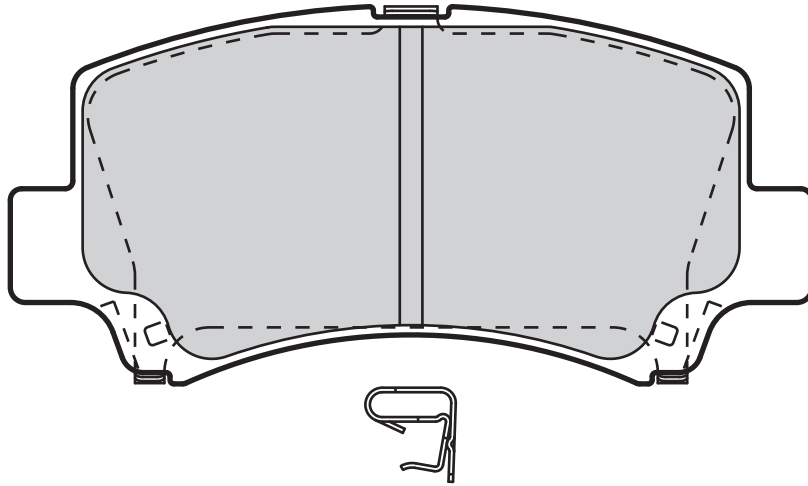

Valeo



2

Valeo



106



50



15



AKEBONO



SUZUKI

598843

23669 (WVA)

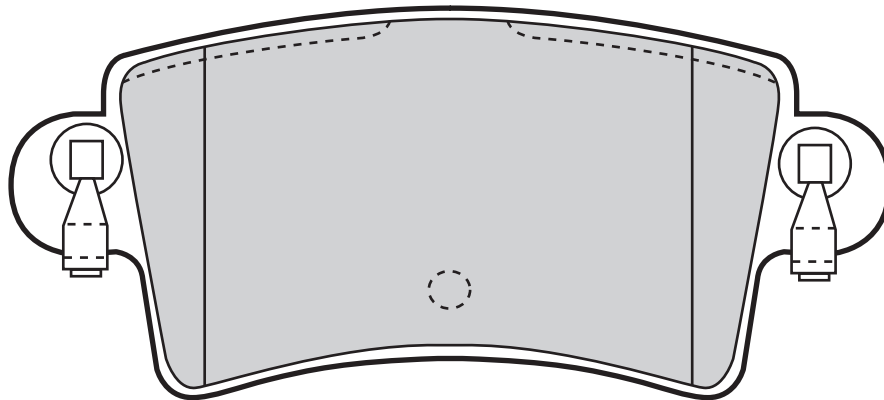

Valeo



0

Valeo



116



51,4



16,8



BOSCH



NISSAN, OPEL, RENAULT, VAUXHALL

598538



23692 (WVA)

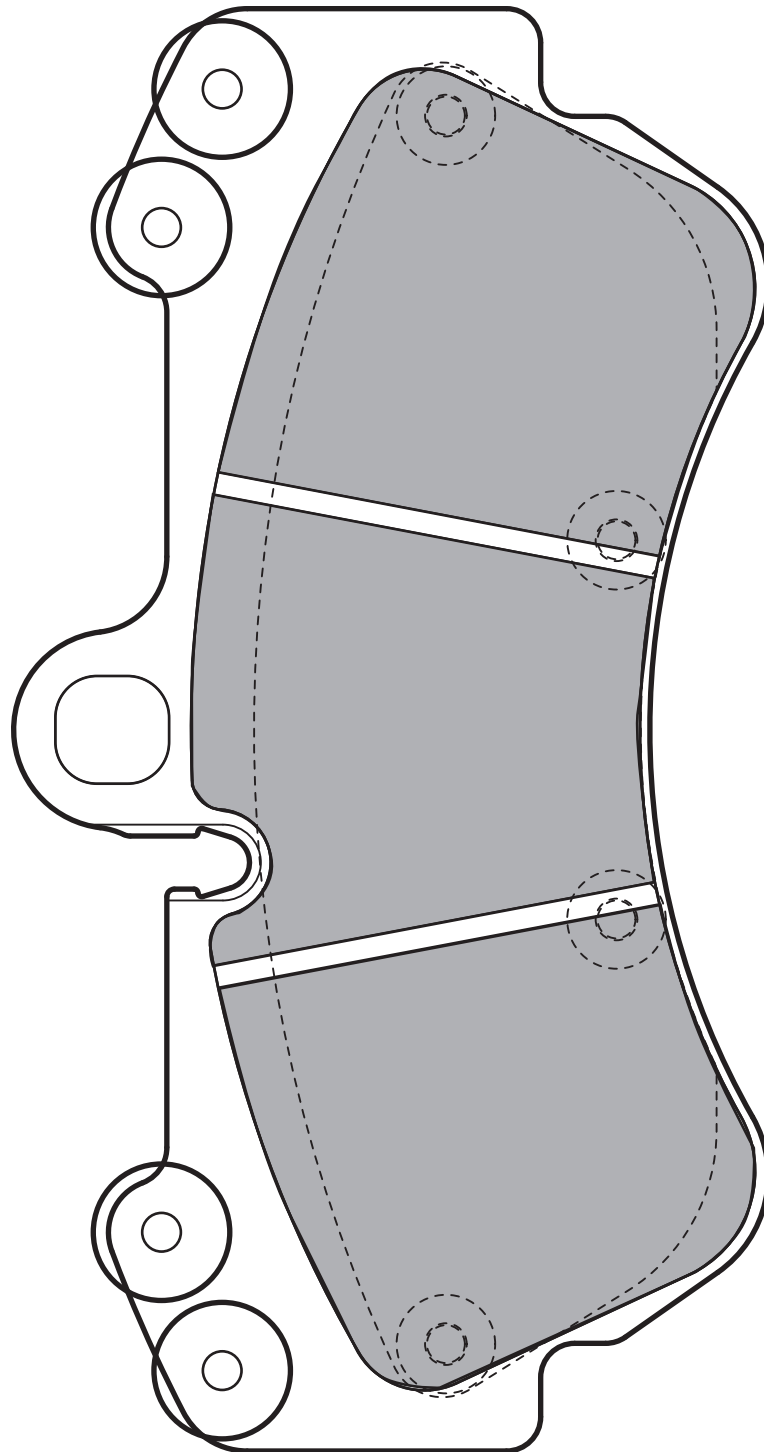

598655

0

190,2

99,5

16,6

BREMBO

PORSCHE, VOLKSWAGEN

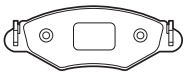

23693 (WVA)

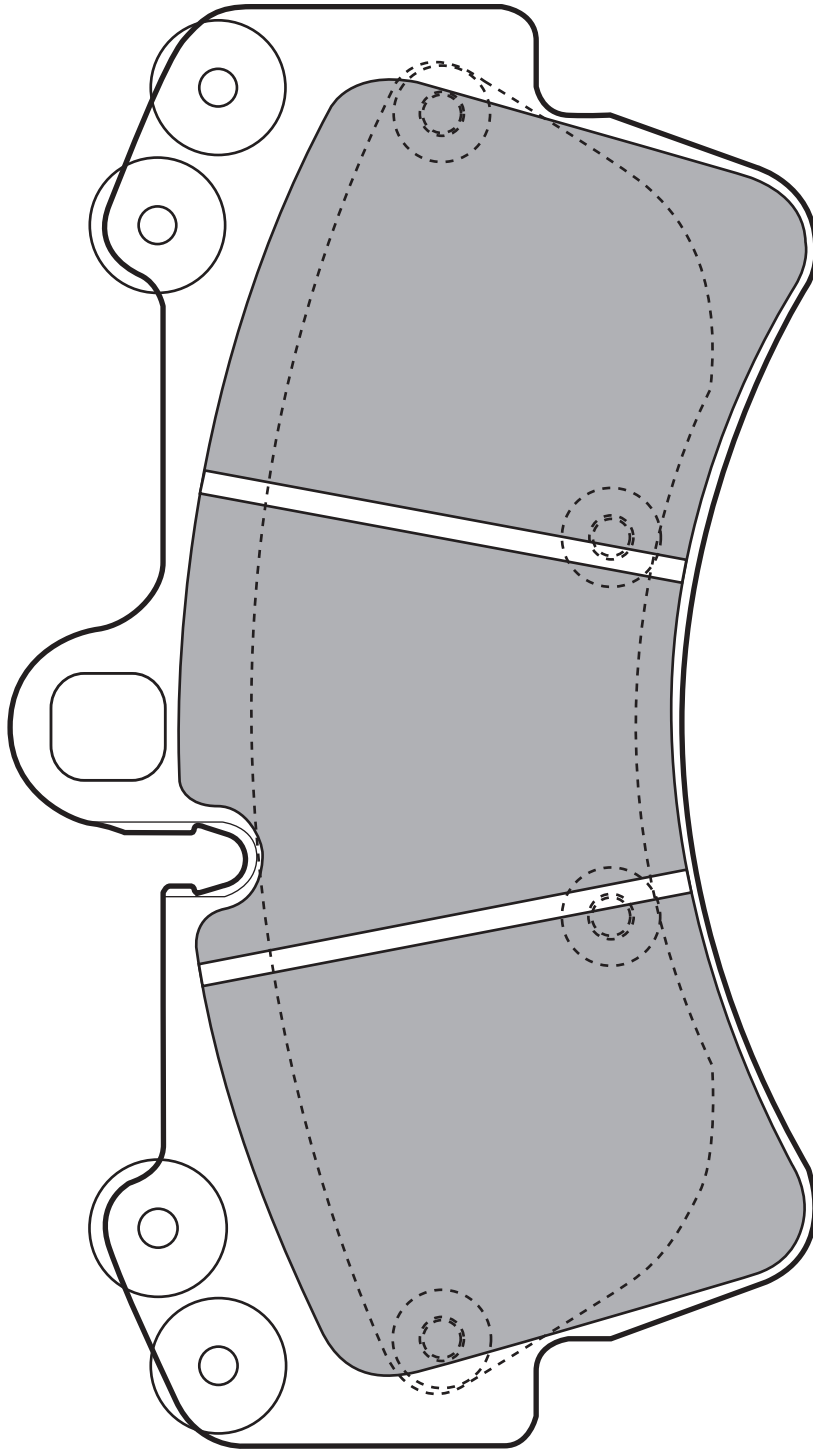

Valeo



Valeo



598656

0

190,2

106,5

16,6

BREMBO

AUDI, PORSCHE, VOLKSWAGEN

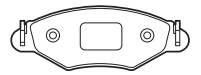

23694 (WVA)

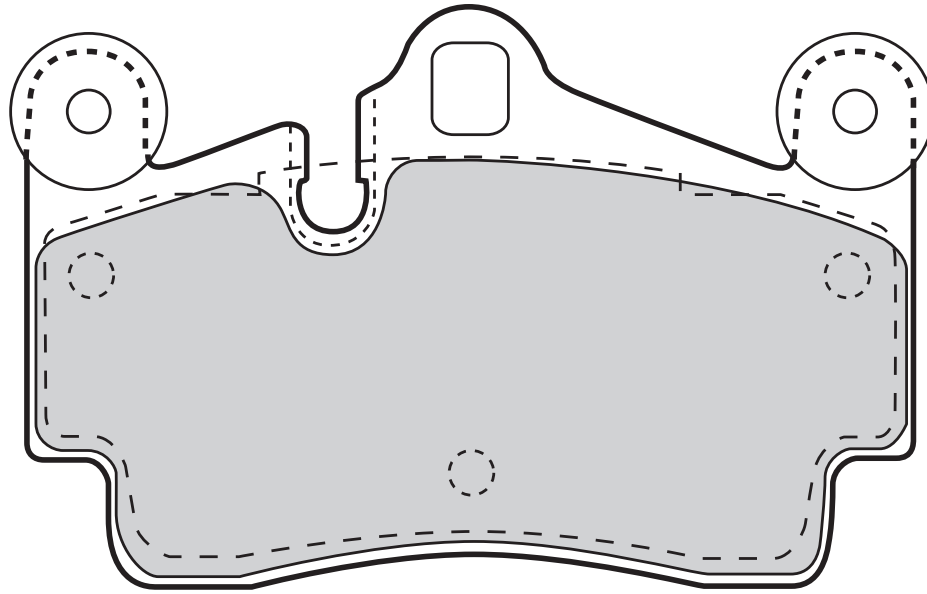

598770

0

117,3

73,1

16,7

BREMBO

AUDI, PORSCHE, VOLKSWAGEN

23703 (WVA)

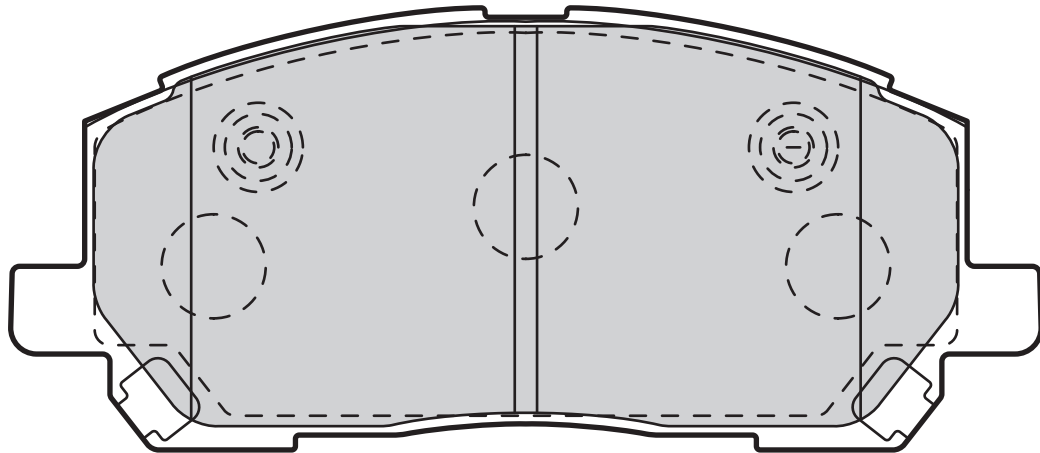

598944

2

Leaf

138

60

18,6

AKEBONO

LEXUS



23705 (WVA)

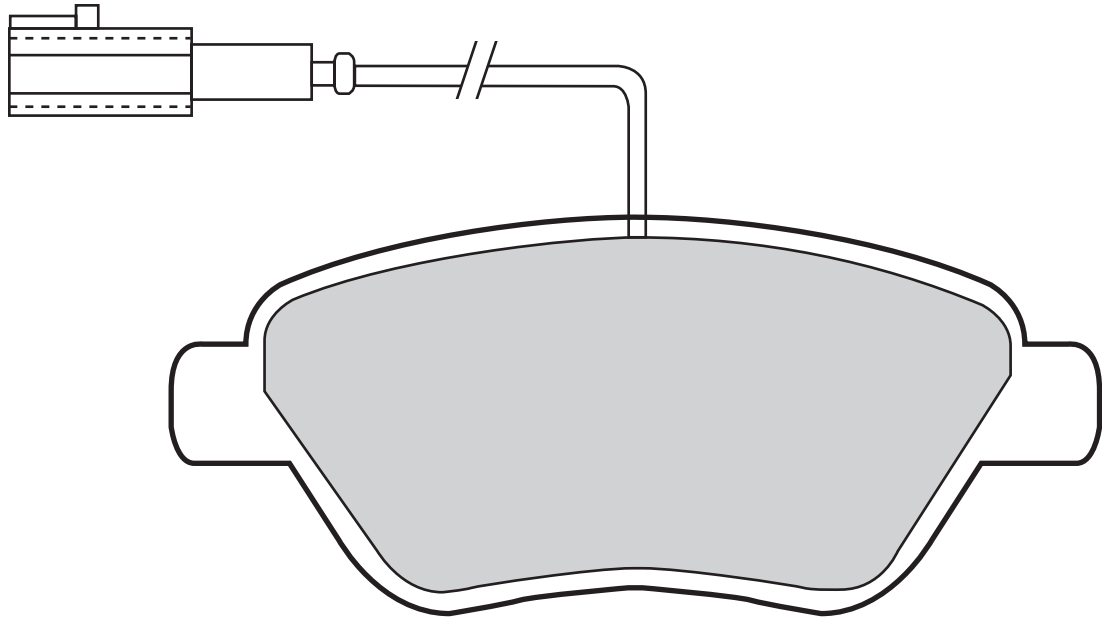

Valeo							
598426	1	215	123	53,3	17,8	BOSCH	ALFA ROMEO, CITROËN, FIAT, PEUGEOT
598670	2	215	122,7	53	17,8	BOSCH	FIAT, LANCIA
598913	0		122,7	53,2	17,8	BOSCH	FIAT, LANCIA

23708 (WVA)

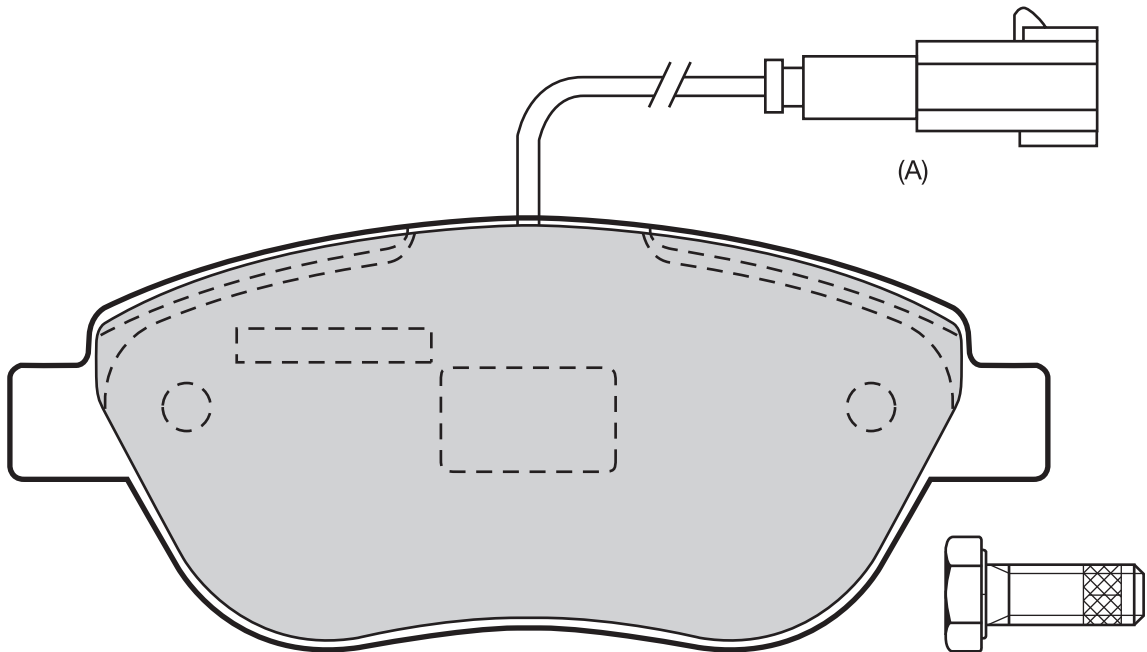

Valeo							
598427	1 (A)	200	137	57,4	19	BOSCH	FIAT, LANCIA
598698	0		136,7	57,4	19	BOSCH	FIAT, LANCIA
598839	1		136,7	57,3	19,7	BOSCH	OPEL, VAUXHALL

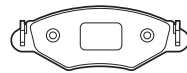

23711 (WVA)

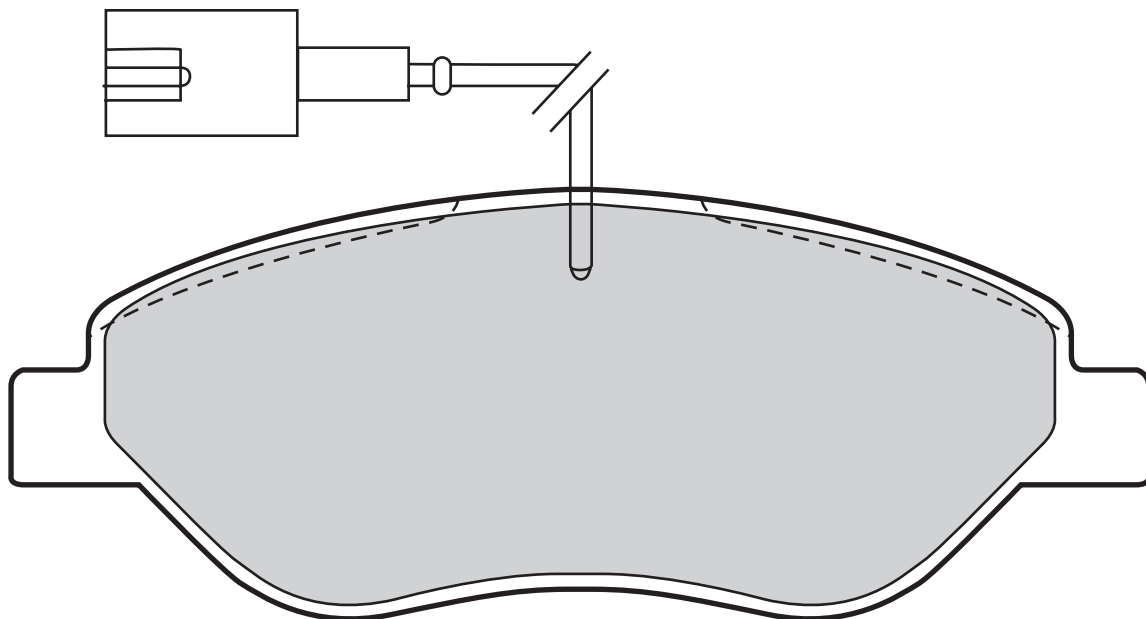

598428

1

195

151

57,5

19

BOSCH

ALFA ROMEO, FIAT, LANCIA

23714 (WVA)

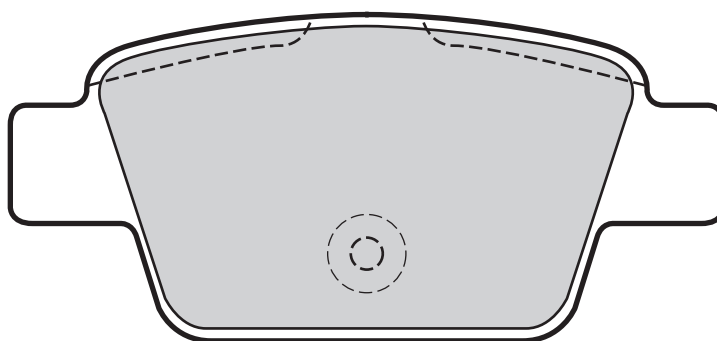

598633

0

95

42,9

16

BOSCH

ALFA ROMEO, FIAT, LANCIA

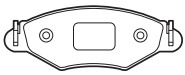

Valeo

23716 (WVA)

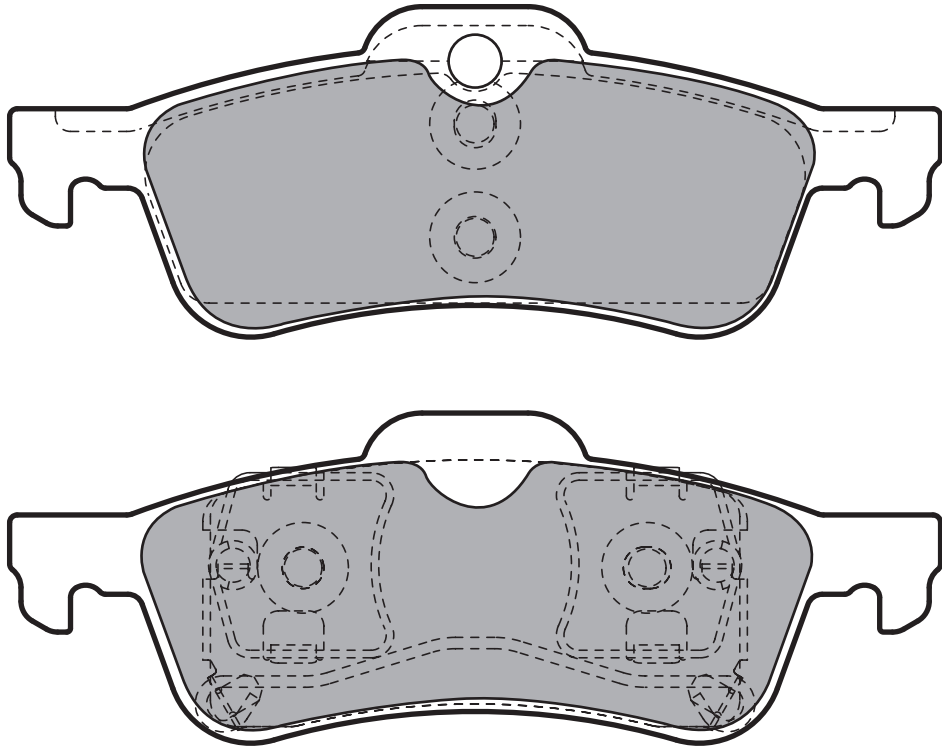

Valeo



0

Valeo



123



43,6



16,5



TEVES



MINI



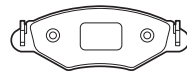

23719 (WVA)

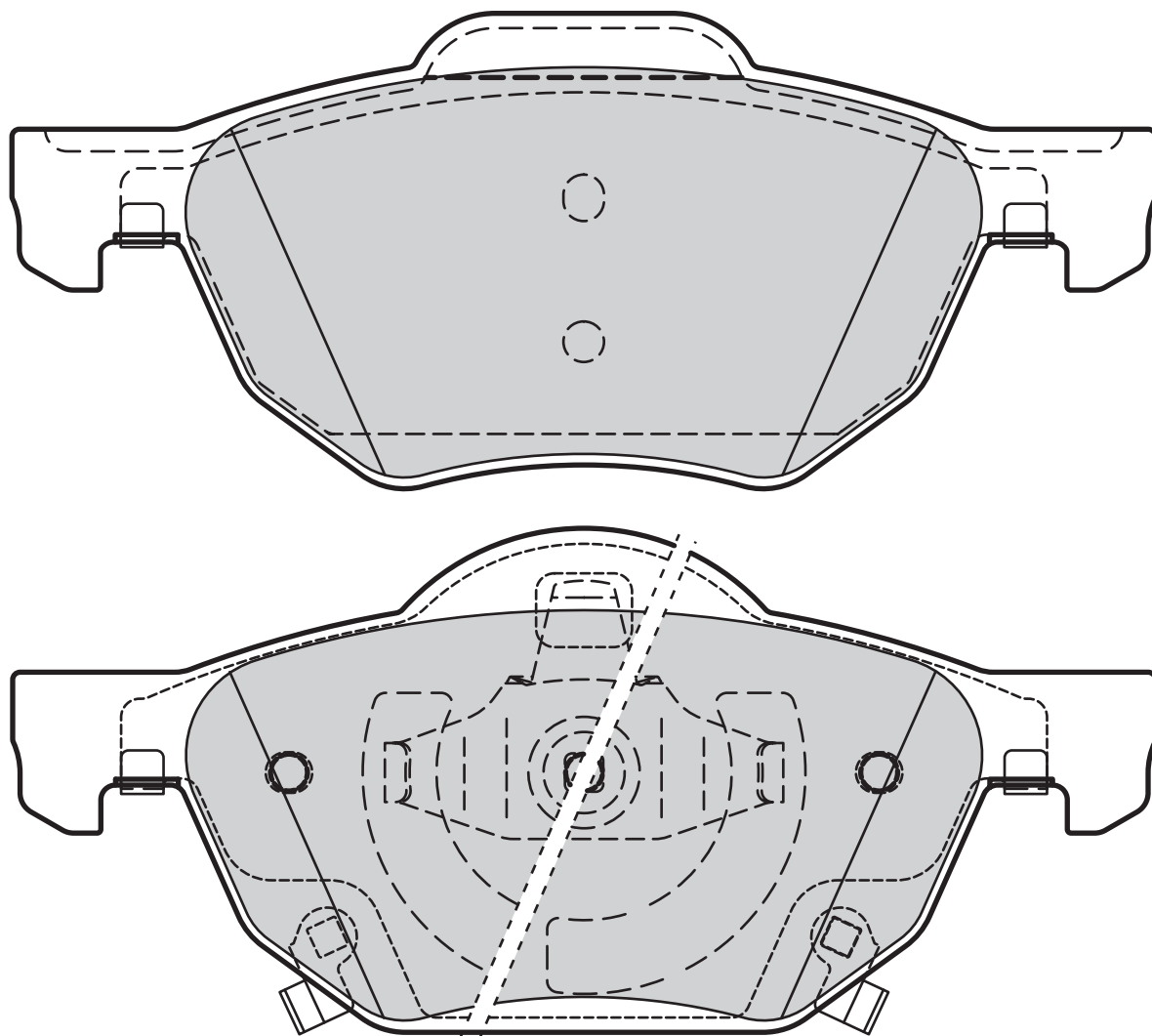

Valeo



Valeo



598824

2

154,9

64,5

17,5

TEVES

HONDA

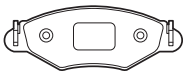

Valeo

23722 (WVA)

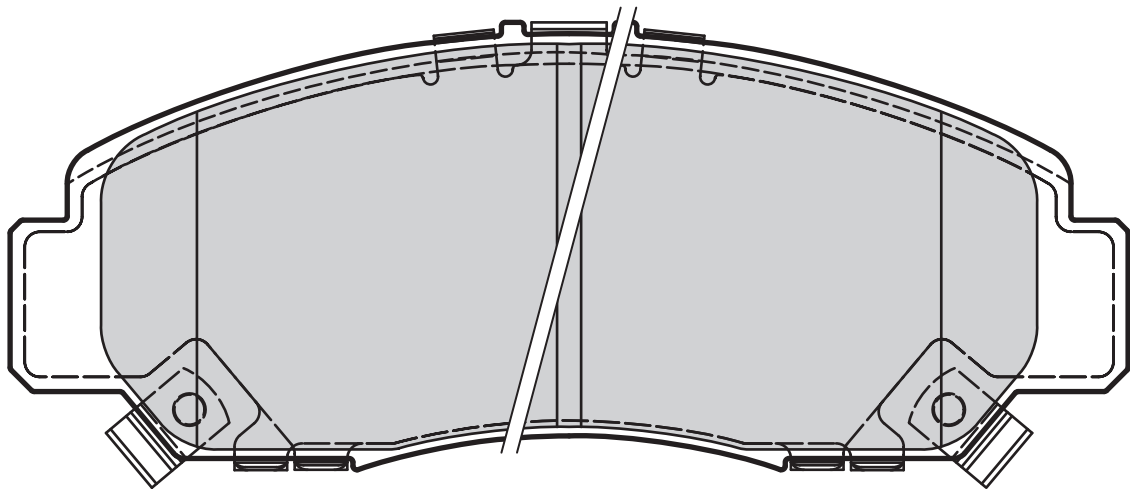
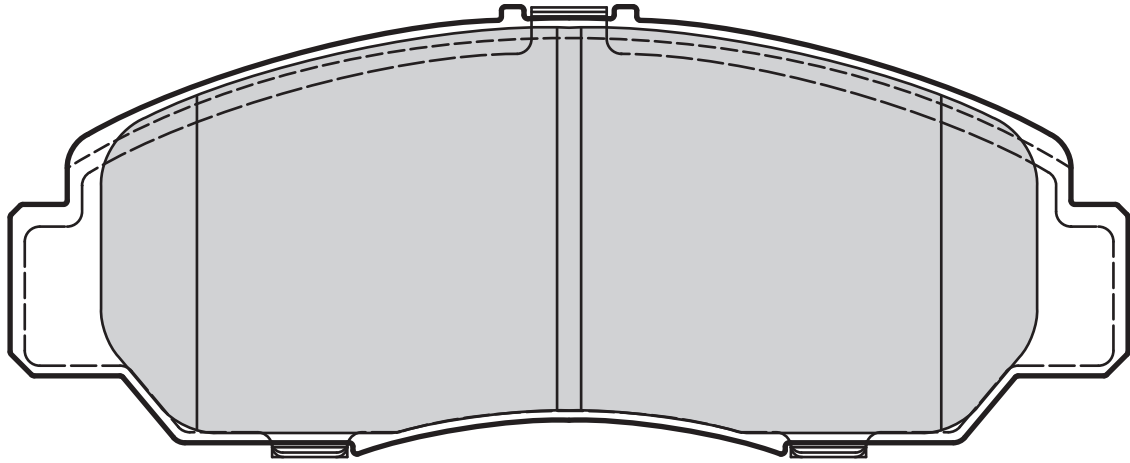

Valeo



Valeo



598887

2

Leaf

148,7

59

17

SUMITOMO

HONDA

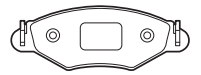

23723 (WVA)

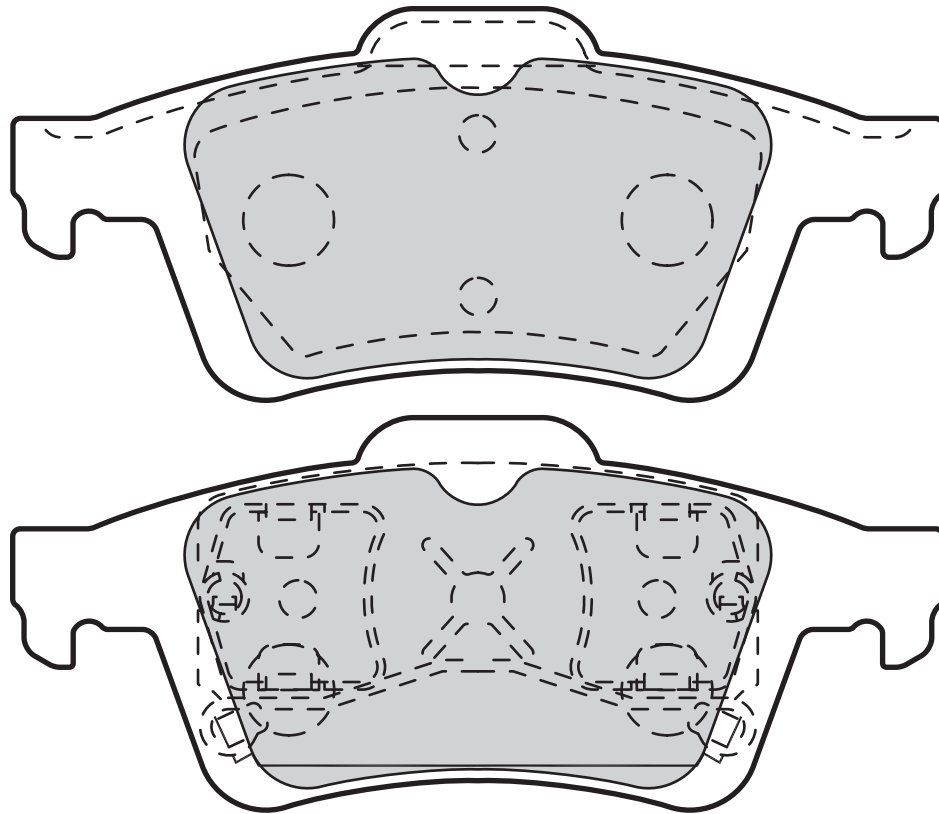

Valeo



Valeo



598649
601005
601008

0
0
0

156,3
122,9
122,9

62,6
51,8
51,8

17,5
16,4
16,4

TEVES
TEVES
AKEBONO

FORD, MAZDA, VOLVO
FORD, MAZDA, VOLVO
MAZDA

23726 (WVA)

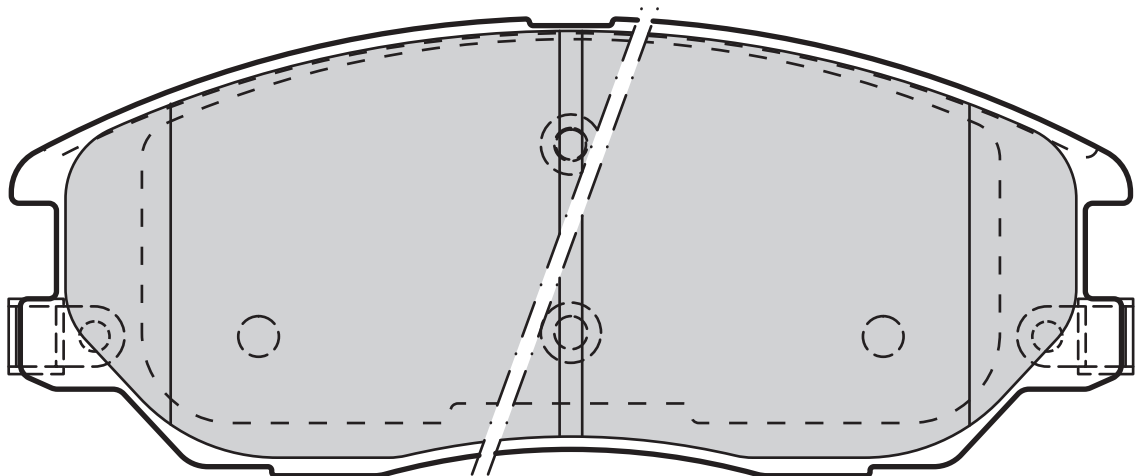

Valeo



Valeo



598871

2

148,7

60,8

17,2

MANDO

SSANGYONG

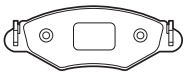

Valeo

23730 (WVA)

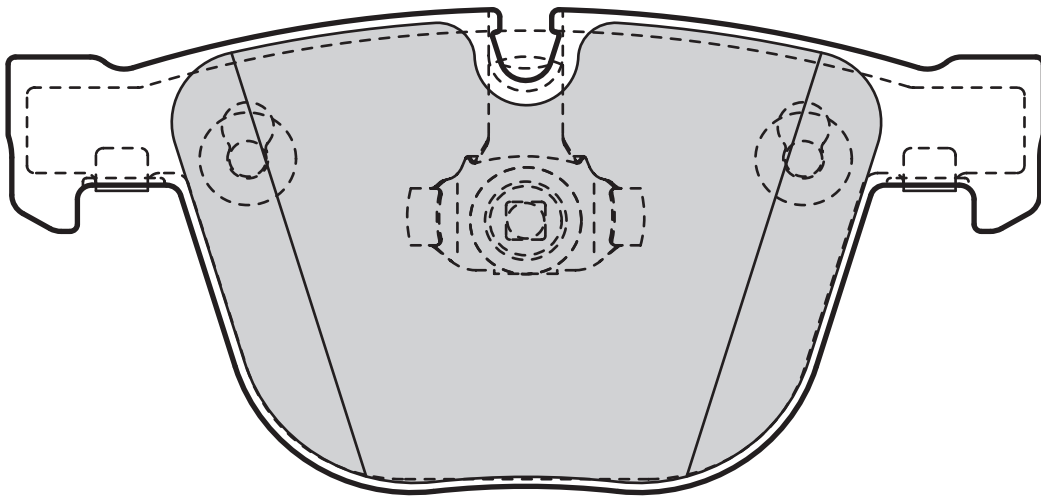
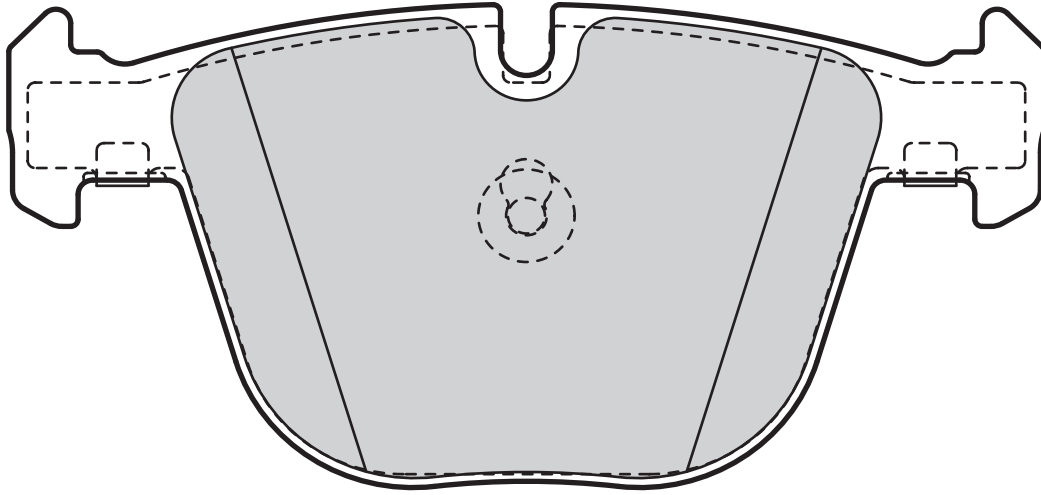

Valeo



0

Valeo



137



63,4



18



TEVES



BMW



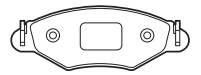

23736 (WVA)

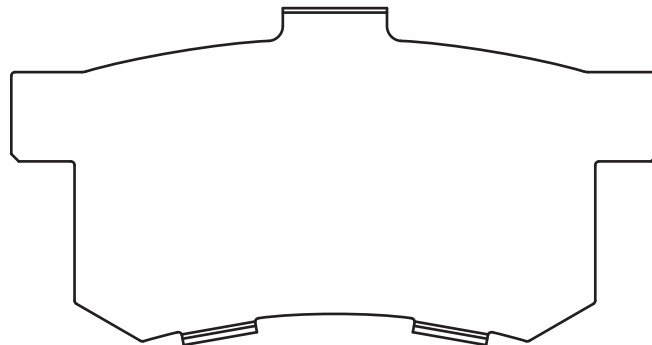
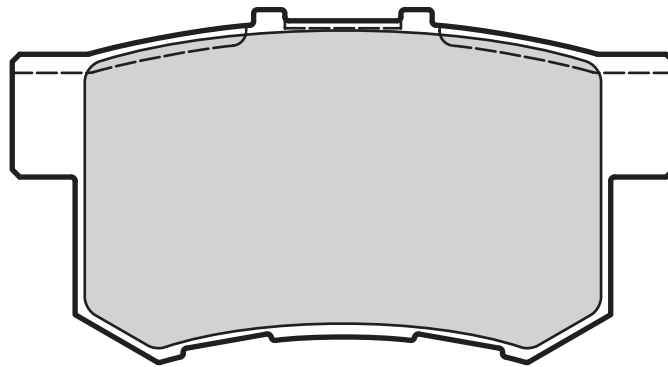
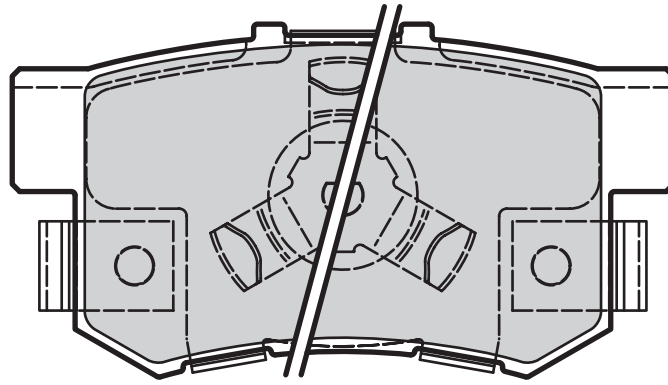

Valeo



Valeo



601043

2

Leaf

88,8

47,6

15,4

AKEBONO

HONDA

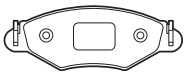

Valeo

23743 (WVA)

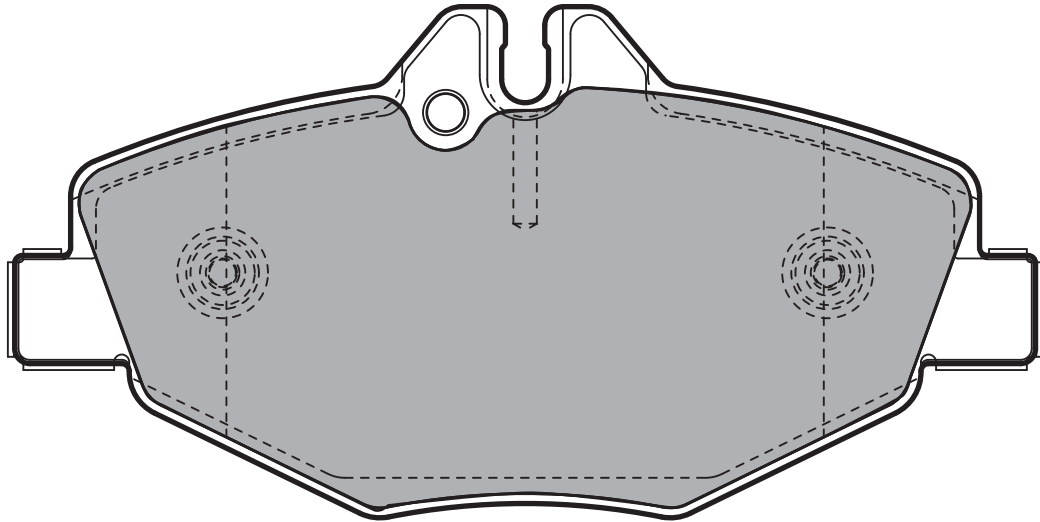

Valeo



Valeo



598638

2

137

67,8

20

BOSCH

MERCEDES

23745 (WVA)

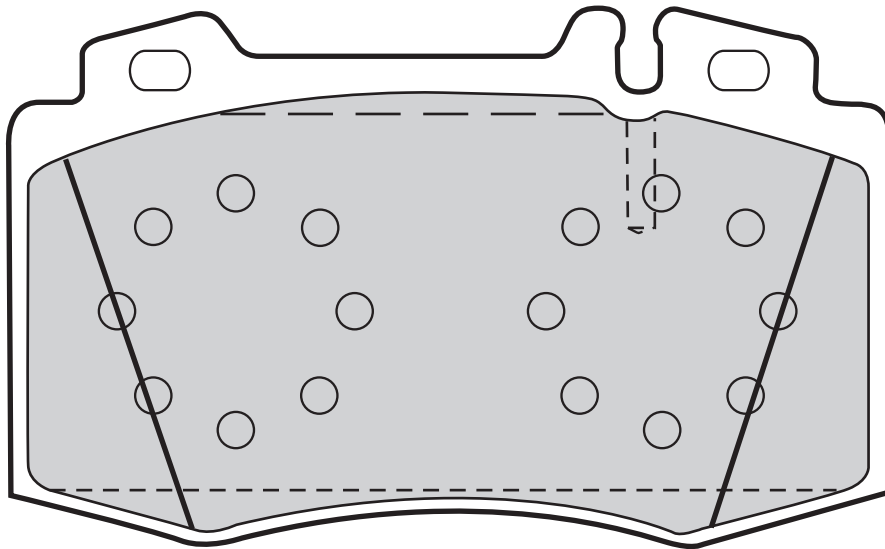
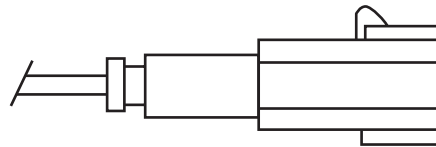

Valeo



Valeo



598659

0

117,8

71,5

17,2

BREMBO

MERCEDES



23746 (WVA)

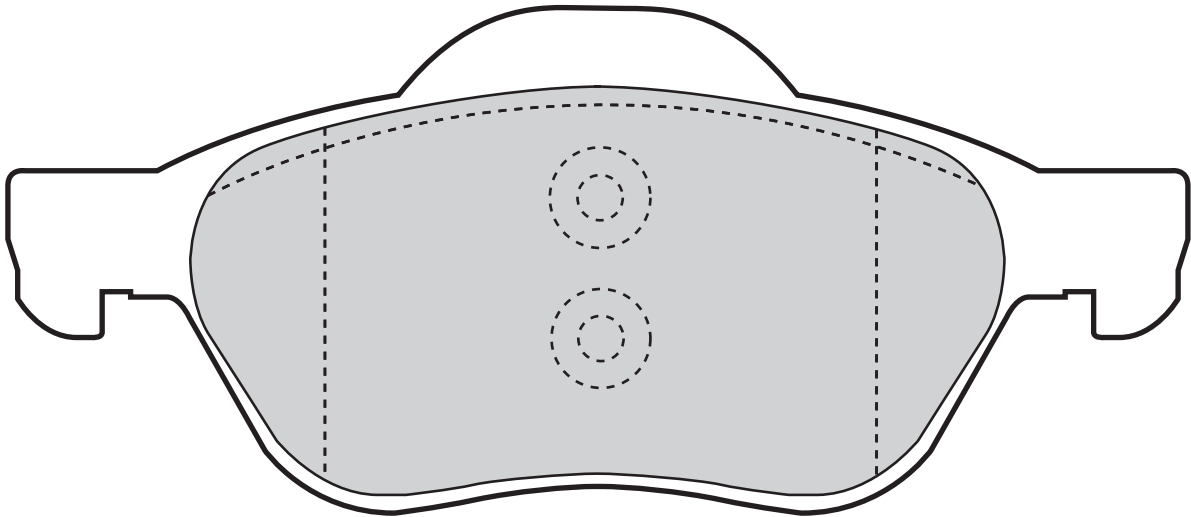
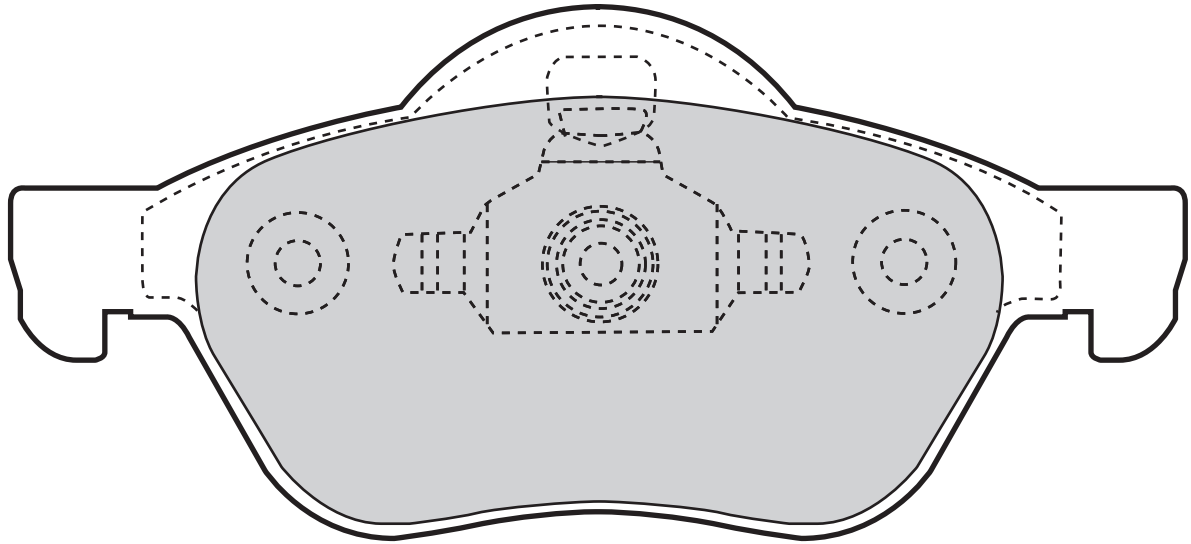

Valeo



Valeo



598651
598652

1
1

200
200

156,2
156,2

73,3
73,3

19
17,5

TEVES
TEVES

VOLKSWAGEN
VOLKSWAGEN



Valeo

23759 (WVA)

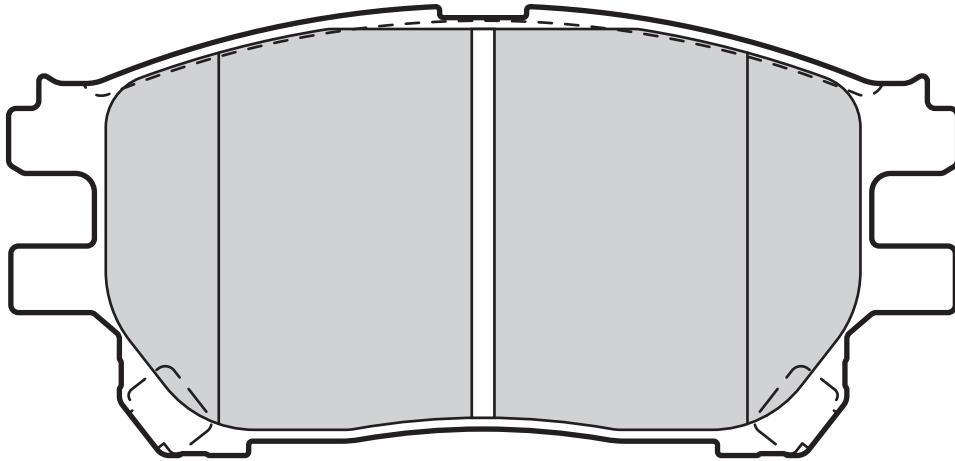

Valeo



Valeo



598710

125,5

59,4

17

SUMITOMO

TOYOTA

23760 (WVA)

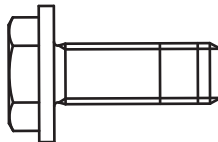
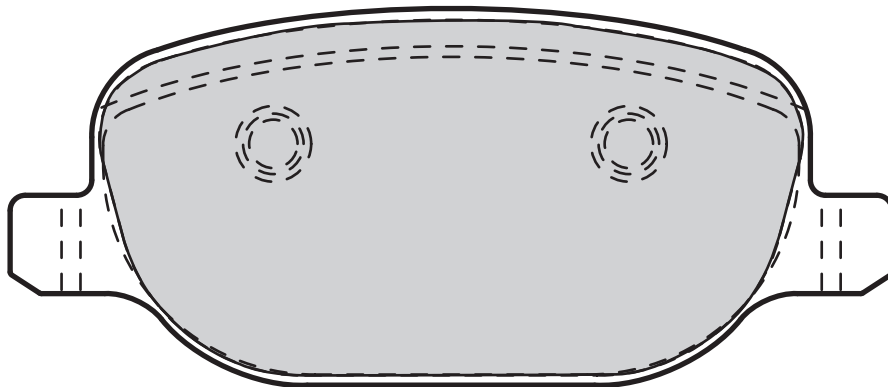

Valeo



Valeo



601029

0

116

50

17,8

LUCAS

ALFA ROMEO, LANCIA

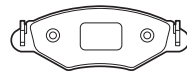

23761 (WVA)

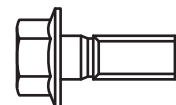
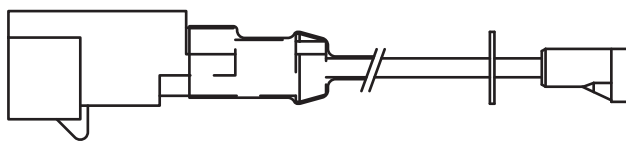
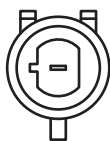
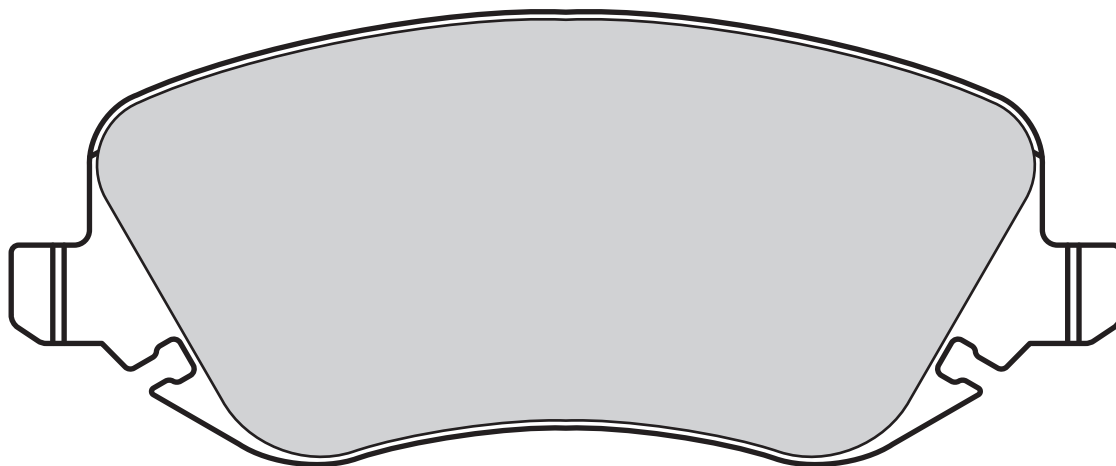

Valeo



Valeo



601001

2

205

146,5

59,5

19

LUCAS

LANCIA

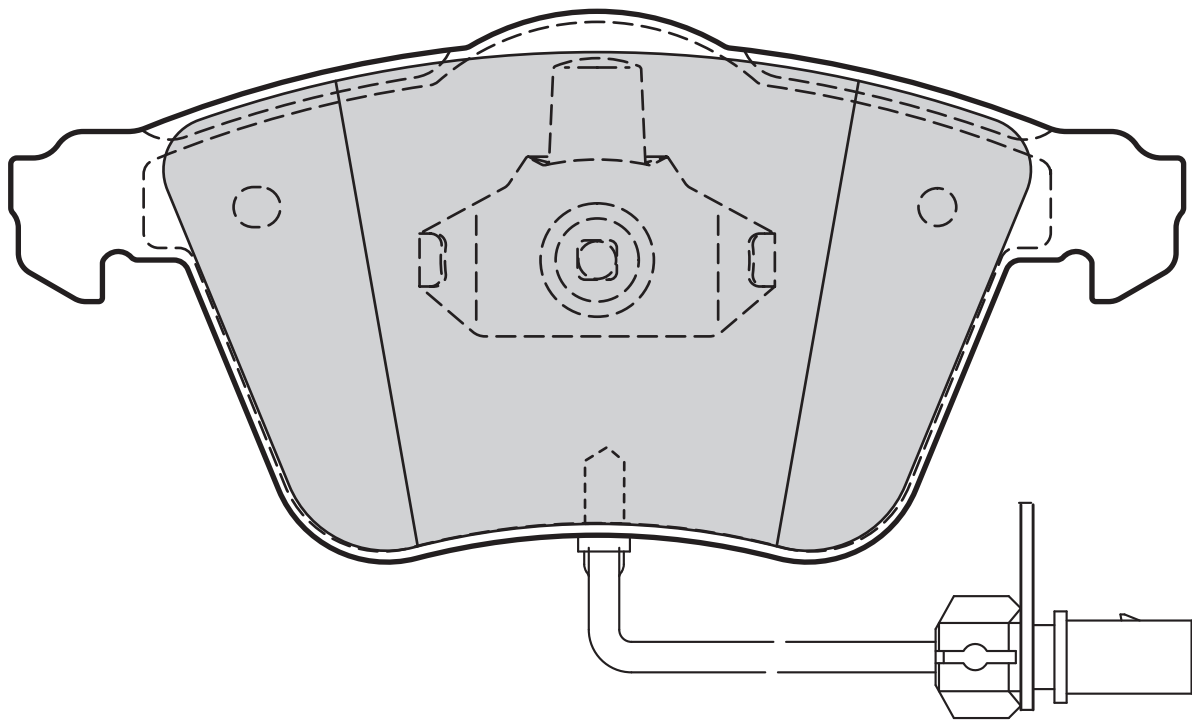
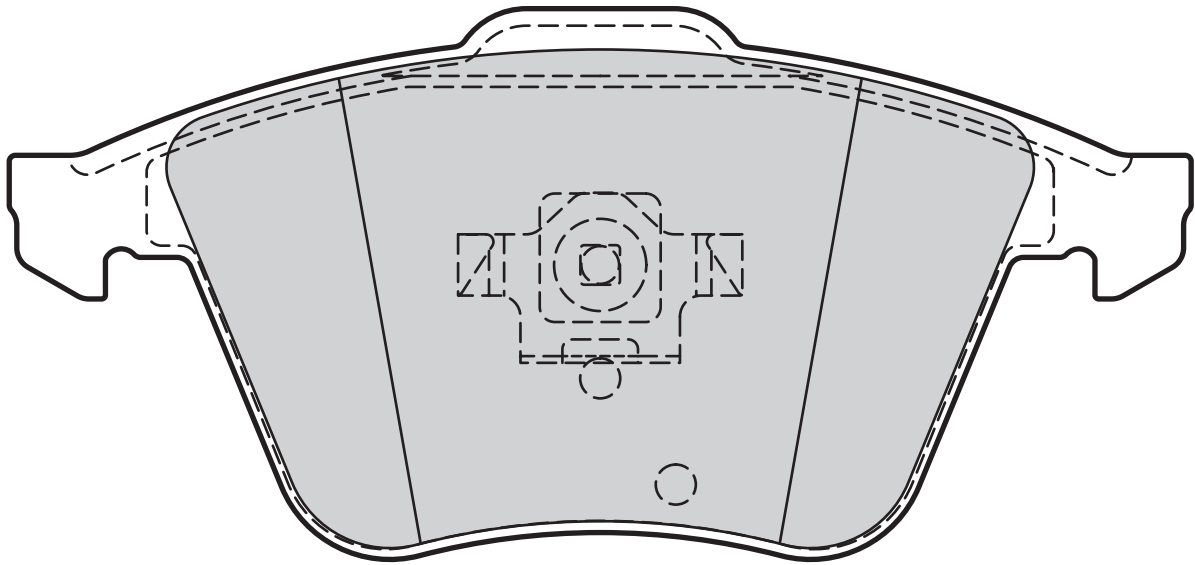

Valeo



Valeo



598750
598779
598822

2
2
0

210
250

155,1
156,3
156,3

72,8
72,8
72,8

20,3
20,3
18,5

TEVES
TEVES
TEVES

AUDI
AUDI, SEAT
FORD, OPEL, SAAB, VOLVO

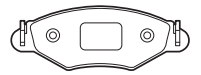

23766 (WVA)

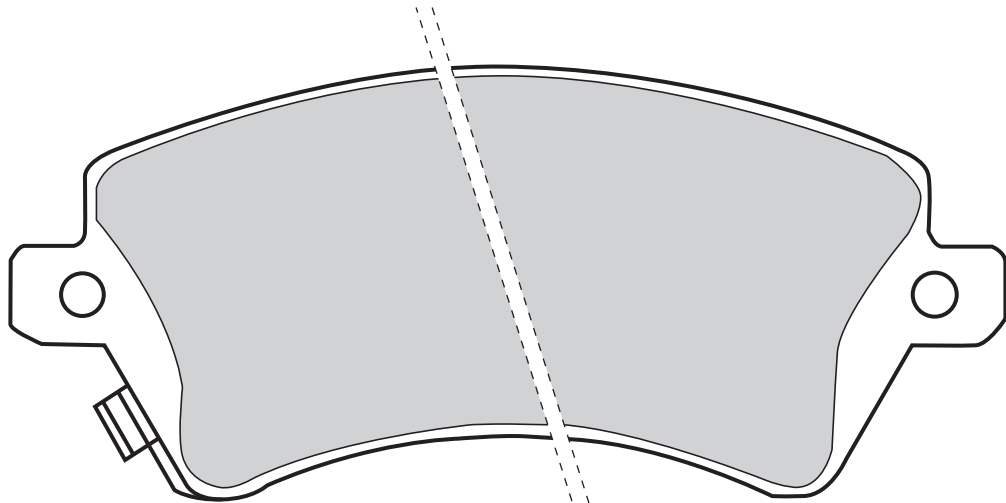

Valeo



2

Valeo



17,8



LUCAS



TOYOTA

598679

131,7

57,4

23768 (WVA)

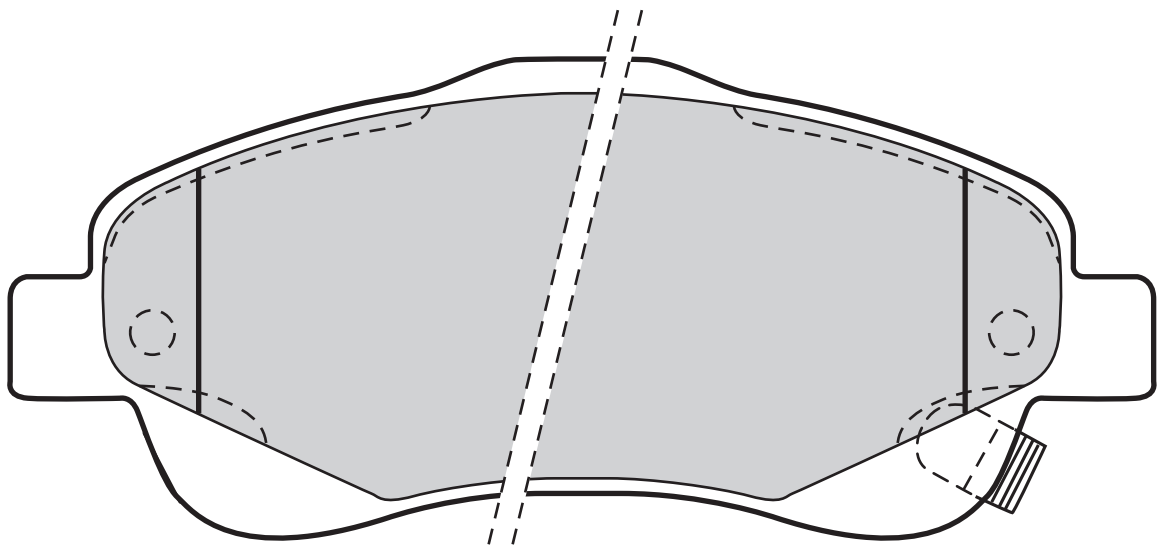

Valeo



2

Valeo



18,8



BOSCH



TOYOTA

598665

151

63,1



Valeo

23776 (WVA)

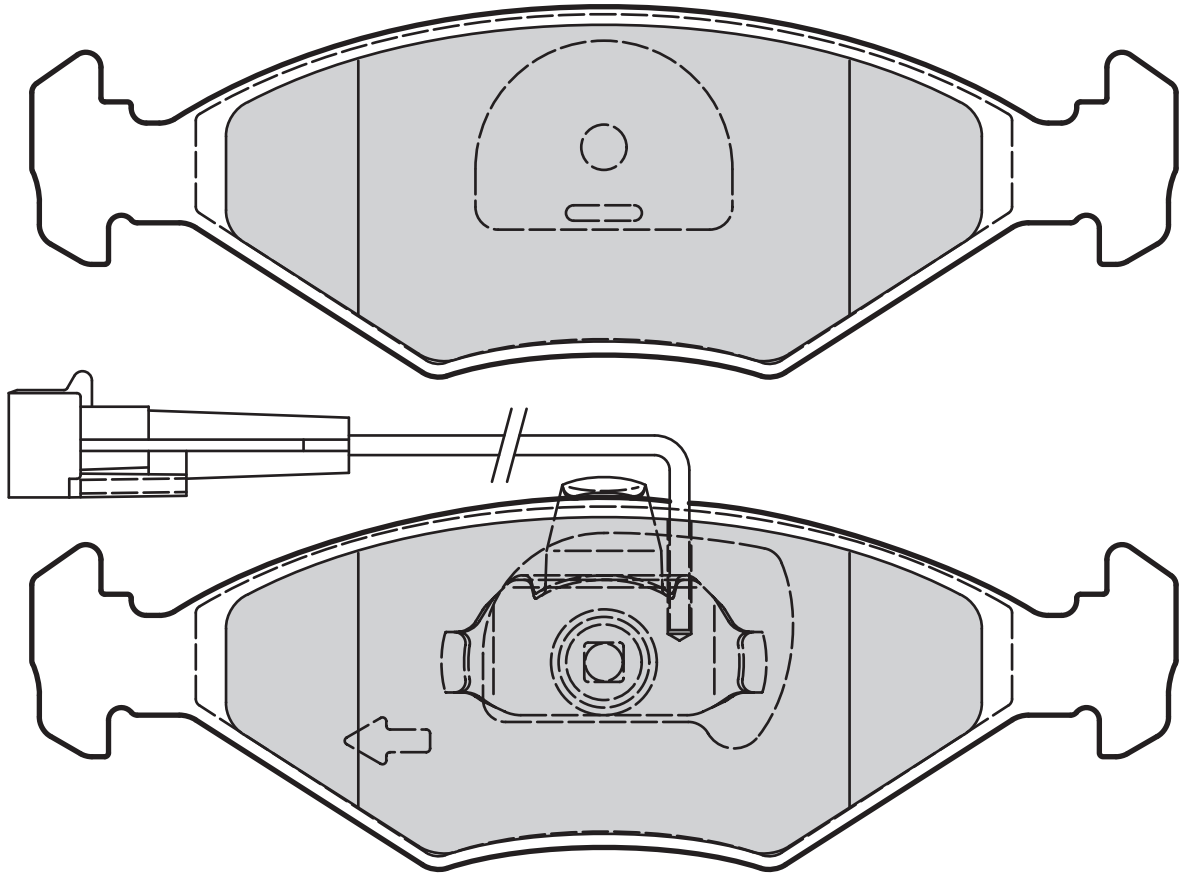

Valeo



2

Valeo



200



151,4



49



18



TEVES



FIAT



23780 (WVA)

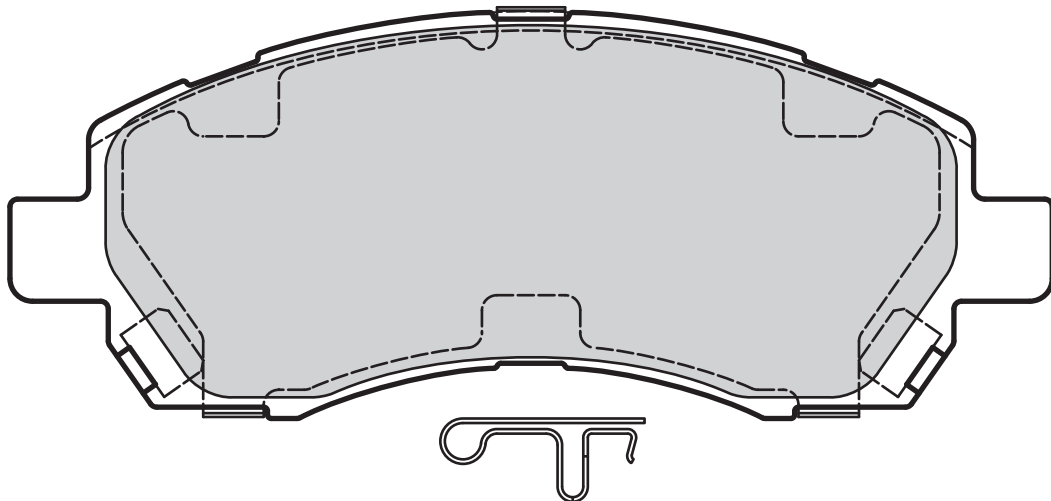

Valeo



2

Valeo



Leaf



137,7



53,8



18



AKEBONO



SUBARU



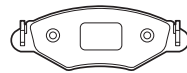

23794 (WVA)

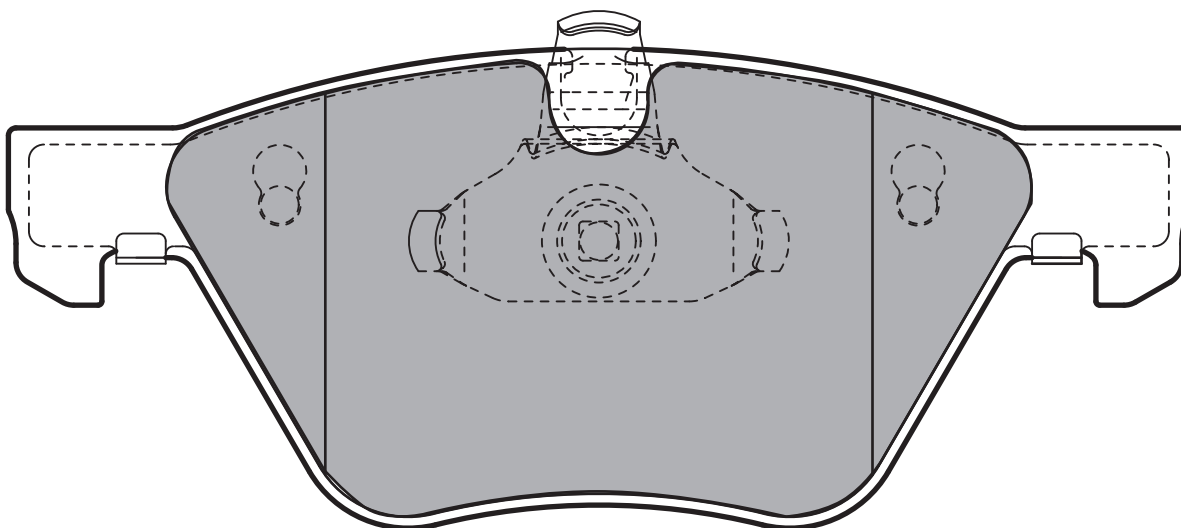
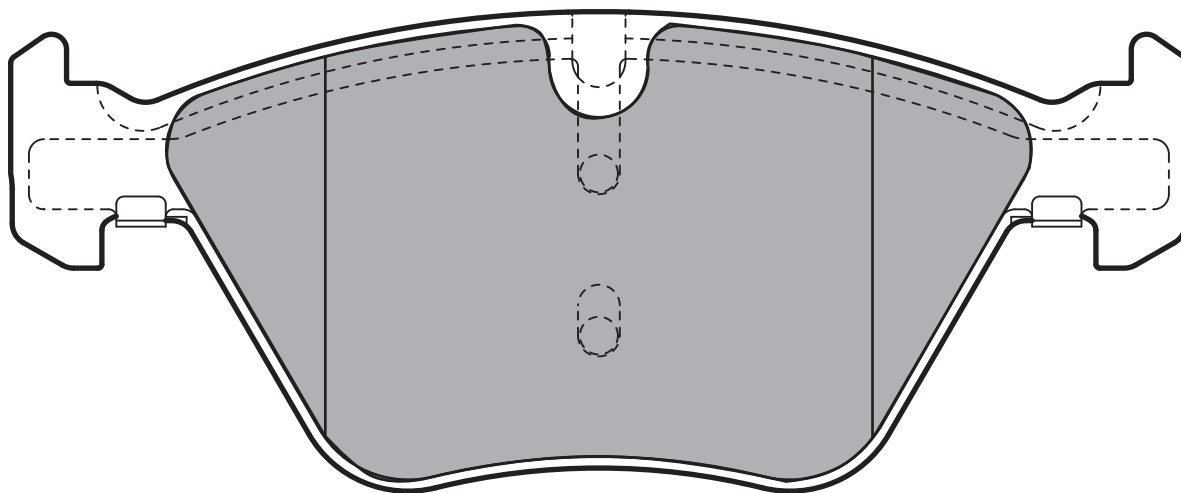

Valeo



Valeo



598640

0

170

154,8

63,6

20

TEVES

BMW

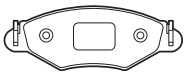

Valeo

23795 (WVA)

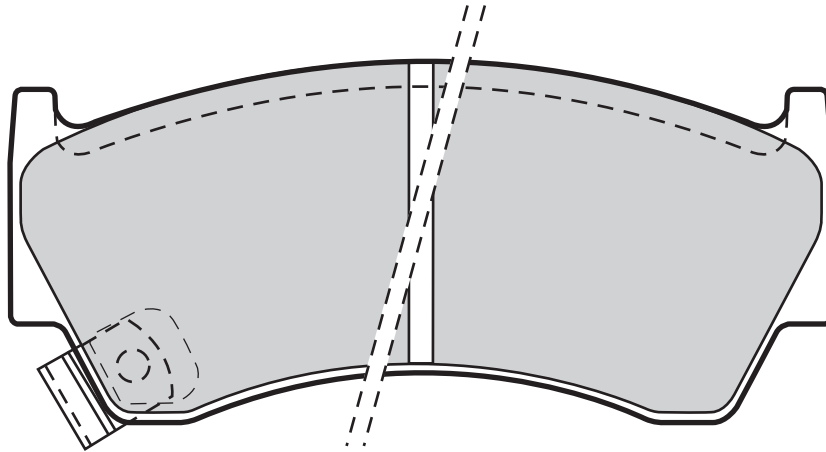

Valeo



Valeo



598697

2

108,4

47,7

15

SUMITOMO

SUZUKI

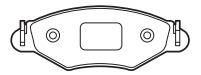

23801 (WVA)

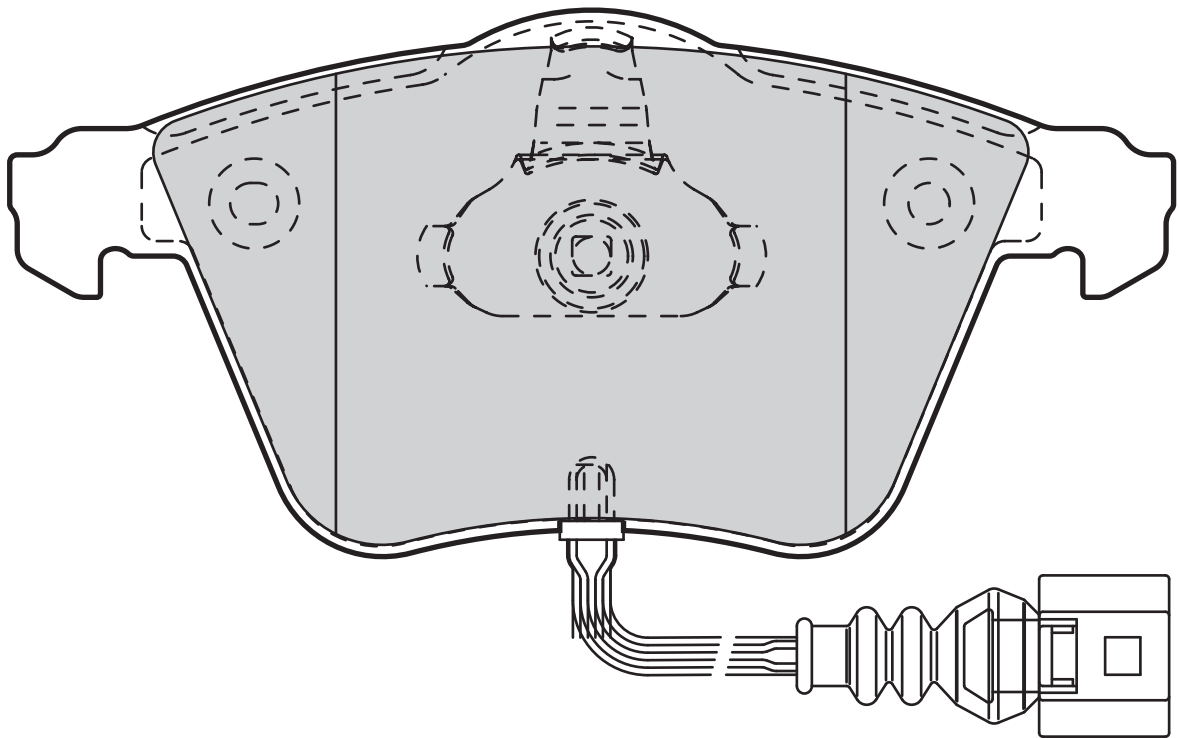
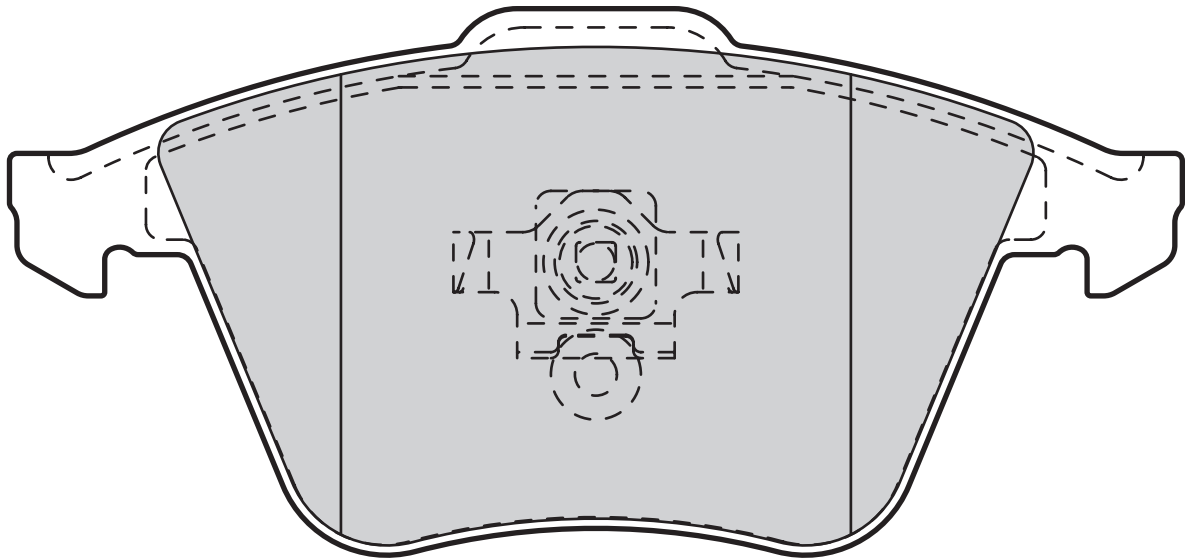

Valeo



Valeo



598863

1

206

155,1

72,8

20,3

TEVES

AUDI, SEAT, SKODA, VOLKSWAGEN



Valeo

23806 (WVA)

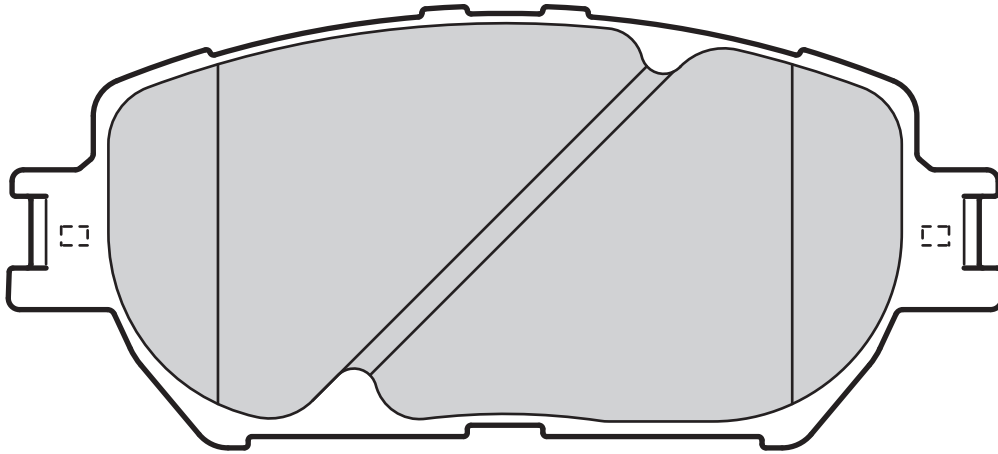

Valeo



Valeo



598862

0

131,4

58,5

17,3

AKEBONO

TOYOTA

23807 (WVA)

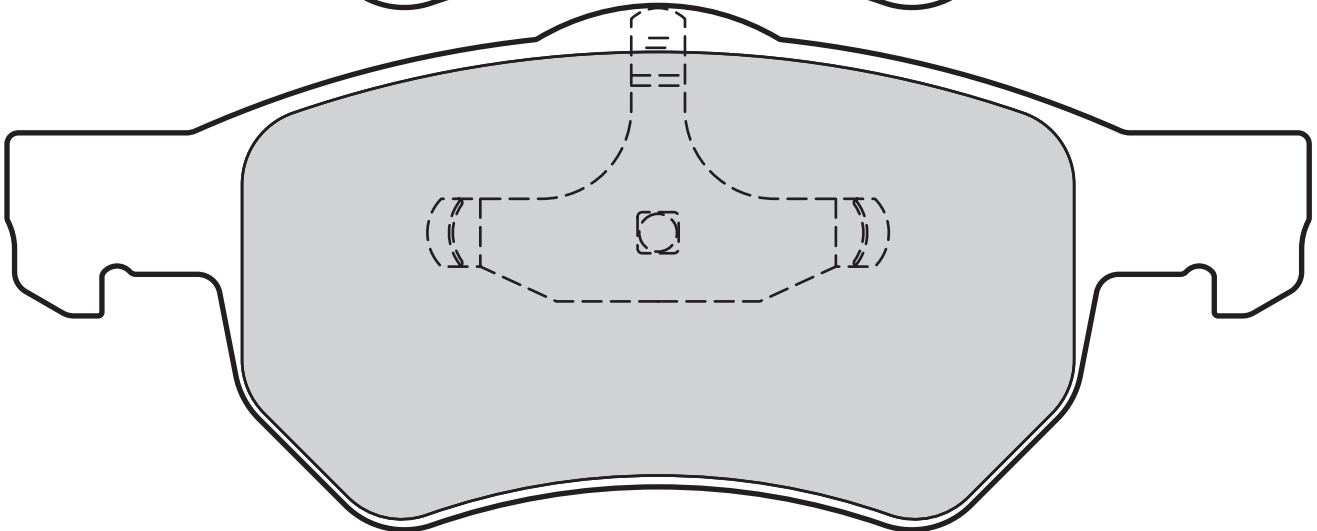
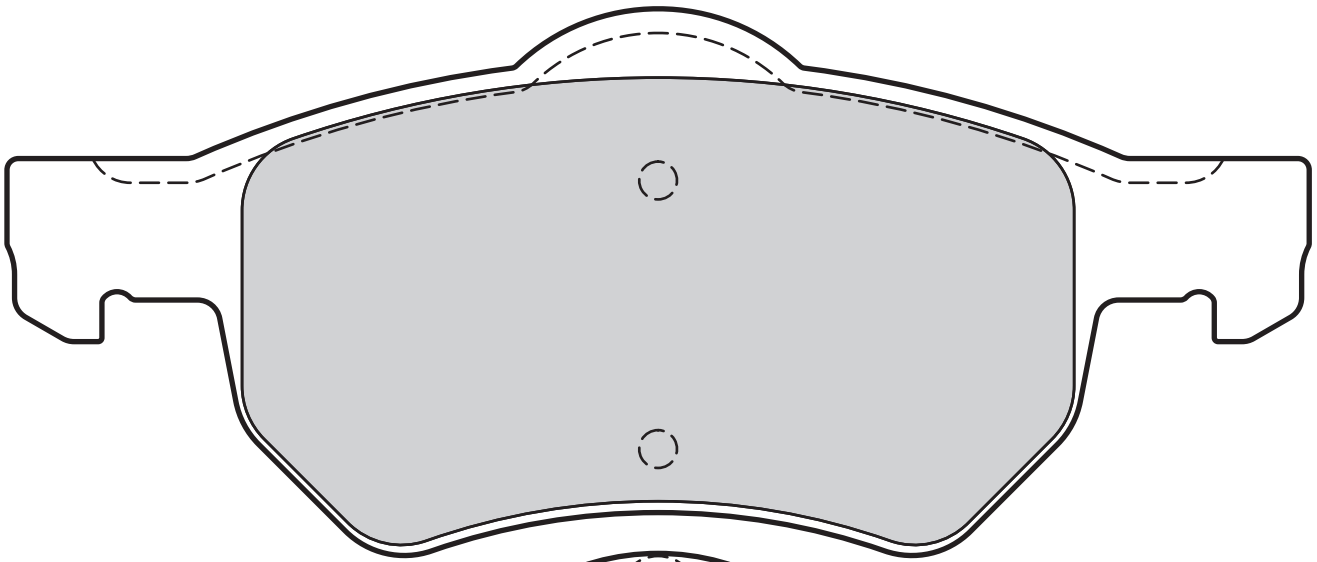

Valeo



Valeo



598756

172,2

72,3

18,6

TEVES

CHRYSLER

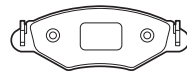

23816 (WVA)

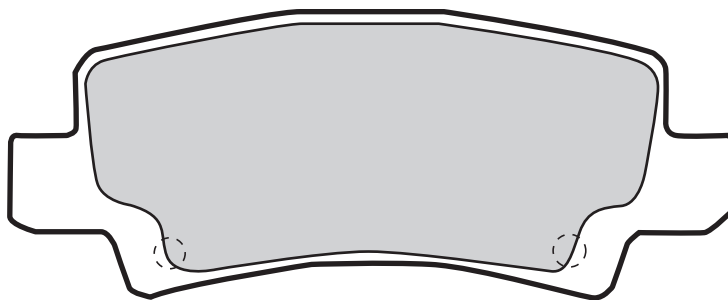

598680

2

95,7

38

15,8

LUCAS

TOYOTA

23817 (WVA)

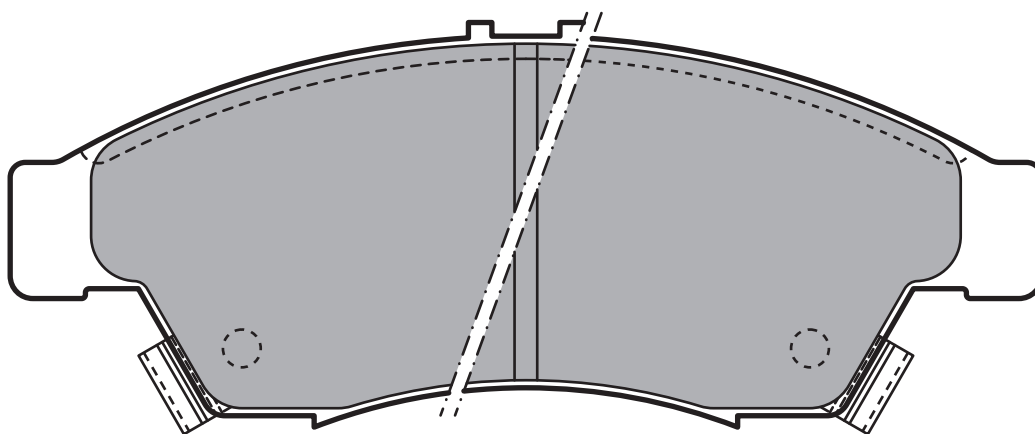

598848

2

13,4

53,2

17,2

AKEBONO

SUZUKI

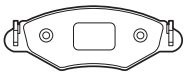

Valeo

23832 (WVA)

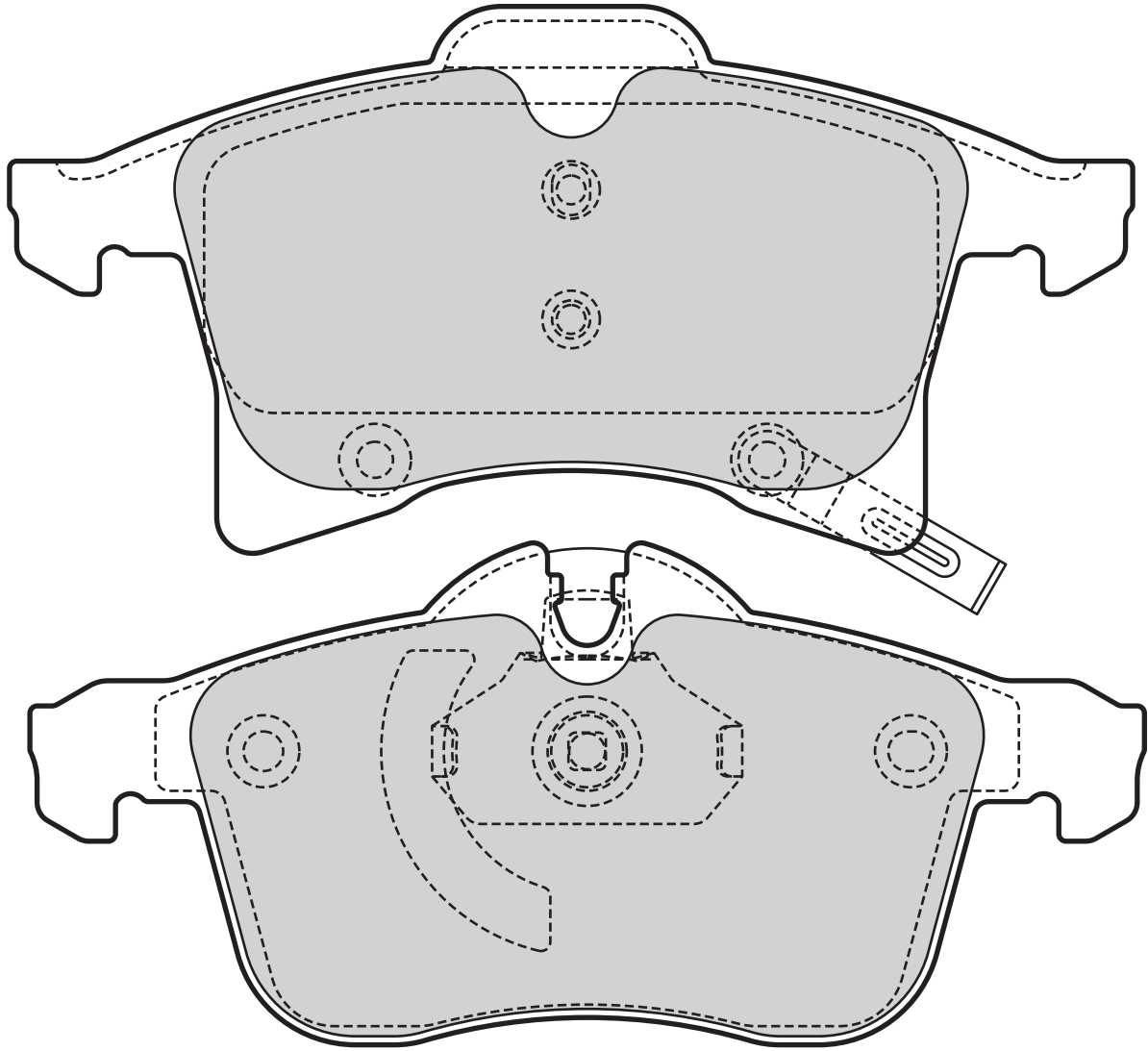

Valeo



Valeo



598860

2

156,1

69,8

20,4

TEVES

OPEL, VAUXHALL



23834 (WVA)

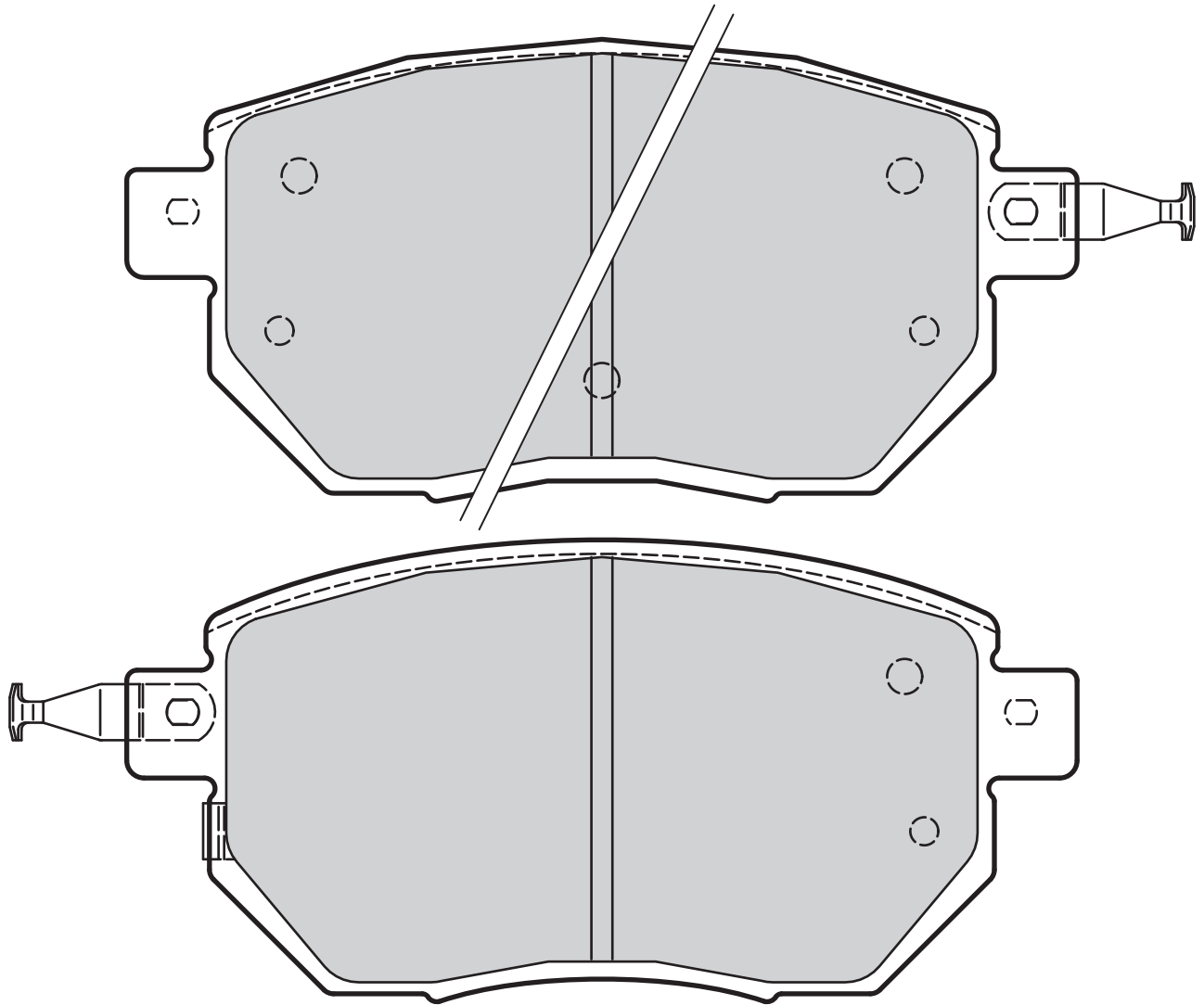

598918

1

Leaf

135,5

66

15,5

TOKICO

INFINITI

23865 (WVA)

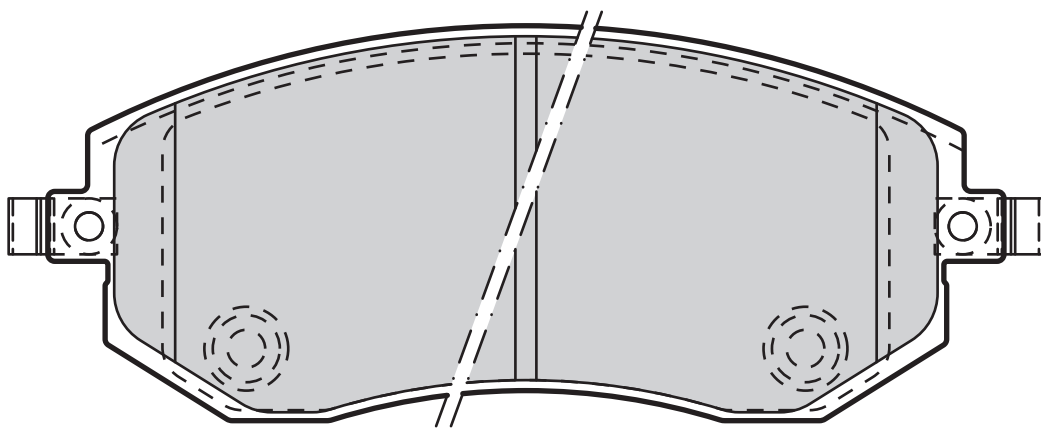

598853

2

136,8

56,5

17,5

AKEBONO

SUBARU

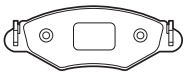

23868 (WVA)

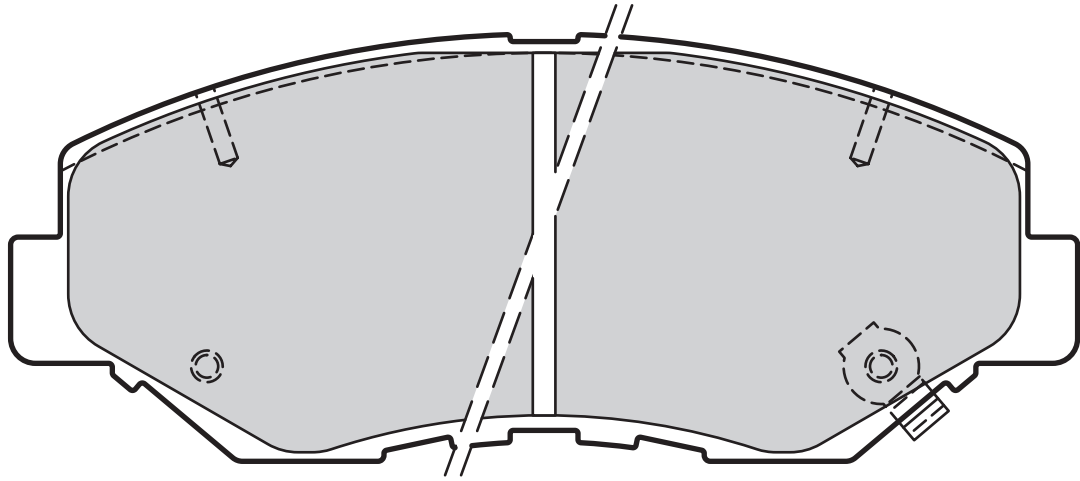

Valeo



2

Valeo



141,6



56,6



18



AKEBONO



HONDA

598757

23871 (WVA)

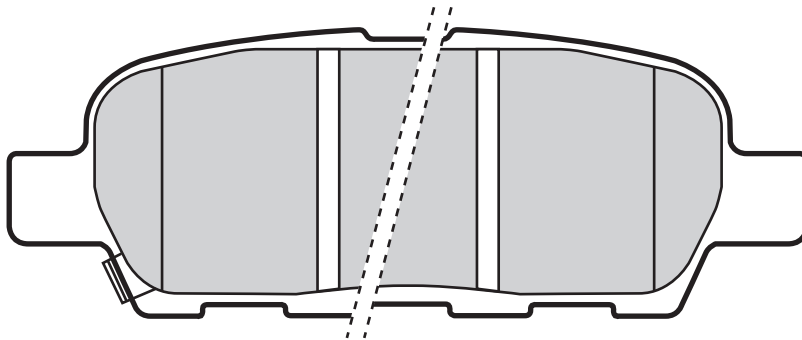

Valeo



2

Valeo



105,5



38



14



AKEBONO



NISSAN

598672



23873 (WVA)

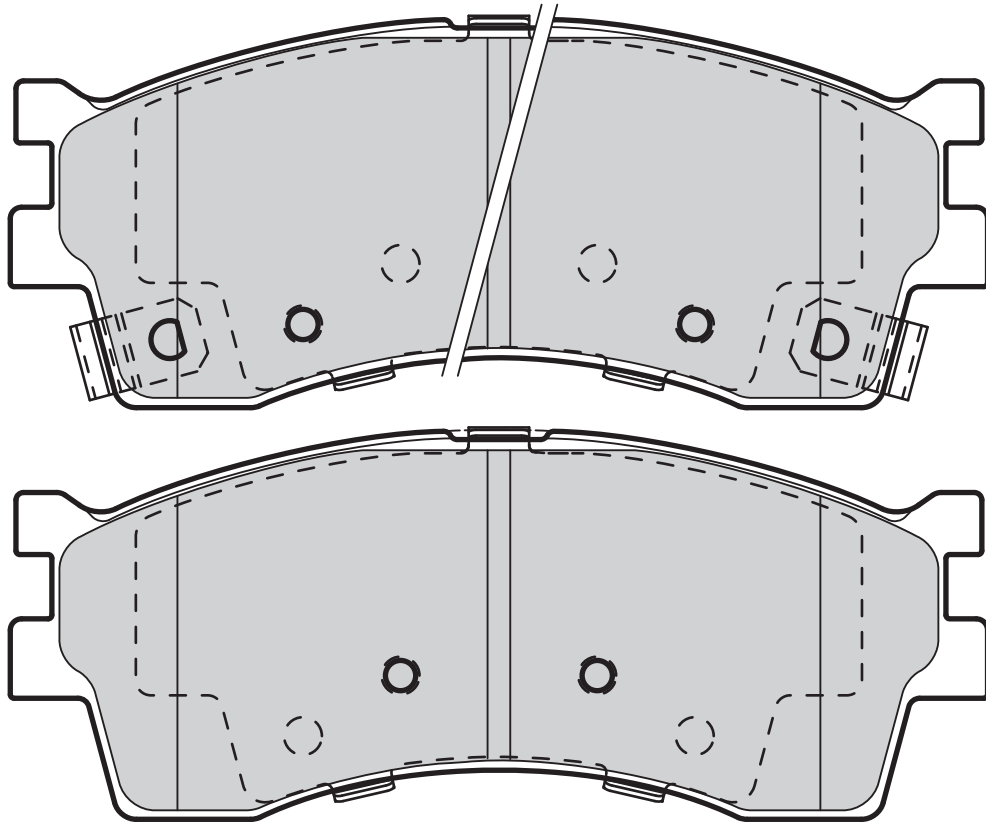

Valeo



Valeo



Leaf



128,9



51,3



16,5



SUMITOMO



KIA

598910

2

23879 (WVA)

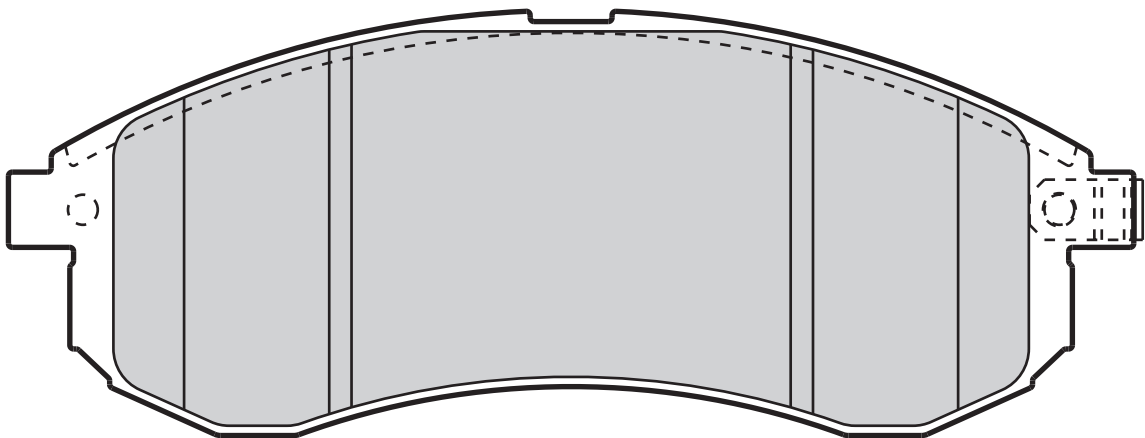

Valeo



Valeo



151



56,1



16



SUMITOMO



mitsubishi

598855

1

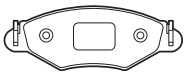

Valeo

23881 (WVA)

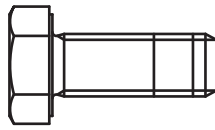
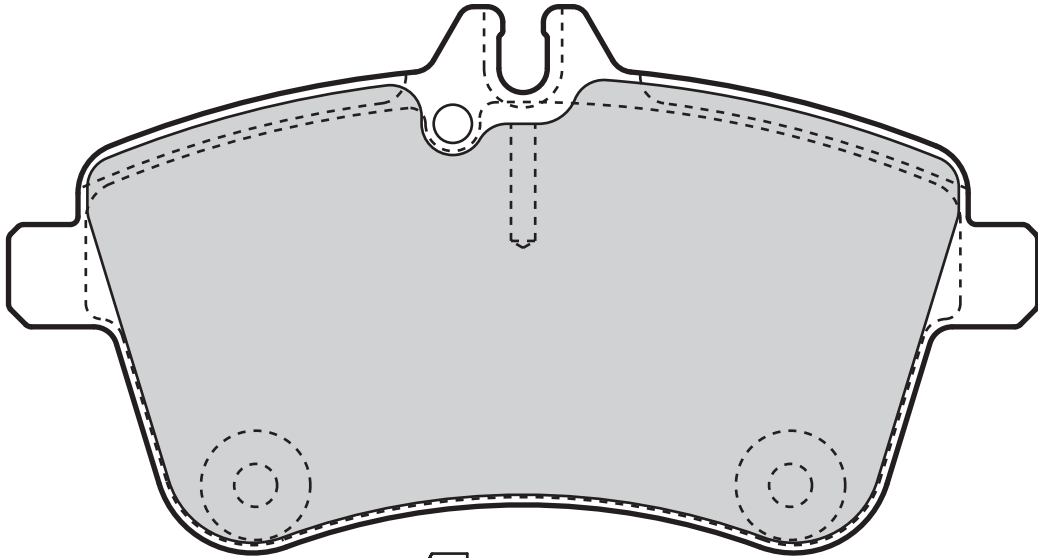

Valeo



Valeo



598795

2

95

131,6

70

20,1

LUCAS

MERCEDES

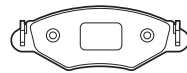

23885 (WVA)

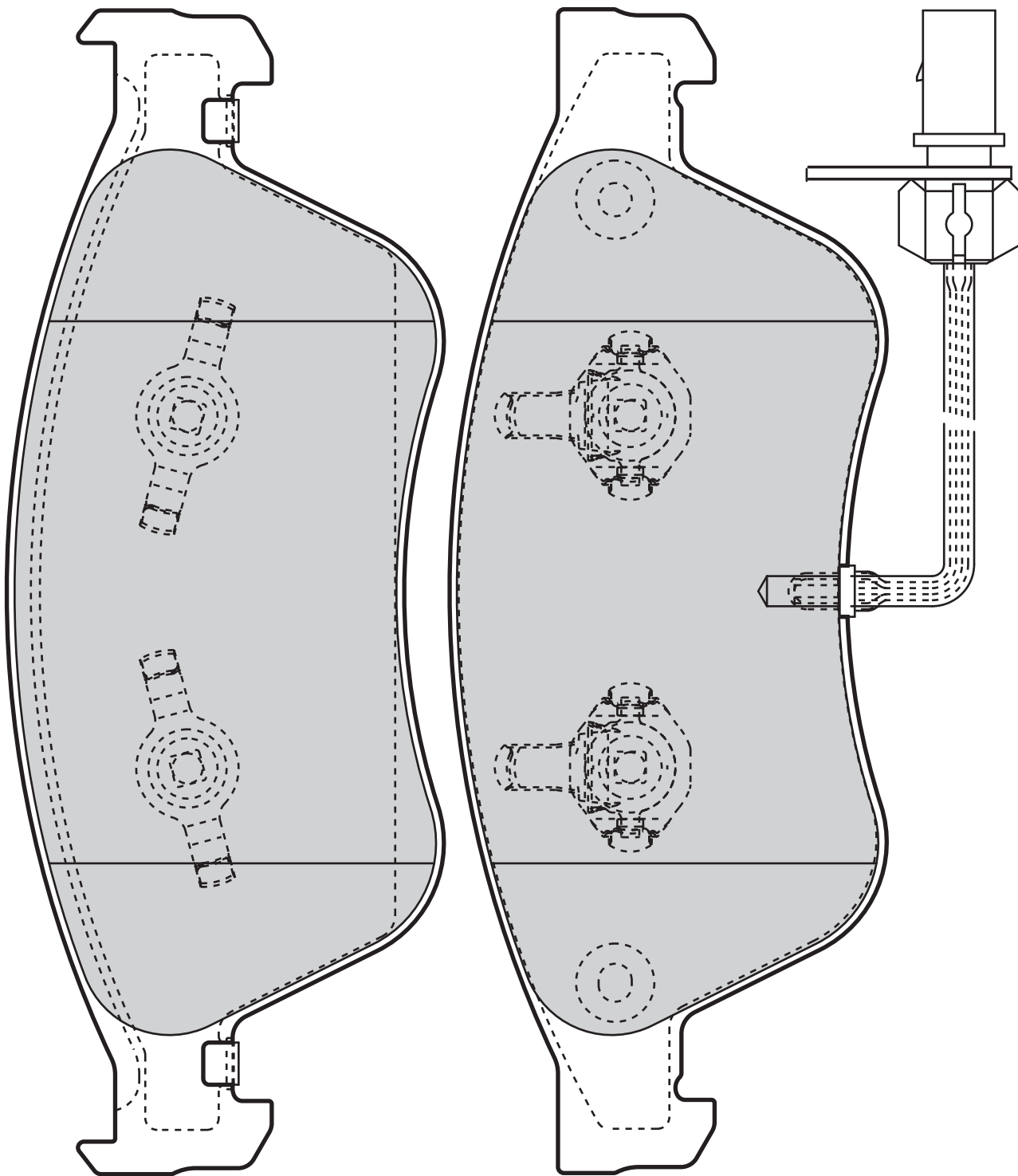

Valeo



Valeo



598845

2

240

193,2

72,6

20,3

TEVES

AUDI, VOLKSWAGEN



23891 (WVA)

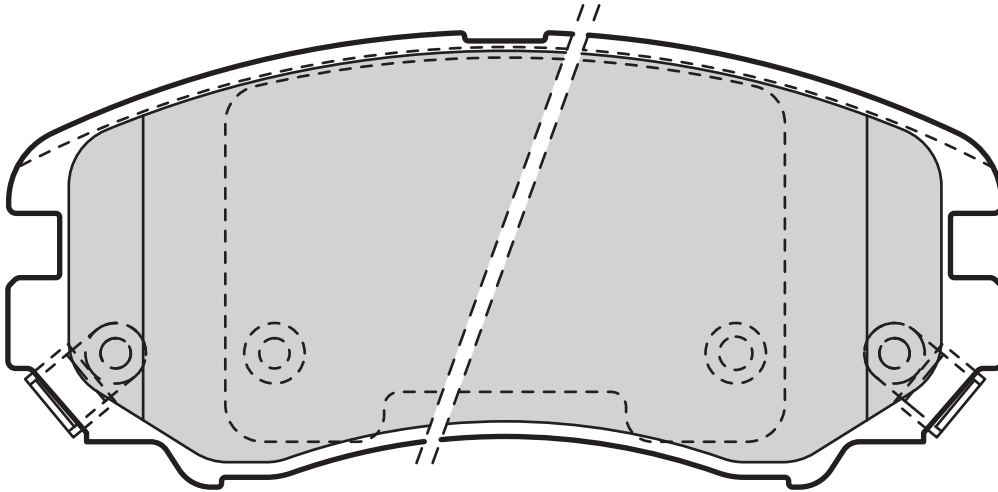

Valeo



2

Valeo



131,5



60,1



17,5



MANDO



HYUNDAI, KIA

598744

23914 (WVA)

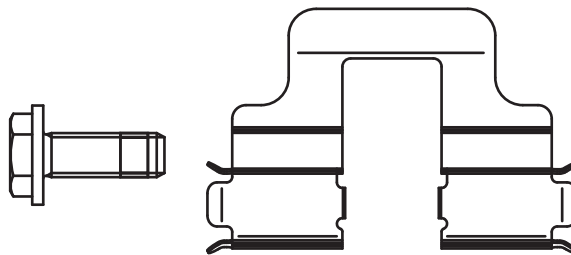
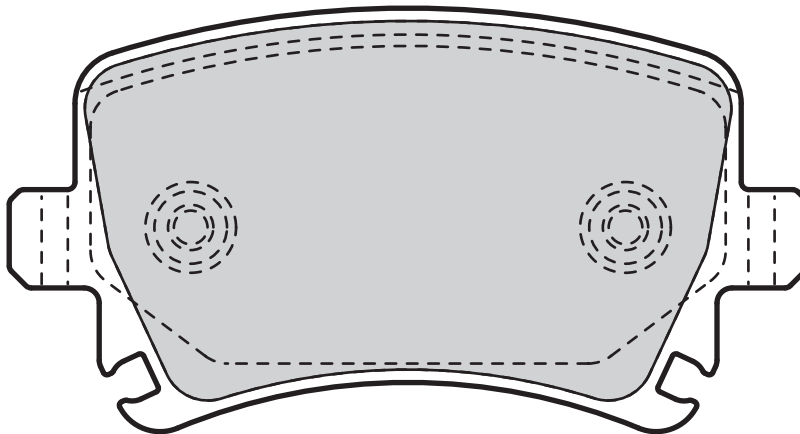

Valeo



0

Valeo



105,5



56



17



LUCAS



AUDI, SEAT, SKODA, VOLKSWAGEN

598752

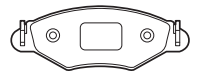

23915 (WVA)

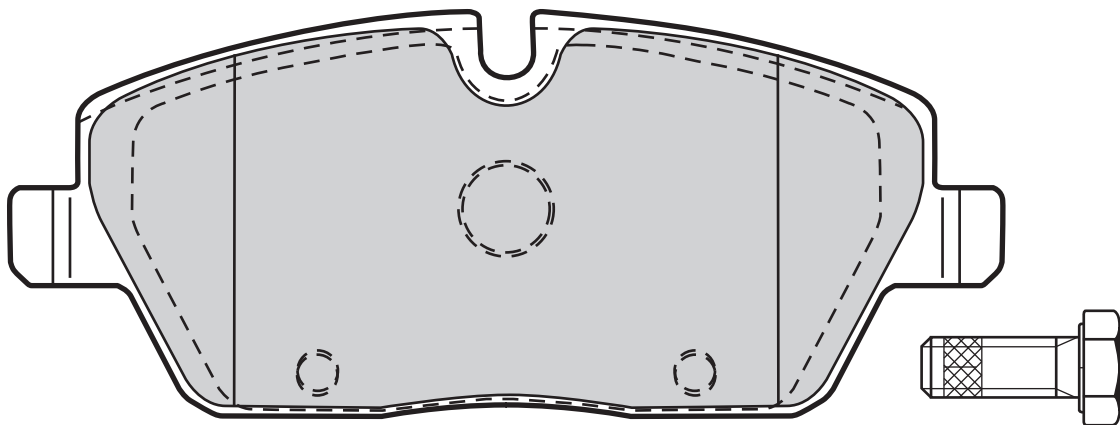
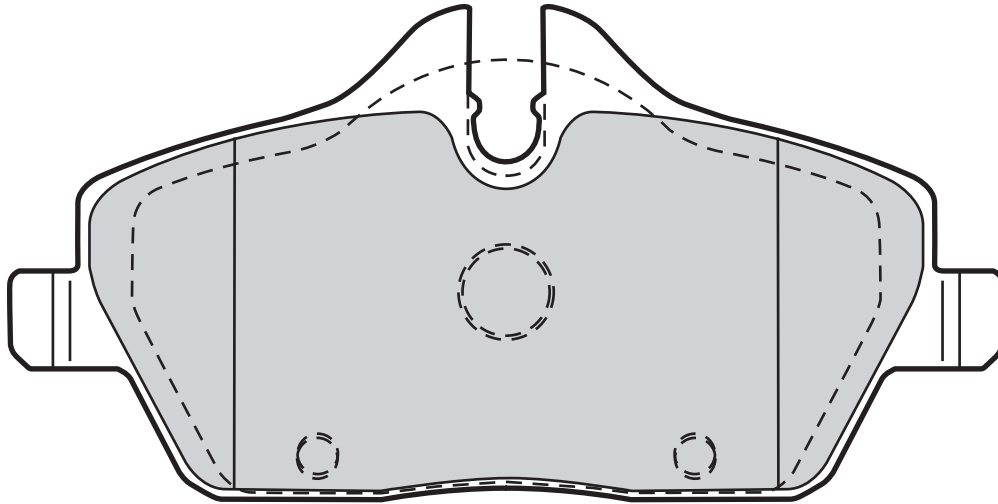

Valeo



Valeo



598699

0

131,2

65/53,2

17,9

LUCAS

BMW, MINI

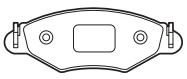

23918 (WVA)

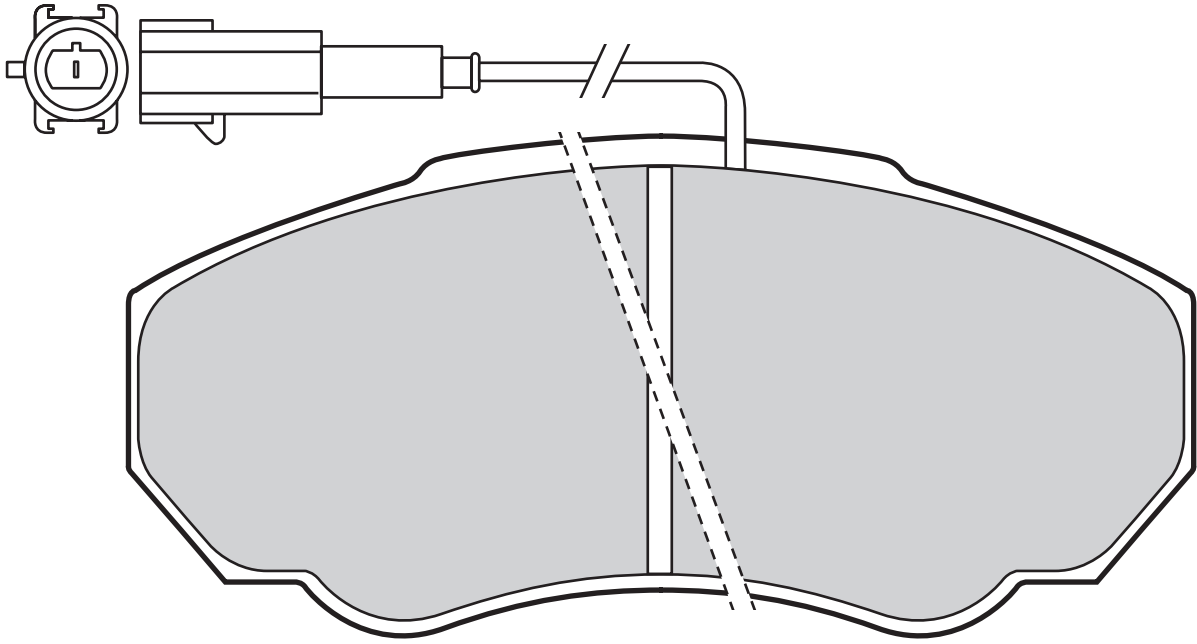

Valeo		Valeo								
598568	1	175	140,5	65,8	19	BREBBO	CITROËN, FIAT, PEUGEOT			

23919 (WVA)

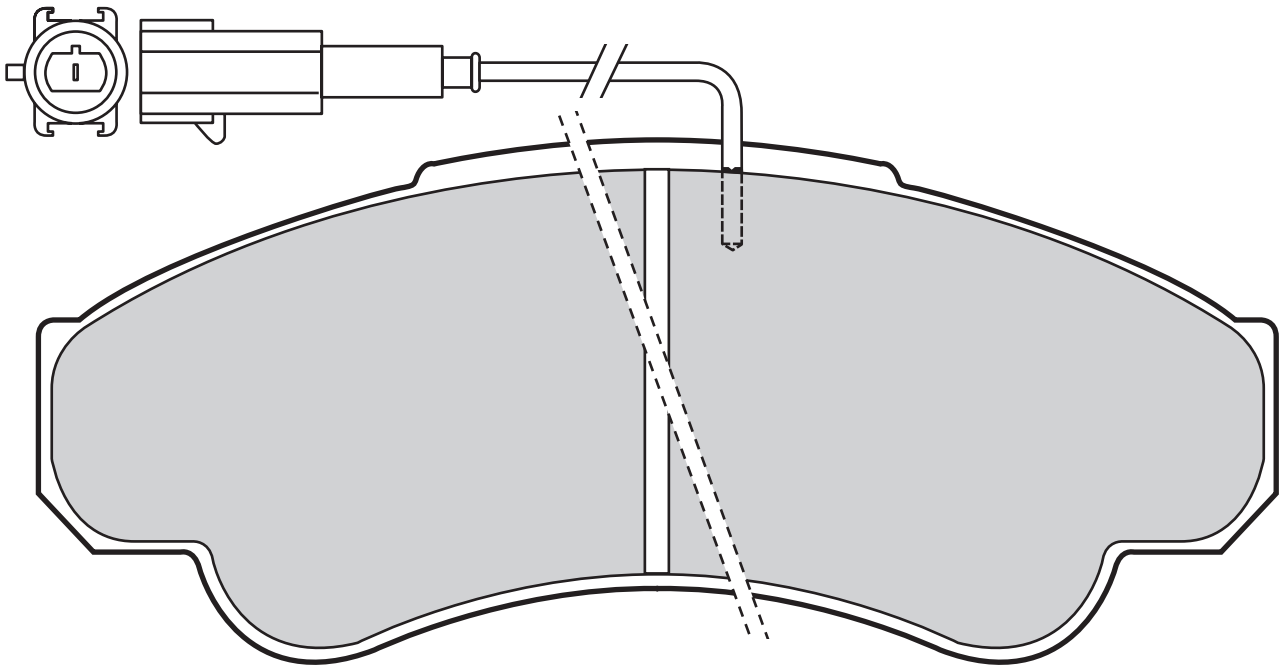



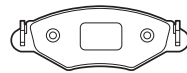



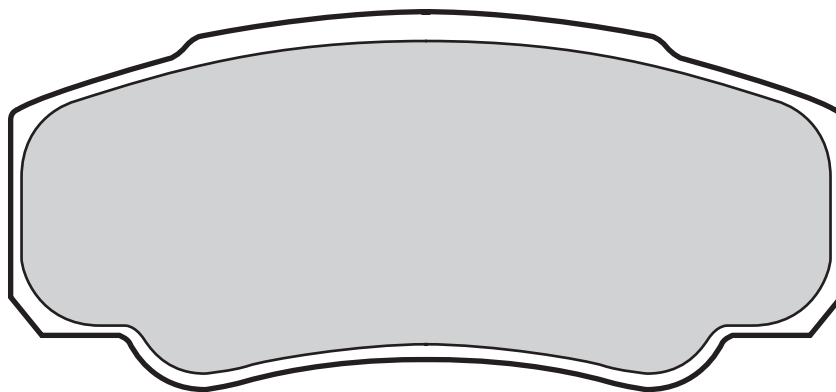

Valeo		Valeo								
598569	1	175	164,6	69,3	18,3	BREBBO	CITROËN, FIAT, PEUGEOT			



23921 (WVA)



Valeo								
541738	2	255	109,7	49,9	20	BREMBO	NISSAN	
598570	0		109,5	49,8	20	BREMBO	CITROËN, FIAT, PEUGEOT	

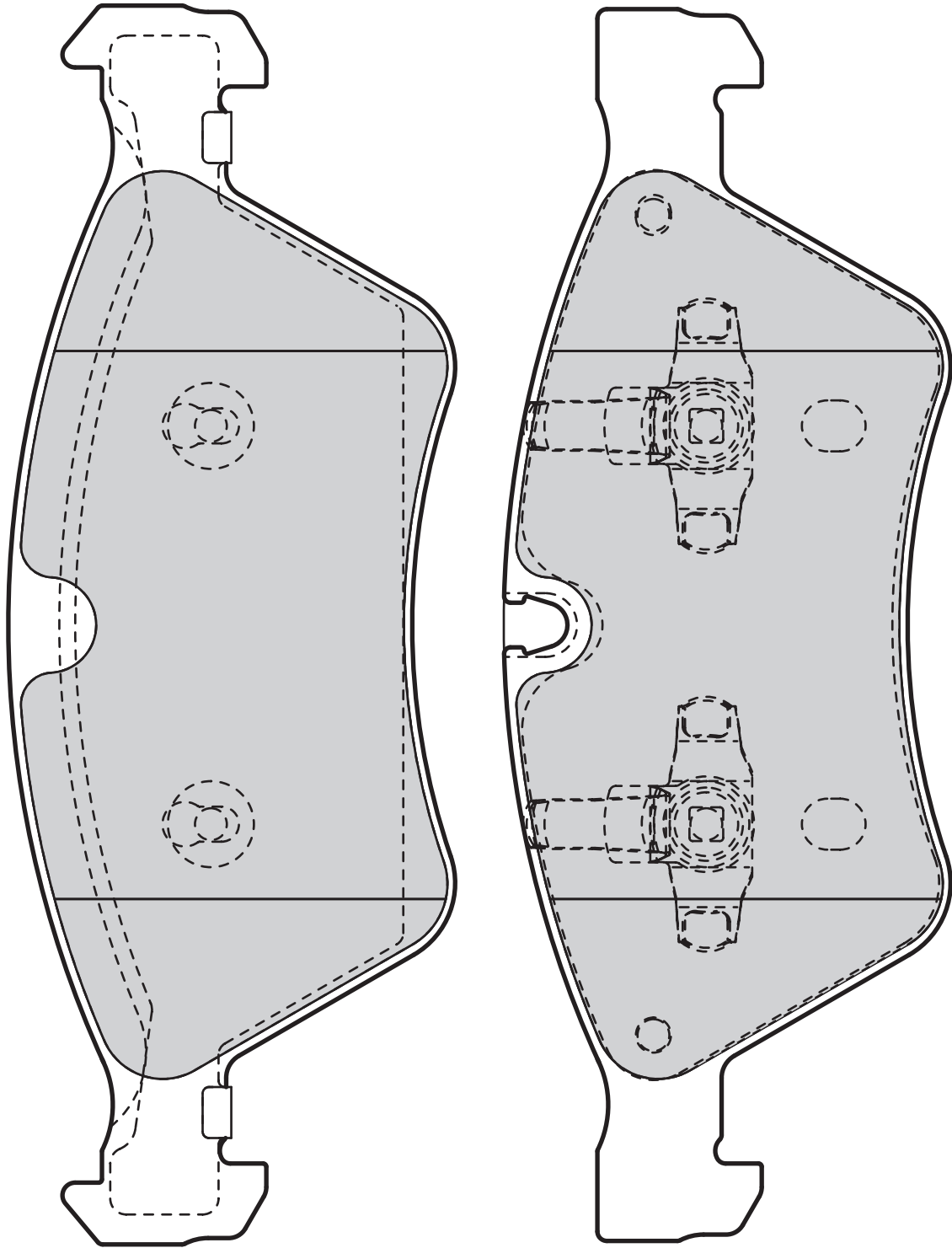
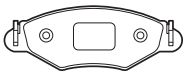

598728

0

193,3

70

20,3

TEVES

MERCEDES



23923 (WVA)

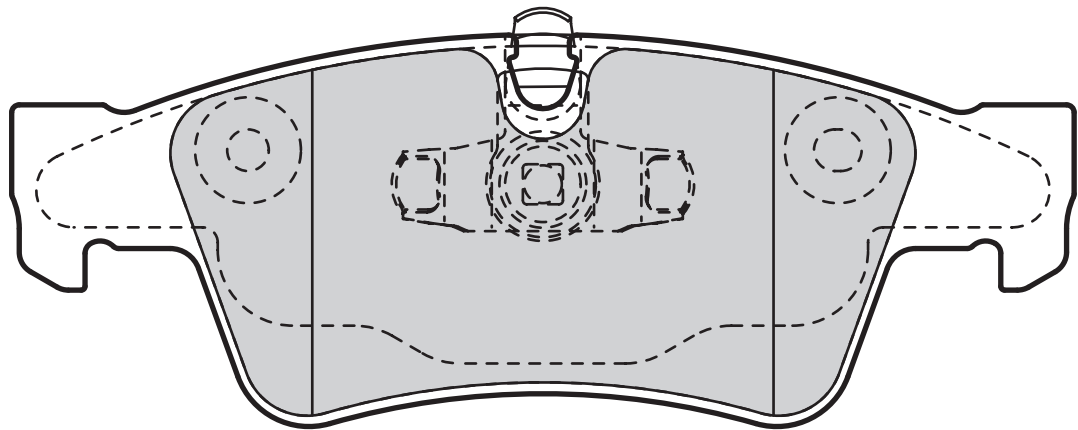
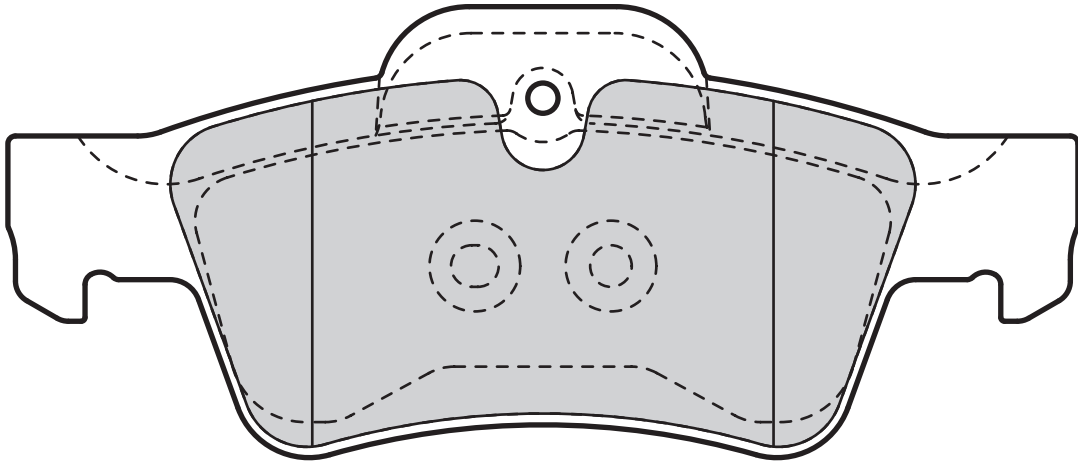

Valeo



Valeo



598802

0

140,2

52

17,9

TEVES

MERCEDES



23926 (WVA)

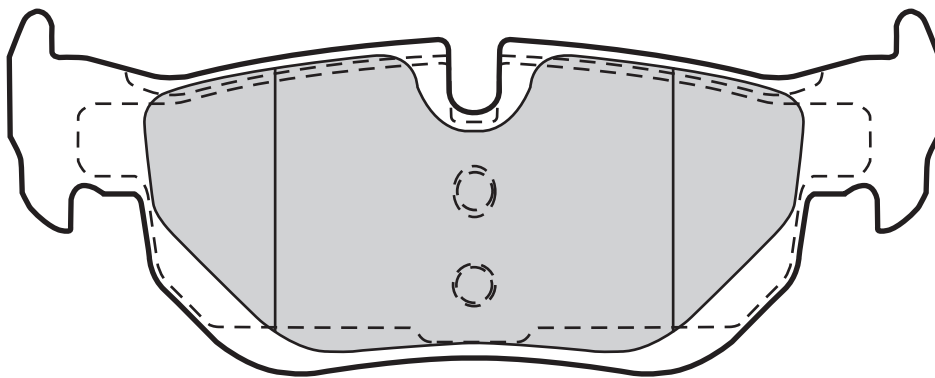
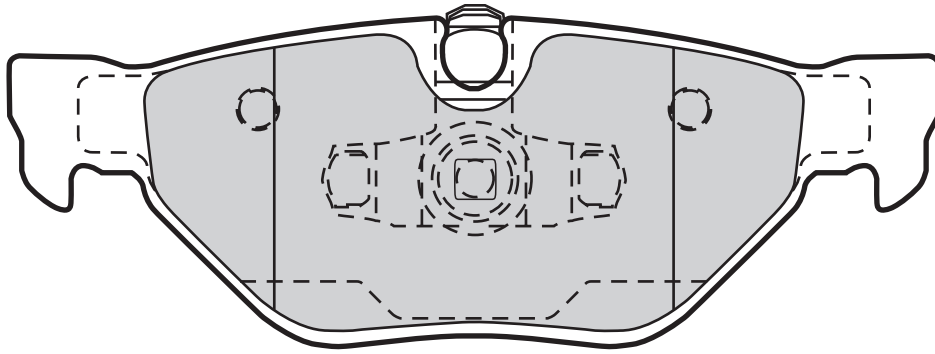

598703	0	123	44,5	17,3	TEVES	BMW					

23930 (WVA)

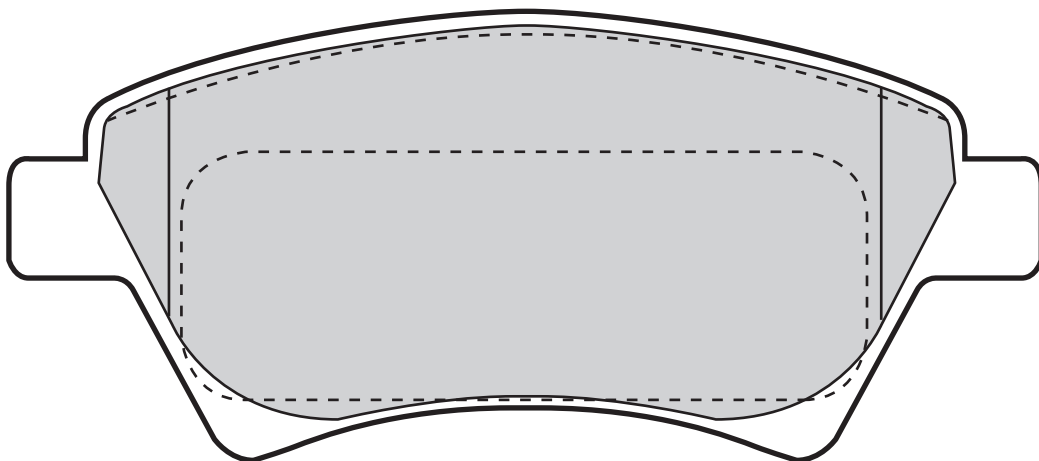

598558	0	136,8	59,5	18,3	BOSCH	RENAULT					

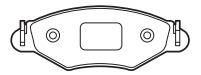

23934 (WVA)

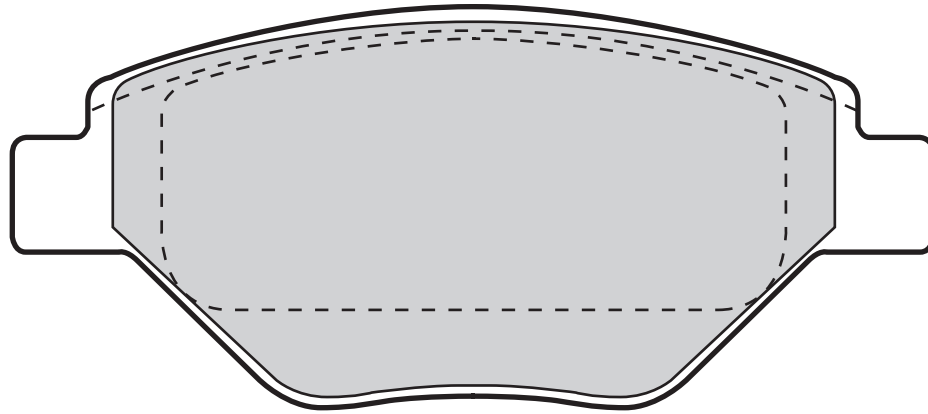

Valeo



Valeo



598557

0

122,8

54,3

18,3

BOSCH

RENAULT

23935 (WVA)

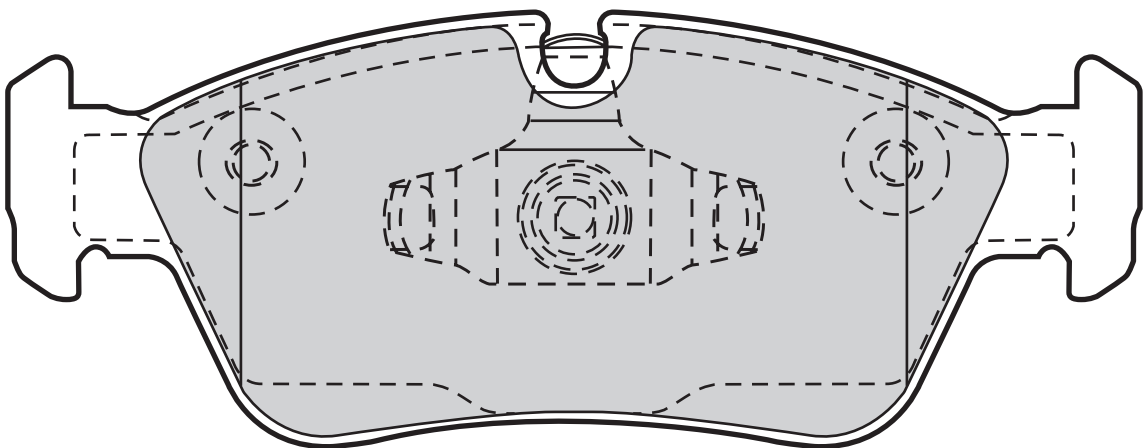
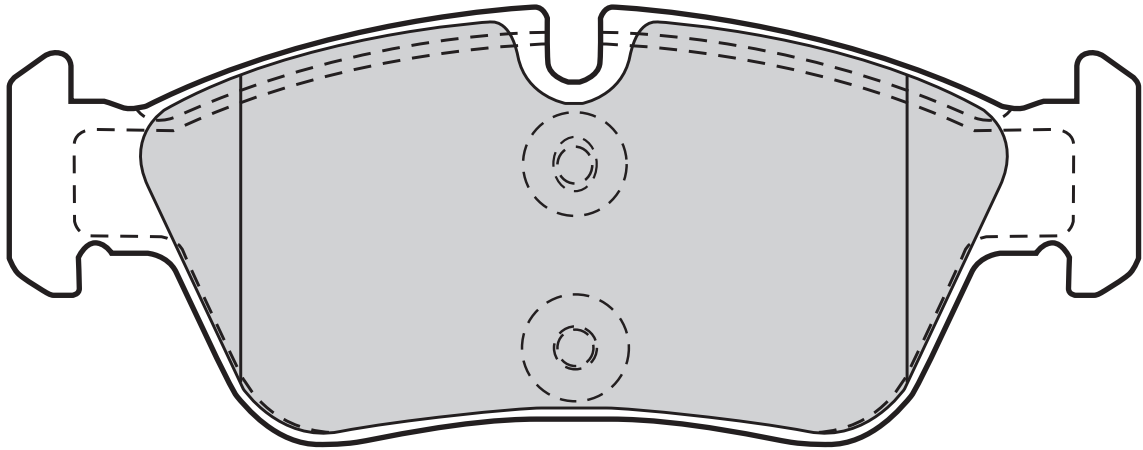

Valeo



Valeo



598700

0

149,4

57,5

17,8

TEVES

BMW

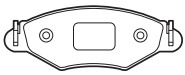

Valeo

23945 (WVA)

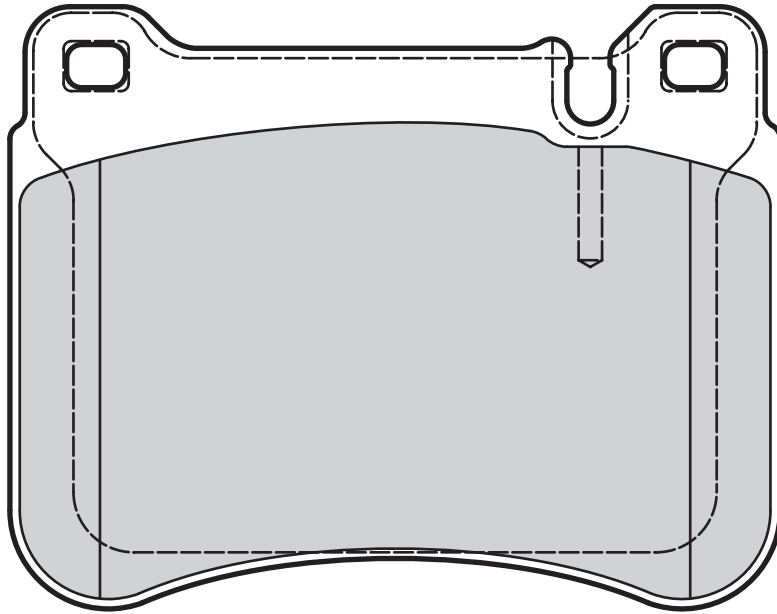

Valeo



Valeo



601034

0

101,8

79,6

16,5

TEVES

MERCEDES

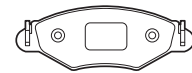

23951 (WVA)

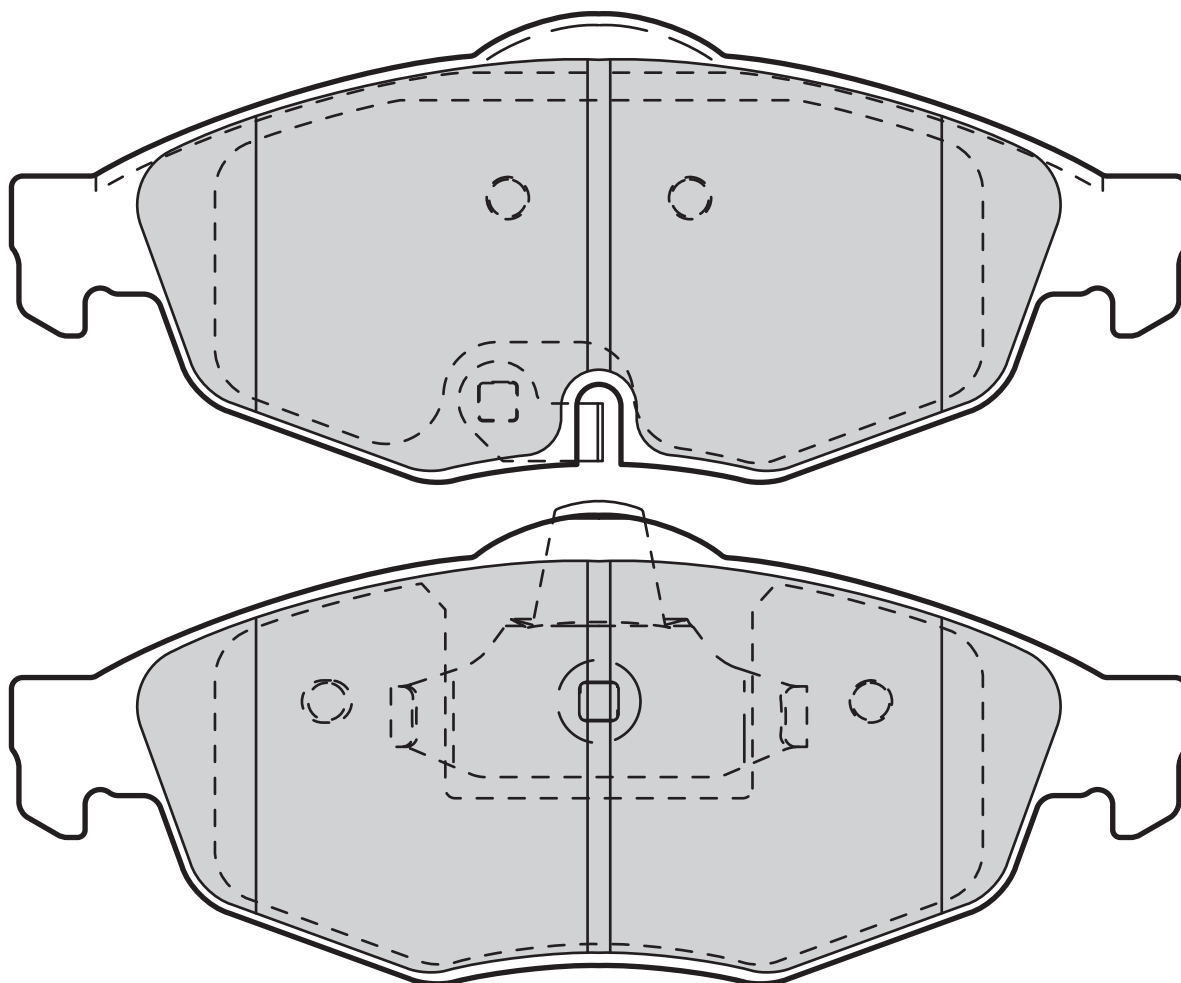

Valeo



Valeo



598905

0

155,5

62

20,5

TEVES

CHRYSLER

23959 (WVA)

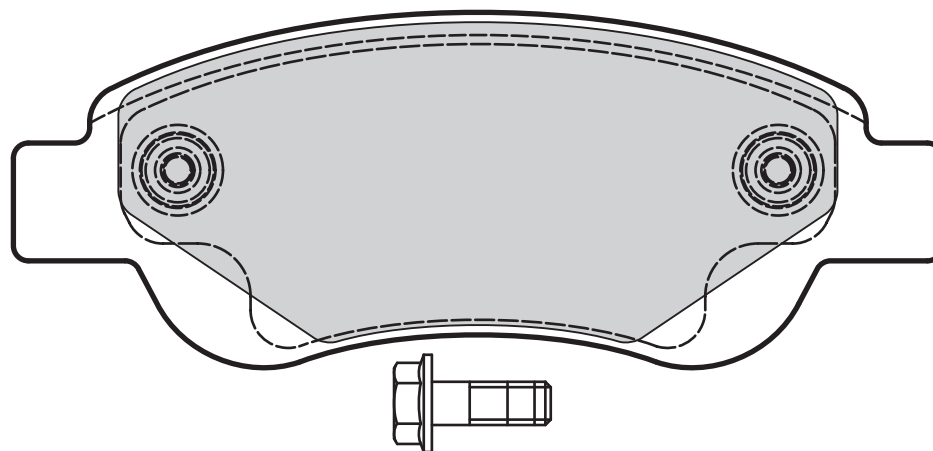

Valeo



Valeo



598718

0

122,7

46,7

17,6

BOSCH

CITROËN, PEUGEOT, TOYOTA



Valeo

23960 (WVA)

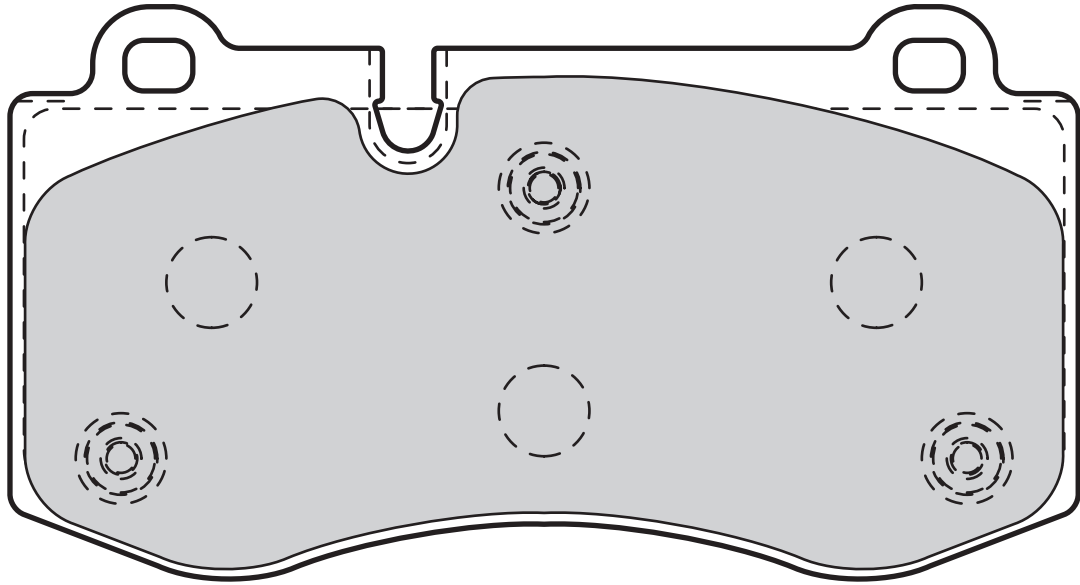

Valeo



0

Valeo



141,4

75,8



17,8



BREMBO



MERCEDES

598995

23961 (WVA)

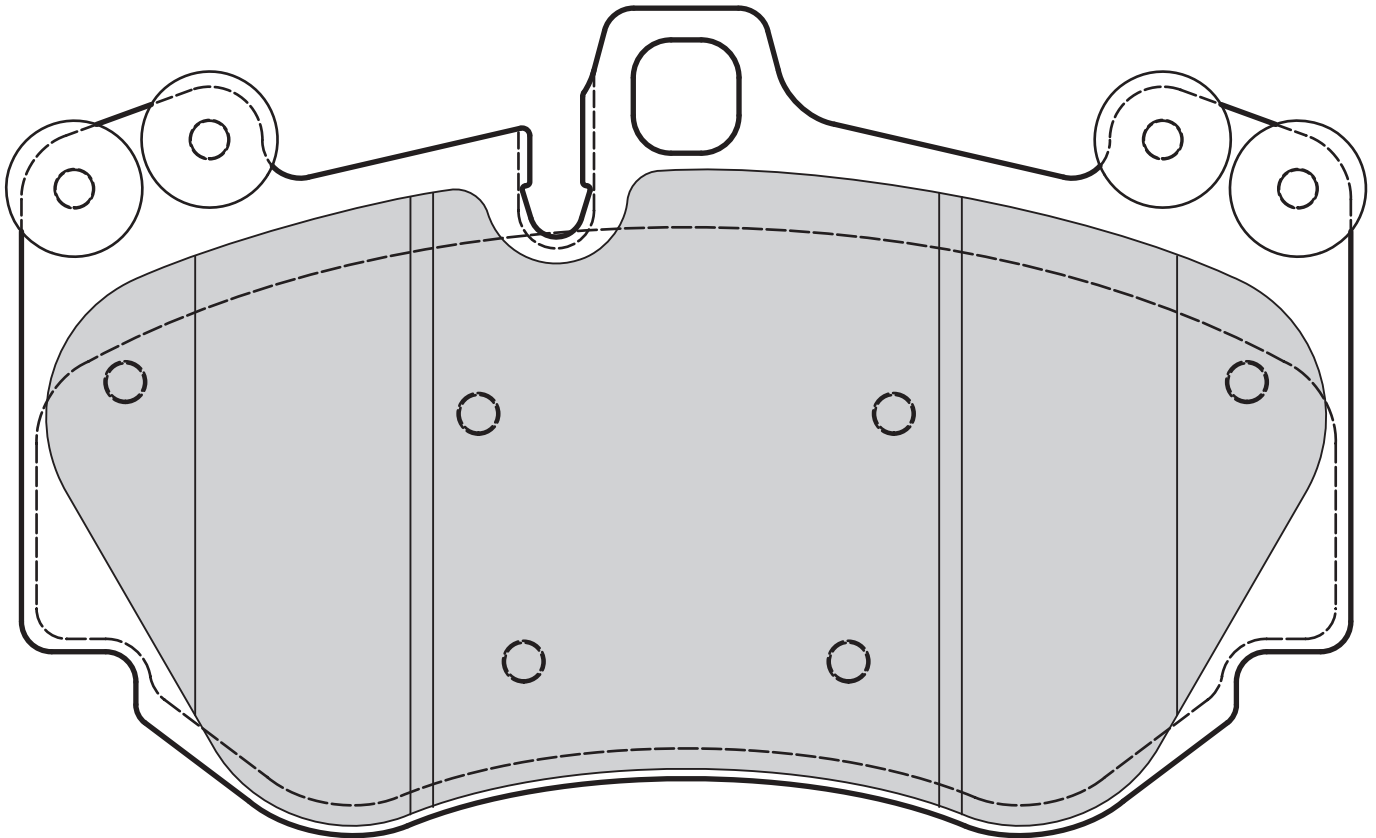

Valeo



598709

Valeo



176

109,5



16,8



BREMBO



PORSCHE

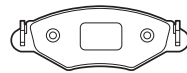

23966 (WVA)

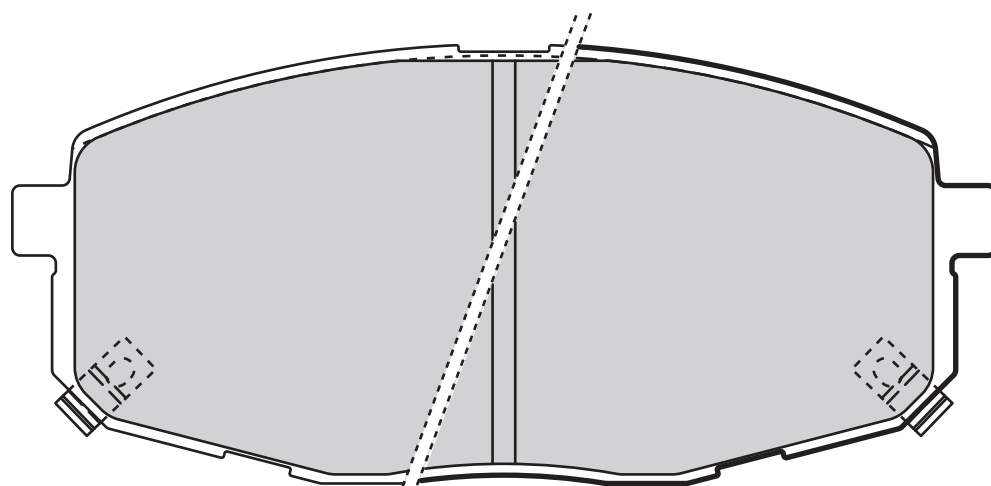
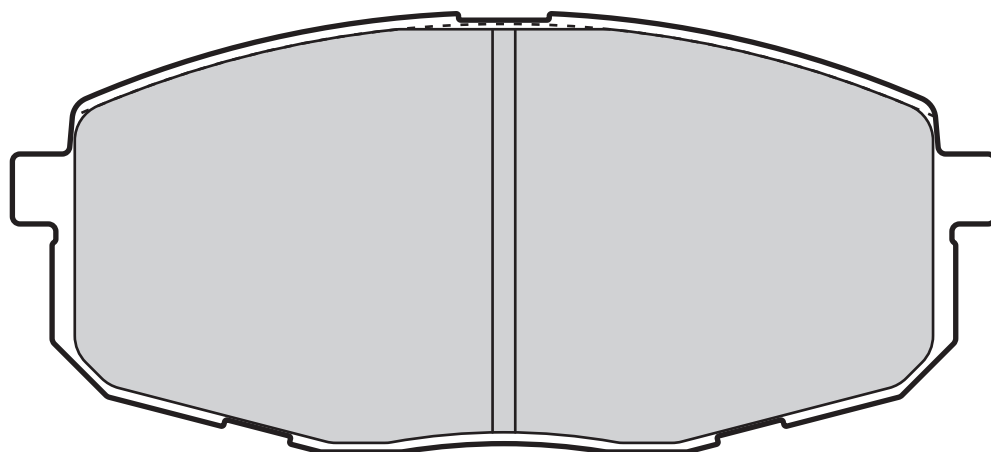

Valeo



Valeo



598842

2

130

58

16,7

MANDO

HYUNDAI, KIA

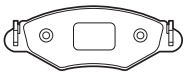

Valeo

23970 (WVA)

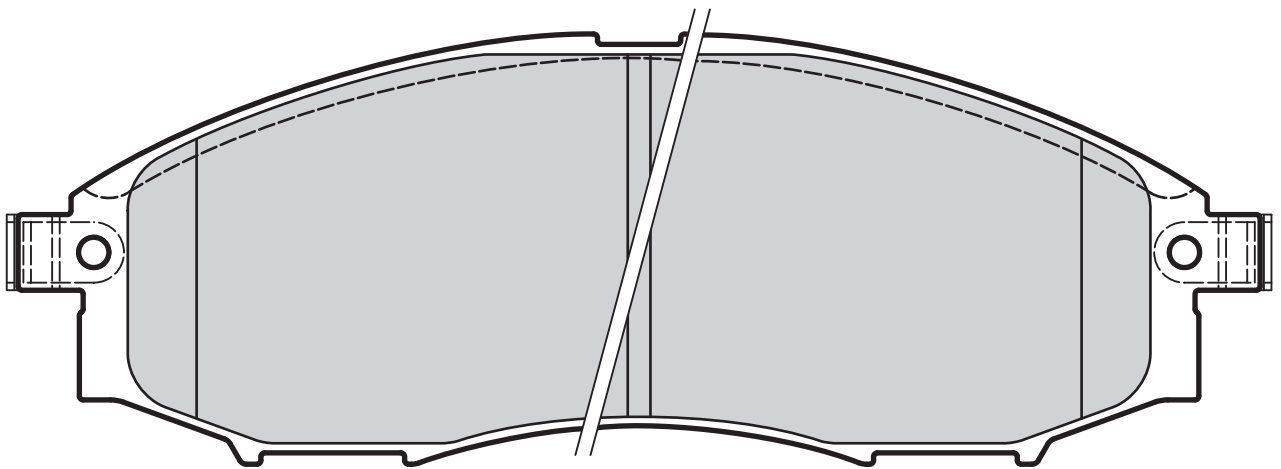
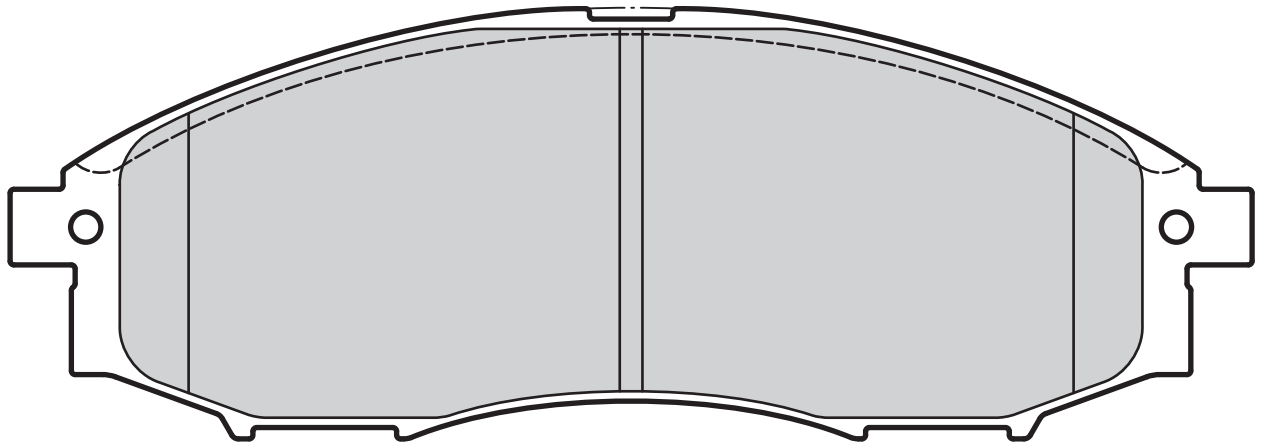

Valeo



Valeo



Leaf



164



57



16,9



AKEBONO



NISSAN

598889

2

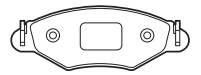

23973 (WVA)

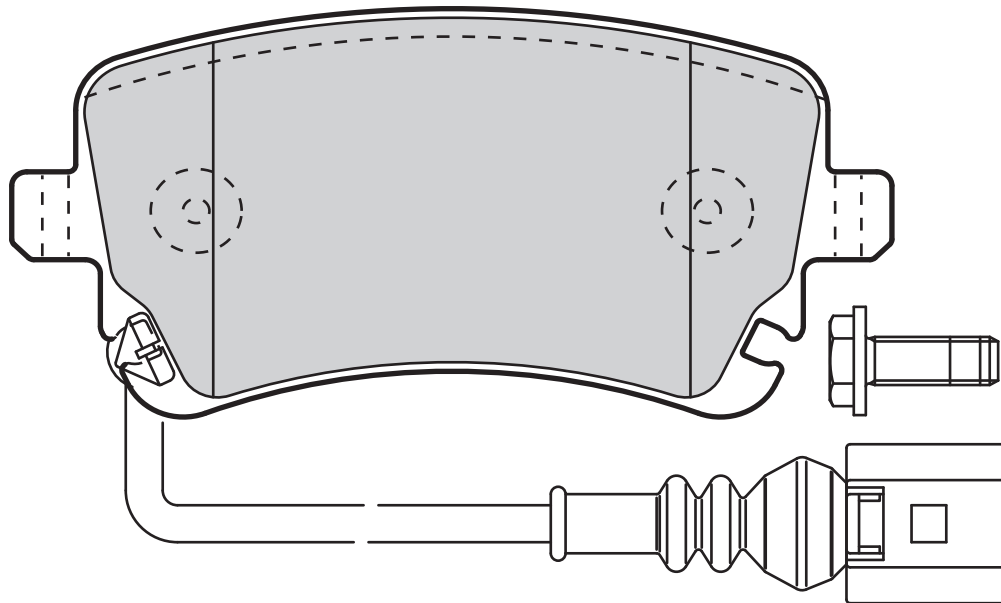

Valeo							
598641	0	116,4	52,5	17,3	LUCAS	DACIA, NISSAN, RENAULT	
598847	1	116,2	52,1	17,3	LUCAS	OPEL, SUZUKI, VAUXHALL	

23974 (WVA)

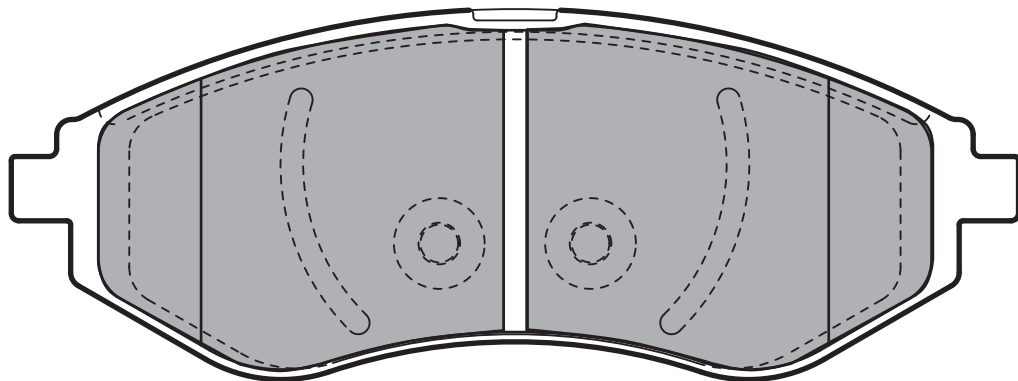

Valeo							
598644	0	133	49	17,8	AKEBONO	CHEVROLET, DAEWOO	



23982 (WVA)

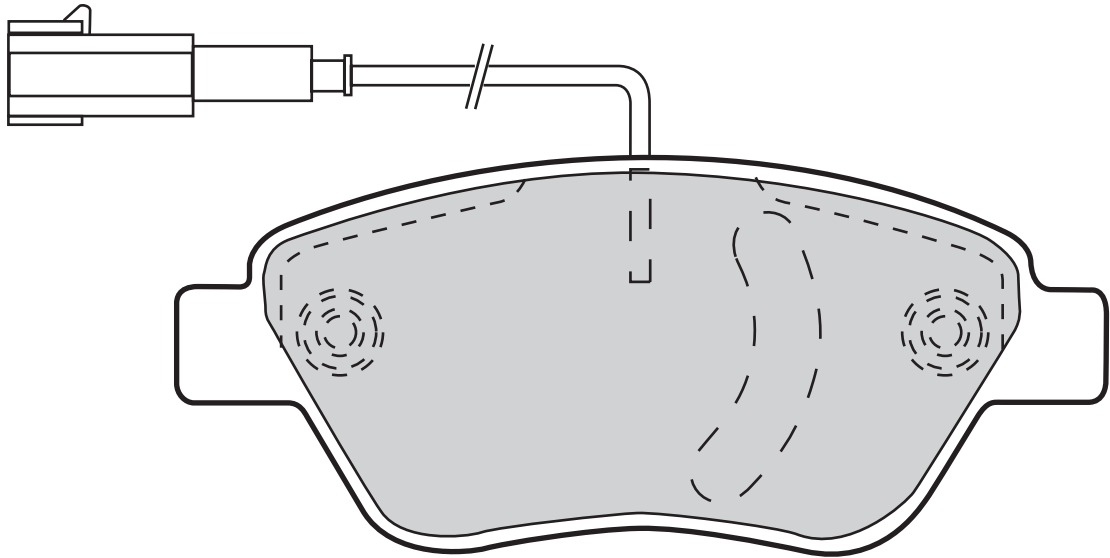

598825	1	122,8	53,2	17,8	BOSCH	OPEL, VAUXHALL

23983 (WVA)

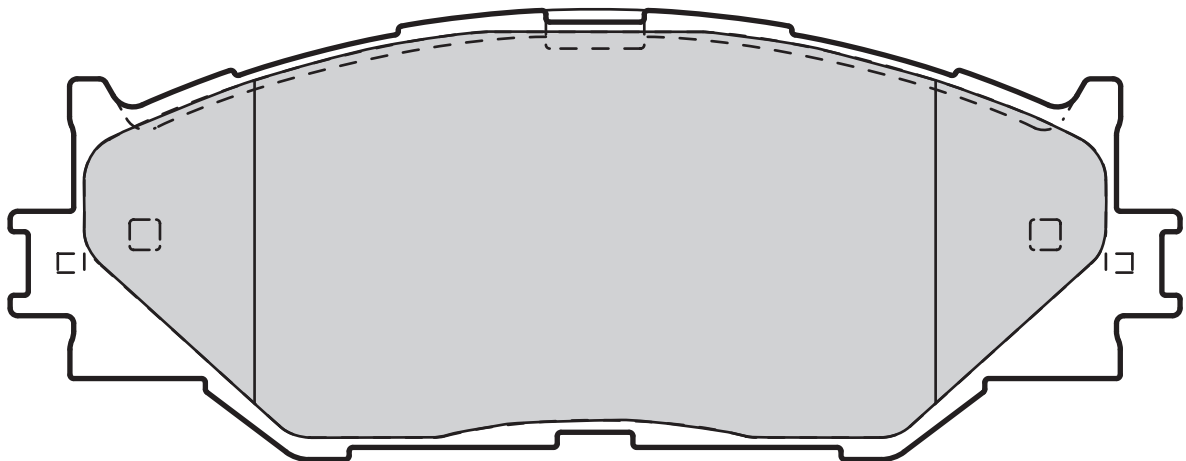

601035	0	154,6	59,5	17,7	SUMITOMO	LEXUS

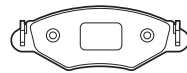

23984 (WVA)

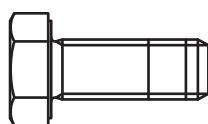
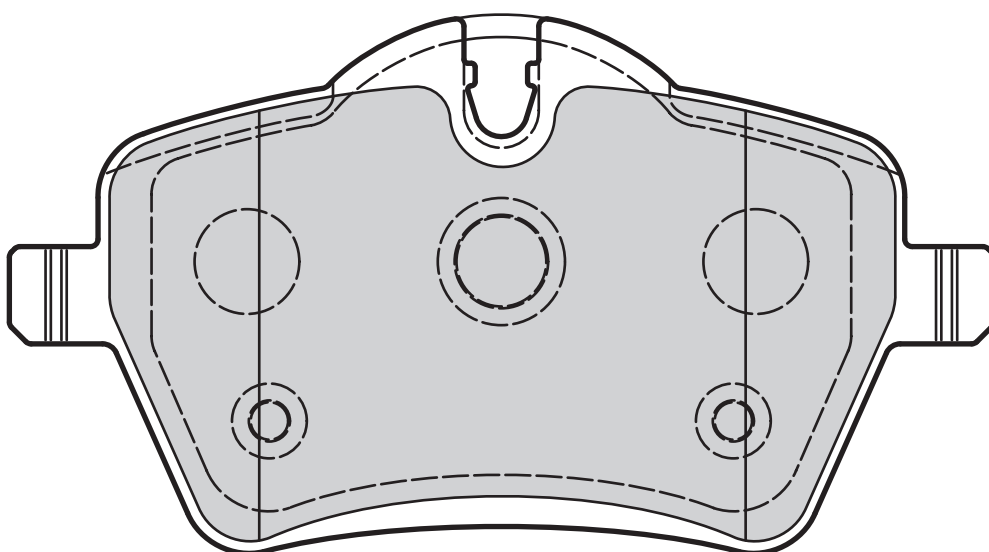
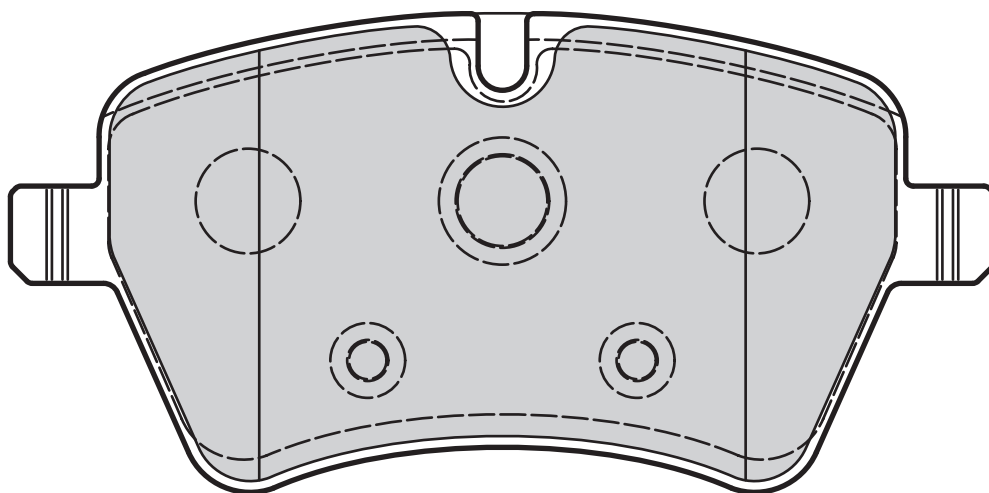

Valeo



Valeo



598925

2

Leaf

131,5

64/71,4

17,9

LUCAS

MINI



23993 (WVA)

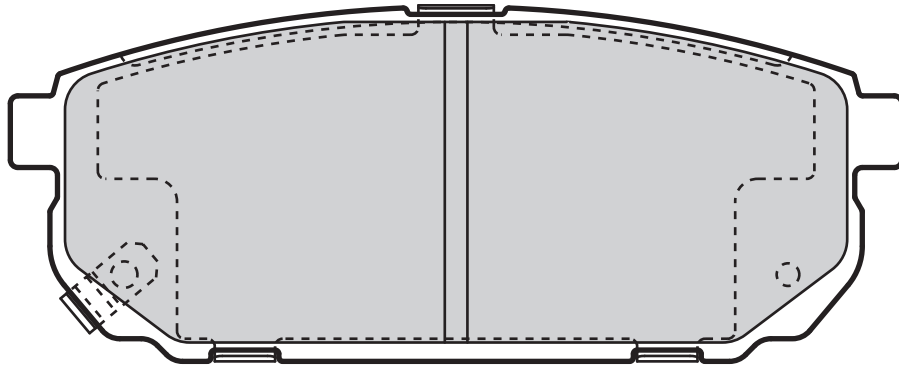

598823

2

117,9

46,9

15,8

SUMITOMO

KIA

23996 (WVA)

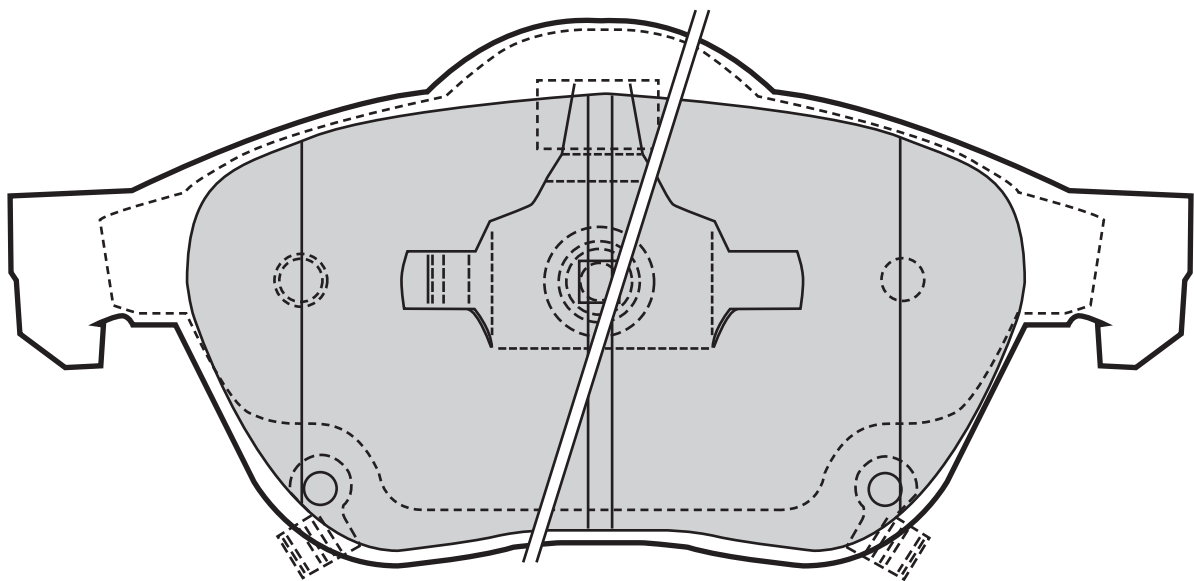
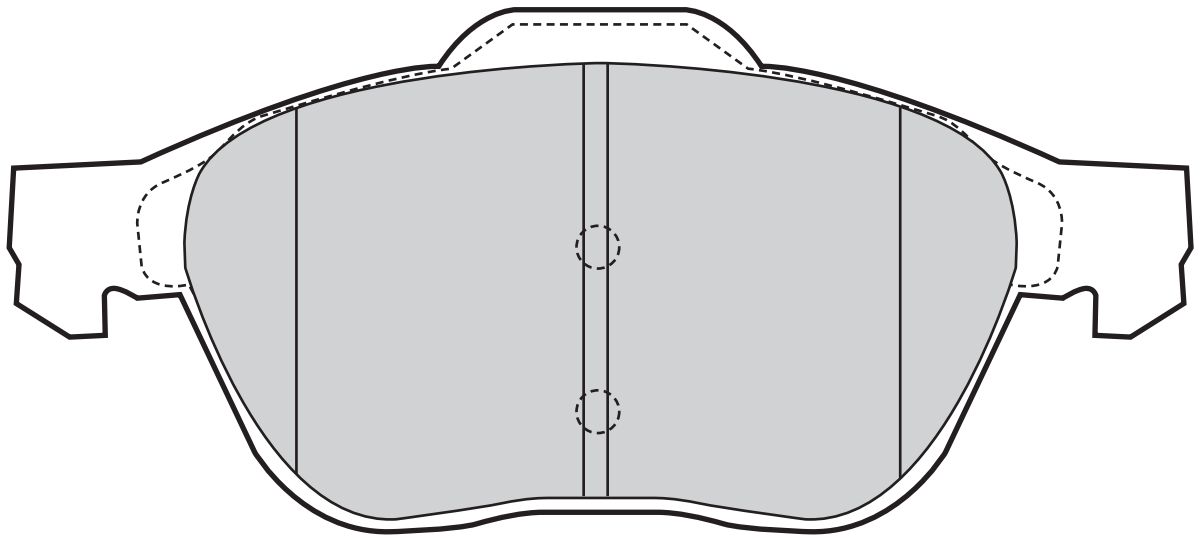

598653

2

156,4

71/68,5

18,3

TEVES

TOYOTA

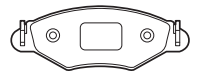

24007 (WVA)

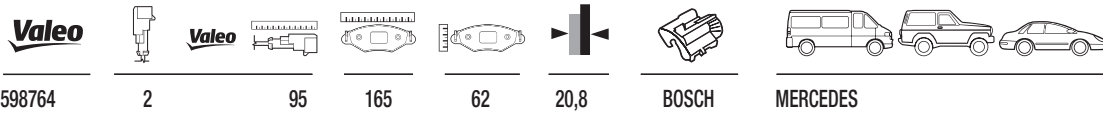
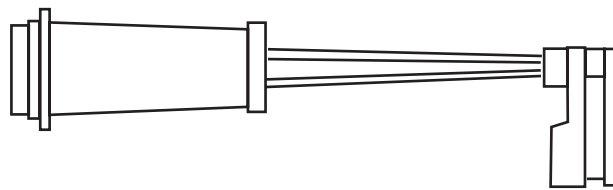
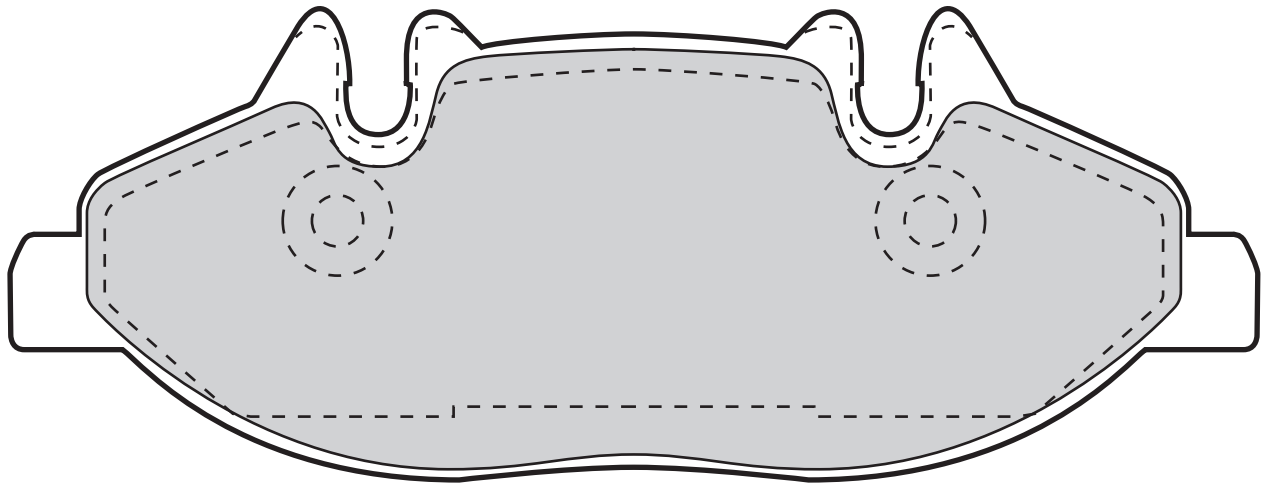

598764

2

95

165

62

20,8

BOSCH

MERCEDES

24008 (WVA)

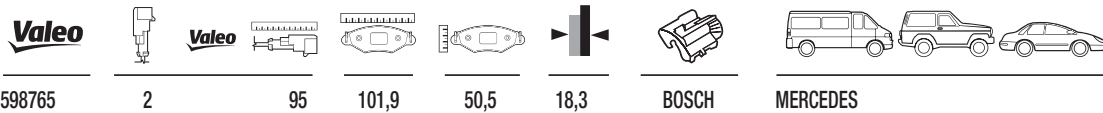
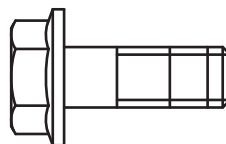
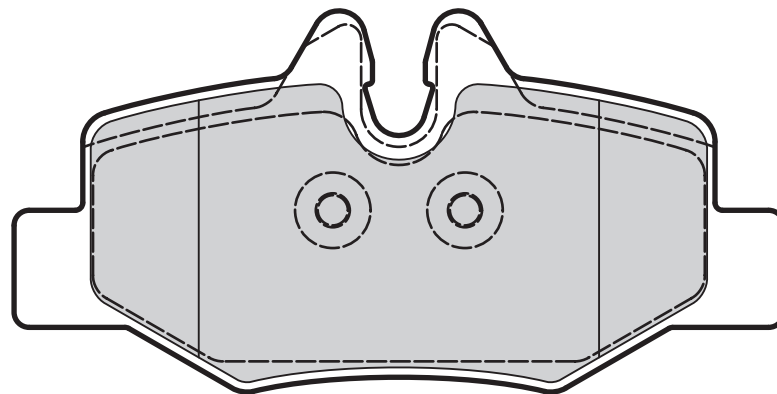

598765

2

95

101,9

50,5

18,3

BOSCH

MERCEDES

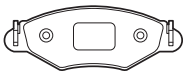

Valeo

24011 (WVA)

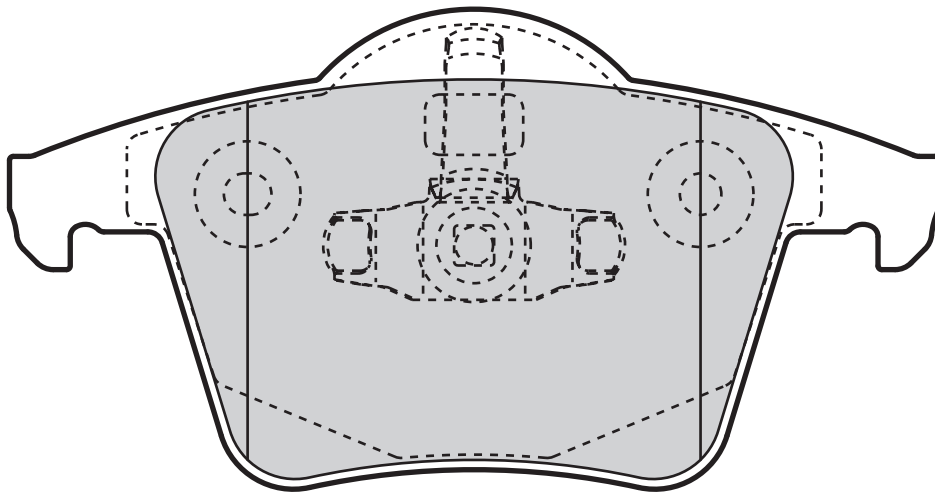
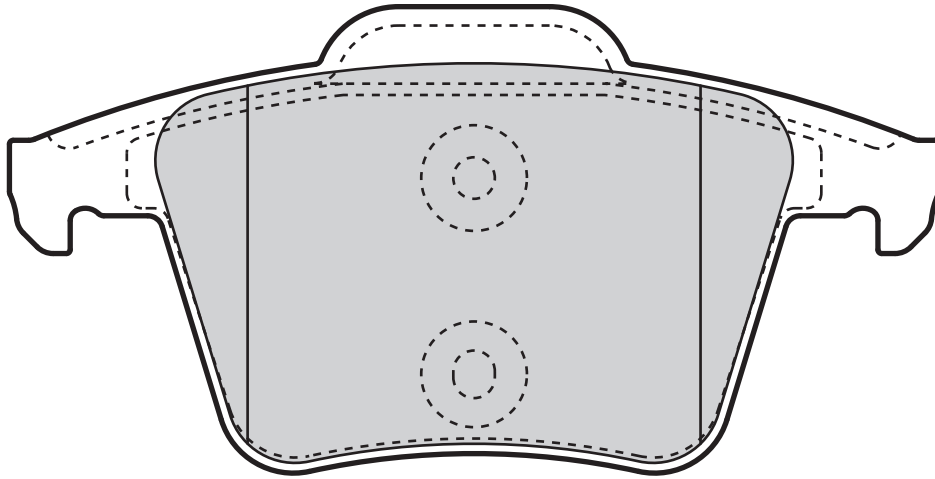

Valeo



Valeo



598829

0

122,9

61,7

18,7

TEVES

VOLVO

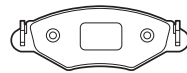

24013 (WVA)

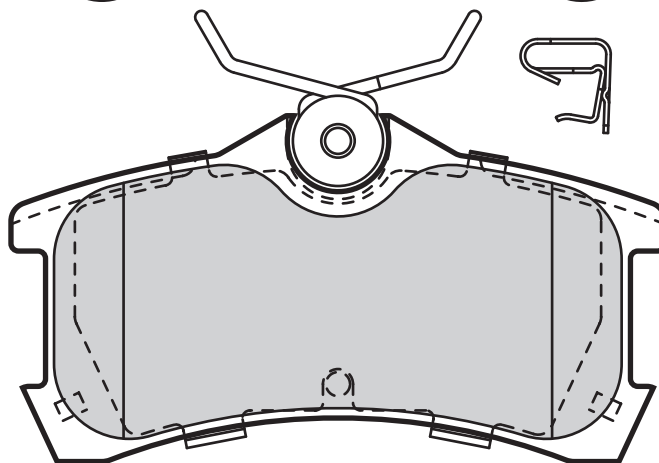
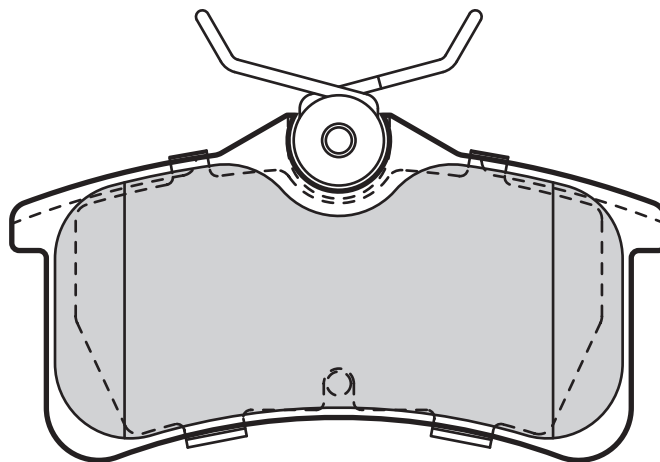

Valeo



Valeo



598810

2

87

46

15,5

LUCAS

TOYOTA



Valeo

24014 (WVA)

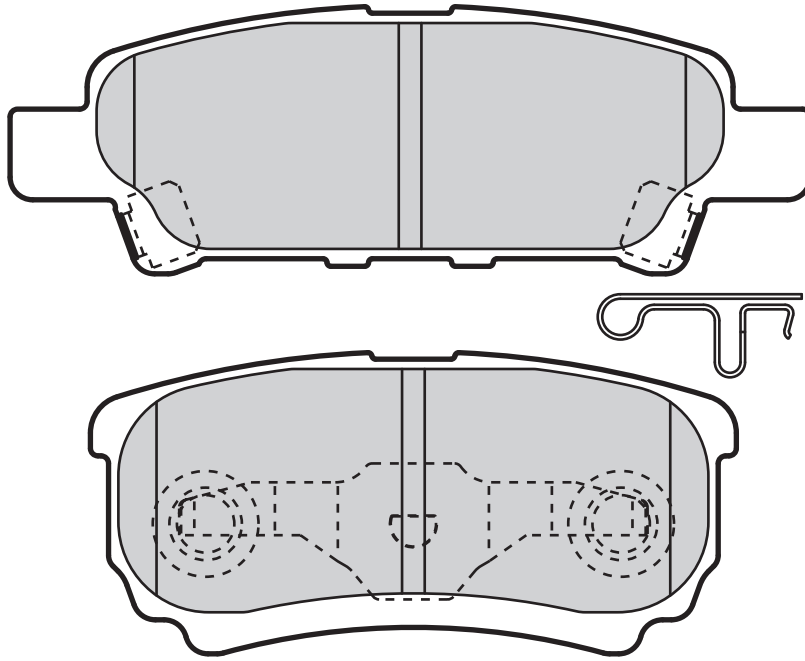

Valeo



Valeo



598852

2

85,4

35,5

15,4

AKEBONO

CITROËN, DODGE, MITSUBISHI, PEUGEOT

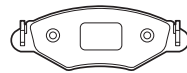

24022 (WVA)

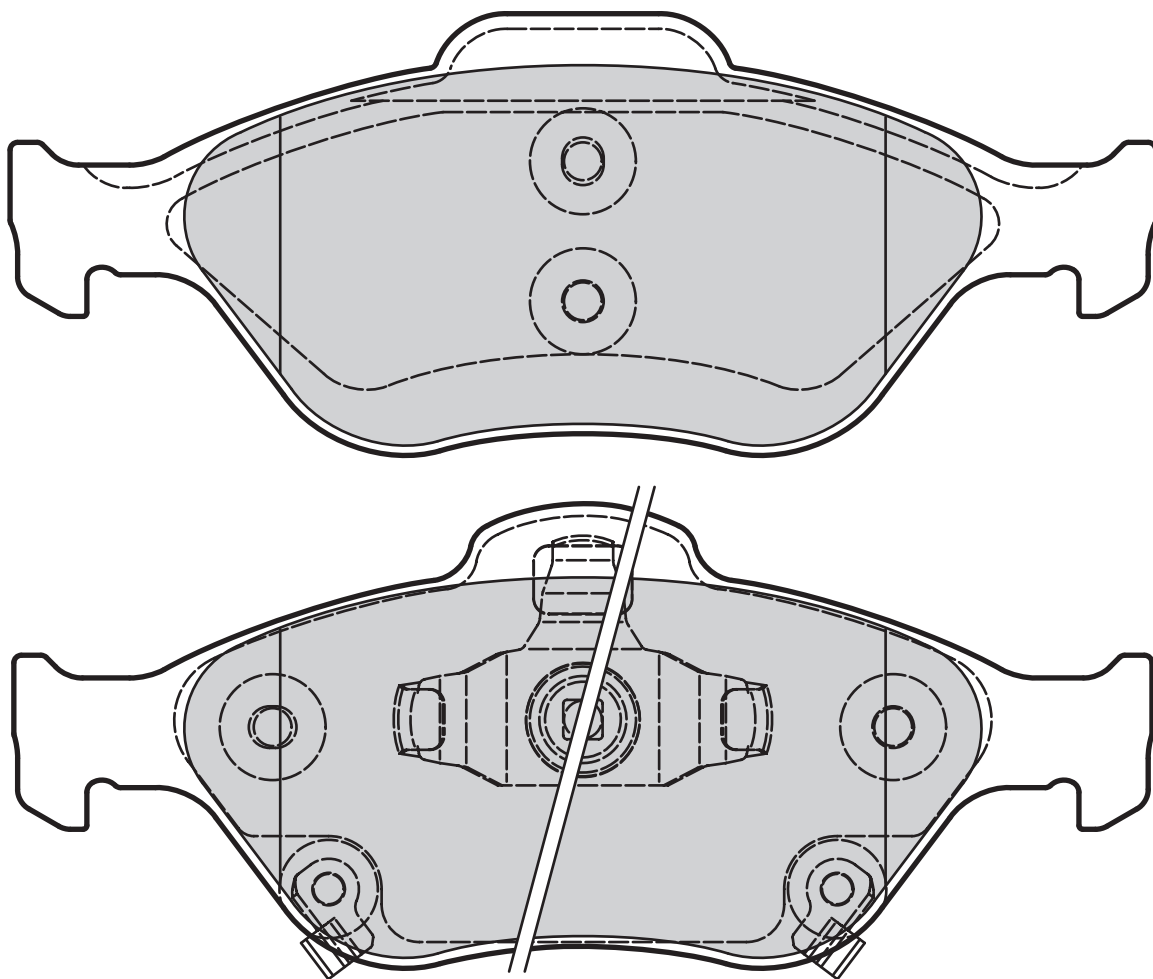

Leaf



151,4



58,3



17,5



TEVES



TOYOTA

601026

1



24024 (WVA)

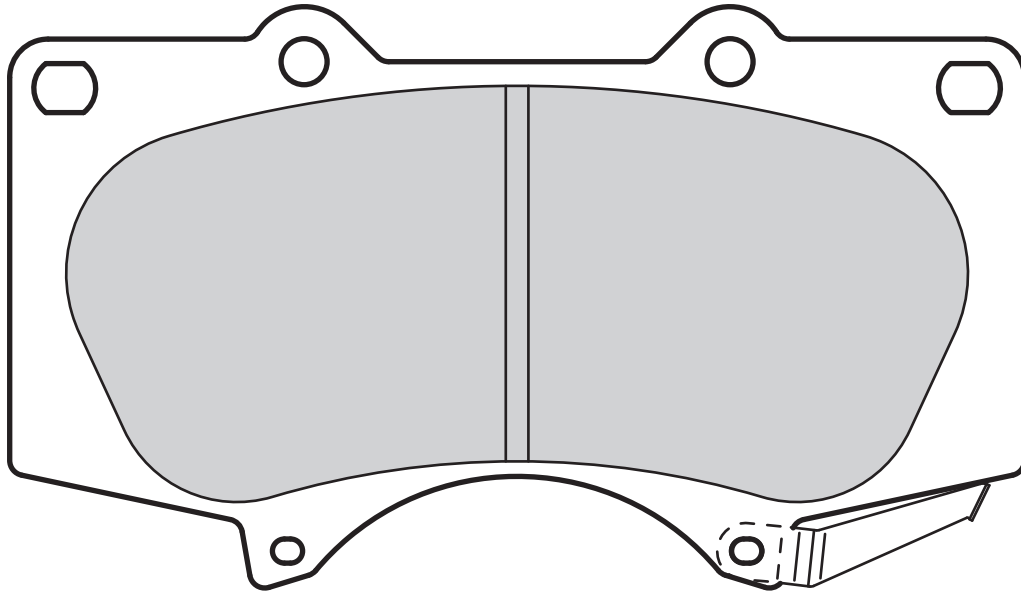

598857	2		134,2	76,9	17,8		SUMITOMO	TOYOTA

24029 (WVA)

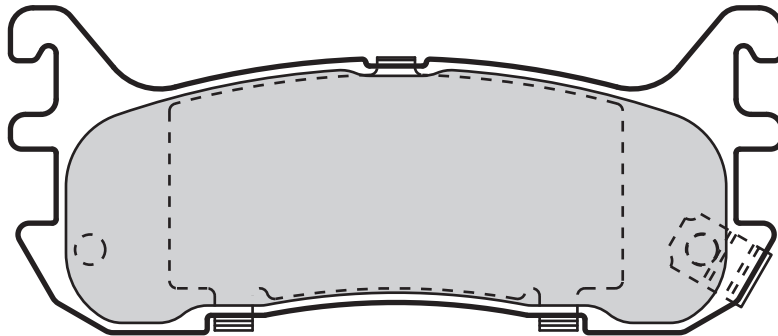

598835	2		102	42,6	12,5		AKEBONO	MAZDA



24031 (WVA)

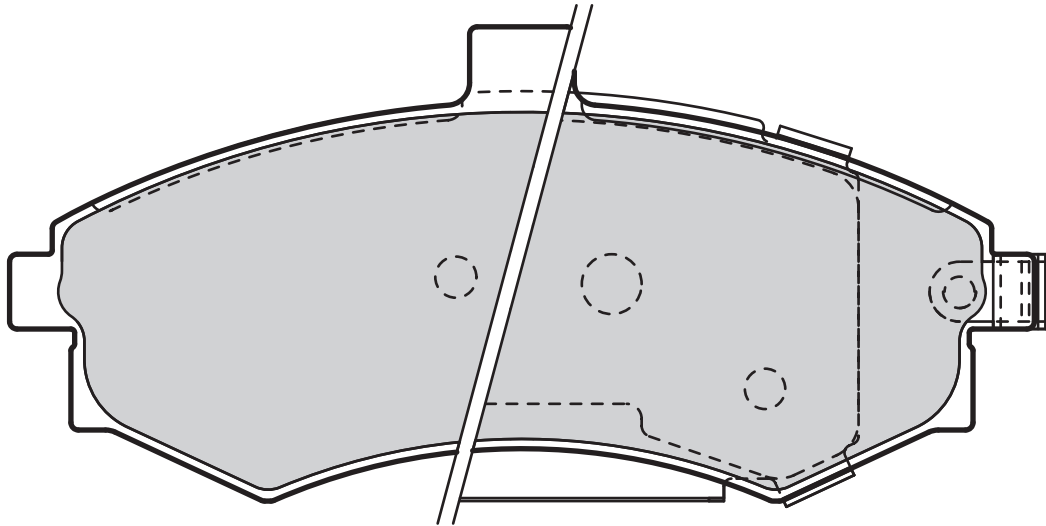

Valeo



Valeo



598781

2

136,7

63,5

17,6

MANDO

HYUNDAI

24036 (WVA)

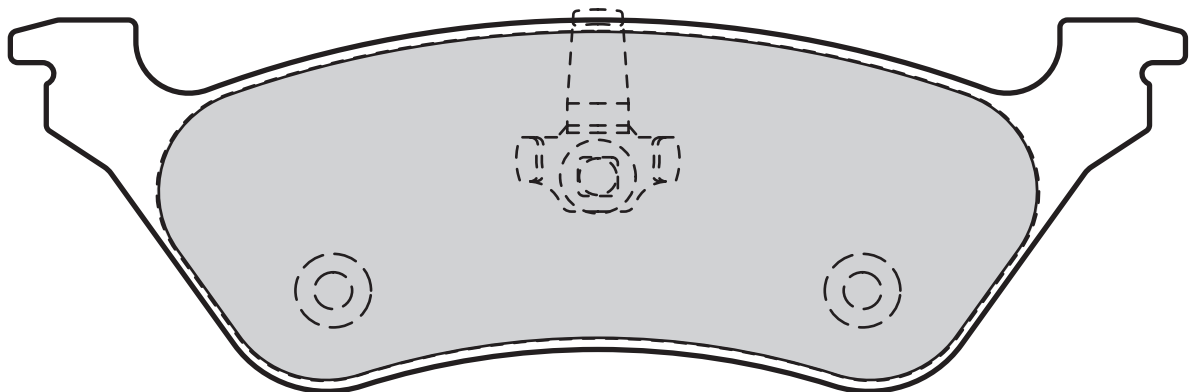

Valeo



Valeo



598755

155,4

50,5

17

KELSEY

CHRYSLER, JEEP

24039 (WVA)

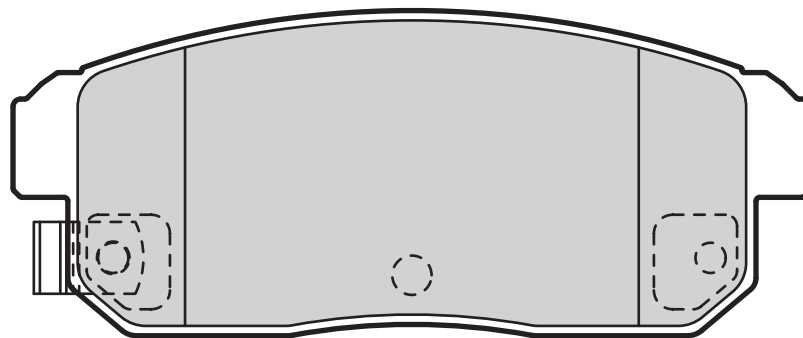

Valeo



Valeo



598831

1

105,5

43

15

AKEBONO

MAZDA, SUZUKI



24045 (WVA)

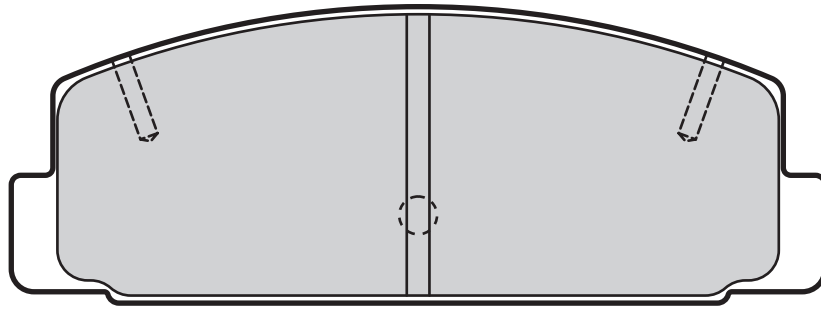

598780

0

107,6

39,2

13,1

AKEBONO

MAZDA

24046 (WVA)

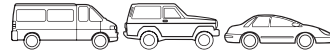
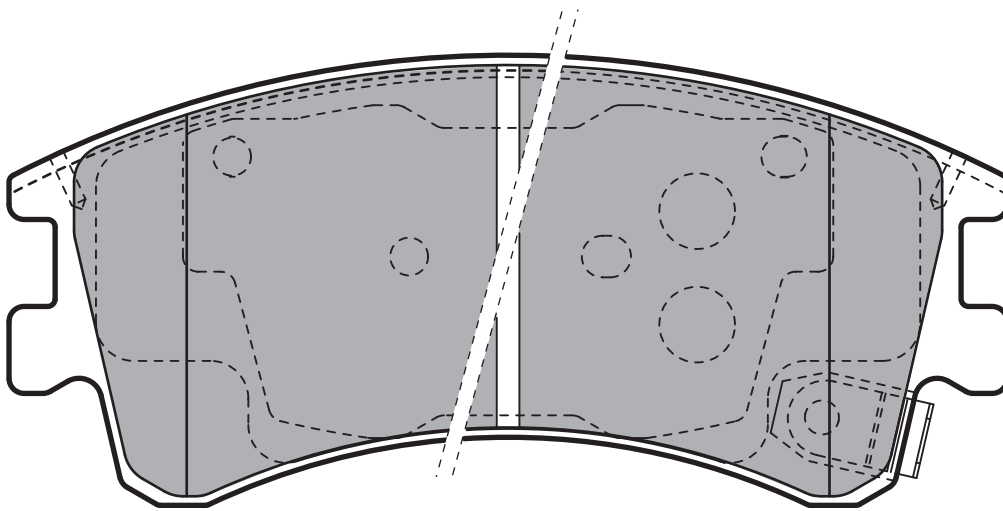

598648

2

132

59,5

19

AKEBONO

MAZDA

24071 (WVA)

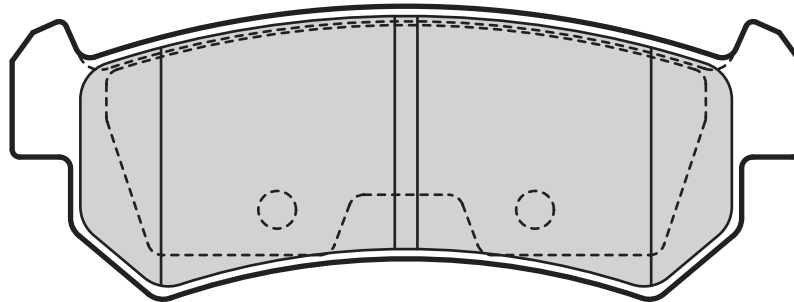

598874

0

104,2

38,8

14,6

SUMITOMO

CHEVROLET, DAEWOO

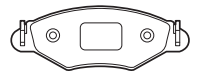

24072 (WVA)

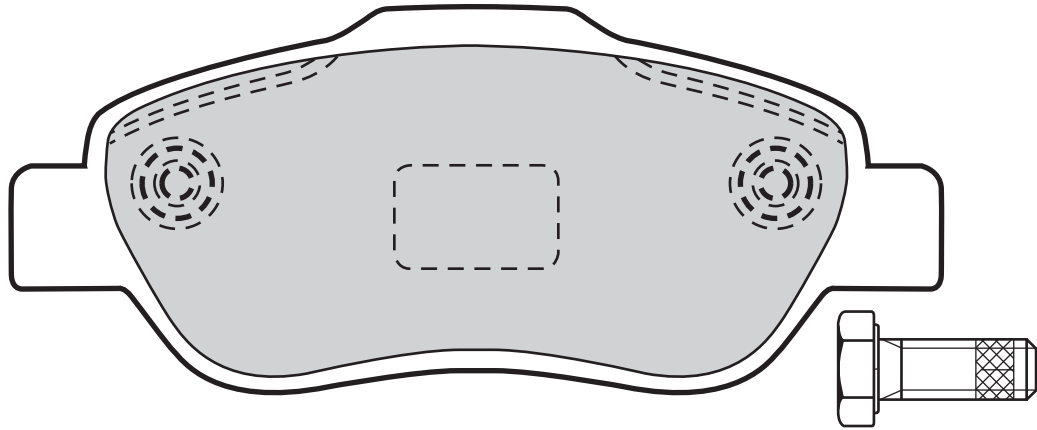

Valeo



Valeo



598696

0

122,8

51,8

17,9

BOSCH

FIAT

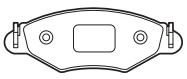

Valeo

24073 (WVA)

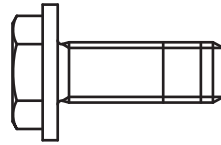
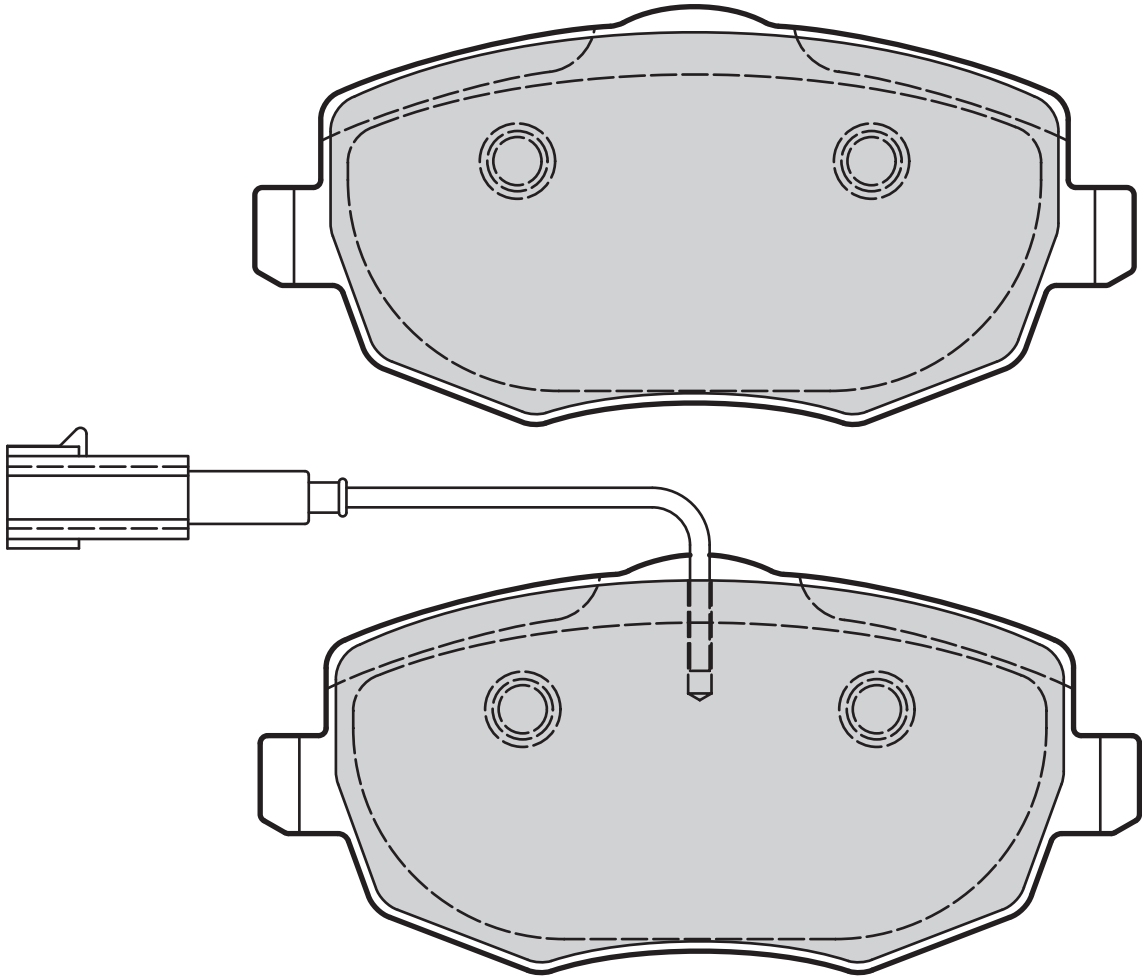

Valeo



Valeo



601031

1

210

116,7

55,5

15,6

TEVES

LANCIA

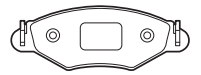

24077 (WVA)

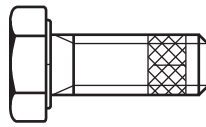
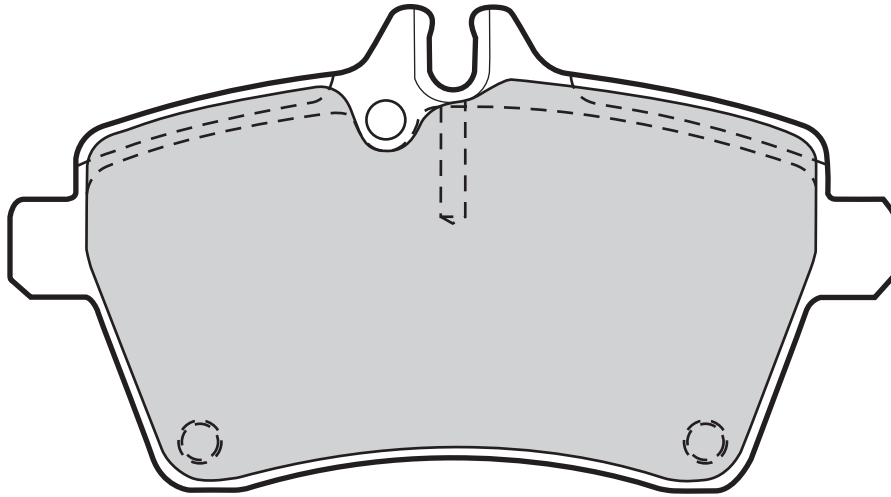

Valeo



Valeo



598704

0

116,5

63,8

19

LUCAS

MERCEDES

24083 (WVA)

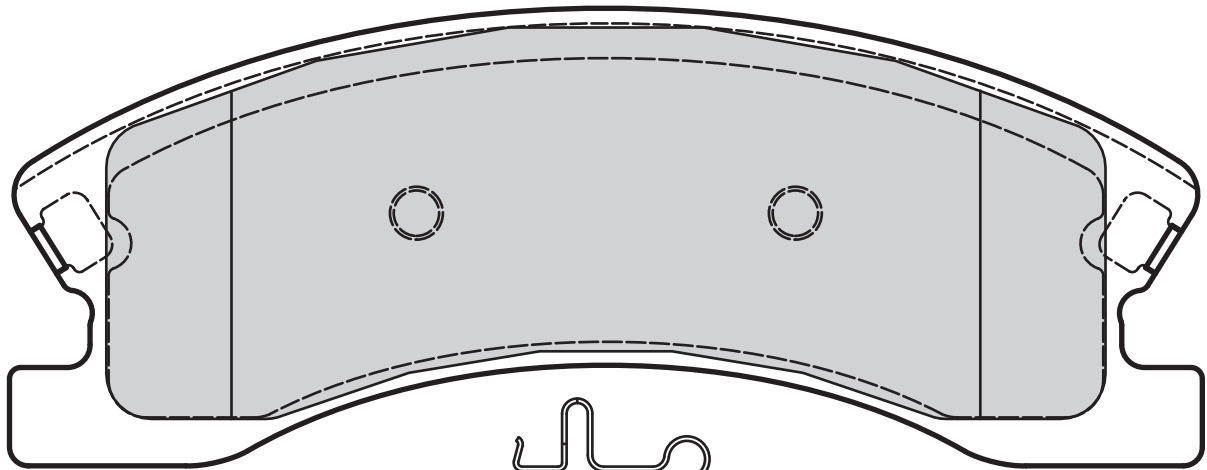

Valeo



Valeo



598833

0

157,8

60,5

19,3

AKEBONO

JEEP

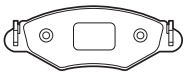

24086 (WVA)

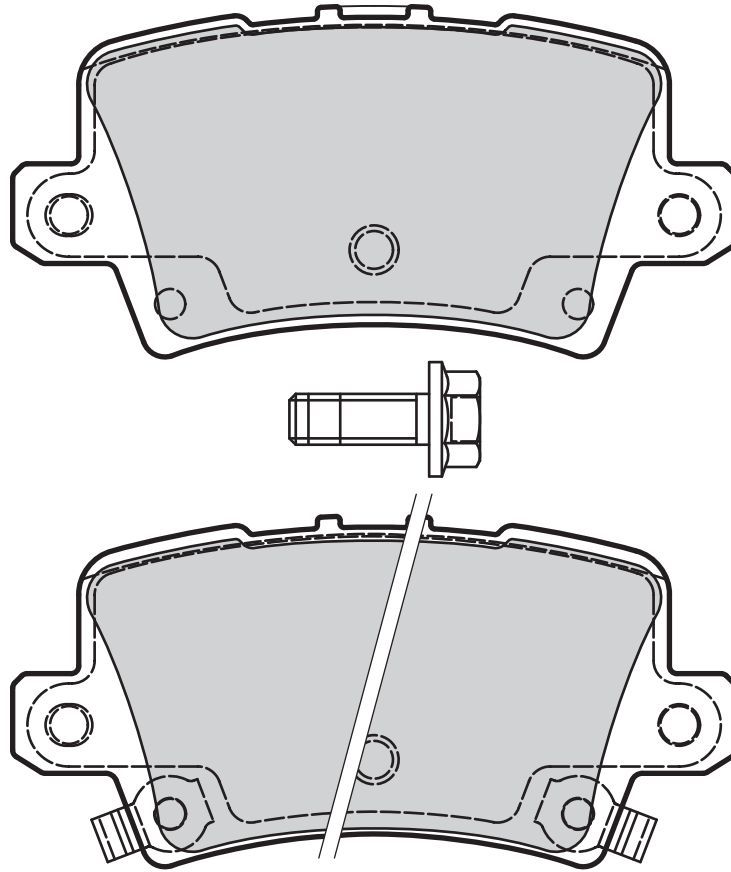

598849	2	Leaf	95,6	46,3	15,7	LUCAS	HONDA		

24087 (WVA)

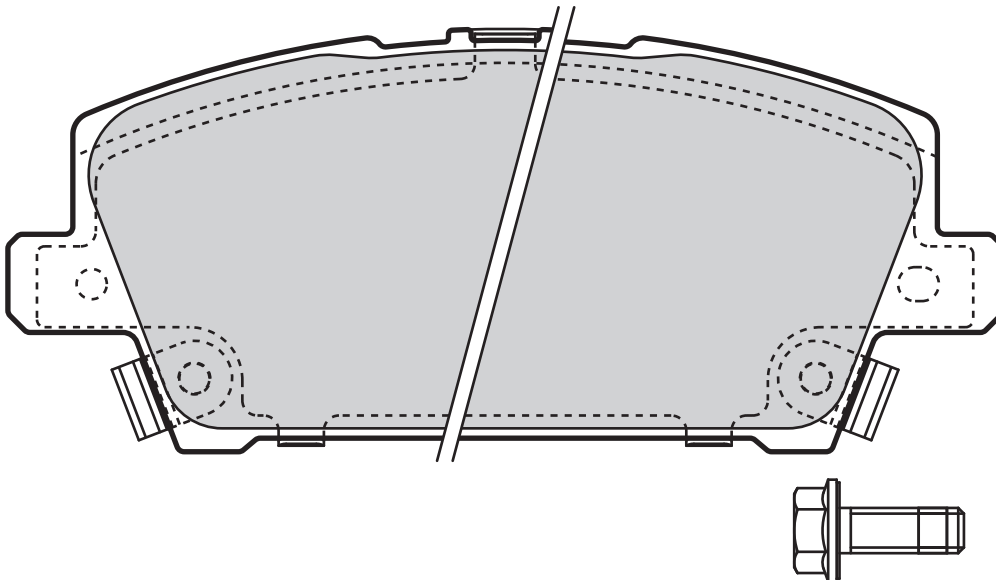

598803	2	Leaf	131,5	55,7	17,5	SUMITOMO	HONDA		



24092 (WVA)

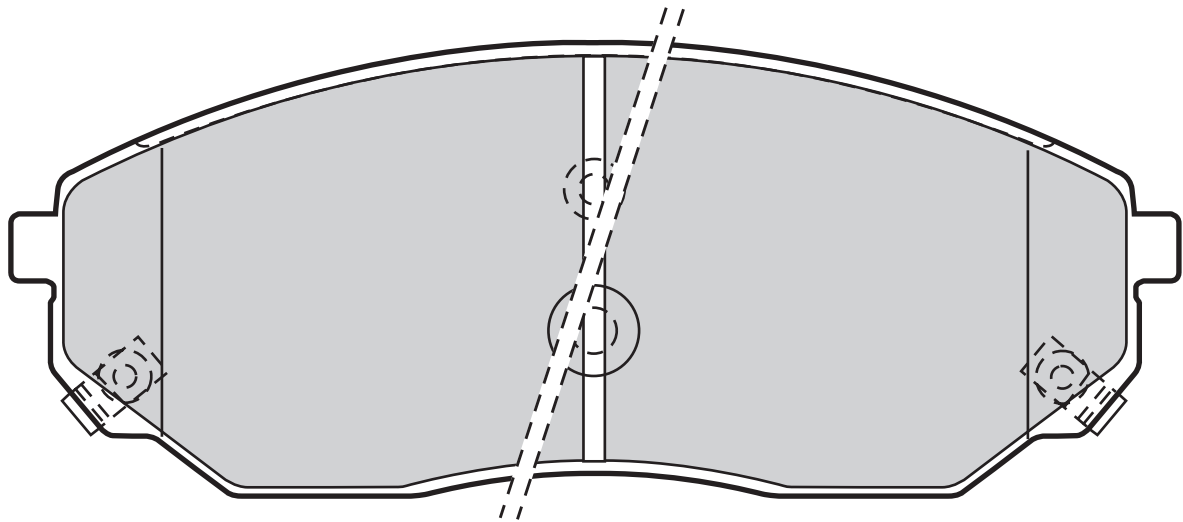
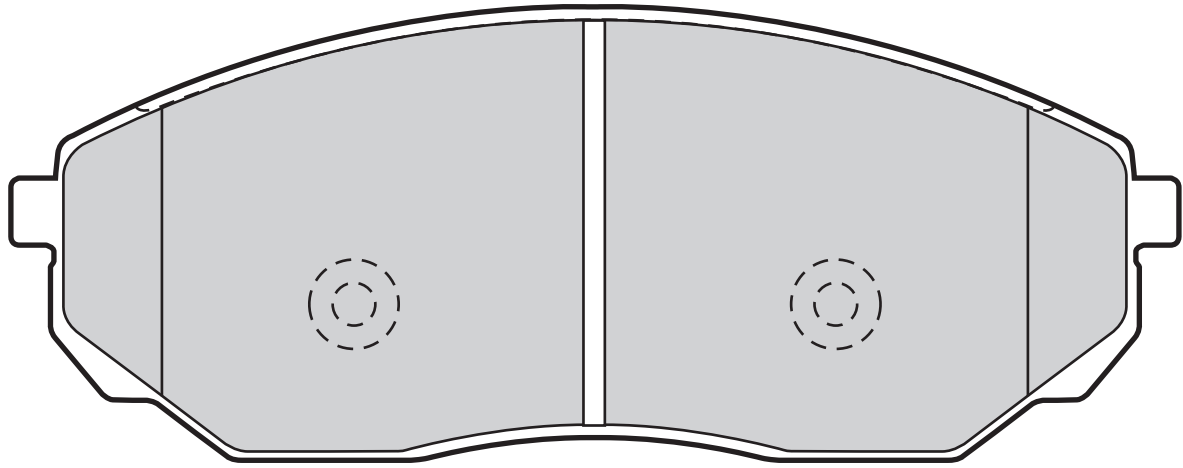

Valeo



Valeo



598654

2

155

60

17,3

AKEBONO

KIA



24098 (WVA)

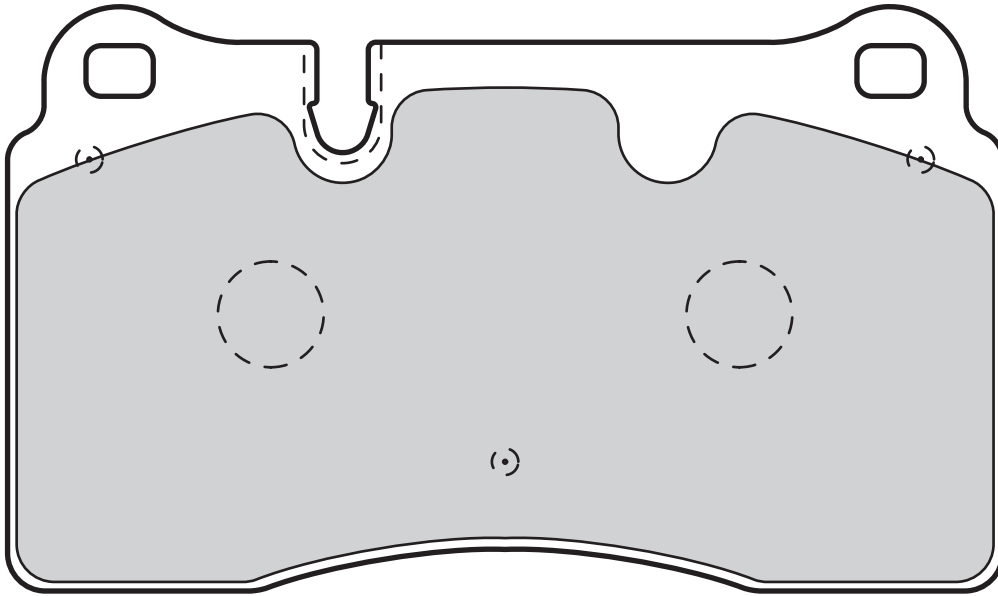

598994	0		131,8	77,4	17,1	BREBBO		AUDI, VOLKSWAGEN

24111 (WVA)

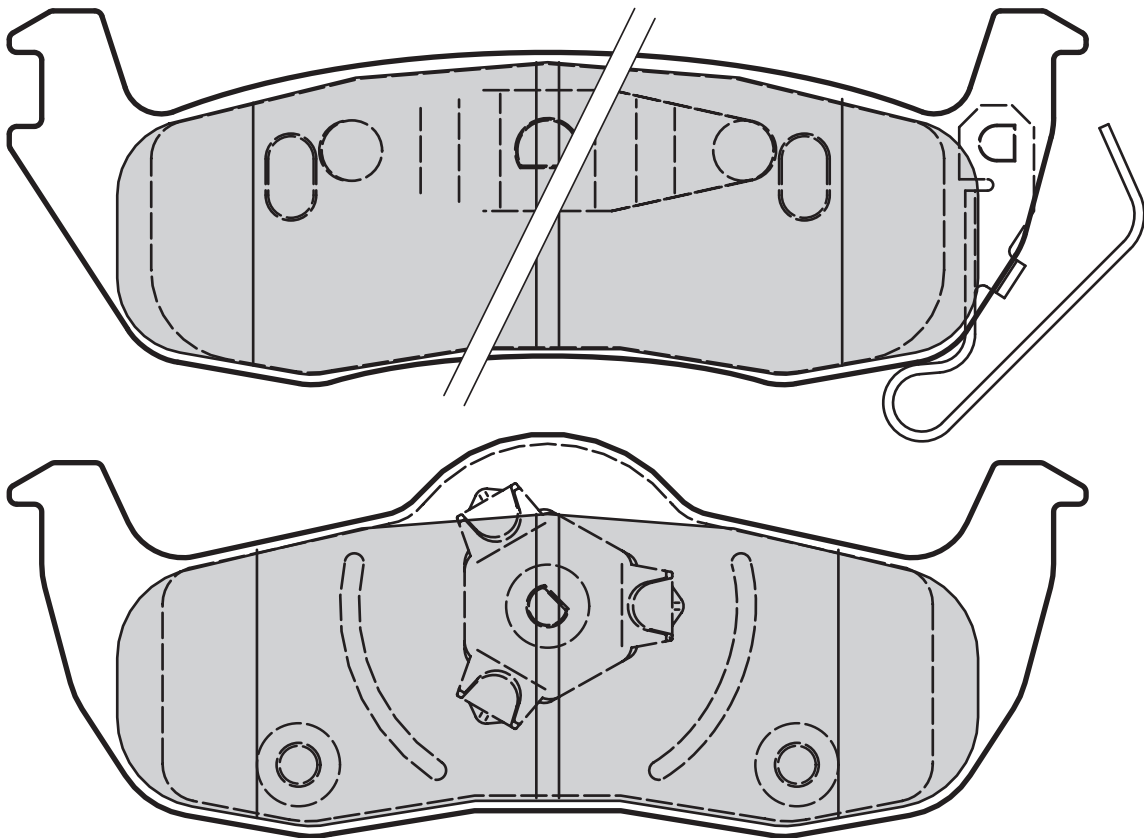

598920	2	Leaf	142	49/52,9	17,9	KELSEY		JEEP



24122 (WVA)

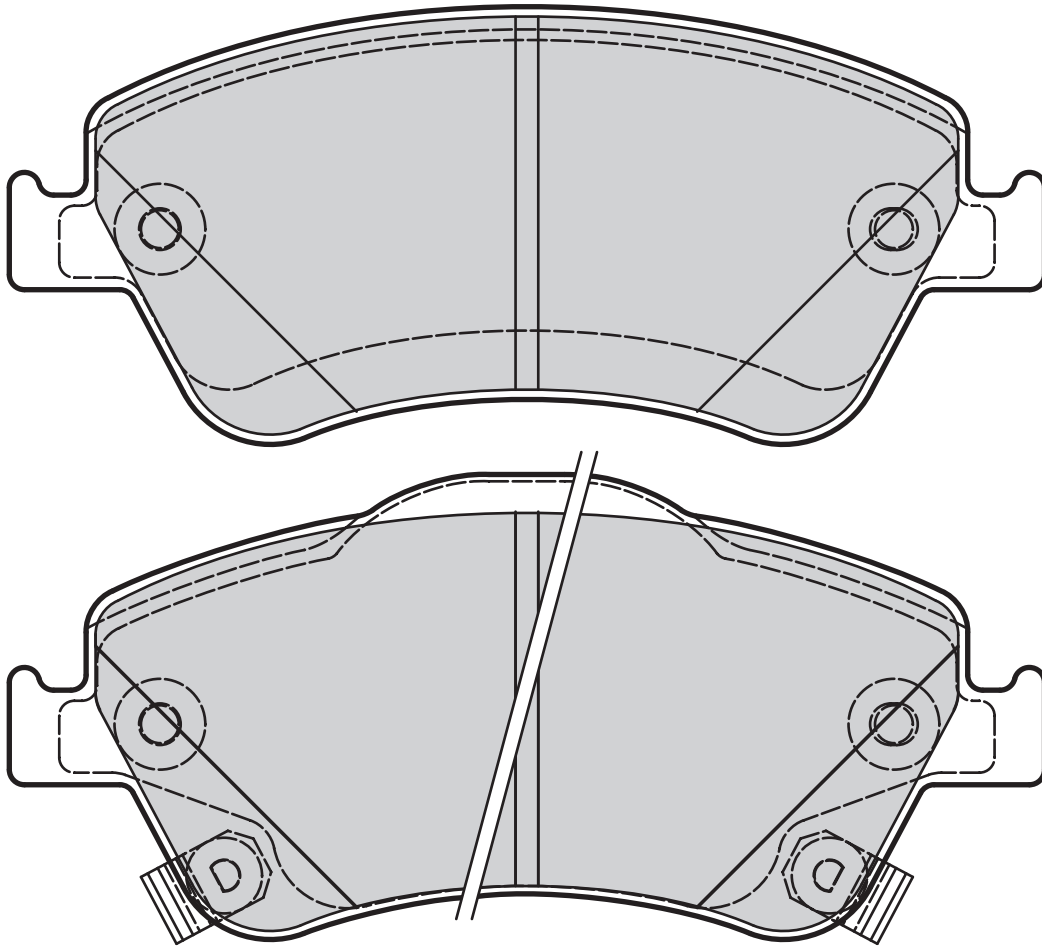

Valeo



Valeo



601040

0

136,8

57,9

19

BOSCH

TOYOTA

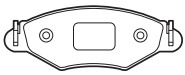

Valeo

24123 (WVA)

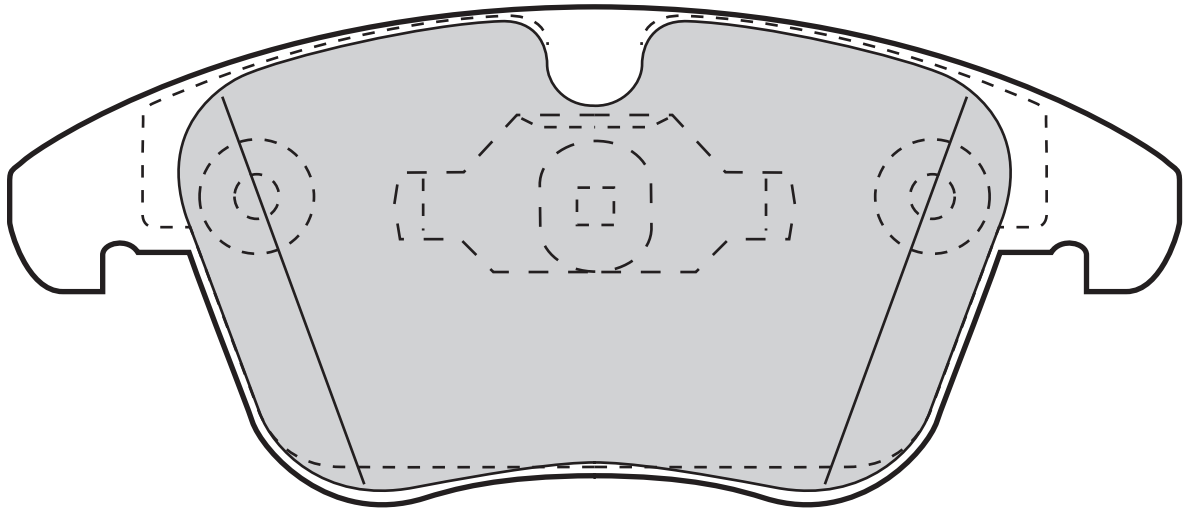
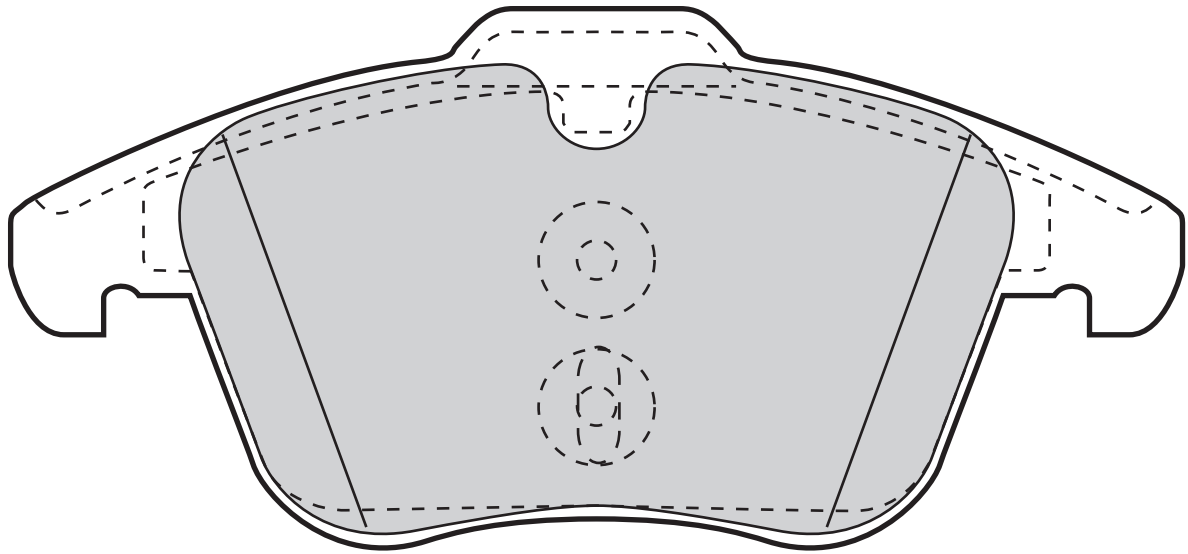

Valeo



Valeo



598879

0

155,1

72/66,6

19,2

TEVES

FORD, LAND ROVER, VOLVO

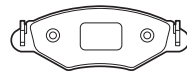

24133 (WVA)

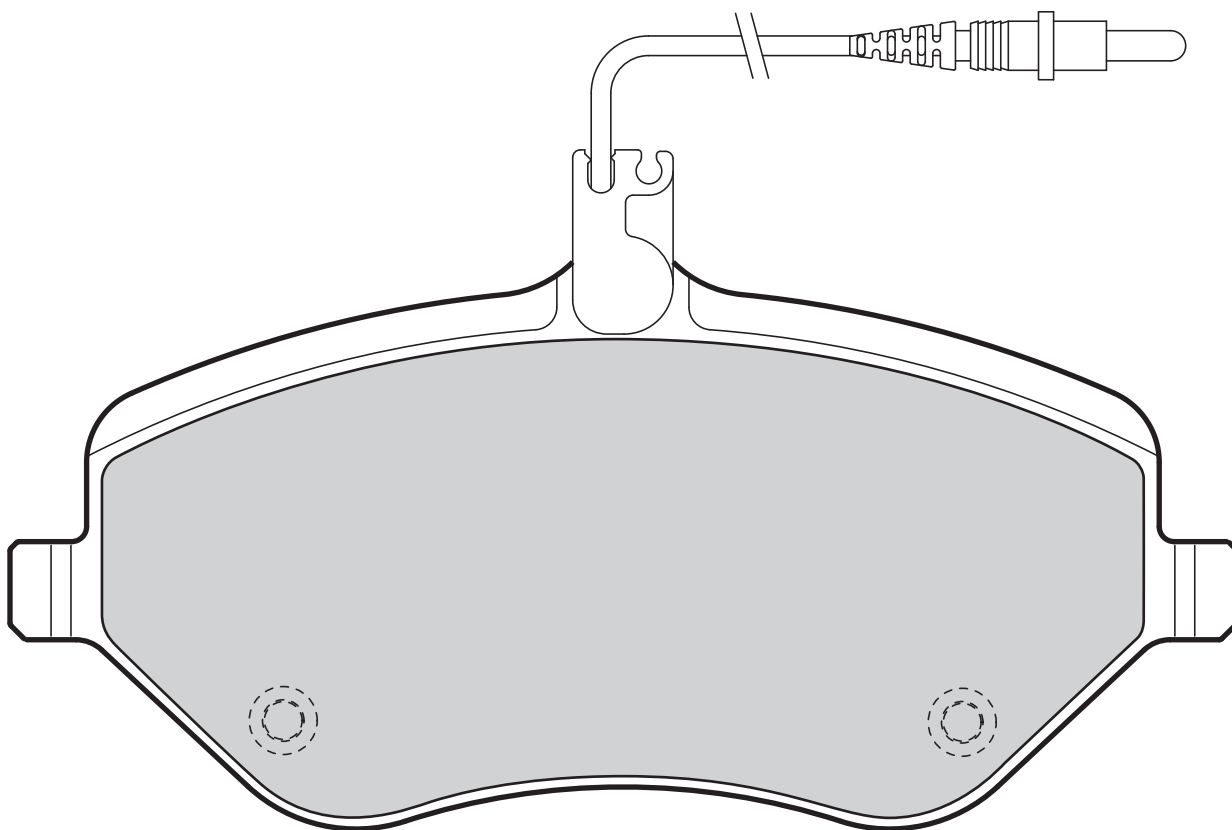

Valeo



Valeo



598663

2

325/365

162,4

79

18,5

LUCAS

CITROËN, PEUGEOT



Valeo

24134 (WVA)

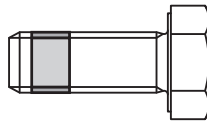
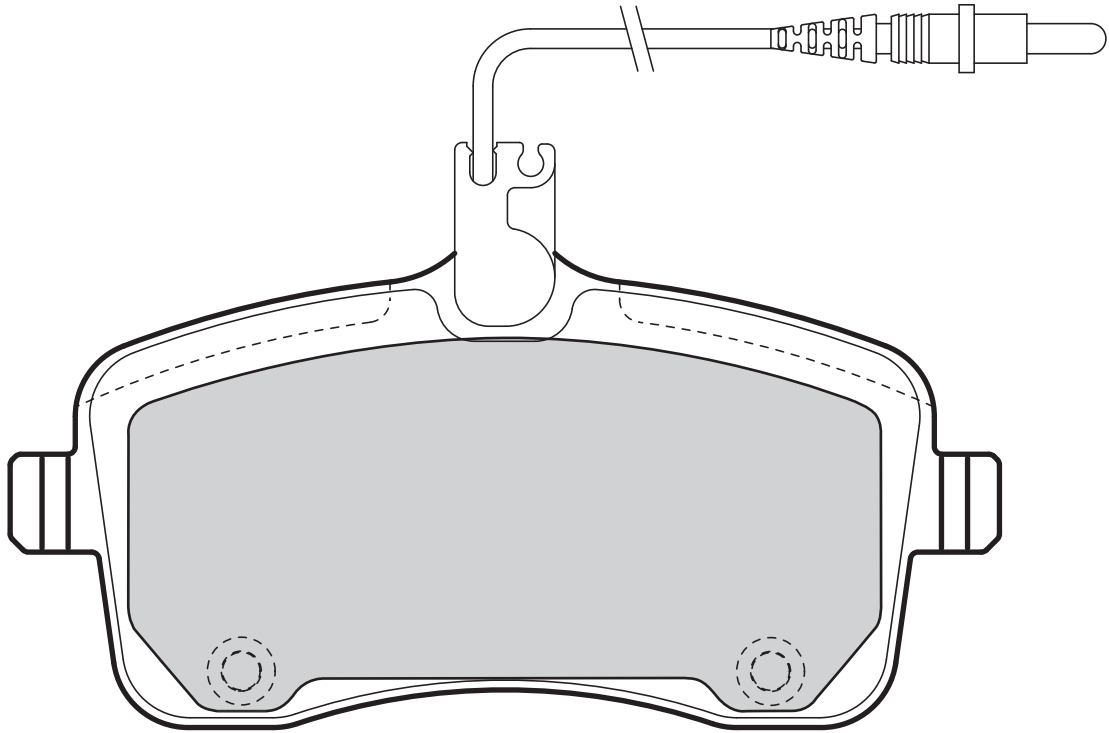

Valeo



Valeo



598662

2

325/365

131,4

66,8

19,5

LUCAS

PEUGEOT

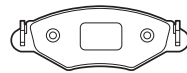

24135 (WVA)

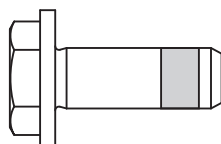
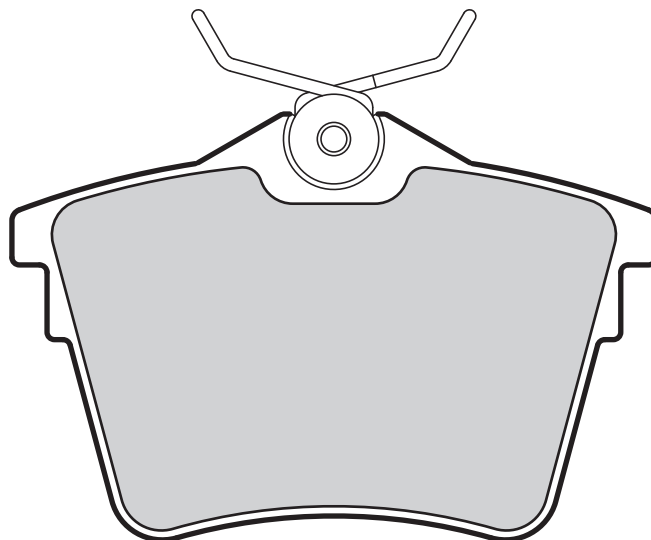

Valeo



Valeo



598664

0

86,2

57

17,8

LUCAS

CITROËN, PEUGEOT



Valeo

24137 (WVA)

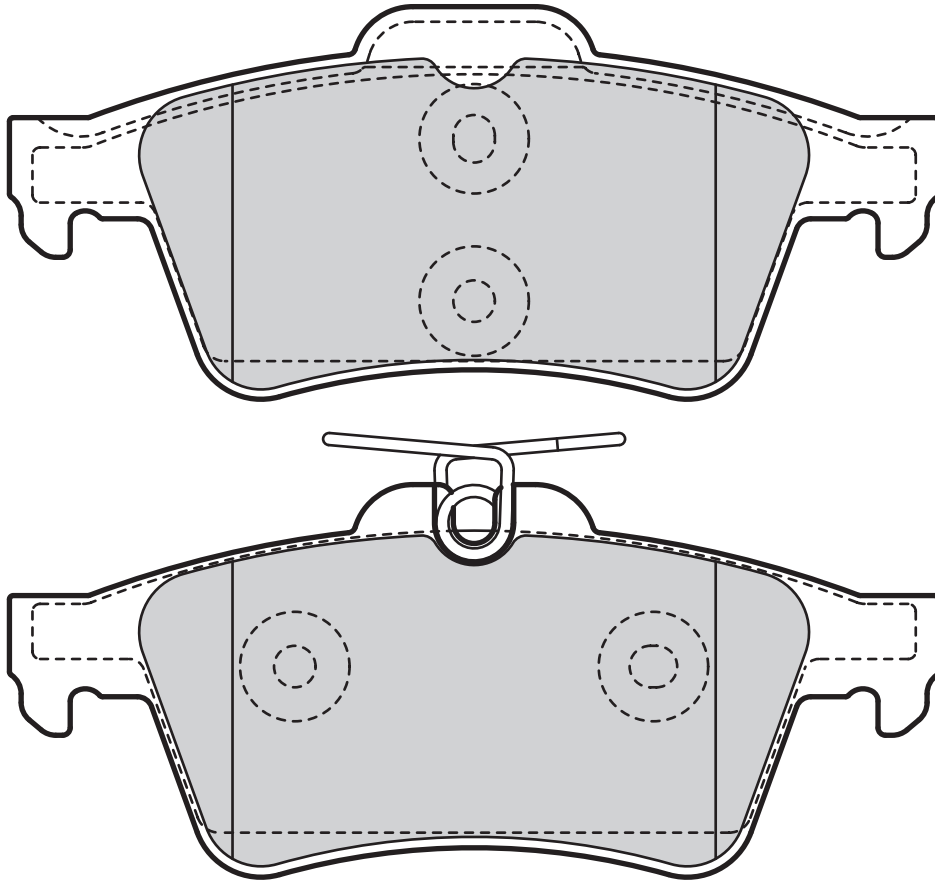

Valeo



Valeo



598783

0

122,9

51,7

16,4

TEVES

CADILLAC, CITROËN, FORD, OPEL, RENAULT, VAUXHALL

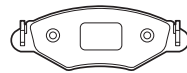

24141 (WVA)

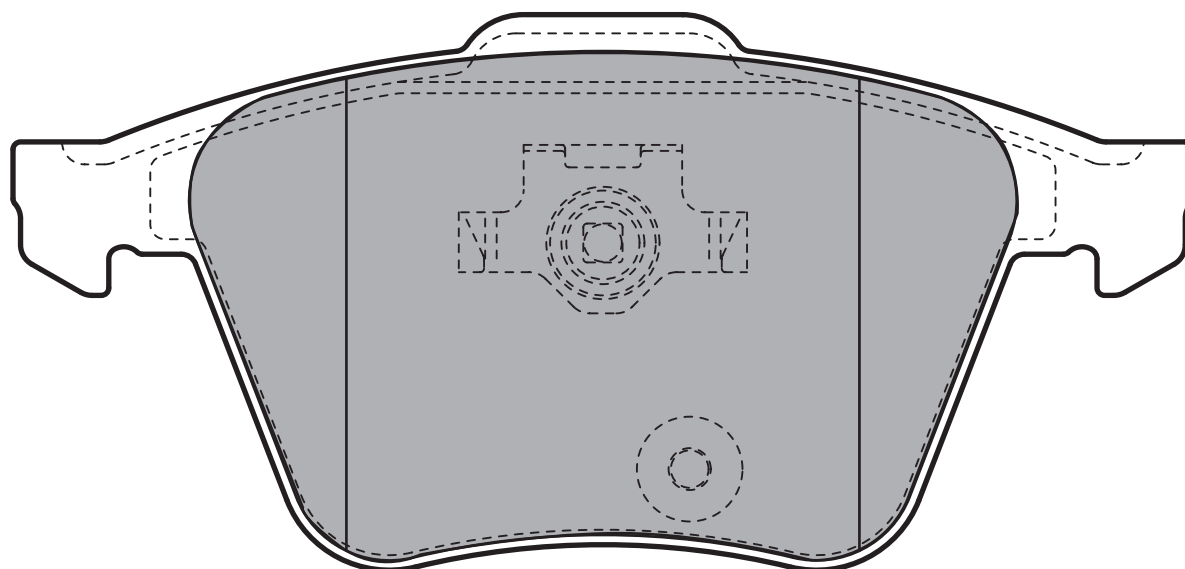
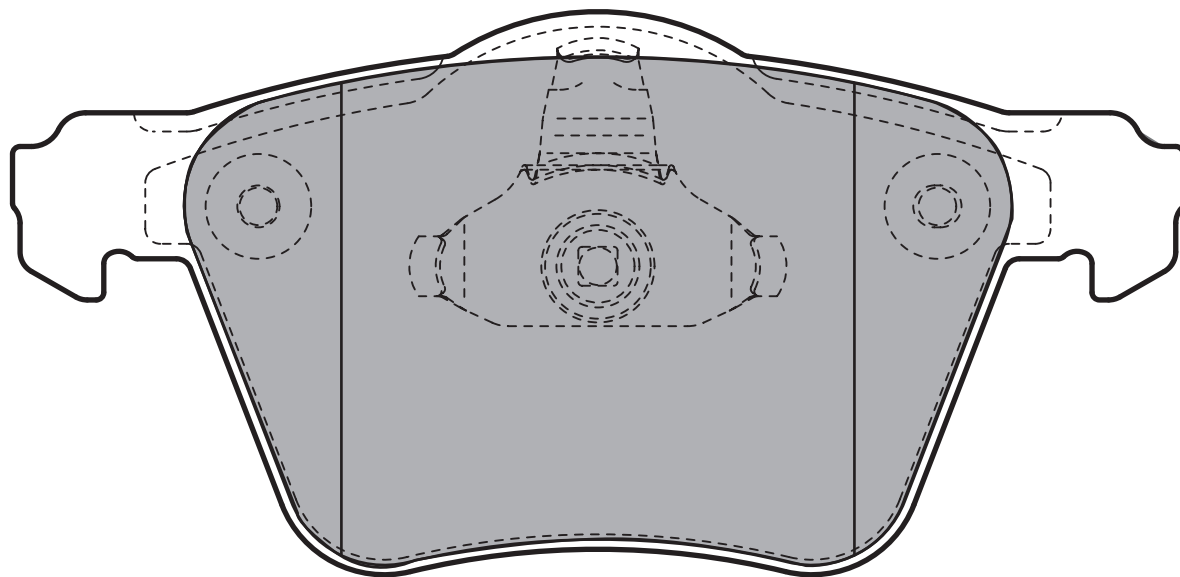

Valeo



Valeo



598657

0

155,2

74/75

19

TEVES

VOLVO

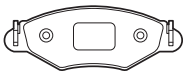

Valeo

24142 (WVA)

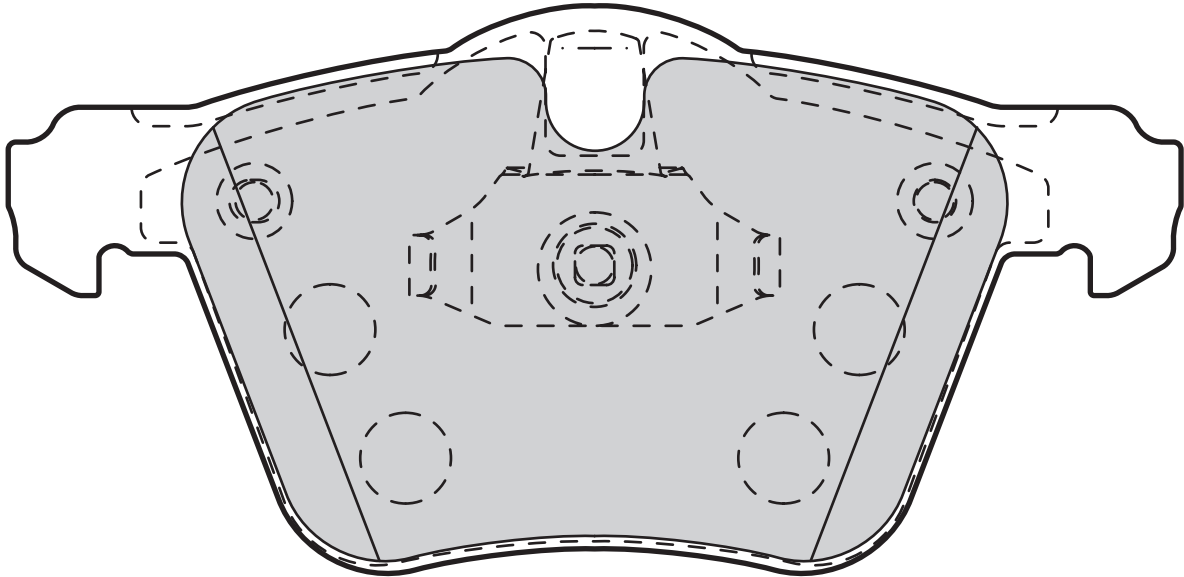
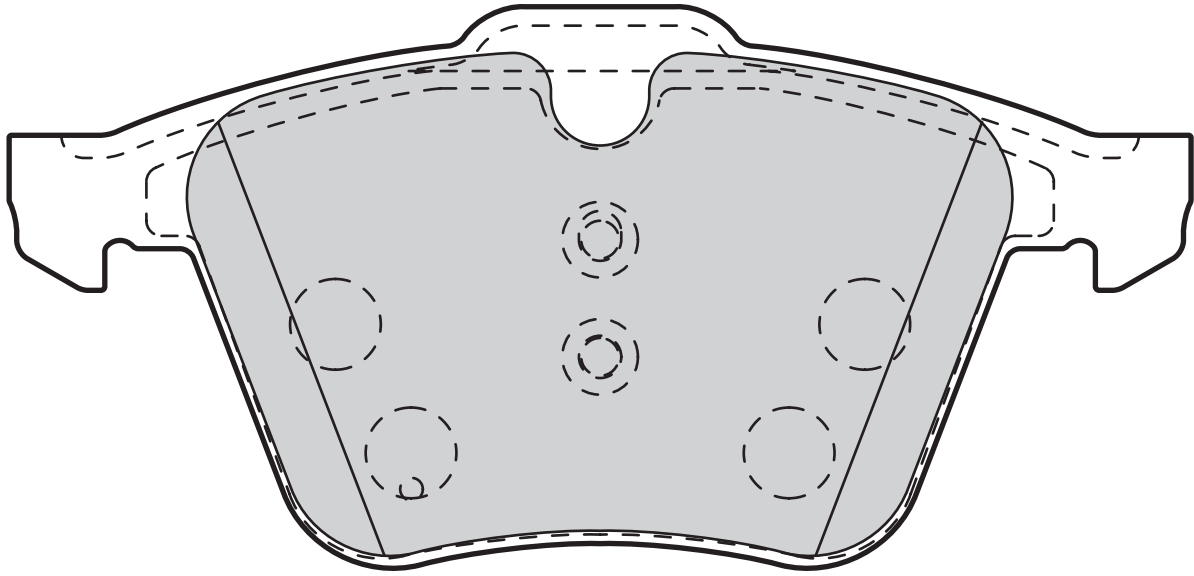

Valeo



Valeo



601007

0

155,2

75,1

20,1

TEVES

FORD, VOLVO

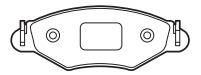

24150 (WVA)

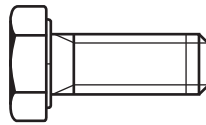
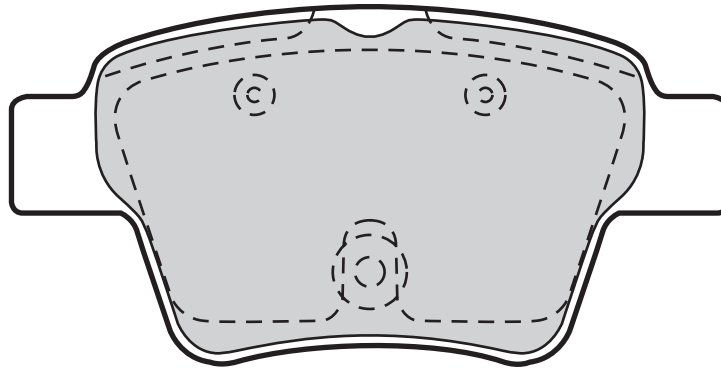

Valeo



0

Valeo



94,5



46,7



17,6



BOSCH



CITROËN, PEUGEOT

598702

24162 (WVA)

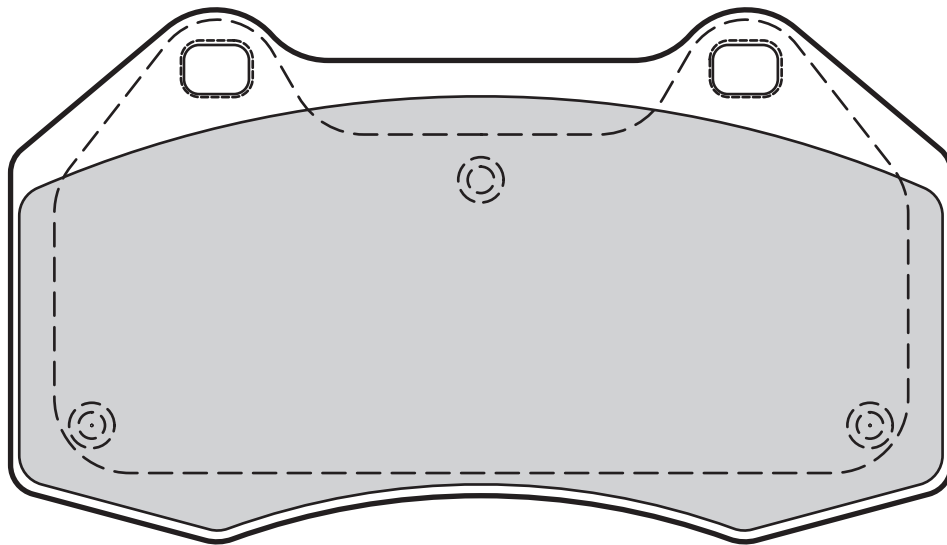

Valeo



0

Valeo



124,5



70,4



15,2



BREMBO







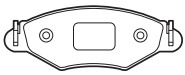



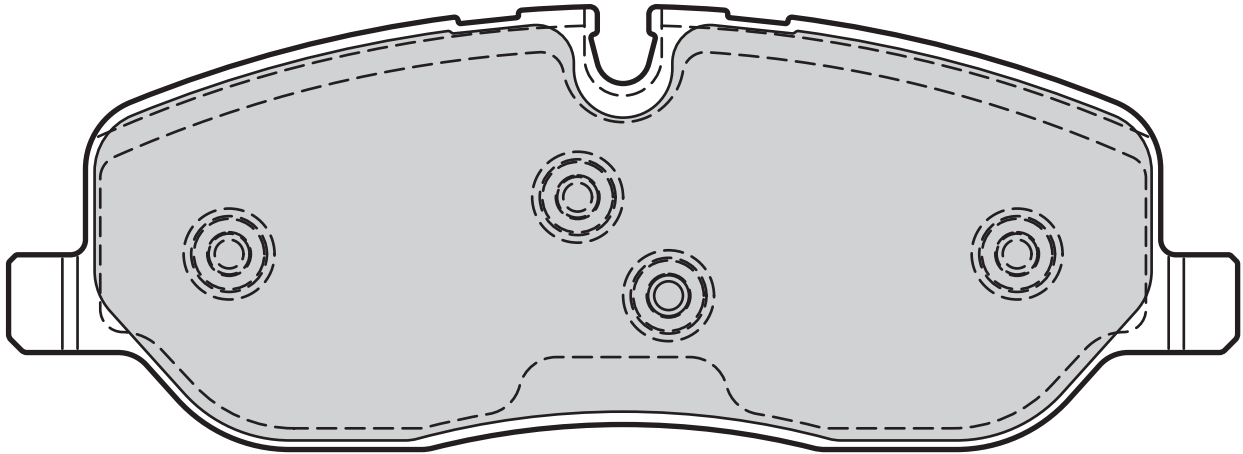

RENAULT

598861



24191 (WVA)









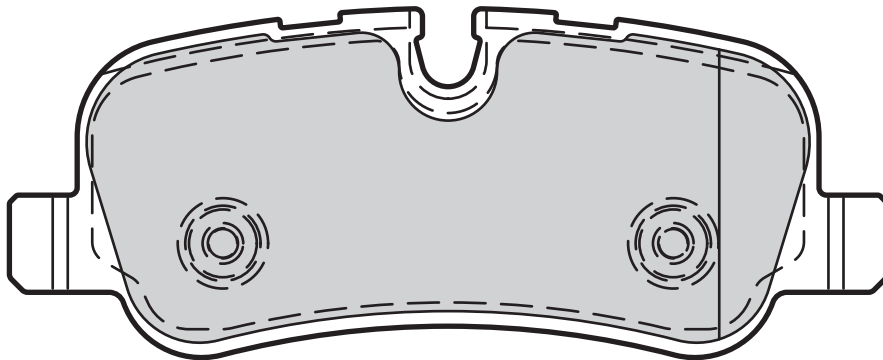



598741 162,5 58,5 18,1 LUCAS LAND ROVER

24192 (WVA)









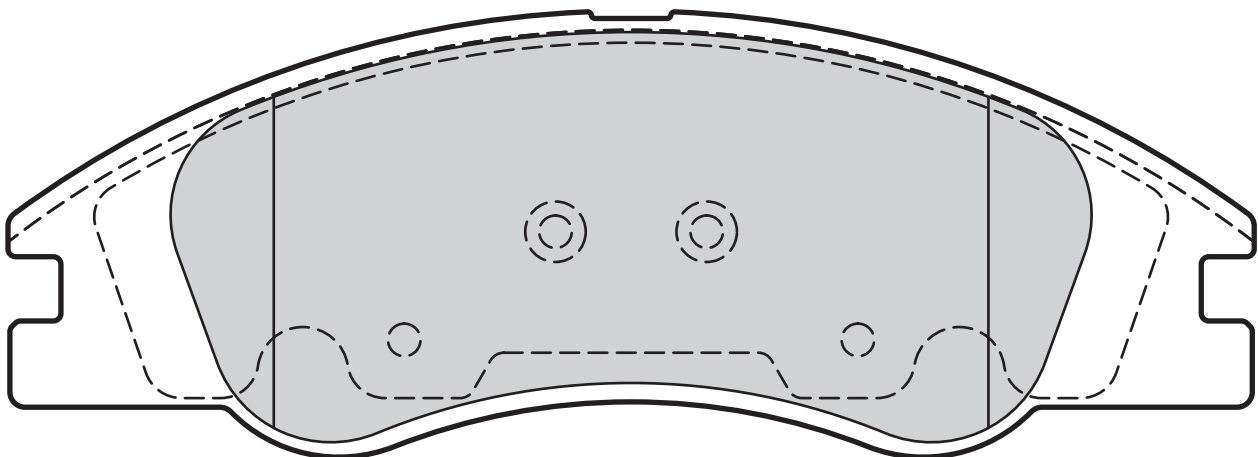



598742 116,5 46,3 17,5 LUCAS LAND ROVER

24218 (WVA)



598705 2 164,8 58,9 16,9 MANDO KIA

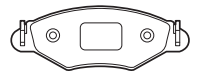

24229 (WVA)

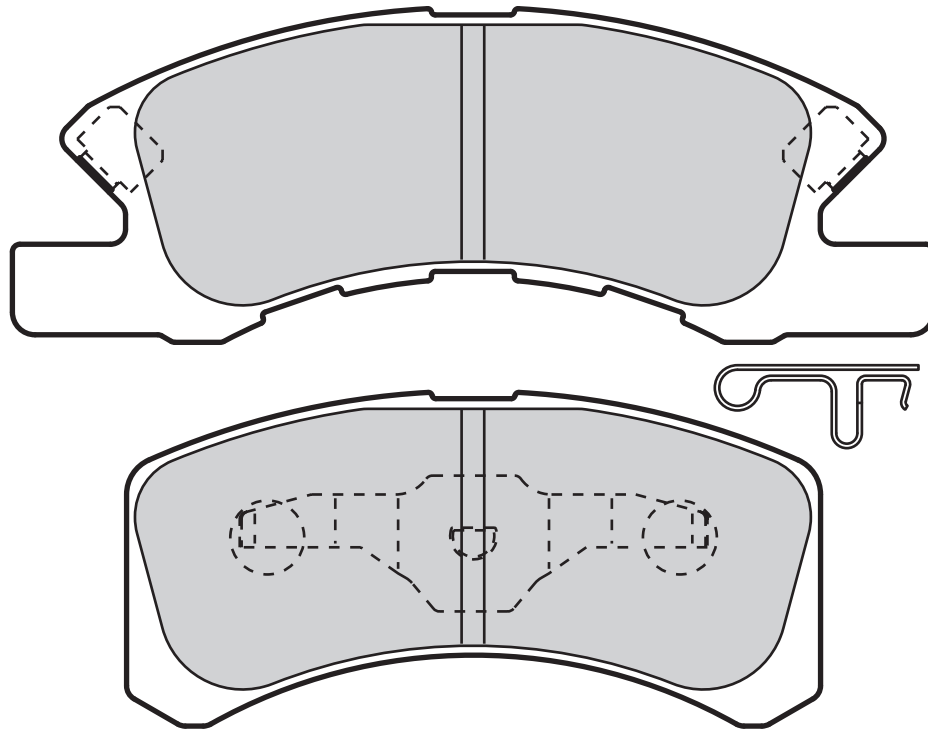

Valeo



2

Valeo



91,8



44,3



15,3



AKEBONO



DAIHATSU

598873

24240 (WVA)

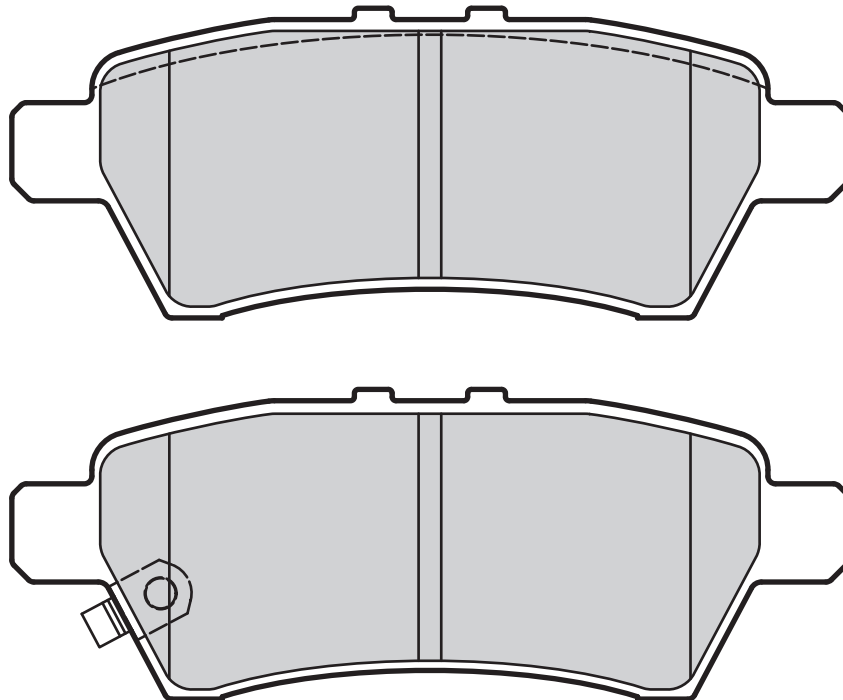

Valeo



1

Valeo



110,7



41



15,7



TOKICO



NISSAN

598730



24250 (WVA)

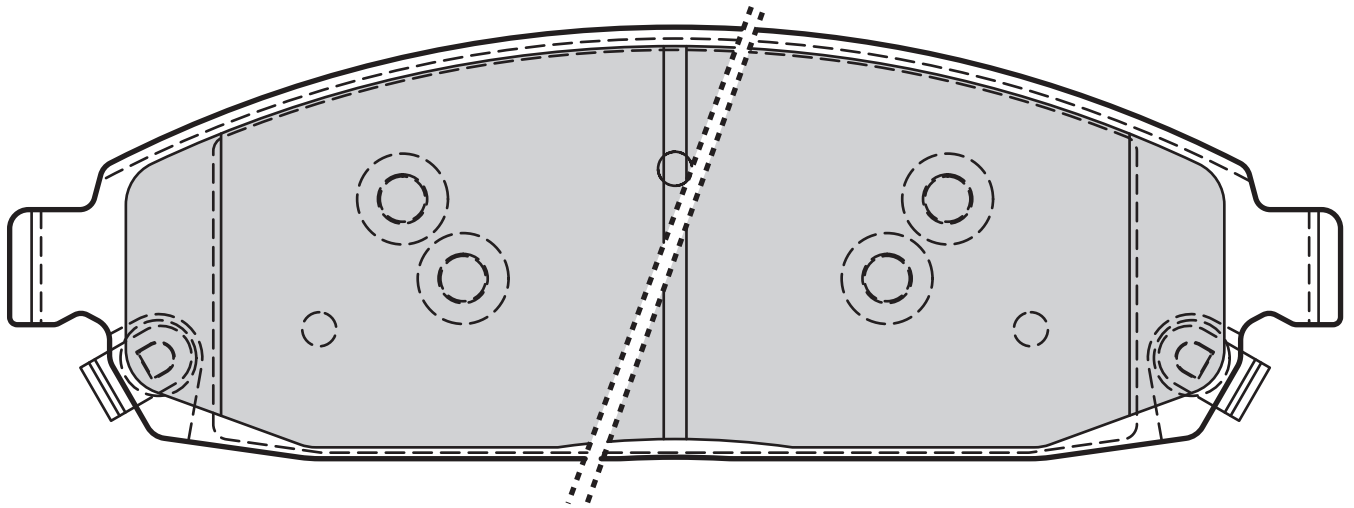

598872	2		176	57	18,8	AKEBONO		JEEP		

24253 (WVA)

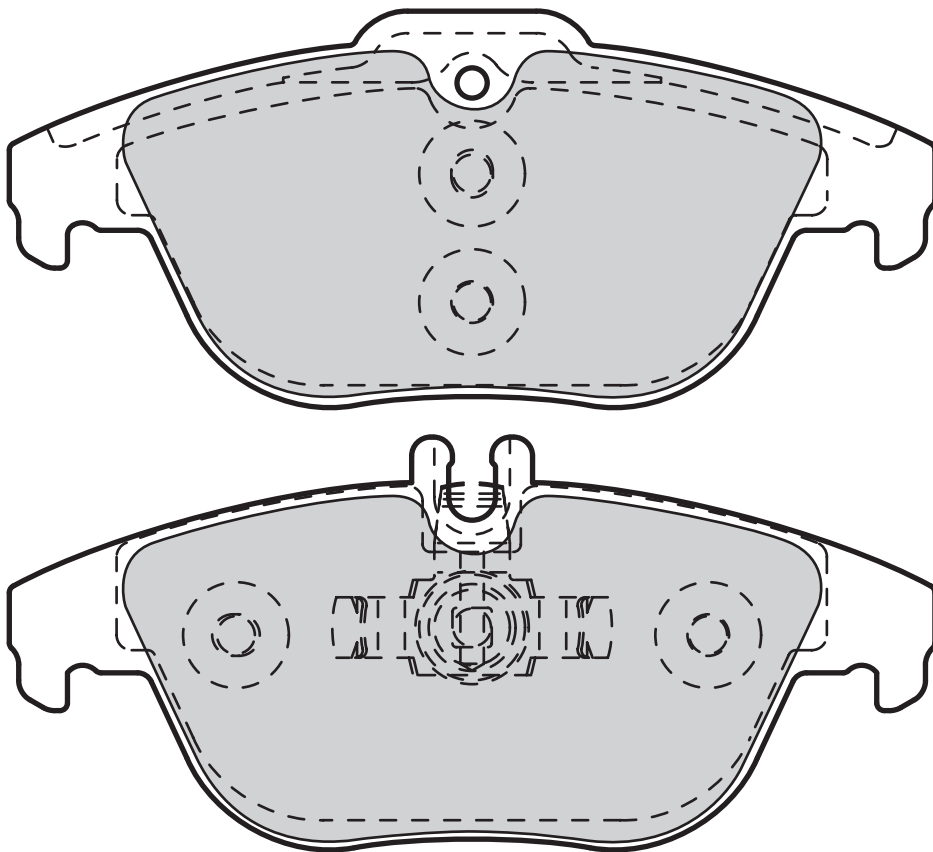

601051	0		122,5	52,5	17,6	TEVES		MERCEDES		

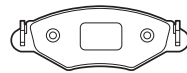

24260 (WVA)

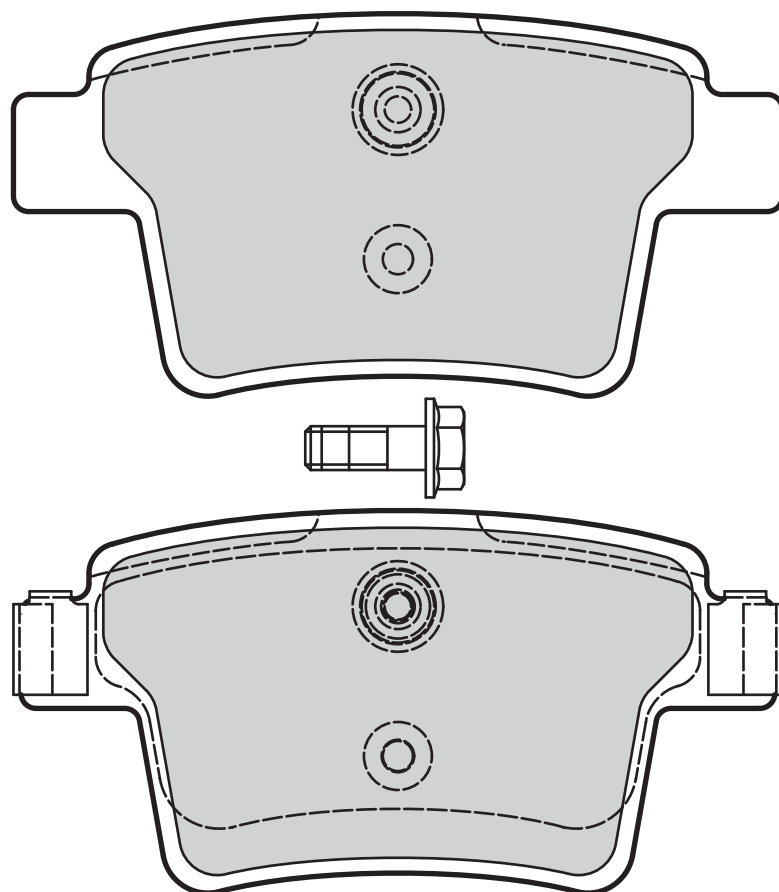

Valeo



Valeo



598740

0

101,8

50,6

17

BOSCH

FORD



24271 (WVA)

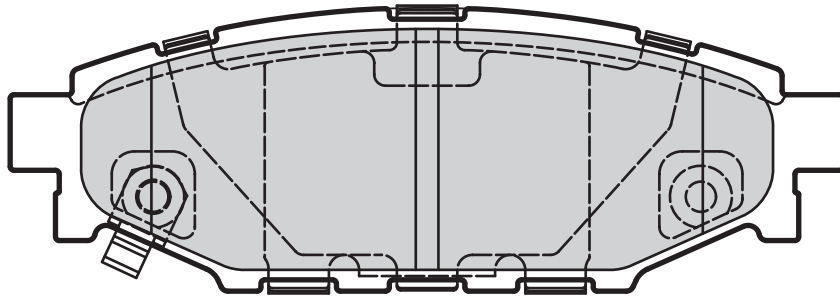
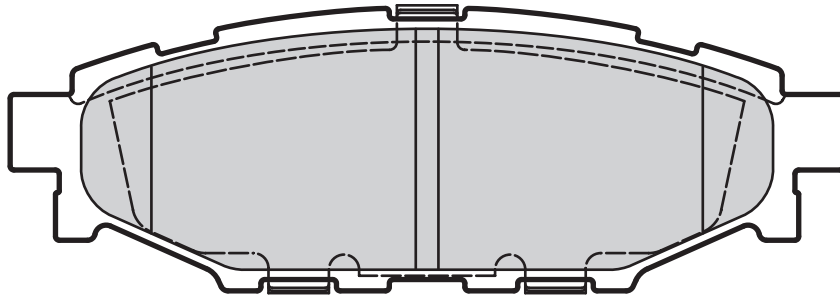

Valeo



2

Valeo



110



37



14,5



AKEBONO



SUBARU

598929

24275 (WVA)

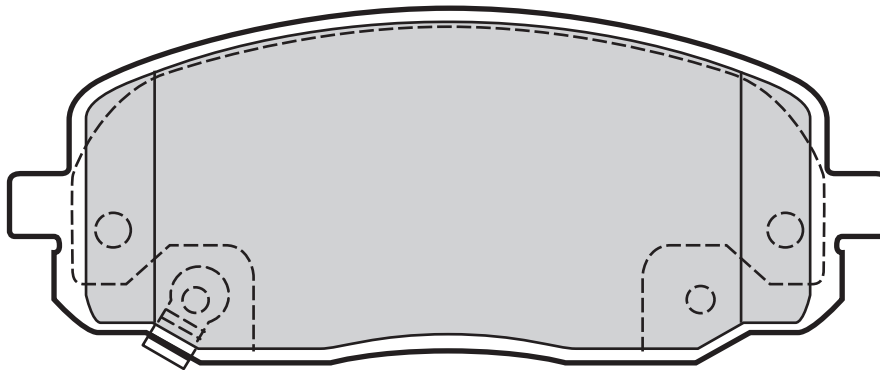

Valeo



2

Valeo



116



47,2



16,8



MANDO



HYUNDAI, KIA

598707



24276 (WVA)

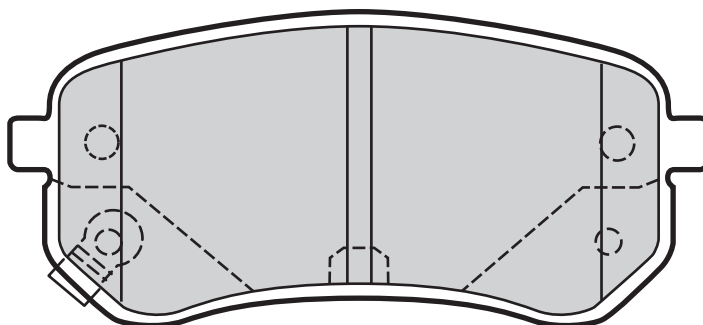

Valeo



2

Valeo



92,3



41



14,8



MANDO



HYUNDAI, KIA

598706

24277 (WVA)

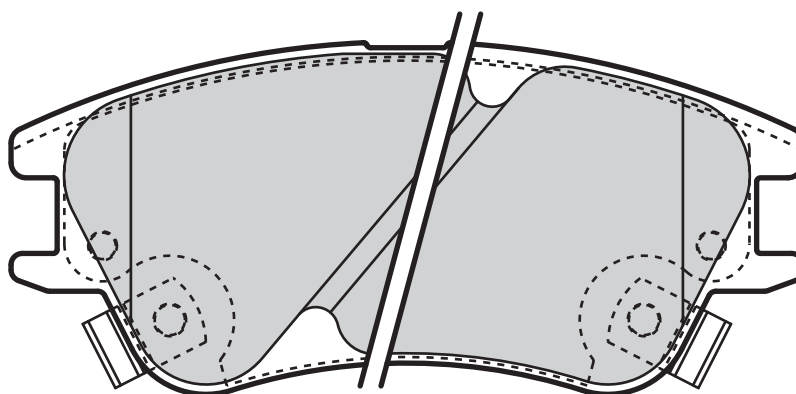

Valeo



2

Valeo



104,7



47,2



16,3



MANDO



HYUNDAI

598708

24280 (WVA)

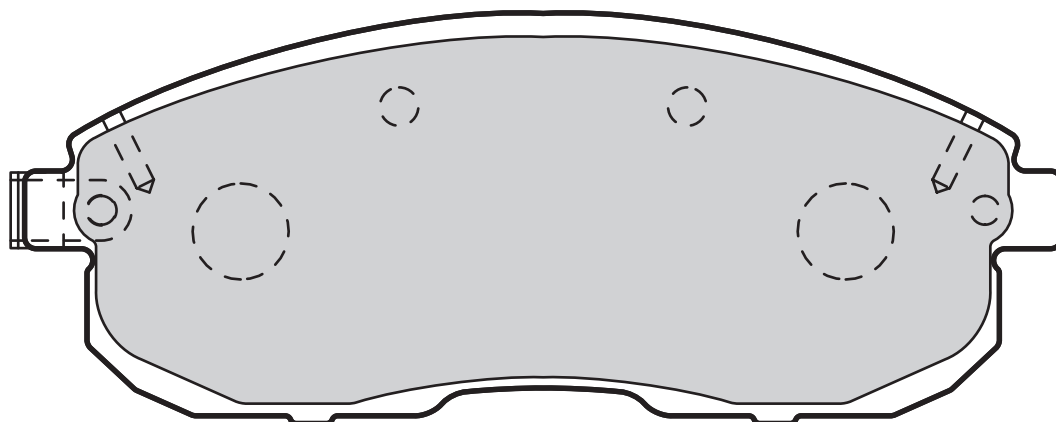

Valeo



2

Valeo



Leaf



137,3



54,4



17



TRW



NISSAN

601013



Valeo

24283 (WVA)

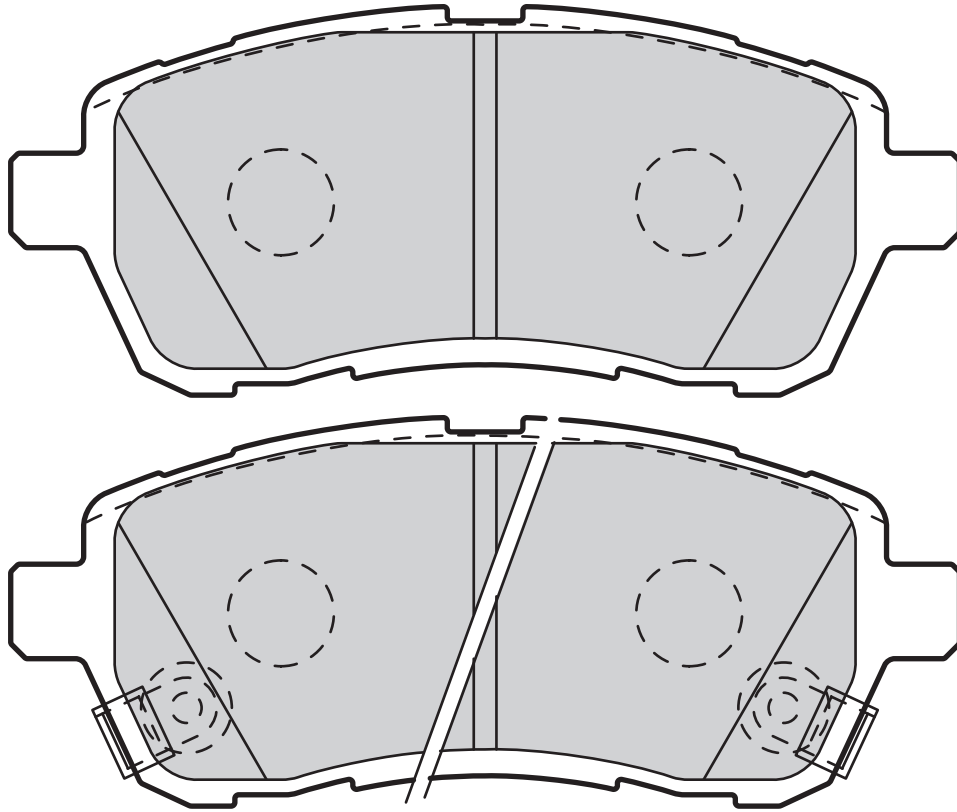

Valeo



Valeo



598999

1

Leaf

125,6

51,5

16,5

LUCAS

DAIHATSU, FORD, MAZDA



24289 (WVA)

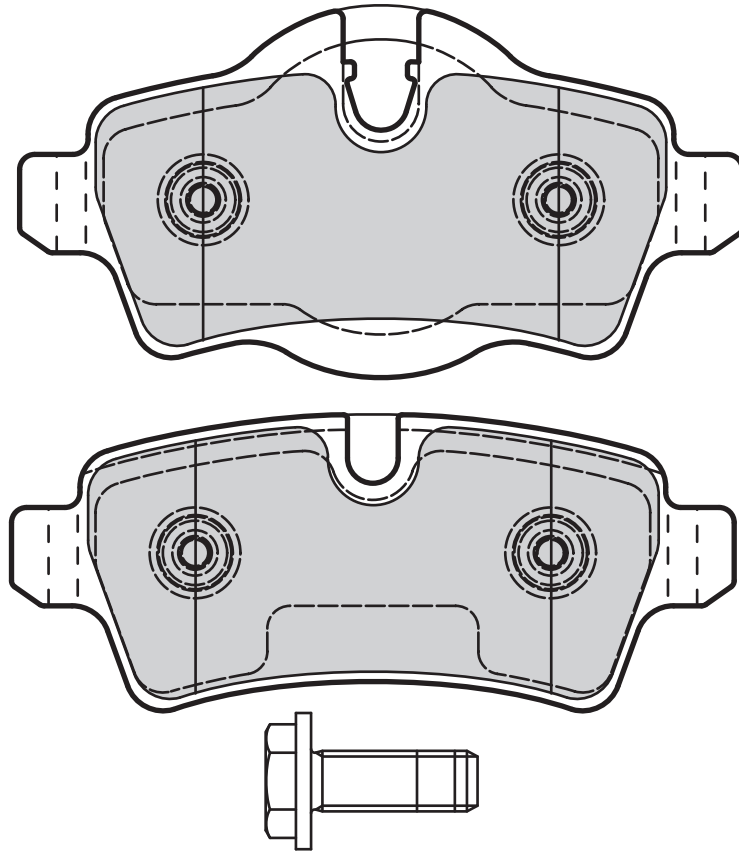

Valeo



0

Valeo



95,5



49,2



17



LUCAS



MINI



601041

24291 (WVA)

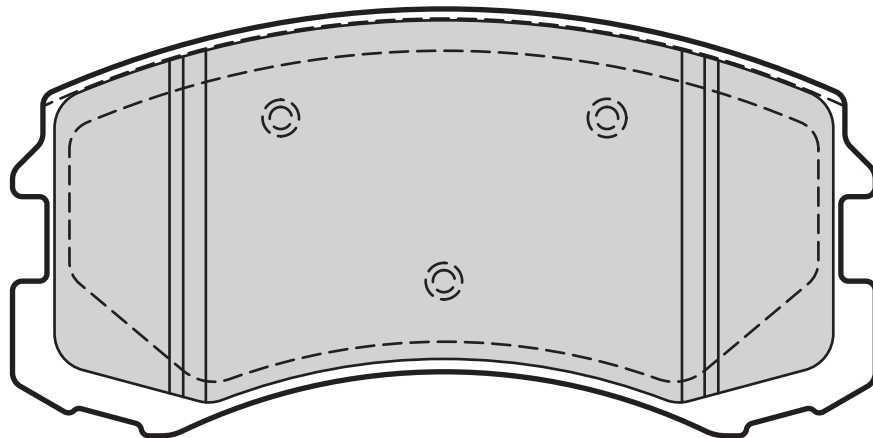

Valeo



2

Valeo



114,1



56,5



16,1



SUMITOMO



MINI



598864

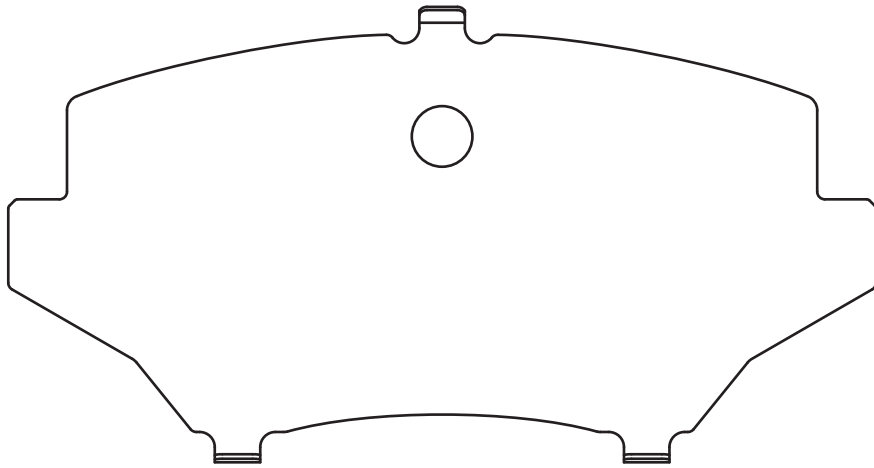
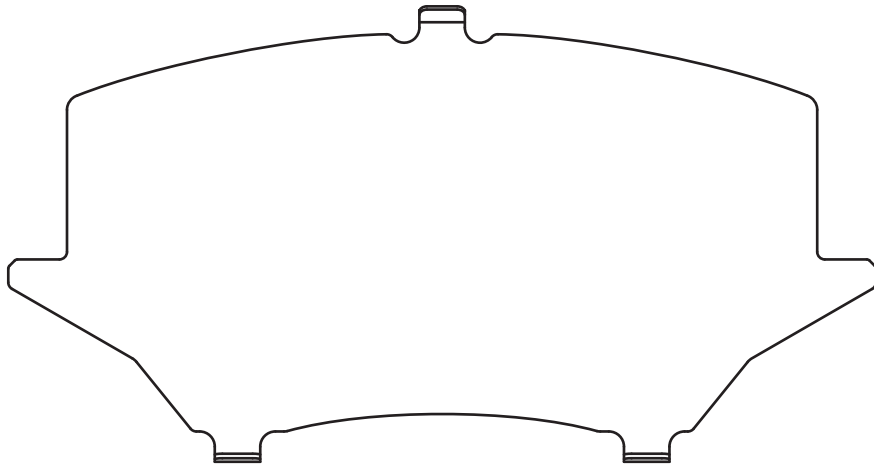
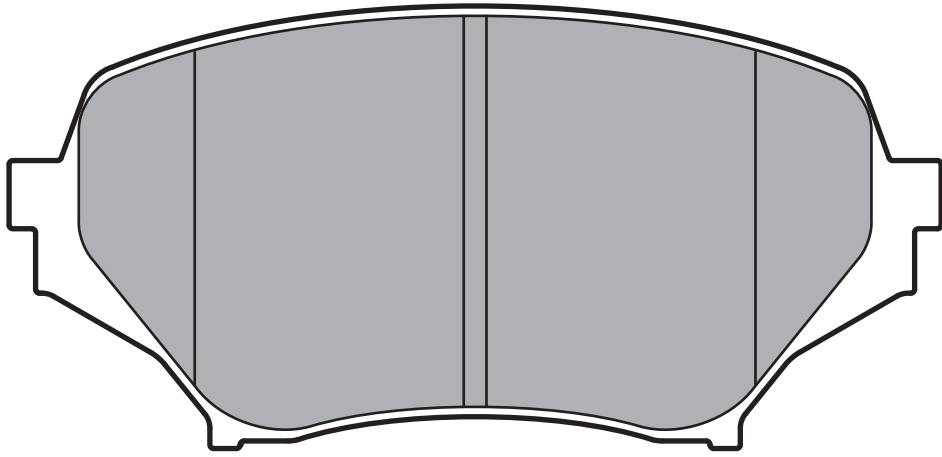
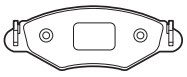

Valeo



2

Valeo



123



58,4



14,4



AKEBONO



MAZDA

598745

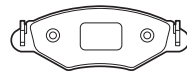

24298 (WVA)

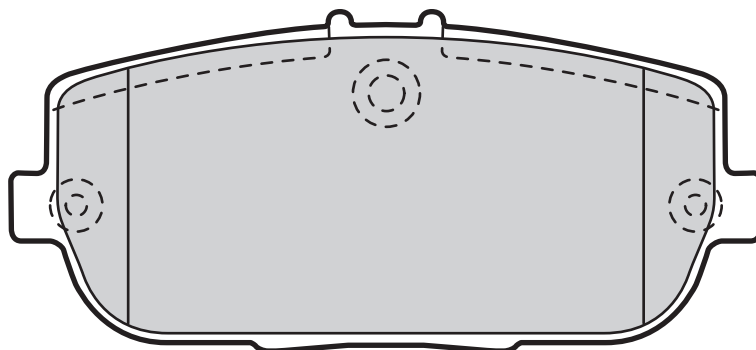

Valeo



1

Valeo



99,2



45



13,8



AKEBONO



MAZDA

598746

24301 (WVA)

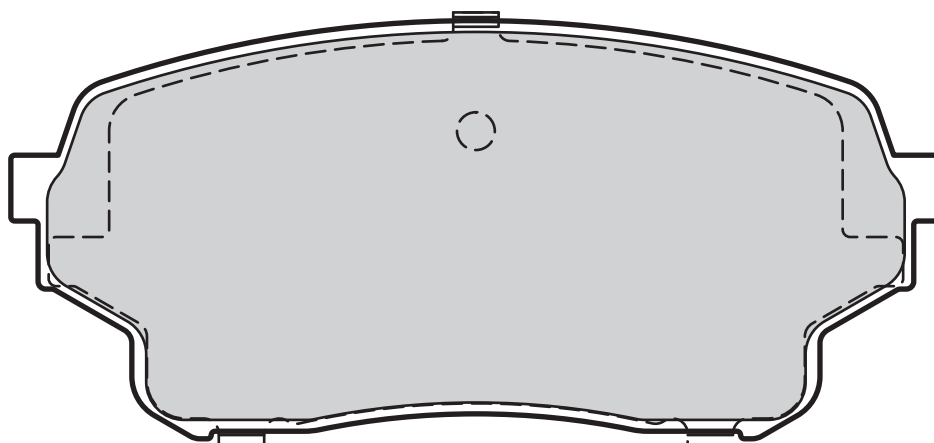

Valeo



2

Valeo



123



55,3



16,4



AKEBONO



SUZUKI

598878

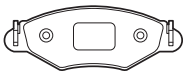

24317 (WVA)

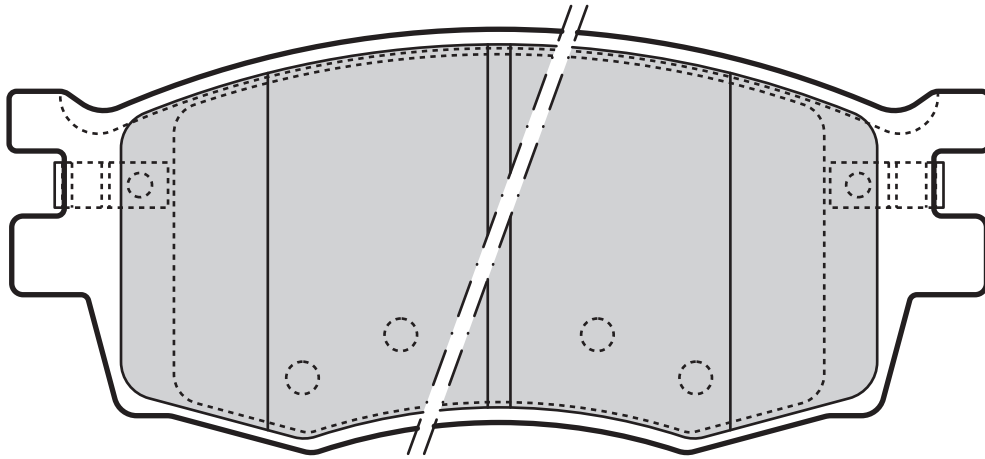

2



129,6



56



18



MANDO



HYUNDAI, KIA

598868

24320 (WVA)

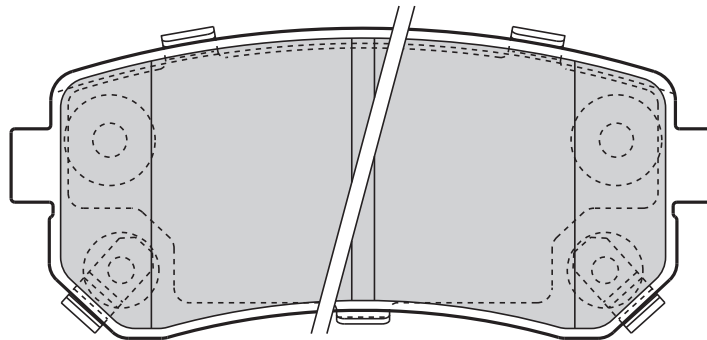

2



92,9



41



15,9



MANDO



HYUNDAI, KIA

598867



24323 (WVA)

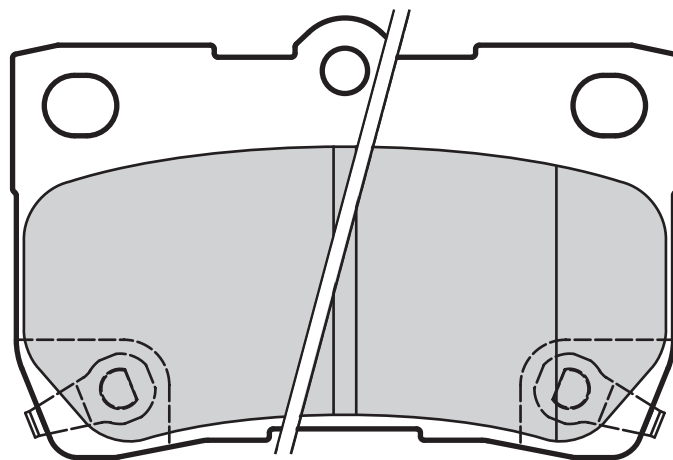
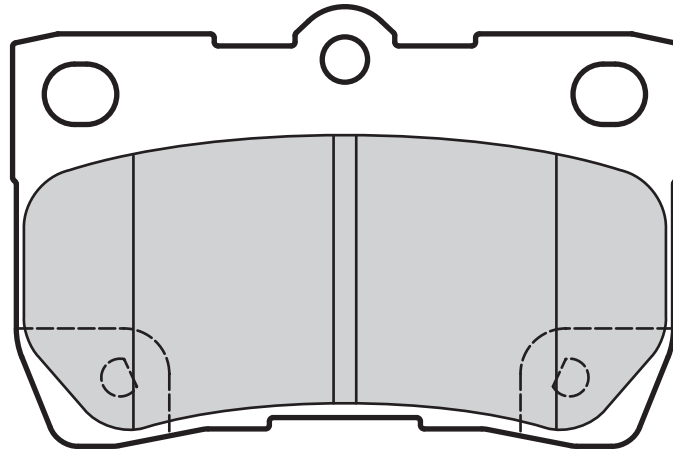

Valeo



Valeo



Leaf



88



58,2



15,5



AKEBONO



LEXUS

598888

2

24331 (WVA)

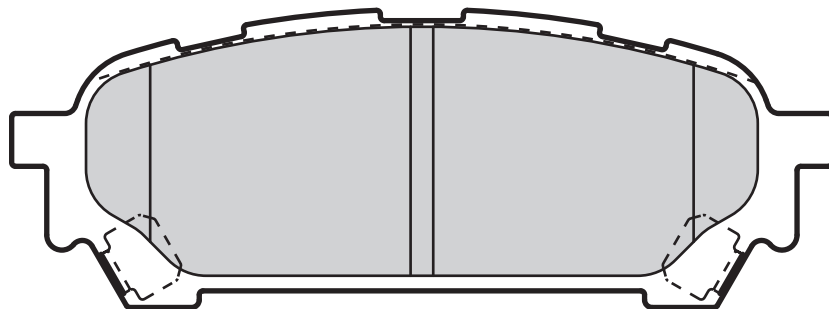

Valeo



Valeo



108,5



39,3



13,8



AKEBONO



SUBARU

598875

2

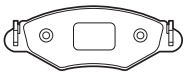

Valeo

24333 (WVA)

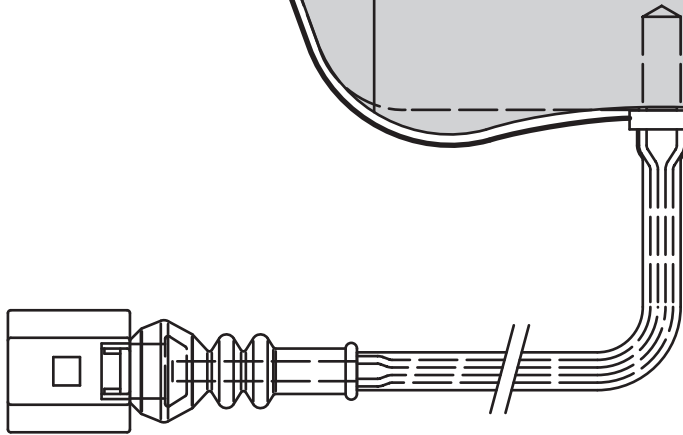
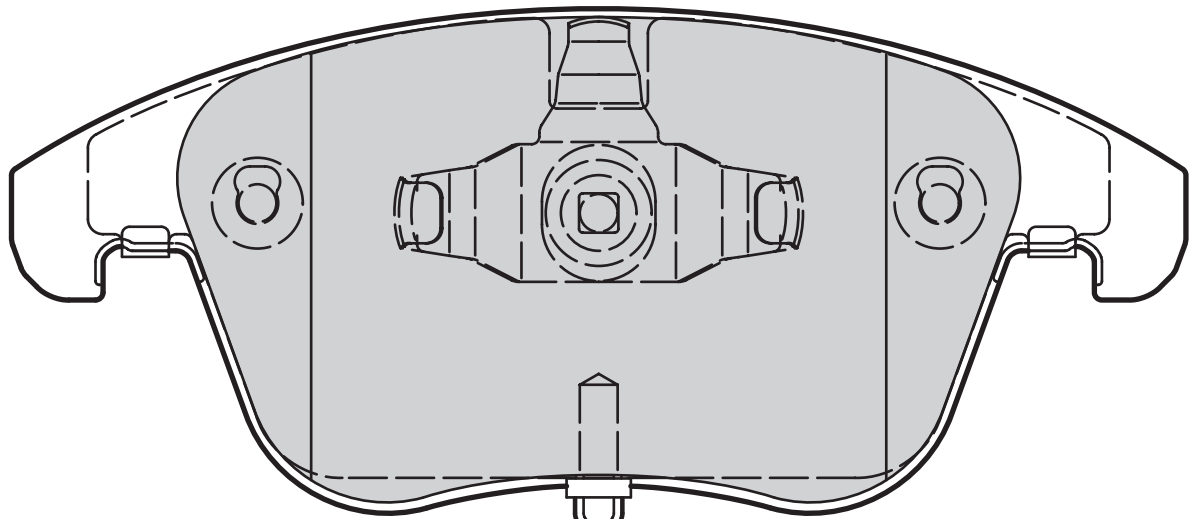
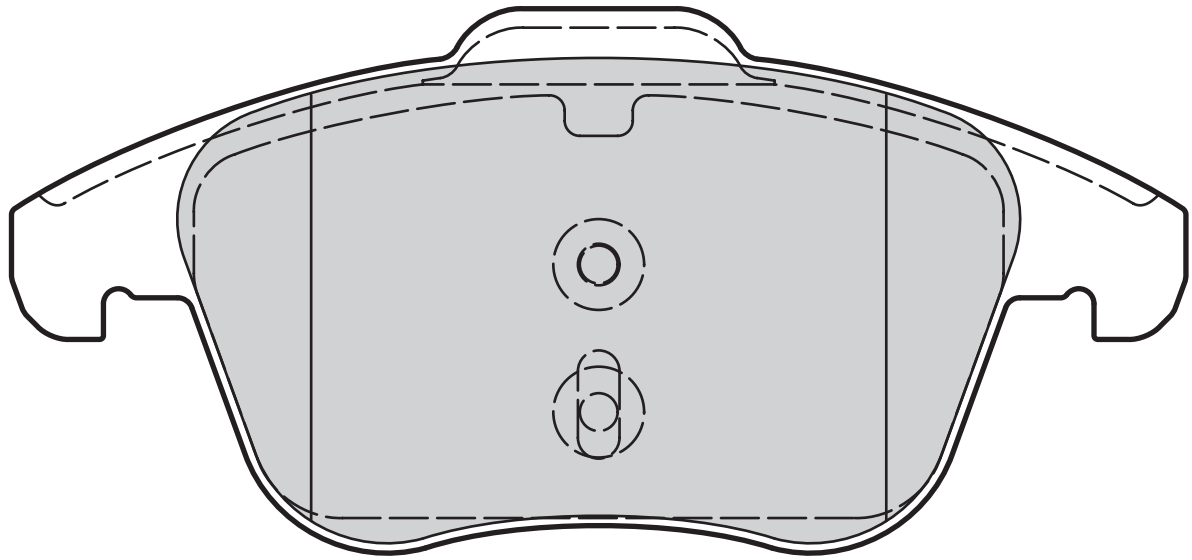

Valeo



Valeo



601036

1

165

155,2

72

19,8

TEVES

VOLKSWAGEN



24336 (WVA)

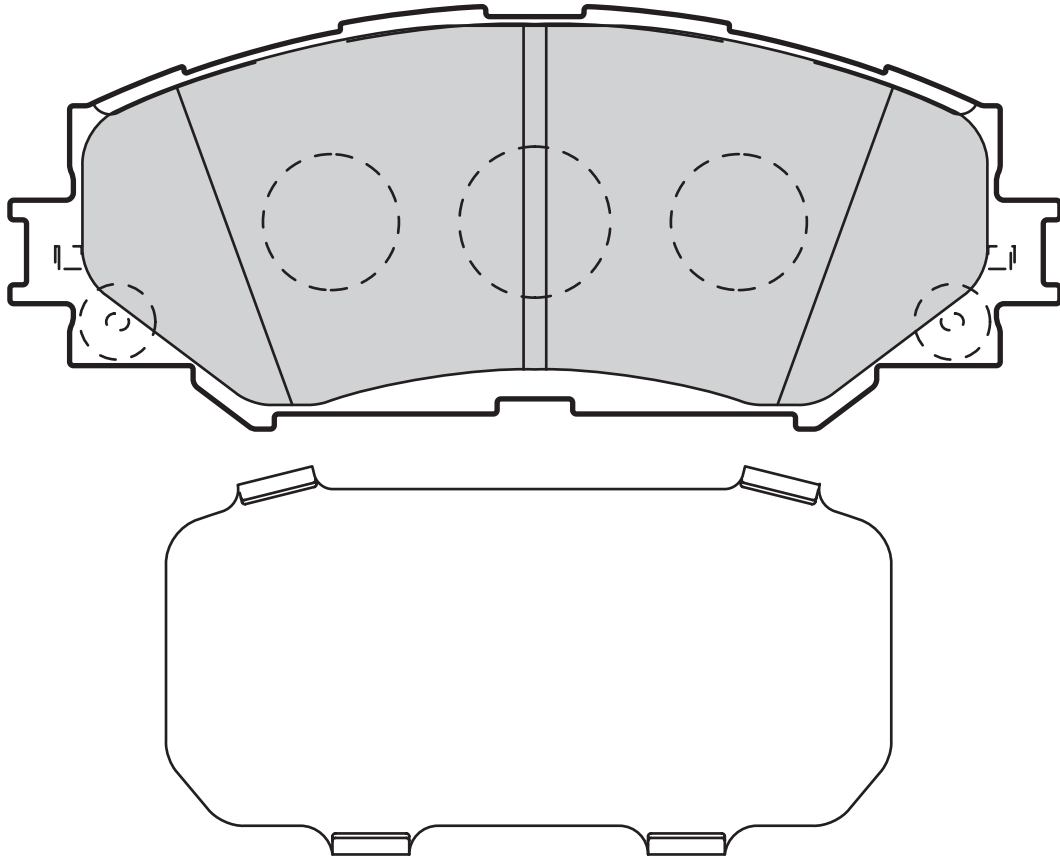

Valeo



Valeo



598943

0

139

56

17

AKEBONO

TOYOTA

24337 (WVA)

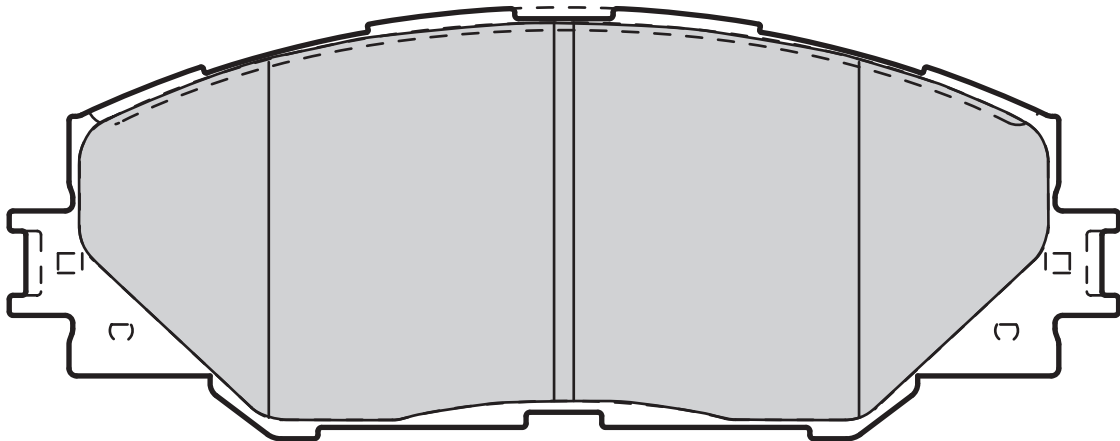

Valeo



Valeo



601037

0

146,6

57

17,5

SUMITOMO

TOYOTA



Valeo

24338 (WVA)

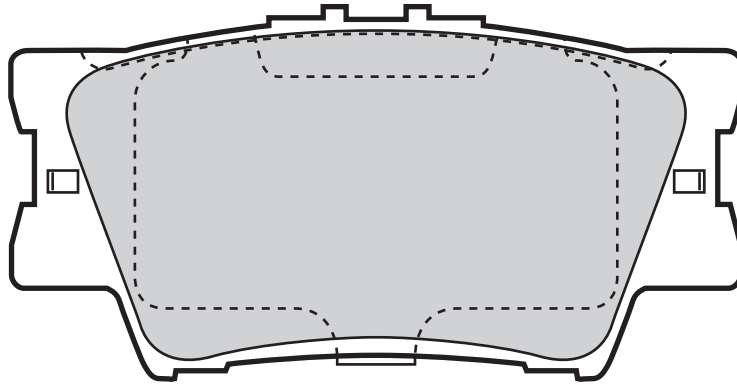

598819	0	96,6	49,2	15,4	AKEBONO	TOYOTA		

24346 (WVA)

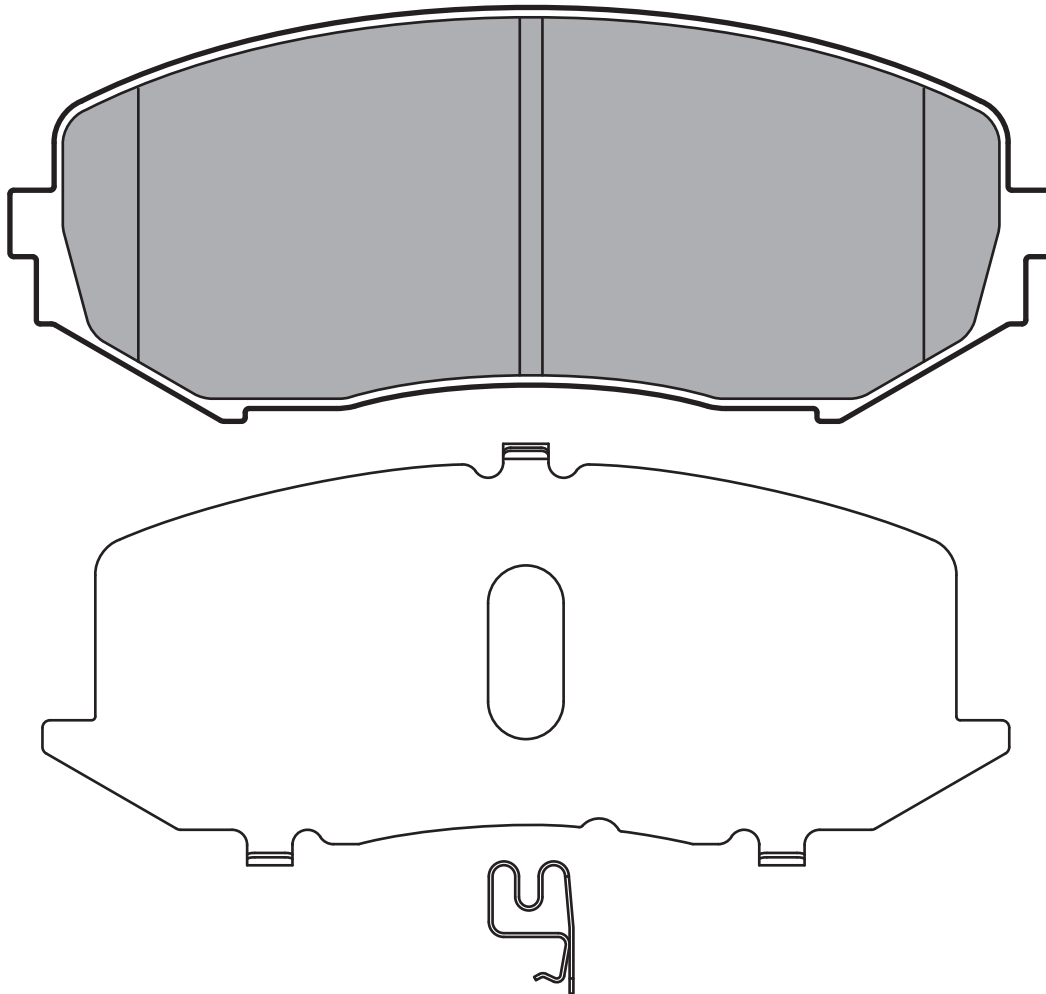

598877	2	137,9	54,7	17,1	AKEBONO	SUZUKI		

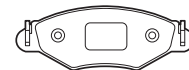

24347 (WVA)

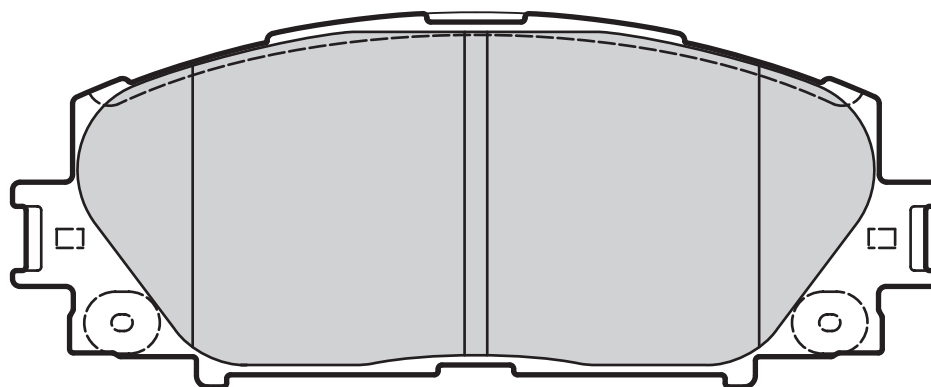

Valeo



Valeo



598896

0

122,6

49,5

18,2

AKEBONO

TOYOTA

24348 (WVA)

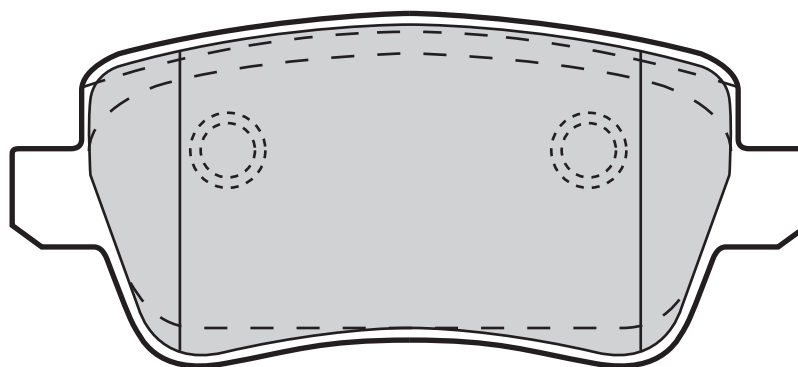

Valeo



Valeo



598727

0

105,5

46,6

16,4

LUCAS

FIAT

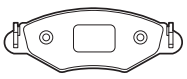

Valeo

24349 (WVA)

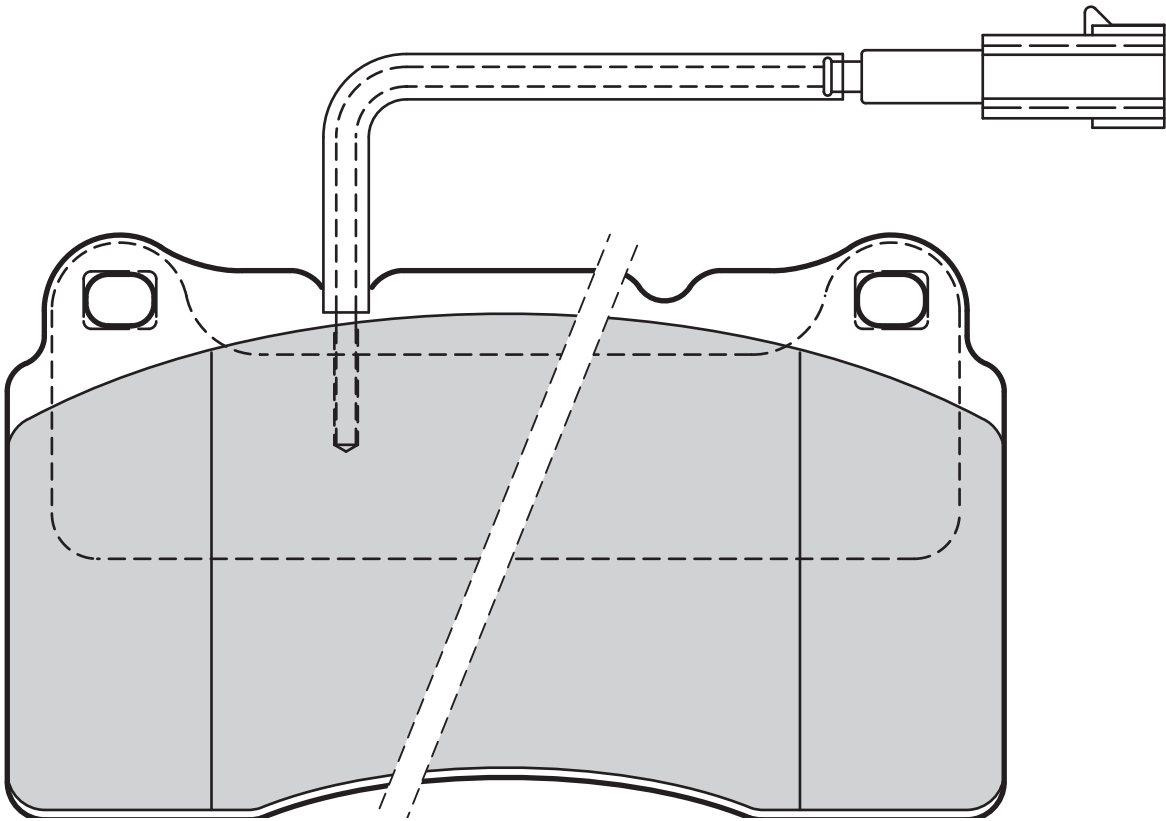
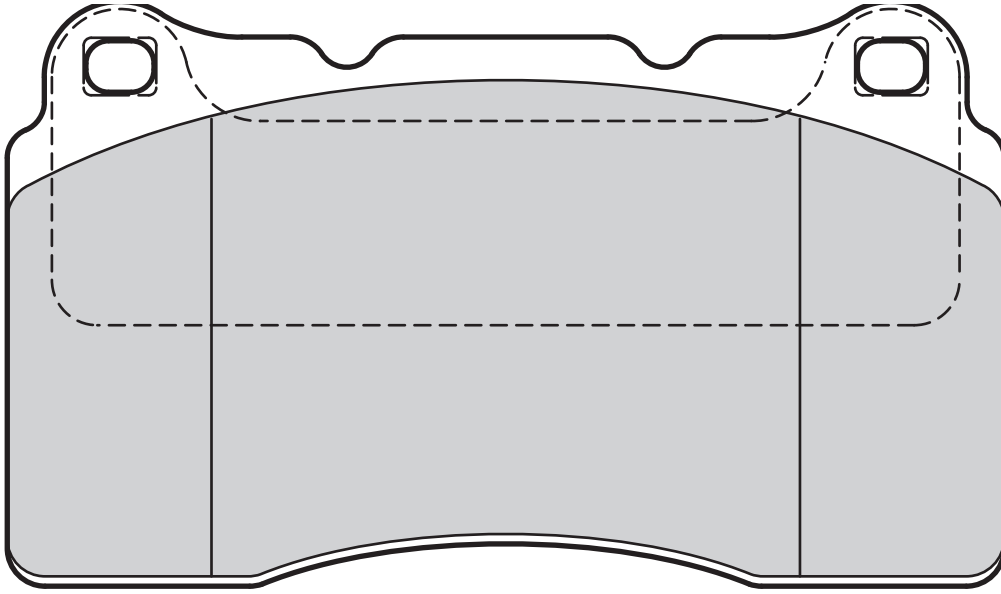

Valeo



Valeo



598722

0

101,7

47,4

17,2

BOSCH

ABARTH, FIAT, OPEL, VAUXHALL

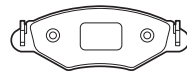

24350 (WVA)

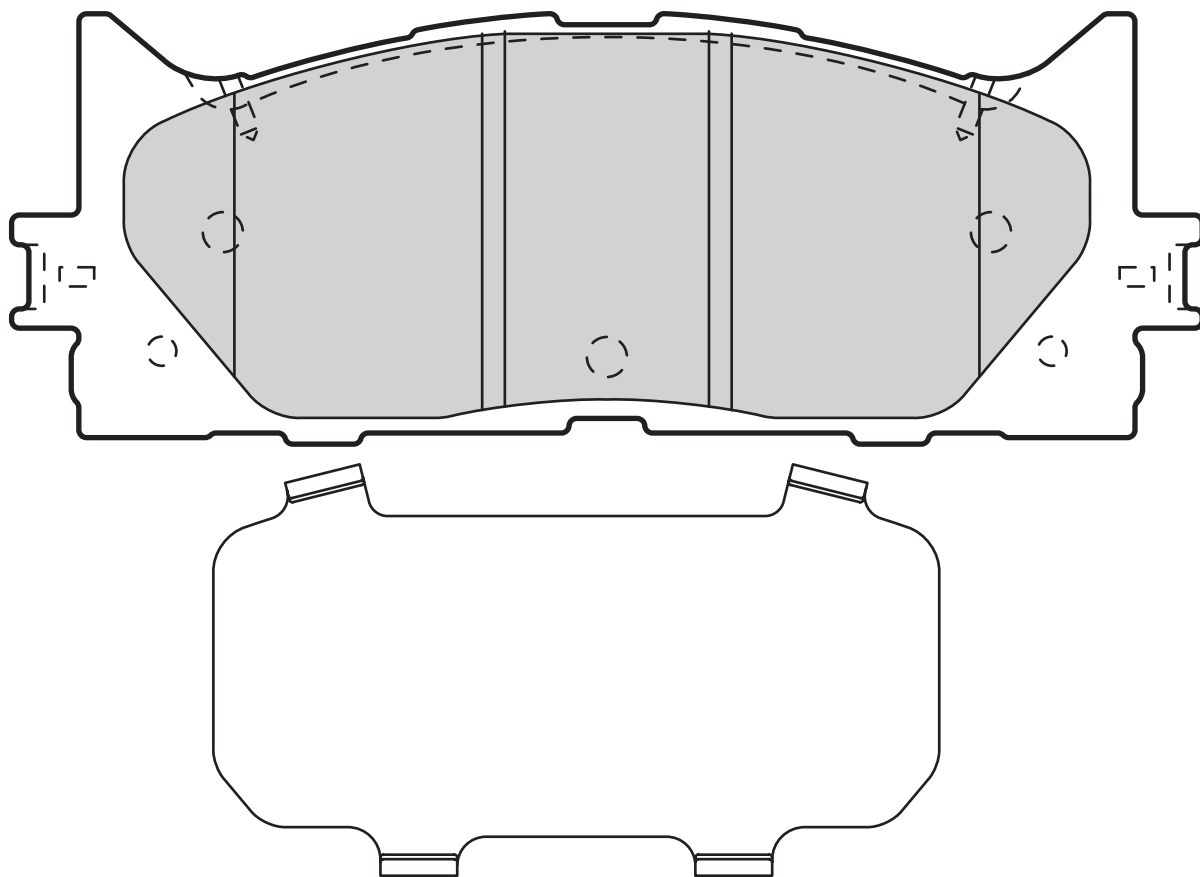

598890

0

157,5

57

17,6

AKEBONO

TOYOTA

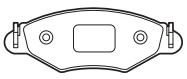

24351 (WVA)

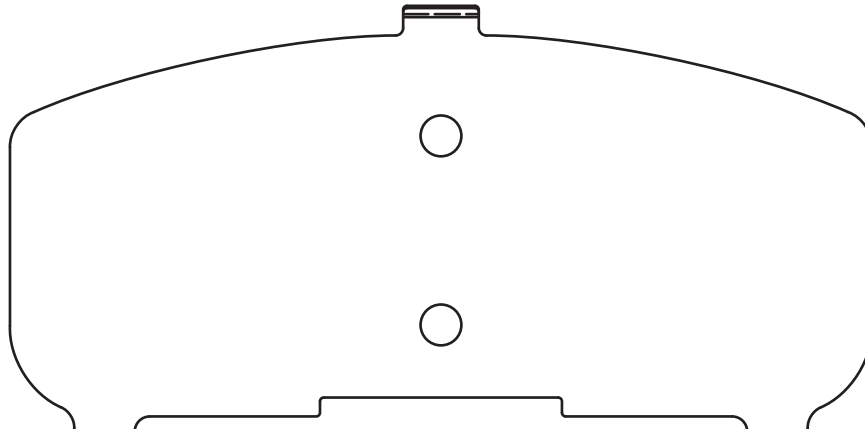
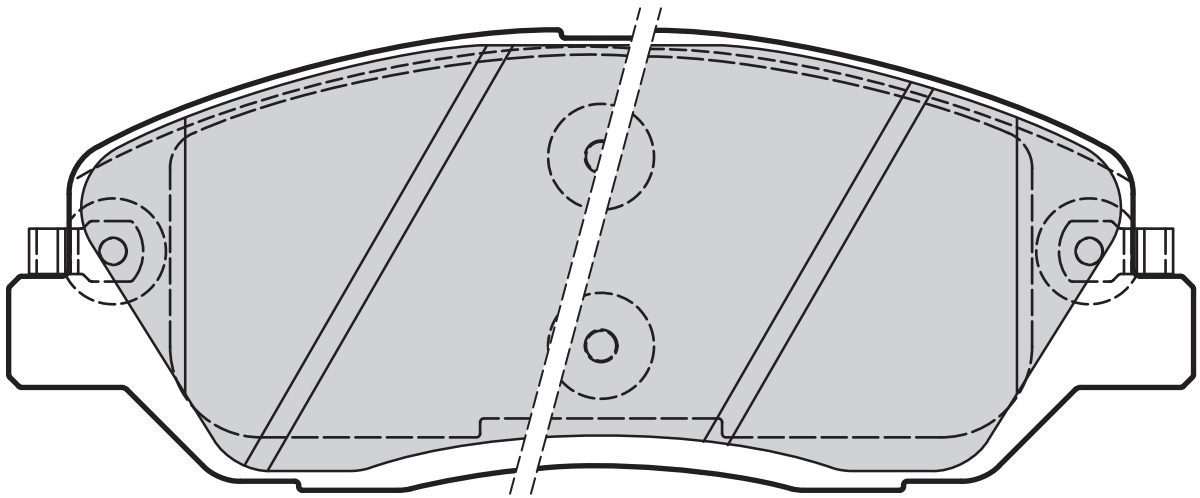
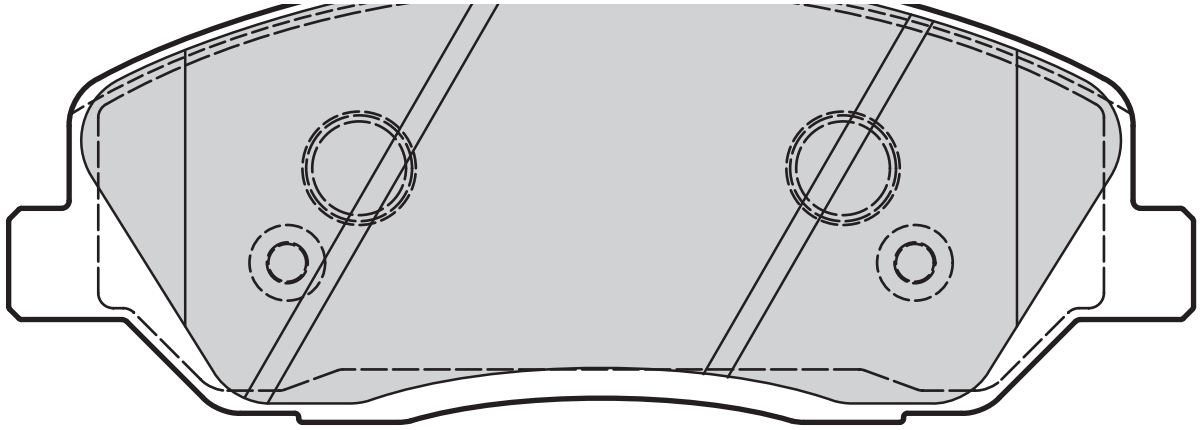

2



156



60



17



MANDO



HYUNDAI



598937



24367 (WVA)

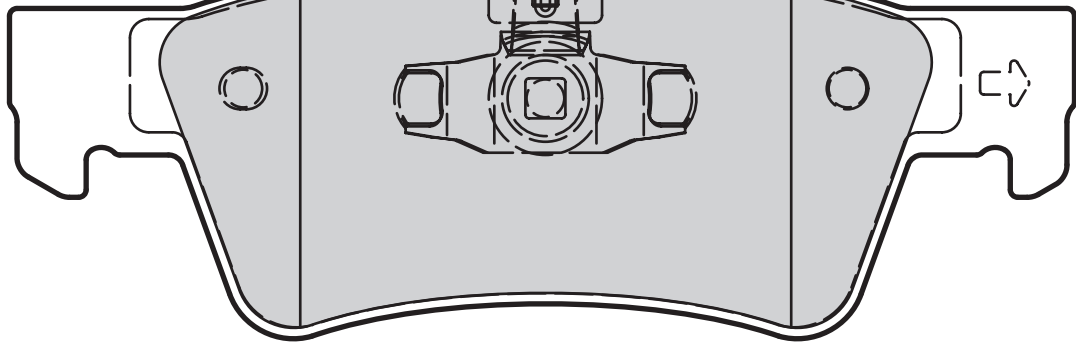
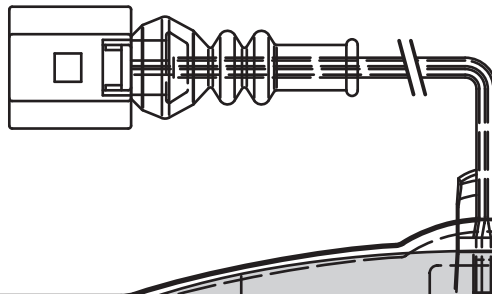
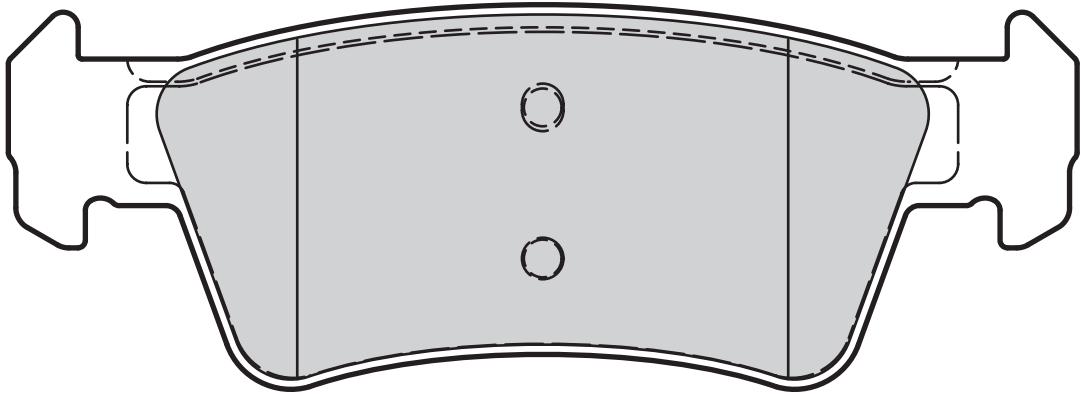

Valeo



Valeo



598946
598967

2
0

Leaf

140/141
140,7

51/54
54

19
19,1

TEVES
TEVES

VOLKSWAGEN
VOLKSWAGEN



24369 (WVA)

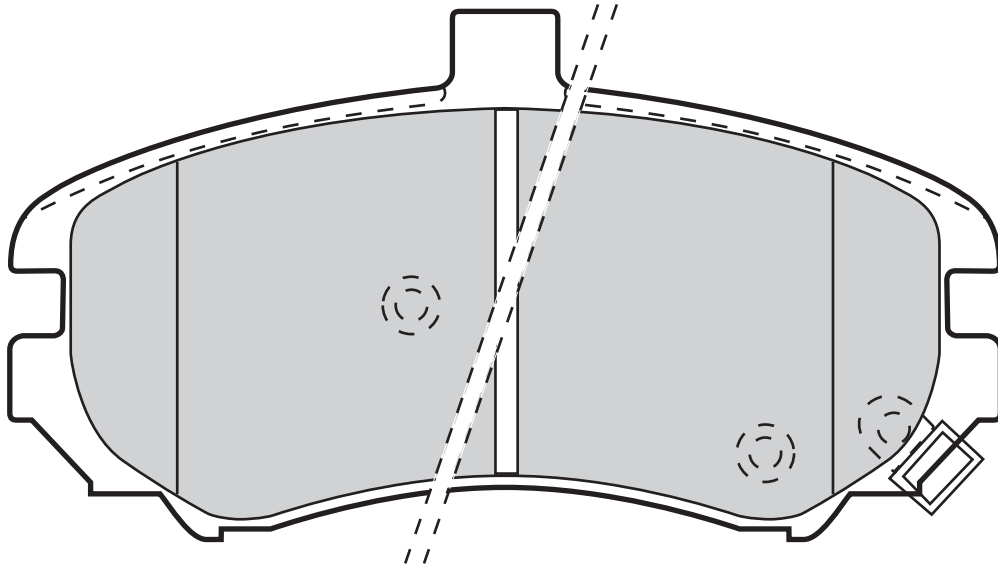

Valeo



2

Valeo



131



70



17,2



MANDO



HYUNDAI

598739

24391 (WVA)

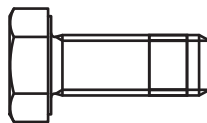
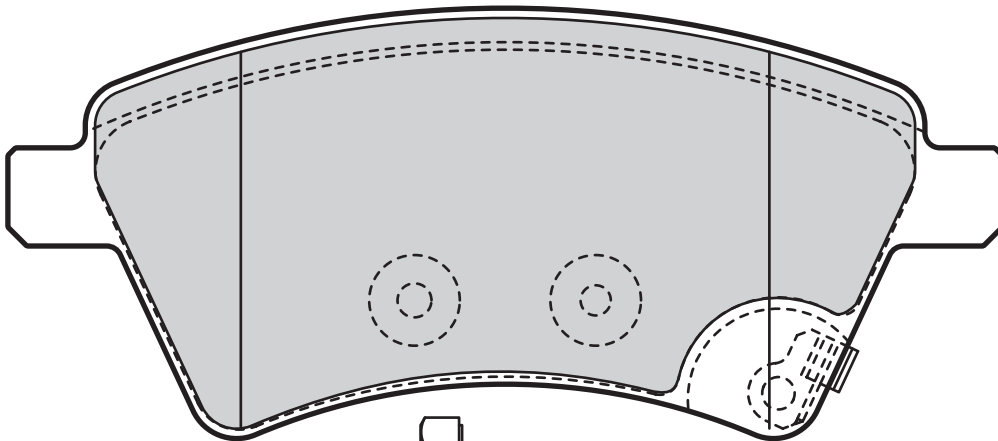

Valeo



1

Valeo



131,5



56,9



16



LUCAS



FIAT, SUZUKI

598804



24412 (WVA)

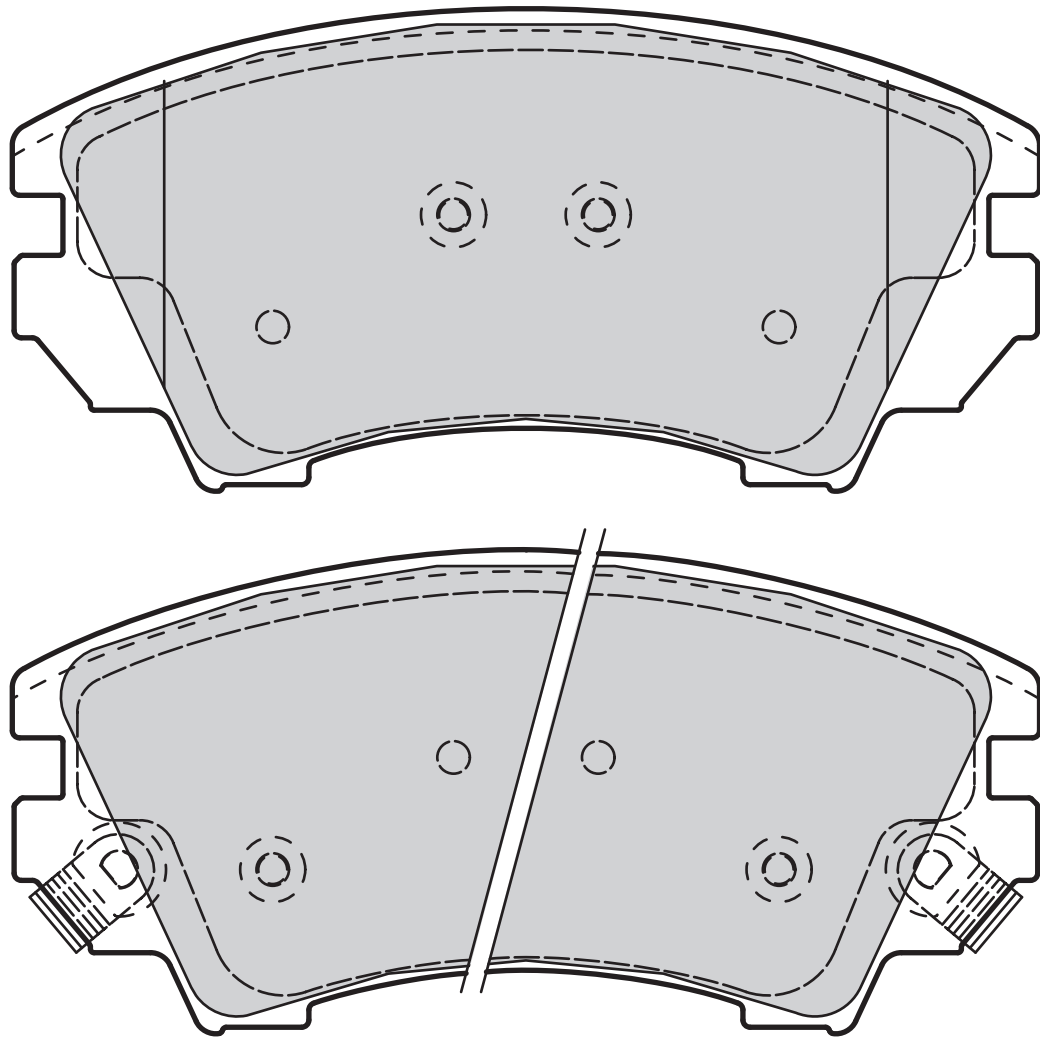

Valeo



Valeo



601046

2

Leaf

142

66,7

18,8

MANDO

OPEL, VAUXHALL

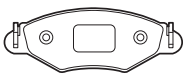

Valeo

24415 (WVA)

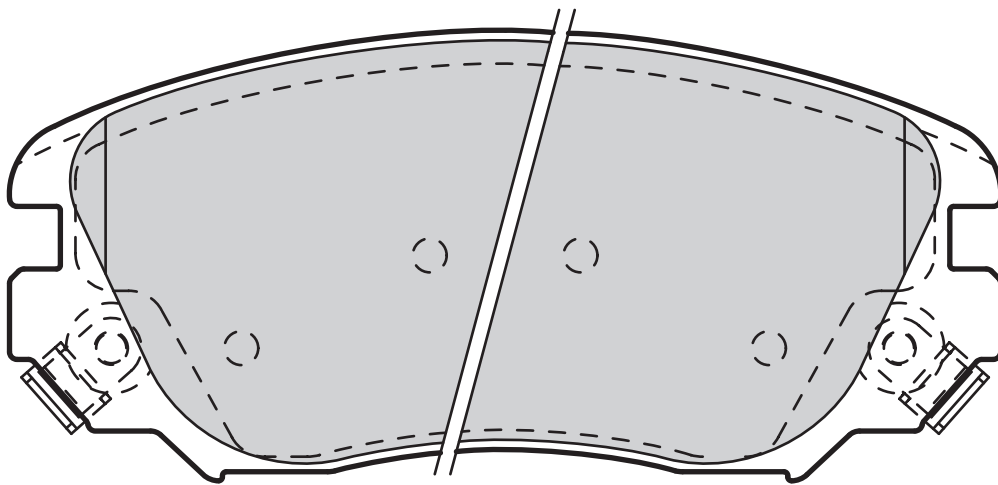
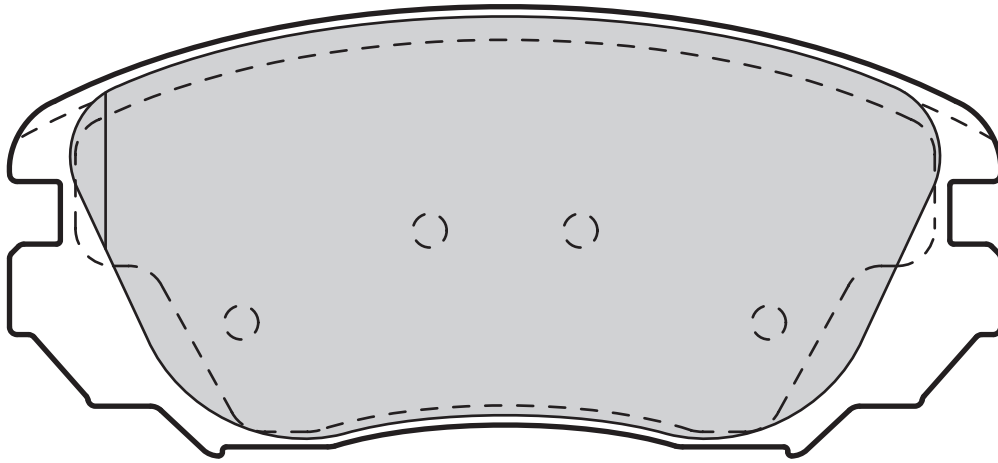

Valeo



Valeo



601047

2

Leaf

131,5

59,6

19

MANDO

OPEL, VAUXHALL



24418 (WVA)

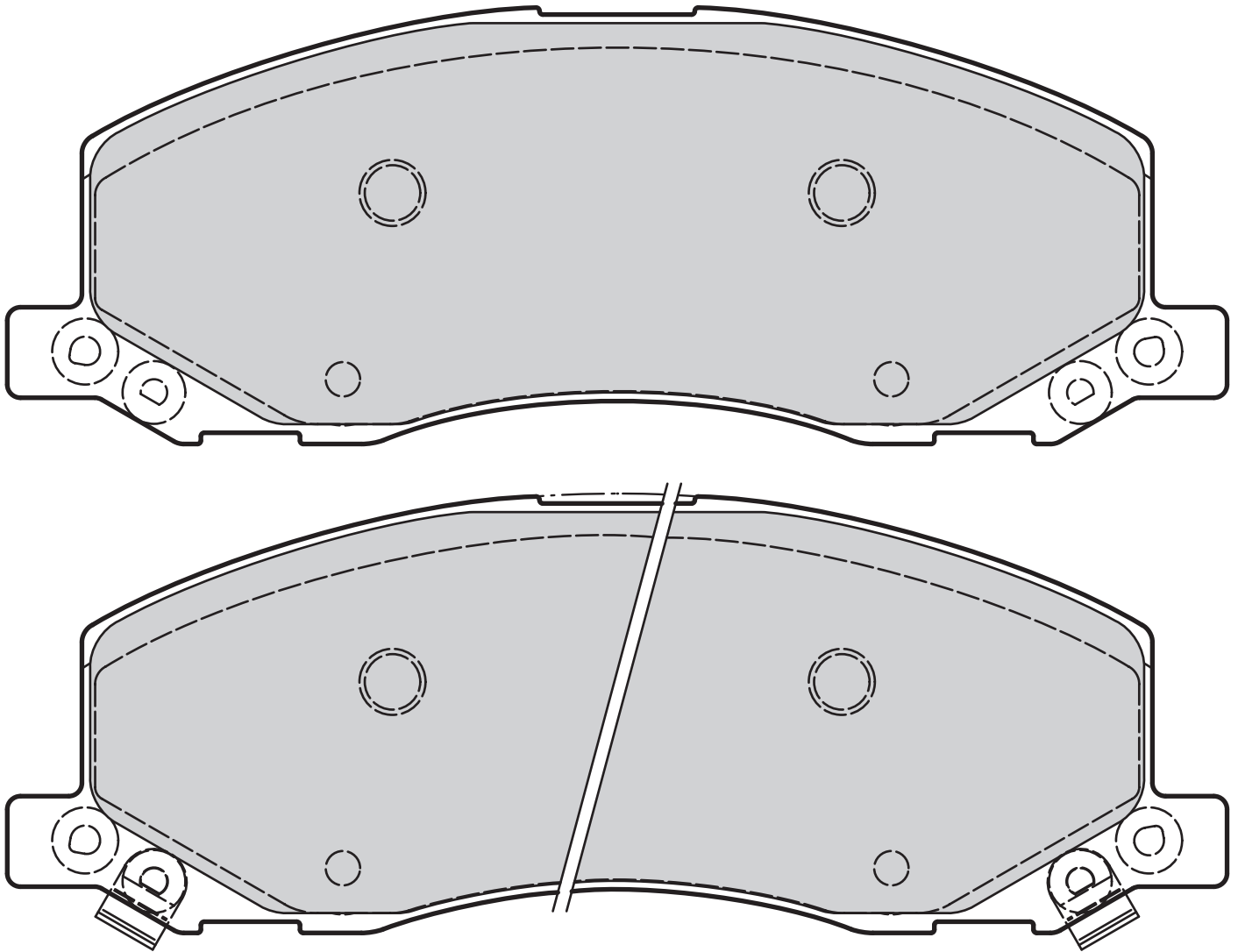

Valeo



Valeo



601048

2

Leaf

184,6

66,5

17

TRW

OPEL, VAUXHALL



24421 (WVA)

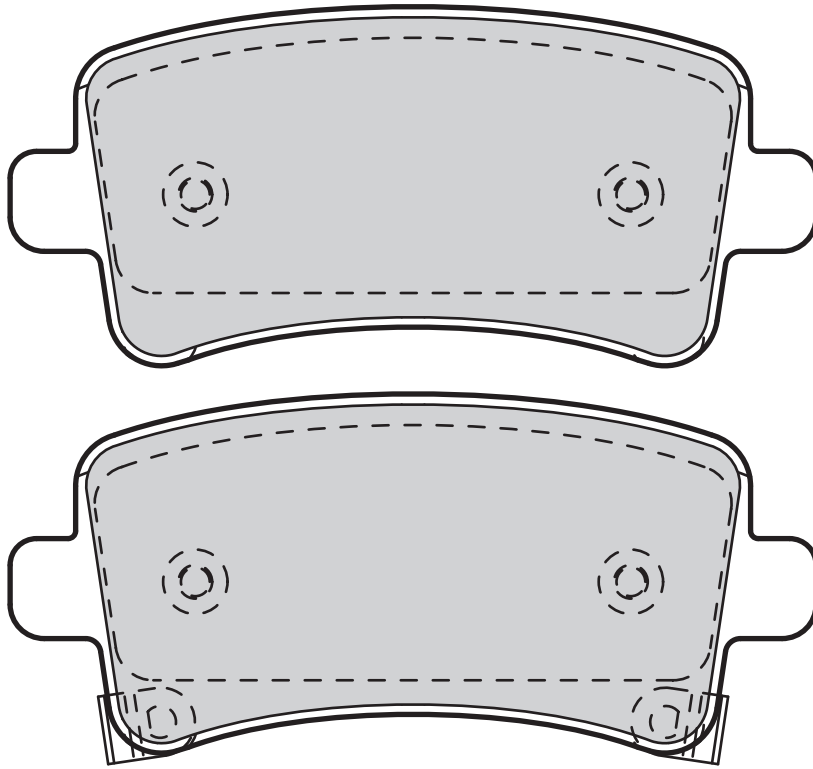

Valeo



4

Valeo



Leaf



160,4



47,4



17,3



TRW



OPEL, VAUXHALL

601049

24462 (WVA)

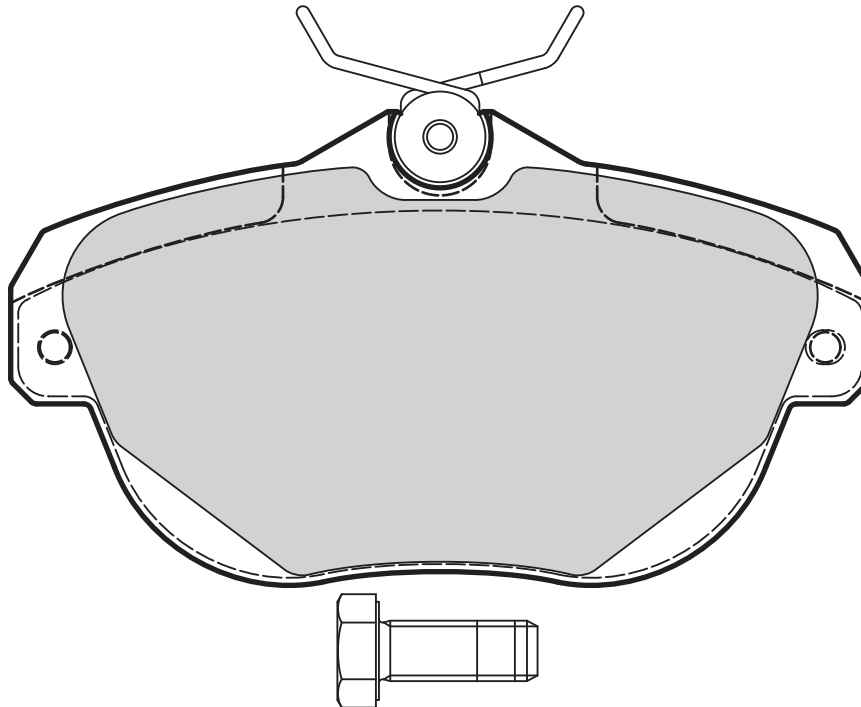

Valeo



1

Valeo



114



63



17



LUCAS



CITROËN

598939

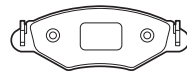

24464 (WVA)

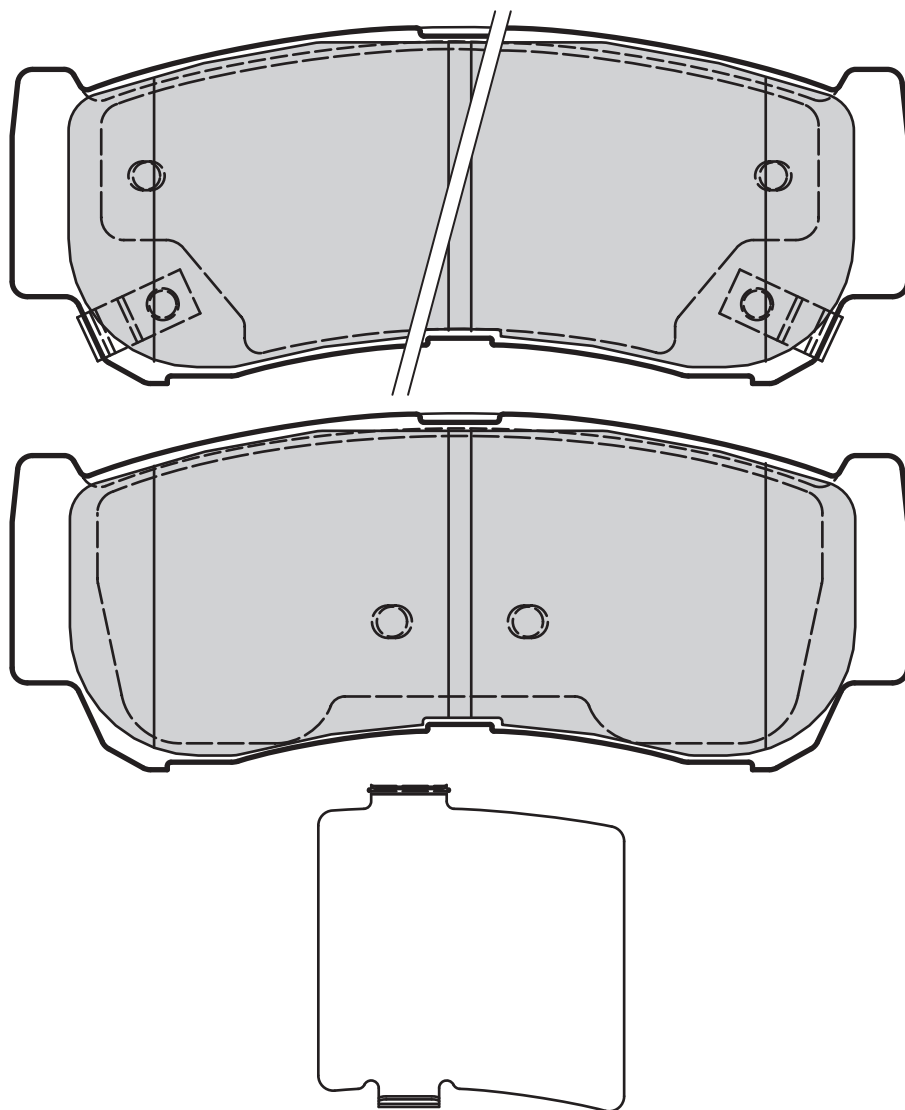

Valeo



Valeo



598932

2

Leaf

118,5

47

15,5

MANDO

HYUNDAI

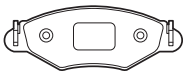

Valeo

24465 (WVA)

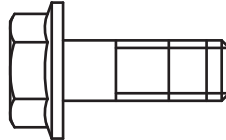
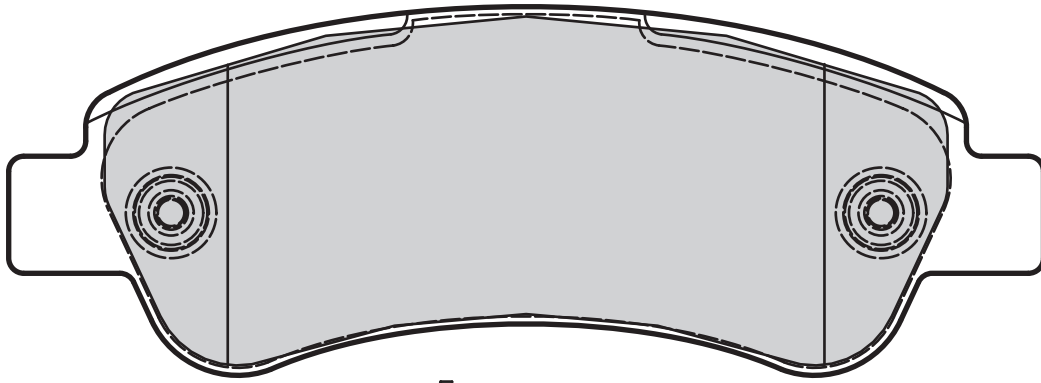

Valeo



Valeo



598892

0

136,8

48,9

19

BOSCH

CITROËN, FIAT, PEUGEOT

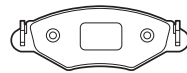

24468 (WVA)

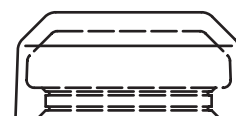
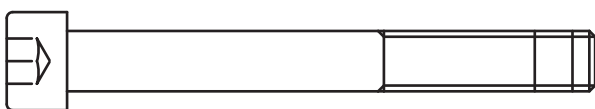
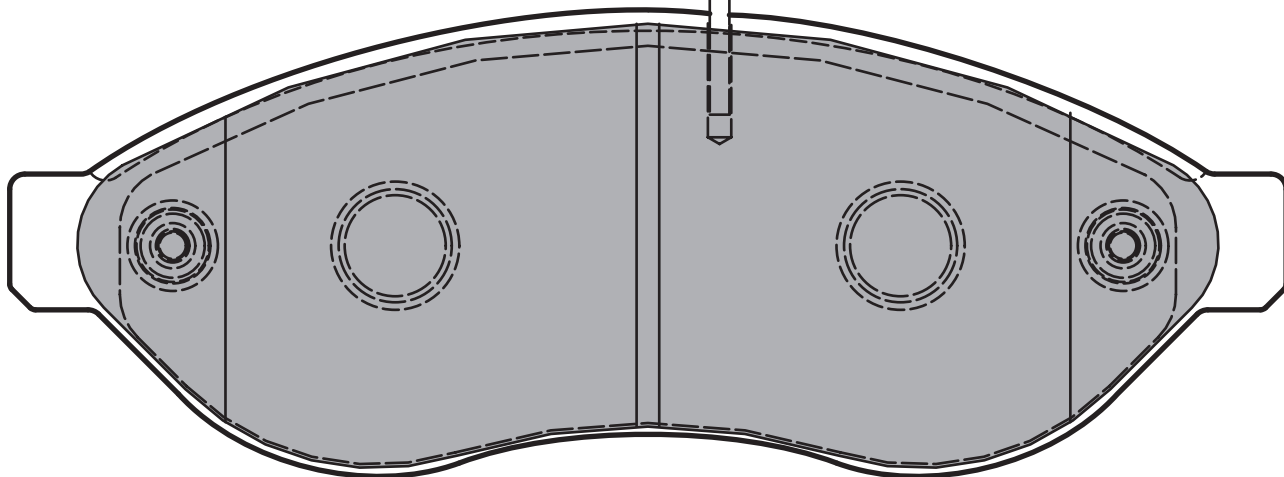
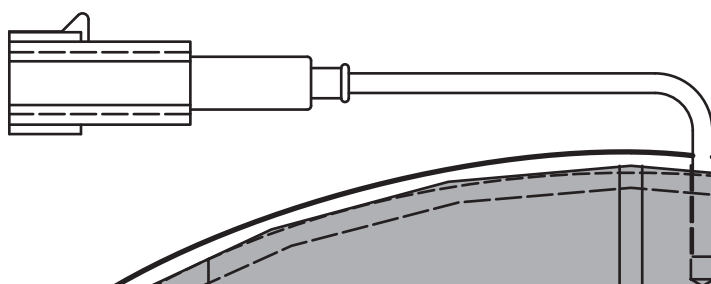
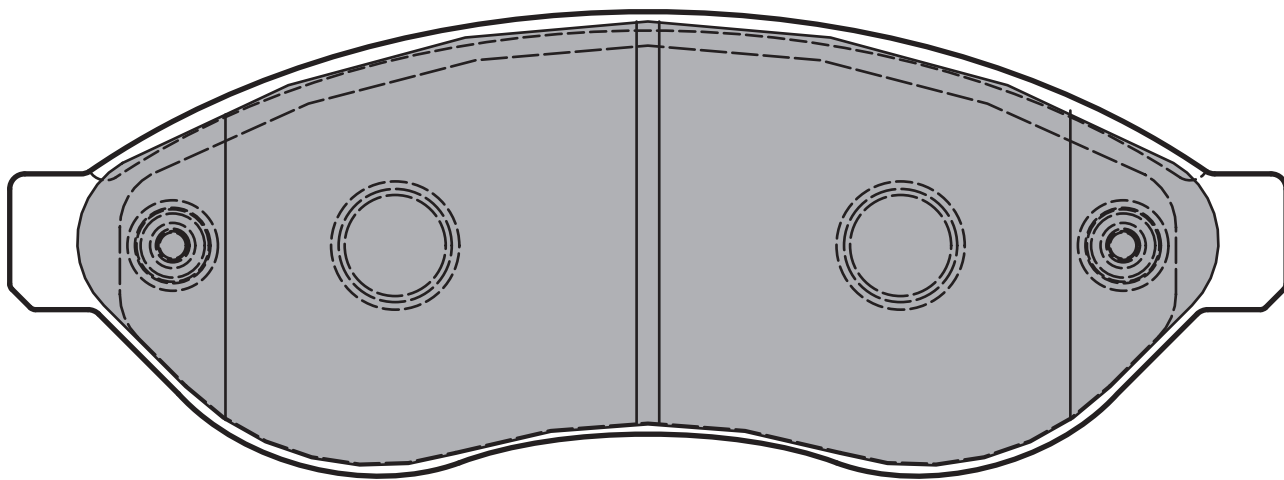

Valeo



Valeo



598891

1

160

169

61

19

BREMBO

CITROËN, FIAT, PEUGEOT

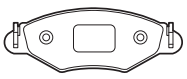

Valeo

24486 (WVA)

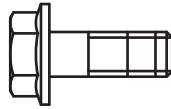
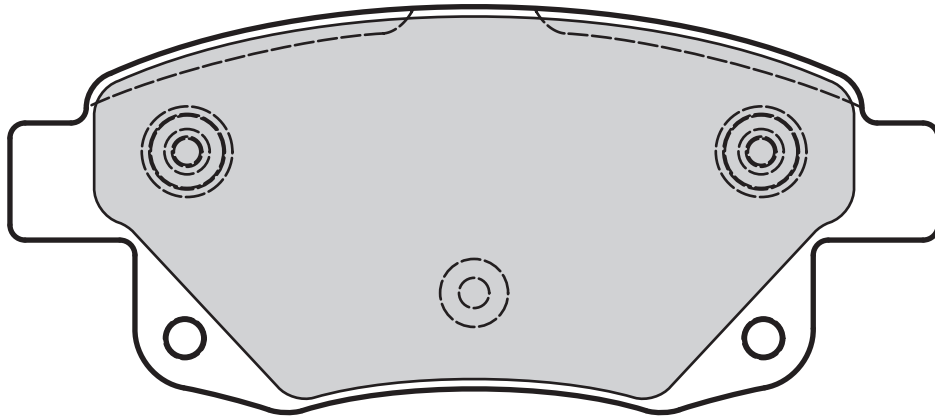

Valeo



Valeo



541736

2

430

122,9

53,7

17

BOSCH

FORD

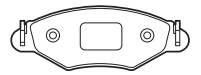

24491 (WVA)

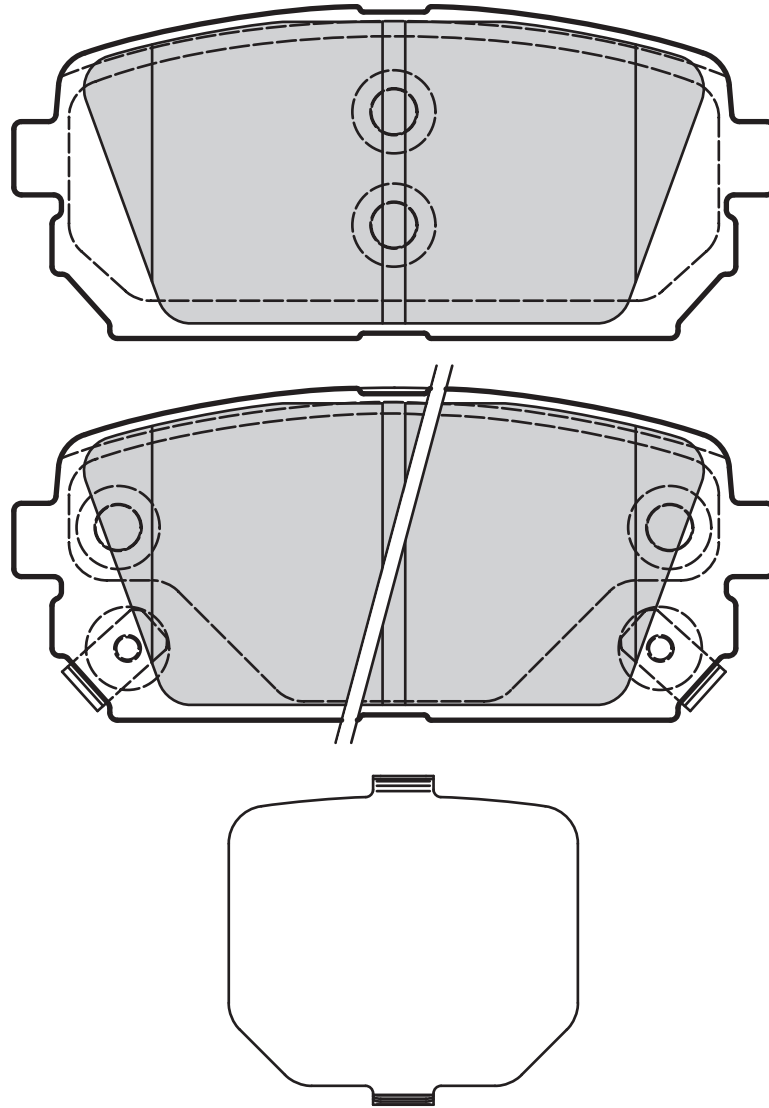

Valeo



Valeo



Leaf



100



44



15



MANDO



KIA

598945

1

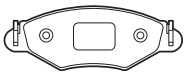

Valeo

24496 (WVA)

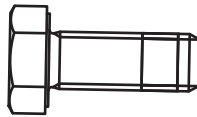
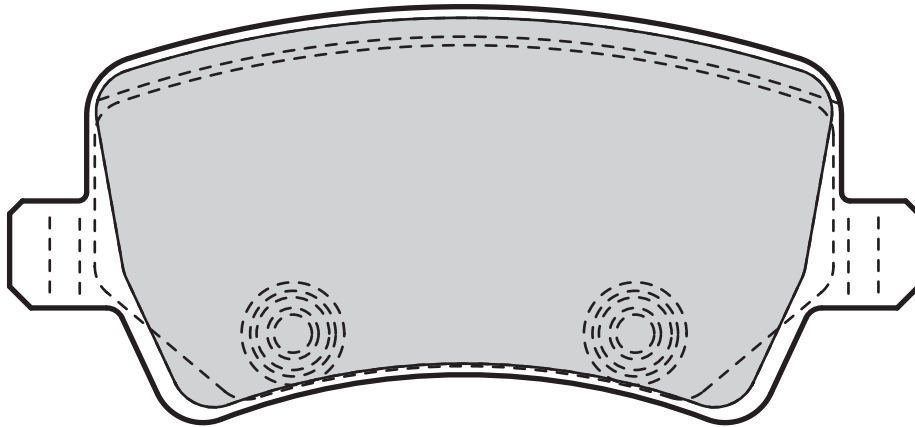

Valeo



Valeo



598928

0

106

48,4

17

LUCAS

FORD, VOLVO

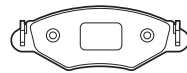

24498 (WVA)

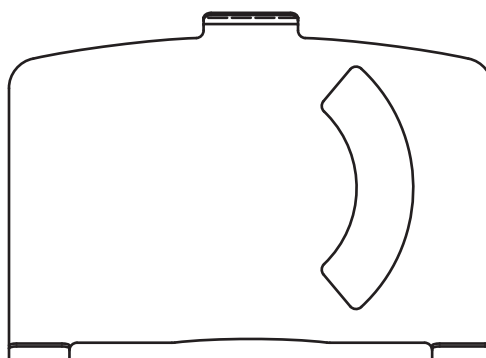
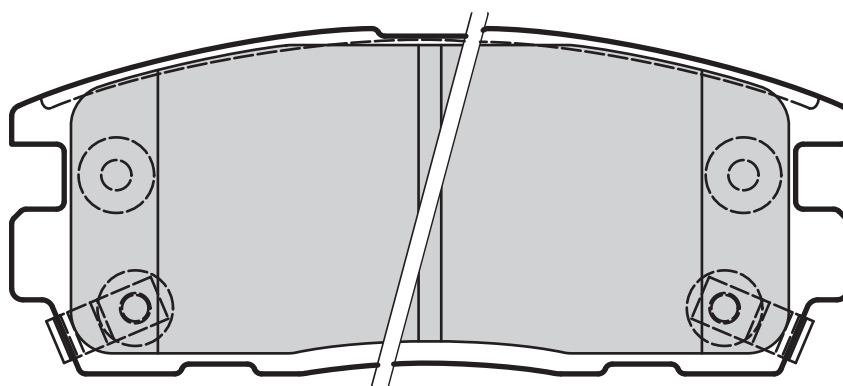
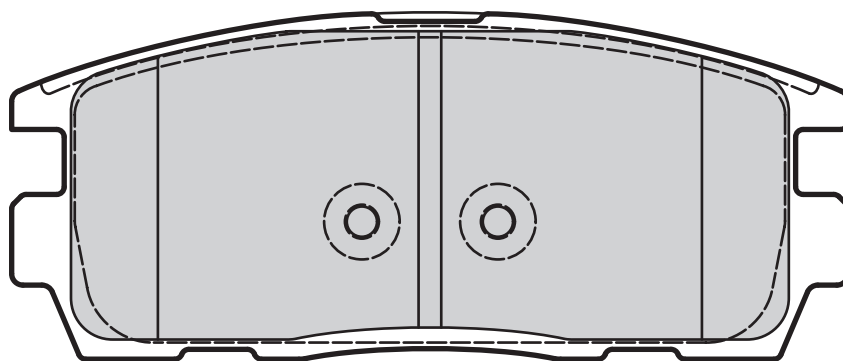

Valeo



Valeo



598941

2

Leaf

110

46

15

AKEBONO

CHEVROLET, OPEL, VAUXHALL

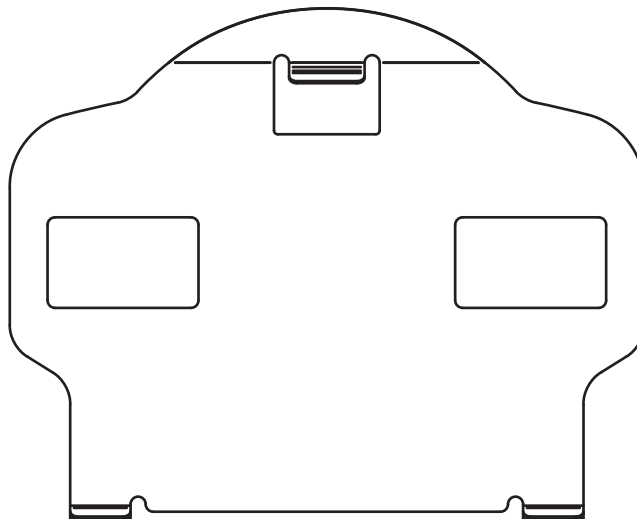
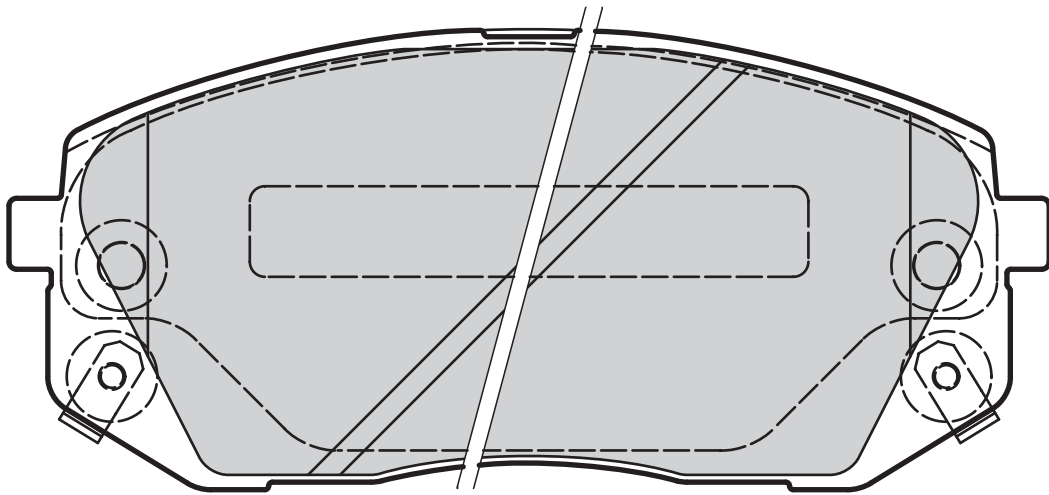
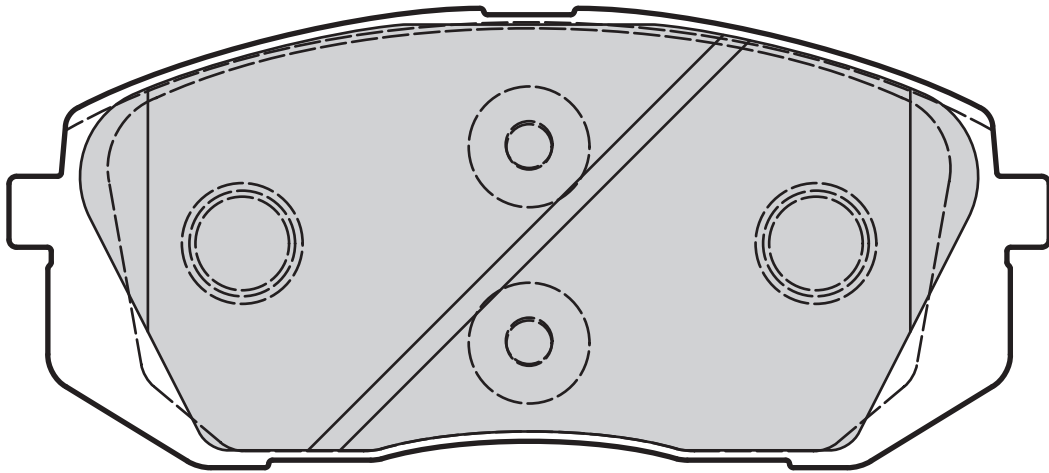
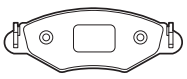



24510 (WVA)

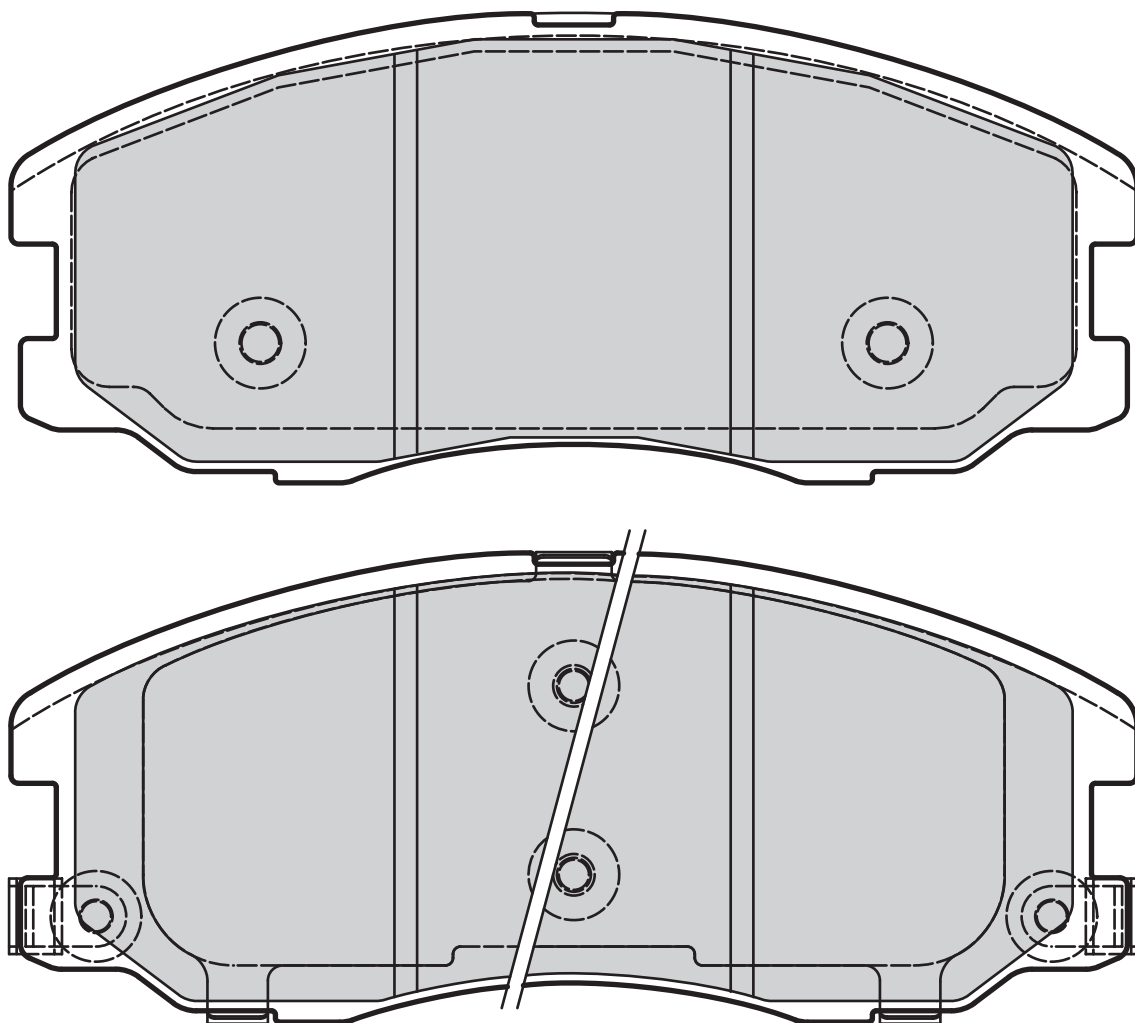

Valeo



2

Valeo



Leaf



149



62



17



MANDO



CHEVROLET, OPEL, VAUXHALL

598942



24529 (WVA)

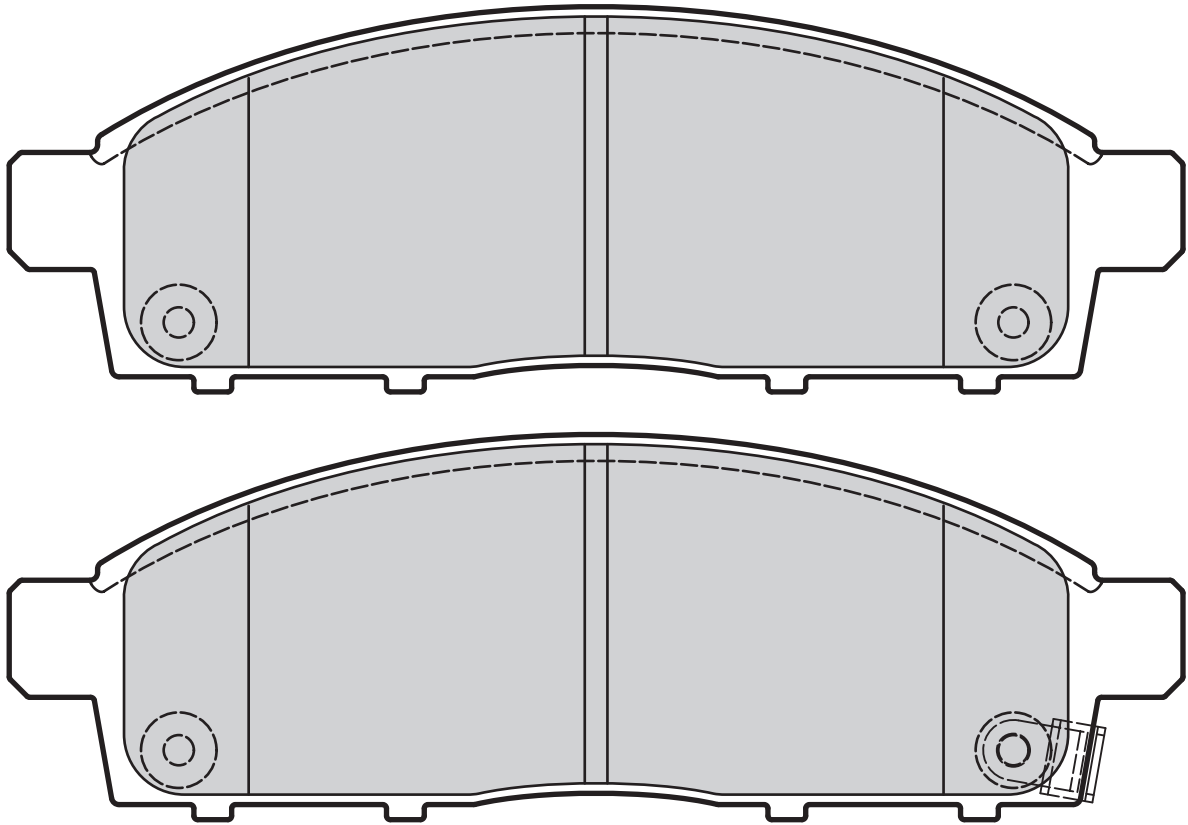

598893

2

Leaf

155

50,9

16

TOKICO

MITSUBISHI



24535 (WVA)

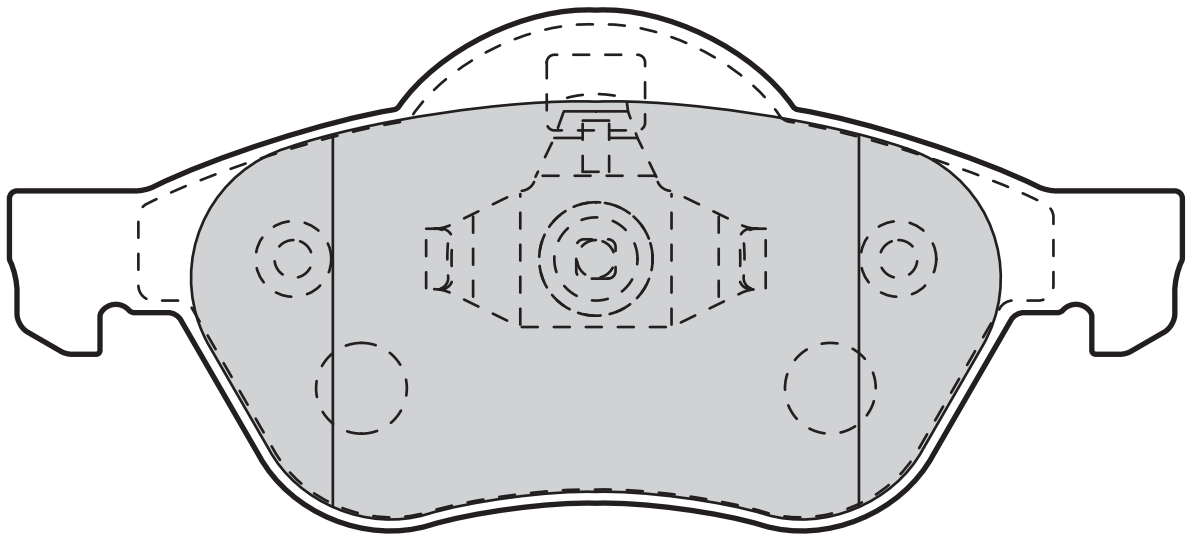
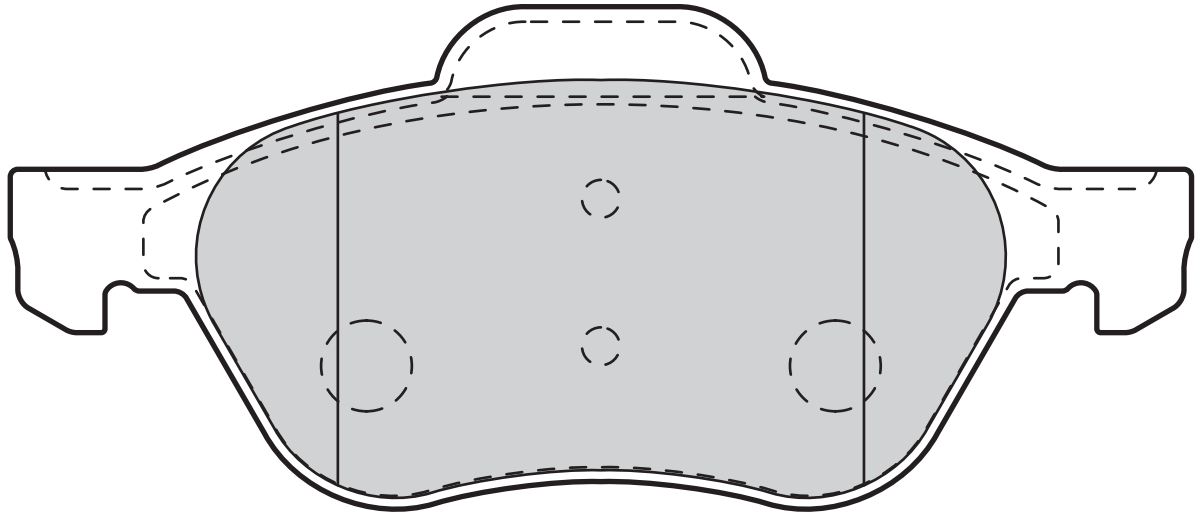

Valeo



0

Valeo



155,2



69



18,3



TEVES



RENAULT

601012

24537 (WVA)

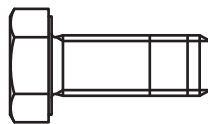
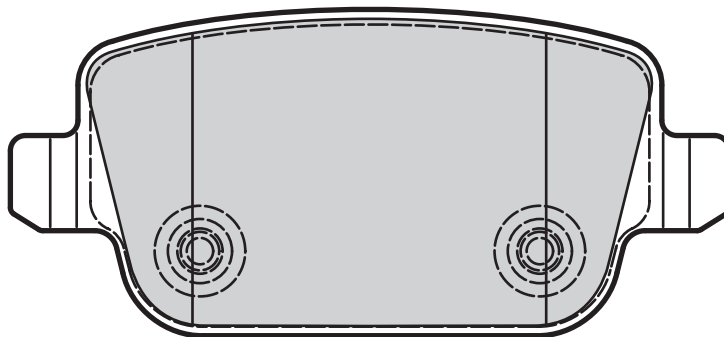

Valeo



0

Valeo



95



43



16



LUCAS



FORD, LAND ROVER

598935

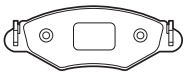

24538 (WVA)

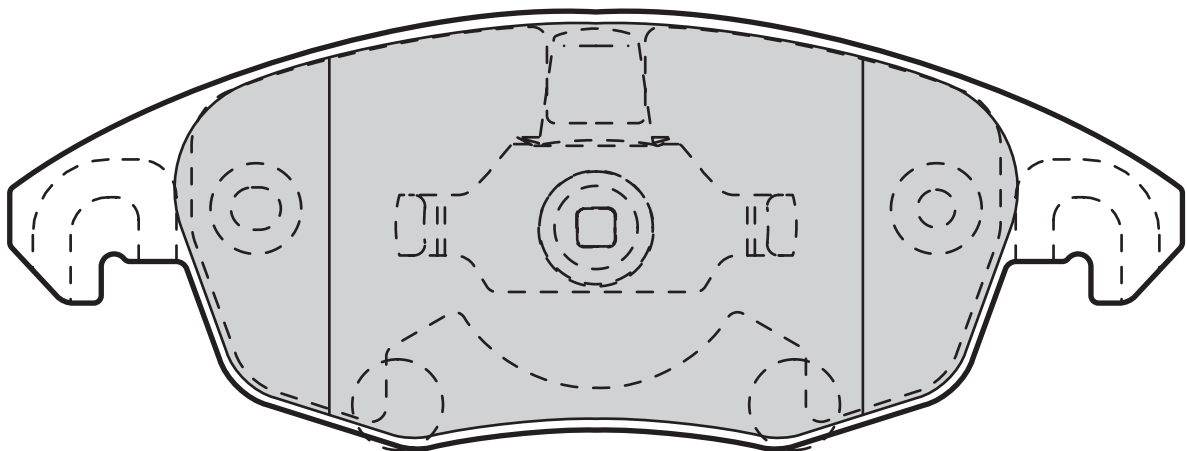
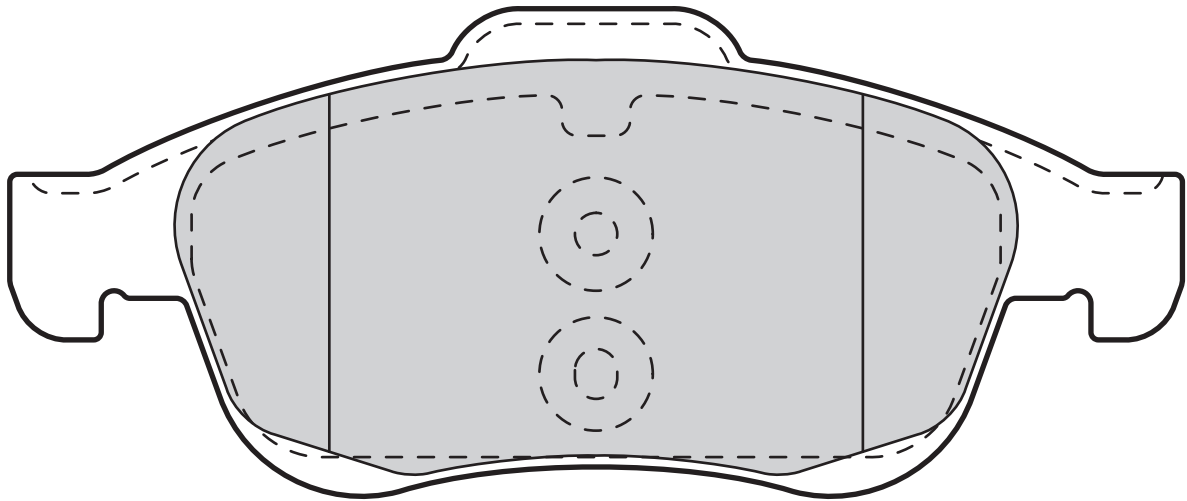

Valeo



0

Valeo



19,1



TEVES



CITROËN, PEUGEOT

598997

155,2

57,9

24540 (WVA)

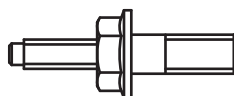
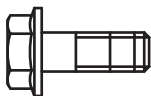
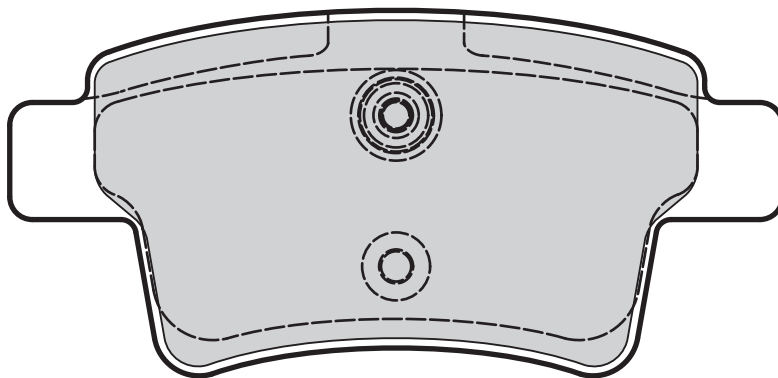

Valeo



0

Valeo



16



LUCAS



CITROËN

598936

102

48

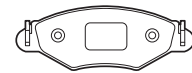

24557 (WVA)

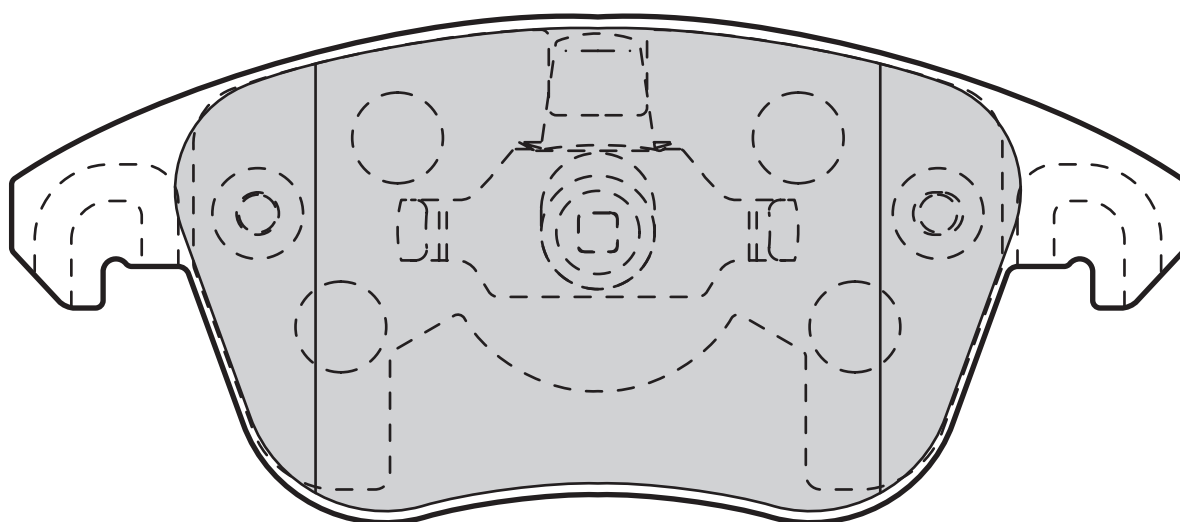
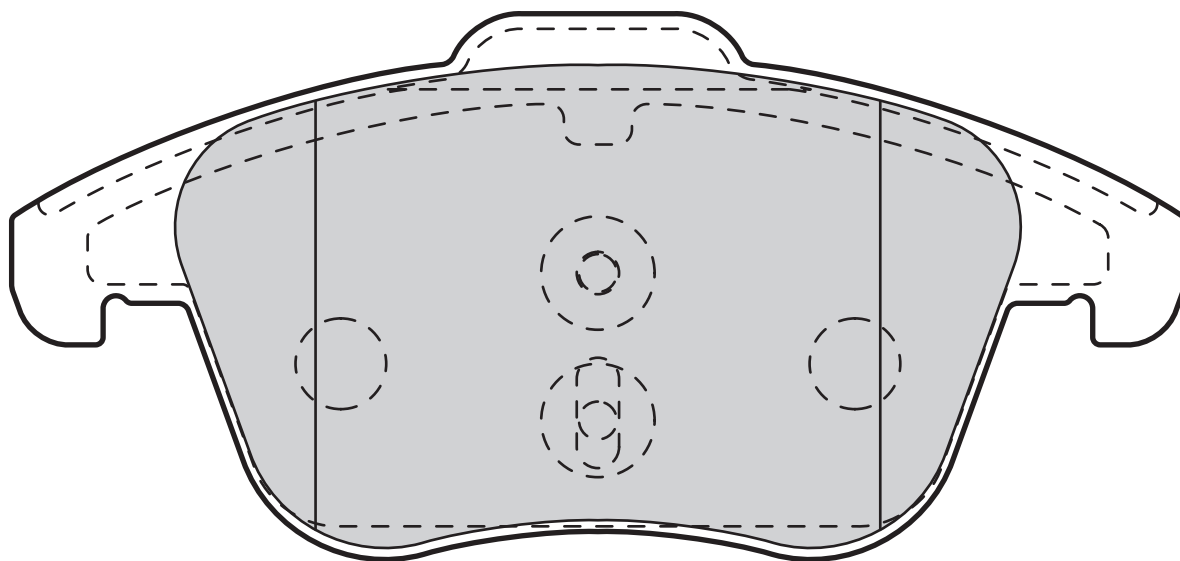

Valeo



Valeo



598998

0

155,2

67

19,5

TEVES

CITROËN, PEUGEOT



24574 (WVA)

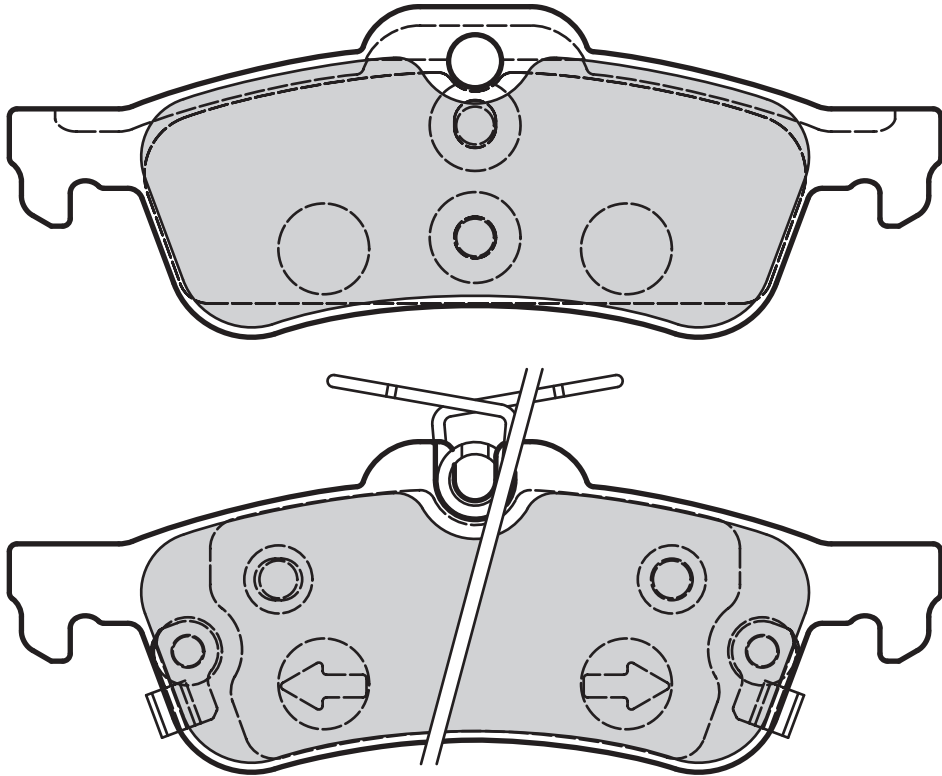

Valeo



Valeo



601028

2

Leaf

123,1

43,7

14,5

TEVES

TOYOTA

24578 (WVA)

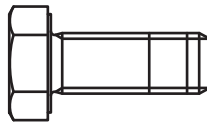
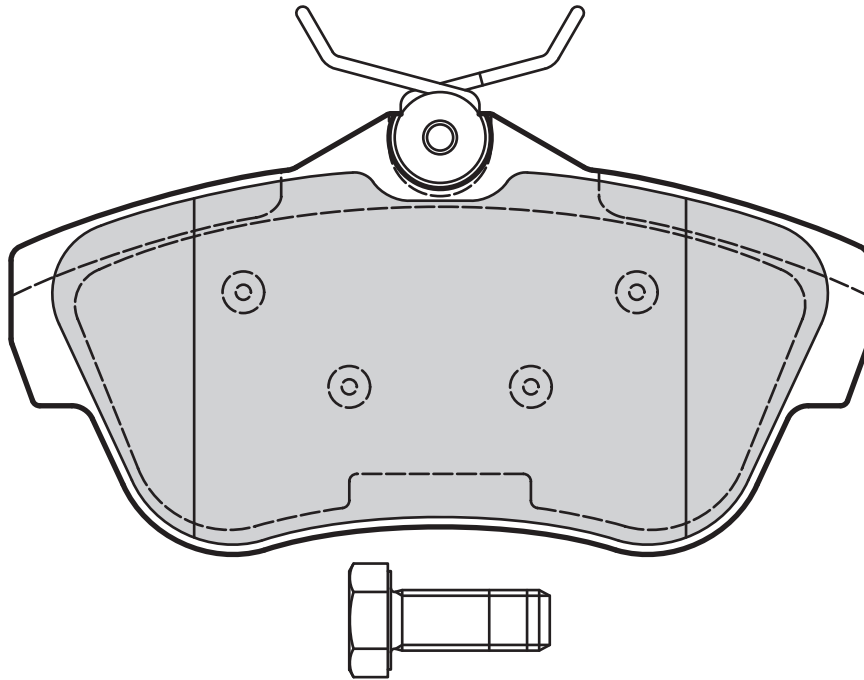

Valeo



Valeo



601039

0

113,4

58,2

16,6

LUCAS

CITROËN, FIAT, PEUGEOT



24595 (WVA)

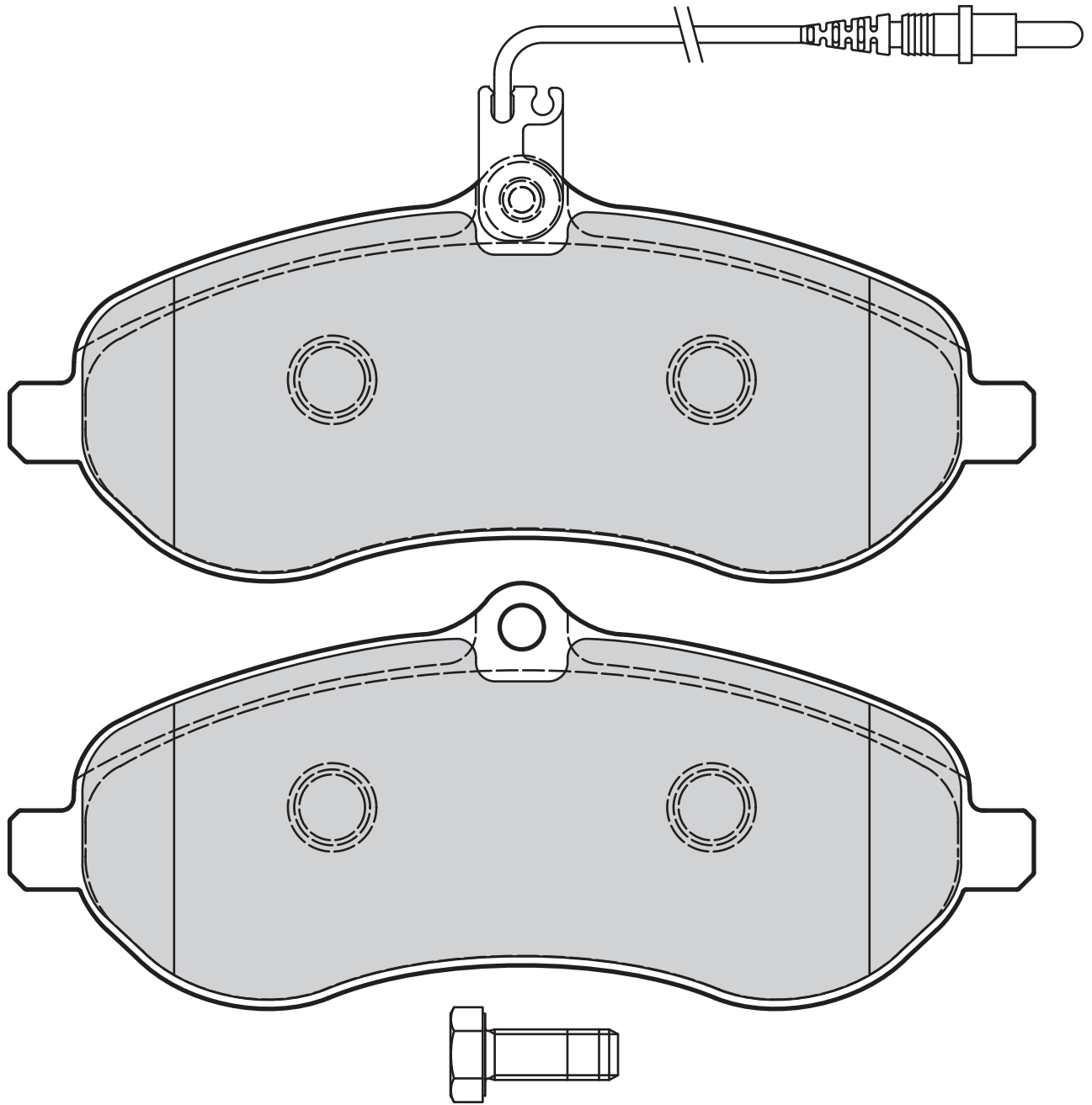

Valeo



Valeo



598899

1

330

162

64,4

18,5

LUCAS

CITROËN, FIAT, PEUGEOT

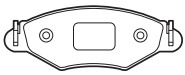

24610 (WVA)

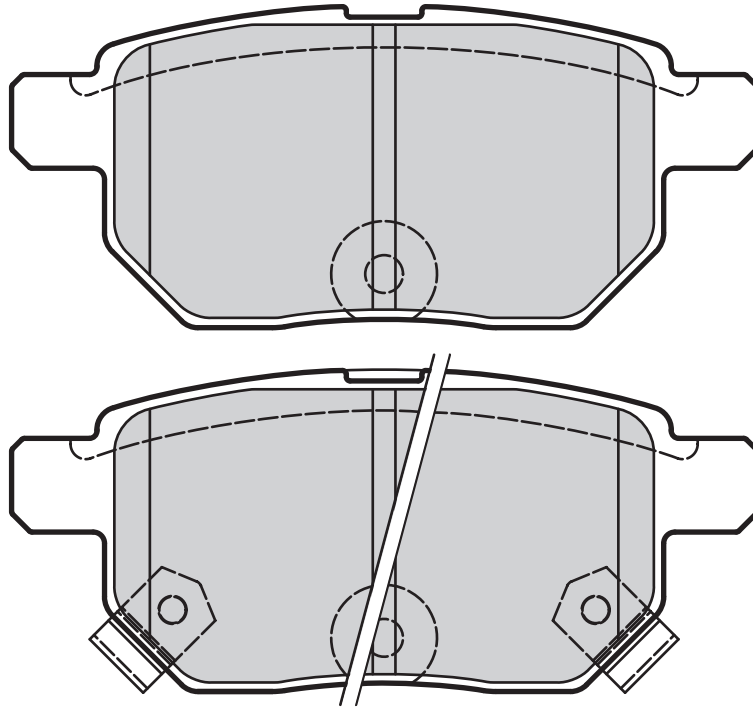

598933	2			98,6	42,5	14				AKEBONO	TOYOTA		

24632 (WVA)

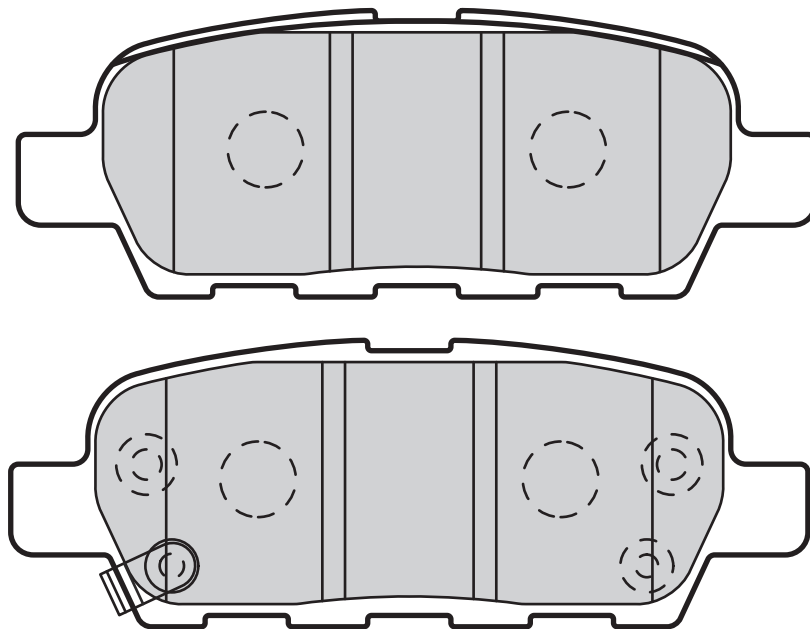

601009	1	Leaf		105,5	38	13,7				AKEBONO	INFINITI, NISSAN, RENAULT		

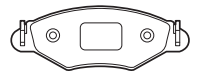

24635 (WVA)

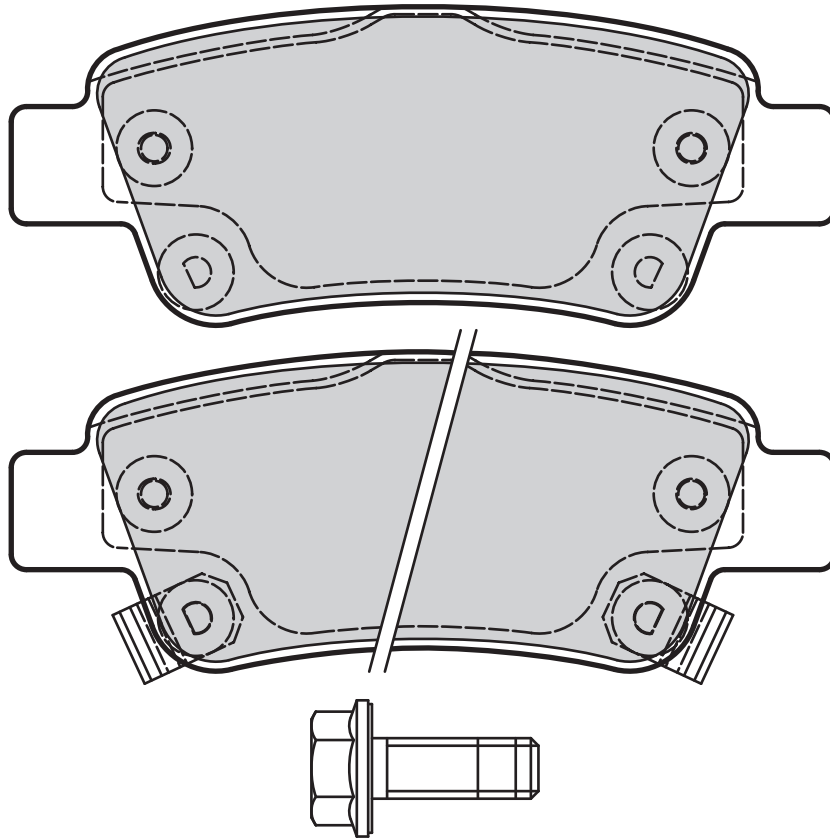

Valeo



Valeo



Leaf



108,8



42,1



16,5



BOSCH



HONDA



601038

2

24660 (WVA)

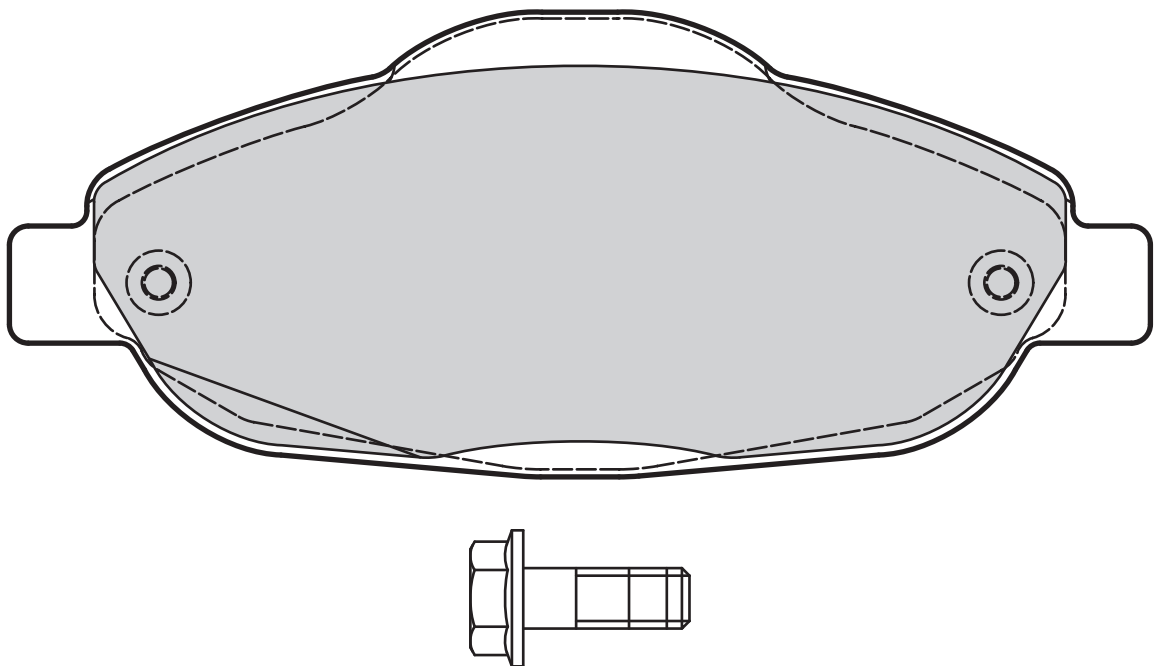

Valeo



Valeo



151



61,6



18



BOSCH



PEUGEOT



598927

0



24673 (WVA)

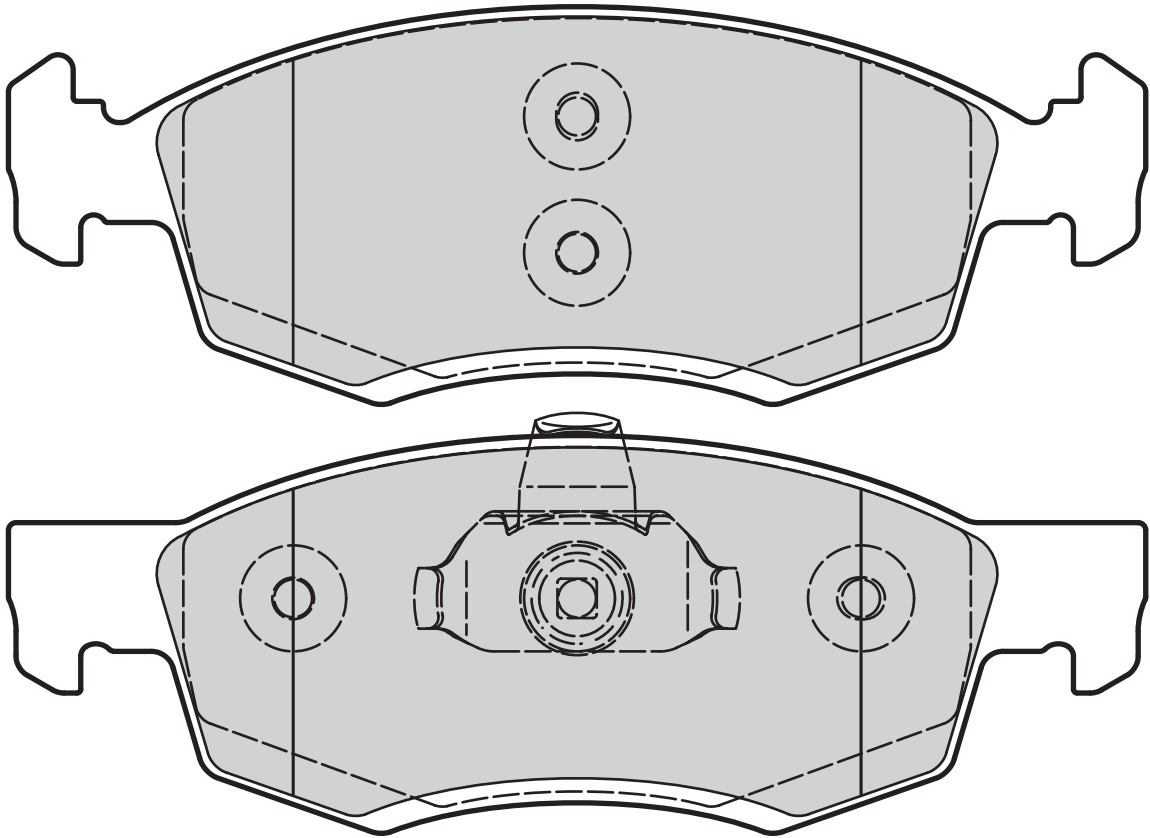

601017

0

150,2

52,5

17,8

TEVES

DACIA

24692 (WVA)

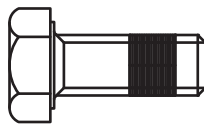
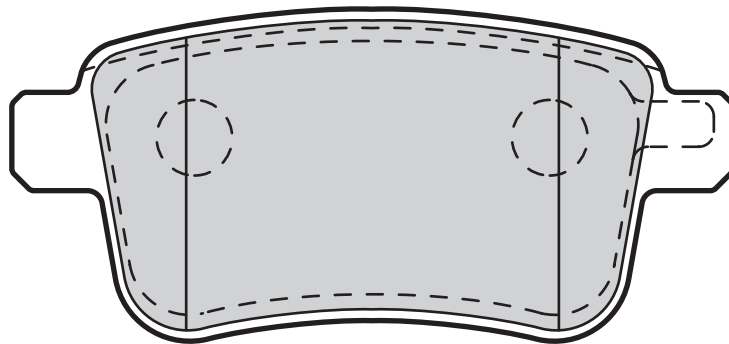

601011

0

95,4

44

16

TRW

RENAULT

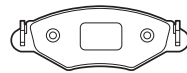

24693 (WVA)

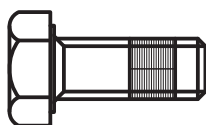
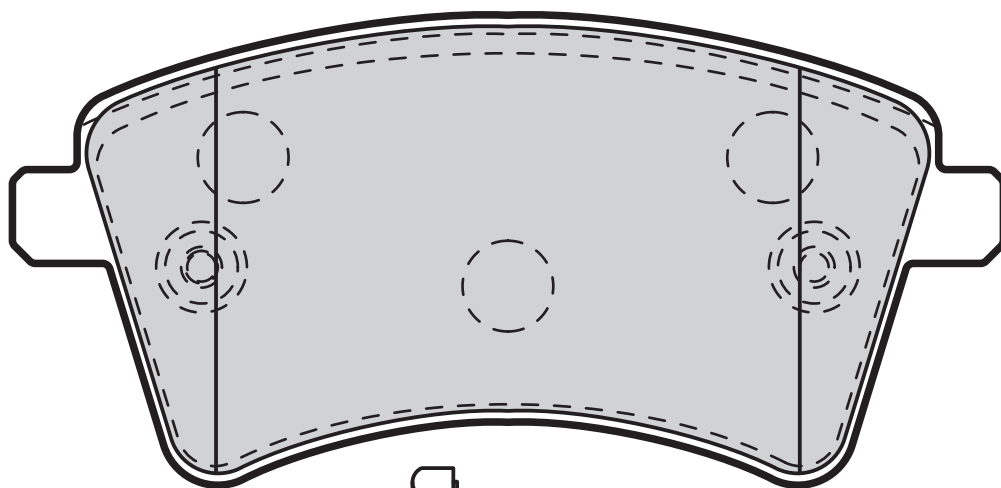

Valeo



Valeo



601010

0

131,1

62,2

18,5

TRW

RENAULT



Valeo

24705 (WVA)

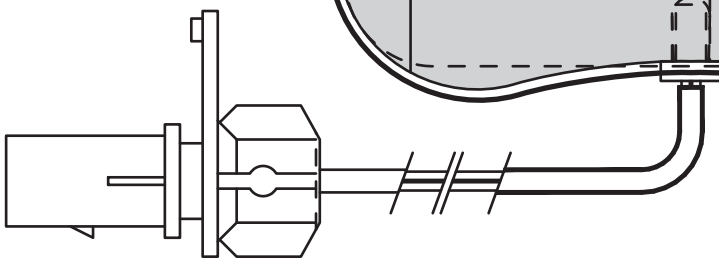
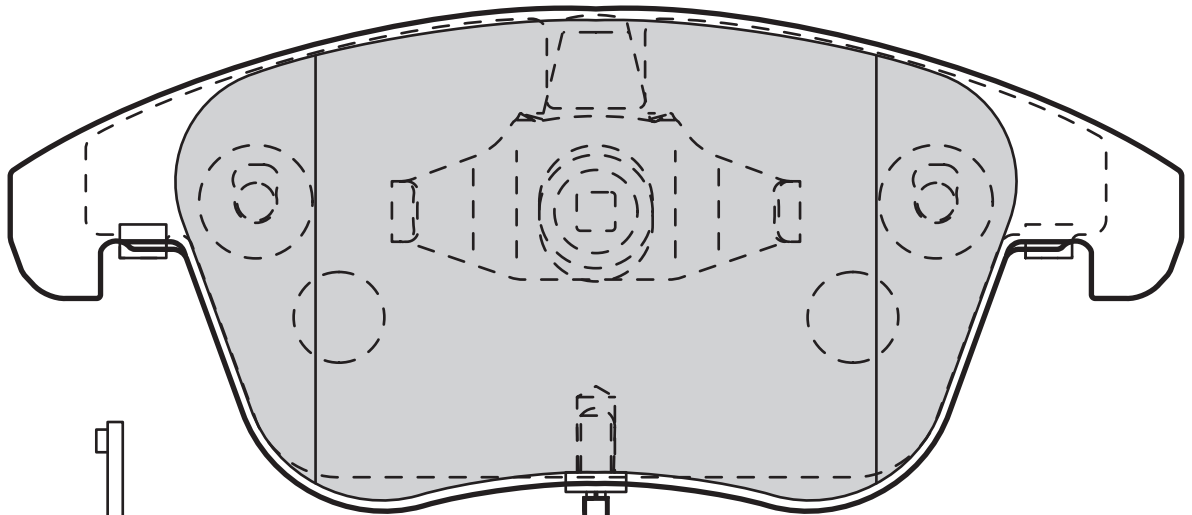
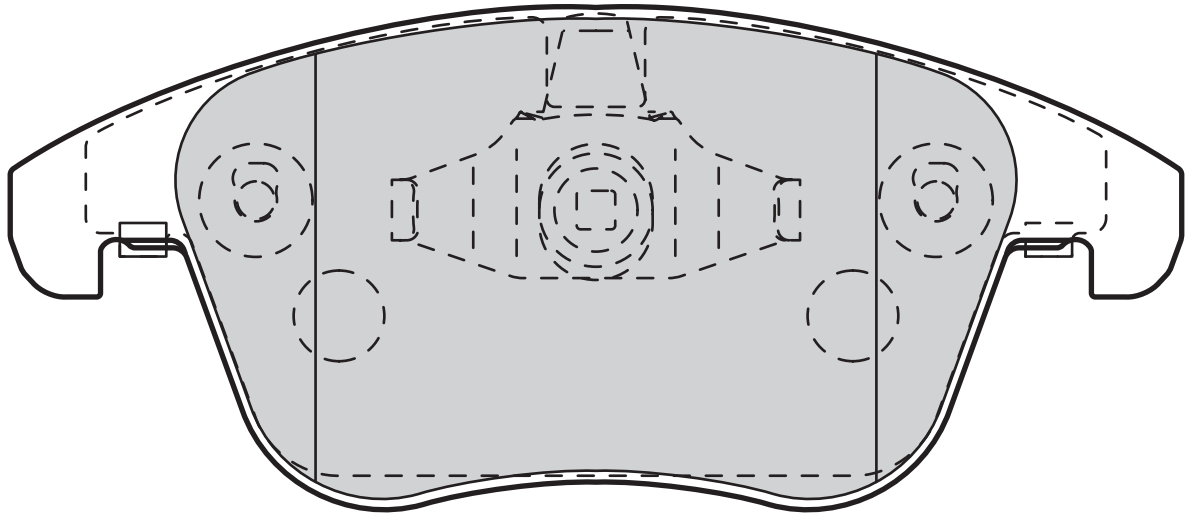

Valeo



Valeo



598996

1

280

155,2

66,5

20,7

TEVES

AUDI



24708 (WVA)

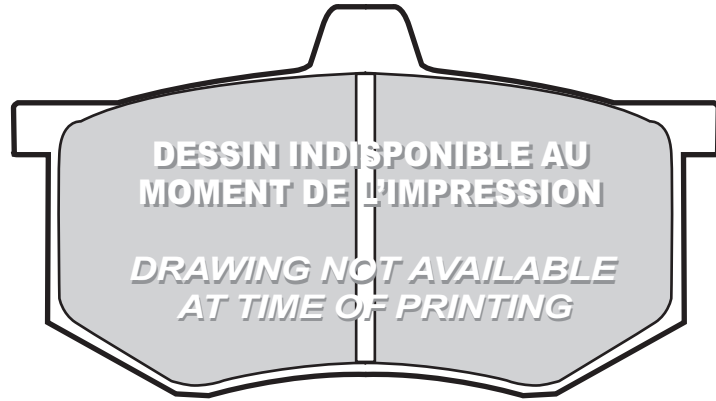

601052

0

122,7

54,7

17,5

SUMITOMO

TOYOTA

24710 (WVA)

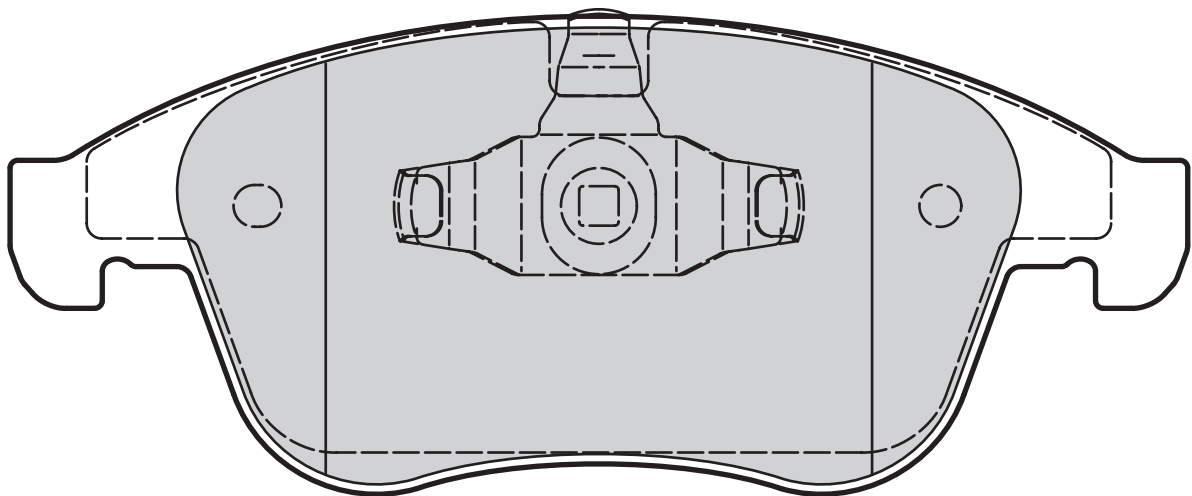
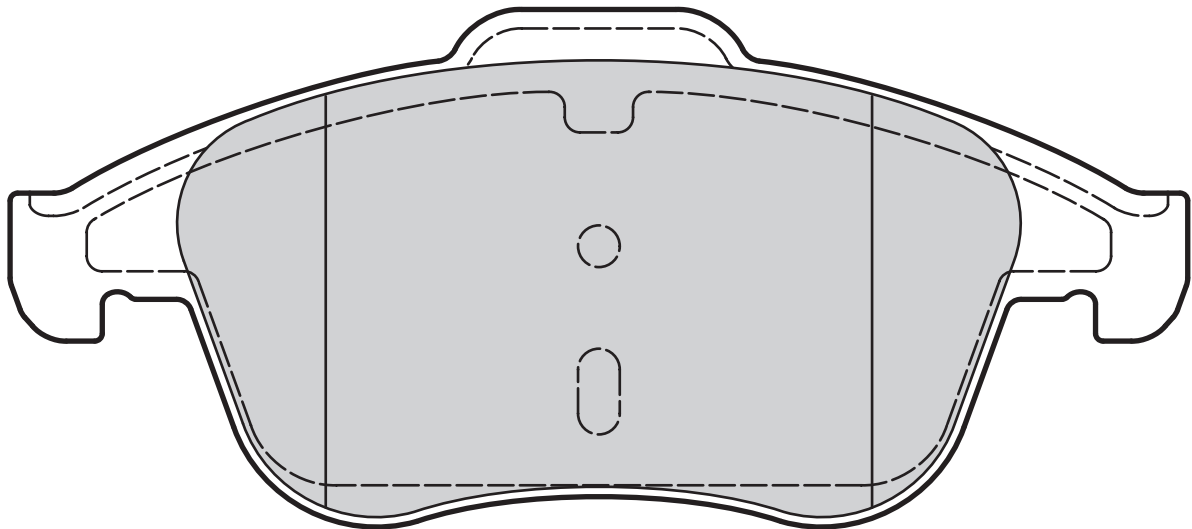

601050

0

155,2

68,3

18

TEVES

RENAULT

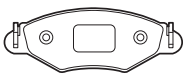

Valeo

24727 (WVA)

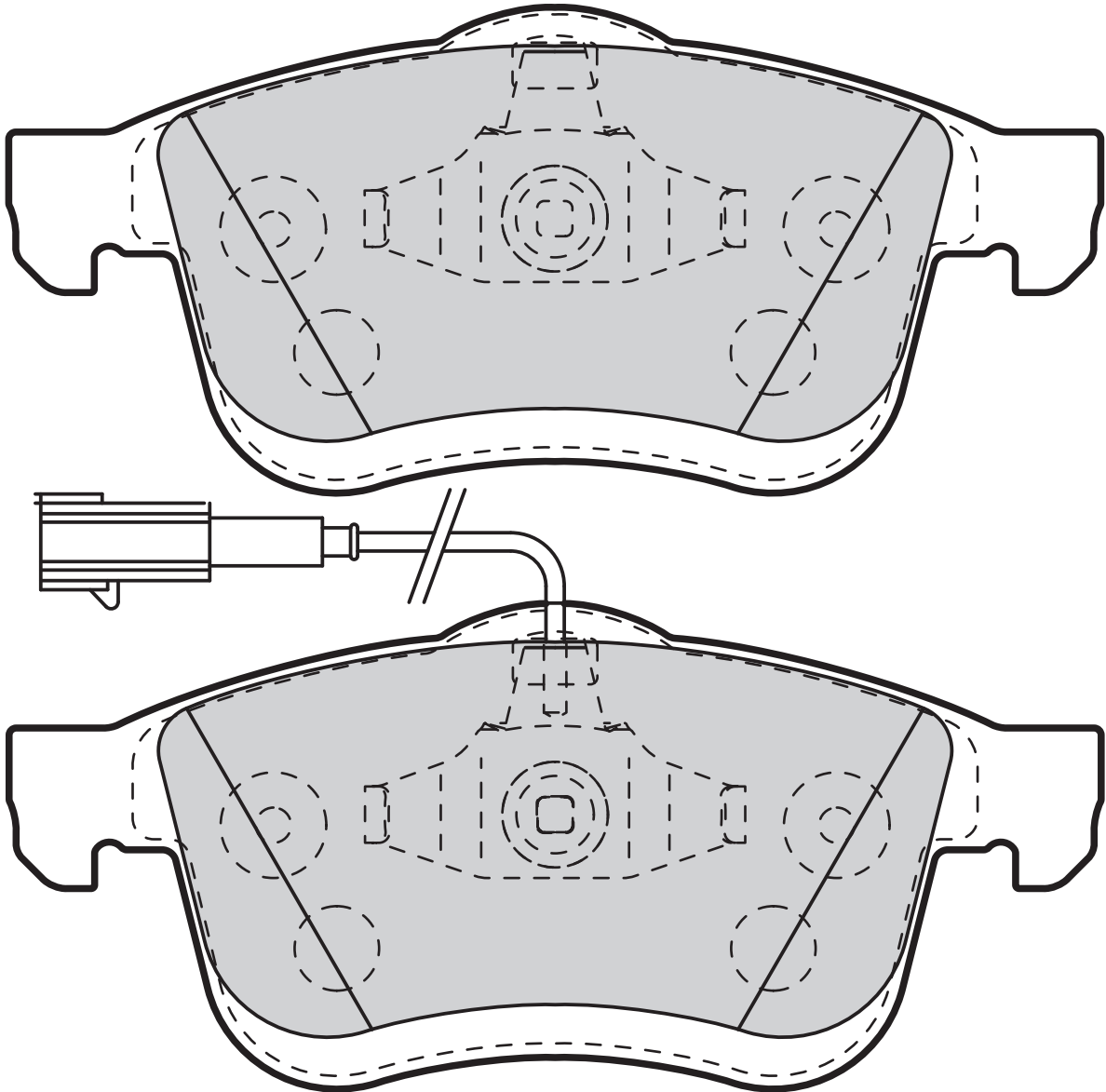

Valeo



Valeo



601014

1

210

155,2

69,1

20,3

TEVES

LANCIA



24764 (WVA)

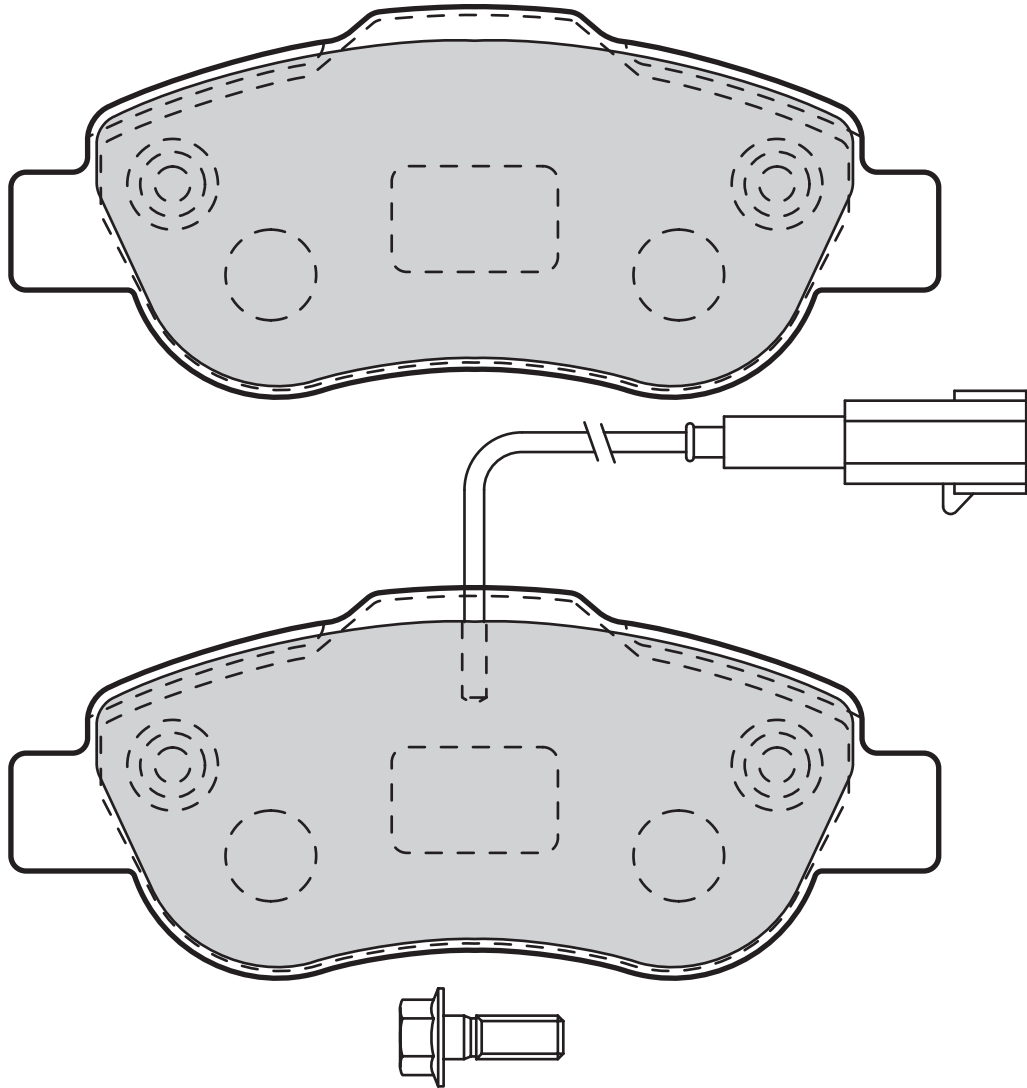

Valeo



Valeo



601015

1

216

122,8

51,7

17,7

BOSCH

FIAT, FORD



Valeo

24765 (WVA)

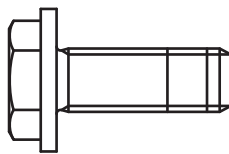
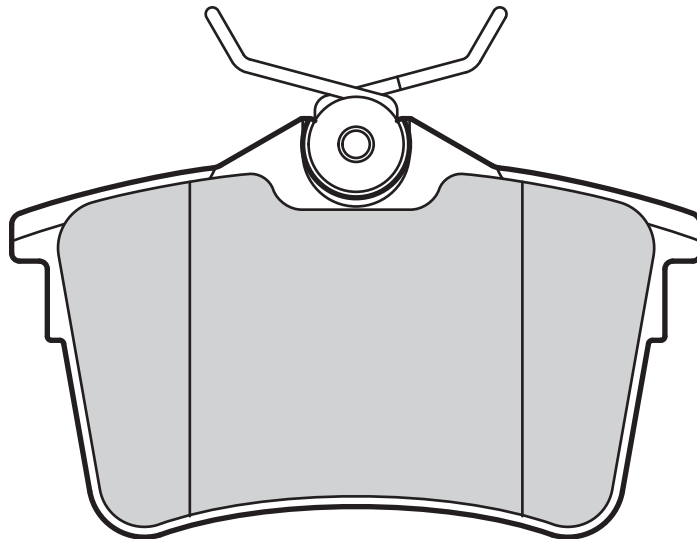

Valeo



0

Valeo



87



52,9



16,7



LUCAS



CITROËN, PEUGEOT

601042

24820 (WVA)

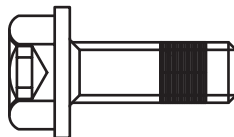
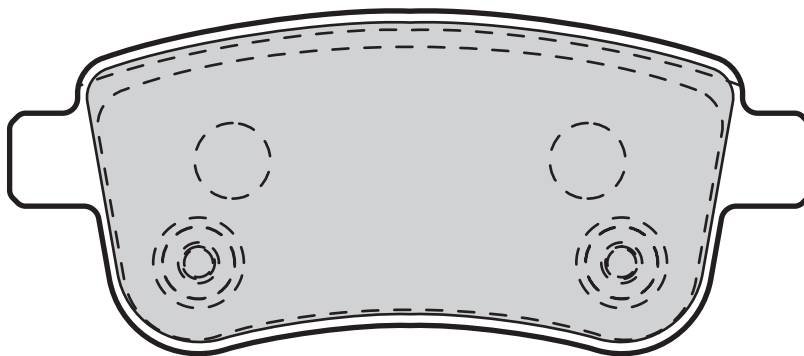

Valeo



0

Valeo



106,1



45,4



16



TRW



RENAULT

601000

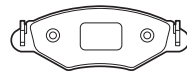

24914 (WVA)

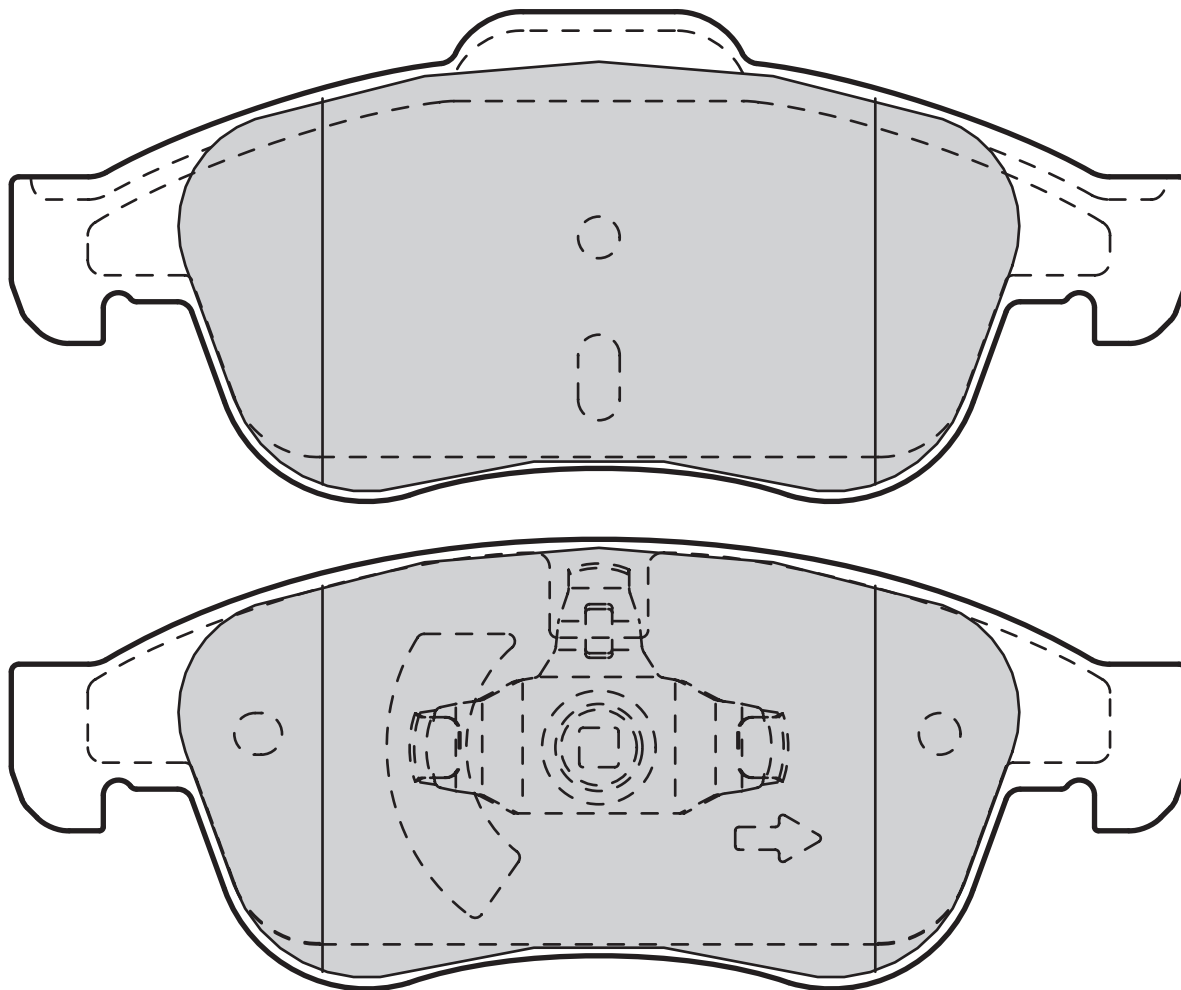

Valeo



Valeo



601045

0

155,2

64,8

18

TEVES

DACIA, RENAULT

27073 (WVA)

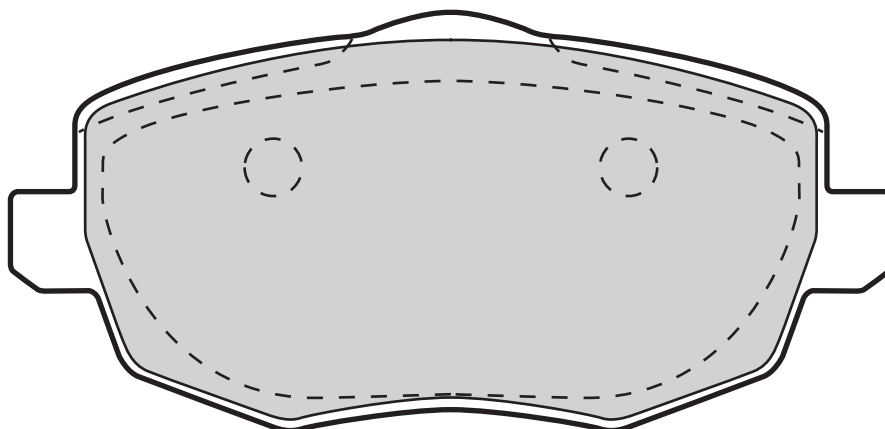

Valeo



Valeo



598761

116,5

55,2

16,4

LUCAS

LANCIA

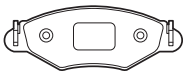

29001 (WVA)

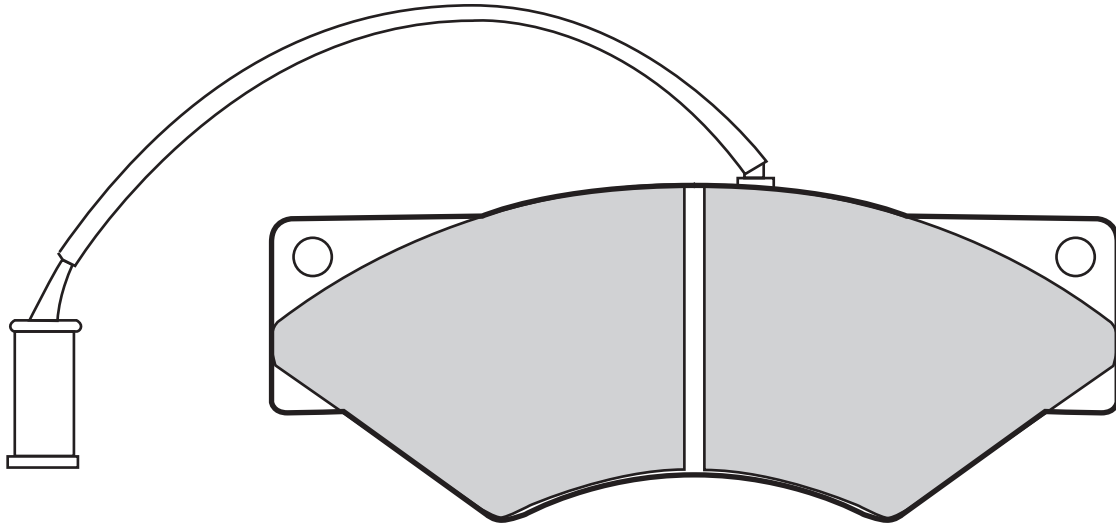

541641	4	230	174,4	69,2	20	PERROT	IVECO			

29012 (WVA)



540436	2	440	146	69	18	PERROT	IVECO			



29037 (WVA)

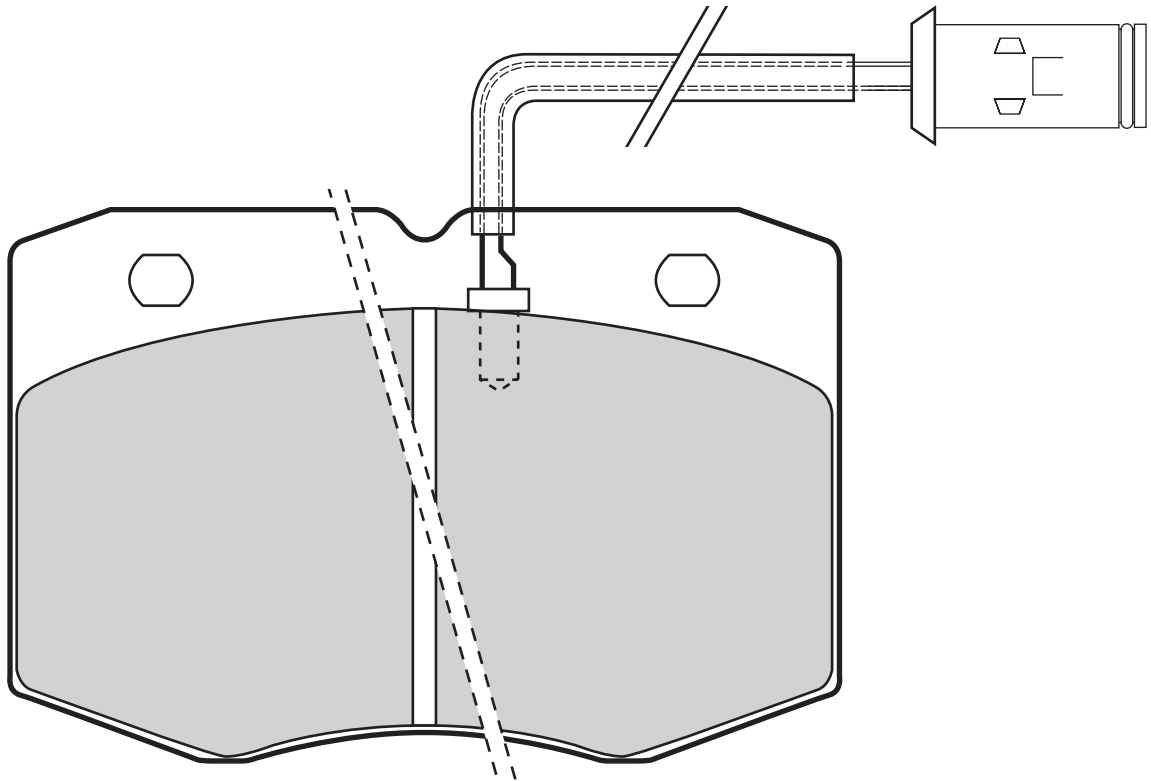

Valeo



Valeo



598598

2

170

109,7

73

18,3

BREMBO

IVECO

29076 (WVA)

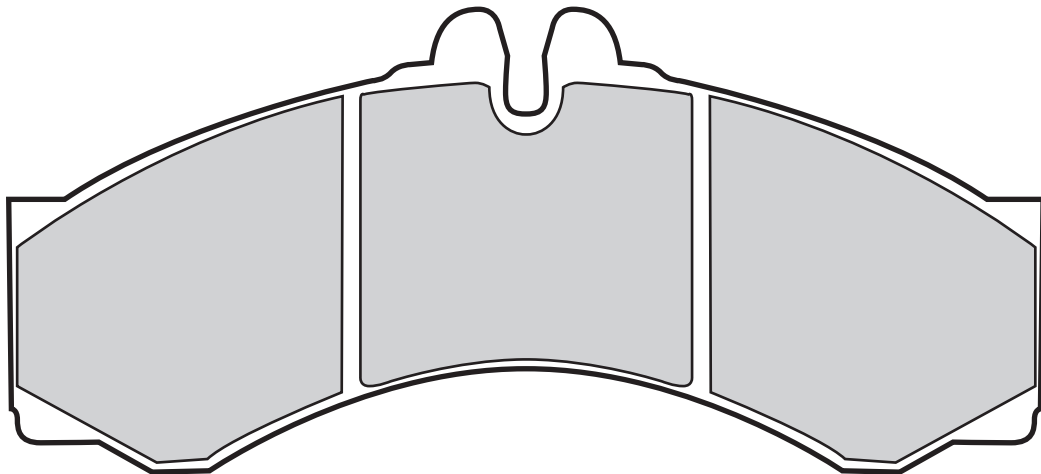

Valeo



Valeo

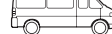

541664

2

210

164,4

72,8

20

BREMBO

MERCEDES, VOLKSWAGEN

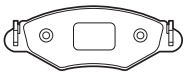

29121 (WVA)

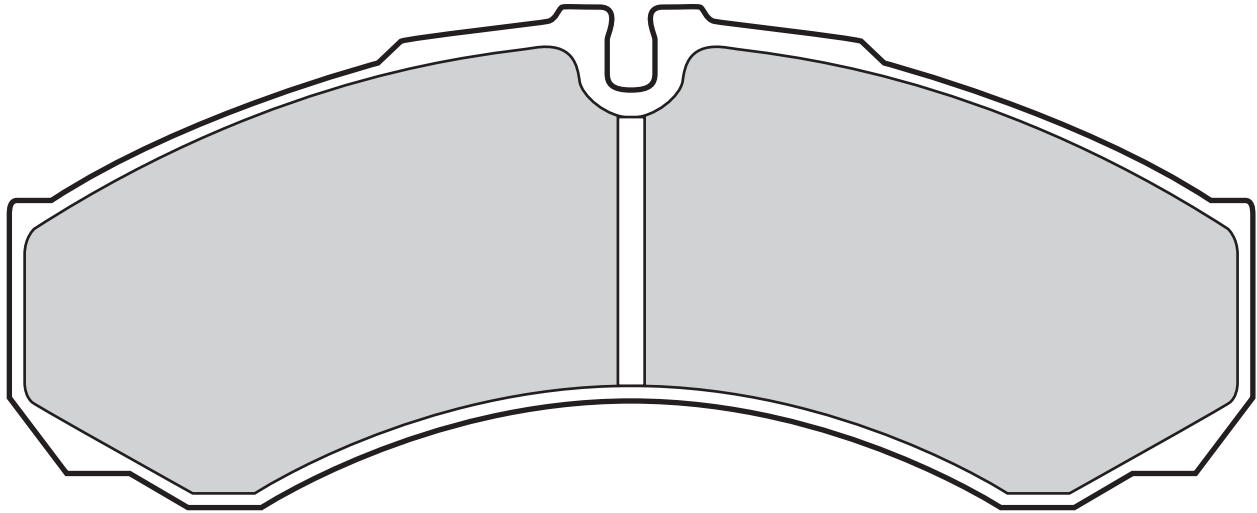

Valeo		Valeo					
541662	2	280	165	66,5	18,3	BREMBO	IVECO
541683	2	260	164,5	66,3	20	BREMBO	RENAULT, RVI
541717	2	295	164,5	66,6	17,1	BREMBO	IVECO

29123 (WVA)

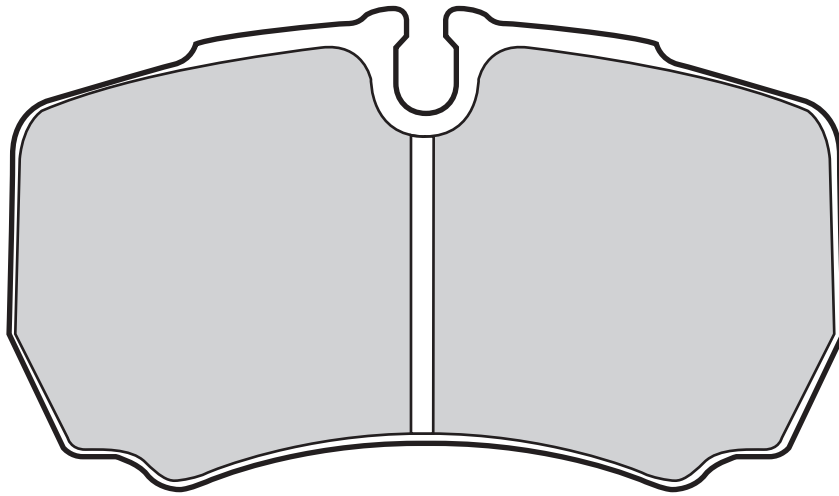

Valeo		Valeo					
541705	2	300	110	64	20,3	BREMBO	IVECO

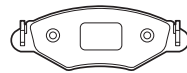

29139 (WVA)

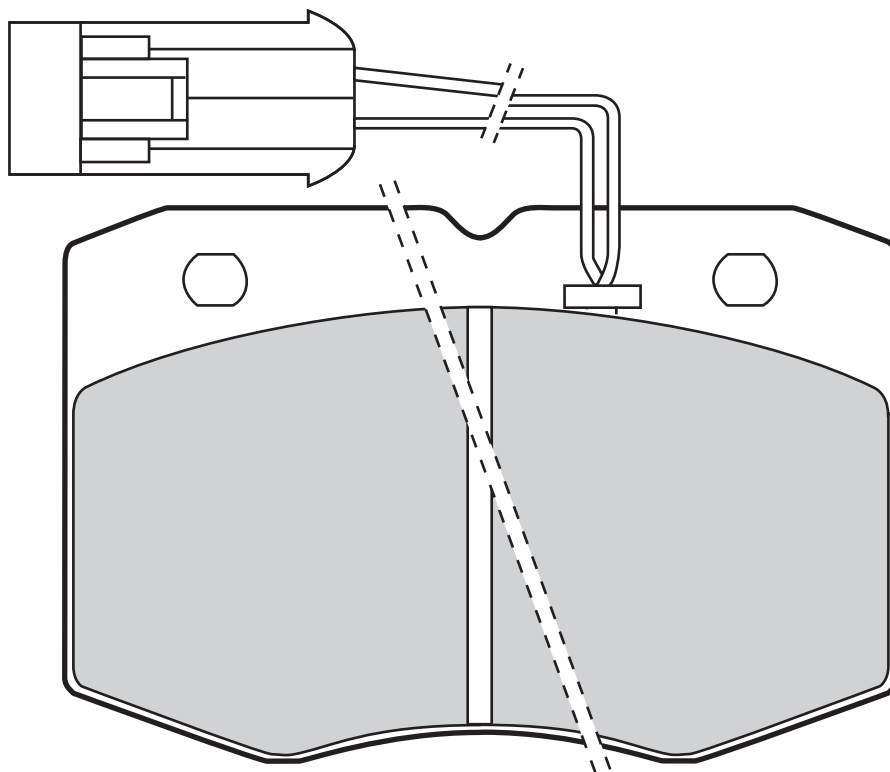

Valeo



Valeo



598586

2

170

109,7

73

18,3

BREMBO

IVECO



29153 (WVA)

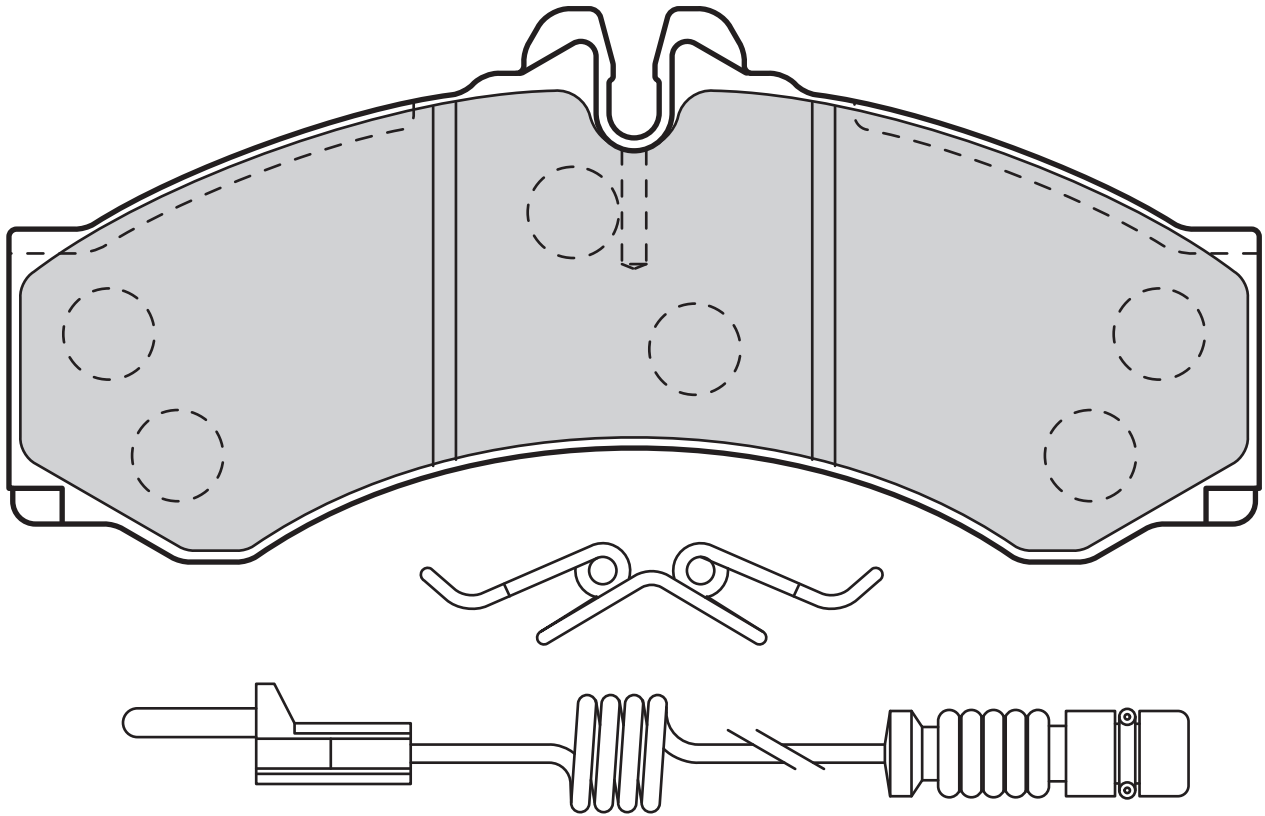

2



164,4



72,8



20



BOSCH



VOLKSWAGEN

598966

29160 (WVA)

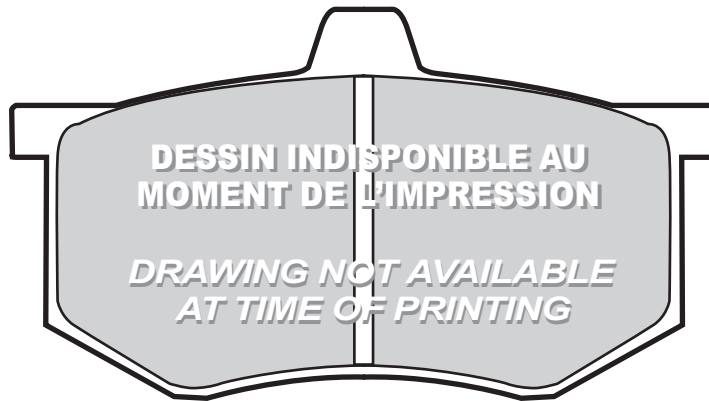

2



260



164,6



67,8



20



BREMBO



IVECO

541663

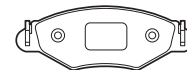

29190 (WVA)

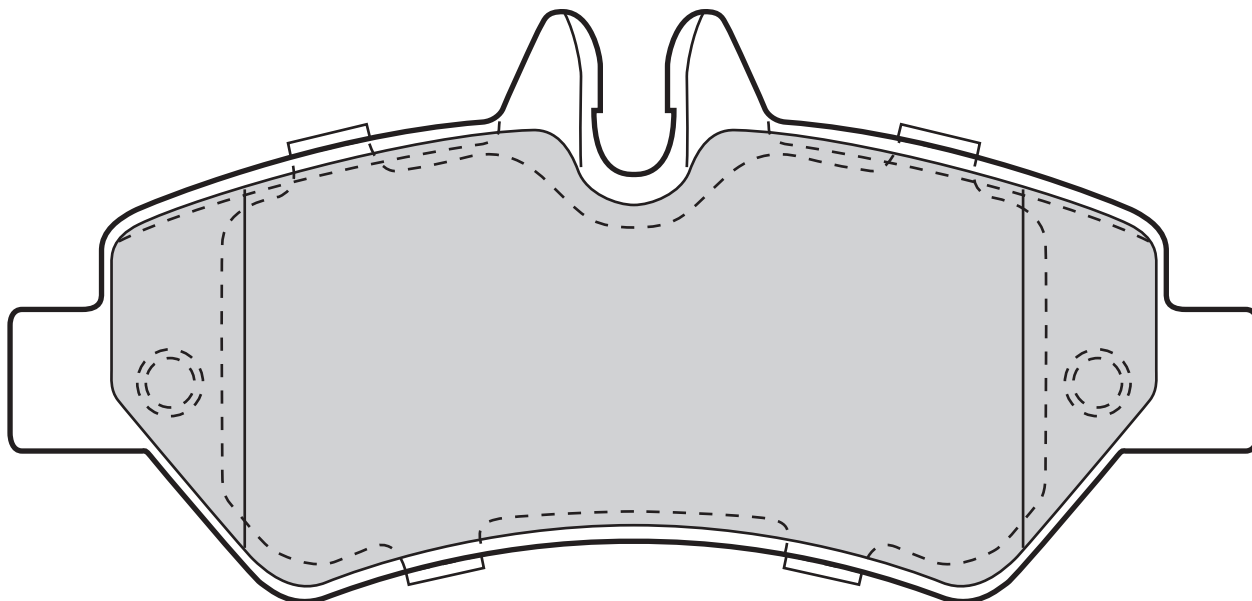

Valeo



Valeo



541728
598876

0

136,9
165

63,1
78,1

19,8
20,5

BOSCH
BOSCH

MERCEDES, VOLKSWAGEN
MERCEDES, VOLKSWAGEN

29192 (WVA)

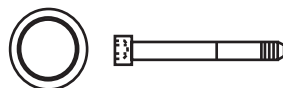
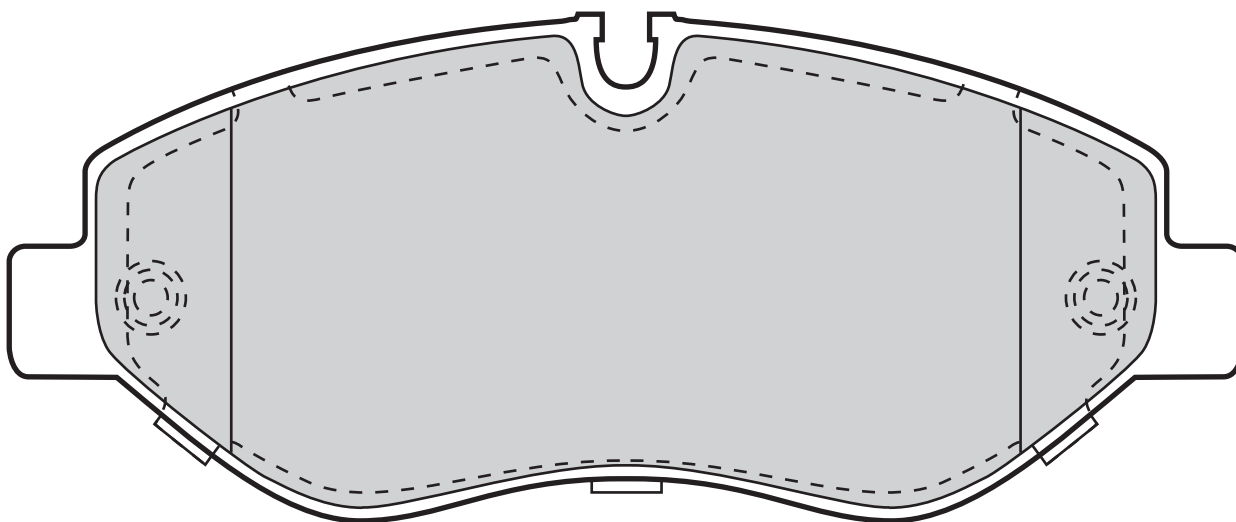

Valeo



Valeo



598882

163,1

67,1

20,8

BREMBO

MERCEDES, VOLKSWAGEN



29200 (WVA)

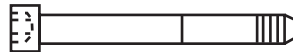
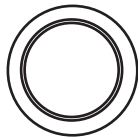
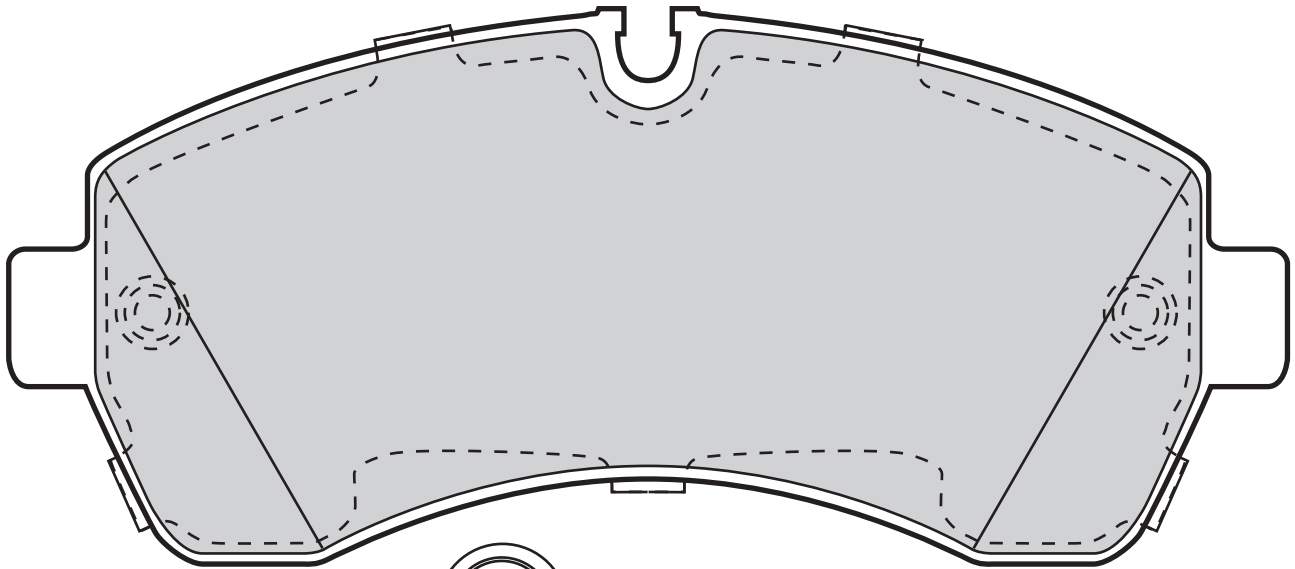

Valeo



Valeo



598881

169,1

73,5

20,8

BREMBO

MERCEDES, VOLKSWAGEN

29229 (WVA)

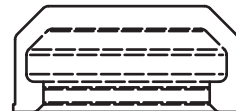
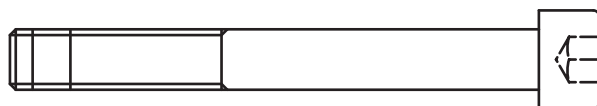
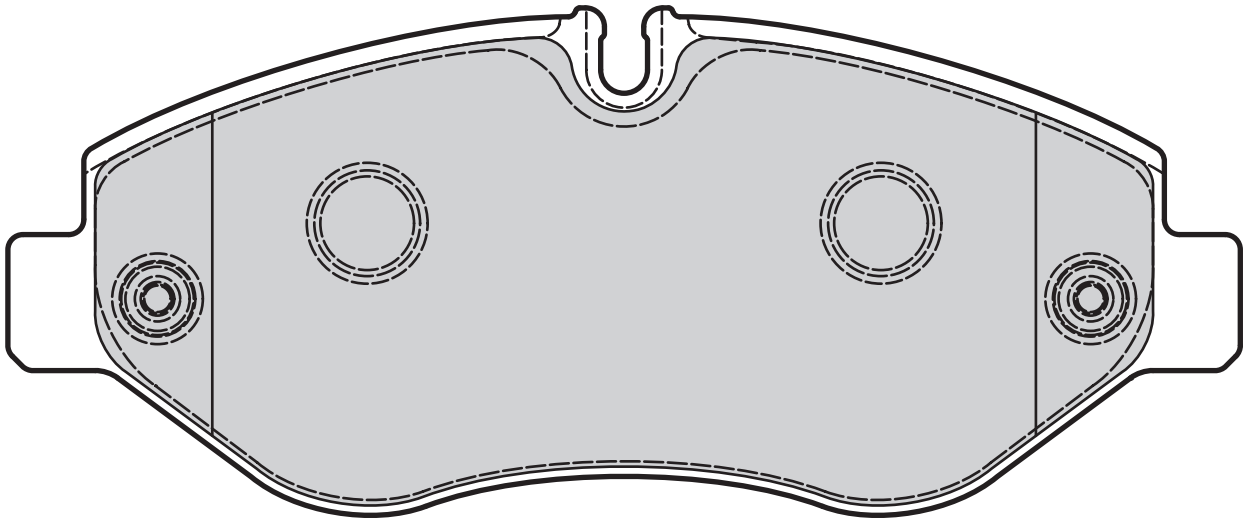

Valeo



Valeo



541734

0

163,1

67,1

20

BREMBO

IVECO

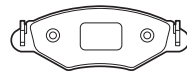

29230 (WVA)

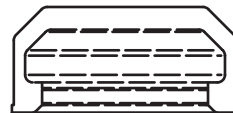
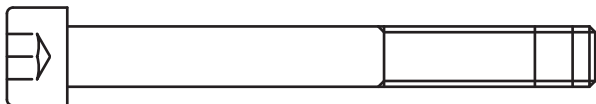
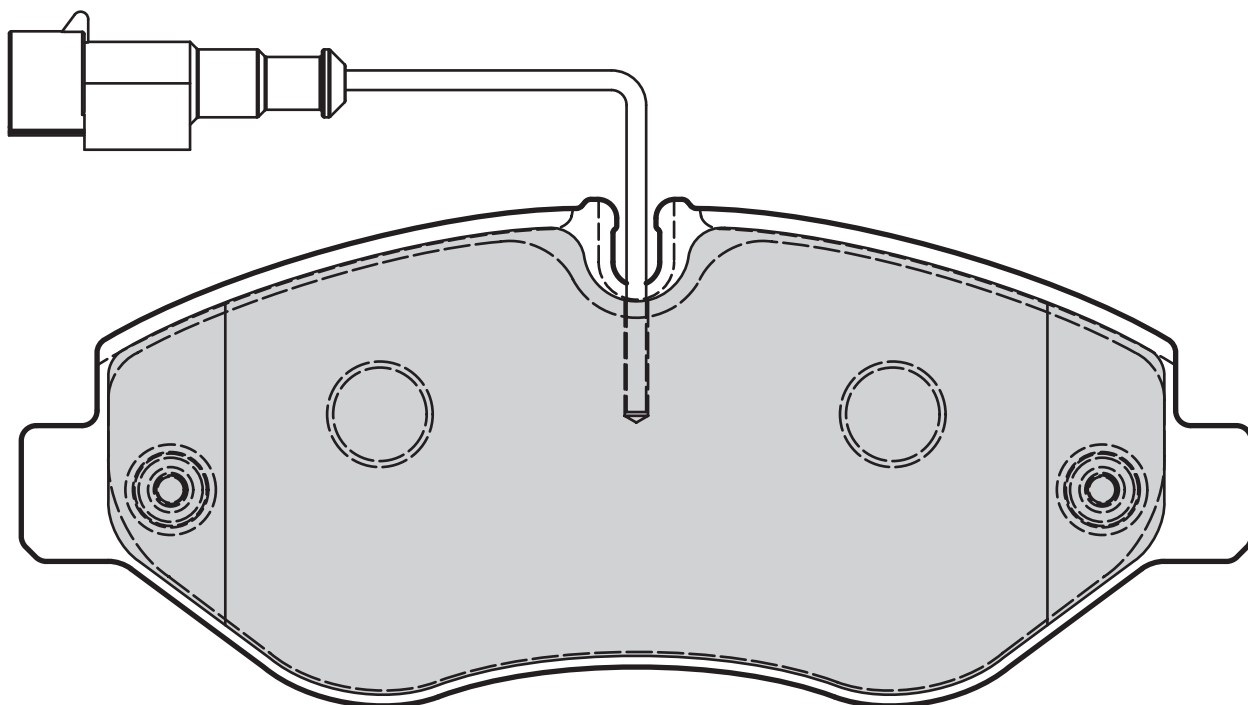
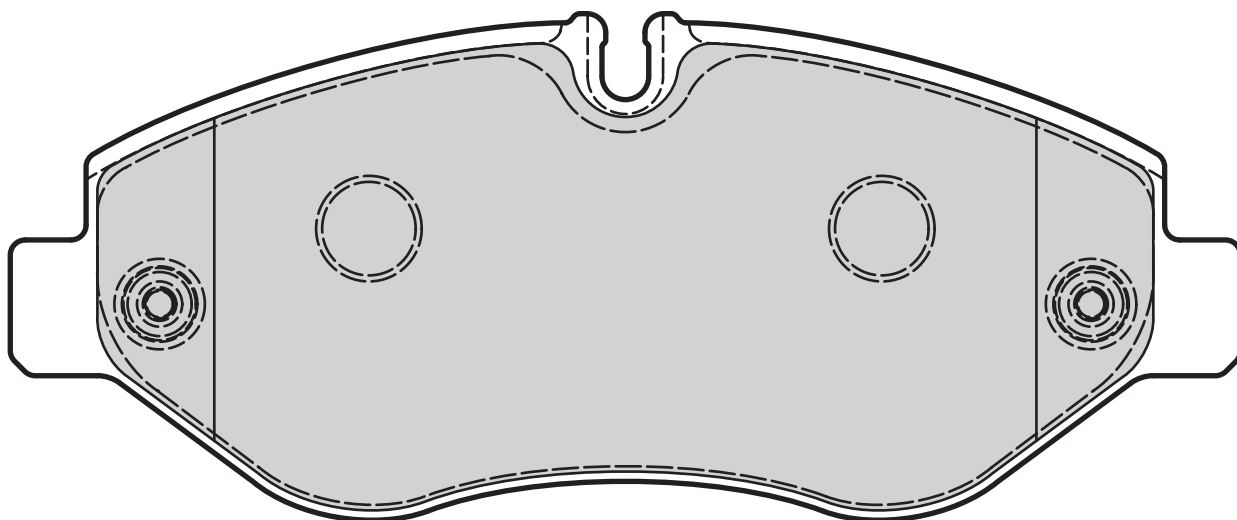

Valeo



2

Valeo



160



163,1



67,1



20,8



BREMBO



NISSAN

541737



29232 (WVA)

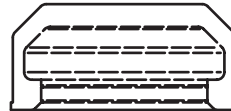
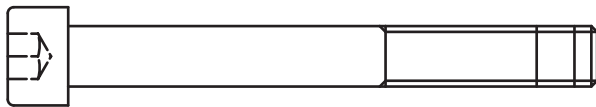
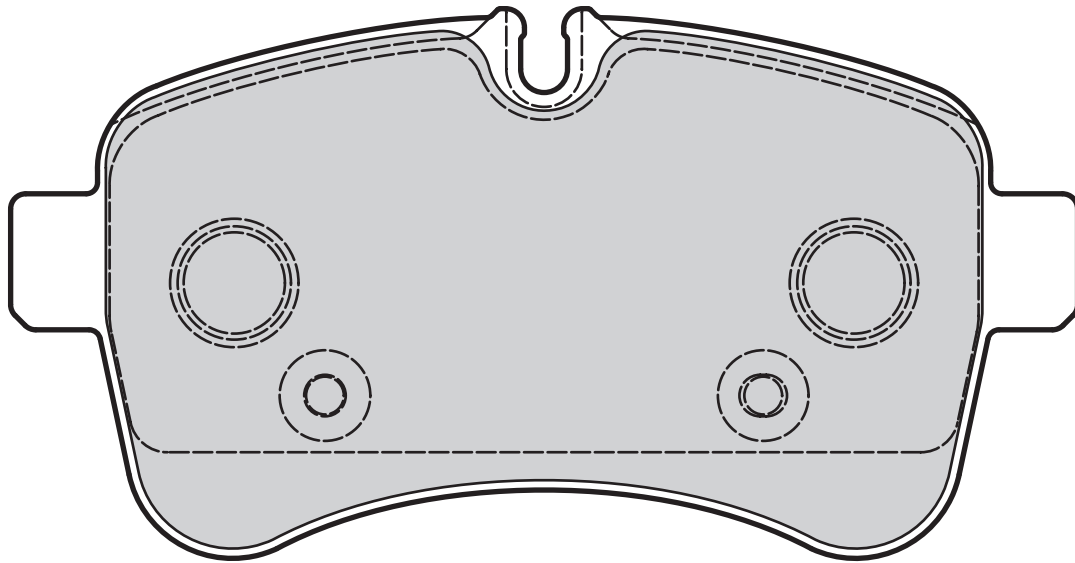

Valeo



0

Valeo



141,1



72,8



21



BREBBO



IVECO

541735

29738 (WVA)

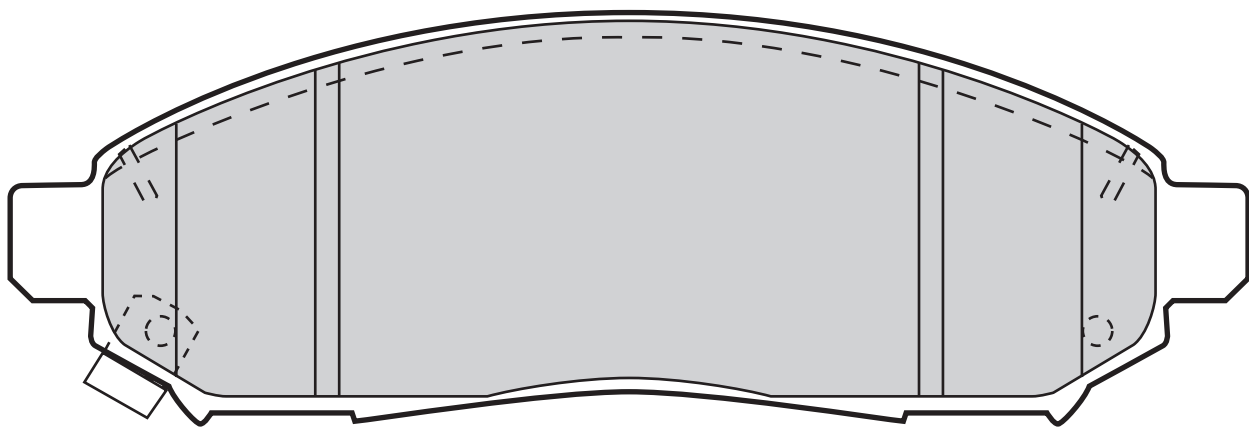

Valeo



1

Valeo



163,7



54



16



AKEBONO



INFINITI, NISSAN, RENAULT

598738



29747 (WVA)

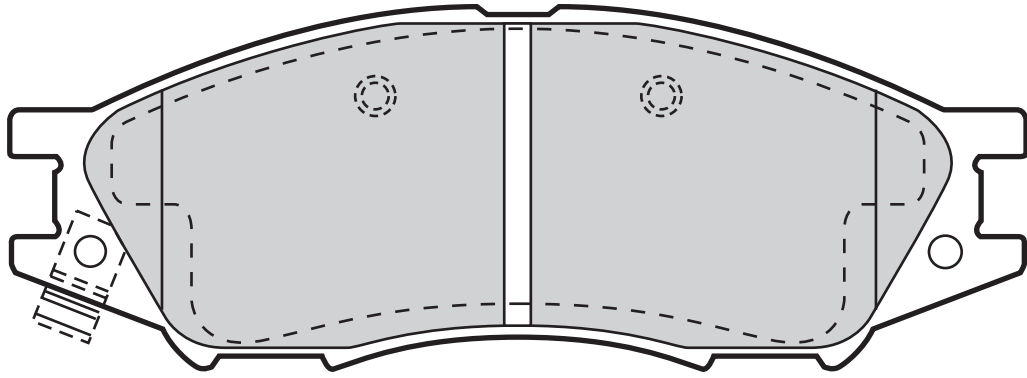

Valeo



Valeo



598747

1

135

48,5

16,1

AKEBONO

NISSAN

29773 (WVA)

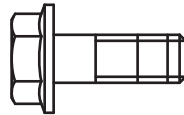
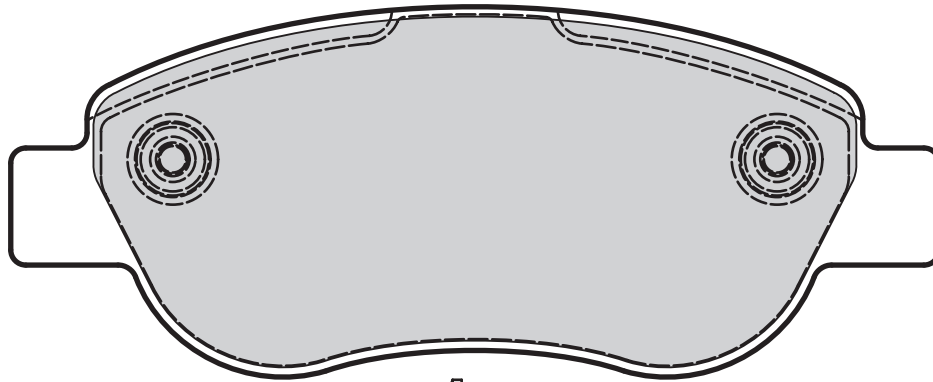

Valeo



Valeo



598773

2

122,9

49

17,4

LUCAS

RENAULT



29816 (WVA)

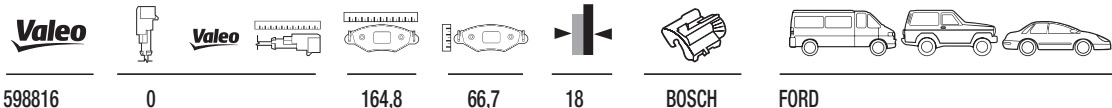
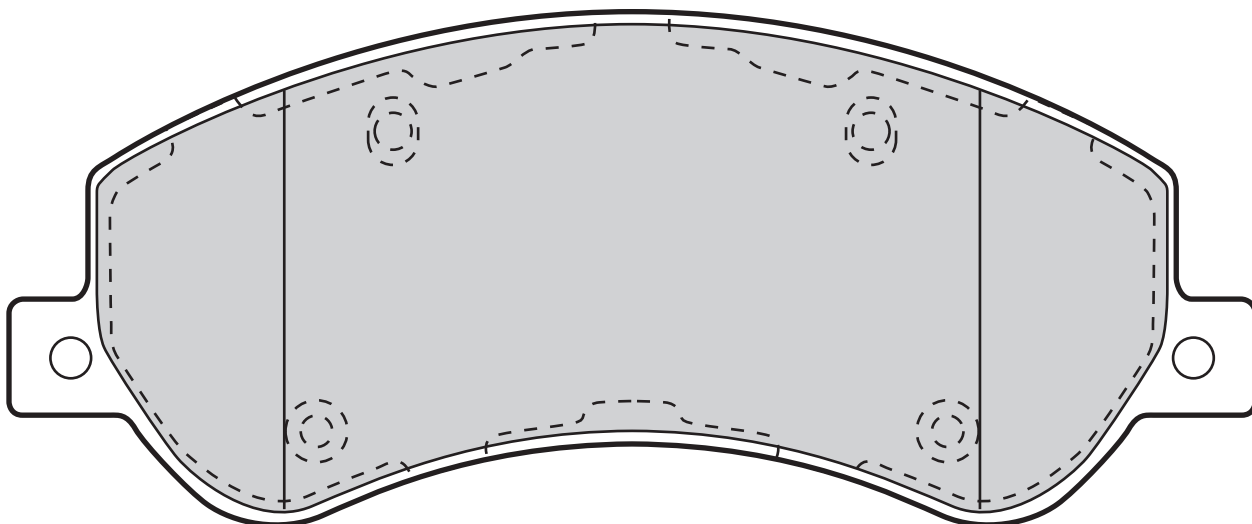

29818 (WVA)

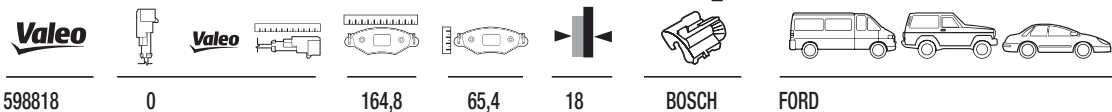
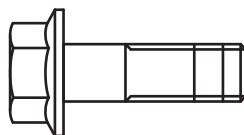
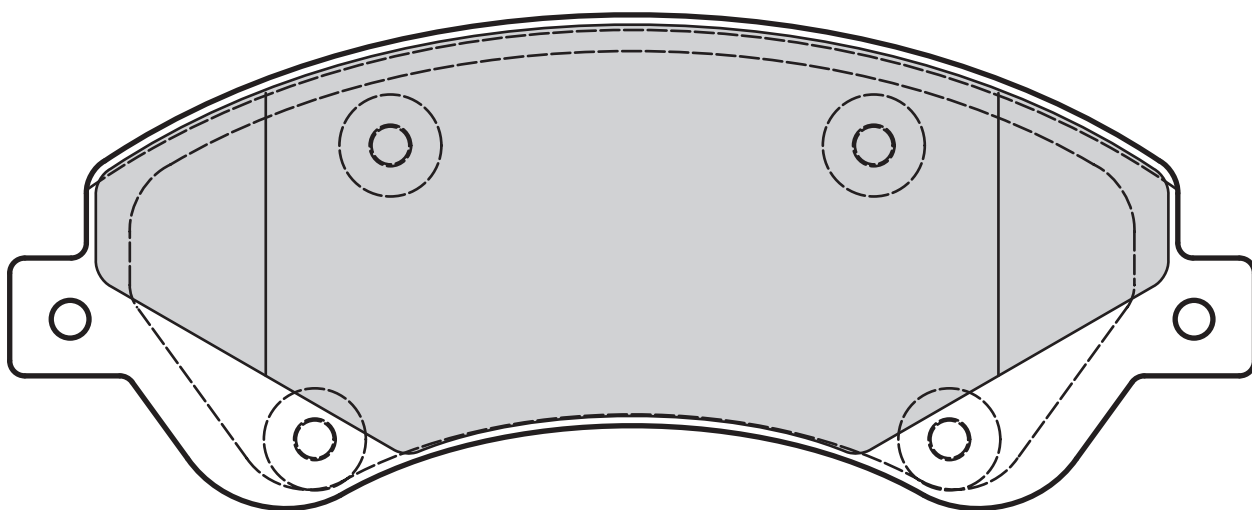

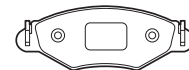

29835 (WVA)

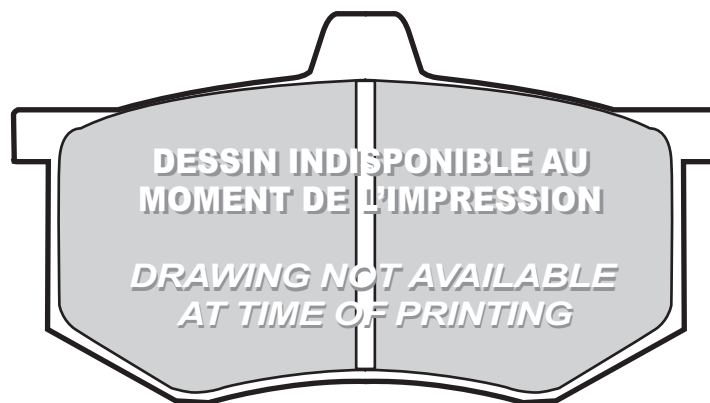

541655

2

220/310

174,8

85,6

22

LUCAS

MERCEDES

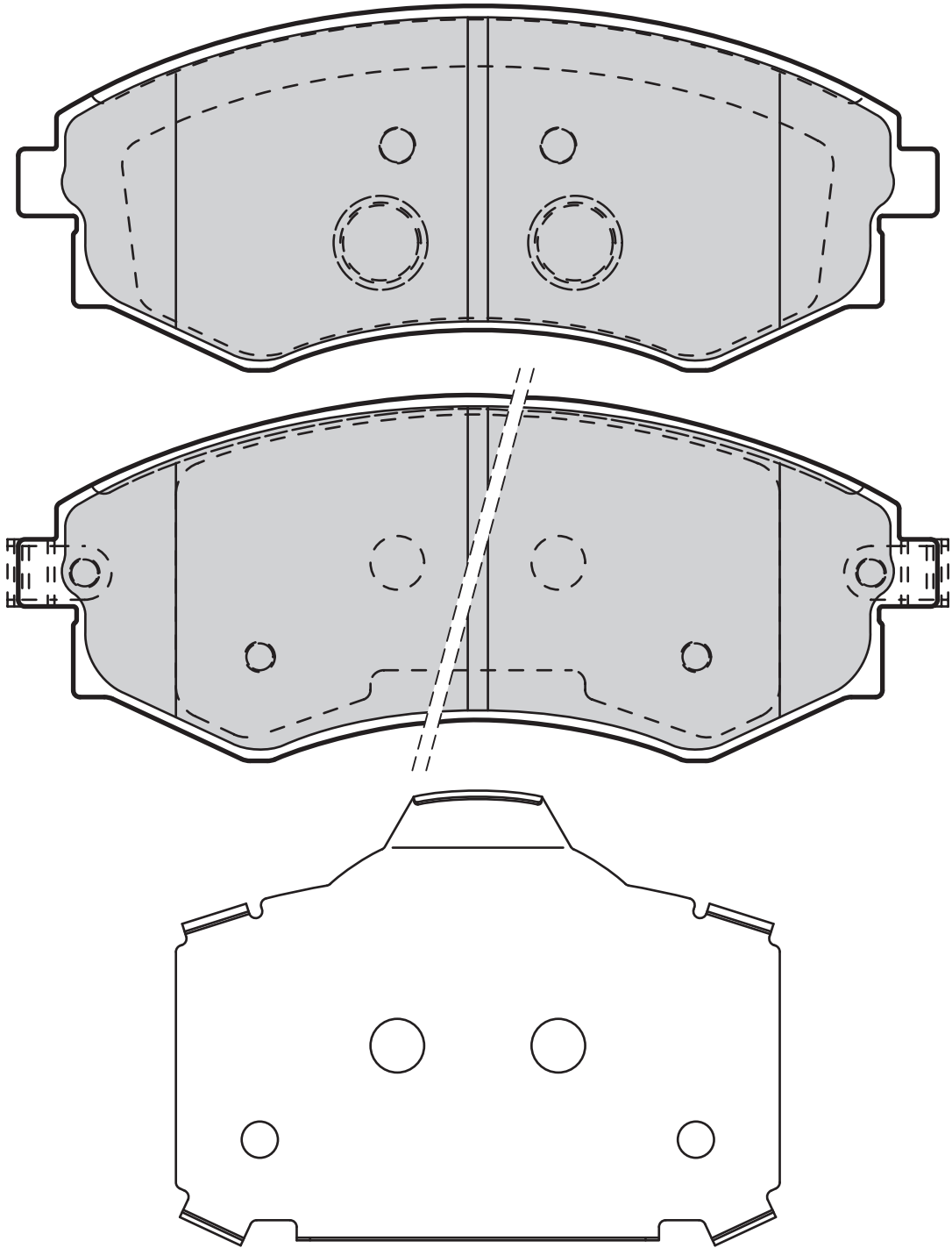
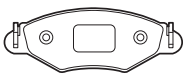

Valeo



Valeo



598870

2

136,9

54

16,6

SUMITOMO

SSANGYONG

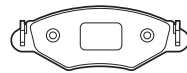

29894 (WVA)

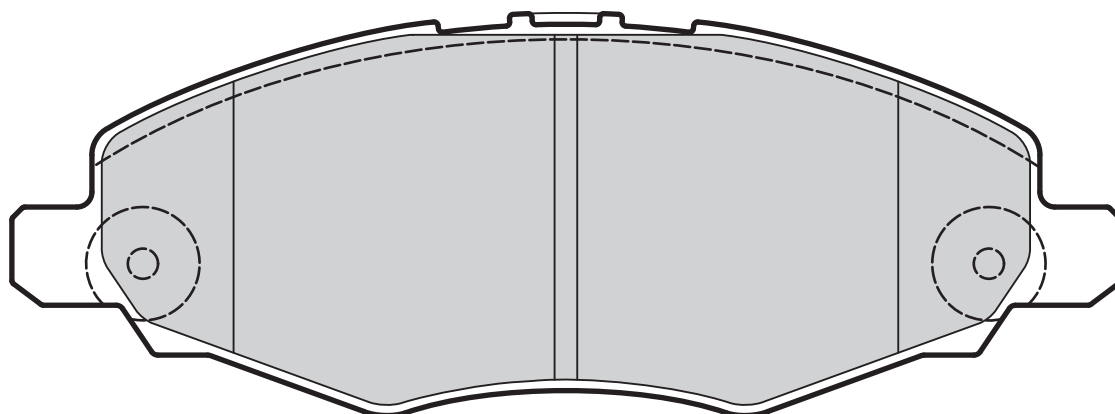
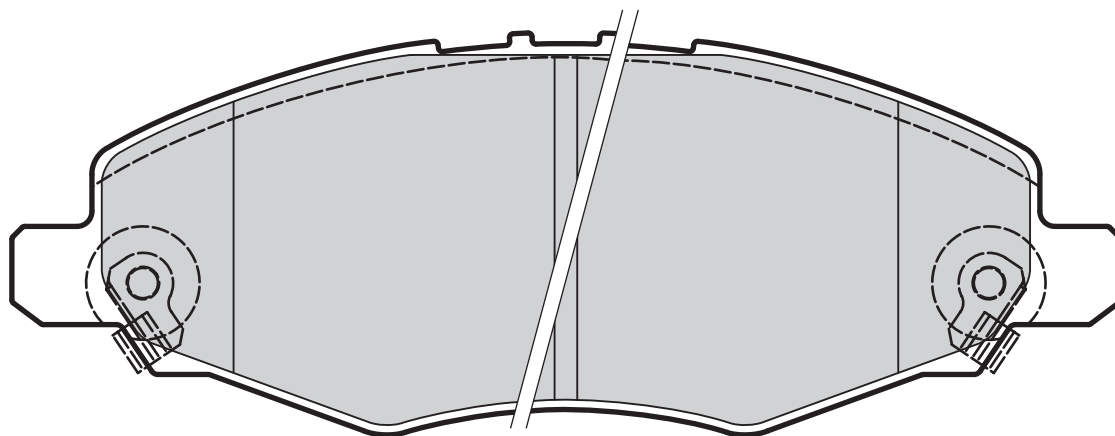

Valeo



Valeo



598894

2

Leaf

146,5

53,1

16,4

SUMITOMO

TOYOTA

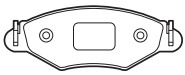

Valeo

29901 (WVA)

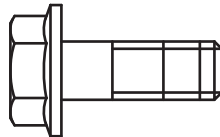
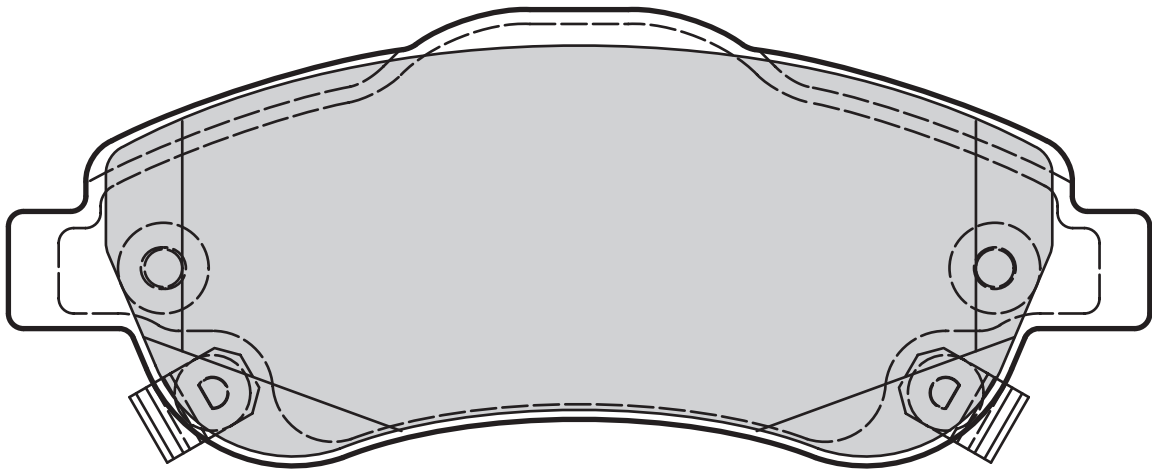
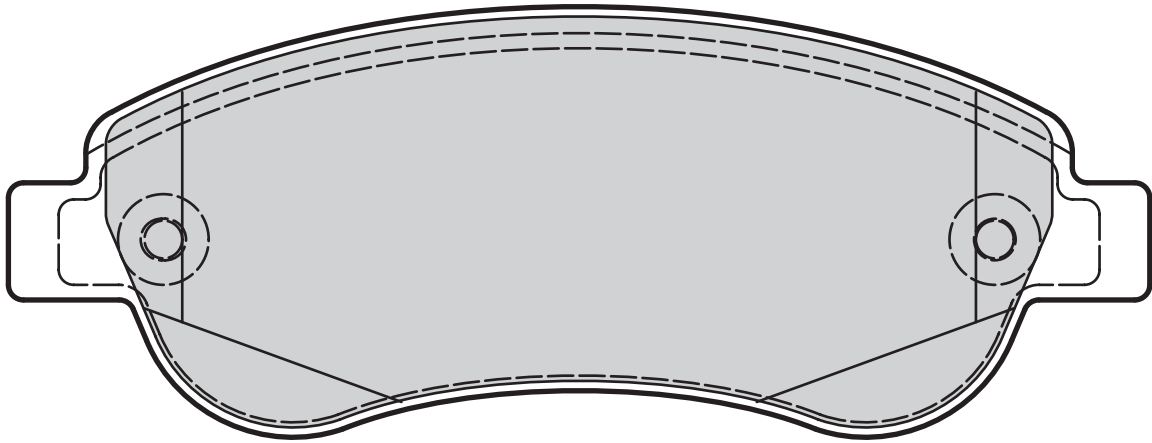

Valeo



Valeo



598901

2

Leaf

151

60,3

19

BOSCH

HONDA

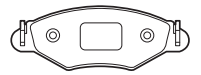

29907 (WVA)

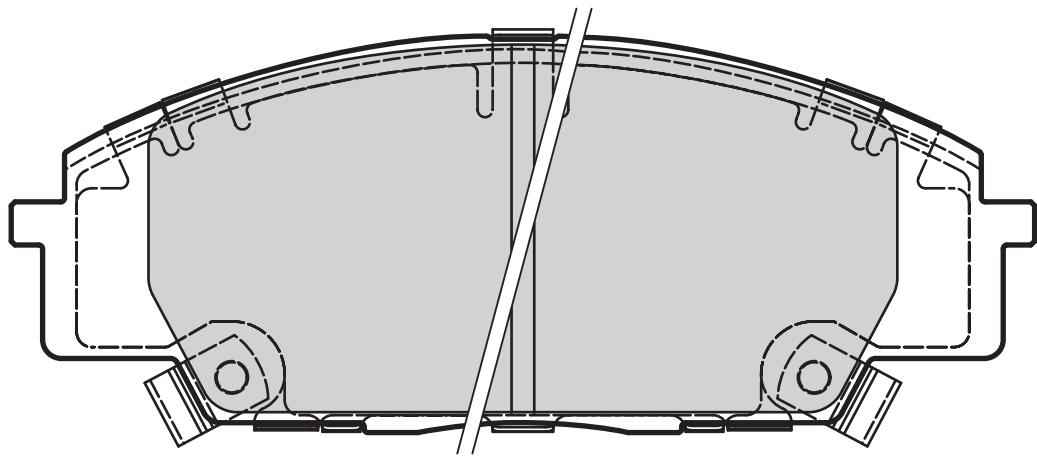
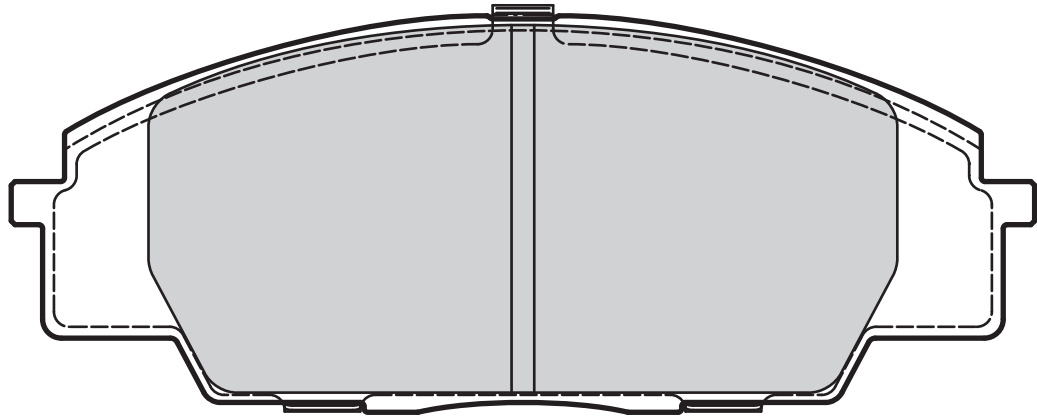

Valeo



Valeo



598907

2

Leaf

135,3

52,5

16,6

AKEBONO

HONDA

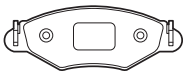

29924 (WVA)

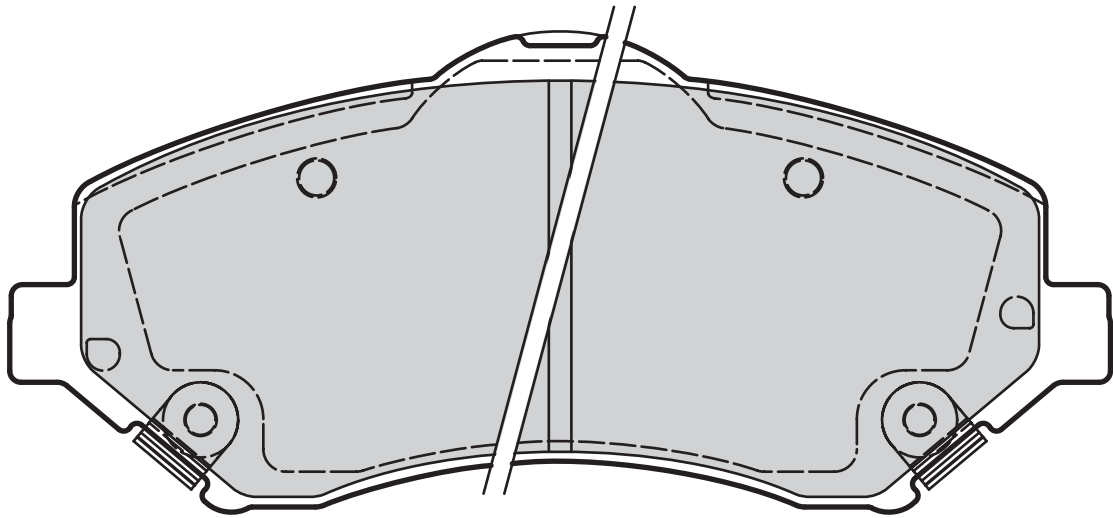
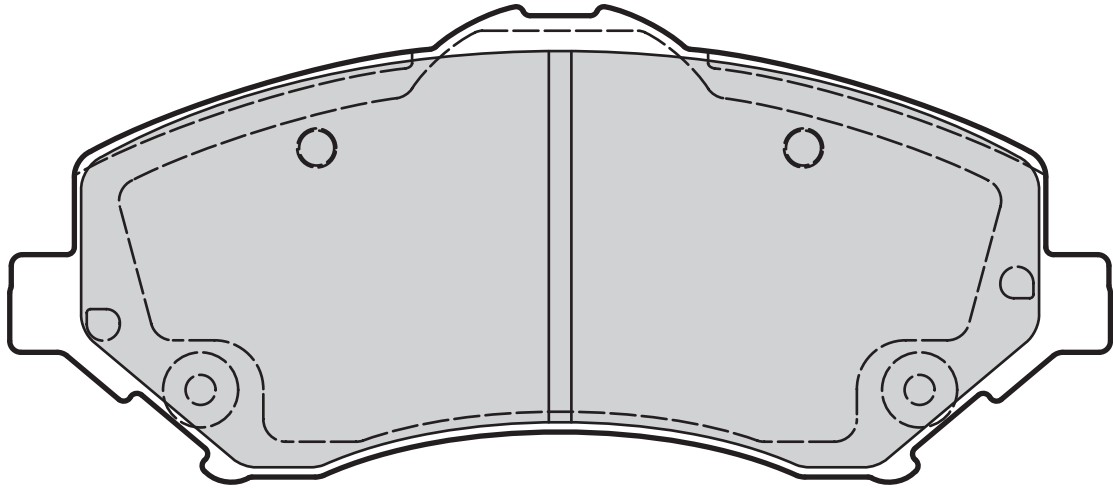

Valeo



Valeo



598924

2

Leaf

146,5

64

17,6

LUCAS

JEEP

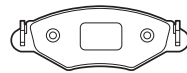

598588 (WVA)

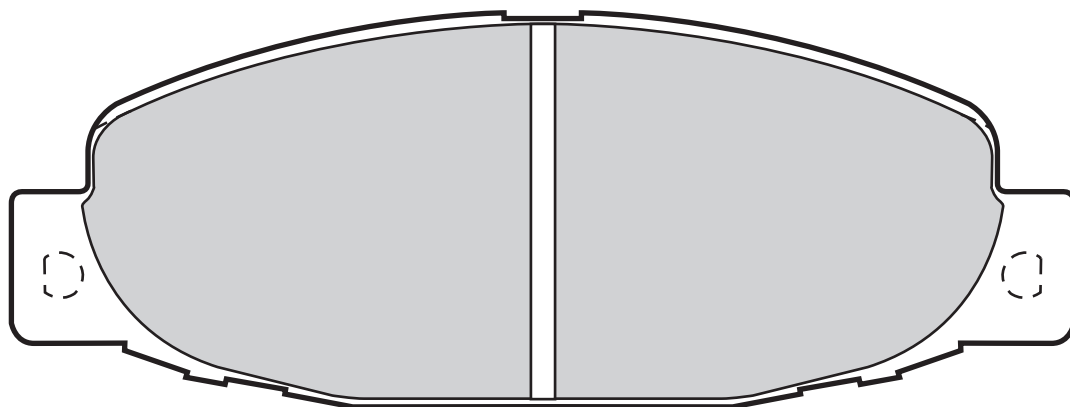
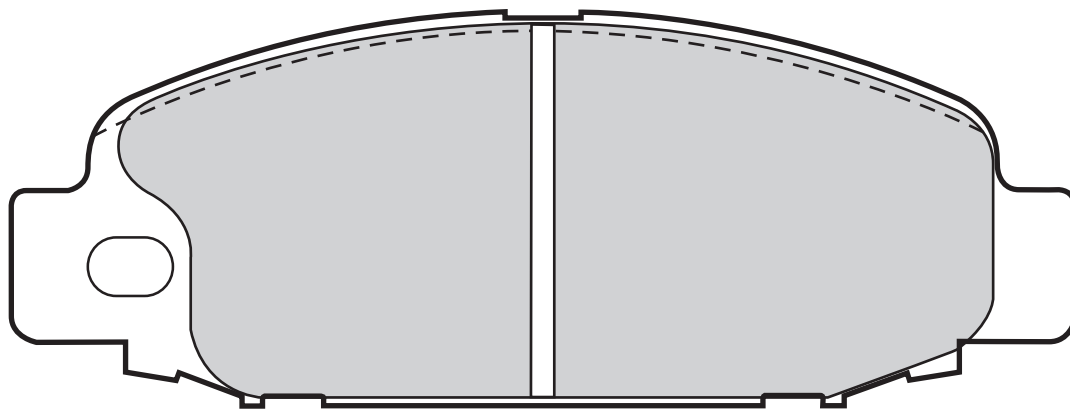

Valeo



Valeo



598588

0

140,2

51,8

18

SUMITOMO

MITSUBISHI



Pads and Discs

Plaquettes et Disques

Pastillas y Discos

Pastillas e Discos

Pastiglie e Dischi

Blokjes en Schijven

Bremsbeläge und Bremsscheiben

Klocki i Tarcze

Balatalari ve Diskleri

Κολοδκι и Δισκι

Δισκόφρενα & Δισκόπλακες

刹车片和刹车盘

بطانات و قرص

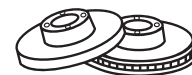

186102

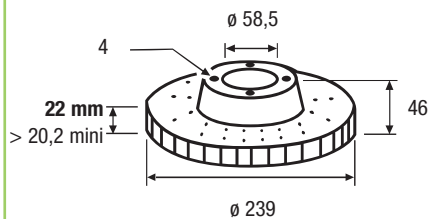

186103

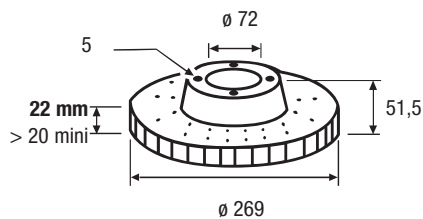

186110

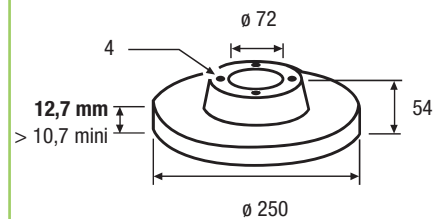

186112

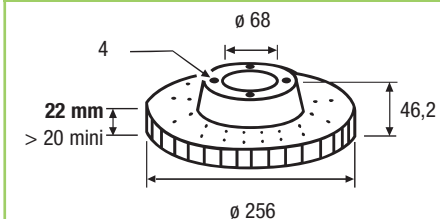

186113

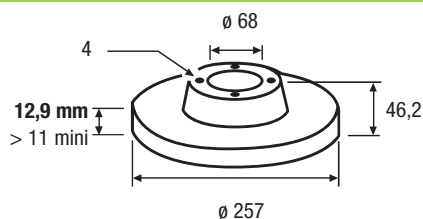

186114

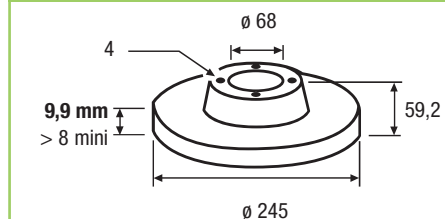

186115

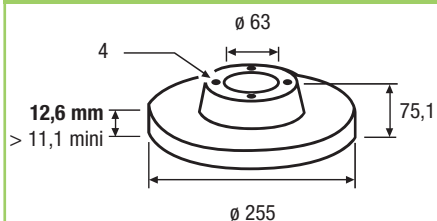

186116

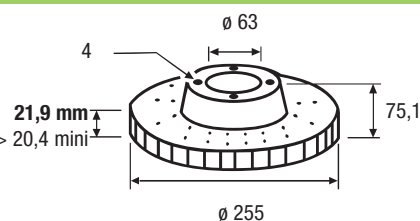

186117

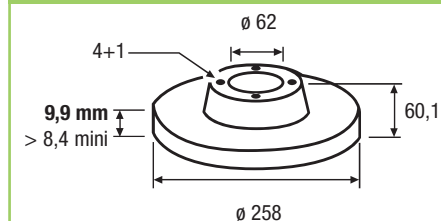

186118

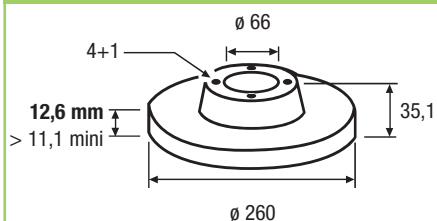

186119

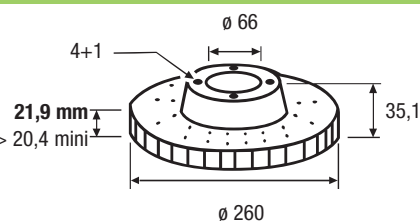

186124

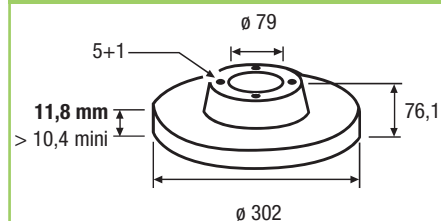

186125

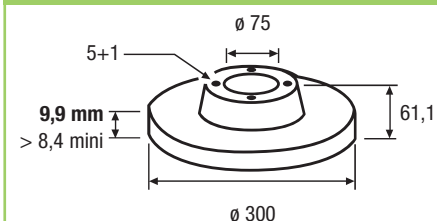

186128

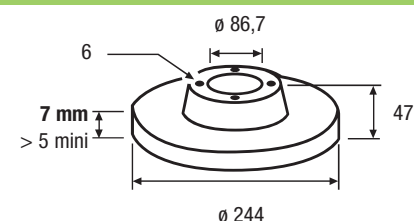

186130

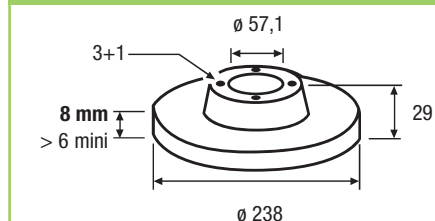

186131

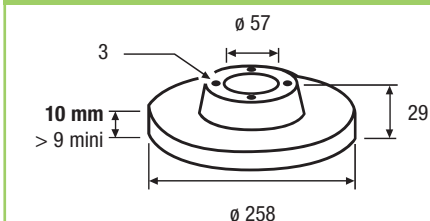

186134

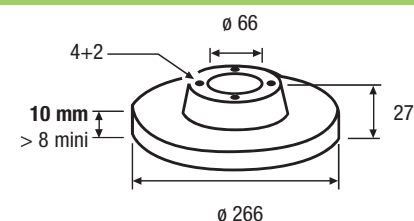

186135

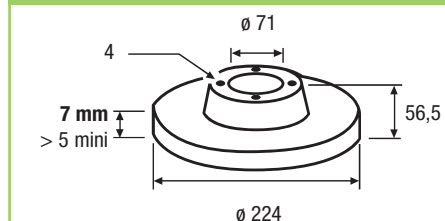

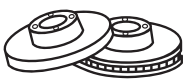

186136

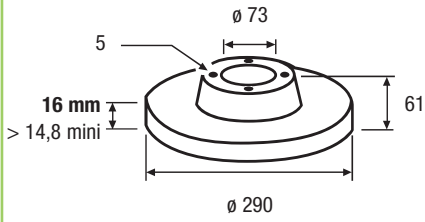

186137

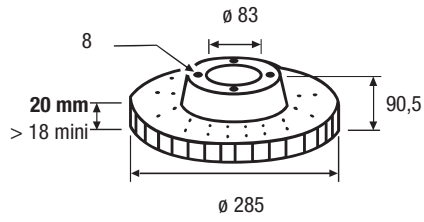

186140

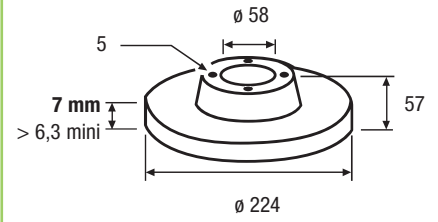

186142

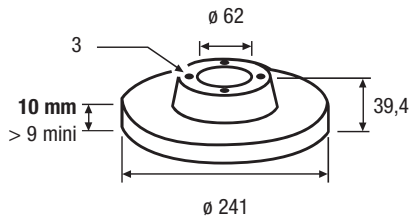

186143

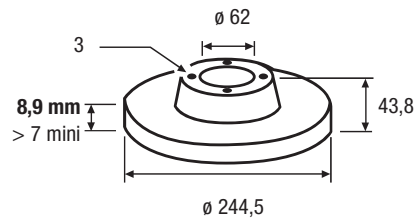

186144

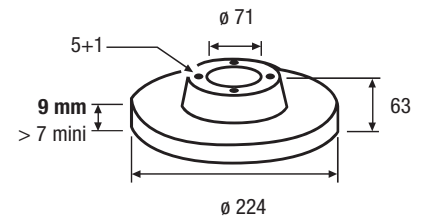

186145

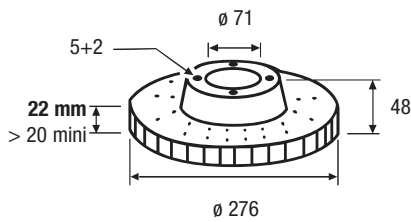

186146

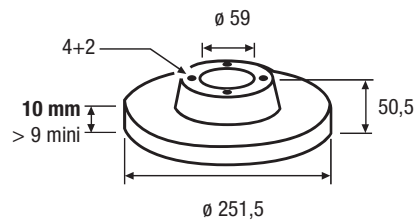

186147

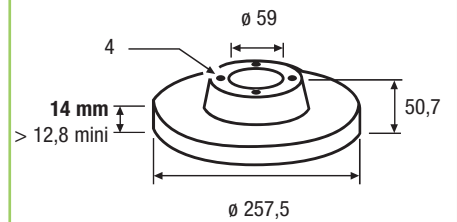

186148

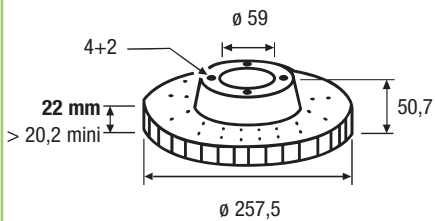

186149

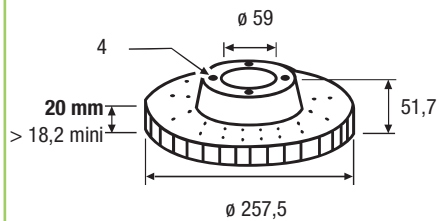

186150

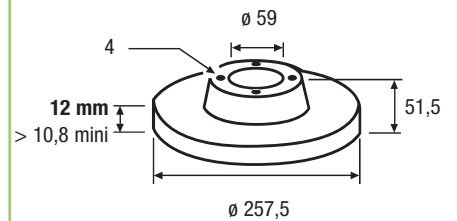

186151

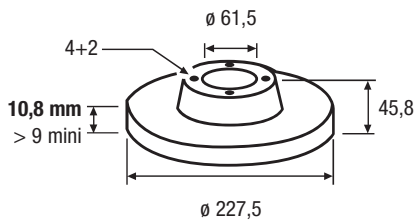

186152

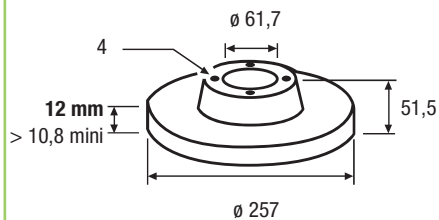

186153

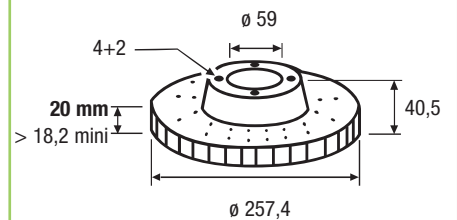

186154

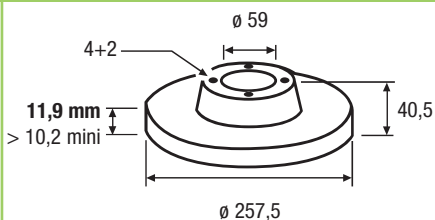

186155

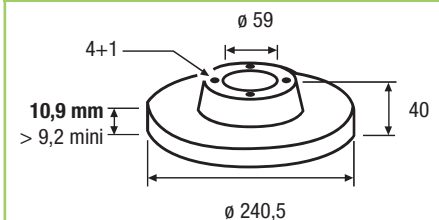

186156

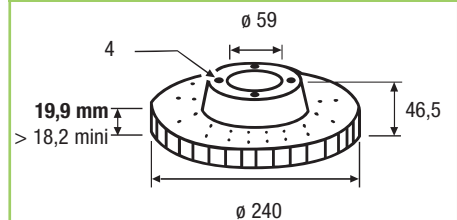

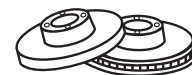

186157

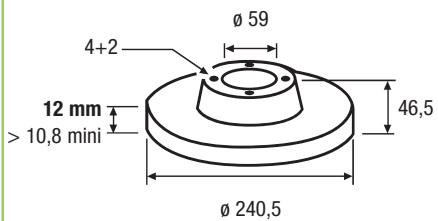

186158

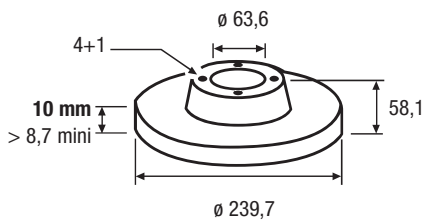

186159

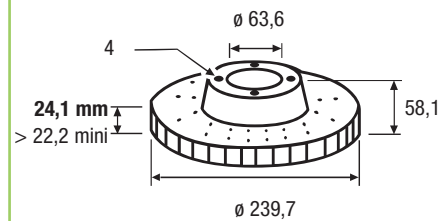

186160

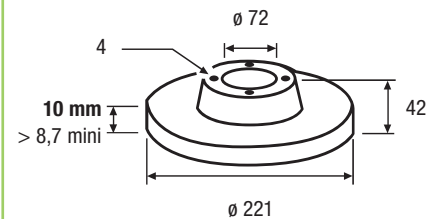

186162

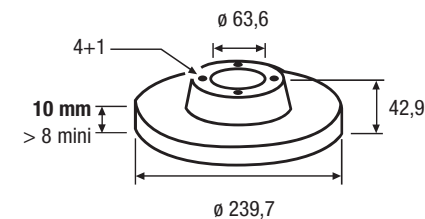

186163

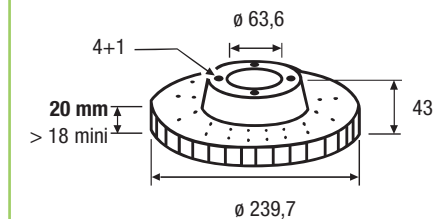

186165

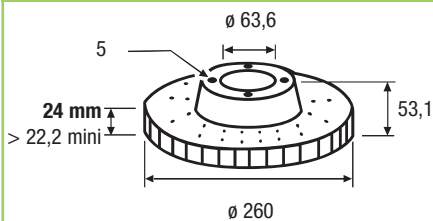

186166

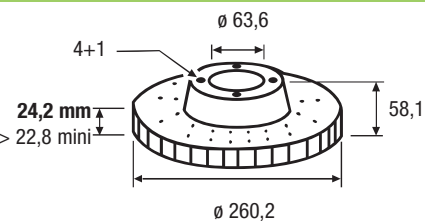

186168

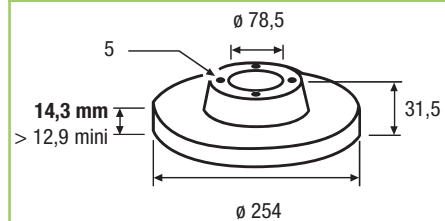

186169

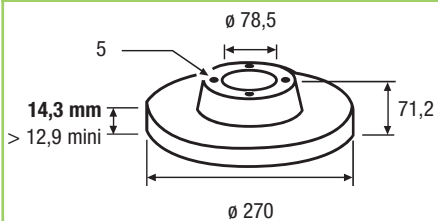

186170

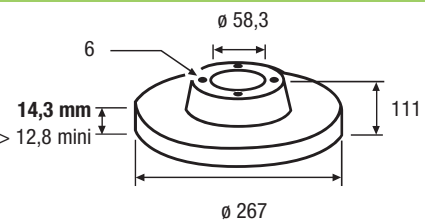

186171

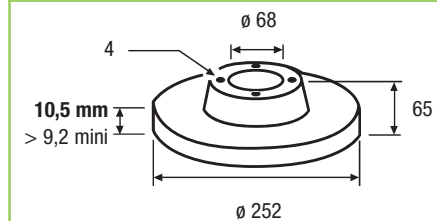

186172

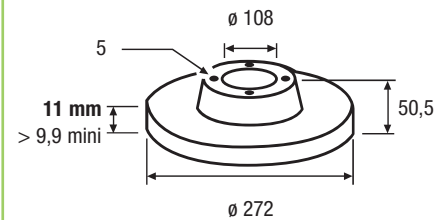

186173

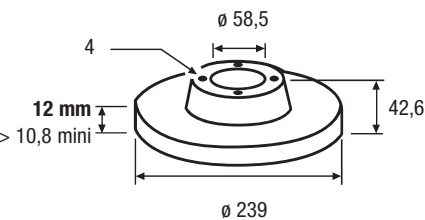

186176

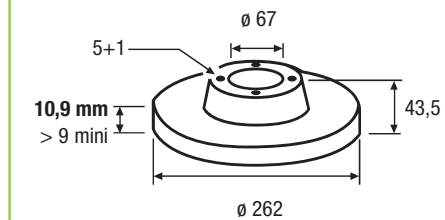

186177

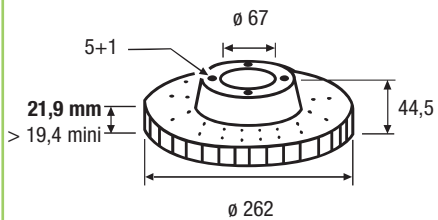

186178

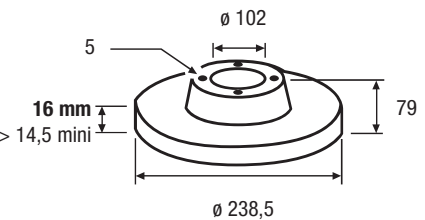

186180

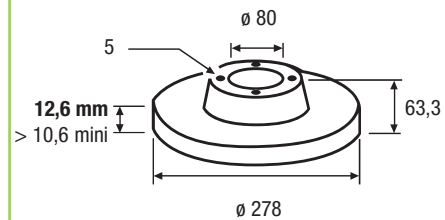



186182

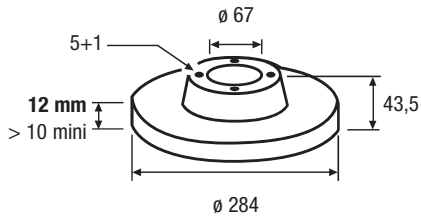

186183

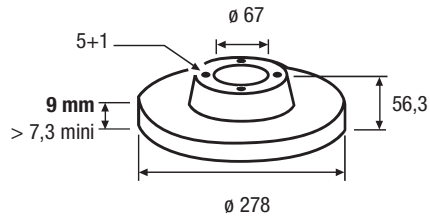

186184

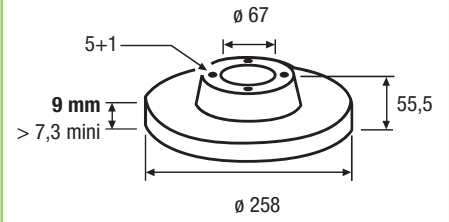

186185

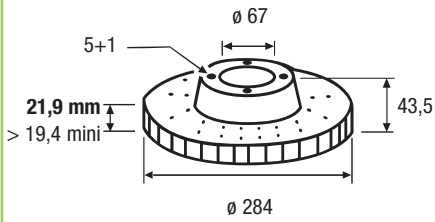

186186

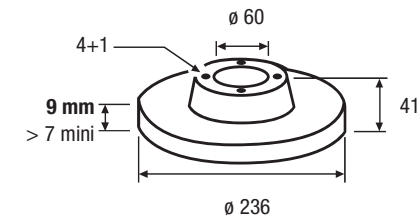

186187

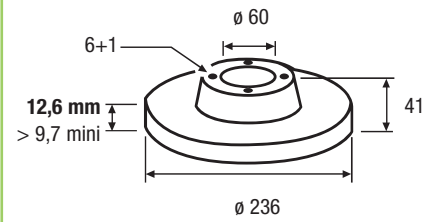

186188

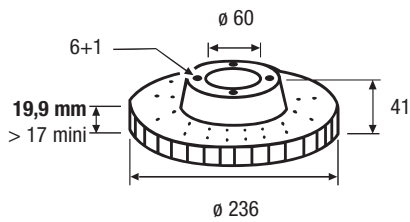

186189

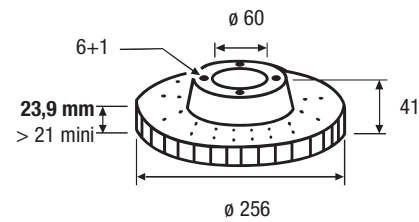

186190

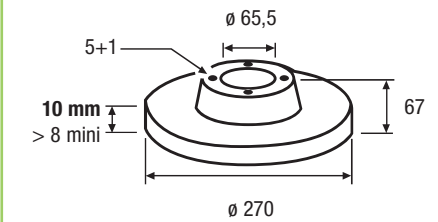

186191

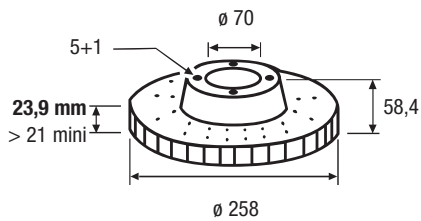

186192

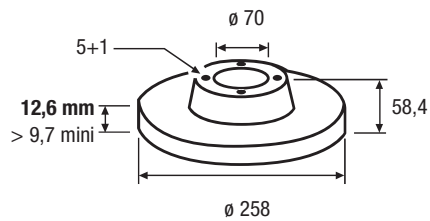

186194

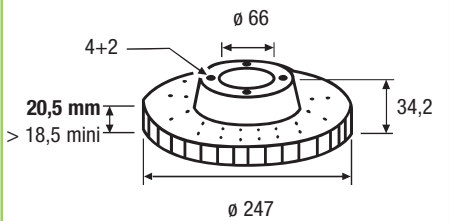

186195

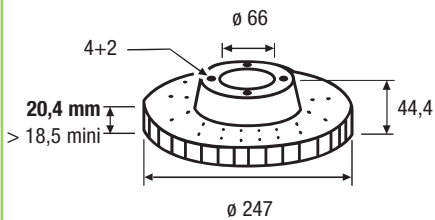

186196

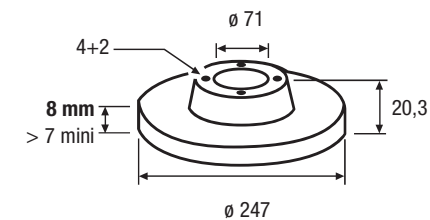

186197

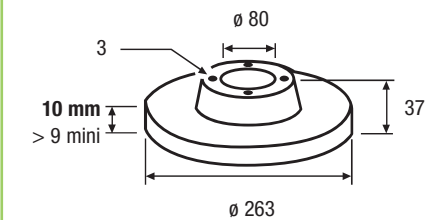

186198

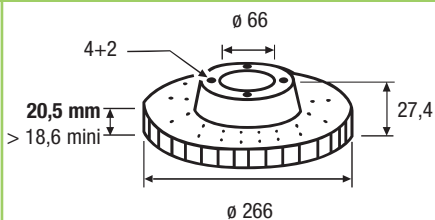

186199

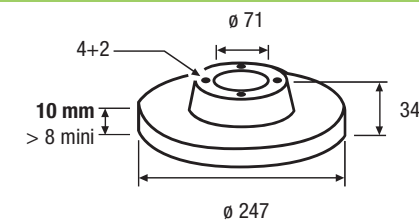

186200

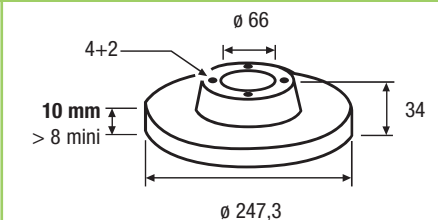

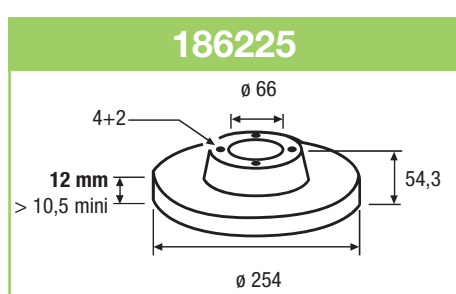
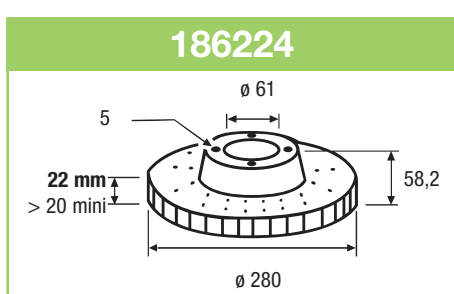
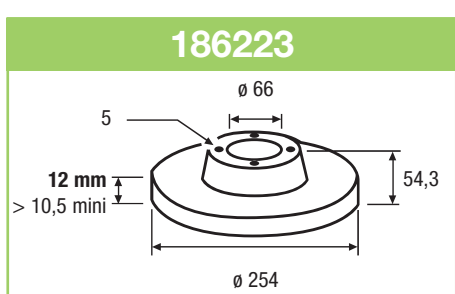
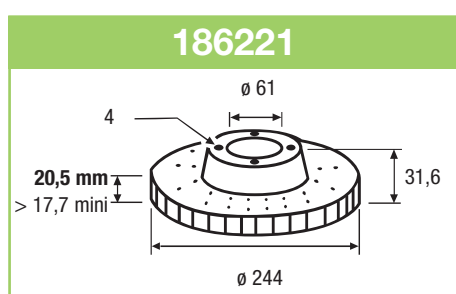
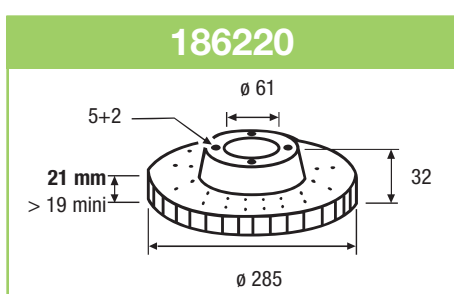
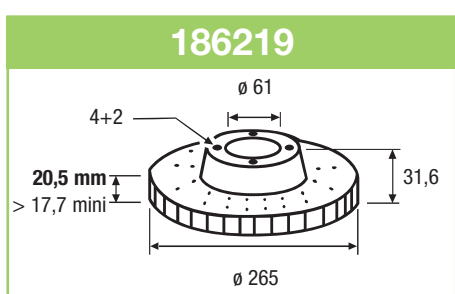
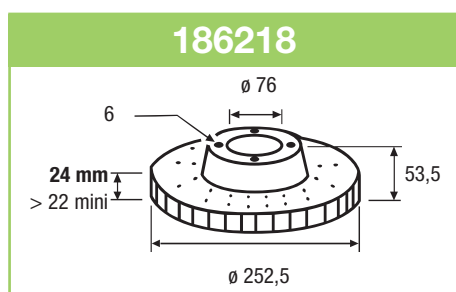
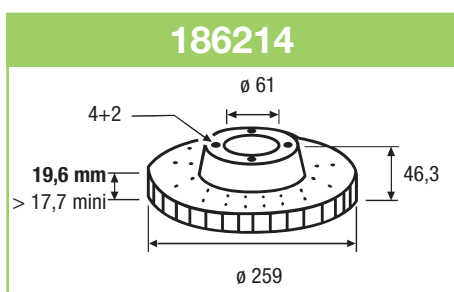
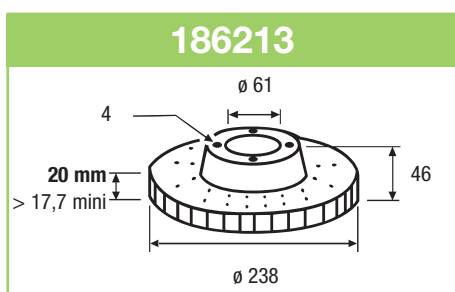
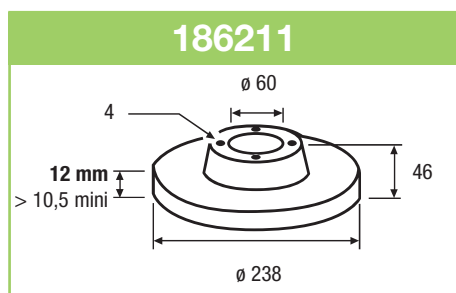
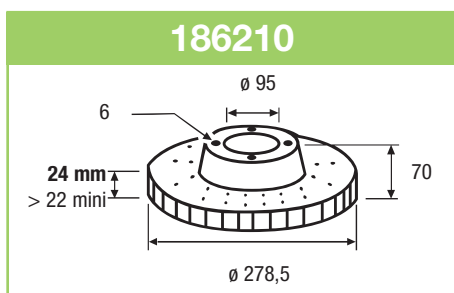
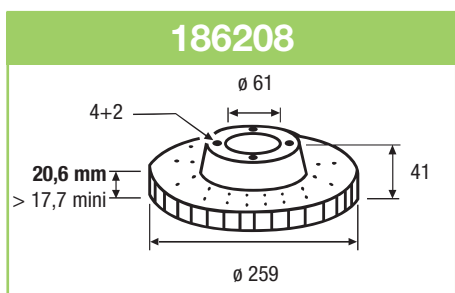
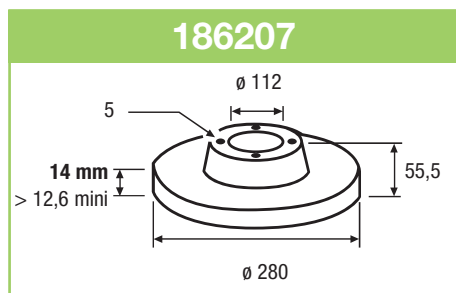
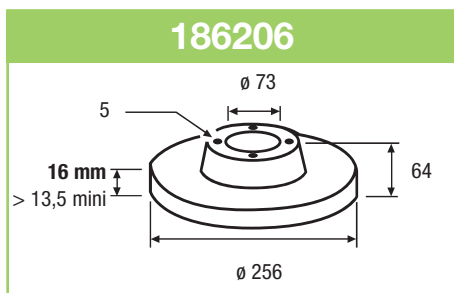
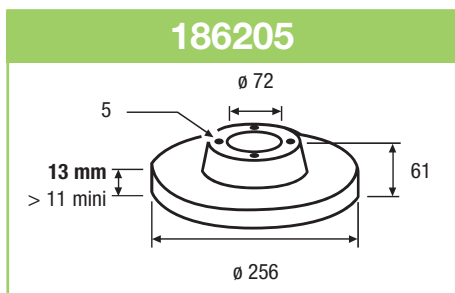
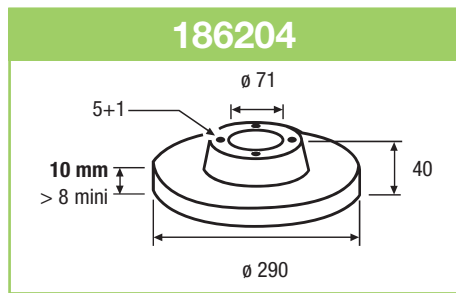
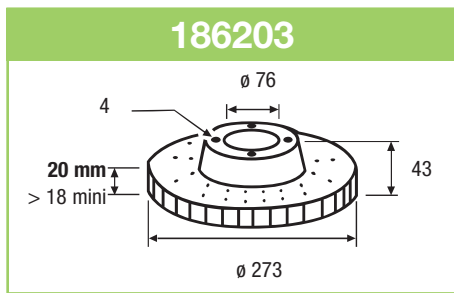
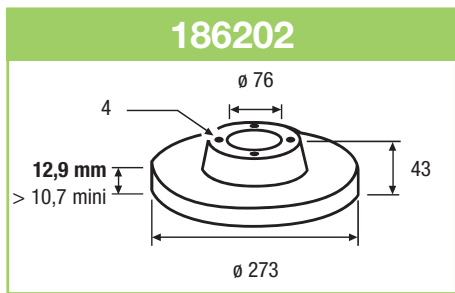
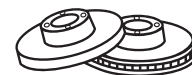

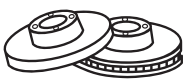

186226

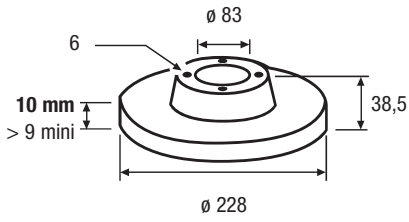

186228

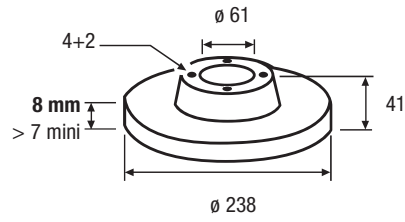

186229

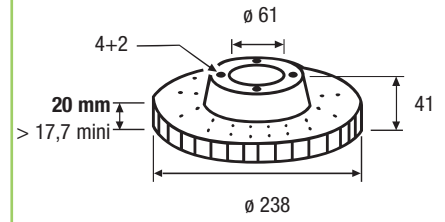

186230

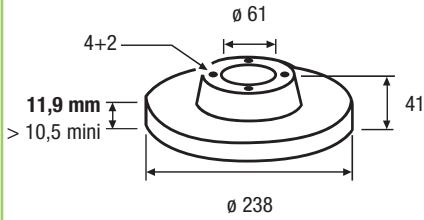

186231

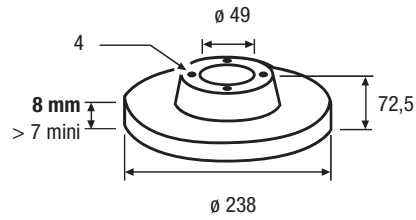

186232

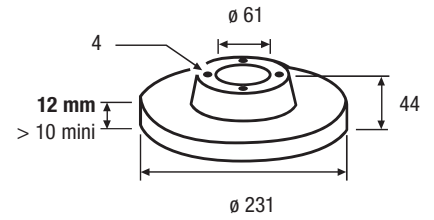

186234

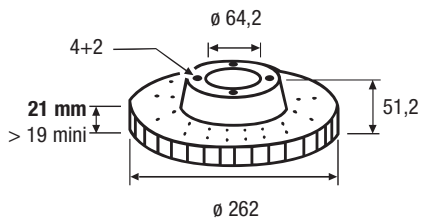

186235

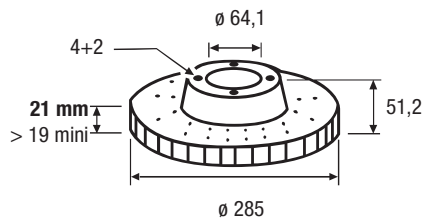

186236

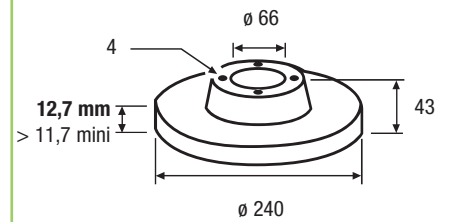

186240

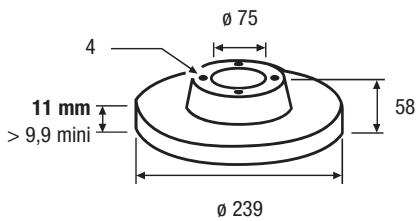

186242

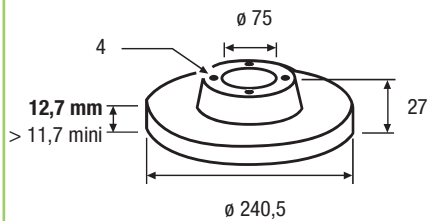

186245

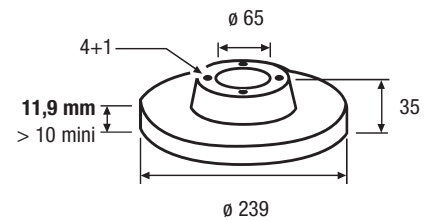

186246

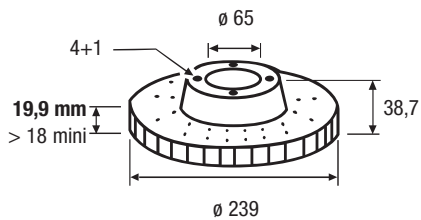

186247

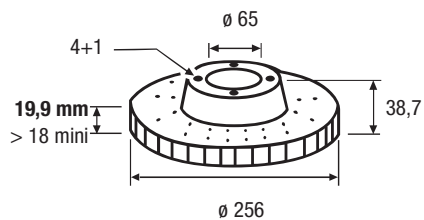

186249

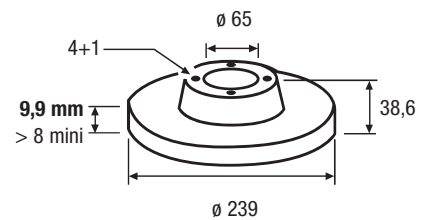

186251

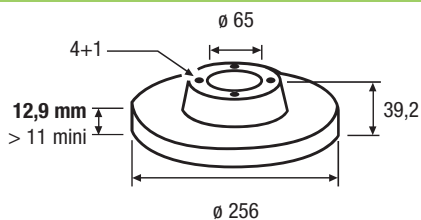

186254

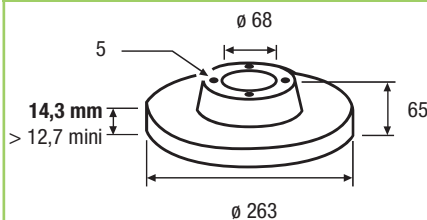

186255

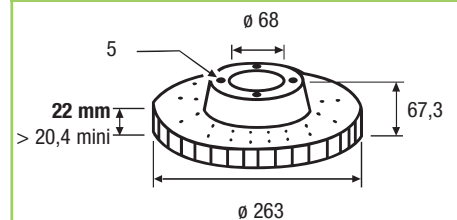

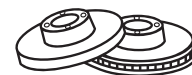

186256

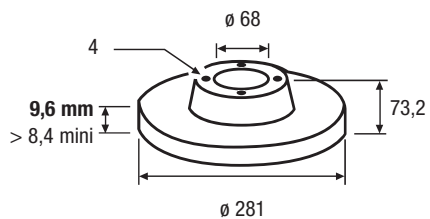

186257

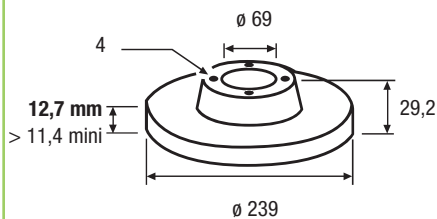

186258

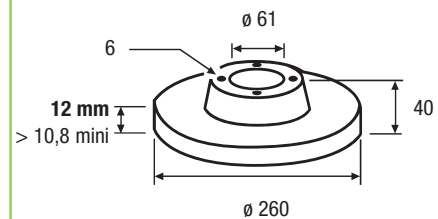

186263

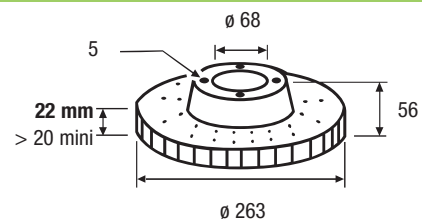

186264

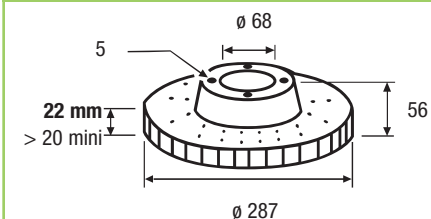

186265

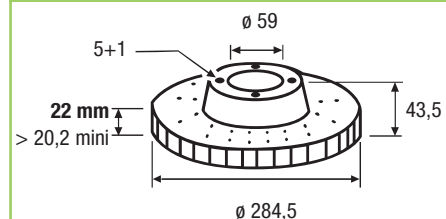

186266

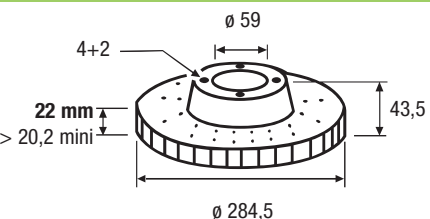

186267

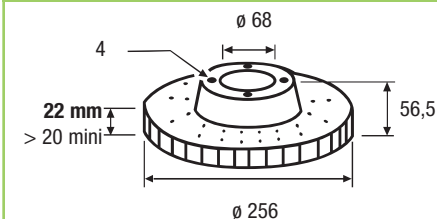

186268

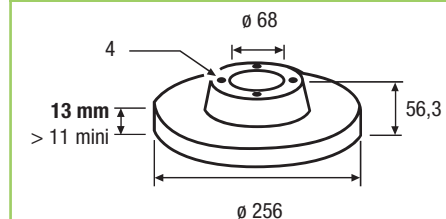

186269

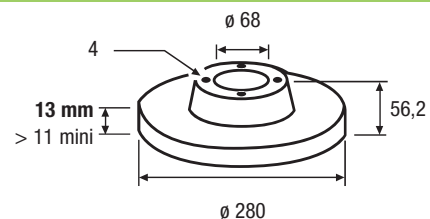

186270

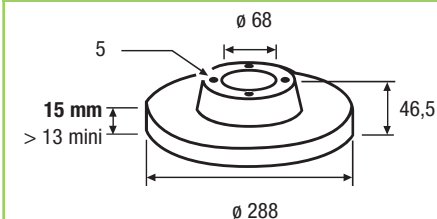

186272

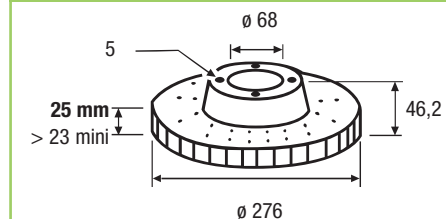

186273

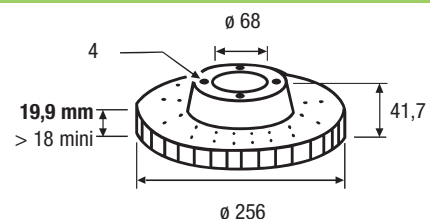

186274

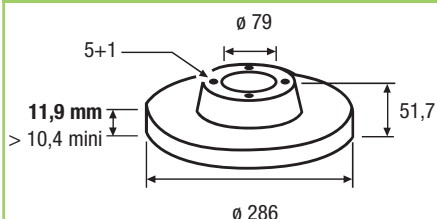

186275

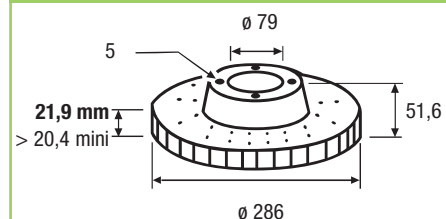

186276

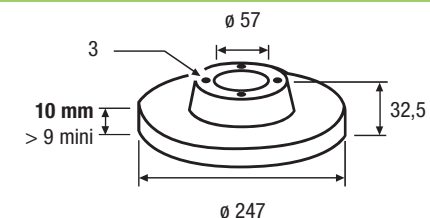

186277

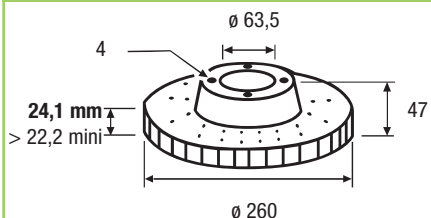

186278

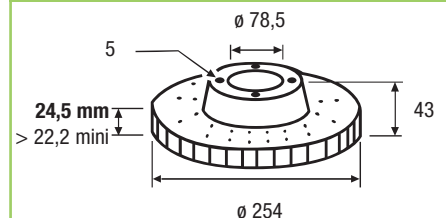



186280

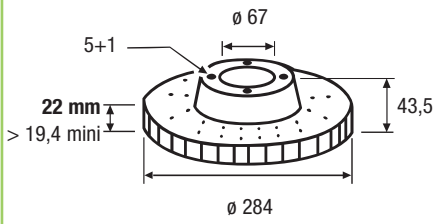

186281

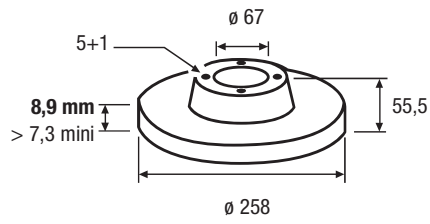

186282

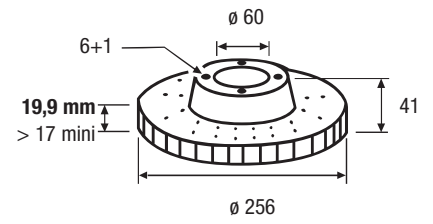

186283

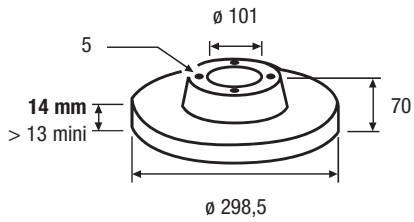

186284

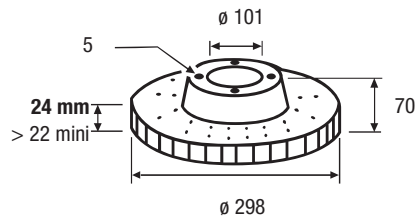

186285

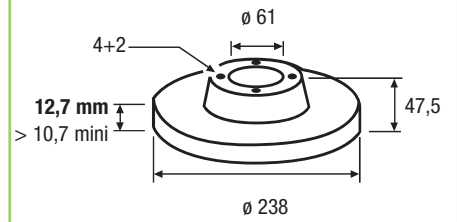

186286

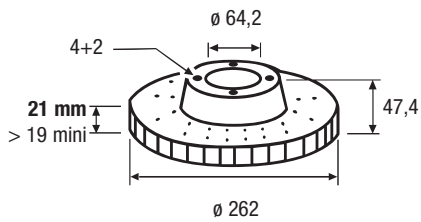

186287

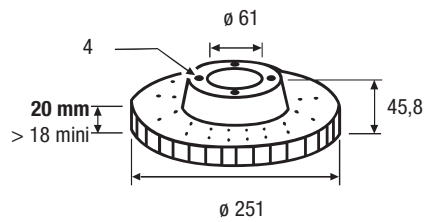

186288

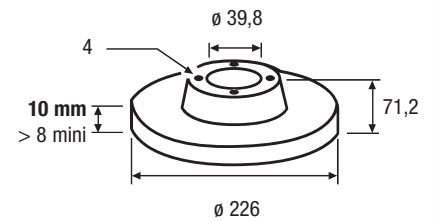

186289

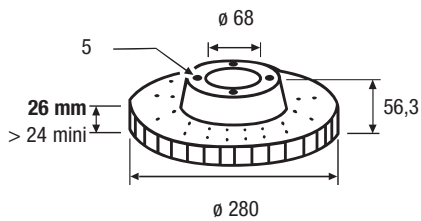

186290

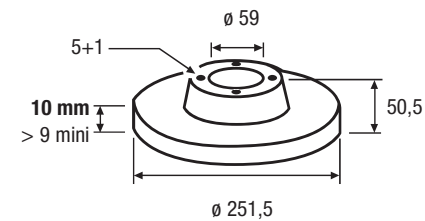

186291

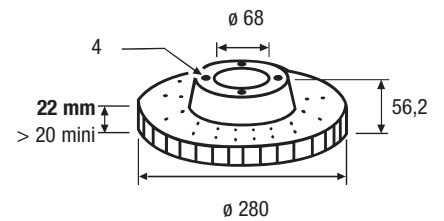

186292

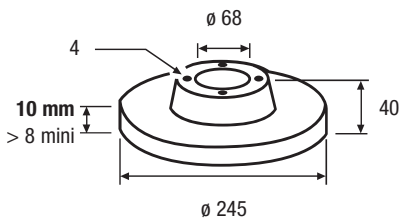

186294

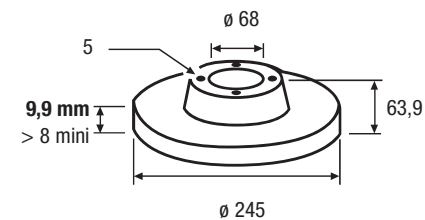

186295

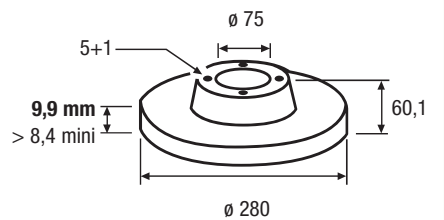

186296

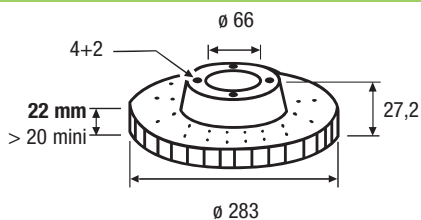

186297

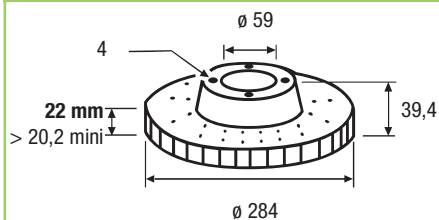

186298

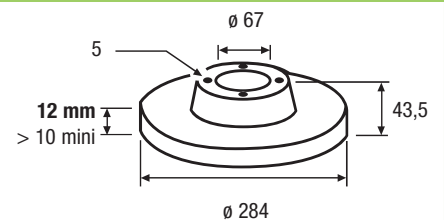

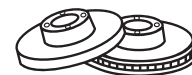

186299

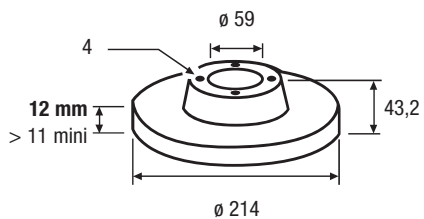

186300

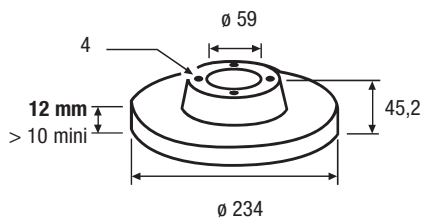

186301

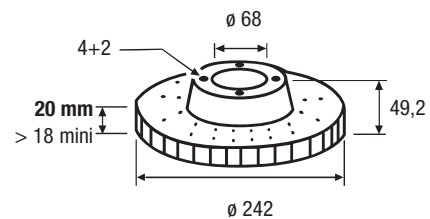

186302

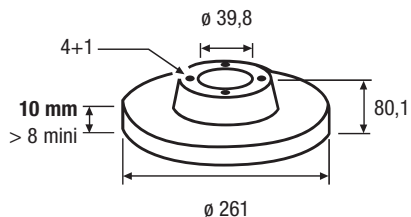

186303

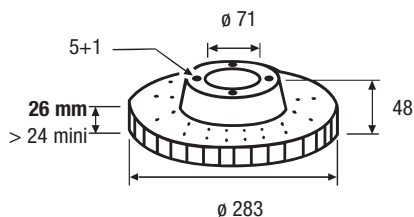

186304

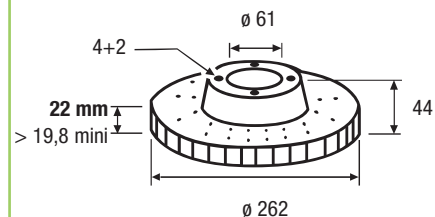

186305

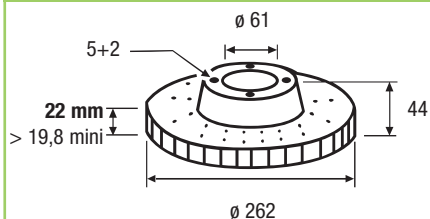

186306

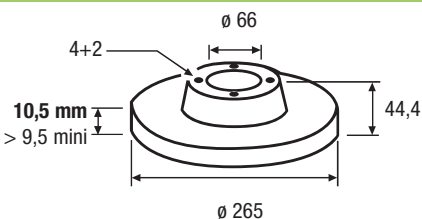

186307

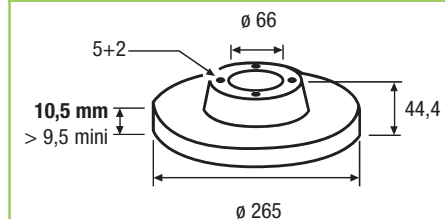

186310

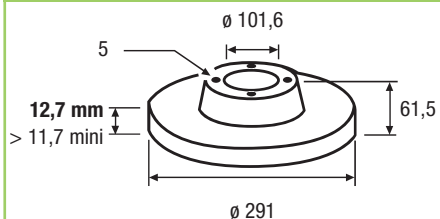

186311

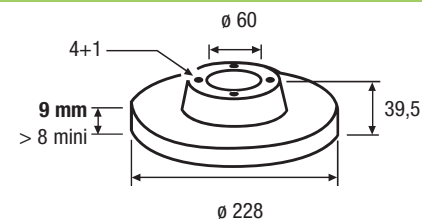

186313

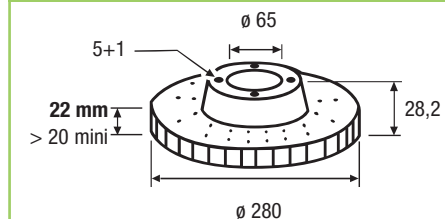

186314

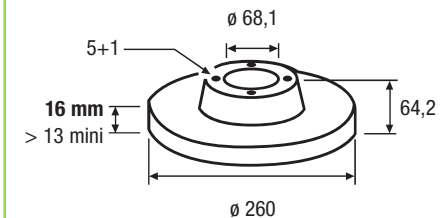

186315

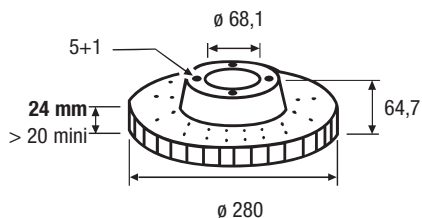

186374

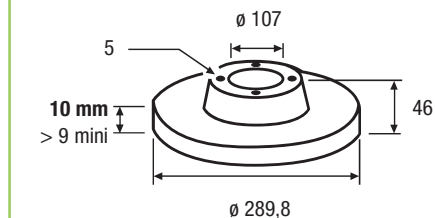

186401

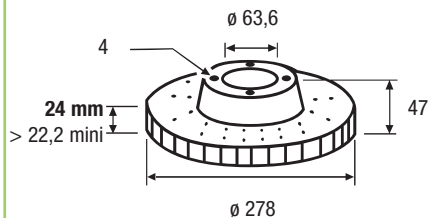

186405

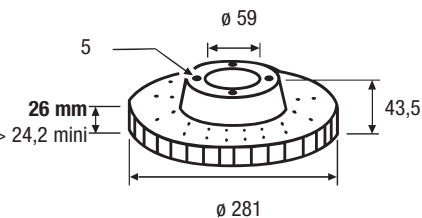

186406

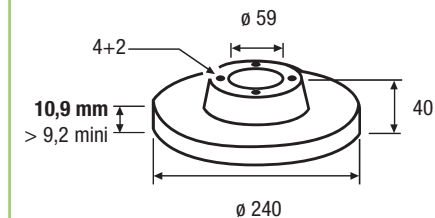

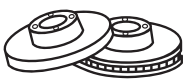

186408

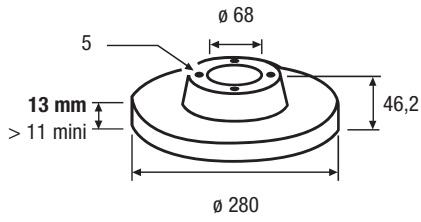

186416

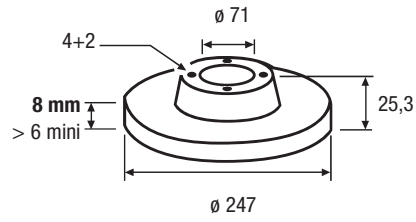

186418

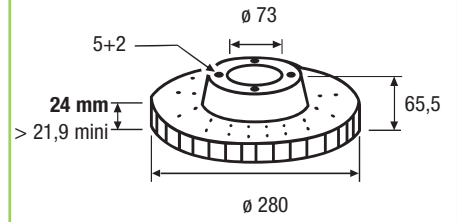

186420

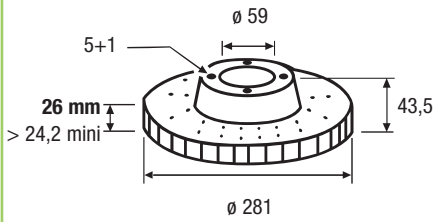

186421

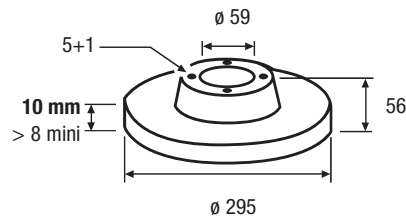

186424

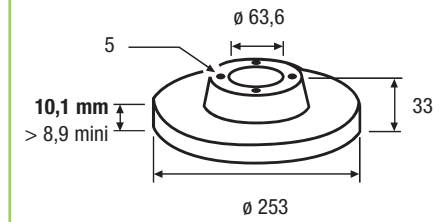

186425

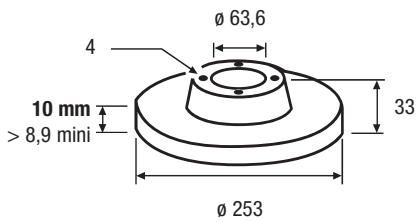

186426

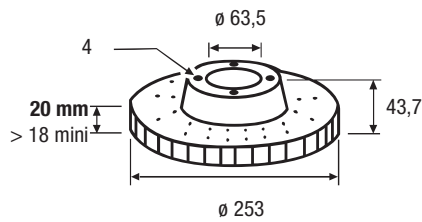

186427

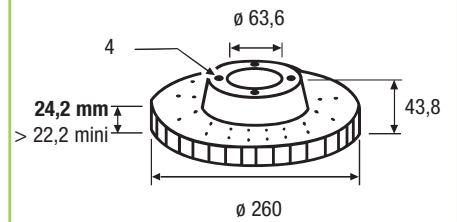

186428

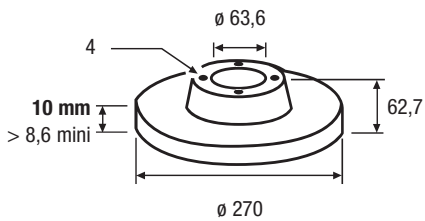

186431

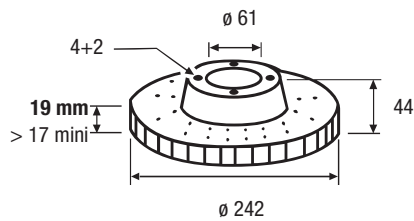

186432

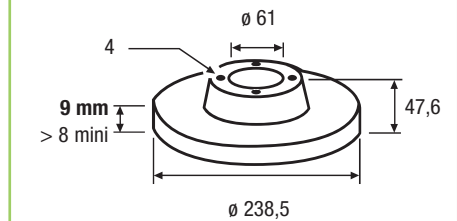

186433

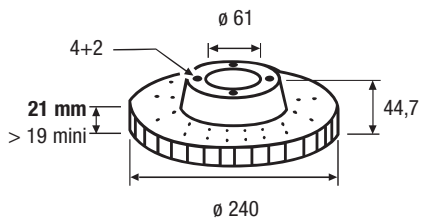

186435

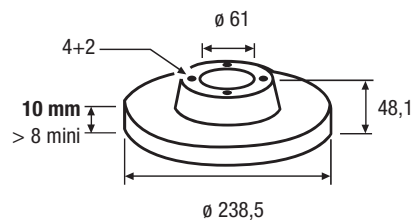

186436

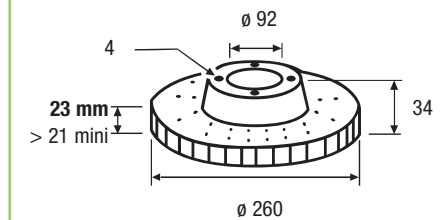

186438

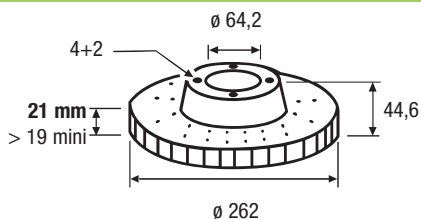

186439

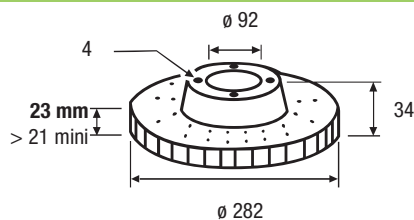

186440

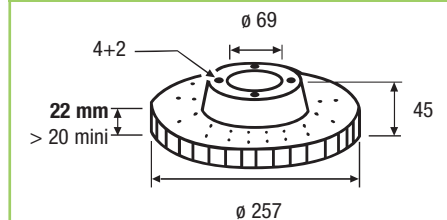

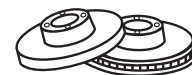

186441

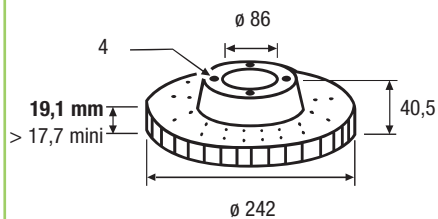

186442

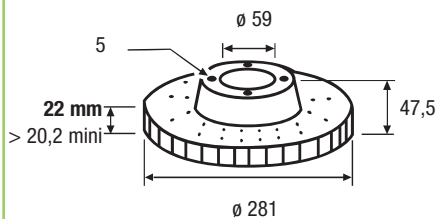

186443

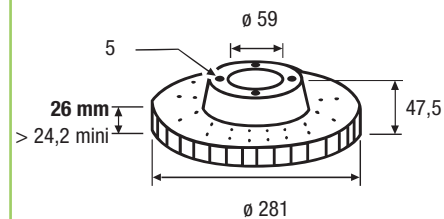

186446

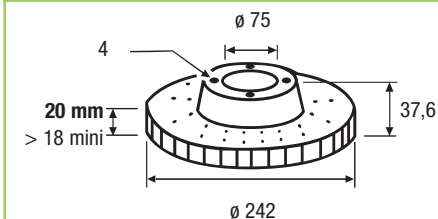

186449

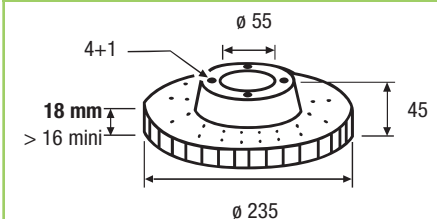

186451

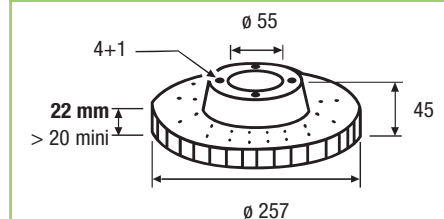

186452

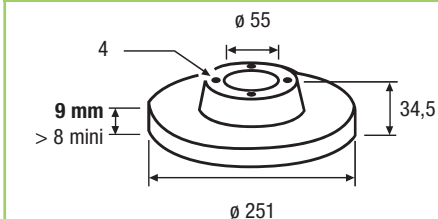

186453

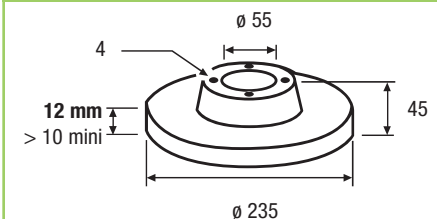

186454

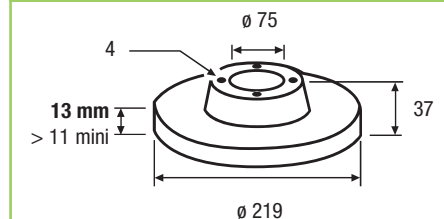

186455

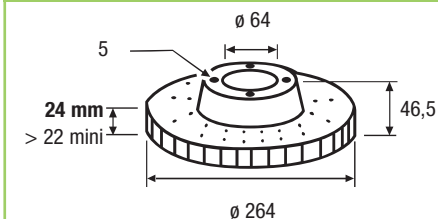

186457

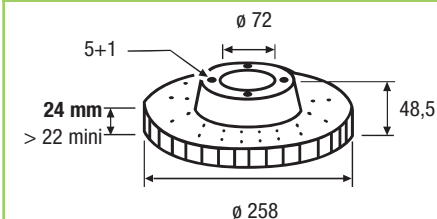

186458

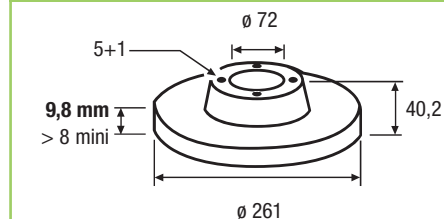

186460

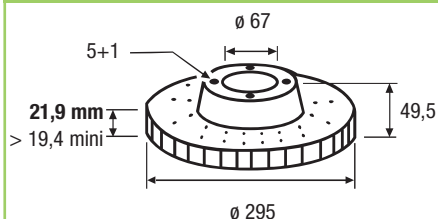

186461

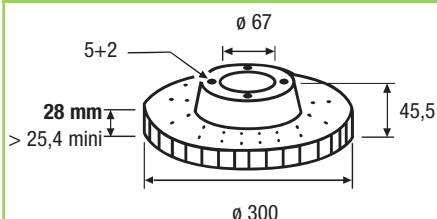

186462

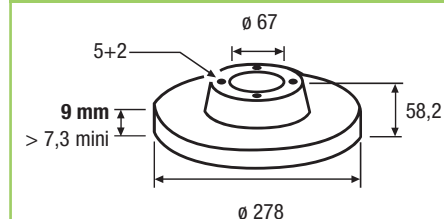

186465

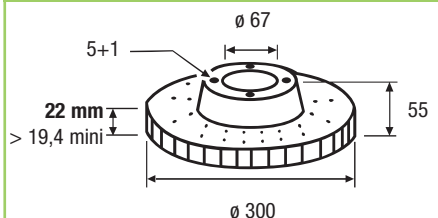

186467

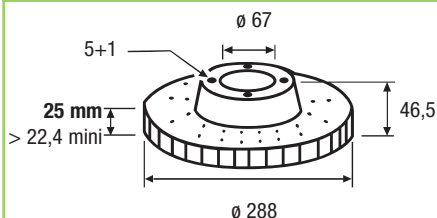

186469

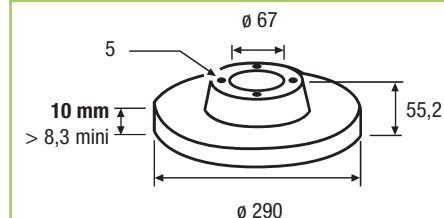



186470

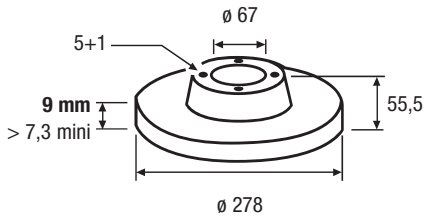

186476

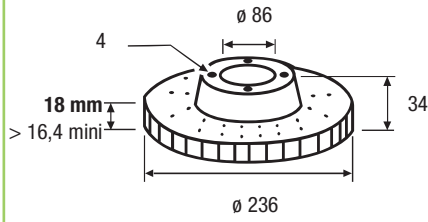

186479

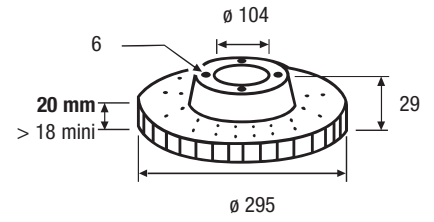

186482

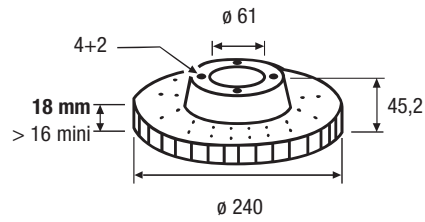

186485

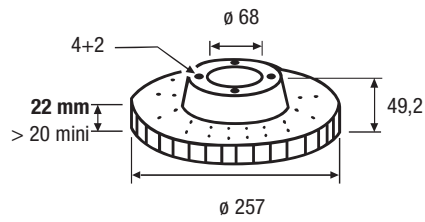

186487

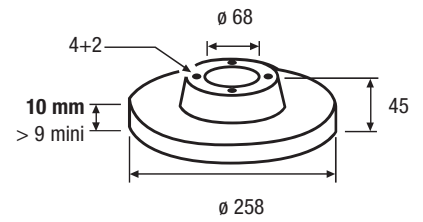

186488

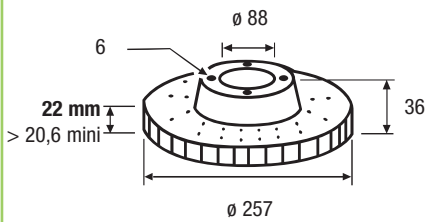

186490

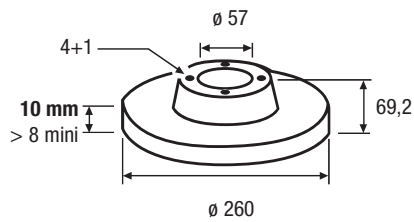

186495

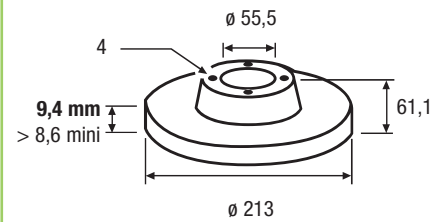

186496

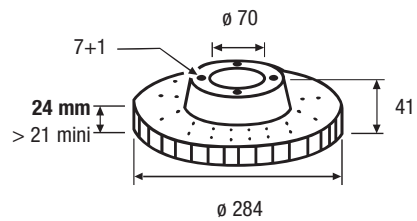

186497

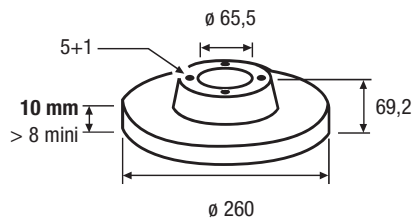

186498

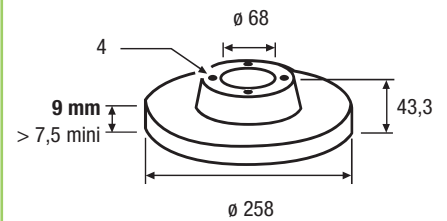

186500

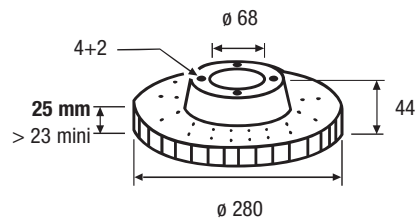

186501

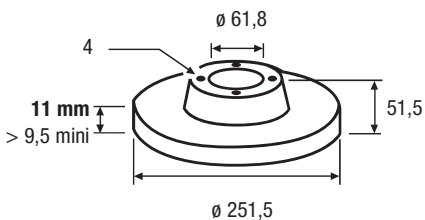

186503

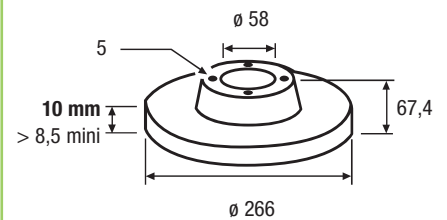

186504

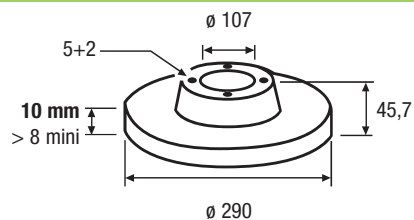

186505

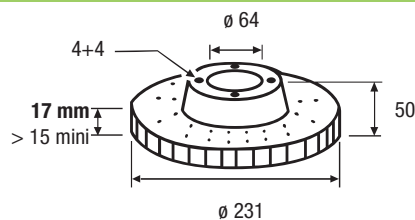

186508

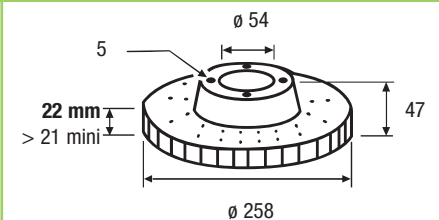

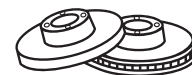

186509

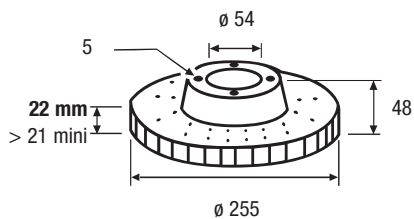

186510

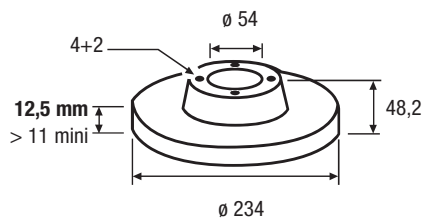

186511

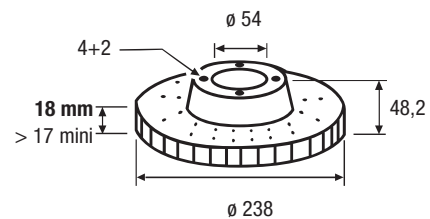

186514

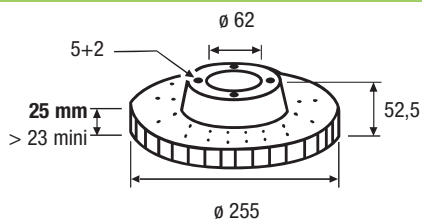

186517

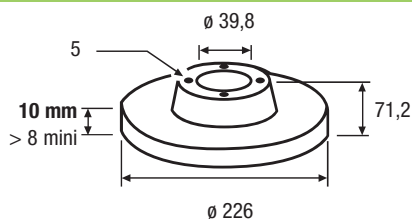

186519

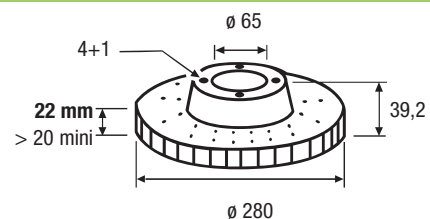

186520

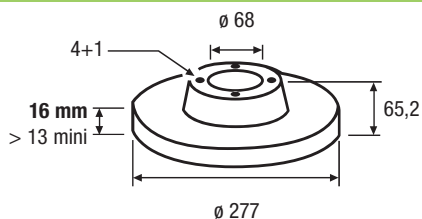

186521

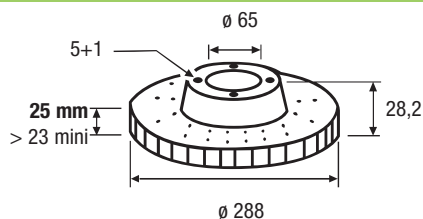

186523

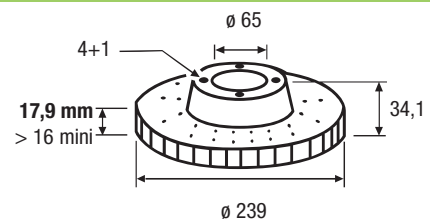

186526

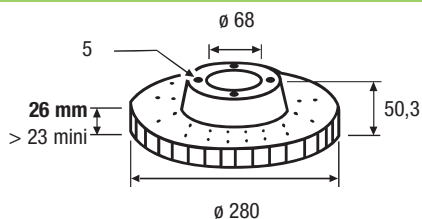

186528

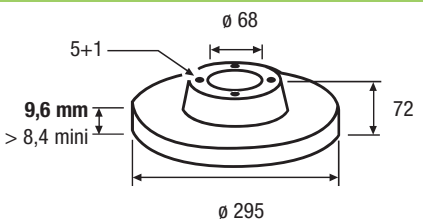

186529

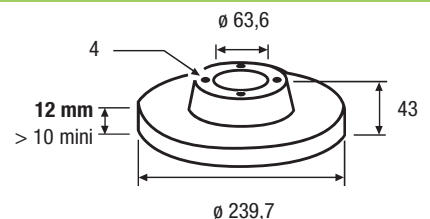

186530

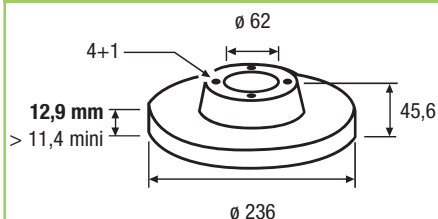

186532

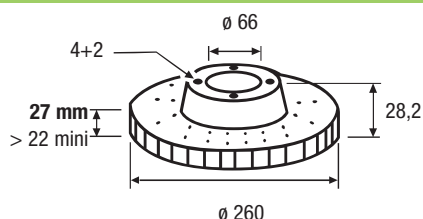

186533

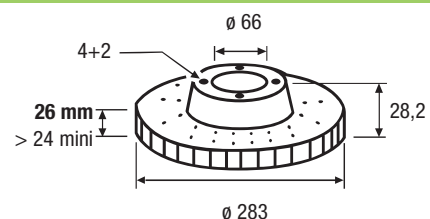

186537

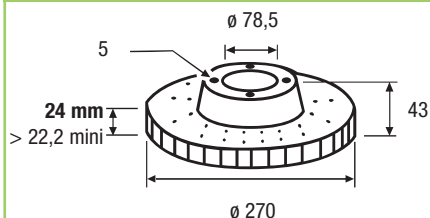

186547

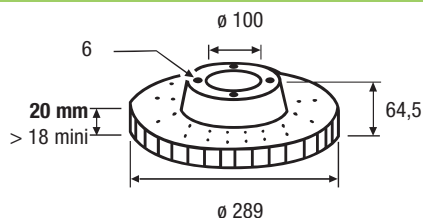

186551

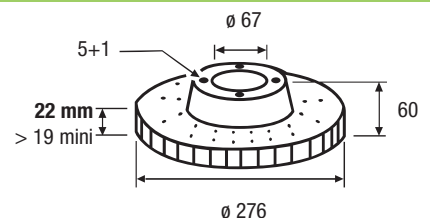

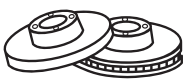

186552

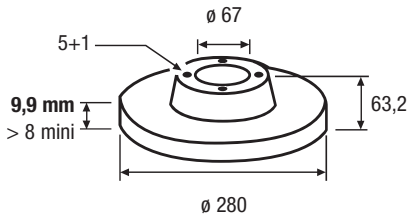

186559

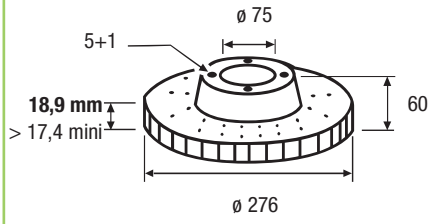

186560

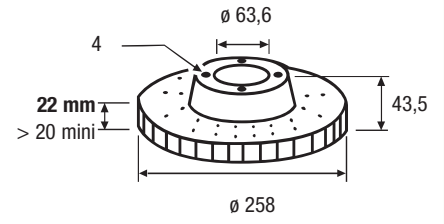

186562

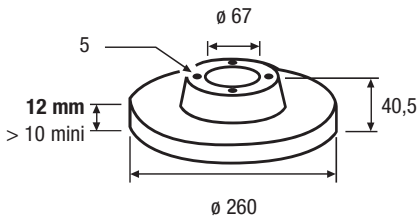

186563

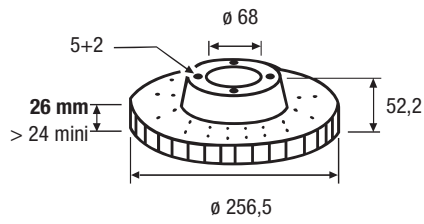

186564

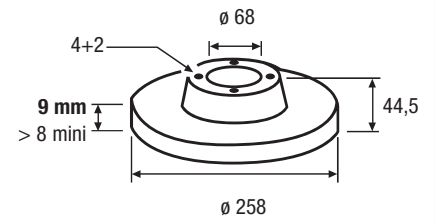

186565

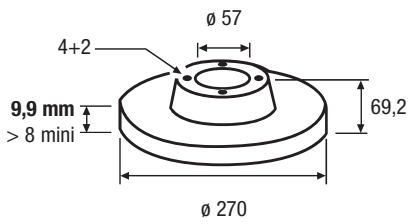

186566

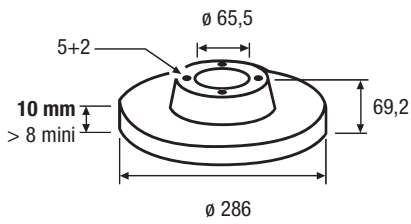

186567

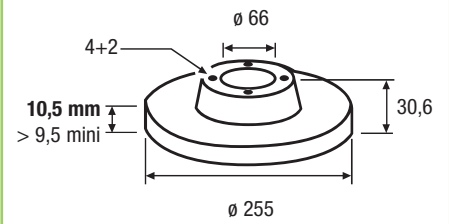

186568

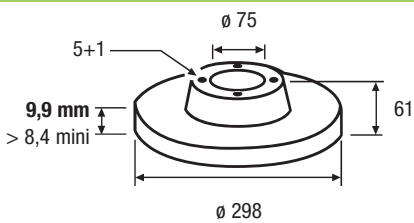

186569

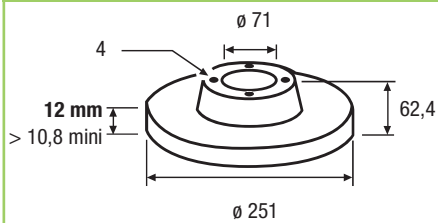

186570

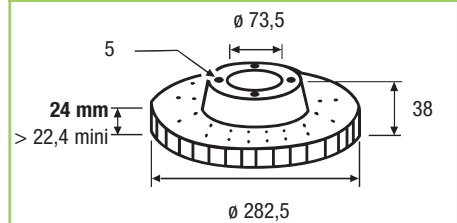

186571

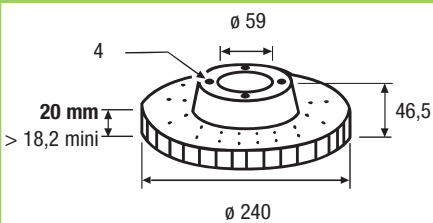

186572

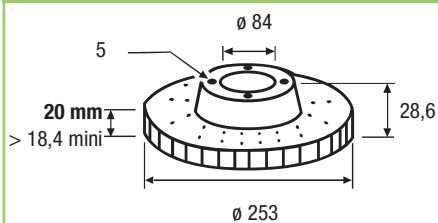

186573

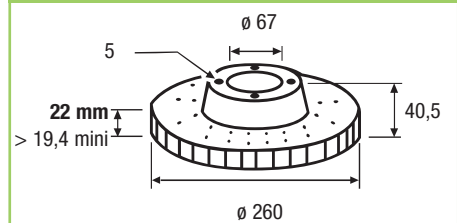

186576

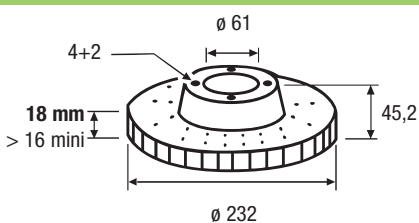

186577

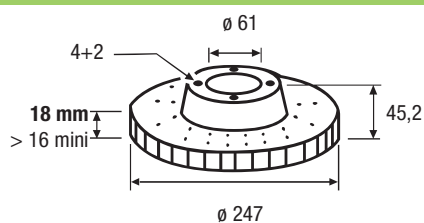

186579

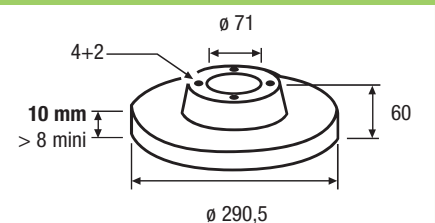

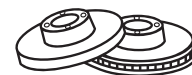

186581

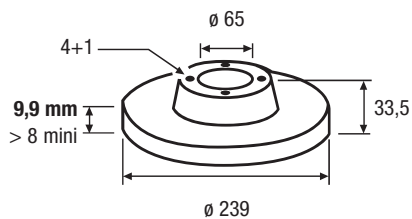

186582

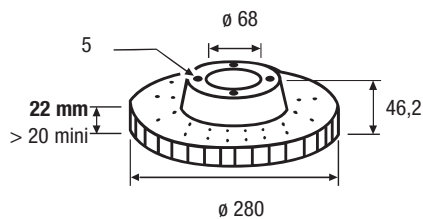

186583

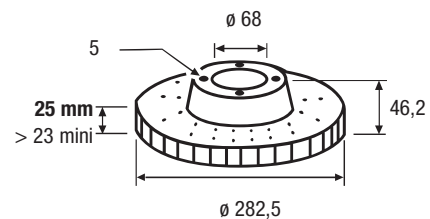

186585

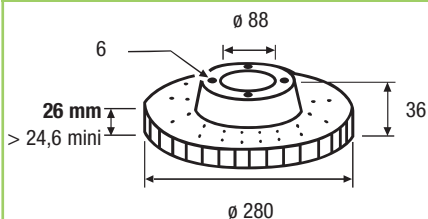

186586

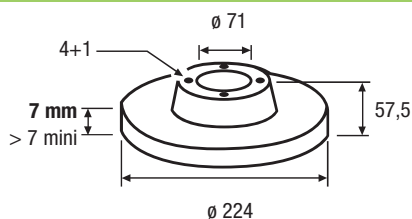

186587

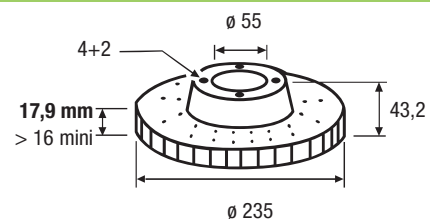

186589

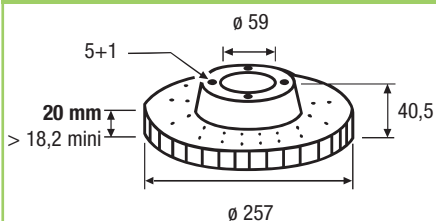

186590

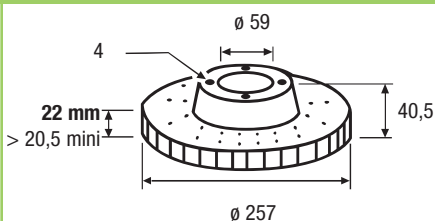

186591

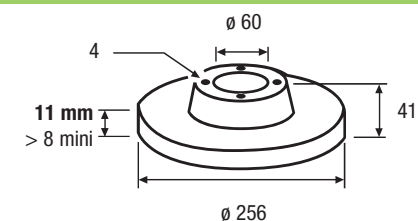

186592

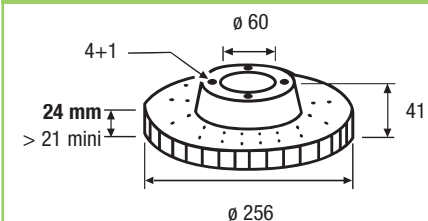

186593

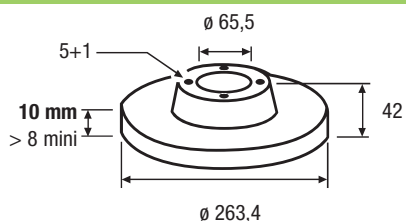

186594

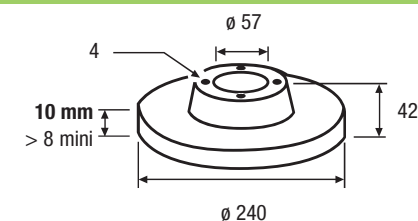

186596

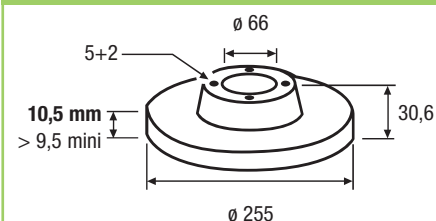

186597

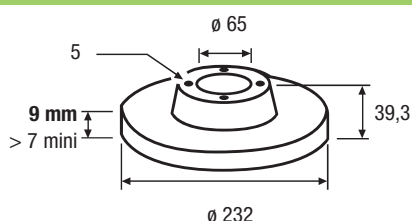

186598

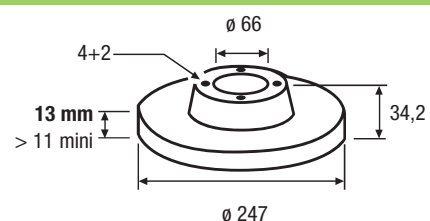

186599

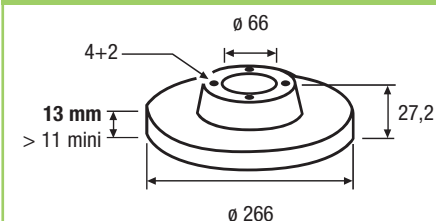

186600

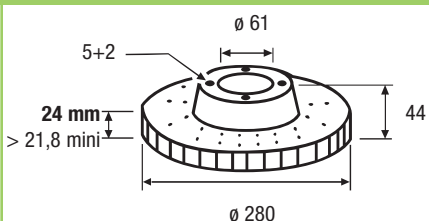

186603

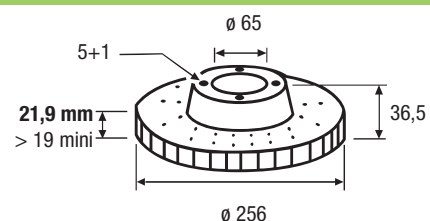

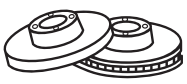

186604

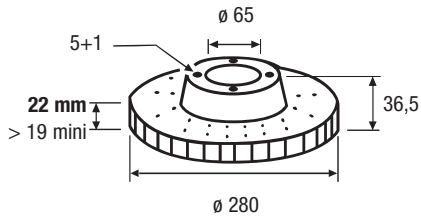

186605

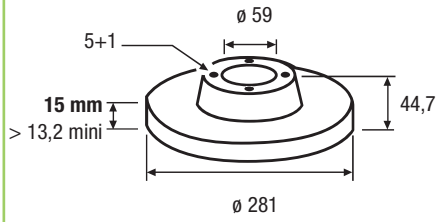

186607

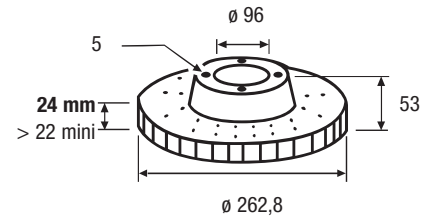

186611

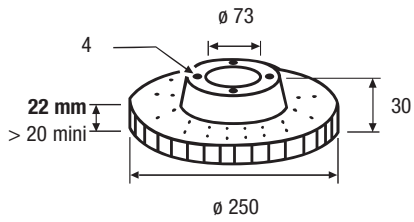

186612

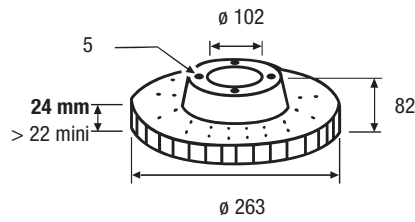

186613

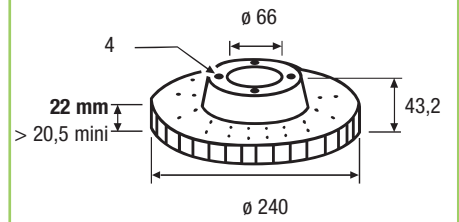

186614

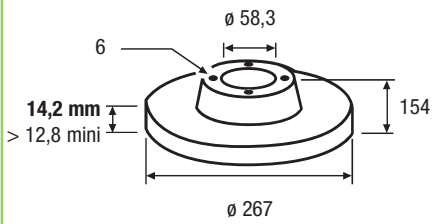

186617

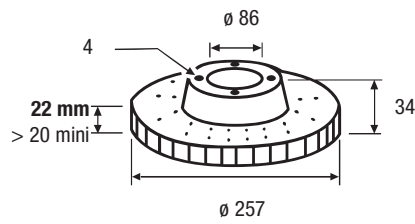

186618

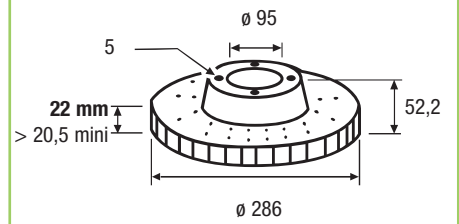

186620

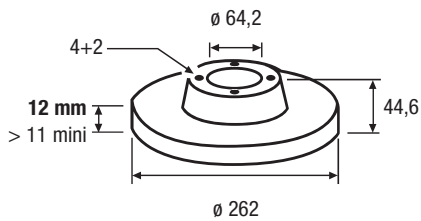

186621

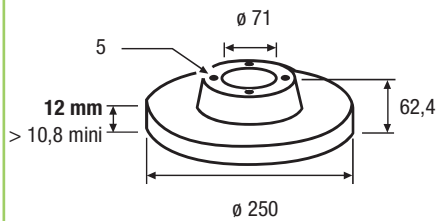

186624

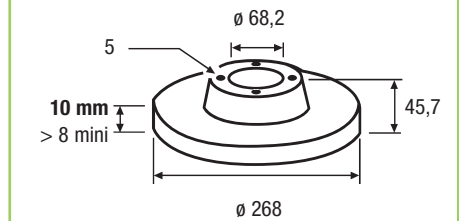

186625

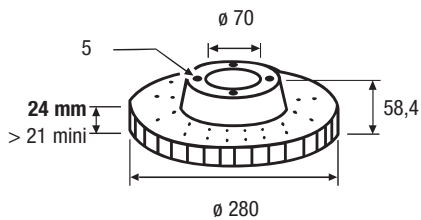

186628

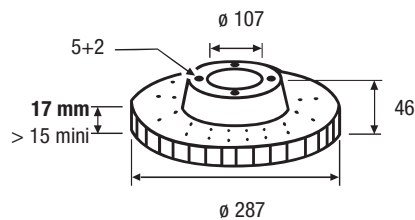

186637

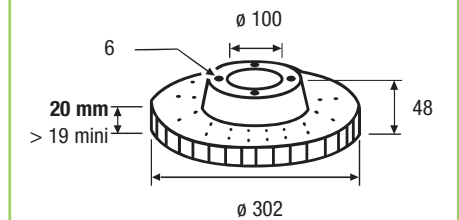

186638

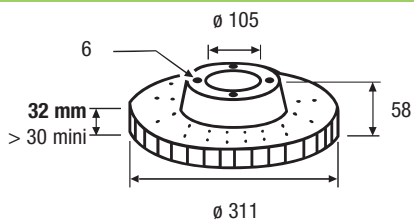

186640

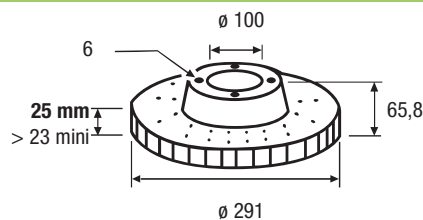

186642

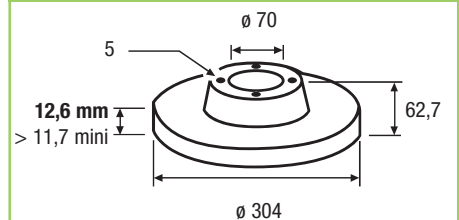

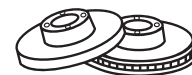

186643

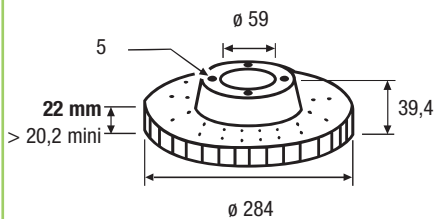

186644

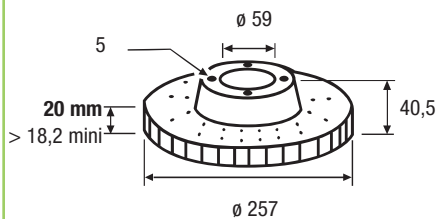

186645

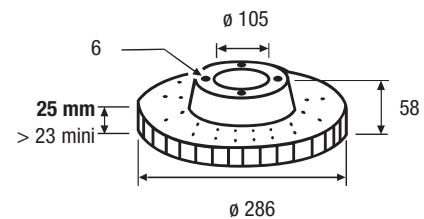

186647

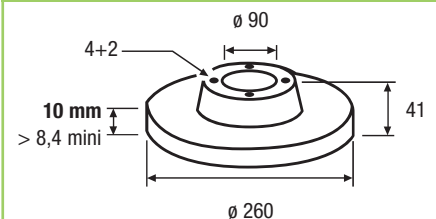

186648

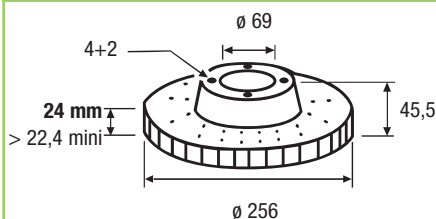

186652

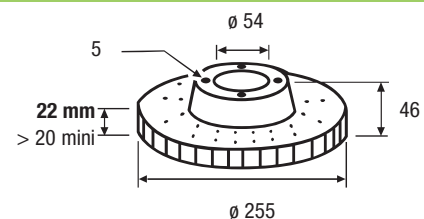

186653

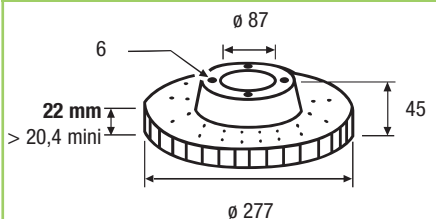

186654

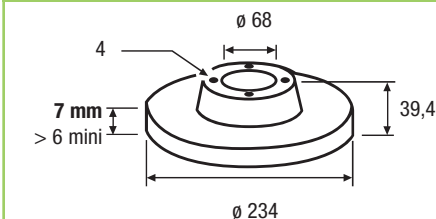

186655

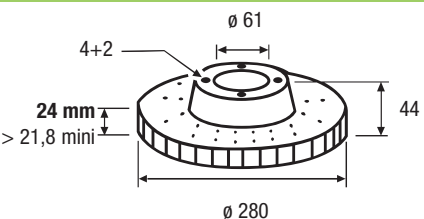

186664

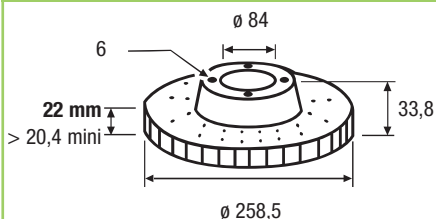

186665

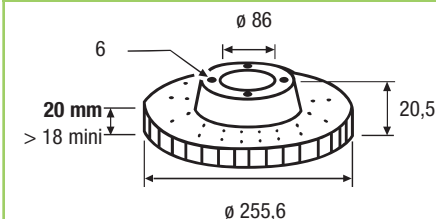

186681

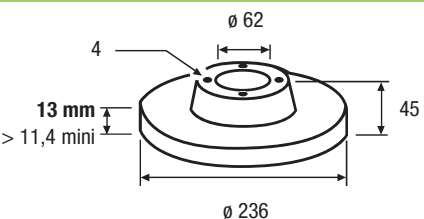

186682

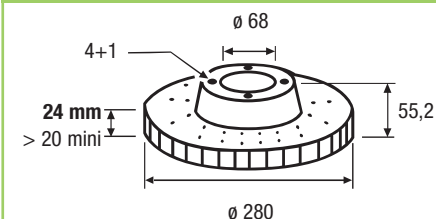

186684

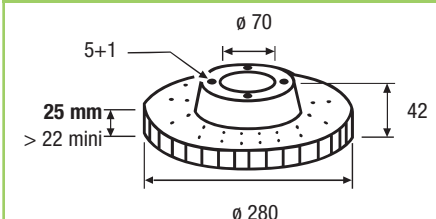

186685

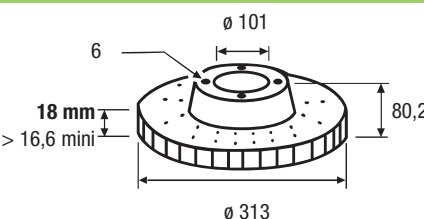

186686

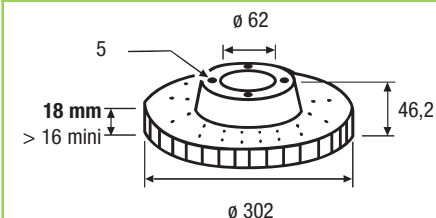

186687

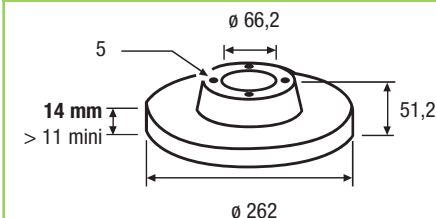

186688

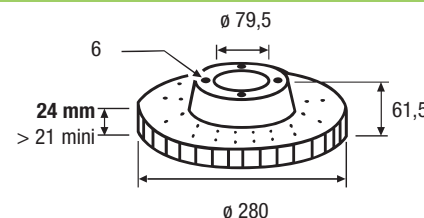

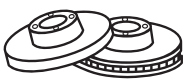

186691

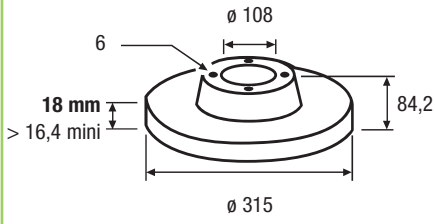

186692

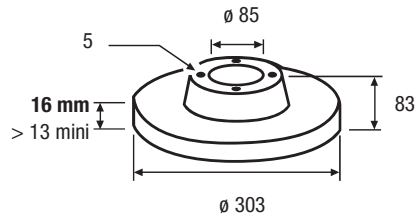

186693

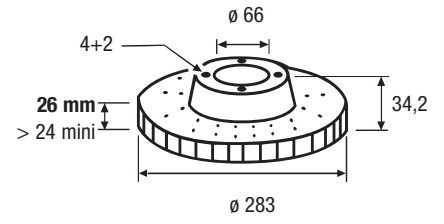

186694

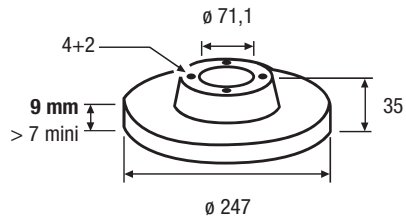

186695

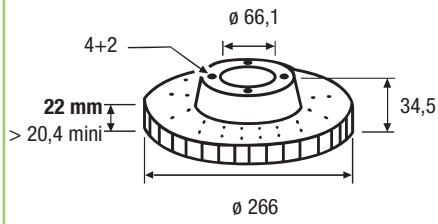

186696

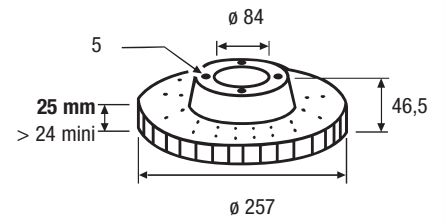

186697

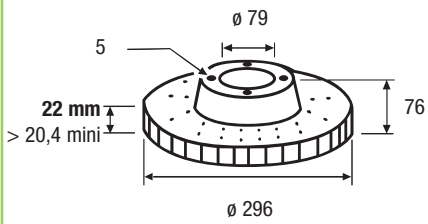

186699

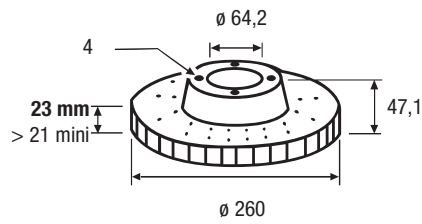

186701

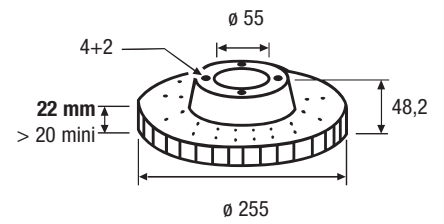

186702

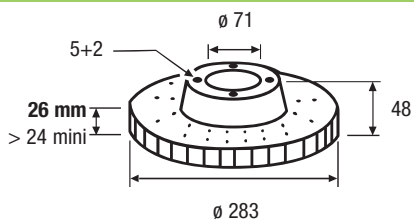

186703

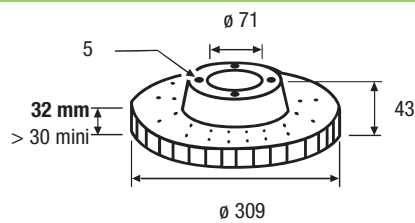

186704

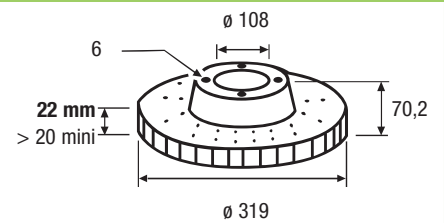

186705

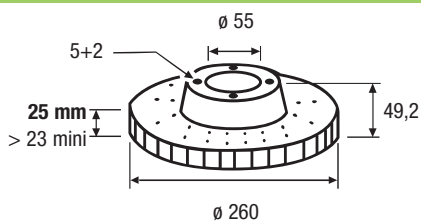

186707

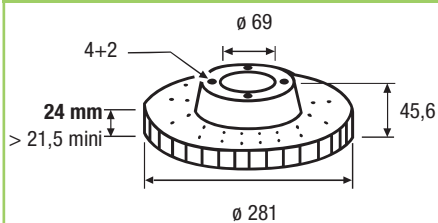

186708

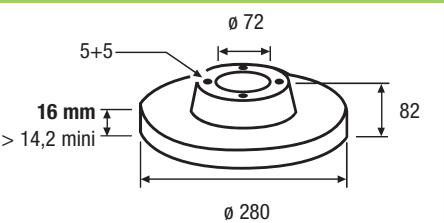

186709

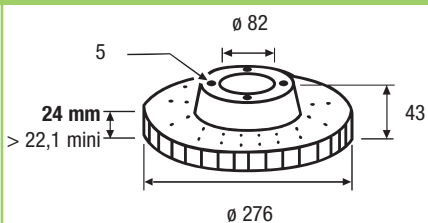

186710

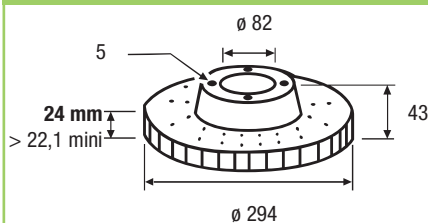

186712

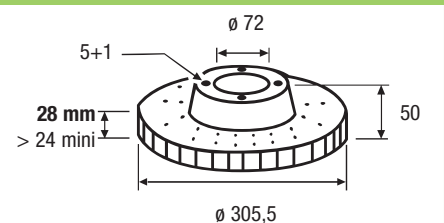

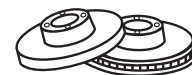

186713

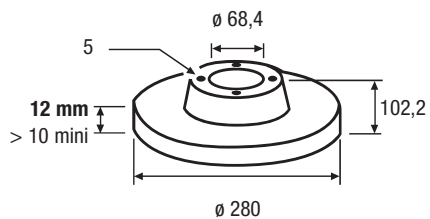

186714

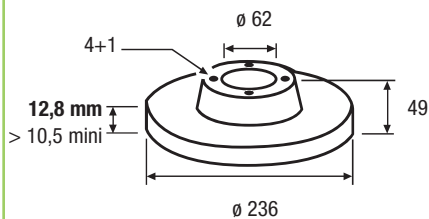

186715

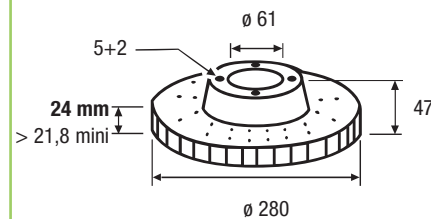

186717

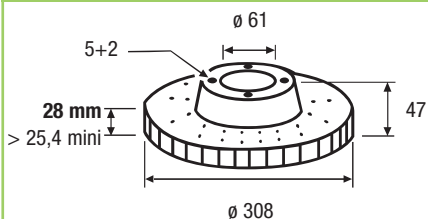

186718

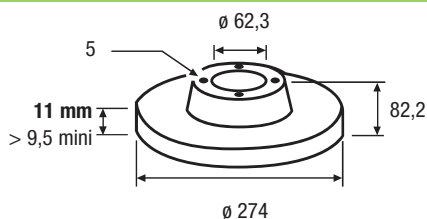

186719

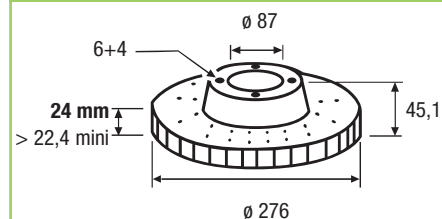

186720

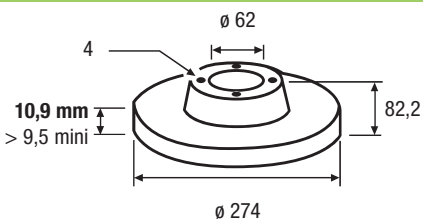

186724

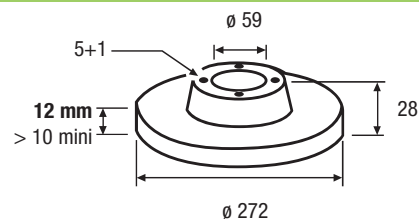

186725

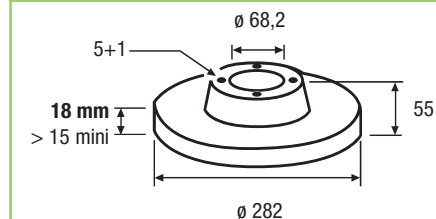

186727

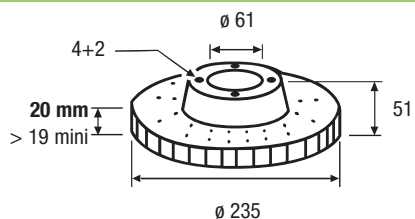

186728

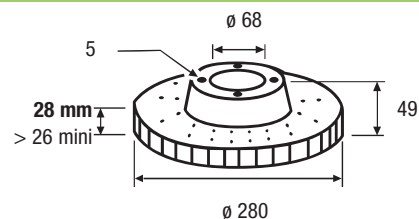

186729

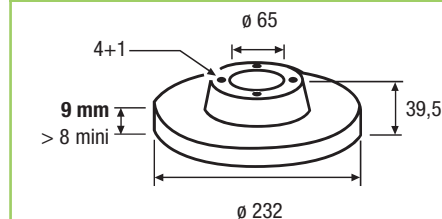

186730

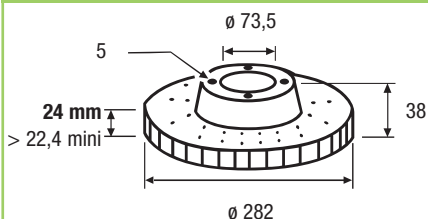

186731

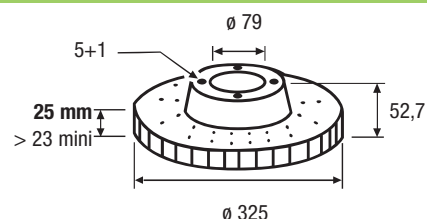

186732

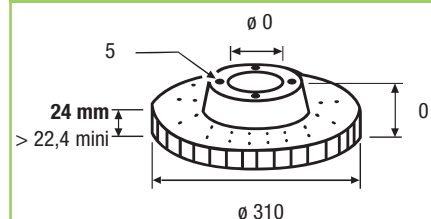

186734

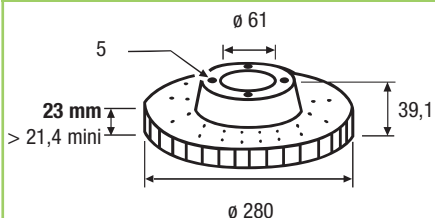

186736

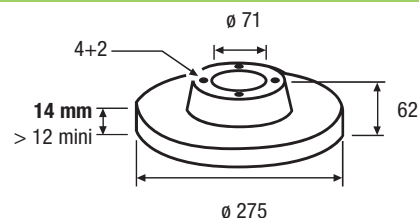

186740

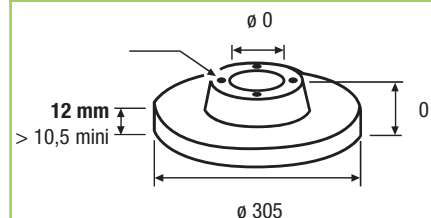



186741

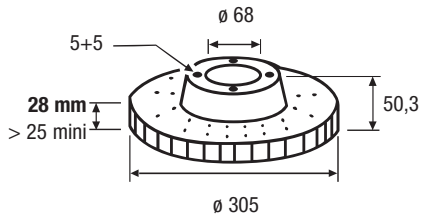

186742

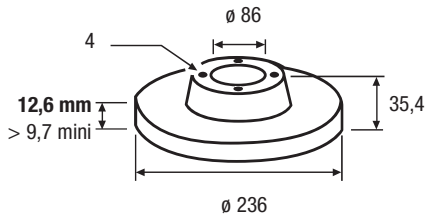

186743

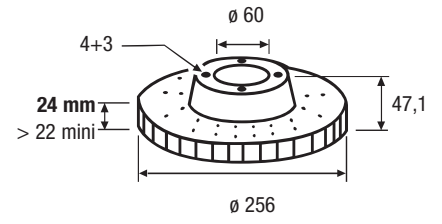

186744

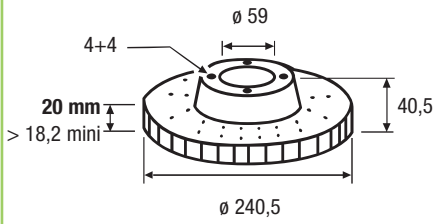

186745

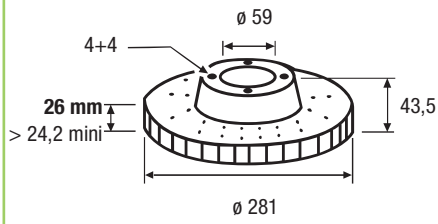

186746

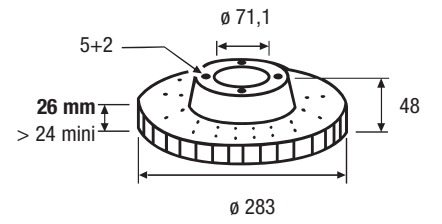

186747

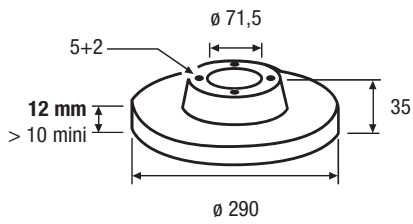

186748

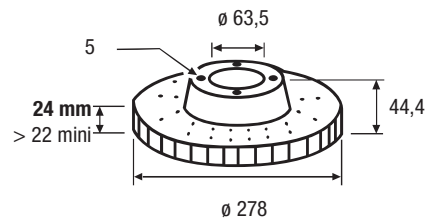

186750

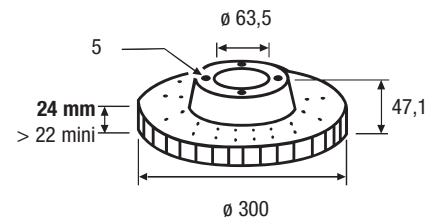

186751

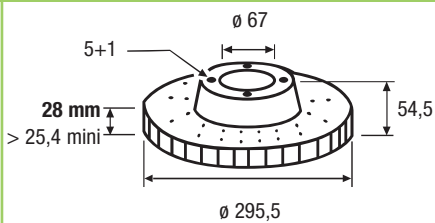

186753

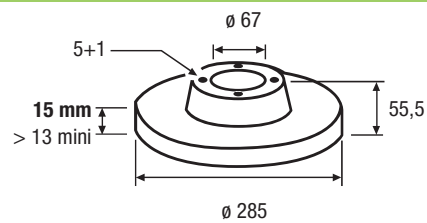

186754

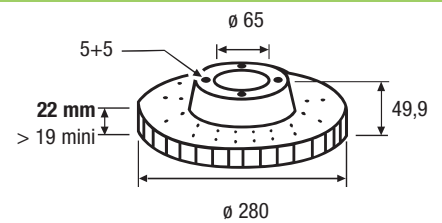

186755

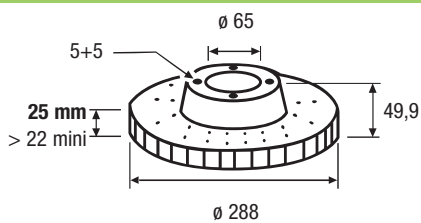

186756

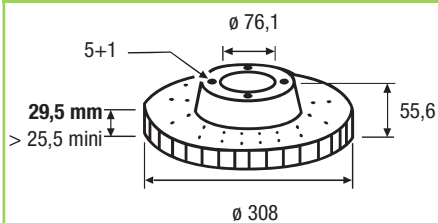

186757

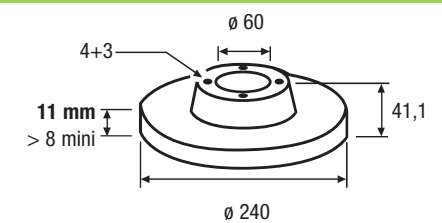

186758

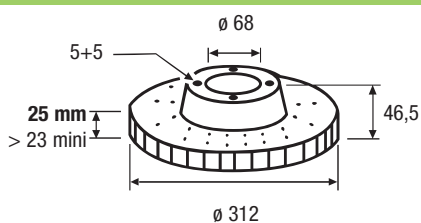

186759

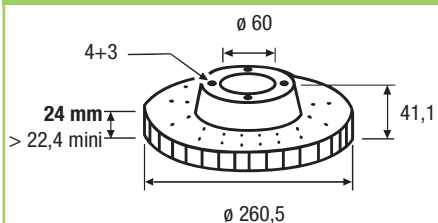

186760

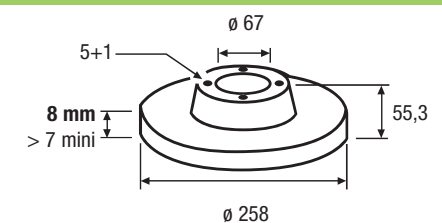

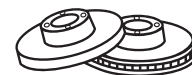

186761

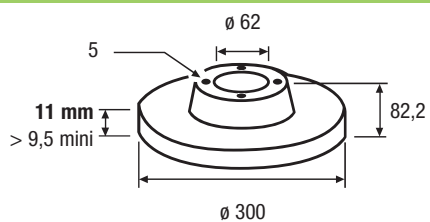

186762

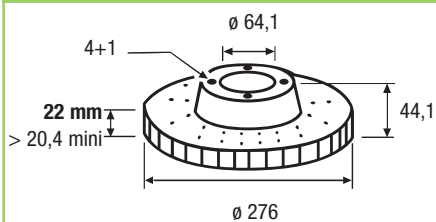

186764

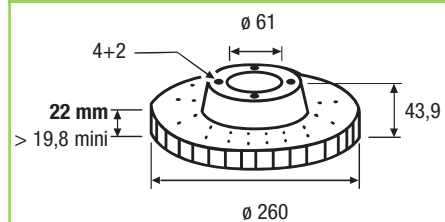

186765

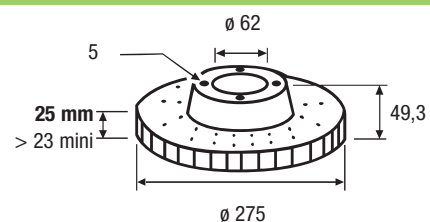

186766

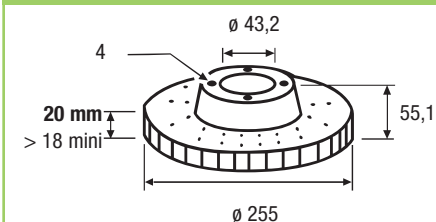

186768

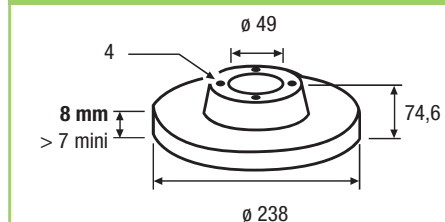

186770

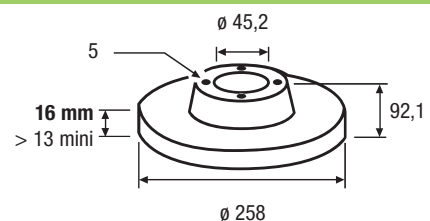

186771

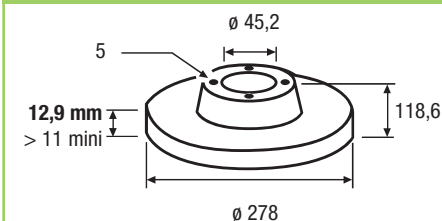

186773

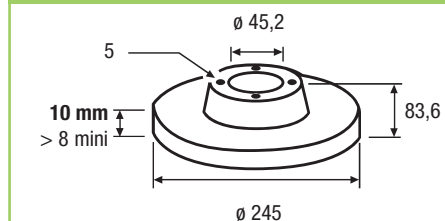

186774

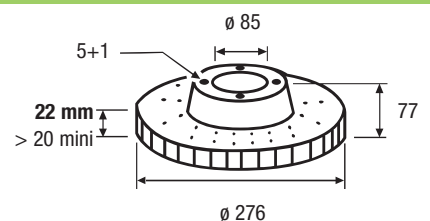

186775

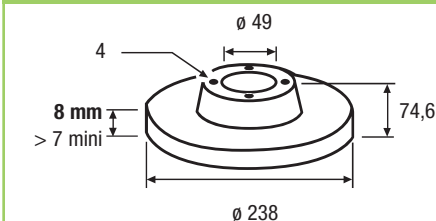

186776

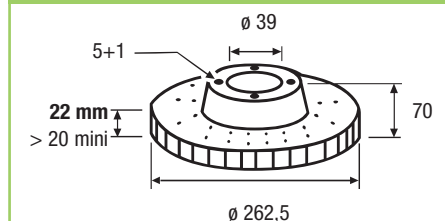

186777

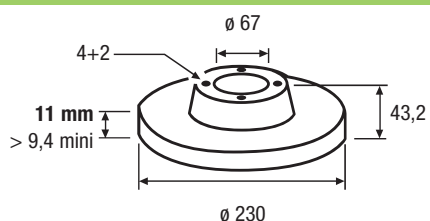

186778

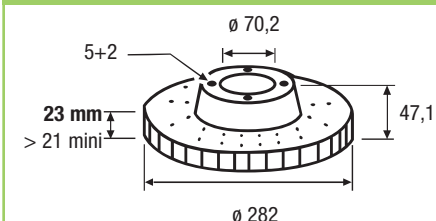

186780

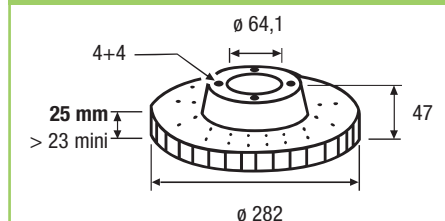

186781

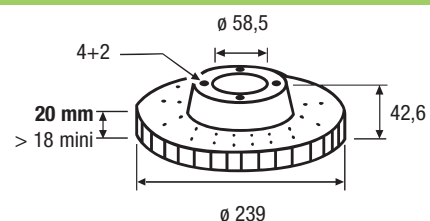

186783

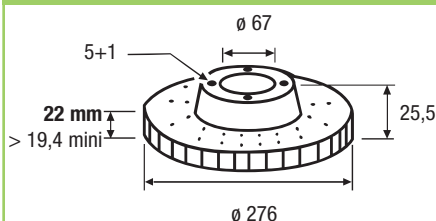

186784

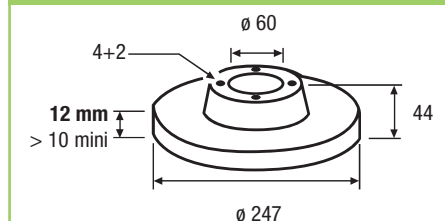

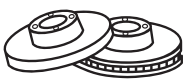

186785

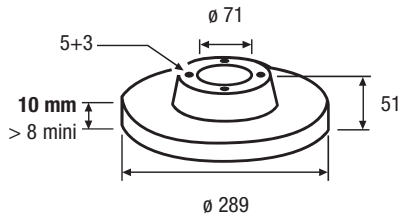

186786

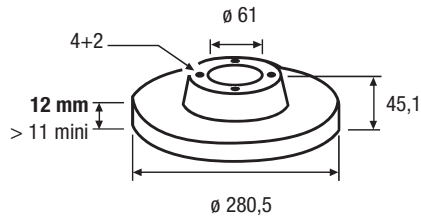

186788

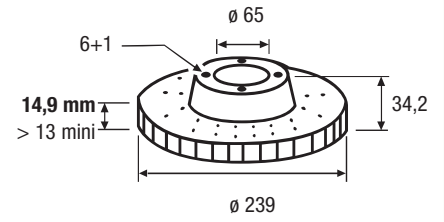

186789

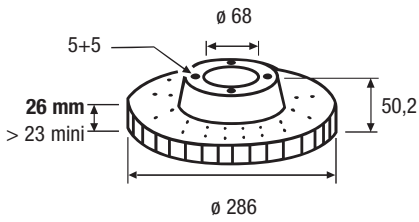

186790

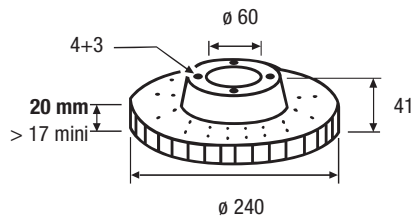

186791

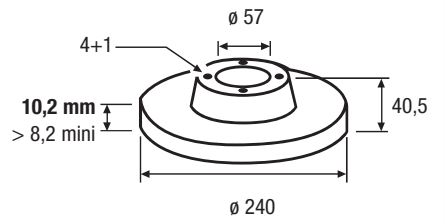

186796

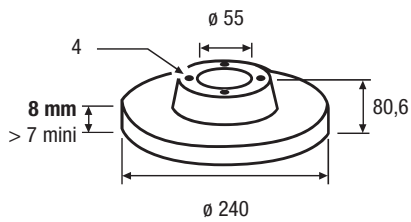

186797

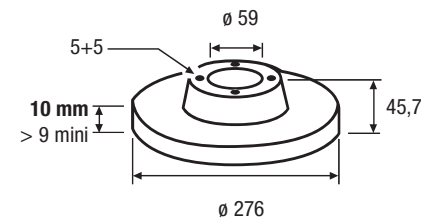

186798

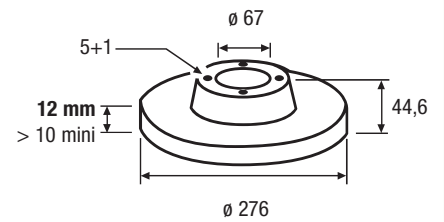

186799

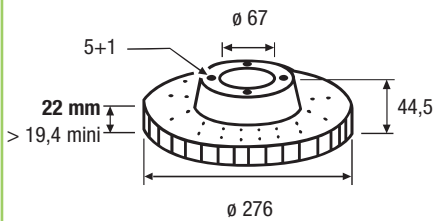

186800

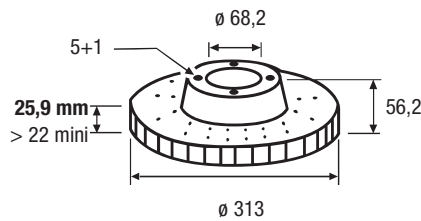

186801

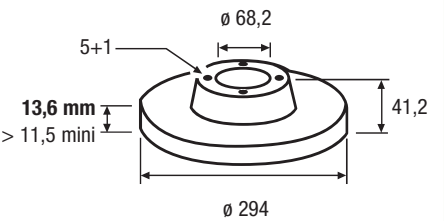

186802

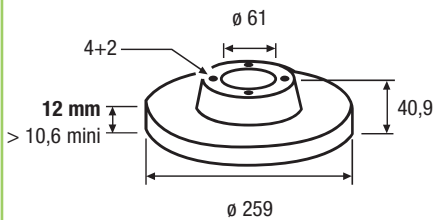

186803

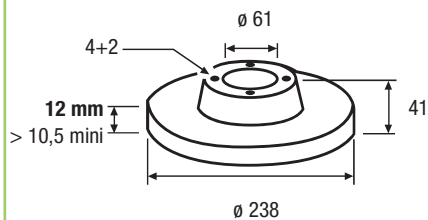

186804

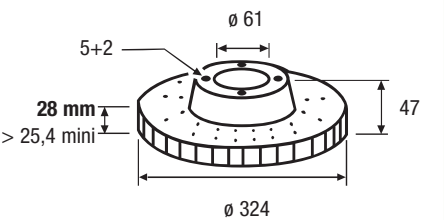

186805

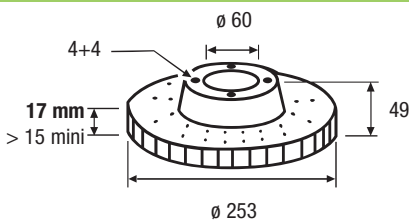

186807

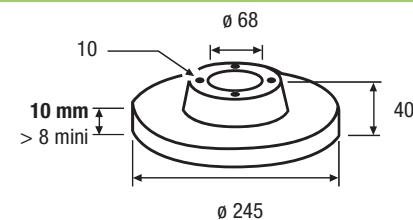

186808

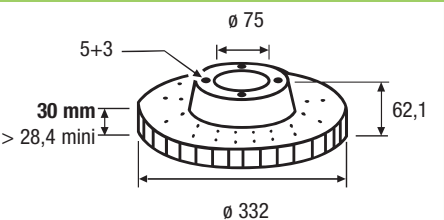

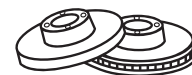

186809

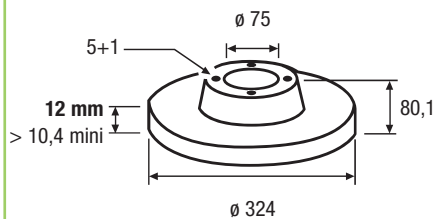

186810

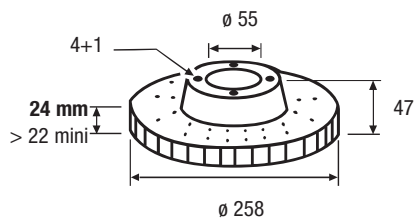

186811

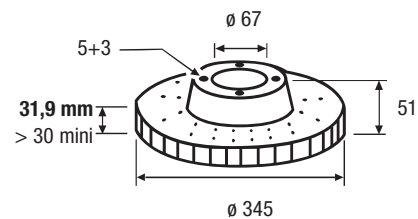

186812

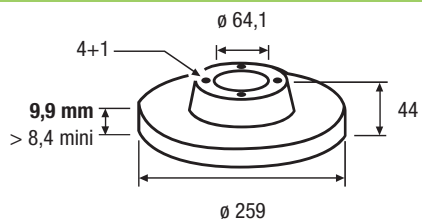

186813

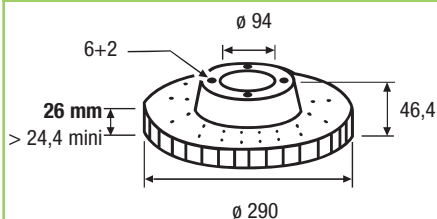

186814

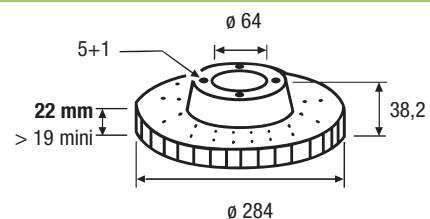

186815

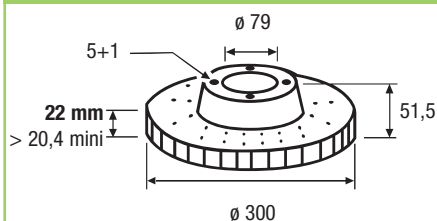

186816

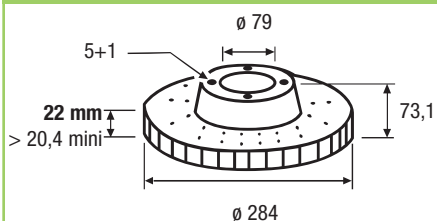

186817

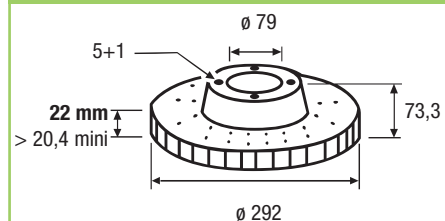

186818

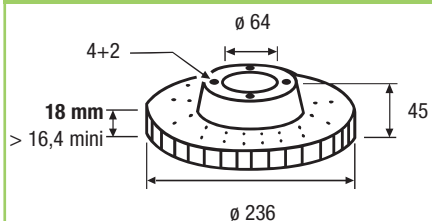

186819

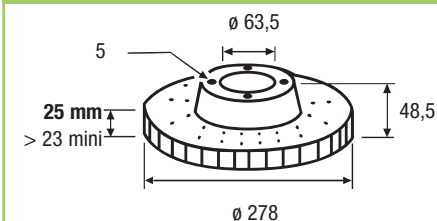

186821

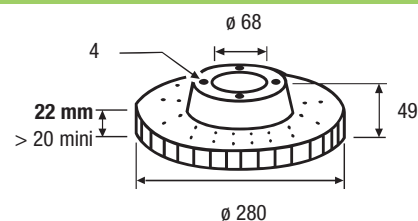

186822

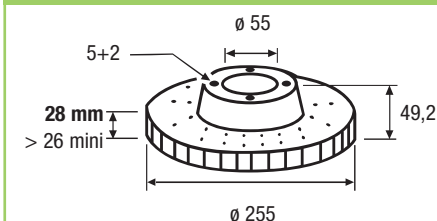

186823

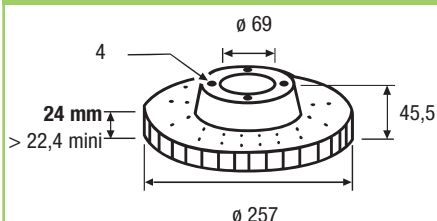

186824

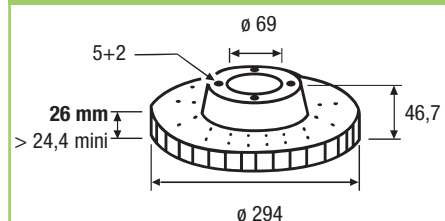

186825

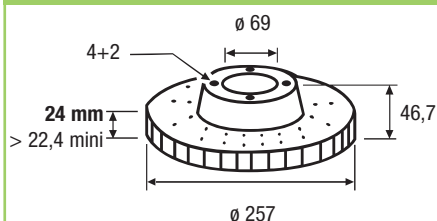

186827

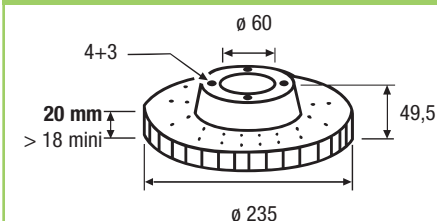

186829

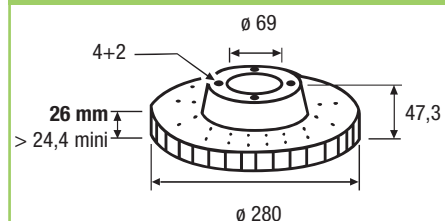

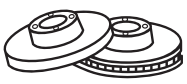

186833

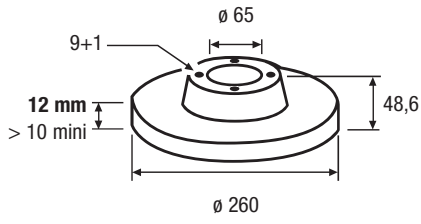

186834

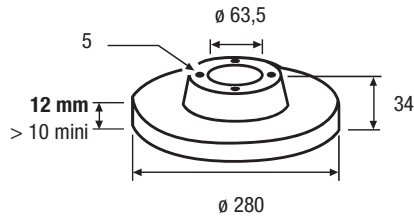

186839

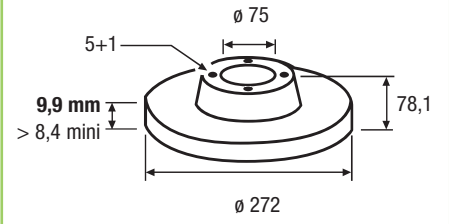

186840

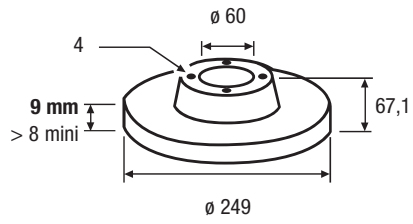

186841

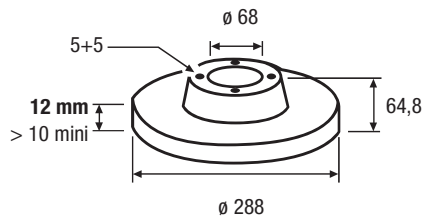

186842

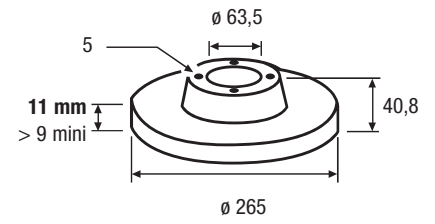

186843

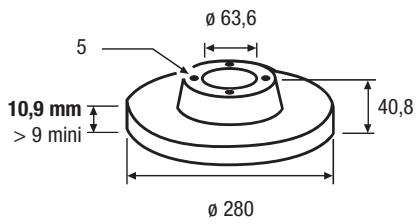

186844

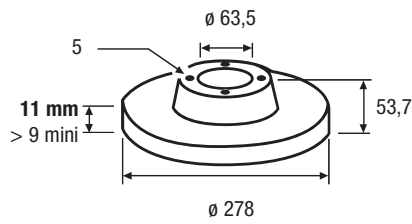

186845

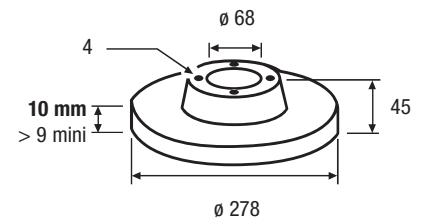

186846

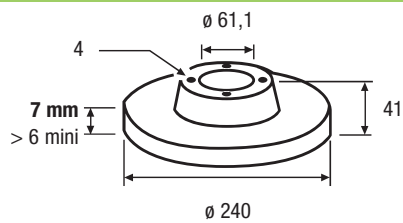

186847

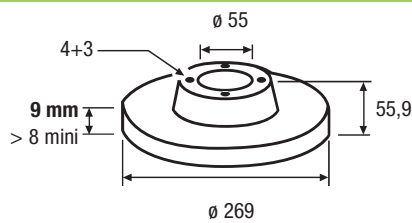

186848

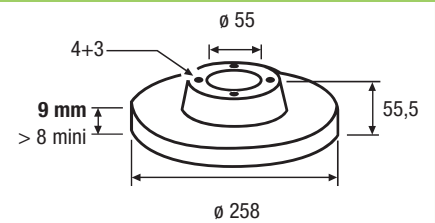

186849

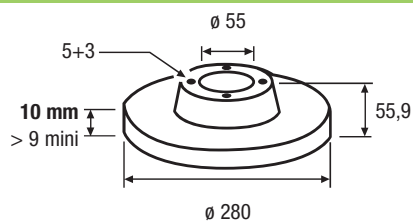

186850

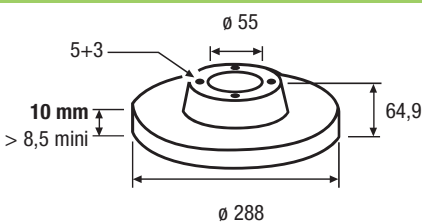

186851

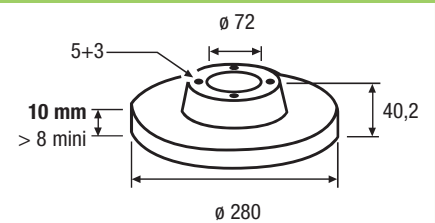

186853

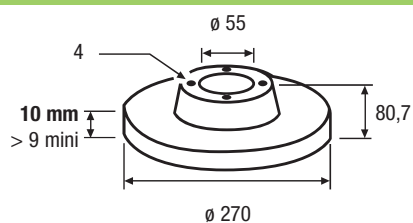

186854

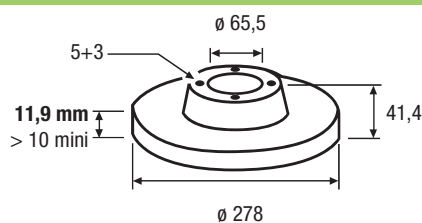

186855

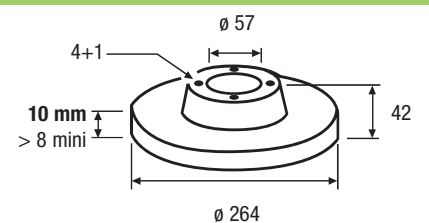

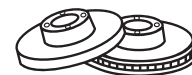

186856

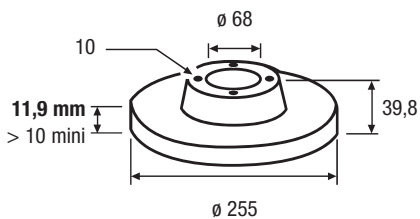

186857

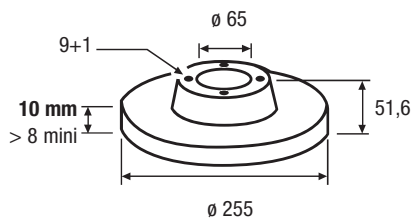

186858

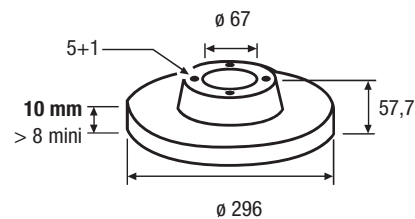

186859

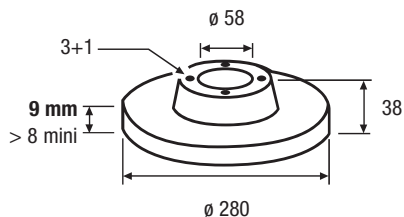

186860

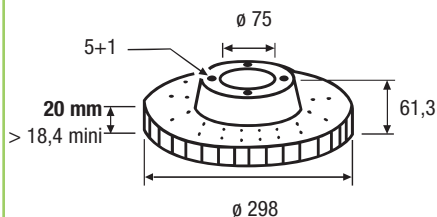

186861

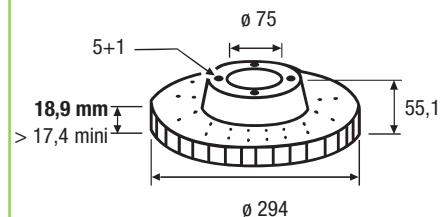

186863

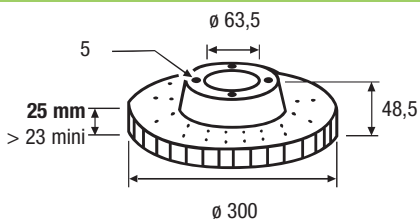

186864

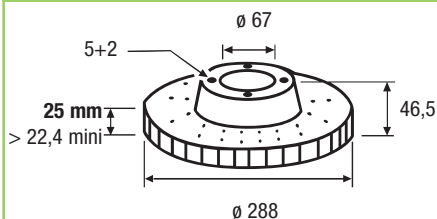

186865

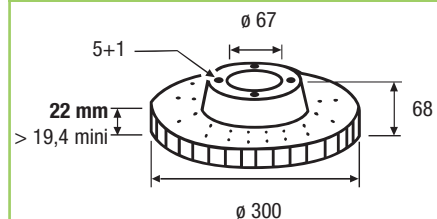

186866

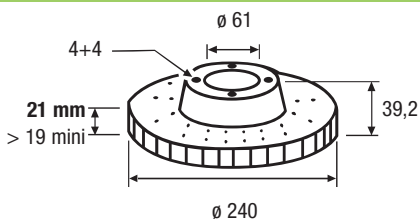

186868

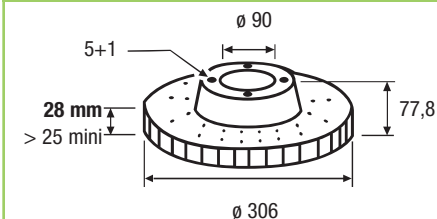

186869

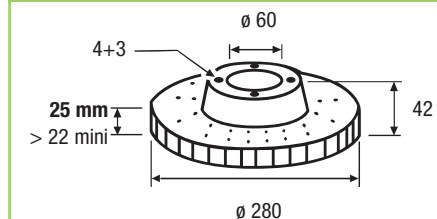

186871

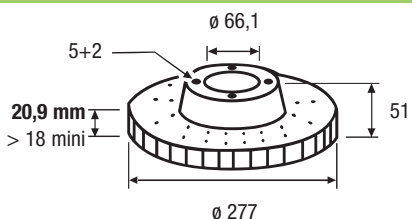

186872

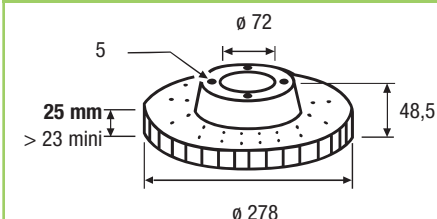

186874

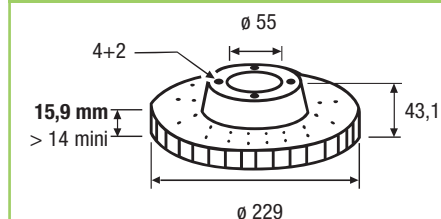

186875

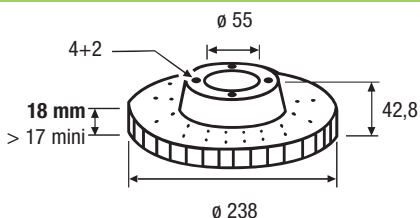

186876

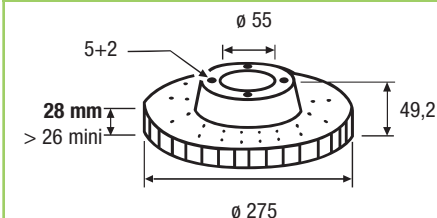

186877

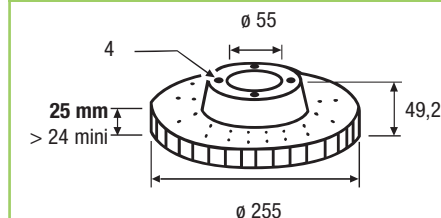

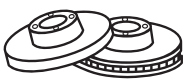

186878

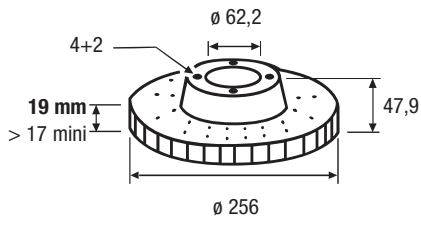

186879

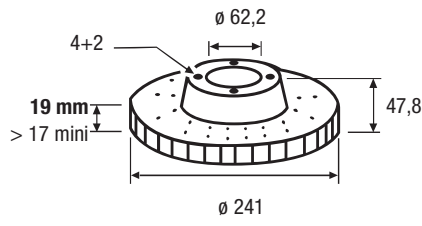

186880

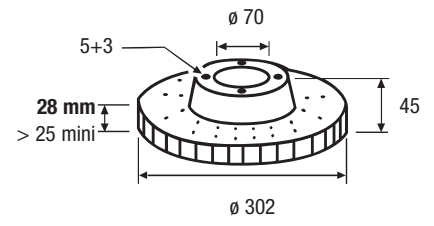

186881

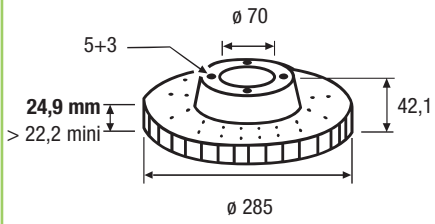

186882

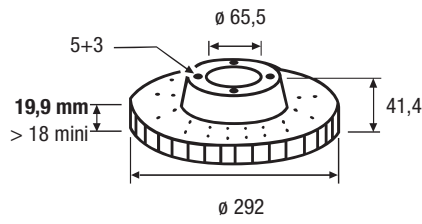

186883

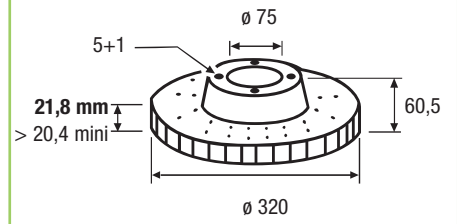

186884

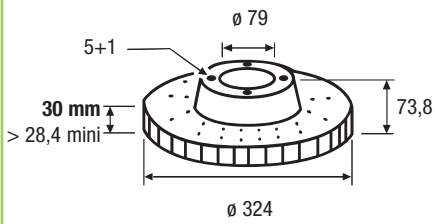

186885

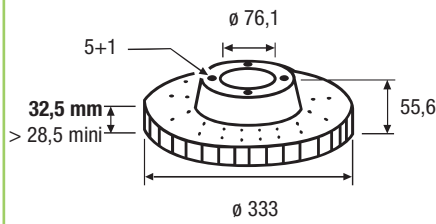

186886

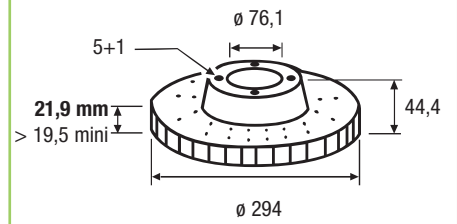

186888

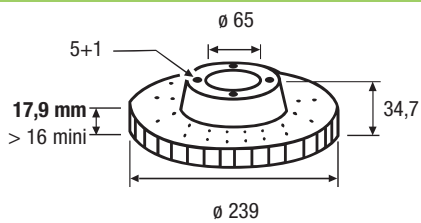

186890

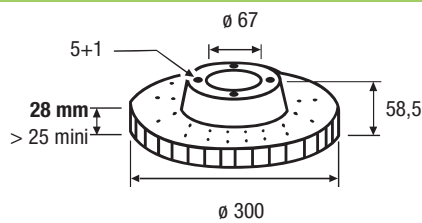

186893

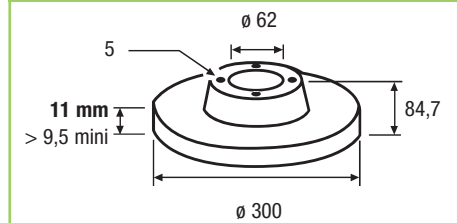

186894

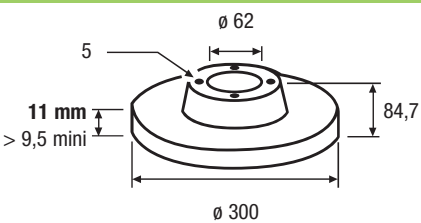

186895

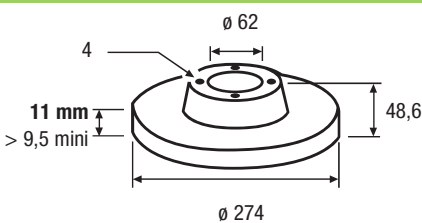

186896

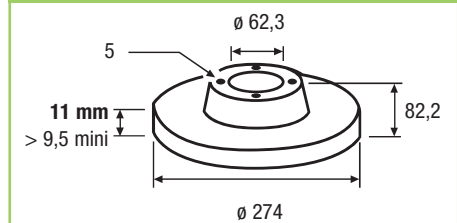

186897

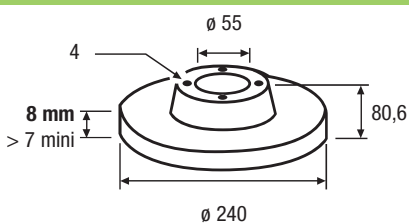

186898

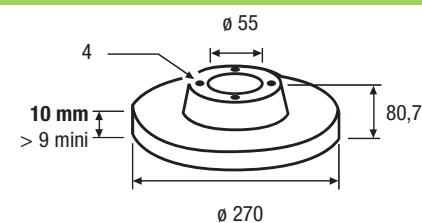

186899

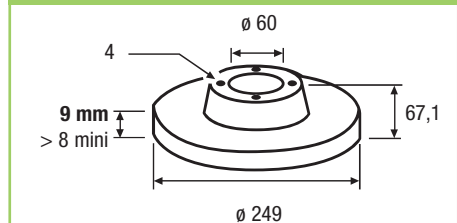



187029

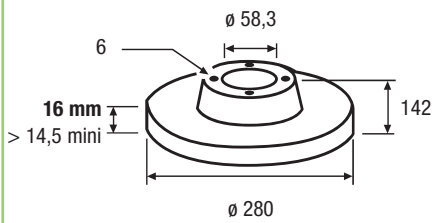

187040

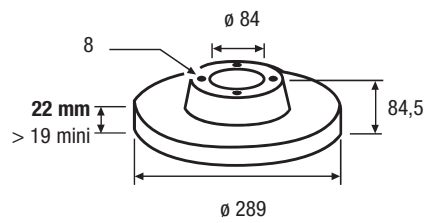

187045

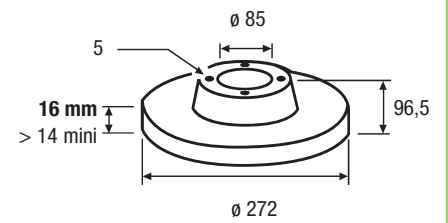

187058

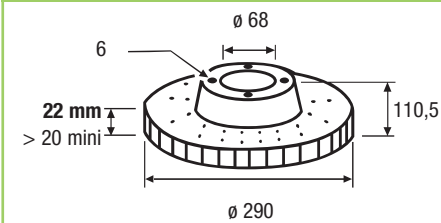

187061

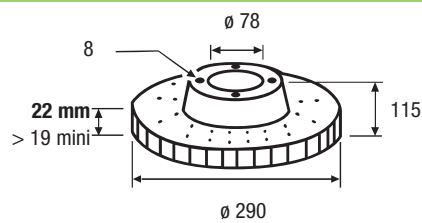

187130

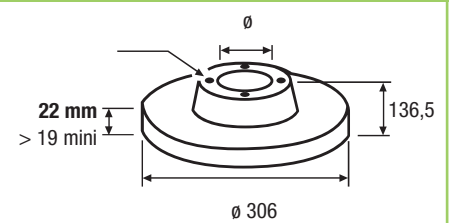

187141

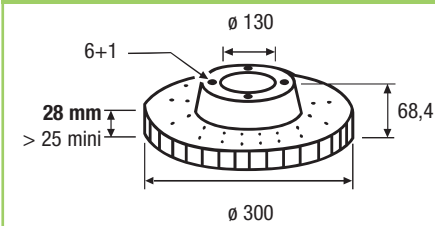

187146

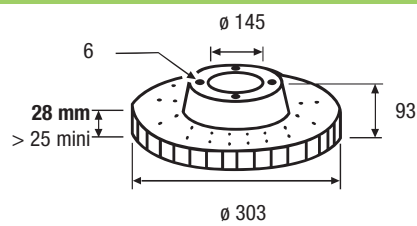

187147

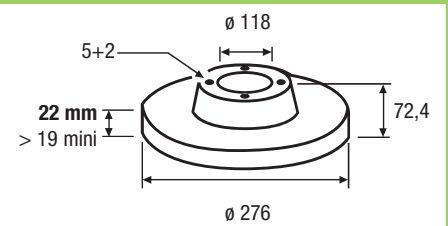

187148

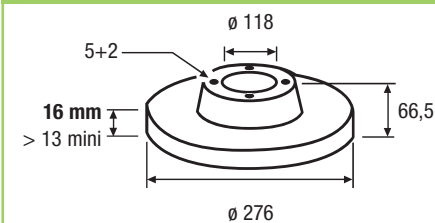

187149

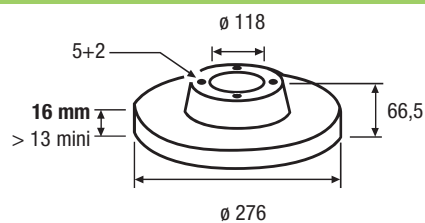

187152

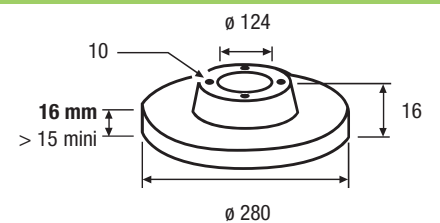

187154

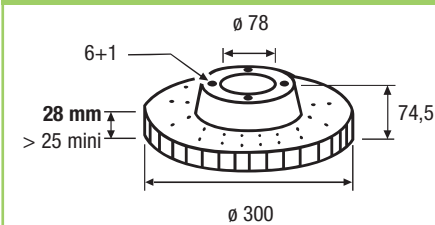

187155

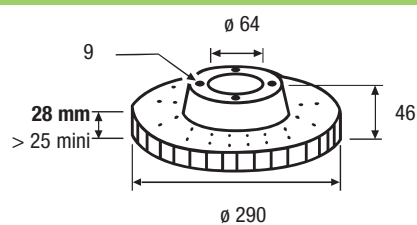

197000

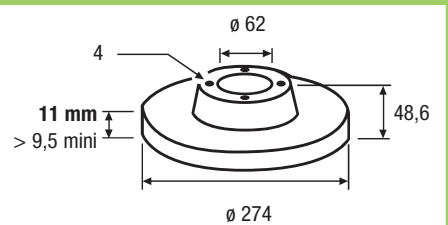

197001

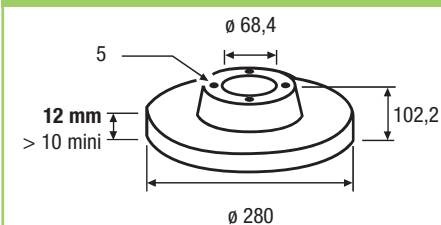

197002

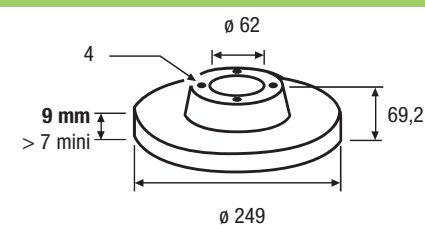

197003

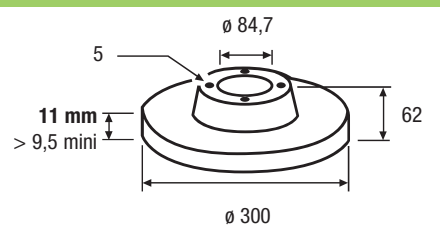

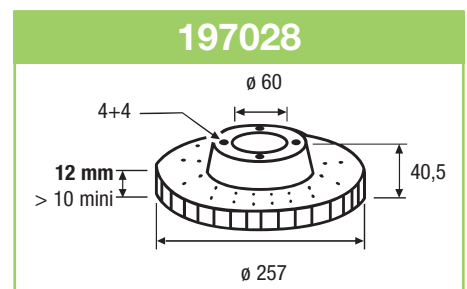
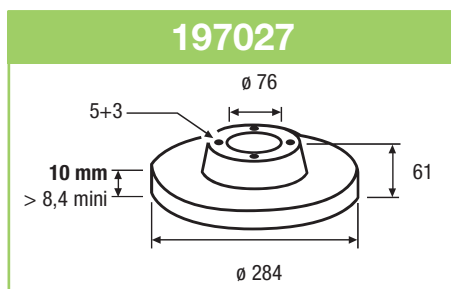
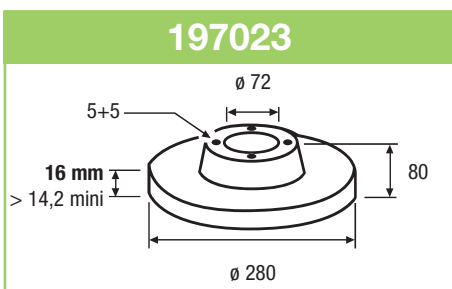
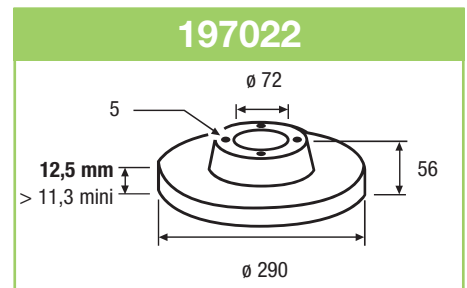
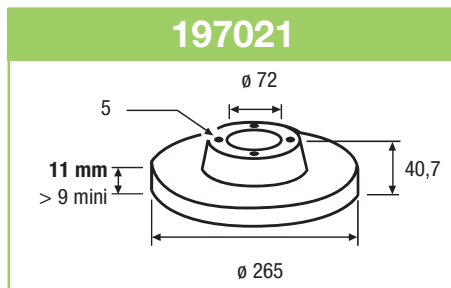
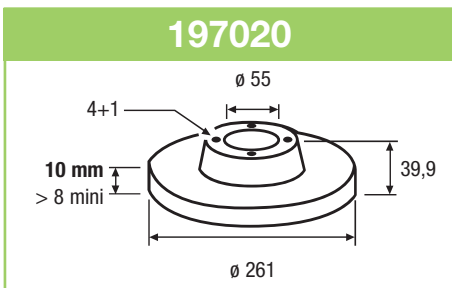
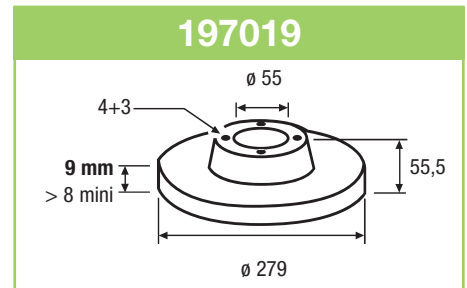
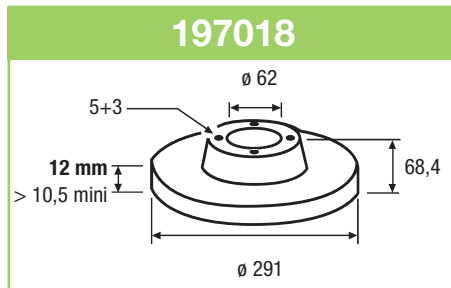
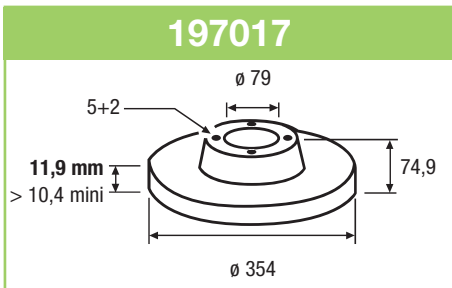
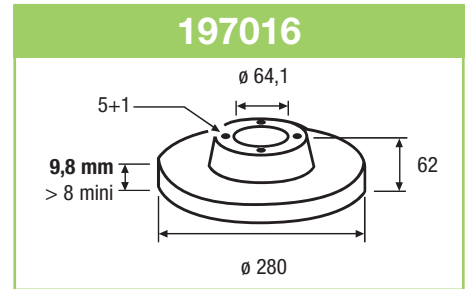
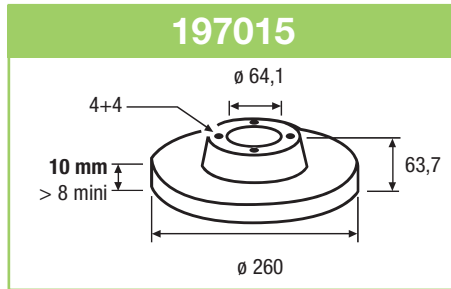
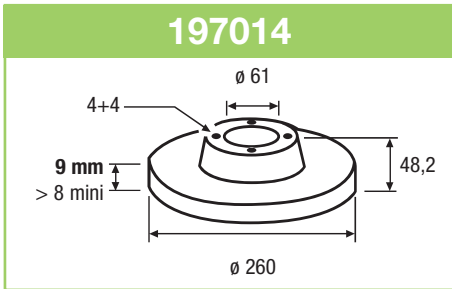
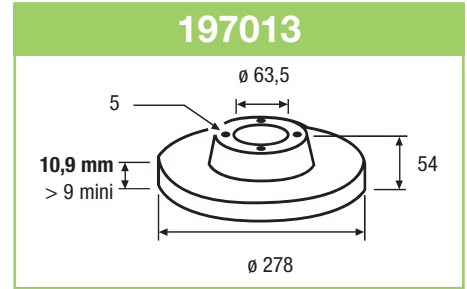
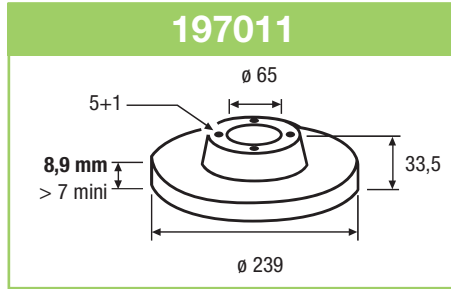
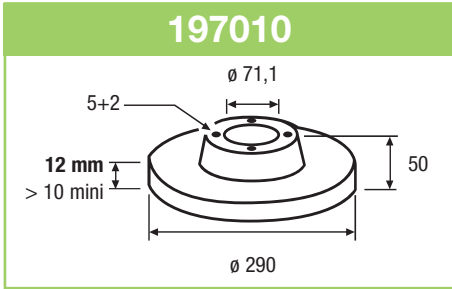
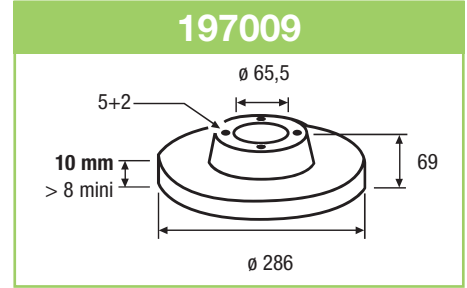
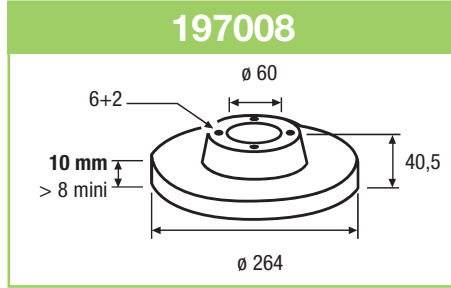
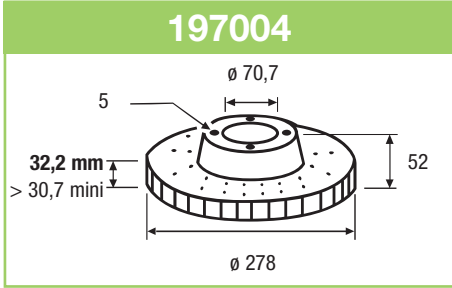



197029

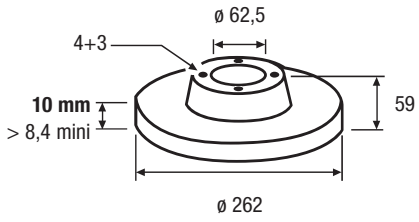

197030

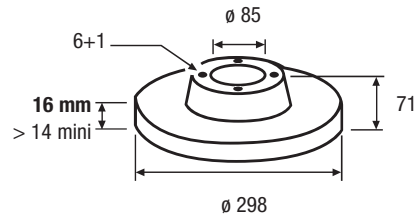

197031

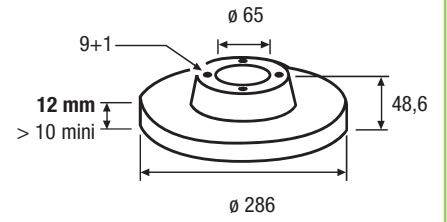

197032

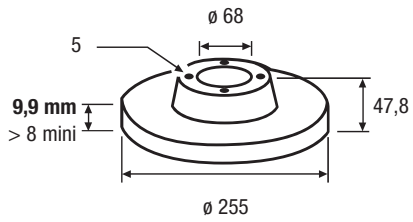

197033

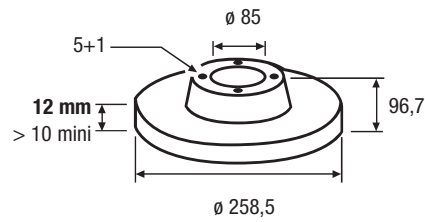

197035

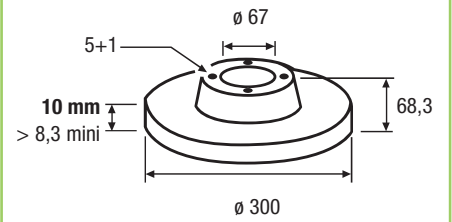

197036

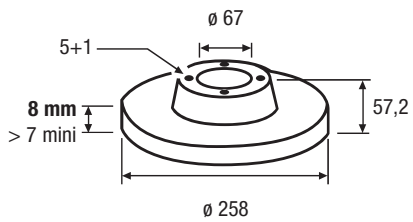

197038

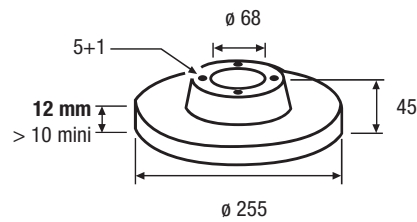

197043

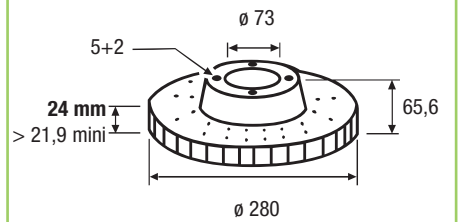

197044

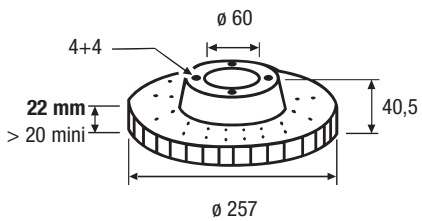

197045

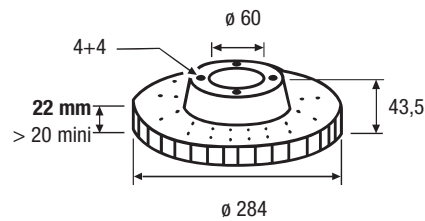

197046

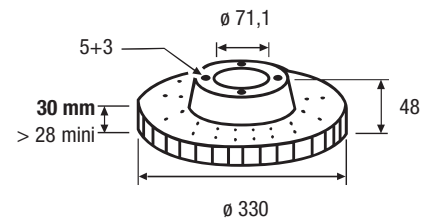

197047

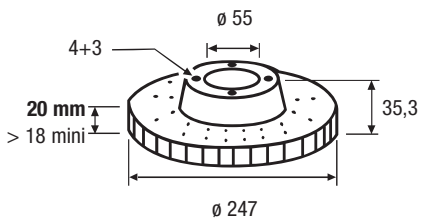

197049

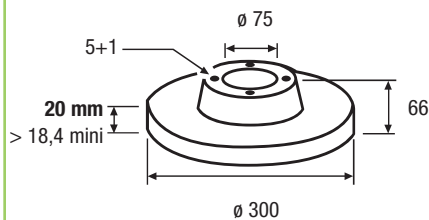

197050

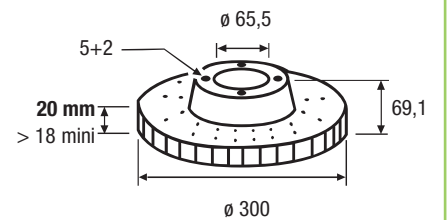

197051

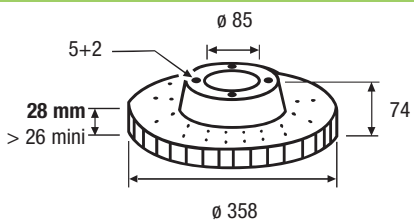

197052

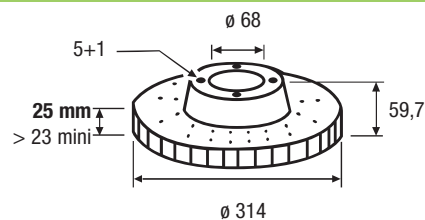

197054

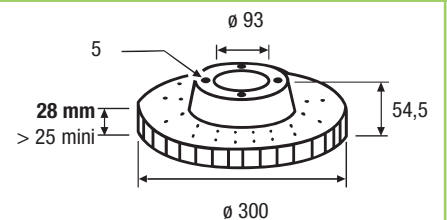

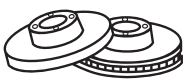

197055

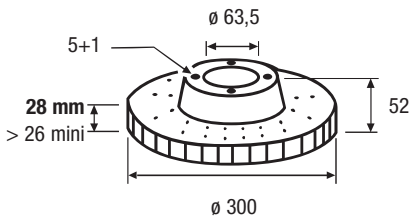

197056

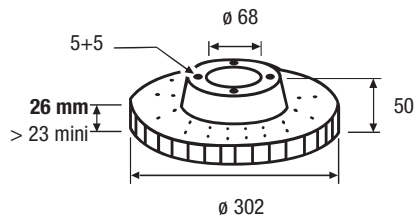

197057

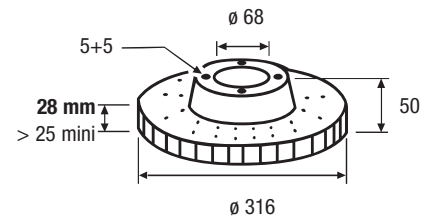

197059

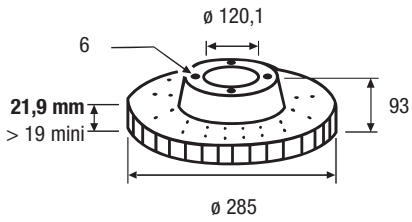

197060

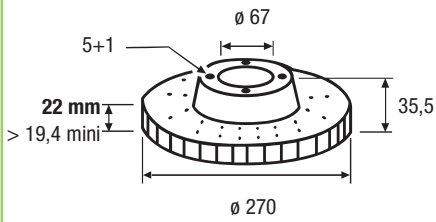

197062

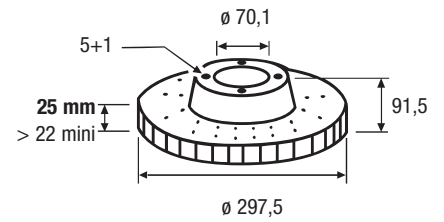

197063

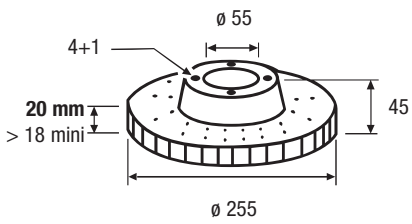

197064

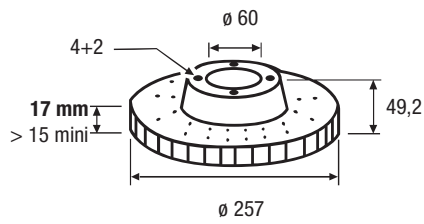

197065

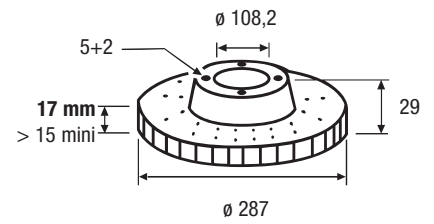

197066

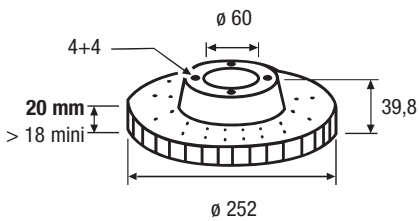

197067

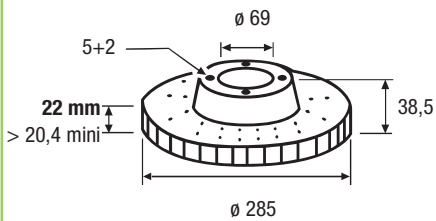

197069

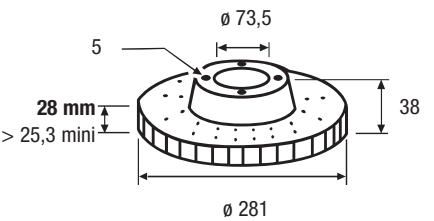

197070

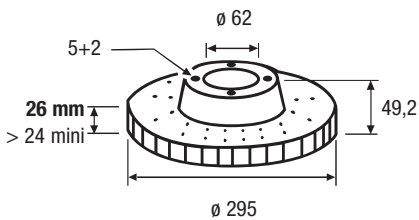

197071

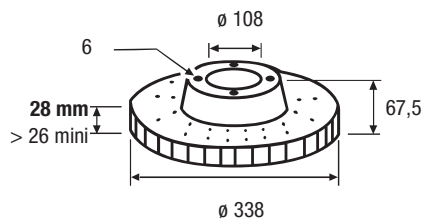

197072

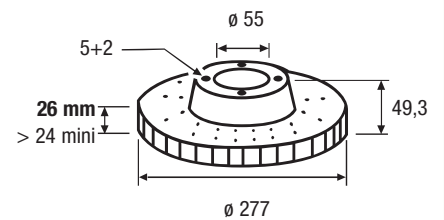

197073

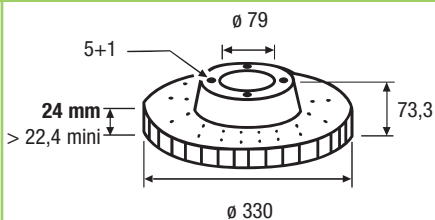

197074

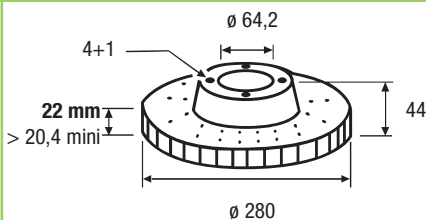

197079

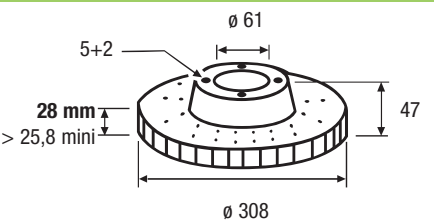

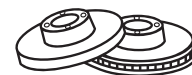

197081

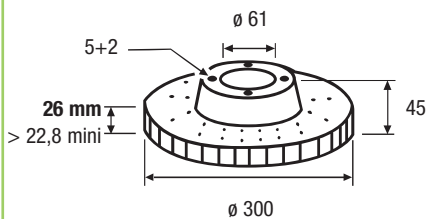

197083

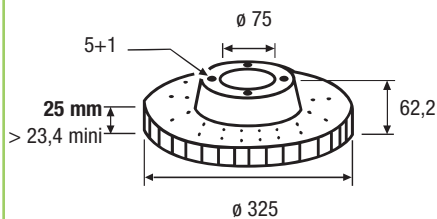

197084

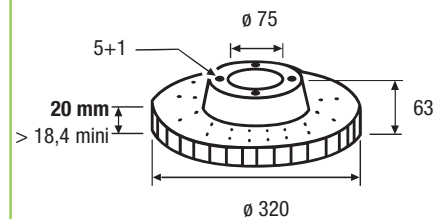

197086

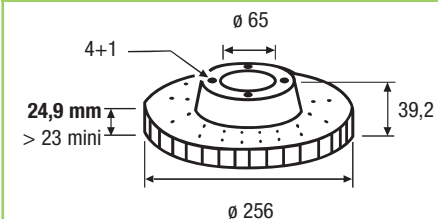

197087

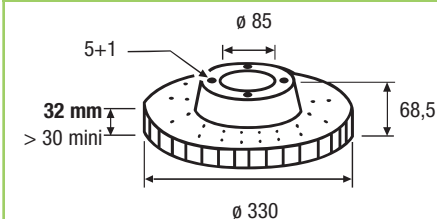

197088

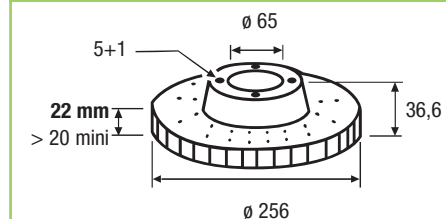

197089

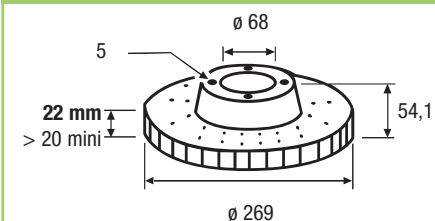

197090

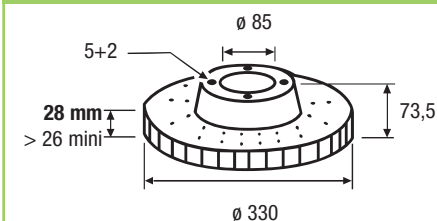

197091

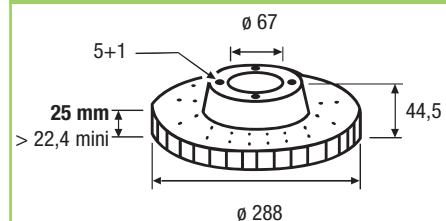

197092

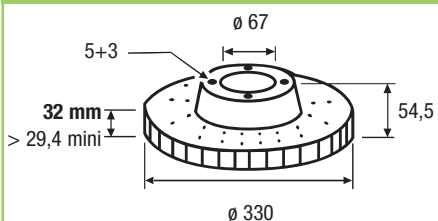

197093

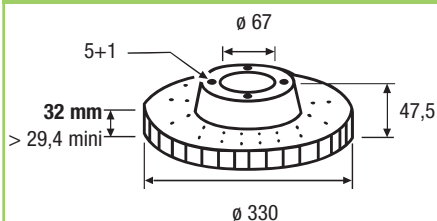

197094

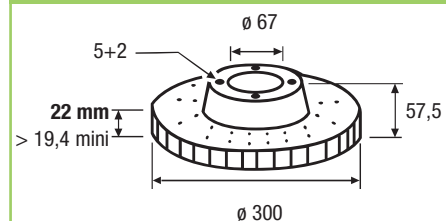

197096

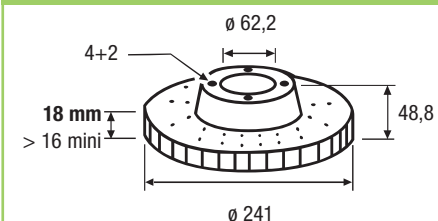

197097

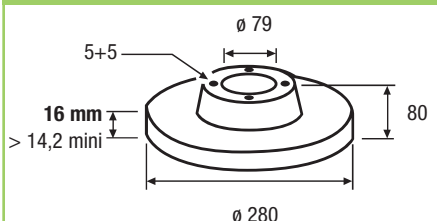

197098

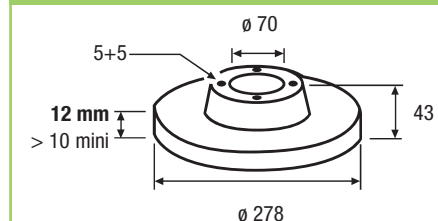

197099

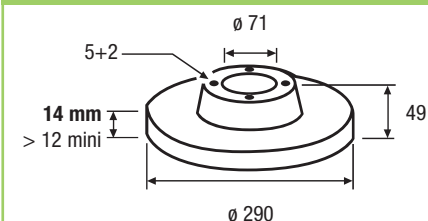

197100

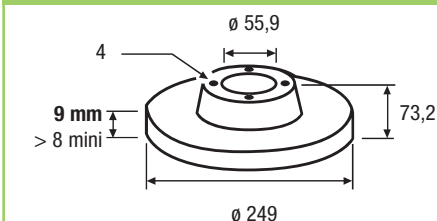

197101

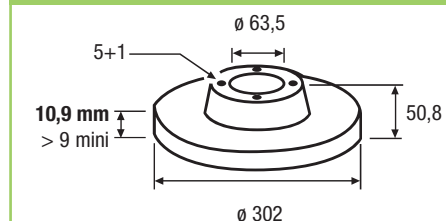

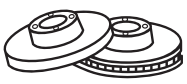

197102

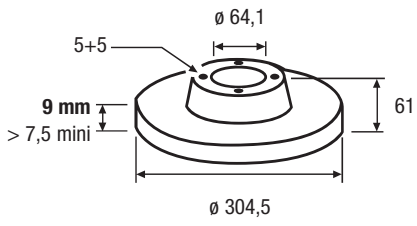

197103

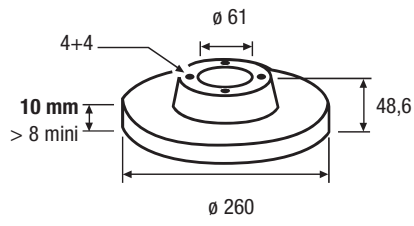

197104

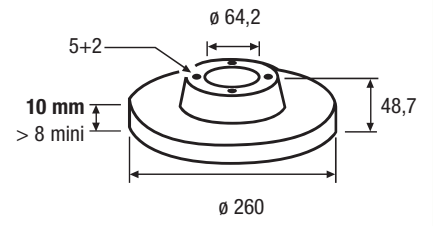

197105

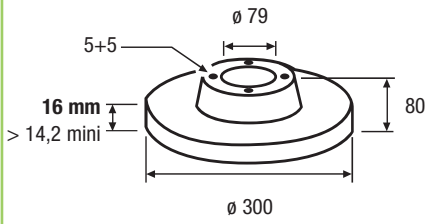

197106

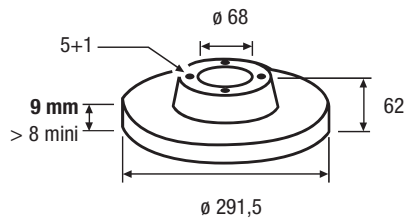

197107

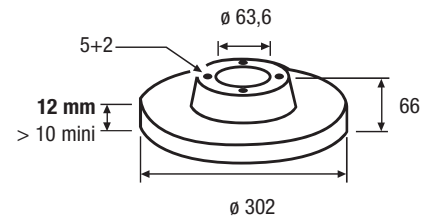

197108

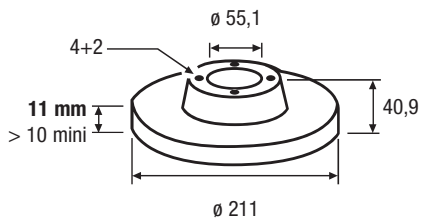

197109

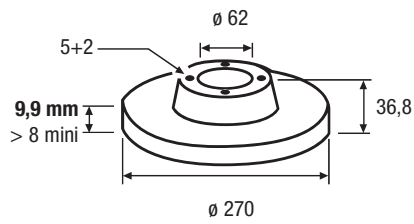

197110

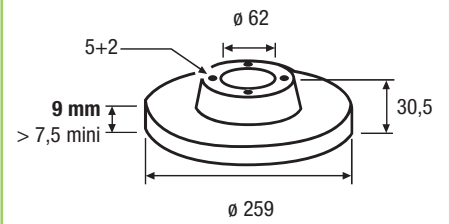

197111

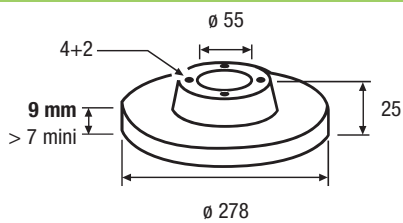

197112

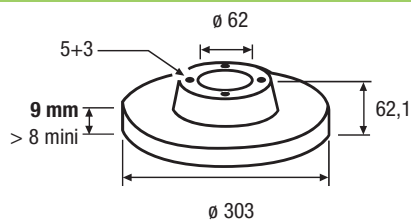

197113

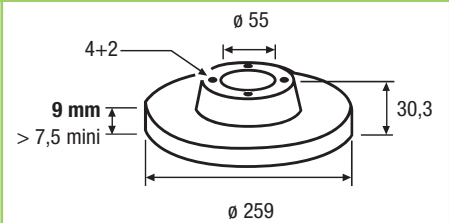

197114

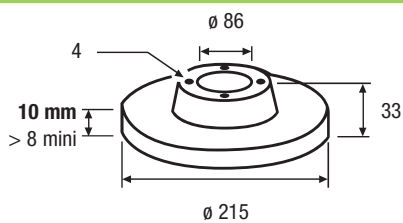

197116

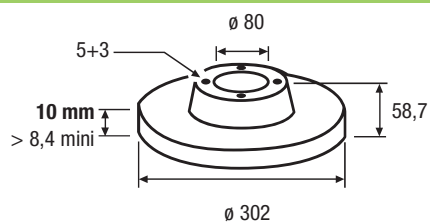

197117

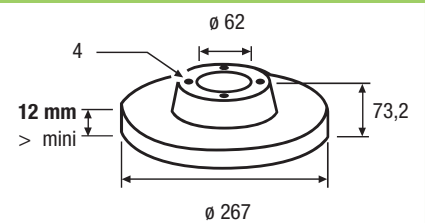

197120

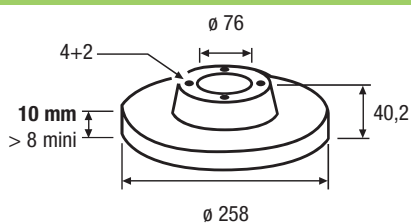

197121

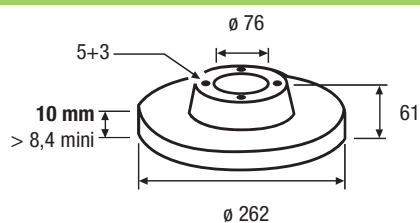

197122

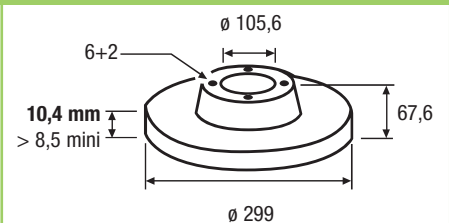

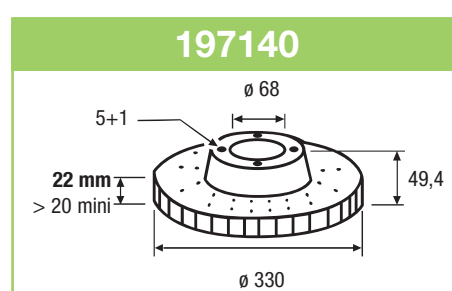
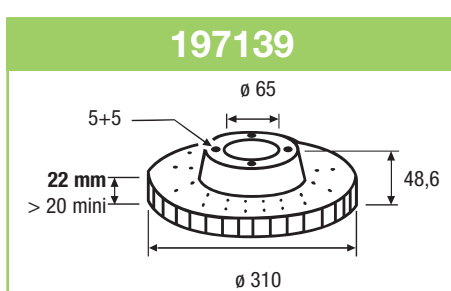
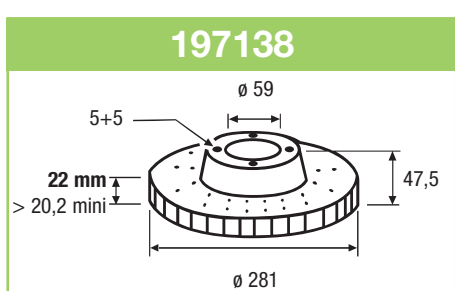
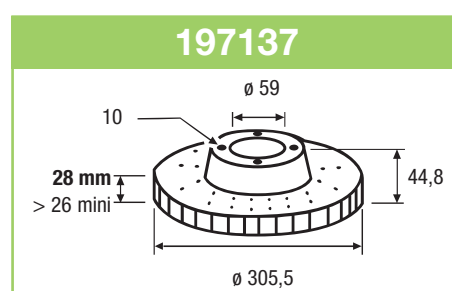
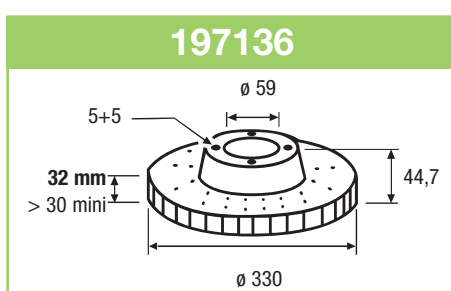
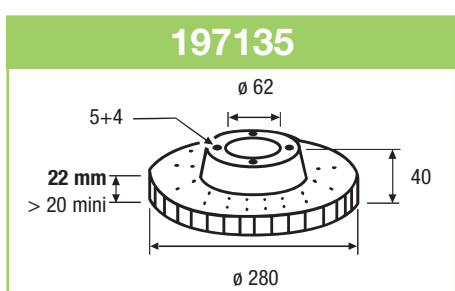
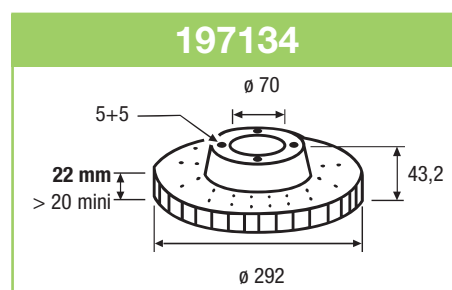
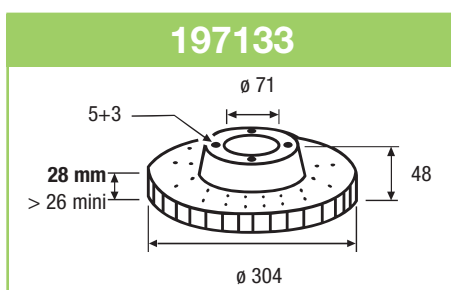
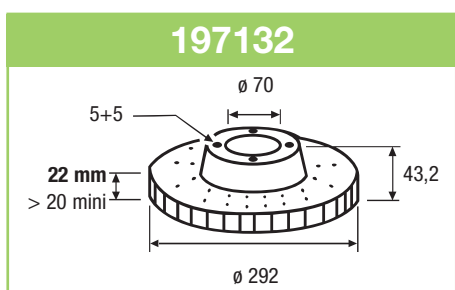
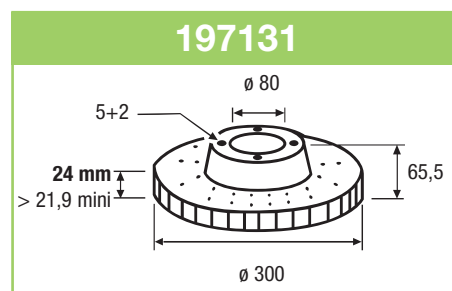
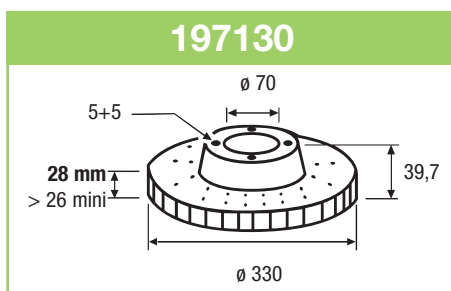
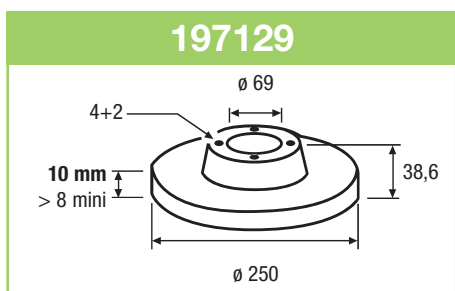
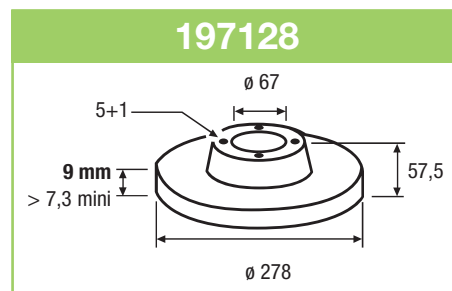
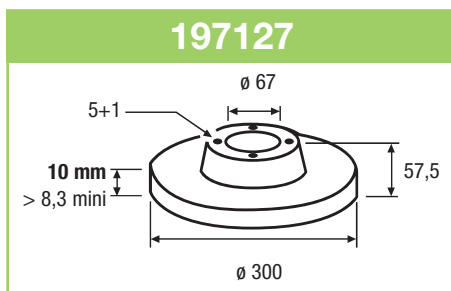
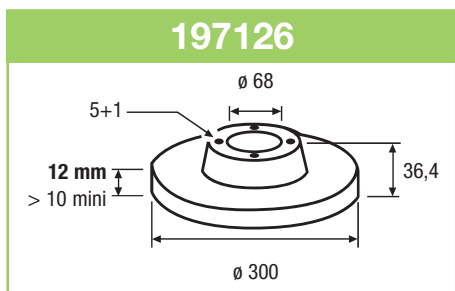
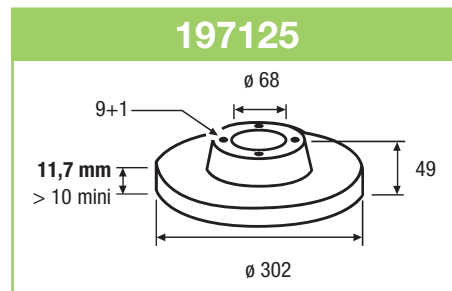
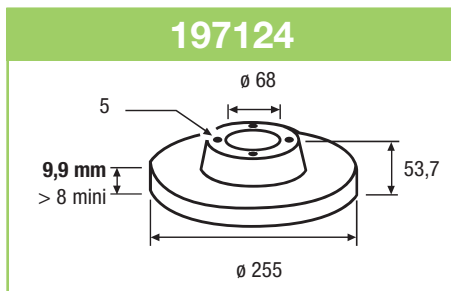
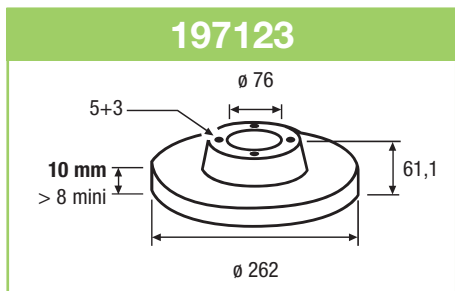
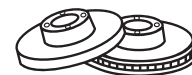

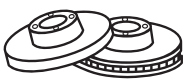

197141

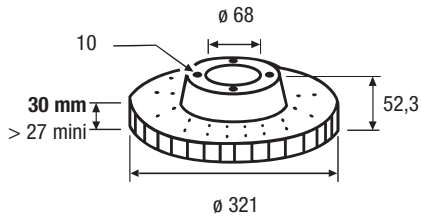

197142

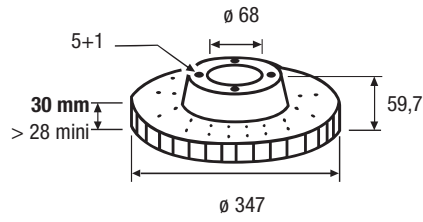

197143

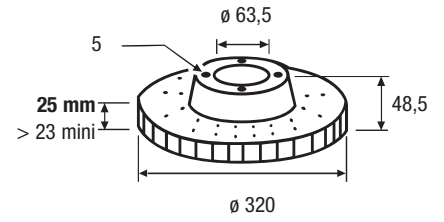

197144

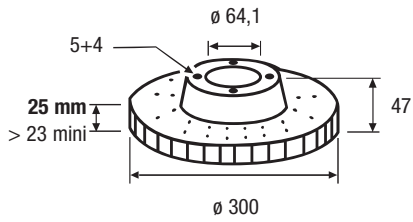

197145

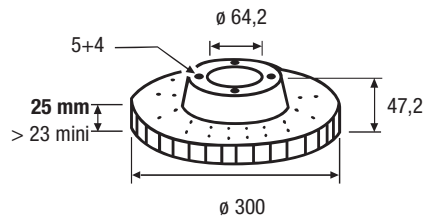

197146

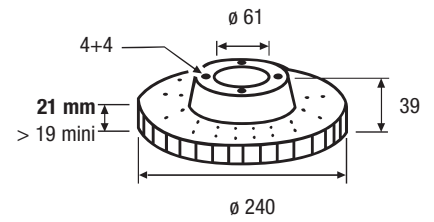

197147

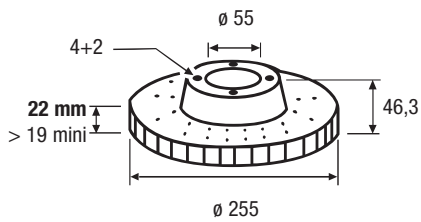

197148

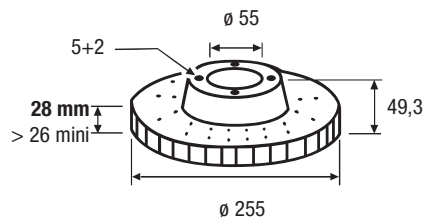

197149

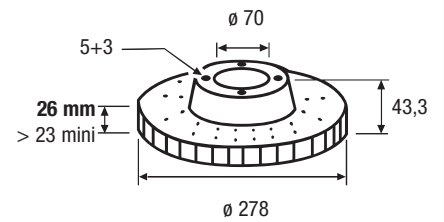

197150

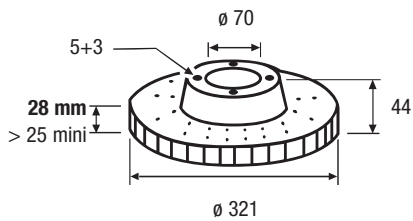

197151

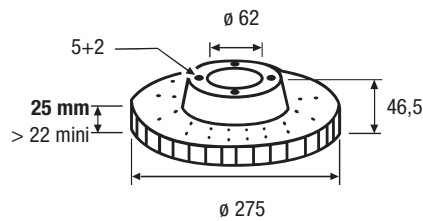

197152

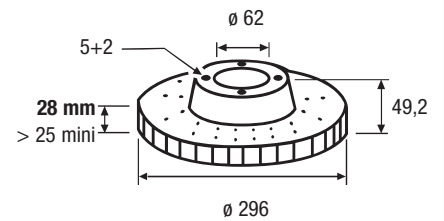

197153

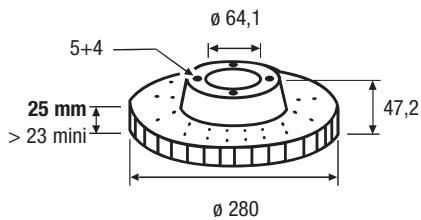

197154

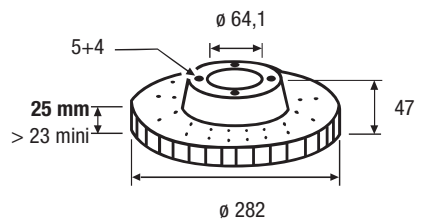

197155

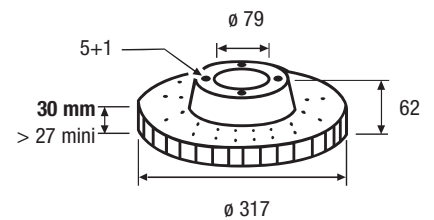

197156

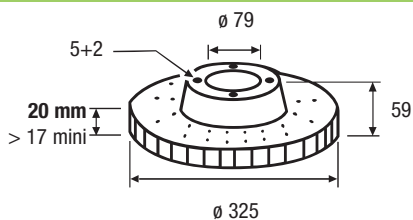

197157

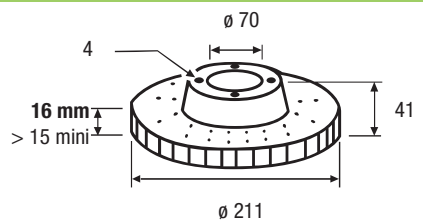

197158

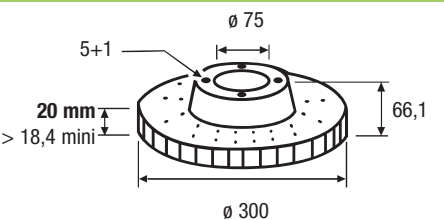



197159

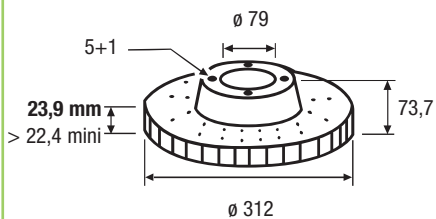

197160

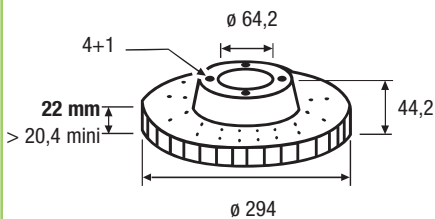

197161

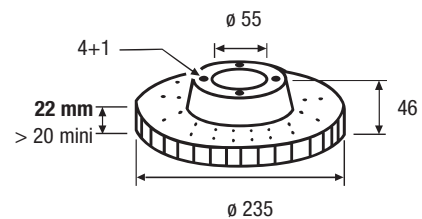

197162

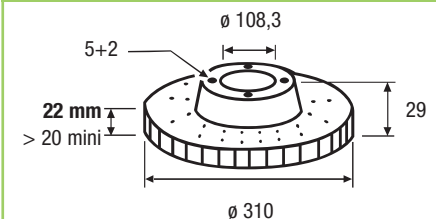

197163

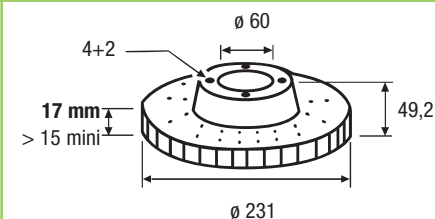

197164

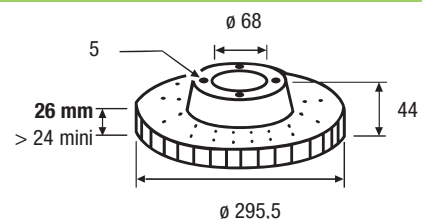

197165

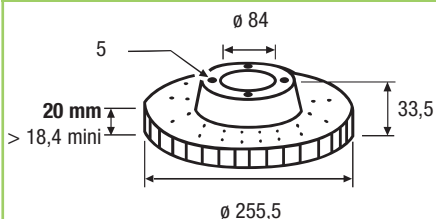

197166

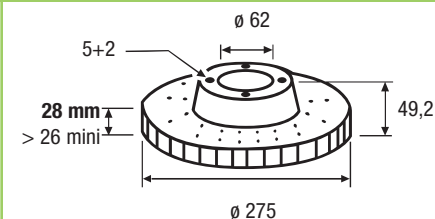

197167

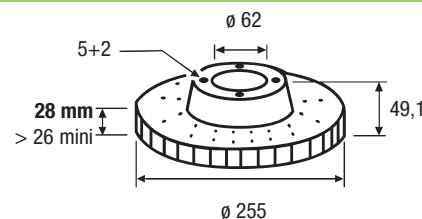

197168

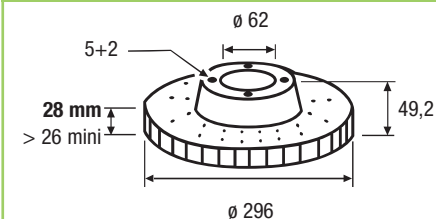

197169

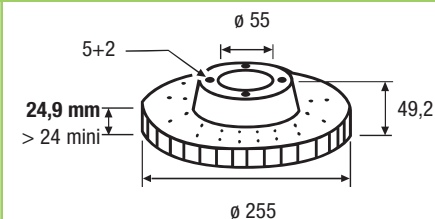

197170

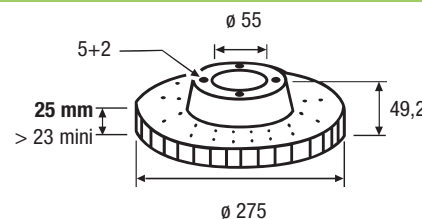

197171

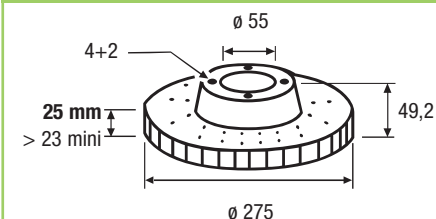

197172

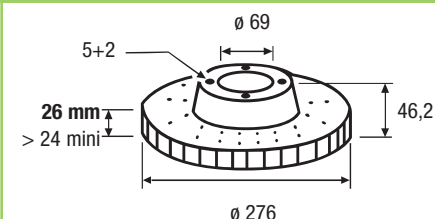

197173

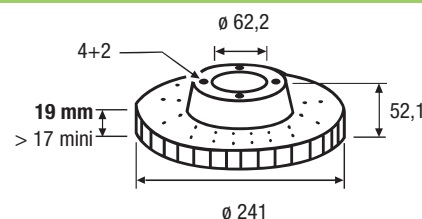

197174

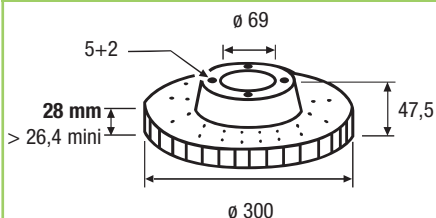

197175

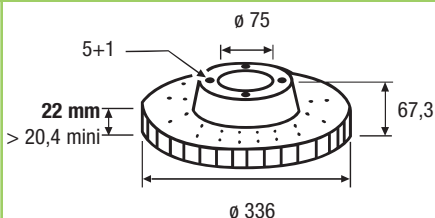

197176

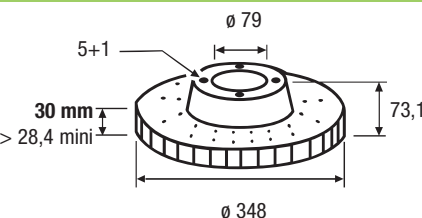



197177

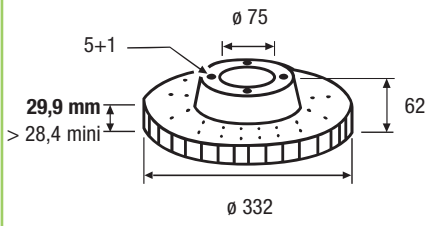

197178

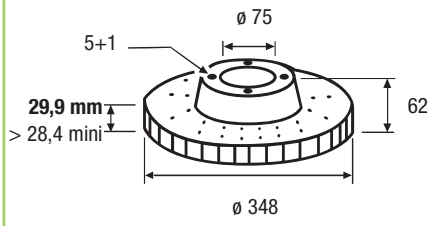

197179

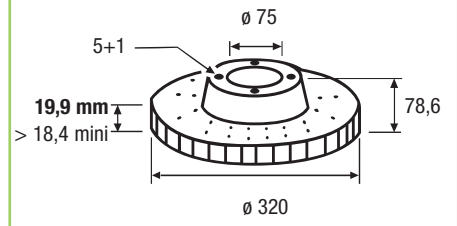

197180

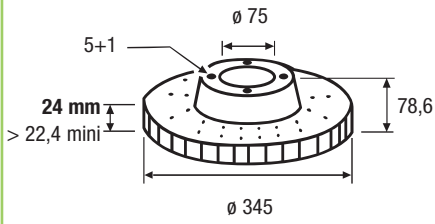

197181

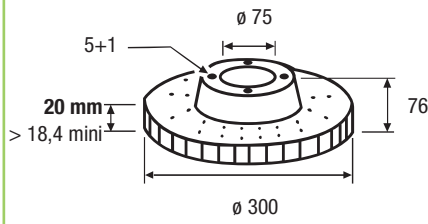

197182

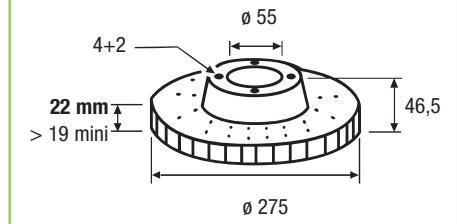

197183

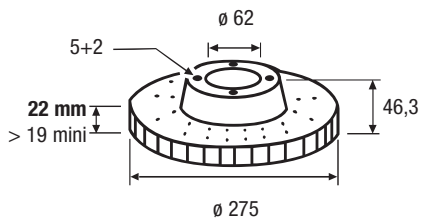

197184

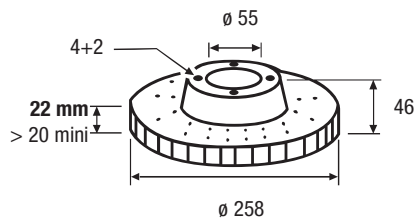

197185

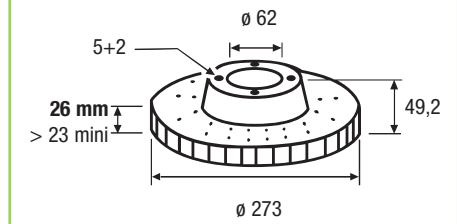

197186

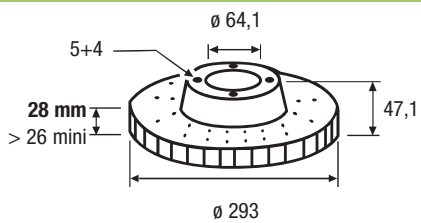

197187

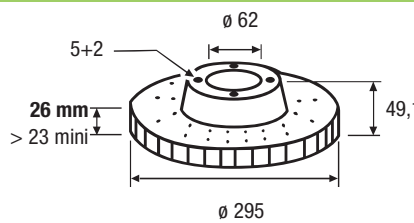

197188

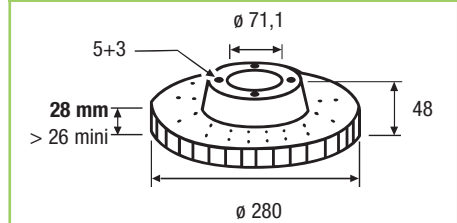

197190

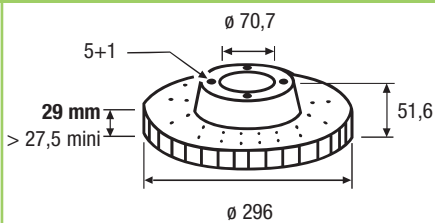

197191

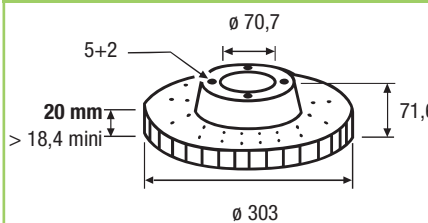

197192

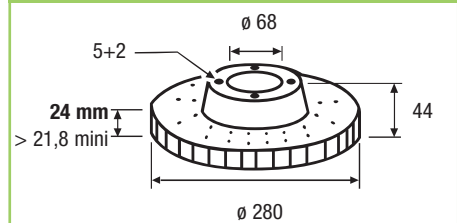

197193

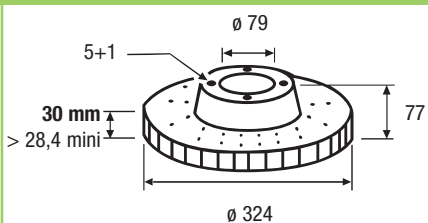

197194

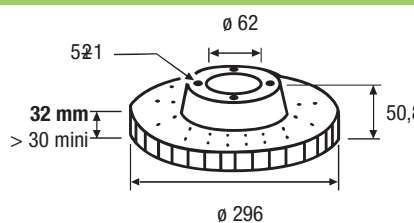

197195

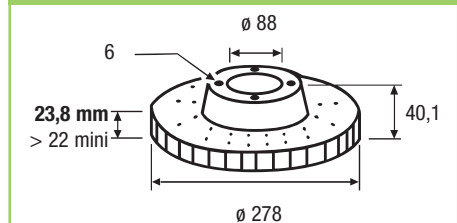

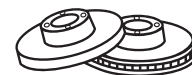

197196

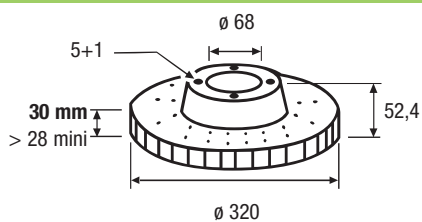

197197

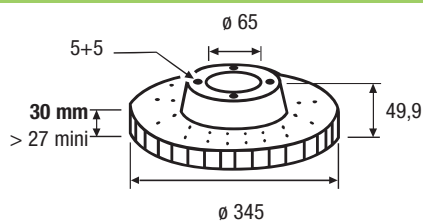

197198

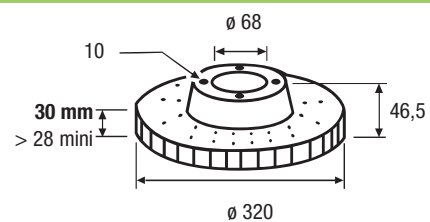

197199

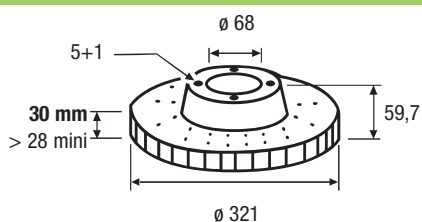

197200

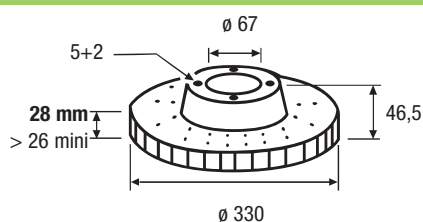

197201

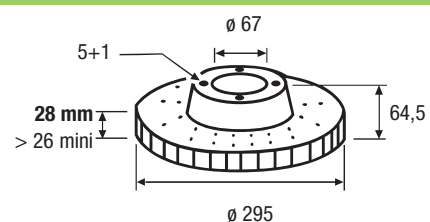

197202

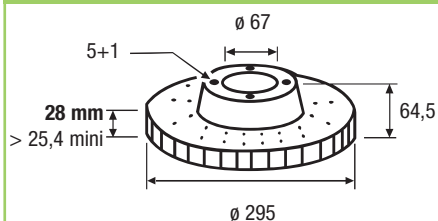

197203

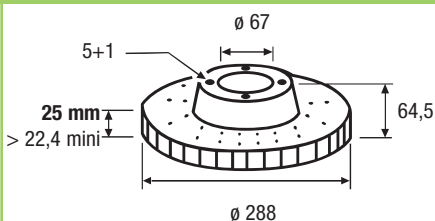

197204

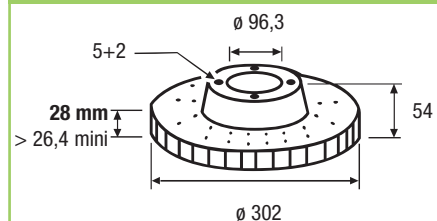

197205

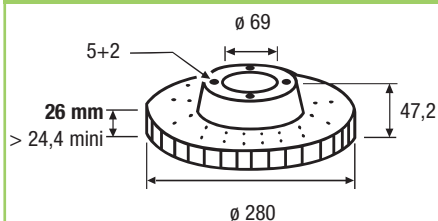

197206

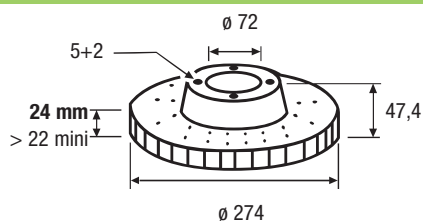

197207

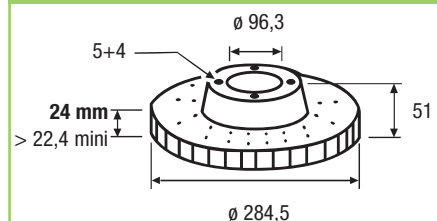

197208

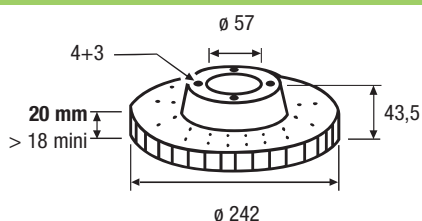

197209

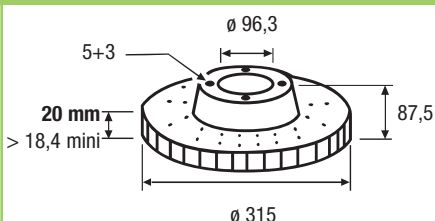

197210

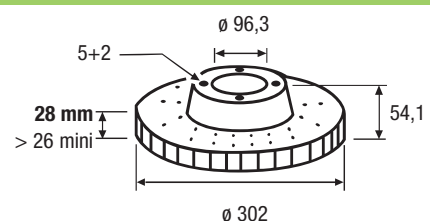

197211

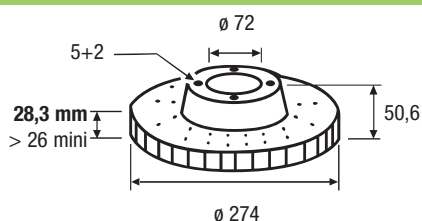

197212

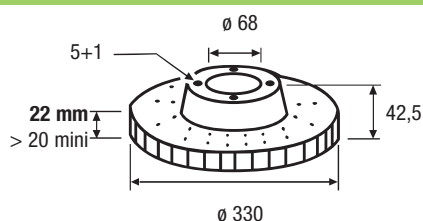

197213

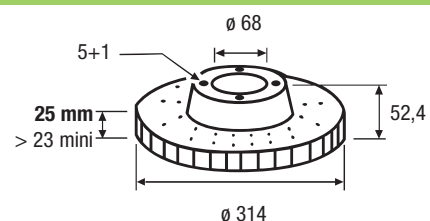

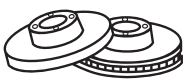

197214

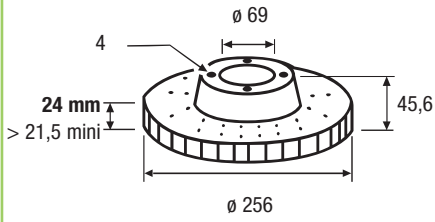

197215

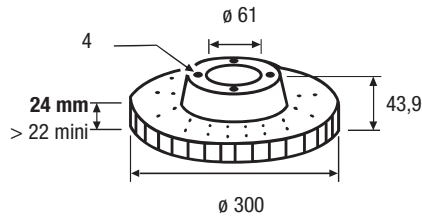

197216

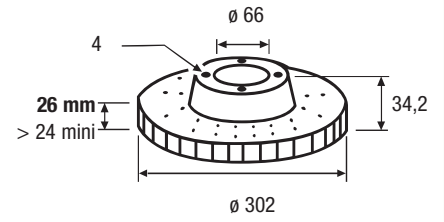

197217

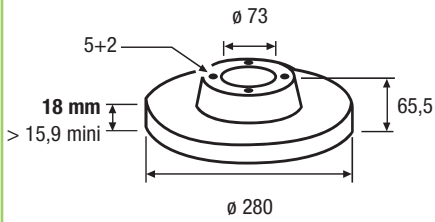

197218

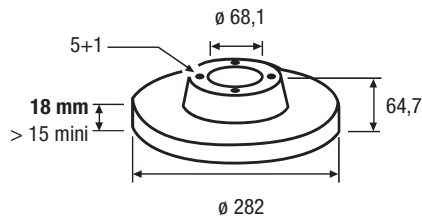

197219

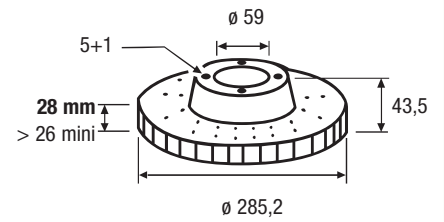

197220

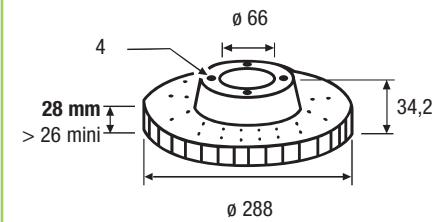

197221

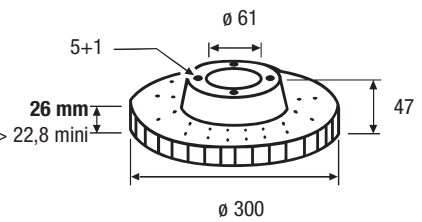

197222

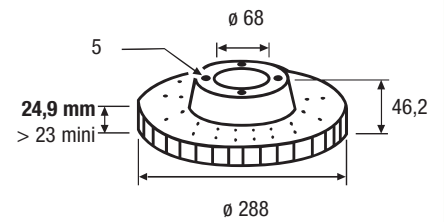

197223

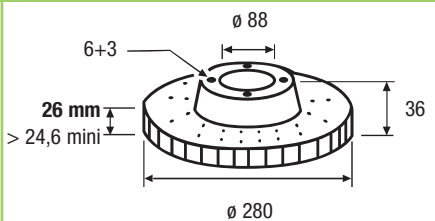

197224

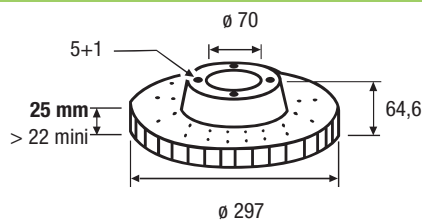

197225

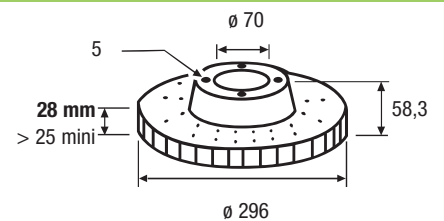

197226

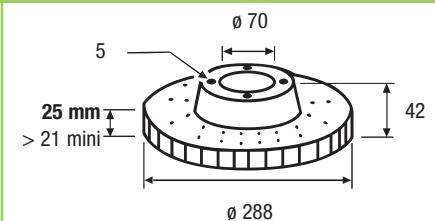

197227

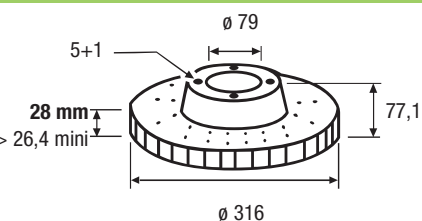

197228

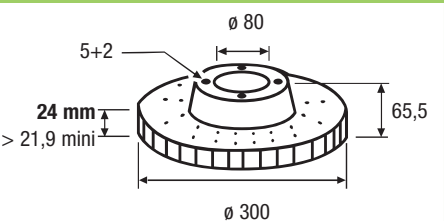

197229

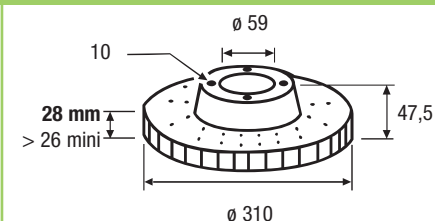

197230

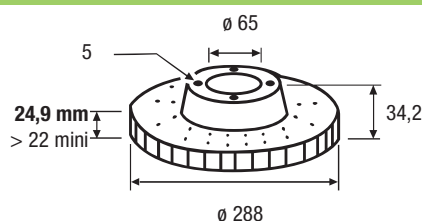

197231

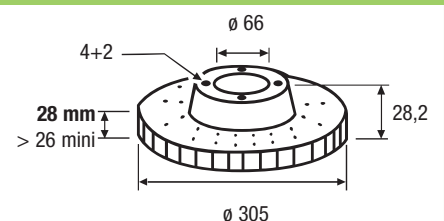

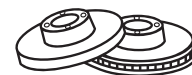

197232

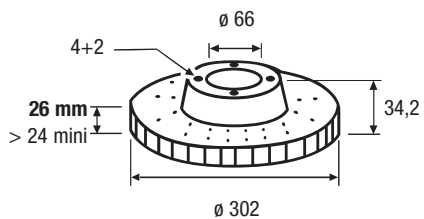

197233

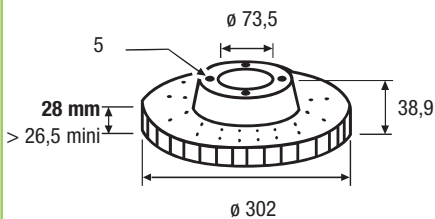

197234

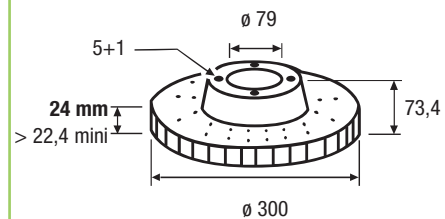

197236

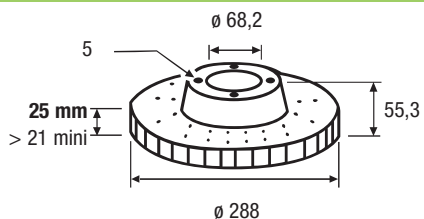

197238

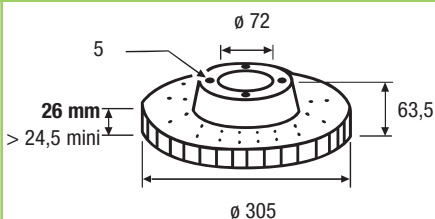

197239

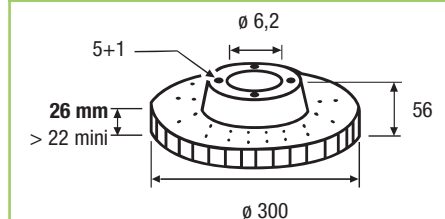

197240

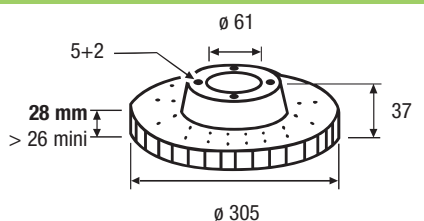

197241

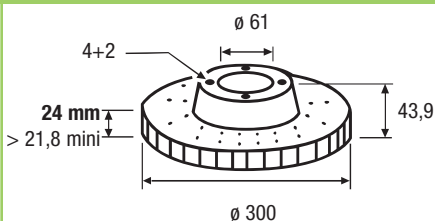

197242

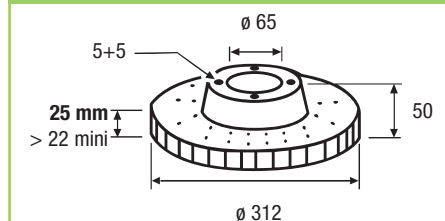

197243

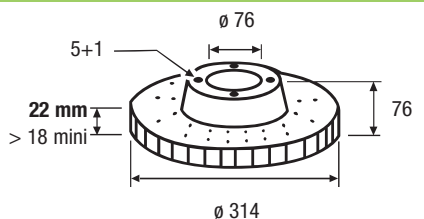

197244

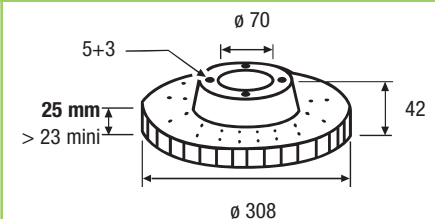

197245

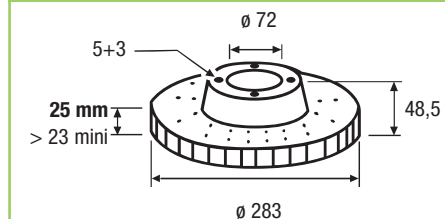

197246

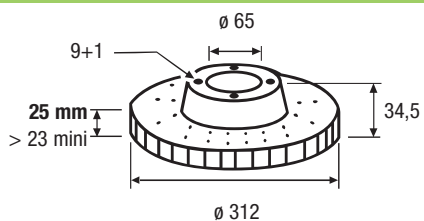

197247

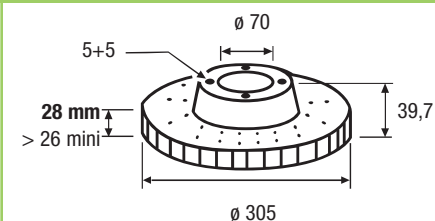

197248

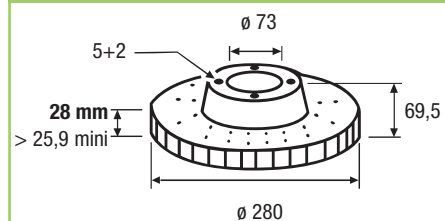

197249

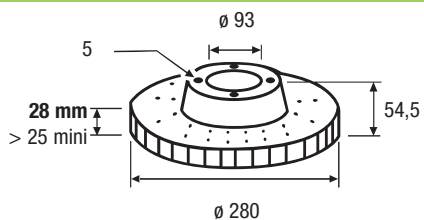

197251

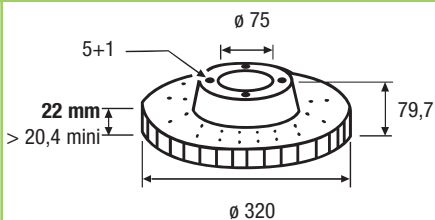

197252

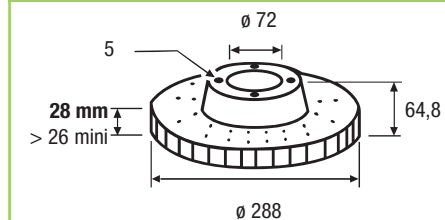

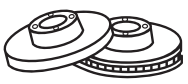



Pads and Discs

Plaquettes et Disques

Pastillas y Discos

Pastillas e Discos

Pastiglie e Dischi

Blokjes en Schijven

Bremsbeläge und Bremsscheiben

Klocki i Tarcze

Balatalari ve Diskleri

Κολοδκι и Δισκι

Δισκόφρενα & Δισκόπλακες

刹车片和刹车盘

بطانات و قرص

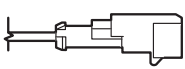

431821



x 2



598241	MERCEDES	150
598315	MERCEDES	150
598601	MERCEDES	150

431823

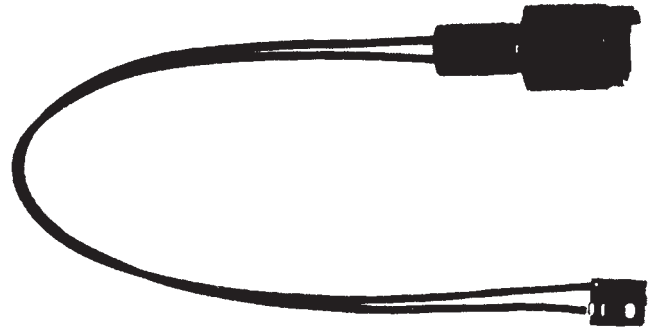

x 1



598103	BMW	260
598104	BMW	260
598107	BMW	260
598259	BMW	260

431822

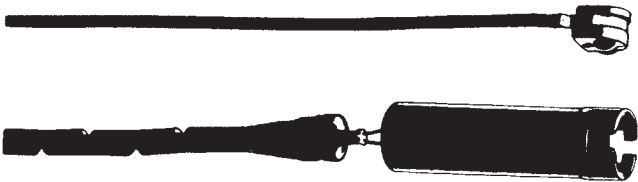

x 1



598018	BMW	790
--------	-----	-----

431824

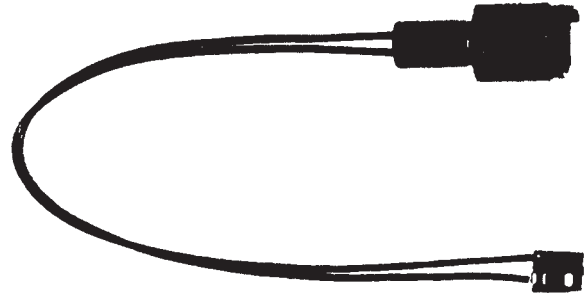

x 1



598231	BMW	220
--------	-----	-----

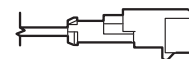

431825



x 2

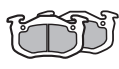

598044

MERCEDES 

185

598044

MERCEDES 

185

431827



x 1

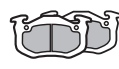

598386

BMW 

790

598753

BMW 

790

431826



x 4

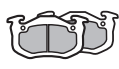

598601

MERCEDES 

94

431828



x 2



598013

MERCEDES 

90

598110

MERCEDES 

90

598110

VOLKSWAGEN 

90

598357

MERCEDES 

90

598549

MERCEDES 

90

598636

CHRYSLER 

90

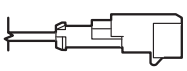

431829

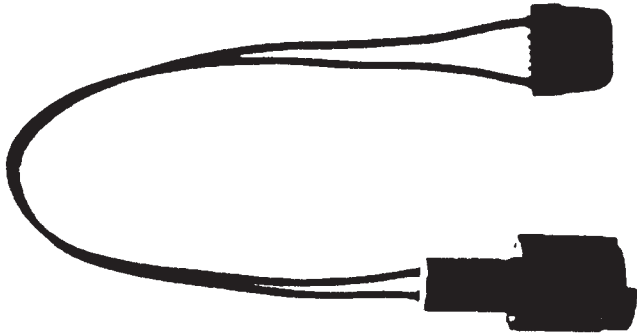

x 1



598237

SAAB 

250

431831

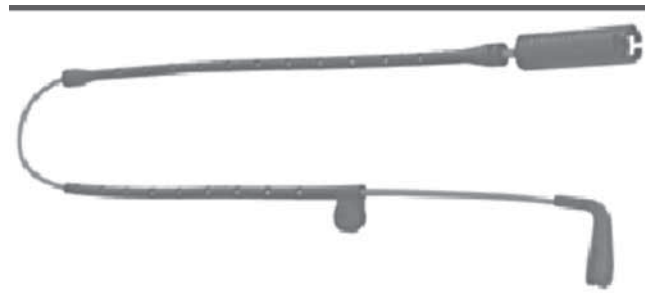

x 1



598310

BMW 

830

431830

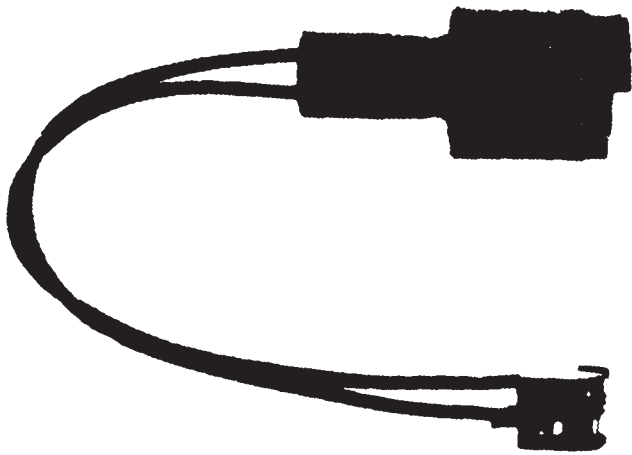

x 1



598103

BMW 

165

598104

BMW 

165

598107

BMW 

165

431832

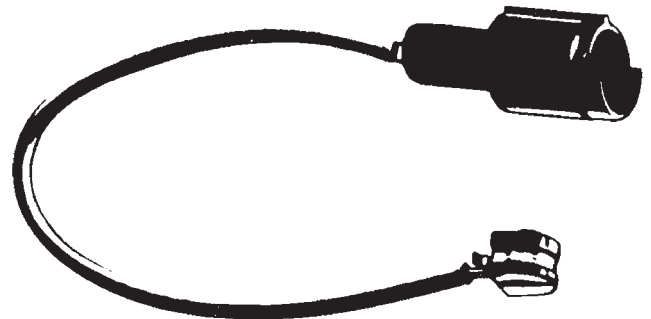

x 1



598231

BMW 

230

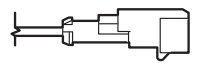

431834

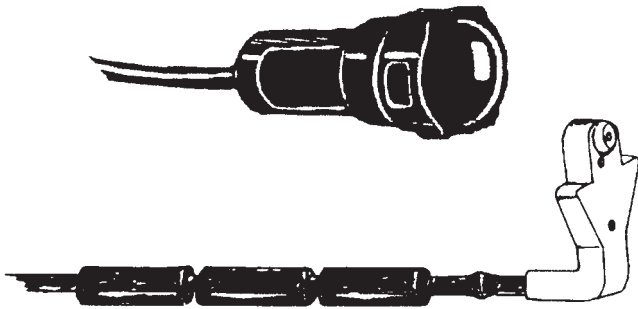

x 2



598050

OPEL 

730

431838



x 1



598311

BMW 

545

431836



x 2



598184

OPEL 

685

431839

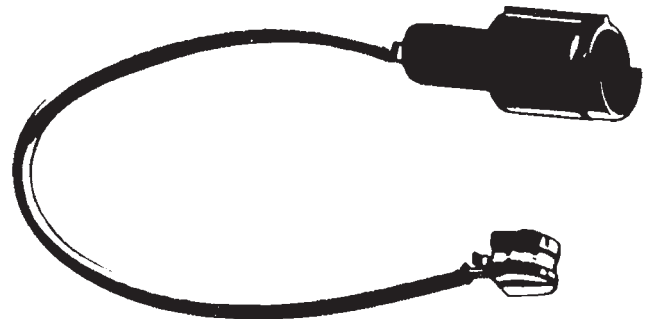

x 1



598259

BMW 

220

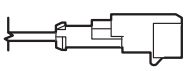

431843

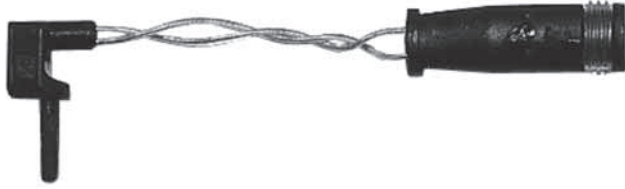

x 2



598447

MERCEDES

95

598448

MERCEDES

95

431847

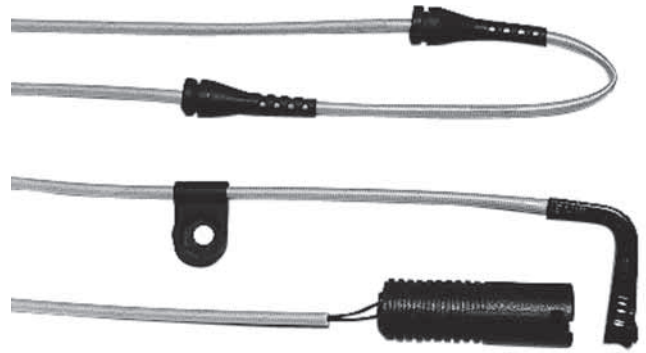

x 1



598311

BMW

1100

431845

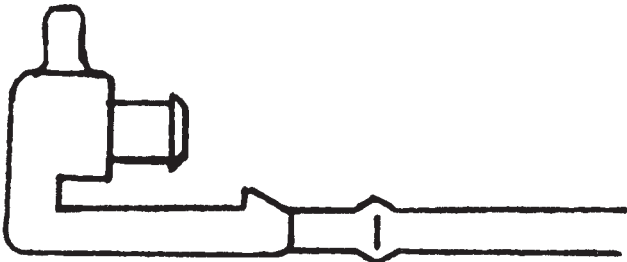
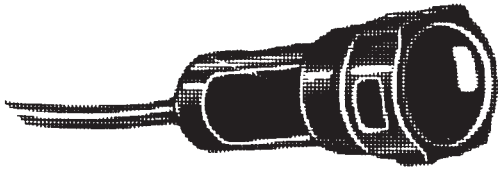

x 2



598182

VAUXHALL

660

598184

OPEL

660

431848

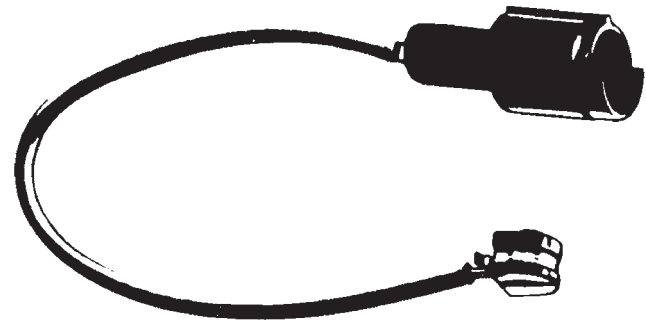

x 1



598231

BMW

315

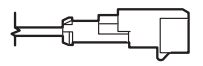

431849

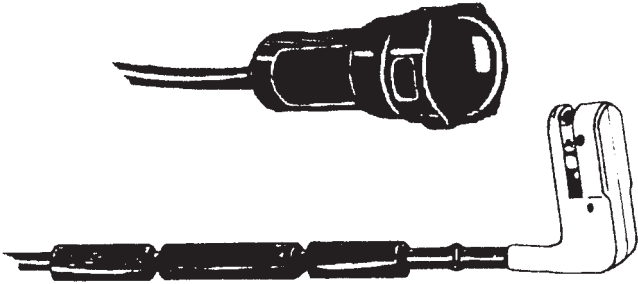

x 2



598182

OPEL 

660

431850



x 1



598231

BMW 

810

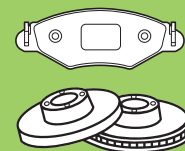
**Pads and Discs**

Plaquettes et Disques

Pastillas y Discos

Pastilas e Discos

Pastiglie e Dischi

Blokjes en Schijven

Bremsbeläge und Bremsscheiben

Klocki i Tarcze

Balatalari ve Diskleri

Колодки и диски

Δισκόφρενα & Δισκόπλακες

刹车片和刹车盘

بطانات و قرص





ATE	
11.0461-3308.2	598291
13.0460-2701.2	598483
13.0460-2704.2	601001
13.0460-2706.2	598939
13.0460-2707.2	601029
13.0460-2708.2	598795
13.0460-2709.2	598641
13.0460-2710.2	598699
13.0460-2711.2	598704
13.0460-2712.2	598583
13.0460-2713.2	598701
13.0460-2714.2	601041
13.0460-2715.2	598804
13.0460-2718.2	598514
13.0460-2720.2	598441
13.0460-2722.2	598928
13.0460-2723.2	598935
13.0460-2724.2	601031
13.0460-2725.2	598925
13.0460-2726.2	598448
13.0460-2727.2	598448
13.0460-2738.2	598899
13.0460-2739.2	601039
13.0460-2740.2	598180 598463
13.0460-2741.2	601010
13.0460-2742.2	601010
13.0460-2744.2	601011
13.0460-2745.2	601042
13.0460-2801.2	598118
13.0460-2803.2	598022
13.0460-2804.2	598254
13.0460-2805.2	598019
13.0460-2806.2	598982
13.0460-2808.2	598377
13.0460-2809.2	598135
13.0460-2810.2	598382
13.0460-2811.2	598237 598269
13.0460-2813.2	598219
13.0460-2815.2	598256
13.0460-2816.2	598068
13.0460-2817.2	598069
13.0460-2818.2	598482
13.0460-2819.2	598463
13.0460-2820.2	598180 598463
13.0460-2821.2	598330
13.0460-2822.2	598017
13.0460-2823.2	598463
13.0460-2824.2	598374
13.0460-2825.2	598119 598714
13.0460-2826.2	598142 598331
13.0460-2827.2	598581

ATE (.../...)	
13.0460-2828.2	598582
13.0460-2829.2	598326
13.0460-2831.2	598319
13.0460-2832.2	598470
13.0460-2833.2	598549
13.0460-2834.2	598002 598084
13.0460-2835.2	598431
13.0460-2836.2	598599
13.0460-2837.2	598484
13.0460-2838.2	598814
13.0460-2839.2	598807
13.0460-2840.2	598546
13.0460-2842.2	598180
13.0460-2844.2	598467
13.0460-2845.2	598180
13.0460-2850.2	598429 598430
13.0460-2852.2	598430
13.0460-2853.2	598493
13.0460-2854.2	598448
13.0460-2855.2	598583
13.0460-2857.2	598456
13.0460-2858.2	598425 598457
13.0460-2860.2	598180
13.0460-2861.2	598473
13.0460-2862.2	598398
13.0460-2864.2	598463
13.0460-2867.2	598407
13.0460-2868.2	598584
13.0460-2869.2	598353
13.0460-2870.2	598545 598669
13.0460-2871.2	598500
13.0460-2873.2	598482
13.0460-2874.2	598482
13.0460-2875.2	598992
13.0460-2877.2	598674
13.0460-2878.2	598761
13.0460-2879.2	598425
13.0460-2880.2	598752
13.0460-2881.2	598501
13.0460-2882.2	598671
13.0460-2883.2	598667
13.0460-2884.2	598720
13.0460-2885.2	598704
13.0460-2886.2	598463
13.0460-2887.2	598752
13.0460-2888.2	601004
13.0460-2889.2	601004
13.0460-2891.2	598662
13.0460-2892.2	598663
13.0460-2893.2	598664
13.0460-2894.2	598180 598463

ATE (.../...)	
13.0460-2895.2	598473
13.0460-2896.2	598318
13.0460-2897.2	598319
13.0460-2898.2	598439
13.0460-2899.2	598414
13.0460-2901.2	598153
13.0460-2902.2	598138
13.0460-2903.2	598027
13.0460-2912.2	598217
13.0460-2913.2	598169
13.0460-2915.2	598129
13.0460-2916.2	598129
13.0460-2923.2	598241
13.0460-2924.2	598205
13.0460-2925.2	598017
13.0460-2926.2	598004
13.0460-2927.2	598315
13.0460-2928.2	598240
13.0460-2932.2	598241
13.0460-2933.2	598121
13.0460-2934.2	598017
13.0460-2935.2	598621
13.0460-2936.2	598214
13.0460-2937.2	598180
13.0460-2938.2	598205
13.0460-2939.2	598133
13.0460-2941.2	598141 598219
13.0460-2942.2	598219
13.0460-2943.2	598221
13.0460-2944.2	598219
13.0460-2948.2	598095
13.0460-2949.2	598219
13.0460-2951.2	598142 598331
13.0460-2952.2	598135
13.0460-2953.2	598337
13.0460-2954.2	598338
13.0460-2955.2	598084
13.0460-2956.2	598119 598176 598179
13.0460-2957.2	598004 598016
13.0460-2958.2	598017 598252
13.0460-2959.2	598543
13.0460-2960.2	598003
13.0460-2961.2	598134 598135
13.0460-2962.2	598125 598142
13.0460-2963.2	598230
13.0460-2964.2	598217
13.0460-2965.2	598406
13.0460-2966.2	598405

ATE (.../...)	
13.0460-2967.2	598076
13.0460-2968.2	598000 598005
13.0460-2969.2	598289
13.0460-2970.2	598008
13.0460-2971.2	598179
13.0460-2972.2	598025 598048
13.0460-2973.2	598048
13.0460-2975.2	598013
13.0460-2976.2	598070
13.0460-2977.2	598800
13.0460-2978.2	598064
13.0460-2979.2	598010 598985
13.0460-2980.2	598006
13.0460-2981.2	598154 598353
13.0460-2982.2	598622
13.0460-2983.2	598061
13.0460-2984.2	598180 598463
13.0460-2985.2	598337 598695
13.0460-2986.2	598093
13.0460-2987.2	598985
13.0460-2988.2	598093
13.0460-2989.2	598093
13.0460-2999.2	598161
13.0460-3010.2	598187
13.0460-3011.2	598187
13.0460-3013.2	598351
13.0460-3014.2	598351
13.0460-3016.2	598029
13.0460-3024.2	598187
13.0460-3306.2	598291
13.0460-3401.2	598270 598338
13.0460-3403.2	598270
13.0460-3602.2	598125
13.0460-3605.2	598386 598753
13.0460-3802.2	598259
13.0460-3803.2	598103 598259
13.0460-3805.2	598272
13.0460-3806.2	598538
13.0460-3808.2	598270
13.0460-3810.2	598913
13.0460-3811.2	598465 598698
13.0460-3813.2	598702
13.0460-3814.2	598557
13.0460-3815.2	598558
13.0460-3818.2	598426
	598670

 Valeo	
ATE (.../...)	
13.0460-3819.2	598764
13.0460-3821.2	598765
13.0460-3822.2	598158
13.0460-3823.2	598396
13.0460-3824.2	598793
13.0460-3825.2	598727
13.0460-3826.2	598426
13.0460-3827.2	598721
13.0460-3828.2	598722
13.0460-3829.2	598718
13.0460-3831.2	598740
13.0460-3832.2	541728
13.0460-3833.2	598818
13.0460-3834.2	598816
13.0460-3835.2	541736
13.0460-3836.2	598936
13.0460-3837.2	541728
13.0460-3838.2	598987
13.0460-3839.2	598825
13.0460-3840.2	598839
13.0460-3842.2	598876
13.0460-3845.2	598099
13.0460-3846.2	601015
13.0460-3847.2	598927
13.0460-3848.2	598722
13.0460-3850.2	598913
13.0460-3851.2	598702
13.0460-3900.2	598126
	598160
13.0460-3902.2	598294
13.0460-3903.2	598175
13.0460-3904.2	598141
13.0460-3905.2	598126
13.0460-3908.2	598085
13.0460-3911.2	598081
	598177
13.0460-3914.2	598257
13.0460-3915.2	598151
13.0460-3916.2	598029
13.0460-3926.2	598396
13.0460-3927.2	598165
13.0460-3928.2	598077
	598078
	598085
13.0460-3931.2	598592
13.0460-3933.2	598082
13.0460-3934.2	598080
	598081
13.0460-3935.2	598172
13.0460-3936.2	598090
	598603
13.0460-3939.2	598091
13.0460-3940.2	598091
13.0460-3941.2	598081
13.0460-3942.2	598141
13.0460-3943.2	598155
	598181

 Valeo	
ATE (.../...)	
13.0460-3944.2	598032
13.0460-3947.2	598028
13.0460-3948.2	598280
13.0460-3949.2	601021
13.0460-3950.2	598012
13.0460-3951.2	598011
13.0460-3952.2	598155
	598181
13.0460-3953.2	598080
13.0460-3954.2	598158
	598396
13.0460-3955.2	598080
13.0460-3956.2	598031
13.0460-3957.2	598073
13.0460-3959.2	598037
13.0460-3960.2	598036
13.0460-3961.2	598077
	598085
13.0460-3962.2	598075
	598081
	598181
13.0460-3964.2	598035
13.0460-3965.2	598172
	598399
13.0460-3966.2	598465
13.0460-3967.2	598078
	598085
13.0460-3968.2	598366
13.0460-3969.2	598086
13.0460-3970.2	598593
13.0460-3971.2	598594
13.0460-3972.2	598383
13.0460-3973.2	598385
13.0460-3975.2	598461
13.0460-3977.2	598726
13.0460-3978.2	598462
13.0460-3979.2	598329
13.0460-3980.2	598299
13.0460-3982.2	598426
13.0460-3983.2	598427
13.0460-3984.2	598428
13.0460-3985.2	598301
13.0460-3986.2	598420
13.0460-3987.2	598433
13.0460-3990.2	598300
13.0460-3993.2	598432
	598453
13.0460-3994.2	598464
13.0460-3995.2	598453
13.0460-3996.2	598417
13.0460-3997.2	598419
13.0460-3998.2	598416
13.0460-3999.2	598638
13.0460-4014.2	598179
	598295
13.0460-4015.2	598107
	598187

 Valeo	
ATE (.../...)	
13.0460-4019.2	598113
13.0460-4028.2	598099
13.0460-4029.2	598099
13.0460-4030.2	598105
13.0460-4033.2	598099
13.0460-4034.2	598345
13.0460-4035.2	598099
	598115
	598182
13.0460-4039.2	598243
13.0460-4040.2	598183
	598187
13.0460-4041.2	598030
	598156
13.0460-4042.2	598030
	598156
13.0460-4043.2	598253
13.0460-4047.2	598617
13.0460-4048.2	598111
13.0460-4059.2	598063
13.0460-4060.2	598763
13.0460-4062.2	598375
13.0460-4063.2	598375
13.0460-4064.2	598444
13.0460-4065.2	598447
13.0460-4066.2	598156
	598360
13.0460-4069.2	598446
13.0460-4201.2	598601
13.0460-4401.2	598613
13.0460-4412.2	598099
13.0460-4801.2	598859
13.0460-4805.2	598861
13.0460-4807.2	598891
13.0460-4809.2	598891
13.0460-4812.2	598892
13.0460-4816.2	598768
13.0460-4817.2	598995
13.0460-4823.2	541735
13.0460-4826.2	598882
13.0460-4830.2	541734
13.0460-4833.2	598994
13.0460-4847.2	541663
13.0460-4900.2	598364
13.0460-4901.2	598292
13.0460-4902.2	598146
13.0460-4903.2	598207
13.0460-4905.2	598148
	598292
13.0460-4906.2	598144
	598591
13.0460-4907.2	598147
13.0460-4908.2	598150
13.0460-4909.2	598145
	598149
13.0460-4910.2	598362

 Valeo	
ATE (.../...)	
13.0460-4911.2	598207
13.0460-4913.2	598598
13.0460-4918.2	598585
13.0460-4919.2	598586
13.0460-4921.2	598418
13.0460-4953.2	598007
13.0460-4956.2	598292
13.0460-4957.2	598055
13.0460-4958.2	598859
13.0460-4959.2	598115
13.0460-4966.2	541662
13.0460-4967.2	598766
13.0460-4968.2	598988
13.0460-4969.2	598466
13.0460-4971.2	598309
	598772
13.0460-4972.2	598468
13.0460-4974.2	598914
13.0460-4976.2	598770
13.0460-4977.2	598719
13.0460-4978.2	598568
13.0460-4979.2	598569
	598570
13.0460-4980.2	598569
	598570
13.0460-4984.2	541655
	598445
13.0460-4985.2	598988
13.0460-4986.2	598328
13.0460-4987.2	598767
13.0460-4988.2	598768
13.0460-4989.2	541717
13.0460-4990.2	598659
13.0460-4992.2	598655
13.0460-4993.2	598656
13.0460-4994.2	601034
13.0460-4995.2	598468
13.0460-4996.2	541705
13.0460-5029.2	598125
13.0460-5030.2	598108
13.0460-5031.2	598375
13.0460-5032.2	598108
13.0460-5038.2	598115
13.0460-5405.2	598018
13.0460-5409.2	598271
13.0460-5410.2	598271
13.0460-5418.2	598178
13.0460-5423.2	598168
13.0460-5469.2	598111
13.0460-5602.2	601040
13.0460-5603.2	598943
13.0460-5604.2	598933
13.0460-5700.2	598847
13.0460-5701.2	598109
	598110
13.0460-5703.2	598269



 Valeo	
ATE (.../...)	
13.0460-5708.2	598883
13.0460-5709.2	598873
13.0460-5711.2	598682
	601043
13.0460-5714.2	598824
13.0460-5717.2	598806
13.0460-5742.2	598842
13.0460-5743.2	598862
13.0460-5744.2	598777
13.0460-5745.2	598393
13.0460-5746.2	598535
13.0460-5747.2	598857
13.0460-5751.2	601002
13.0460-5753.2	598901
13.0460-5754.2	601038
13.0460-5756.2	598803
13.0460-5757.2	598849
13.0460-5762.2	598746
13.0460-5765.2	598819
13.0460-5766.2	601037
13.0460-5768.2	601052
13.0460-5769.2	598933
13.0460-5777.2	598937
13.0460-5778.2	598738
13.0460-5782.2	598932
13.0460-5783.2	598738
13.0460-5785.2	598942
13.0460-5788.2	598941
13.0460-5790.2	598888
13.0460-5800.2	598736
13.0460-5801.2	598641
13.0460-5812.2	598577
13.0460-5813.2	598665
13.0460-5814.2	598812
13.0460-5815.2	598679
13.0460-5819.2	598680
13.0460-5820.2	598494
13.0460-5821.2	598648
13.0460-5825.2	598436
	598451
13.0460-5826.2	598844
13.0460-5827.2	598682
	598758
13.0460-5829.2	598708
13.0460-5830.2	598512
13.0460-5831.2	598647
13.0460-5832.2	598505
	598759
13.0460-5833.2	598051
	598748
13.0460-5834.2	598836
13.0460-5835.2	598984
13.0460-5836.2	598843
13.0460-5837.2	598991
13.0460-5838.2	598830
13.0460-5839.2	598697

 Valeo	
ATE (.../...)	
13.0460-5840.2	598810
13.0460-5841.2	598449
13.0460-5842.2	598452
13.0460-5843.2	598672
	601009
13.0460-5844.2	598653
13.0460-5845.2	598809
13.0460-5846.2	598541
13.0460-5847.2	598542
13.0460-5848.2	598536
13.0460-5849.2	598673
13.0460-5850.2	598828
13.0460-5851.2	598530
13.0460-5852.2	598856
13.0460-5853.2	598518
13.0460-5854.2	598521
13.0460-5855.2	598520
	598852
13.0460-5856.2	598831
13.0460-5857.2	598534
13.0460-5859.2	598361
13.0460-5860.2	598757
13.0460-5861.2	598435
13.0460-5864.2	598534
13.0460-5865.2	598835
13.0460-5867.2	598745
13.0460-5868.2	598910
13.0460-5869.2	598810
13.0460-5871.2	598841
13.0460-5872.2	598051
	598052
	598505
13.0460-5873.2	598574
	598744
13.0460-5874.2	598817
13.0460-5875.2	598781
13.0460-5876.2	598739
13.0460-5878.2	598887
13.0460-5879.2	598524
13.0460-5880.2	598912
13.0460-5881.2	598123
13.0460-5882.2	598944
13.0460-5884.2	598515
13.0460-5885.2	598504
13.0460-5886.2	598506
13.0460-5887.2	598733
13.0460-5888.2	598848
13.0460-5890.2	598522
13.0460-5894.2	598710
13.0460-5895.2	598915
13.0460-5896.2	598511
13.0460-5897.2	598491
13.0460-5898.2	598850
13.0460-5899.2	598644
13.0460-5916.2	598185
13.0460-5917.2	598131

 Valeo	
ATE (.../...)	
13.0460-5919.2	598047
13.0460-5920.2	598022
	598248
13.0460-5922.2	598047
	598056
13.0460-5923.2	598989
13.0460-5925.2	598039
	598184
13.0460-5926.2	598460
13.0460-5927.2	598507
13.0460-5929.2	598682
	598911
13.0460-5930.2	598612
13.0460-5931.2	598293
13.0460-5932.2	598250
13.0460-5934.2	598239
13.0460-5935.2	598921
13.0460-5936.2	598052
13.0460-5937.2	598123
13.0460-5938.2	598402
	598947
13.0460-5939.2	598266
13.0460-5940.2	598597
13.0460-5941.2	598628
13.0460-5942.2	598020
13.0460-5943.2	598495
	598760
13.0460-5944.2	598274
13.0460-5947.2	598220
13.0460-5948.2	598224
13.0460-5949.2	598024
13.0460-5950.2	598054
13.0460-5951.2	598551
	598579
	598625
13.0460-5952.2	598625
13.0460-5953.2	598626
13.0460-5954.2	598250
	598629
13.0460-5955.2	598056
	598627
13.0460-5956.2	598014
13.0460-5957.2	598618
13.0460-5958.2	598517
	601020
13.0460-5959.2	598602
13.0460-5960.2	598122
13.0460-5962.2	598384
13.0460-5963.2	598278
13.0460-5964.2	598123
13.0460-5965.2	598296
13.0460-5966.2	598021
13.0460-5967.2	598023
13.0460-5968.2	598496
13.0460-5969.2	598815
13.0460-5970.2	598268
13.0460-5971.2	598964

 Valeo	
ATE (.../...)	
13.0460-5972.2	598624
13.0460-5973.2	598290
	598846
13.0460-5974.2	598646
13.0460-5976.2	598266
	598579
13.0460-5978.2	598691
	598915
13.0460-5980.2	598519
	598834
13.0460-5981.2	598519
13.0460-5982.2	598627
13.0460-5983.2	598668
13.0460-5984.2	598826
13.0460-5985.2	598666
13.0460-5986.2	598057
13.0460-5987.2	598320
13.0460-5988.2	598071
13.0460-5989.2	598642
13.0460-5992.2	598897
13.0460-5993.2	598902
13.0460-5994.2	598361
13.0460-5995.2	598846
13.0460-5996.2	598316
13.0460-5998.2	598053
	598437
13.0460-5999.2	598131
13.0460-6008.2	598186
13.0460-6015.2	541655
13.0460-6027.2	598111
13.0460-6028.2	598106
13.0460-6029.2	598110
13.0460-6033.2	598231
13.0460-6906.2	598129
13.0460-6910.2	598129
	598391
13.0460-6911.2	598129
	598392
13.0460-6912.2	598392
13.0460-6916.2	598498
13.0460-6917.2	598497
13.0460-7005.2	598167
13.0460-7026.2	598212
13.0460-7027.2	598166
	598334
13.0460-7030.2	598127
	598258
13.0460-7032.2	598128
13.0460-7033.2	598124
13.0460-7036.2	598103
13.0460-7038.2	598182
13.0460-7040.2	598120
	598335
13.0460-7041.2	598120
13.0460-7042.2	598168
13.0460-7046.2	598104

ATE (.../...)	
13.0460-7047.2	598103
13.0460-7048.2	598099
	598182
13.0460-7049.2	598281
13.0460-7051.2	598039
	598184
	598356
13.0460-7052.2	598184
13.0460-7053.2	598616
13.0460-7054.2	598130
13.0460-7055.2	598130
13.0460-7056.2	598033
13.0460-7057.2	598034
	598630
13.0460-7058.2	598038
13.0460-7059.2	598258
13.0460-7060.2	598033
13.0460-7061.2	598502
13.0460-7063.2	598271
13.0460-7064.2	598040
13.0460-7065.2	598041
13.0460-7067.2	598040
13.0460-7069.2	598065
	598308
13.0460-7071.2	598166
	598212
13.0460-7072.2	598066
13.0460-7073.2	598043
	598171
13.0460-7076.2	598067
13.0460-7077.2	598355
13.0460-7078.2	598412
13.0460-7079.2	598580
13.0460-7080.2	598050
13.0460-7081.2	598303
13.0460-7082.2	598044
13.0460-7083.2	598045
13.0460-7084.2	598046
13.0460-7085.2	598062
13.0460-7086.2	598357
13.0460-7087.2	598636
13.0460-7088.2	598074
13.0460-7089.2	598310
	598409
13.0460-7090.2	598311
13.0460-7091.2	598305
	601006
13.0460-7100.2	598488
13.0460-7101.2	598403
13.0460-7102.2	598675
13.0460-7105.2	598880
13.0460-7108.2	598424
13.0460-7109.2	598018
13.0460-7110.2	598483
	598751
13.0460-7111.2	598332

ATE (.../...)	
13.0460-7112.2	598308
13.0460-7113.2	601019
13.0460-7114.2	598605
13.0460-7115.2	598322
13.0460-7116.2	598454
13.0460-7117.2	598408
13.0460-7121.2	598317
13.0460-7122.2	598486
13.0460-7123.2	598858
13.0460-7124.2	598676
13.0460-7125.2	598607
	598619
13.0460-7126.2	598422
	598424
13.0460-7127.2	598423
13.0460-7128.2	601019
13.0460-7129.2	598006
13.0460-7132.2	598423
13.0460-7133.2	601003
13.0460-7134.2	598063
	598295
13.0460-7135.2	598480
13.0460-7137.2	598472
	598783
13.0460-7138.2	598440
13.0460-7140.2	598065
	598990
13.0460-7141.2	598422
13.0460-7142.2	598564
13.0460-7144.2	598632
13.0460-7145.2	598479
13.0460-7148.2	598563
13.0460-7153.2	598565
13.0460-7154.2	598801
13.0460-7155.2	598811
13.0460-7156.2	598489
13.0460-7157.2	598566
13.0460-7158.2	598471
13.0460-7159.2	598471
13.0460-7160.2	598472
13.0460-7161.2	598413
13.0460-7162.2	598643
13.0460-7163.2	598630
13.0460-7164.2	598805
13.0460-7165.2	598619
13.0460-7166.2	598750
13.0460-7167.2	598410
13.0460-7168.2	598411
13.0460-7169.2	598820
13.0460-7171.2	598637
13.0460-7172.2	598678
13.0460-7173.2	598305
	598475
13.0460-7174.2	598754
13.0460-7175.2	601005
13.0460-7176.2	598640

ATE (.../...)	
13.0460-7177.2	598735
13.0460-7178.2	598734
13.0460-7179.2	598860
13.0460-7181.2	598990
13.0460-7182.2	598845
13.0460-7184.2	598635
13.0460-7186.2	598639
13.0460-7187.2	601030
13.0460-7188.2	598657
13.0460-7189.2	598829
13.0460-7190.2	598967
13.0460-7191.2	598940
13.0460-7192.2	598651
	598652
	598860
13.0460-7193.2	598649
13.0460-7194.2	598472
	598783
13.0460-7195.2	598472
	601005
	601044
13.0460-7196.2	598044
13.0460-7199.2	598808
13.0460-7200.2	598863
13.0460-7201.2	598779
13.0460-7202.2	598715
13.0460-7203.2	598636
13.0460-7204.2	598822
13.0460-7206.2	598510
13.0460-7207.2	598756
13.0460-7211.2	598729
13.0460-7213.2	601026
13.0460-7214.2	601028
13.0460-7215.2	598700
13.0460-7216.2	598640
13.0460-7217.2	598703
13.0460-7218.2	598946
13.0460-7219.2	598802
13.0460-7220.2	598728
13.0460-7221.2	601012
13.0460-7222.2	598993
13.0460-7225.2	598885
13.0460-7226.2	598635
13.0460-7228.2	598879
13.0460-7229.2	598997
13.0460-7230.2	598998
13.0460-7236.2	598651
13.0460-7237.2	598898
13.0460-7238.2	601027
13.0460-7240.2	598652
13.0460-7242.2	601036
13.0460-7243.2	601007
13.0460-7244.2	601051
13.0460-7248.2	601012
13.0460-7251.2	598783
13.0460-7253.2	598783

ATE (.../...)	
13.0460-7254.2	598997
13.0460-7256.2	598996
13.0460-7257.2	601051
13.0460-7258.2	601014
13.0460-7903.2	540436
13.0460-7904.2	541664
	598966
13.0460-7906.2	541641
13.0460-8002.2	598458
13.0460-8003.2	598556
13.0460-8004.2	598442
13.0460-8005.2	598443
13.0460-8006.2	598389
13.0460-8007.2	598813
13.0460-8008.2	598755
13.0460-8009.2	598600
13.0460-9028.2	598109
13.0460-9029.2	598110
13.0460-9030.2	598107
13.0460-9031.2	598107
13.0460-9034.2	598107
13.0462-4856.2	598111
13.0463-2821.2	598330
13.0463-2822.2	598017
13.0463-2834.2	598002
	598084
13.0463-2854.2	598448
13.0463-2957.2	598004
	598016
13.0463-2958.2	598017
	598252
13.0463-2975.2	598013
13.0463-4967.2	598766
13.0463-4987.2	598767
13.0463-4988.2	598768
13.0463-5405.2	598018
13.0463-6033.2	598231
13.0463-7032.2	598128
13.0463-7051.2	598039
	598356
13.0463-7052.2	598184
13.0463-7071.2	598166
	598212
13.0463-7086.2	598357
13.0463-7087.2	598636
13.0463-7089.2	598310
	598409
13.0463-7091.2	598305
	601006
13.0463-7110.2	598483
	598751
13.0463-7115.2	598322
13.0463-7116.2	598454
13.0463-7117.2	598332
	598408
13.0463-7121.2	598317



ATE (.../...)	
13.0463-7122.2	598303
	598486
13.0463-7142.2	598564
13.0463-7155.2	598811
13.0463-7161.2	598413
13.0469-5440.2	598168
13.0469-5466.2	598168
13.0469-5480.2	598168
13.0469-5482.2	598168
13046028302	598318
13046028592	598681
13046028632	598553
13046028722	598650
	598681
13046038002	598537
13046038072	598012
13046038092	598696
13046038122	598633
13046039462	598490
13046039762	598926
13046039882	598434
	598527
13046039912	598633
13046039922	598547
13046058022	598548
13046058032	598575
13046058042	598780
13046058072	598450
13046058082	598840
13046058092	598478
13046058102	598737
	598917
13046058112	598606
13046058172	598827
13046058182	598788
13046059282	598494
13046059332	598051
	598574
	598786
13046071432	598489
13046071832	598712
27.0460.0301.2	598145
27.0460-0302.2	598375
27.0460-0303.2	598148
27.0460-0304.2	598363
27.0460-0305.2	598375
27.0460-0700.2	598256
27.0460-0801.2	598375
27.0460-0802.2	598193
27.0460-0803.2	598193
27.0460-0804.2	598593
27.0460-0805.2	598594
27.0460-1001.2	598086
27.0460-1002.2	598366
27.0460-1003.2	598086
27.0460-1005.2	598374

ATE (.../...)	
27.0460-1204.2	598163
27.0460-1205.2	598077
	598085
27.0460-1206.2	598375
27.0460-1208.2	598081
27.0460-1209.2	598162
27.0460-1302.2	598102
27.0460-1303.2	598015
27.0460-1501.2	598389
27.0460-1709.2	598208
27.0460-2014.2	598268
27.0460-2103.2	598220
27.0460-2203.2	598122
27.0460-2205.2	598123
	598379
27.0460-2209.2	598122
27.0460-2502.2	598984
27.0460-2507.2	598614
BENDIX	
571202B	598405
571204B	598338
571205B	598088
	598099
	598099
	598187
	598584
	598941
571206B	598111
	598174
	598193
571206X	598174
571210B	598144
571212B	598392
571212X	598392
571213B	598050
	598099
	598113
	598187
	598270
571215B	598111
571215X	598111
571217B	598593
	598594
571218B	598193
571218X	598193
571219B	598145
571220B	598146
571221B	598099
571221X	598099
571222B	598375
571223B	598090
571224B	598077
	598078
	598085
571225B	598147

BENDIX (.../...)	
571226B	598088
571227B	598077
	598375
571228B	598178
571228X	598178
571232B	598099
571233B	598391
571234B	598337
571234X	598337
571236B	598106
	598111
571236X	598106
	598111
571243B	598085
	598142
571244B	598165
571244X	598165
571245B	598375
571246B	598366
571247B	598168
571247X	598168
571248B	598375
571250B	598007
	598129
	598596
571250X	598007
	598129
	598596
571251B	598076
571252B	598592
571253B	598161
	598187
	598338
571254B	598113
571255B	598109
	598110
571255X	598109
	598110
571260B	598107
571261B	598107
571262B	598077
	598085
	598175
571262X	598175
571263B	598150
571264B	598148
	598292
571264X	598148
	598292
571265B	598389
571271B	598108
571271X	598108
571272B	598109
	598613
571272X	598109
	598613

BENDIX (.../...)	
571276B	598182
571276X	598182
571278B	598110
571278X	598110
571279B	598099
571279X	598099
571284B	598168
571285B	598081
571286B	598162
571288B	598377
571291B	598166
	598212
571291X	598166
	598171
	598212
	598334
571294B	598116
571296B	598149
571297B	598091
	598093
571297X	598091
	598093
	598219
571298B	598168
571300B	598103
	598291
571301B	598094
	598125
	598133
	598141
	598142
	598219
571302B	598151
571302X	598151
571303B	598163
571304B	598153
571305B	598371
571306B	598086
571307B	598126
	598160
571308B	598169
	598217
571309B	598006
	598012
	598091
	598093
	598095
	598134
	598135
	598141
	598219
571309X	598006
	598012
	598091
	598093
	598095
	598134

BENDIX (.../...)	
	598135
	598141
	598219
571312B	598167
571313B	598061
571314B	598130
571315B	598127
	598258
571315X	598127
	598258
571316B	598124
571316X	598124
571317B	598128
571317X	598128
571318B	598090
	598091
	598603
571319B	598119
	598176
	598714
571319X	598119
571320B	598176
571320X	598176
571321B	598007
	598374
571322B	598375
571323B	598375
571325B	598007
571327B	598002
	598084
571330B	598095
	598219
571330X	598095
	598219
571331B	598080
571331X	598080
571332B	598081
	598177
	598179
	598338
571332X	598075
	598081
	598177
	598179
	598338
	598366
571333B	598081
571333X	598081
571334B	598158
	598396
571334X	598396
571335B	598396
571336B	598032
571336X	598032
	598166
571337B	598078
	598085

BENDIX (.../...)	
571337X	598078
	598085
571339B	598082
571339X	598082
571340B	598594
571341B	598126
	598130
	598160
571342B	598107
571344B	598105
571346B	598406
571347B	598135
571349B	598111
571350B	598125
	598142
571351B	598033
	598034
	598120
	598335
	598630
571351X	598033
	598034
	598120
	598335
571353B	598241
571353X	598241
571355B	598231
	598310
571355X	598231
	598310
571356B	598017
571356X	598017
571357B	598017
	598252
571357X	598017
	598252
571359B	598179
571359X	598179
571361B	598180
	598463
571361X	598180
	598463
571362B	598090
	598603
571363B	598148
	598292
571364B	598003
571365B	598006
571366B	598294
571367B	598030
	598156
	598181
571367X	598030
	598156
571368B	598112
571369B	598029

BENDIX (.../...)	
571370B	598222
	598257
571372B	598109
571372X	598109
571374B	598187
571375B	598205
	598214
571375X	598205
	598214
571376B	598004
	598016
	598252
	598330
571376X	598004
	598016
571379B	598007
	598129
	598132
	598596
571380B	598027
571380X	598027
571381B	598115
571382B	598315
571382X	598315
571384B	598099
	598113
571385B	598351
571386B	598131
571387B	598103
	598259
	598386
571387X	598103
	598259
	598386
571388B	598272
571389B	598183
	598243
571390B	598183
	598243
571391B	598039
	598184
571391X	598184
571392B	598186
571393B	598138
571394B	598440
571395B	598039
	598502
	598753
571398B	598295
571398X	598295
571400B	598024
	598123
571401B	598118
571402B	598230
571404B	598221
571404X	598221

BENDIX (.../...)	
571405B	598154
571405X	598154
	598353
571406B	598714
571406X	598714
571407B	598050
	598253
571407X	598253
571408B	598121
	598240
	598312
571409B	598142
	598219
	598331
571410B	598008
	598289
571411B	598018
571412B	598043
	598171
571413B	598601
571414B	598015
571415B	598102
571416B	598598
571417B	598270
	598338
	598621
571418B	598621
571419B	540436
571420B	598281
571421B	598057
571422B	598596
571424B	598595
571425B	598055
571425X	598055
571426B	598134
	598135
571426X	598134
	598135
571427B	598859
571428B	598291
571428X	598291
571429B	598103
	598187
571433B	598000
	598005
571435B	598272
571436B	598254
571437B	598019
	598022
571438B	598019
	598022
	598436
	598512
571439B	598129
	598498
571439X	598129
	598498







Valeo	
BENDIX (.../...)	
571440B	598497
571442B	598132
	598380
	598498
571444B	598132
	598380
571446B	540436
	598369
571447B	598596
	598598
571448B	598271
571448X	598271
571449B	598271
571449X	598271
571450B	598115
571452B	598133
571453B	598093
	598533
571454B	598093
	598531
571455B	598093
571456B	598695
571456X	598695
571457B	598616
571457X	598616
571458B	598048
571460B	598025
	598048
571461B	598130
571462B	598016
	598125
	598142
571463B	598603
571463X	598603
571464B	598091
	598160
571465B	598237
	598269
571466B	598108
	598115
571471B	598006
	598010
	598135
571472B	598010
	598985
571473B	598156
571473X	598156
571474B	598125
	598141
571475B	598094
571476B	598061
571476X	598061
571488B	598187
571491B	598099
	598128
	598205



Valeo	
BENDIX (.../...)	
571491X	598128
	598205
571492B	598039
	598184
	598356
571492X	598039
	598356
571493B	598256
571509B	598038
	598074
571509X	598038
	598074
571510B	598353
571511B	598085
	598382
571512B	598483
571513B	598180
571514B	598600
571518B	598965
571519B	598491
571521B	598112
571522B	598033
	598034
	598036
	598120
	598619
571522X	598033
	598034
	598619
571523B	598011
	598012
571523X	598011
571524B	598075
	598081
	598177
	598181
571524X	598075
	598181
571525B	598181
571525X	598181
571526B	598002
	598084
571526X	598002
	598084
571527B	598103
	598386
571528B	598012
571528X	598012
571529B	598104
571530B	598050
571531B	598117
571532B	598374
571533B	598374
571533X	598374
571535B	598237
	598269



Valeo	
BENDIX (.../...)	
571536B	598212
	598838
571536X	598212
571539B	598182
571540B	598169
	598217
571540X	598217
571542B	598104
571543B	598108
	598115
571545B	598103
571546B	598103
	598259
571549B	598116
571550B	598599
571555B	598345
571557B	598103
571559B	598241
571560B	598315
571722B	598617
571725B	598172
571726B	598172
571726X	598172
571733B	598280
571734B	598151
571736B	598294
571741B	598028
	598385
571743B	598155
571743X	598155
571744B	598396
571745B	598036
571745X	598036
571746B	598037
571746X	598037
571747B	598158
571747X	598158
571748B	598080
	598396
571749B	598012
	601021
571749X	598012
	601021
571752B	598294
571753B	598345
571754B	598035
571755B	598035
571755X	598035
571756B	598383
571757B	598031
571800B	598187
571803B	598497
571809B	598077
571816B	601016
571820B	598391
571827B	598623

Valeo	
BENDIX (.../...)	
571828B	598013
571828X	598013
571832B	598033
	598034
	598619
	598630
571832X	598034
571833B	598182
571833X	598182
571835B	598018
571837B	598502
571838B	598064
571839B	598070
571839X	598070
571840B	598800
571840X	598800
571843B	598073
571844B	598044
571845B	598062
571846B	598045
571847B	598622
571847X	598622
571848B	598258
571848X	598258
571849B	598033
	598034
	598120
571850B	598240
571851B	598630
571855B	598121
	598240
	598312
571856B	598303
	598982
571861B	598351
571862B	598095
571867B	598081
	598177
571868B	598241
571872B	598712
571873B	598412
571875B	598482
571876B	598636
571877B	598357
571880B	598231
	598310
571882B	598040
	598483
571883B	598041
571884B	598065
	598308
571887B	598040
571888B	598065
571890B	598363
571891B	598362
571892B	598364



 	
BENDIX (.../...)	
571893B	598012
571894B	598985
571895B	598591
571896B	598207
571897B	598068
571897X	598068
571898B	598069
571898X	598069
571899B	598063
571899X	598063
571900B	598048
	598067
	598303
571902B	598038
	598074
571903B	598385
571904B	598353
571905B	598010
	598219
571906B	598180
	598463
571906X	598180
	598463
571907B	598145
571908B	598581
571910B	598044
	598046
571911B	598075
	598081
571911X	598075
	598081
571912B	598156
	598360
571913B	598043
	598171
571914B	598212
571915B	598066
	598128
571915X	598066
571916B	601019
571917B	598423
	601019
571918B	598580
571919B	598326
571919X	598326
571920B	598305
571921B	598355
571922B	598470
571923B	598488
571924B	598039
	598356
571925B	598444
571929B	598332
571931B	598726
571932B	598490
571933B	598880



 	
BENDIX (.../...)	
571933X	598880
571934B	598675
571935B	598303
571936B	598311
571937B	598441
571938B	598903
571939B	598403
571939X	598403
571940B	598318
571941B	598319
571942B	598320
571943B	598844
571944B	598549
571945B	598549
571946B	598299
571947B	598301
571948B	598048
571949B	598605
571950B	598300
571951B	598308
571952B	598772
571954B	598461
571954X	598461
571955B	598017
571959B	598018
571959X	598018
571960B	598753
571961B	541655
	598445
571962B	598446
571963B	598328
571964B	598399
571964X	598399
571965B	598462
571966B	598398
571967B	598317
571967X	598317
571968B	598322
571969B	598330
571971B	598408
571971X	598408
571972B	598605
	598607
571973B	601003
571974B	598424
571975B	598454
	598860
571976B	598022
571976X	598022
571977B	598053
571977X	598053
571979B	598331
571979X	598142
	598331
571980B	598632
571980X	598632



 	
BENDIX (.../...)	
571981B	598453
571982B	598483
	598751
571982X	598483
	598751
571984B	598486
571985B	598332
571986B	598448
571987B	598448
571988B	598447
571989B	598637
571990B	598410
571991B	598820
571992B	598413
571994B	598811
571995B	598329
571996B	598563
571996X	598563
571997B	598305
	598475
571998B	598431
571998X	598431
571999B	598466
572100B	598268
572127B	598817
572129B	598817
572134B	598437
572135B	598053
572136B	598053
572137B	598053
572138B	598437
	598627
	598682
	598911
572140B	598897
572144B	598293
572145B	598274
	598293
572146B	598274
	598646
572149B	598612
572154B	598826
572155B	598826
572159B	598964
572161B	598290
572162B	598624
572163B	598624
	598835
572166B	598023
572169B	598780
	598846
572175B	598983
572178B	598921
572179B	598532
	598666
572180B	598131



 	
BENDIX (.../...)	
572182B	598540
	598984
572186B	598519
	598834
	598866
572188B	598540
	598984
572189B	598384
572193B	598780
572197B	598828
572200B	598519
572206B	598278
	598379
572207B	598278
572209B	598224
572210B	598628
572216B	598220
572217B	598986
572221B	598507
572226B	598021
	598023
572227B	598020
572229B	598208
572230B	598123
	598379
572232B	598379
572233B	598123
	598379
	598393
572236B	598296
572237B	598047
572238B	598047
572245B	598777
572247B	598533
572250B	598185
572253B	598393
572255B	598266
	598402
	598551
	598815
572256B	598266
	598551
572257B	598014
572258B	598615
572260B	601022
572266B	598266
572268B	598052
572269B	598052
	598817
572271B	598020
572272B	598020
572275B	598476
	598691
572276B	598021
572280B	598597
572281B	598220
	598597





  Valeo	
BENDIX (.../...)	
572284B	598047
	598248
572290B	598851
572295B	598220
	598620
	598626
572299B	598620
572304B	598496
572309B	598047
	598056
	598227
572310B	598054
572311B	598227
572312B	598112
	598123
572313B	598123
572317B	598250
572319B	598239
572320B	598239
572322B	598507
572323B	598532
572324B	598495
572325B	598629
572326B	598614
572327B	598815
572329B	598248
572330B	598047
	598056
	598248
572333B	598551
572336B	598250
572339B	598786
572340B	598494
572342B	598496
572343B	598786
572345B	598786
	598787
572346B	598787
572347B	598051
	598574
	598786
572348B	598460
572349B	598788
572350B	598056
	598627
572354B	598627
572355B	598402
572357B	598809
572360B	598122
572361B	598122
	598123
572362B	598122
572364B	601023
572365B	598947
572367B	598947
572370B	598517
	598597

  Valeo	
BENDIX (.../...)	
	601020
572373B	598123
	598618
572375B	598626
572376B	598668
	598826
572377B	598691
572381B	598625
572382B	598602
572388B	598989
572391B	598266
572393B	598056
	598627
572394B	598897
572396B	598071
572397B	598840
572398B	598449
572399B	598830
572400B	598478
572401B	598575
572402B	598316
572404B	598606
572405B	598737
572406B	598902
572407B	598361
	598902
572409B	598850
572411B	598634
572416B	598528
572417B	598854
572418B	598991
572419B	598522
572420B	598534
572422B	598450
572423B	598530
572424B	598895
572428B	598451
572429B	598436
572430B	598022
572432B	598907
572433B	598697
572434B	598629
572437B	598548
572442B	598908
572447B	601020
572448B	598524
572449B	598887
572450B	598577
572451B	598806
572453B	598505
	598759
572464B	598435
572466B	598452
572468B	598579
572471B	598733
	598832

  Valeo	
BENDIX (.../...)	
572473B	598437
572478B	598758
572480B	598824
572481B	598653
572485B	598665
572487B	598536
572488B	598673
572490B	598780
572491B	598679
572494B	598762
572495B	598523
572496B	598574
572497B	598518
572498B	598520
572499B	598521
572500B	598855
572501B	598672
572502B	598745
572504B	598757
572507B	598658
572508B	598919
572510B	598736
572512B	598542
572513B	598781
572514B	598744
572515B	598857
	601023
572516B	598812
572517B	598827
572519B	598778
572520B	598810
572521B	598741
572522B	598742
572523B	541733
572526B	598707
572528B	598535
	598777
572529B	598875
572532B	598821
572533B	598589
572534B	598504
572536B	598511
572537B	598784
572539B	598644
572540B	598506
572541B	598806
572543B	598579
572544B	601043
572545B	598848
572546B	598541
572547B	598852
572548B	598865
572549B	598823
572550B	598853
572551B	598889
572552B	598883

  Valeo	
BENDIX (.../...)	
572553B	598862
572554B	598710
572556B	598841
572557B	598748
572558B	598914
572560B	598910
572564B	541733
572565B	598856
572566B	598915
572568B	598642
572569B	601037
572570B	598942
572574B	598893
572575B	598738
572576B	601026
572577B	598842
572578B	598896
572579B	598803
572580B	598849
573000B	598467
573001B	598468
573002B	598409
573003B	598479
573004B	598420
573005B	598180
573006B	598484
573007B	598180
	598463
573008B	598473
573009B	598457
573010B	598926
573011B	598456
573012B	598434
573013B	598433
573014B	598407
573015B	598432
	598563
573016B	598566
573017B	598471
573018B	598472
	598783
573019B	598425
573020B	598433
573021B	598480
573022B	598489
573023B	598439
573024B	598438
573025B	598471
573026B	598417
573027B	598419
573028B	598418
573029B	598416
573030B	598464
573031B	598465
573032B	598180
	598463

 → Valeo	
BENDIX (.../...)	
573033B	598543
573034B	598442
573035B	598443
573036B	598462
573037B	598483
	598751
573038B	598650
	598681
573039B	598493
573040B	598735
573041B	598564
573042B	598065
	598308
	598990
573043B	598766
573044B	598768
573045B	598801
	598858
573046B	598807
573047B	598565
573048B	598650
573049B	598482
	598650
573050B	598814
573051B	598461
573052B	598481
573053B	598763
573055B	598538
573056B	598643
573058B	598545
573059B	598546
573060B	598429
573061B	598430
573062B	598459
573063B	598458
573064B	598483
	598992
573065B	598681
573066B	598460
	598661
573067B	598499
573068B	598762
573069B	598965
573071B	598556
573072B	598556
573074B	598426
573074X	598426
573075B	598427
573075X	598427
573076B	598428
573076X	598428
573077B	598510
573078B	598677
573079B	598988
573080B	598411
573081B	598586



 → Valeo	
BENDIX (.../...)	
573082B	598583
573083B	598500
573084B	598501
573085B	598639
573086B	598658
573089B	598678
	598860
573089X	598678
	598860
573090B	598808
573091B	598638
573092B	598445
	598659
573093B	598444
573094B	598424
573095B	598470
573096B	598553
573098B	598463
573099B	598669
573100B	598582
573101B	598667
573102B	598514
573105B	598633
573106B	598676
573107B	598537
573109B	601019
573110B	598547
573110X	598547
573111B	598805
573112B	598674
573113B	598568
573114B	598569
573115B	598570
573115X	598570
573116B	601001
573117B	601029
573118B	598756
573119B	598415
573120B	598434
573122B	598584
573123B	598557
573124B	598558
573125B	598641
573126B	598734
573127B	598720
573128B	598635
573131B	598663
573132B	598662
573133B	598664
573134B	598715
573135B	598718
573136B	598701
573137B	598699
573138B	598700
573139B	598703
573142B	601030



 → Valeo	
BENDIX (.../...)	
573143B	598657
573144B	598761
573145B	598750
573146B	598305
	598475
573147B	598719
573148B	598813
573149B	598859
573151B	598640
573152B	598659
573153B	598860
573158B	598752
573159B	598651
573160B	598652
573161B	598811
573164B	598426
573165B	598721
573166B	598722
573168B	598696
573169B	598012
573170B	598913
573171B	598698
573172B	598670
573173B	598729
573174B	598585
573175B	598728
573177B	601034
573178B	598995
573179B	601007
573181B	601027
573183B	598464
573184B	598465
573186B	598472
	598783
	601005
	601044
573188B	598640
573189B	598410
573190B	598044
573192B	598997
573193B	598998
573194B	598936
573196B	598779
	598845
	598845
573197B	598863
573198B	598779
573199B	598822
573201B	598879
573202B	598802
573203B	598512
573204B	598825
573206B	598489
	598801
573207B	598845
573209B	598649
573210B	598898



 → Valeo	
BENDIX (.../...)	
573211B	601031
573212B	598633
573214B	598035
573216B	598874
573217B	598793
573218B	598740
573219B	601004
573220B	598671
573221B	598764
573222B	598765
573224B	598754
573226B	598704
573227B	598770
573228B	598411
573229B	598768
573230B	598795
573234B	598925
573235B	598702
573236B	598829
573238B	598415
573250B	598928
573252B	601029
573253B	598861
573256B	598438
573266B	601015
573267B	598987
573272B	601011
BOSCH	
0 986 424 005	598392
0 986 424 016	598695
0 986 424 026	598145
0 986 424 027	598039
	598502
0 986 424 029	598115
0 986 424 030	598070
0 986 424 031	598800
0 986 424 033	598064
0 986 424 037	598115
0 986 424 044	598129
	598132
	598380
0 986 424 045	598593
0 986 424 046	598594
0 986 424 047	598371
0 986 424 049	598351
0 986 424 050	598107
0 986 424 069	598591
0 986 424 080	598112
0 986 424 081	598091
0 986 424 092	598254
0 986 424 093	598116
0 986 424 098	598091
0 986 424 100	598093
0 986 424 110	598131







	
BOSCH (.../...)	
0 986 424 117	598130
0 986 424 134	598393
0 986 424 135	598052
	598817
0 986 424 144	598596
0 986 424 145	598007
	598139
0 986 424 147	598396
0 986 424 151	598118
0 986 424 160	598278
0 986 424 167	598006
0 986 424 172	598380
	598391
0 986 424 173	598289
0 986 424 175	598135
0 986 424 176	540436
0 986 424 178	598271
0 986 424 182	598227
0 986 424 183	598177
	598496
0 986 424 184	598005
0 986 424 192	598122
0 986 424 200	598619
0 986 424 204	598602
0 986 424 211	598476
	598691
0 986 424 214	598022
0 986 424 215	598051
	598574
	598786
0 986 424 217	598599
0 986 424 218	598044
0 986 424 219	598046
0 986 424 223	598069
	598467
0 986 424 227	598068
0 986 424 229	598062
0 986 424 230	598266
0 986 424 233	598636
0 986 424 234	598357
0 986 424 236	598067
0 986 424 237	598120
0 986 424 240	598598
0 986 424 244	598019
0 986 424 246	598040
0 986 424 248	598065
	598308
	598990
0 986 424 251	598533
0 986 424 260	598227
0 986 424 261	598122
0 986 424 264	598815
0 986 424 266	598290
0 986 424 267	598497
0 986 424 268	598393
	598897



	
BOSCH (.../...)	
0 986 424 274	598531
0 986 424 277	598035
0 986 424 278	598383
0 986 424 284	598491
0 986 424 286	598623
0 986 424 287	598129
	598497
	598498
0 986 424 289	598056
0 986 424 295	598780
0 986 424 299	598826
0 986 424 313	598777
0 986 424 319	598947
0 986 424 340	598523
0 986 424 347	598066
0 986 424 348	598989
0 986 424 351	598281
0 986 424 352	598630
0 986 424 359	598033
	598120
0 986 424 360	598305
	601006
0 986 424 361	598488
0 986 424 362	601003
0 986 424 363	598556
0 986 424 364	598332
0 986 424 365	598580
0 986 424 366	598460
0 986 424 367	598507
0 986 424 368	598634
0 986 424 369	598071
	598697
0 986 424 370	598320
0 986 424 371	598318
0 986 424 373	598217
0 986 424 374	598010
0 986 424 375	598482
0 986 424 376	598714
0 986 424 379	598011
	598012
0 986 424 381	598169
0 986 424 382	598402
	598540
	598614
	598947
0 986 424 383	598540
	598983
	598984
0 986 424 394	598085
0 986 424 400	598310
	598409
	598640
0 986 424 402	598675
0 986 424 410	598038
	598074
0 986 424 411	598030
	598156



	
BOSCH (.../...)	
	598360
0 986 424 414	598326
0 986 424 415	598073
0 986 424 416	598043
	598171
0 986 424 418	598817
0 986 424 421	598077
0 986 424 427	598319
0 986 424 449	598403
0 986 424 450	598317
0 986 424 451	598470
0 986 424 452	598074
0 986 424 453	598461
0 986 424 455	598726
0 986 424 456	598322
0 986 424 457	598454
	598860
0 986 424 458	598271
0 986 424 459	598311
0 986 424 460	598303
0 986 424 461	598475
0 986 424 462	598212
0 986 424 463	598045
0 986 424 464	598844
0 986 424 465	598830
0 986 424 466	598458
0 986 424 467	598459
0 986 424 468	598330
0 986 424 469	598549
	598582
0 986 424 470	598549
	598582
0 986 424 471	598329
0 986 424 472	598431
0 986 424 473	598385
0 986 424 474	598361
	598902
0 986 424 475	598445
0 986 424 476	598299
0 986 424 478	598926
0 986 424 480	598490
0 986 424 481	598355
0 986 424 482	598483
	598751
0 986 424 483	598018
0 986 424 484	598753
0 986 424 485	598310
0 986 424 487	598726
0 986 424 488	598305
	598475
0 986 424 489	598806
	601002
0 986 424 490	598057
	598450
0 986 424 492	598037
0 986 424 496	598444

	
BOSCH (.../...)	
0 986 424 497	598763
0 986 424 501	598486
0 986 424 502	598735
0 986 424 503	598408
0 986 424 506	598581
0 986 424 507	598880
0 986 424 508	598017
0 986 424 510	598065
0 986 424 511	598420
0 986 424 512	598316
0 986 424 514	598423
	601019
0 986 424 515	598424
0 986 424 516	598300
0 986 424 517	598448
0 986 424 518	598448
0 986 424 519	598444
0 986 424 520	598447
0 986 424 522	598583
0 986 424 523	598517
	601020
0 986 424 527	598456
0 986 424 528	598457
0 986 424 529	598462
0 986 424 531	598470
	598669
	598861
0 986 424 532	598328
0 986 424 533	598473
0 986 424 534	598737
	598917
0 986 424 535	598606
	598737
0 986 424 537	598676
0 986 424 539	598480
0 986 424 540	598479
0 986 424 541	598493
0 986 424 542	598650
	598681
0 986 424 543	598423
	601019
0 986 424 544	598605
	598607
0 986 424 545	598142
	598331
0 986 424 546	598433
0 986 424 547	598617
0 986 424 549	598453
0 986 424 551	598528
	598988
0 986 424 553	598407
0 986 424 554	598422
	598423
	598424
0 986 424 556	598429
	598430

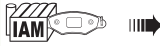
	
BOSCH (.../...)	
0 986 424 558	598564
	598639
0 986 424 559	598681
0 986 424 560	598478
0 986 424 561	598854
0 986 424 563	598497
0 986 424 564	598499
0 986 424 565	598441
0 986 424 566	598512
0 986 424 567	598129
0 986 424 568	598903
0 986 424 569	598768
0 986 424 570	598766
0 986 424 571	598464
0 986 424 572	598522
0 986 424 575	598575
0 986 424 576	598308
0 986 424 577	598309
	598772
0 986 424 578	598065
	598308
	598990
0 986 424 579	598859
	598988
0 986 424 580	598418
0 986 424 581	598416
0 986 424 582	598419
0 986 424 583	598398
0 986 424 584	598412
0 986 424 585	598544
	598965
0 986 424 586	598543
0 986 424 587	598965
0 986 424 590	598850
0 986 424 593	598041
0 986 424 594	598633
0 986 424 595	598428
0 986 424 596	598427
	598698
	598721
0 986 424 597	598426
	598670
0 986 424 598	598417
0 986 424 610	598548
0 986 424 611	598442
0 986 424 614	598537
0 986 424 616	598471
0 986 424 617	598472
	598783
	601005
	601044
0 986 424 618	598471
	598993
0 986 424 619	598566
	601012
0 986 424 626	598843

	
BOSCH (.../...)	
0 986 424 630	598577
0 986 424 632	598734
0 986 424 633	598489
0 986 424 634	598500
0 986 424 635	598501
0 986 424 636	598470
	598545
0 986 424 640	598535
	598777
0 986 424 641	598865
0 986 424 642	601024
0 986 424 643	598883
0 986 424 644	598172
	598399
0 986 424 645	598563
0 986 424 646	598584
0 986 424 648	598443
0 986 424 649	598712
0 986 424 650	598895
0 986 424 651	598410
	598898
	598413
0 986 424 652	598413
0 986 424 653	598411
0 986 424 654	598643
0 986 424 656	598906
0 986 424 657	598547
0 986 424 658	598466
0 986 424 659	598465
0 986 424 660	598461
0 986 424 661	598682
	598758
0 986 424 662	598546
0 986 424 663	598436
0 986 424 665	598677
0 986 424 666	598510
0 986 424 667	598753
0 986 424 668	598756
0 986 424 669	598534
0 986 424 670	598908
0 986 424 671	598527
0 986 424 672	598814
0 986 424 673	598807
0 986 424 674	598484
0 986 424 675	598538
0 986 424 676	598305
0 986 424 677	598678
0 986 424 679	601001
0 986 424 680	598407
0 986 424 681	598767
0 986 424 683	598434
	598438
0 986 424 684	598374
0 986 424 685	598374
0 986 424 687	598658
0 986 424 690	598992
0 986 424 691	598432

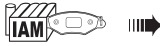
	
BOSCH (.../...)	
0 986 424 692	598579
0 986 424 693	598841
0 986 424 694	598629
0 986 424 695	598453
	598733
	598832
0 986 424 696	598511
0 986 424 697	598856
0 986 424 698	598820
0 986 424 699	598637
0 986 424 700	598530
0 986 424 701	598639
0 986 424 702	598438
0 986 424 703	598568
0 986 424 704	598570
0 986 424 705	598659
0 986 424 706	598483
	598751
0 986 424 707	598454
	598860
0 986 424 708	598813
0 986 424 709	598518
0 986 424 711	598778
0 986 424 713	598521
0 986 424 714	598821
0 986 424 715	598452
0 986 424 716	598886
0 986 424 717	598520
0 986 424 719	598536
0 986 424 720	598784
0 986 424 721	598514
0 986 424 722	598887
0 986 424 723	598805
0 986 424 726	598821
0 986 424 727	598504
	598574
0 986 424 729	598505
	598759
	598871
0 986 424 732	598697
0 986 424 734	598449
0 986 424 735	598679
0 986 424 738	598468
0 986 424 739	598656
0 986 424 740	598655
0 986 424 741	598770
	598967
0 986 424 743	598808
0 986 424 745	598035
0 986 424 747	598482
0 986 424 748	598482
0 986 424 750	541705
0 986 424 751	598463
	598474
0 986 424 756	598425
0 986 424 757	598902

	
BOSCH (.../...)	
0 986 424 758	598632
0 986 424 760	598661
0 986 424 761	598541
0 986 424 762	598542
0 986 424 764	598410
0 986 424 765	598415
0 986 424 766	598754
	598885
0 986 424 767	598231
	598412
	598811
0 986 424 768	598586
0 986 424 769	598569
0 986 424 770	598915
0 986 424 771	598682
	598911
0 986 424 774	598557
0 986 424 775	601029
0 986 424 777	598565
0 986 424 779	598750
0 986 424 780	598801
0 986 424 781	598450
0 986 424 782	598835
0 986 424 784	598670
	598913
0 986 424 785	598558
0 986 424 786	598696
0 986 424 787	598638
0 986 424 788	598736
0 986 424 789	598553
0 986 424 790	598680
0 986 424 791	598451
0 986 424 792	598761
0 986 424 793	598761
0 986 424 794	598649
0 986 424 795	598641
	598847
0 986 424 796	598752
	601004
0 986 424 797	598635
0 986 424 798	598812
0 986 424 799	598809
0 986 424 800	598642
0 986 424 801	598462
0 986 424 803	598737
	598917
0 986 424 804	598991
0 986 424 806	598779
	598845
0 986 424 808	598827
0 986 424 809	598757
0 986 424 810	598574
	598781
0 986 424 811	598842
0 986 424 812	598820
0 986 424 813	598674







Valeo	
BOSCH (.../...)	
0 986 424 814	598852
0 986 424 815	598744
0 986 424 817	598780
0 986 424 818	598644
0 986 424 819	598699
0 986 424 820	598701
0 986 424 821	598703
0 986 424 822	598640
0 986 424 823	598833
0 986 424 824	598752
0 986 424 825	598715
0 986 424 826	598435
0 986 424 827	598762
0 986 424 828	598440
0 986 424 829	598667
0 986 424 830	598446
0 986 424 831	598665
0 986 424 832	541664
	598966
0 986 424 833	541662
	541717
0 986 460 002	598301
0 986 460 101	598099
	598187
0 986 460 111	598106
0 986 460 113	598111
	598183
	598256
0 986 460 346	598088
	598099
	598113
	598187
0 986 460 390	598293
0 986 460 736	598090
	598091
	598603
0 986 460 741	598088
0 986 460 881	598338
0 986 460 932	598374
0 986 460 935	598021
0 986 460 938	598039
	598356
0 986 460 939	598256
0 986 460 941	598025
	598048
0 986 460 942	598006
	598010
	598985
0 986 460 943	598004
	598016
0 986 460 944	598017
	598252
0 986 460 946	598086
0 986 460 947	598000
0 986 460 948	598982
0 986 460 949	598172



Valeo	
BOSCH (.../...)	
0 986 460 950	598294
0 986 460 951	598280
0 986 460 952	598018
0 986 460 953	598082
0 986 460 954	598048
0 986 460 955	598253
0 986 460 956	598029
0 986 460 957	598028
	598294
0 986 460 958	598292
0 986 460 960	598020
0 986 460 961	598257
0 986 460 962	598037
0 986 460 963	598036
0 986 460 964	598386
	598753
0 986 460 965	598617
	598621
0 986 460 966	598601
0 986 460 967	598063
	598295
0 986 460 968	601021
0 986 460 969	598034
0 986 460 970	598158
	598396
0 986 460 971	598033
	598619
	598630
0 986 460 972	598047
	598248
0 986 460 973	598135
0 986 460 974	598646
0 986 460 975	598629
0 986 460 977	598013
0 986 460 978	598597
0 986 460 979	598625
0 986 460 980	598626
0 986 460 981	598024
0 986 460 982	598382
0 986 460 983	598155
	598181
0 986 460 984	598691
	598915
0 986 460 986	598271
0 986 460 989	598015
0 986 460 991	598035
0 986 460 993	598057
0 986 460 995	598621
0 986 460 996	598291
0 986 460 997	598628
0 986 460 998	598138
	598153
	598179
0 986 461 006	598682
	598911
	601043



Valeo	
BOSCH (.../...)	
0 986 461 106	598258
0 986 461 111	598103
0 986 461 115	598230
0 986 461 117	598154
	598353
0 986 461 119	598012
0 986 461 121	598051
	598786
0 986 461 122	598014
0 986 461 123	598551
	598579
	598809
0 986 461 124	598788
0 986 461 126	598495
	598760
0 986 461 127	598051
	598052
0 986 461 129	598050
0 986 461 130	598030
	598156
0 986 461 131	598053
	598437
0 986 461 133	598618
	598851
0 986 461 136	598540
	598984
0 986 461 138	598846
0 986 461 139	598787
0 986 461 141	598274
0 986 461 142	598627
	598682
0 986 461 143	598828
0 986 461 144	598668
0 986 461 145	598519
	598834
0 986 461 146	598624
0 986 461 147	598054
0 986 461 148	598055
	598080
0 986 461 149	598158
	598396
0 986 461 396	598077
	598078
	598085
0 986 461 661	598405
0 986 461 731	598099
0 986 461 750	598023
0 986 461 752	598616
0 986 461 753	598622
0 986 461 757	598031
0 986 461 759	598494
0 986 461 760	598840
0 986 461 763	598075
	598081
	598181
0 986 461 764	598038

Valeo	
BOSCH (.../...)	
0 986 461 765	598061
0 986 461 766	598269
0 986 461 767	598312
0 986 461 768	598519
0 986 461 769	598180
	598463
	598474
0 986 461 770	598125
	598141
0 986 462 001	598337
0 986 462 072	598144
0 986 462 282	598099
0 986 462 283	598099
0 986 462 532	598193
0 986 462 803	598109
	598110
0 986 462 850	598362
0 986 462 971	598146
0 986 463 412	598110
0 986 463 473	598077
	598078
	598085
0 986 463 490	598077
	598085
0 986 463 561	598147
0 986 463 641	598129
	598391
0 986 463 736	598375
0 986 463 890	598207
0 986 463 921	598109
0 986 464 221	598165
0 986 464 361	598187
0 986 464 372	598107
0 986 464 421	598086
	598366
0 986 464 671	598107
	598187
0 986 464 681	598111
0 986 464 801	598076
0 986 464 881	598366
0 986 464 914	598168
0 986 465 111	598620
0 986 465 141	598182
0 986 465 733	598592
0 986 465 744	598205
0 986 465 745	598214
0 986 465 751	598148
	598292
0 986 465 881	598108
0 986 465 941	598150
0 986 466 311	598077
	598085
	598175
0 986 466 346	598080
0 986 466 350	598151
0 986 466 402	598166
	598212



	
BOSCH (.../...)	
0 986 466 403	598166 598334
0 986 466 601	598389
0 986 466 683	598180 598463 598474
0 986 466 693	598017
0 986 466 698	598004
0 986 466 700	598017
0 986 466 751	598103
0 986 466 871	598345
0 986 466 874	598105
0 986 467 311	598185
0 986 467 400	598221
0 986 467 411	598153
0 986 467 570	598104
0 986 467 590	598129
0 986 467 602	598612
0 986 467 720	598002 598084 598474
0 986 467 760	598091
0 986 467 841	598613
0 986 467 930	598168
0 986 468 350	541655
0 986 468 380	598095 598141 598219
0 986 468 451	598163
0 986 468 520	598921
0 986 468 570	598167
0 986 468 613	598217
0 986 468 630	598122
0 986 468 701	598266 598402
0 986 468 870	598128
0 986 468 871	598124 598128
0 986 468 873	598128
0 986 468 890	598127
0 986 469 070	598120 598335
0 986 469 080	598120
0 986 469 111	598113
0 986 469 120	598351
0 986 469 191	598061
0 986 469 390	598182
0 986 469 410	598315
0 986 469 441	598130
0 986 469 550	598220 598224
0 986 469 570	598384
0 986 469 580	598278 598296
0 986 469 761	598186
0 986 469 790	598027



	
BOSCH (.../...)	
0 986 469 810	598240
0 986 469 820	598121 598312
0 986 469 860	598075 598081 598177 598181 598338
0 986 469 960	598103 598259
0 986 490 260	598272
0 986 490 410	598239
0 986 490 440	598047
0 986 490 500	598183
0 986 490 510	598243
0 986 490 550	598241
0 986 490 640	598231 598811
0 986 490 680	598237 598269
0 986 490 800	598119 598176
0 986 490 930	598133 598134
0 986 490 990	598123
0 986 491 030	598125 598141 598142 598219 598331
0 986 491 050	598095
0 986 491 250	598964
0 986 491 260	598224
0 986 491 330	598126 598160
0 986 491 410	598032 598166
0 986 491 441	598125 598142
0 986 491 900	598182 598184
0 986 492 020	598043 598171
0 986 492 090	598179
0 986 493 340	598666
0 986 493 360	598532
0 986 493 450	598278 598296
0 986 493 480	598123 598618
0 986 493 550	598268
0 986 493 720	598266 598402
0 986 493 790	598250
0 986 494 000	598062
0 986 494 001	598636



	
BOSCH (.../...)	
0 986 494 002	598357
0 986 494 003	598067
0 986 494 004	598065 598308 598990
0 986 494 005	598488
0 986 494 006	598580
0 986 494 007	598310 598409 598640
0 986 494 008	598675
0 986 494 009	598311 598753
0 986 494 010	598330
0 986 494 011	598431
0 986 494 012	598445
0 986 494 013	598299
0 986 494 014	598926
0 986 494 015	598018
0 986 494 016	598444
0 986 494 017	598763
0 986 494 018	598486
0 986 494 019	598408
0 986 494 020	598581
0 986 494 021	598017 598484
0 986 494 022	598447
0 986 494 023	598583
0 986 494 024	598473
0 986 494 025	598650 598681
0 986 494 026	598433
0 986 494 027	598464
0 986 494 028	598412 598658
0 986 494 029	598543
0 986 494 030	598633
0 986 494 031	598537
0 986 494 032	598472 598783 601005
0 986 494 033	598471 598993
0 986 494 034	598566 601012
0 986 494 035	598489
0 986 494 036	598410 598898
0 986 494 037	598547
0 986 494 038	598465
0 986 494 039	598461
0 986 494 040	598546
0 986 494 041	598807
0 986 494 042	598484
0 986 494 043	598538
0 986 494 044	598678



	
BOSCH (.../...)	
0 986 494 046	598434 598438
0 986 494 047	598432
0 986 494 048	598568
0 986 494 049	598570
0 986 494 050	598483 598751
0 986 494 051	598482 598650
0 986 494 052	598638
0 986 494 053	598752
0 986 494 054	598665
0 986 494 055	598063 598295
0 986 494 056	598382
0 986 494 057	598258
0 986 494 058	598241
0 986 494 059	598016 598125 598142
0 986 494 061	598703
0 986 494 062	598463 598752
0 986 494 063	598643
0 986 494 064	598707
0 986 494 065	598718
0 986 494 068	598793
0 986 494 070	598426
0 986 494 071	598729
0 986 494 072	598722
0 986 494 073	598678
0 986 494 074	598698
0 986 494 075	601031
0 986 494 076	598740
0 986 494 077	598822
0 986 494 078	598647
0 986 494 079	598648
0 986 494 080	598836
0 986 494 081	598764
0 986 494 082	598765
0 986 494 085	598795
0 986 494 087	598704
0 986 494 090	598672 601009
0 986 494 092	598825
0 986 494 094	598722
0 986 494 095	598664
0 986 494 096	598700
0 986 494 097	598662
0 986 494 098	598663
0 986 494 099	598702
0 986 494 101	598896 601026
0 986 494 102	598829
0 986 494 103	598863
0 986 494 104	598779



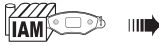



	
BOSCH (.../...)	
0 986 494 105	598720
0 986 494 107	598651
	598652
0 986 494 108	598671
0 986 494 110	598892
0 986 494 111	598891
0 986 494 113	598426
0 986 494 114	601015
0 986 494 115	598987
0 986 494 118	598640
	601027
0 986 494 119	601004
0 986 494 120	598699
0 986 494 121	598882
0 986 494 122	541728
	598876
0 986 494 123	541728
0 986 494 124	598727
0 986 494 125	598727
0 986 494 126	598727
0 986 494 127	598472
	598783
	601005
	601008
	601044
0 986 494 129	598804
0 986 494 130	601028
0 986 494 132	598427
	598913
0 986 494 133	598874
0 986 494 134	598873
0 986 494 135	598824
0 986 494 136	598803
0 986 494 138	598506
0 986 494 139	598868
0 986 494 141	598439
0 986 494 143	598654
0 986 494 144	598910
0 986 494 145	598706
0 986 494 146	598705
	598910
0 986 494 147	598741
0 986 494 148	598742
0 986 494 150	598524
0 986 494 151	598738
0 986 494 152	598889
0 986 494 153	598857
0 986 494 154	598819
0 986 494 155	598575
	598708
0 986 494 157	598825
	598839
0 986 494 158	601030
0 986 494 159	598657
0 986 494 160	598847
0 986 494 162	601051



	
BOSCH (.../...)	
0 986 494 163	598899
0 986 494 164	598940
0 986 494 165	598728
0 986 494 166	601034
0 986 494 167	598995
0 986 494 168	598925
0 986 494 169	598879
0 986 494 170	598816
0 986 494 171	541736
0 986 494 174	601037
0 986 494 175	598928
0 986 494 192	601039
0 986 494 194	598881
0 986 494 196	601052
0 986 494 197	601017
0 986 494 222	598722
0 986 494 261	598927
0 986 505 097	598910
0 986 505 402	598862
0 986 524 438	598903
0 986 524 444	598391
0 986 AB1 201	598634
0 986 AB1 202	598051
0 986 AB1 203	598908
0 986 AB1 222	598506
0 986 AB1 224	598361
0 986 AB1 233	598708
0 986 AB1 241	598316
0 986 AB1 255	598874
0 986 AB1 264	598511
0 986 AB1 266	598937
0 986 AB1 268	598870
0 986 AB1 270	598361
0 986 AB2 027	598393
0 986 AB2 031	598815
0 986 AB2 041	598540
0 986 AB2 061	598496
0 986 AB2 082	598984
0 986 AB2 084	601025
0 986 AB2 085	598827
0 986 AB2 089	598542
0 986 AB2 090	598577
0 986 AB2 093	598737
0 986 AB2 096	598857
0 986 AB2 102	598844
0 986 AB2 104	598520
0 986 AB2 106	598886
0 986 AB2 109	598853
0 986 AB2 110	598476
0 986 AB2 111	598907
0 986 AB2 115	598733
	598832
0 986 AB2 116	598921
0 986 AB2 119	598402
	598614
0 986 AB2 123	598809



	
BOSCH (.../...)	
0 986 AB2 125	598535
0 986 AB2 126	598865
0 986 AB2 127	598536
0 986 AB2 130	598888
0 986 AB2 135	601052
0 986 AB2 136	598933
0 986 AB2 137	598890
0 986 AB2 138	598819
0 986 AB2 141	598449
0 986 AB2 145	598524
0 986 AB2 160	598745
0 986 AB2 168	598929
0 986 AB2 169	598053
0 986 AB2 171	598788
0 986 AB2 173	598757
0 986 AB2 176	598760
0 986 AB2 178	598848
0 986 AB2 217	601002
0 986 AB2 219	598787
0 986 AB2 224	598628
0 986 AB2 226	598786
0 986 AB2 238	598618
0 986 AB2 245	598296
0 986 AB2 250	598452
0 986 AB2 308	598834
0 986 AB2 313	598519
0 986 AB2 330	598521
0 986 AB2 460	598646
0 986 AB2 462	598290
0 986 AB2 463	598629
0 986 AB2 555	598850
0 986 AB2 561	598856
0 986 AB2 563	598883
0 986 AB2 609	598915
0 986 AB2 651	598047
0 986 AB2 658	598248
0 986 AB2 663	598682
0 986 AB2 664	598047
0 986 AB2 666	598760
0 986 AB2 675	598682
	598911
0 986 AB2 751	598021
0 986 AB2 758	598830
	598986
0 986 AB2 760	598023
0 986 AB2 761	598533
	598534
0 986 AB2 764	598830
0 986 AB2 765	598534
0 986 AB2 766	598843
0 986 AB3 802	598408
0 986 AB3 803	598463
0 986 AB3 805	598252
0 986 AB3 808	598464
0 986 AB3 811	598682
0 986 AB3 834	598917

	
BOSCH (.../...)	
0 986 AB3 838	598668
0 986 AB3 839	598393
0 986 AB3 840	598777
0 986 AB3 841	598535
0 986 AB3 842	598865
0 986 AB3 862	598523
0 986 AB4 026	598921
0 986 AB4 034	598614
0 986 AB4 036	598122
0 986 AB4 121	598984
0 986 AB4 150	598777
0 986 AB4 166	598184
	598356
0 986 AB4 189	598356
0 986 AB4 275	598834
0 986 AB4 278	598449
0 986 AB4 279	598625
0 986 AB4 292	598912
0 986 AB4 297	598305
0 986 BB0 056	598112
0 986 BB0 161	598142
0 986 BB0 173	598838
0986424728	598748
0986424805	598719
0986424816	598755
0986AB2004	598266
	598579
0986AB2022	598897
0986AB2026	598947
0986AB2028	598777
0986AB2044	601023
0986AB2050	598393
0986AB2054	601022
0986AB2058	598393
	598897
0986AB2059	598496
0986AB2207	598123
0986AB2210	598384
0986AB2213	598123
	598618
0986AB2221	598916
0986AB2222	598668
0986AB2309	598517
	601020
0986AB2311	598625
0986AB2322	598522
0986AB2328	598517
0986AB2455	598250
0986AB2456	598846
0986AB2458	598780
0986AB2461	598274
0986AB2476	598515
0986AB2565	601024
0986AB2602	598476
	598691
0986AB2603	598691

	
BOSCH (.../...)	
0986AB2604	598828
0986AB2608	598530
0986AB2610	598895
0986AB2662	598627
0986AB2665	598494
0986AB3806	598155
OF026000014	598018
OF026000071	598454
OF026000079	598737
	598917
OF026000120	598053
	598437
F 005 X10 237	598050
F 01G 09G 03Y	598710
F 026 000 000	598040
F 026 000 001	598065
	598308
	598990
F 026 000 002	598488
F 026 000 003	598675
F 026 000 004	598038
	598074
F 026 000 005	598403
F 026 000 006	598074
F 026 000 007	598212
F 026 000 008	598018
F 026 000 009	598753
F 026 000 010	598172
	598399
F 026 000 011	598563
F 026 000 012	598039
	598356
F 026 000 013	598025
	598048
F 026 000 014	598018
F 026 000 015	598258
F 026 000 016	598166
	598212
F 026 000 017	598124
	598128
F 026 000 018	598128
F 026 000 019	598127
F 026 000 020	598315
F 026 000 022	598011
	598012
F 026 000 023	598156
	598360
F 026 000 024	598319
F 026 000 025	598461
F 026 000 026	598549
F 026 000 027	598926
F 026 000 028	598457
F 026 000 029	598650
	598681
F 026 000 030	598584
F 026 000 031	598090
	598603

	
BOSCH (.../...)	
F 026 000 032	598338
F 026 000 035	598035
F 026 000 036	598012
F 026 000 037	598158
	598396
F 026 000 038	598077
	598085
F 026 000 039	598148
	598292
F 026 000 041	598002
	598084
F 026 000 042	598091
F 026 000 043	598182
F 026 000 044	598075
	598081
	598177
	598181
	598338
F 026 000 045	598243
F 026 000 046	598241
F 026 000 047	598141
	598142
	598331
F 026 000 048	598067
F 026 000 049	598317
F 026 000 050	598355
F 026 000 051	598070
F 026 000 052	598064
F 026 000 053	598254
F 026 000 054	598116
F 026 000 055	598091
F 026 000 056	598052
	598817
F 026 000 057	598022
F 026 000 058	598069
	598467
F 026 000 060	598019
F 026 000 061	598066
F 026 000 063	598332
F 026 000 064	598318
F 026 000 065	598217
F 026 000 066	598326
F 026 000 067	598073
F 026 000 068	598043
	598171
F 026 000 070	598322
F 026 000 071	598454
F 026 000 072	598303
F 026 000 073	598330
F 026 000 074	598763
F 026 000 075	598017
F 026 000 076	598456
F 026 000 078	598473
F 026 000 081	598676
	598858
F 026 000 082	598480

	
BOSCH (.../...)	
F 026 000 083	598479
	601030
F 026 000 084	598493
F 026 000 085	598605
	598607
F 026 000 086	598564
F 026 000 087	598577
F 026 000 088	598305
F 026 000 092	598256
F 026 000 093	598004
	598016
F 026 000 094	598017
	598252
F 026 000 095	598982
F 026 000 096	598172
F 026 000 097	598082
F 026 000 098	598048
F 026 000 099	598253
F 026 000 100	598292
F 026 000 102	598037
F 026 000 103	598036
F 026 000 104	598034
F 026 000 105	598396
F 026 000 106	598033
	598619
	598630
F 026 000 107	598013
F 026 000 108	598626
F 026 000 111	598057
F 026 000 112	598621
F 026 000 113	598291
F 026 000 114	598682
	598911
F 026 000 116	598154
	598353
F 026 000 117	598014
F 026 000 118	598551
	598809
F 026 000 119	598030
	598156
F 026 000 120	598053
	598437
F 026 000 122	598274
F 026 000 123	598627
	598682
F 026 000 124	598668
F 026 000 125	598055
	598080
F 026 000 126	598077
	598078
	598085
F 026 000 127	598616
F 026 000 128	598622
F 026 000 129	598031
F 026 000 130	598075
	598081
	598181

	
BOSCH (.../...)	
F 026 000 131	598038
F 026 000 132	598061
F 026 000 133	598180
	598463
F 026 000 135	598099
F 026 000 136	598182
F 026 000 137	598205
F 026 000 139	598080
F 026 000 140	598151
F 026 000 141	598166
F 026 000 142	598180
F 026 000 143	598017
F 026 000 144	598017
F 026 000 145	598345
F 026 000 146	598105
F 026 000 147	598221
F 026 000 148	598095
	598141
	598219
F 026 000 149	598167
F 026 000 150	598266
	598402
F 026 000 151	598128
F 026 000 152	598120
	598335
F 026 000 153	598384
F 026 000 154	598240
F 026 000 155	598183
F 026 000 156	598119
	598176
F 026 000 157	598123
F 026 000 158	598095
F 026 000 159	598125
	598142
F 026 000 161	598182
	598184
F 026 000 162	598043
	598171
F 026 000 163	598179
F 026 000 164	598666
BREMBO	
P 06 001	598099
	598187
P 06 002	598107
P 06 003	598107
P 06 004	598187
P 06 005	598107
	598187
P 06 006	598108
P 06 008	598104
P 06 009	598103
P 06 011	598103
	598259
P 06 012	598231

BREMBO (.../...)	
P 06 013	598386
P 06 014	598018
P 06 016	598103
P 06 017	598013
P 06 019	598712
P 06 020	598580
P 06 021	598412
P 06 022	598310 598409
P 06 023	598311
P 06 024	598018
P 06 025	598753
P 06 026	598820
P 06 027	598643
P 06 029	598411
P 06 030	598413
P 06 031	598410
P 06 032	598643
P 06 033	598754
P 06 034	598699
P 06 035	598700
P 06 036	598640
P 06 037	598701
P 06 038	598703
P 06 039	598885
P 10 001	598874
P 11 007	598600
P 11 008	598556
P 11 010	598965
P 11 011	598904
P 11 012	598543
P 11 014	598755
P 11 015	598415
P 15 002	598361
P 15 003	598528 598988
P 15 004	598854
P 15 005	598902
P 15 006	598316
P 16 006	601024
P 16 007	598850
P 16 008	598856
P 16 009	598883
P 23 001	598111 598183 598256
P 23 002	598088
P 23 003	598090 598603
P 23 005	598090
P 23 007	598090
P 23 008	598094
P 23 010	598145
P 23 012	598113
P 23 013	598091
P 23 014	598141

BREMBO (.../...)	
P 23 015	598094
P 23 017	598093 598095 598141 598219
P 23 018	598093 598531
P 23 019	598093 598133
P 23 020	598351
P 23 021	598091
P 23 022	598153
P 23 023	598138
P 23 024	598091 598093
P 23 025	598371
P 23 026	598142 598331
P 23 027	598130
P 23 028	598093 598168
P 23 029	598160
P 23 030	598130
P 23 031	598126 598160
P 23 032	598141
P 23 033	598115
P 23 034	598133 598134 598135
P 23 035	598289
P 23 036	598010
P 23 038	598108
P 23 039	598271
P 23 040	598271
P 23 041	598006
P 23 042	598003
P 23 043	598010
P 23 044	598095
P 23 045	598135
P 23 047	598135
P 23 048	598000 598005
P 23 052	598859
P 23 054	601021
P 23 055	598271
P 23 056	601019
P 23 057	598040
P 23 058	598065 598308
P 23 060	598011 598987
P 23 061	598064
P 23 062	598502
P 23 063	598424
P 23 064	598425

BREMBO (.../...)	
P 23 065	598407
P 23 066	598010 598985
P 23 067	598581
P 23 068	598070
P 23 069	598800
P 23 070	598041 601003
P 23 071	598040 598065
P 23 072	598073
P 23 073	598607
P 23 074	598988
P 23 075	598880
P 23 076	598424 598308 598990
P 23 077	598065
P 23 078	598772
P 23 079	598422 598424
P 23 080	598633
P 23 081	601003
P 23 082	598468
P 23 083	598429 598430
P 23 084	598429 598430
P 23 085	598426 598670
P 23 086	598428
P 23 087	598427 598721
P 23 088	601001
P 23 089	601029
P 23 090	598553
P 23 091	598568
P 23 092	598569
P 23 093	598570
P 23 094	598761
P 23 095	598761
P 23 096	598012
P 23 097	598696
P 23 098	598772
P 23 099	598913
P 23 100	598793
P 23 101	598727
P 23 102	598727
P 23 103	598729
P 23 104	598722
P 23 105	598804
P 23 106	598987
P 23 107	601015
P 23 108	598426 598913
P 23 109	601029

BREMBO (.../...)	
P 23 110	598772
P 23 111	601029
P 24 002	598168
P 24 004	598129 598391
P 24 006	598166 598212
P 24 007	598120
P 24 009	598165
P 24 010	598168
P 24 011	598168
P 24 012	598166 598334
P 24 013	598217
P 24 014	598169
P 24 015	598121
P 24 016	598167
P 24 018	598240
P 24 019	598120 598335
P 24 020	598120
P 24 021	598121 598312
P 24 023	598032
P 24 024	598250
P 24 025	598846
P 24 026	598123 598618
P 24 028	598043 598171
P 24 029	598172
P 24 032	598036
P 24 033	598037
P 24 034	598033
P 24 035	598630
P 24 036	598290
P 24 037	598034
P 24 039	598602
P 24 043	598212
P 24 044	598043 598171
P 24 045	598399
P 24 046	598317
P 24 047	598431
P 24 048	598644
P 24 049	598036
P 24 050	598037
P 24 051	598784
P 24 052	598432
P 24 053	598547
P 24 054	598563
P 24 055	598564
P 24 057	598822
P 24 058	598639
P 24 059	598434
P 24 060	598433

Valeo	
BREMBO (.../...)	
P 24 061	598649
P 24 062	601005
P 24 063	598740
P 24 064	598816
P 24 065	598818
P 24 066	541736
P 24 067	598472
	601044
P 28 003	598208
P 28 004	598131
P 28 006	598047
P 28 008	598047
P 28 009	598131
P 28 011	598053
	598437
P 28 013	598227
P 28 014	598227
P 28 016	598248
P 28 017	598053
P 28 019	598019
P 28 020	598022
P 28 021	598056
P 28 022	598682
	598911
P 28 023	598494
P 28 024	598495
	598760
P 28 025	598437
P 28 026	598627
P 28 027	598903
P 28 028	598627
P 28 029	598436
	598451
P 28 030	598682
	598758
P 28 031	598435
P 28 032	598907
P 28 034	598887
P 28 035	598757
P 28 036	598824
P 28 037	598803
P 28 038	598849
P 28 039	598682
P 30 001	598052
P 30 002	598051
	598786
P 30 003	598817
P 30 005	598634
P 30 006	598838
P 30 008	598841
P 30 009	598989
P 30 010	598908
P 30 011	598575
P 30 012	598821
P 30 013	598505
	598759

Valeo	
BREMBO (.../...)	
P 30 014	598748
P 30 015	598511
P 30 016	598910
P 30 017	598506
P 30 018	598744
P 30 019	598654
P 30 020	598781
P 30 022	598051
	598574
	598786
P 30 023	598823
P 34 002	598615
P 36 002	598374
P 36 003	598374
P 36 007	598440
P 36 008	598039
P 36 012	598439
P 36 013	598438
P 36 015	598438
P 36 016	598439
P 37 001	598595
P 37 004	598491
P 37 005	598510
P 37 007	598414
P 37 008	598833
P 37 009	598755
P 41 001	598405
P 41 002	598389
P 41 003	598406
P 41 004	598406
P 44 001	598497
P 44 003	598497
P 44 004	598498
P 44 005	598623
P 44 007	598762
P 44 008	598441
P 44 009	598499
P 44 010	598512
P 44 011	598514
P 44 012	598658
P 44 013	598742
P 44 014	598741
P 49 003	598612
P 49 004	598239
P 49 006	598293
P 49 007	598293
P 49 011	598646
P 49 013	598268
P 49 015	598624
P 49 016	598274
P 49 018	598629
P 49 020	598836
P 49 021	598835
P 49 023	598250
	598629
P 49 024	598515

Valeo	
BREMBO (.../...)	
P 49 025	598516
P 49 026	598647
	598648
P 49 027	598548
P 49 028	598515
P 49 029	598745
P 49 035	598831
P 50 002	598109
P 50 003	598613
P 50 004	598110
P 50 007	598105
P 50 008	598315
P 50 009	598272
P 50 010	598601
P 50 011	598241
P 50 013	598345
P 50 015	598000
P 50 017	598617
P 50 019	598046
P 50 020	598300
P 50 021	598000
P 50 023	598357
P 50 024	598763
P 50 025	598444
P 50 026	598636
P 50 027	598045
P 50 028	541664
P 50 029	598044
P 50 030	598062
P 50 031	598299
P 50 032	598301
P 50 033	598447
P 50 035	598549
P 50 036	598549
P 50 038	598329
P 50 039	598442
P 50 040	598443
P 50 041	598445
P 50 042	598446
P 50 043	598719
P 50 044	598813
P 50 045	598448
P 50 046	598448
P 50 047	598582
P 50 049	598638
P 50 050	598764
P 50 051	598765
P 50 052	598637
P 50 053	598659
P 50 054	598704
P 50 055	598318
P 50 056	598704
P 50 057	598795
P 50 058	598583
P 50 059	598881
P 50 060	598876

Valeo	
BREMBO (.../...)	
P 50 063	598728
P 50 064	598802
P 52 002	598392
P 52 008	598116
P 52 011	598118
P 52 015	598254
P 52 017	598632
P 54 002	598620
P 54 004	598620
P 54 006	598220
P 54 008	598597
P 54 009	598224
P 54 010	598964
P 54 012	598519
	598834
P 54 014	598625
P 54 015	598626
P 54 016	598844
P 54 017	598517
	601020
P 54 018	598519
P 54 020	598522
P 54 021	598320
P 54 022	598318
P 54 023	598319
P 54 024	598589
P 54 026	598778
P 54 028	598521
P 54 029	598518
P 54 030	598886
P 54 031	598520
	598852
P 54 032	598523
P 54 033	598855
P 56 004	598123
	598379
P 56 005	598817
P 56 011	598278
P 56 013	598384
P 56 014	598112
	598123
P 56 015	598122
P 56 016	598296
P 56 018	598296
P 56 019	598112
P 56 020	598851
P 56 021	598787
P 56 022	598054
P 56 023	598024
P 56 024	598057
P 56 027	598628
P 56 029	598668
P 56 031	598014
P 56 032	598642
P 56 033	598071
P 56 034	598476







Valeo	
BREMBO (.../...)	
P 56 035	598449
P 56 036	598450
P 56 038	598726
P 56 039	598806
	601002
P 56 040	598452
P 56 041	598524
P 56 042	541733
P 56 044	598451
P 56 045	598912
P 56 046	598672
	601009
P 56 048	598914
P 56 049	598889
P 59 001	598099
	598113
	598187
	598270
P 59 002	598017
	598111
P 59 003	598115
P 59 004	598108
P 59 005	598182
P 59 007	598185
P 59 009	598186
P 59 010	598243
P 59 011	598039
	598356
P 59 013	598184
	598356
P 59 014	598183
P 59 015	598020
P 59 016	598256
P 59 017	598184
P 59 018	598183
	598253
P 59 019	598050
P 59 020	598460
P 59 021	598507
P 59 022	598305
P 59 023	598183
P 59 024	598183
	598187
P 59 027	598459
P 59 028	598458
P 59 029	598305
	598475
P 59 030	598322
P 59 031	598926
P 59 032	598454
P 59 033	598661
P 59 035	598453
P 59 036	598456
P 59 037	598457
P 59 038	598584
P 59 039	598537



Valeo	
BREMBO (.../...)	
P 59 040	598538
P 59 041	598546
P 59 042	598472
	598678
	598783
	601005
	601008
	601044
P 59 043	598678
P 59 044	598472
	598783
P 59 045	598860
P 59 046	598808
P 59 047	598722
P 61 002	598144
P 61 003	598362
P 61 004	598174
P 61 005	598193
P 61 006	598077
	598078
	598085
P 61 007	598150
P 61 008	598363
P 61 009	598077
	598375
P 61 010	598146
P 61 011	598593
	598594
P 61 012	598147
P 61 013	598113
P 61 014	598364
P 61 015	598148
P 61 016	598161
	598193
	598338
P 61 017	598178
	598193
P 61 018	598375
P 61 019	598207
P 61 020	598081
P 61 021	598375
P 61 022	598149
P 61 024	598163
P 61 026	598162
P 61 027	598375
P 61 028	598081
P 61 029	598151
P 61 030	598084
	598119
	598176
	598181
P 61 031	598119
	598176
	598714
P 61 032	598396
P 61 033	598593
	598594



Valeo	
BREMBO (.../...)	
P 61 034	598030
	598156
P 61 035	598179
P 61 036	598029
P 61 037	598292
P 61 038	598295
P 61 039	598294
P 61 041	598714
P 61 042	598155
	598181
P 61 043	598154
P 61 044	598075
	598081
	598155
	598181
P 61 045	598075
P 61 046	598028
	598294
P 61 047	598156
P 61 048	598280
P 61 049	598281
P 61 050	598353
P 61 051	598038
	598074
P 61 052	598031
P 61 053	598383
P 61 054	598038
P 61 055	598385
P 61 056	598068
P 61 057	598069
	598467
P 61 058	598063
P 61 059	598156
	598360
P 61 060	598326
P 61 061	598420
P 61 062	598148
	598292
P 61 063	598461
P 61 064	598466
P 61 065	598462
P 61 066	598464
P 61 067	598462
P 61 068	598465
P 61 069	598398
P 61 070	598417
P 61 071	598419
P 61 072	598416
P 61 073	598418
P 61 074	598500
P 61 075	598501
P 61 076	598715
P 61 077	598662
P 61 078	598663
P 61 079	598664
P 61 080	598702

Valeo	
BREMBO (.../...)	
P 61 081	598718
P 65 001	598111
P 65 007	598766
P 65 008	598768
P 65 009	598767
P 68 001	598077
	598085
P 68 002	598085
P 68 003	598377
P 68 004	598077
	598078
	598085
P 68 005	598076
	598377
P 68 006	598086
P 68 007	598366
P 68 008	598002
	598084
P 68 010	598002
	598075
	598081
	598177
	598181
	598338
P 68 011	598077
	598085
	598175
P 68 012	598374
P 68 013	598086
P 68 014	598061
P 68 015	598080
P 68 016	598082
P 68 017	598055
	598080
	598396
P 68 018	598158
P 68 019	598382
P 68 020	598080
P 68 021	598328
P 68 022	598599
P 68 023	598470
P 68 024	598180
	598474
P 68 025	598490
P 68 026	598669
P 68 027	598473
P 68 028	598527
P 68 029	598566
	601012
P 68 030	598471
P 68 031	598557
P 68 032	598471
P 68 033	598641
P 68 034	598558
P 68 035	598180
P 68 036	598861



 	
BREMBO (.../...)	
P 68 037	598002
P 71 003	598291
P 71 004	598237
	598269
P 71 005	598269
P 78 004	598691
P 78 005	598828
P 78 007	598476
	598691
P 78 009	598915
P 78 010	598530
P 78 011	598895
P 78 012	598991
P 78 013	598853
P 78 014	598875
P 79 001	598021
P 79 004	598986
P 79 005	598666
P 79 006	598023
P 79 007	598531
P 79 008	598533
P 79 009	598534
P 79 010	598830
P 79 011	598843
P 79 012	598733
	598832
P 79 013	598697
P 79 014	598848
P 79 015	598453
P 83 006	598921
P 83 009	598393
	598897
P 83 011	598266
	598402
	598579
P 83 013	598402
	598614
	598947
P 83 015	598540
	598984
P 83 016	598266
P 83 019	598983
P 83 022	598815
P 83 024	598777
P 83 025	598393
P 83 028	598809
P 83 029	598496
P 83 033	598809
P 83 034	598551
	598579
	598809
	598809
P 83 037	601023
P 83 038	601022
P 83 041	598478
P 83 043	598653
P 83 044	598579



 	
BREMBO (.../...)	
P 83 045	601025
P 83 046	598665
P 83 047	598812
P 83 048	598535
P 83 049	598865
P 83 050	598606
P 83 051	598737
	598917
P 83 052	598577
	598737
P 83 053	598736
P 83 054	598827
P 83 055	598536
P 83 056	598542
P 83 057	598673
P 83 058	598944
P 83 061	598541
P 83 062	598862
P 83 064	598679
P 83 065	598680
P 83 066	598857
P 83 070	598710
P 85 001	601016
P 85 002	598106
P 85 003	598099
P 85 004	598099
	598106
	598109
P 85 005	598124
	598128
P 85 007	598109
	598110
P 85 008	598027
P 85 009	598375
P 85 010	598124
	598128
	598205
P 85 011	598017
	598252
P 85 012	598128
P 85 013	598125
	598142
P 85 014	598214
P 85 015	598016
P 85 016	598017
P 85 017	598180
	598463
	598474
P 85 018	598230
P 85 019	598127
P 85 020	598180
	598463
P 85 022	598217
P 85 024	598258
P 85 025	598488
P 85 027	598048



 	
BREMBO (.../...)	
P 85 028	598025
	598048
P 85 029	598622
P 85 030	598066
P 85 031	598403
P 85 032	598330
P 85 034	598982
P 85 035	598303
P 85 036	598355
P 85 037	598483
	598751
P 85 039	598067
P 85 041	598332
P 85 042	598017
P 85 043	598408
P 85 044	598484
P 85 045	598486
P 85 046	598482
	598650
P 85 047	598675
P 85 048	598807
P 85 049	598676
P 85 050	598814
P 85 051	598483
	598751
P 85 052	598858
P 85 055	598735
P 85 056	598750
P 85 057	598667
P 85 058	598674
	598681
P 85 059	598650
	598681
P 85 060	598489
P 85 061	598565
P 85 062	598801
P 85 063	598734
P 85 065	598656
P 85 066	598674
P 85 068	598967
P 85 069	598655
P 85 070	598770
P 85 071	598805
P 85 072	598408
P 85 073	598752
P 85 074	598463
P 85 075	598635
P 85 076	601004
P 85 077	598720
P 85 079	598863
P 85 081	598651
P 85 082	598652
P 85 083	598671
P 85 084	598779
P 85 085	598483
	598751



 	
BREMBO (.../...)	
P 85 086	598484
	598751
P 85 087	598845
P 85 088	598770
P 85 089	598180
	598463
P 85 090	598940
P 85 091	598946
P 86 001	598161
	598270
	598338
P 86 002	598270
P 86 003	598337
P 86 005	598221
P 86 006	598257
P 86 007	598695
P 86 009	598621
P 86 010	598015
P 86 011	598102
P 86 013	598616
P 86 014	598480
P 86 015	598481
P 86 016	598479
P 86 017	598493
P 86 018	598657
P 86 019	598829
P A6 001	598129
P A6 002	598369
P A6 003	598007
P A6 004	598129
P A6 005	598369
P A6 006	598380
	598391
P A6 007	541641
P A6 009	598007
	598139
	598374
P A6 010	598132
P A6 012	598596
P A6 013	540436
P A6 014	598586
	598598
P A6 019	598586
P A6 020	598585
P A6 021	541717
P A6 022	541663
P A6 023	541705
DELPHI	
LP0010	598392
LP0015	598338
LP0017	598374
LP0018	598099
	598270
LP0020	598111







 	
DELPHI (.../...)	
LP0021	598099
LP0029	598088
LP0039	598337
LP0041	598129
LP0045	598391
LP0054	598085
LP0061	598106
LP0076	598099
LP0087	598108
LP0089	598375
LP0092	598405
LP0099	598077
	598078
	598085
LP0106	598174
LP0107	598193
LP0108	598178
LP0110	598165
LP0113	598145
LP0132	598374
LP0133	598374
LP0145	598375
LP0146	598085
LP0154	598168
LP0156	598113
LP0160	598174
	598375
LP0161	598108
LP0168	598377
LP0170	598076
LP0171	598081
LP0172	598592
LP0175	598175
LP0177	598150
LP0179	598205
LP0189	598389
LP0193	598207
LP0199	598614
LP0208	598185
LP0213	598132
LP0219	598379
LP0221	598110
LP0226	598161
LP0232	598162
LP0248	598002
	598084
LP0250	598217
LP0253	598090
	598603
LP0254	598118
LP0255	598120
	598166
	598212
LP0261	598278
LP0275	598219
LP0306	598163



 	
DELPHI (.../...)	
LP0351	598167
LP0353	598091
LP0358	598123
LP0373	598122
LP0378	598153
LP0419	598160
LP0421	598128
LP0422	598363
LP0424	598004
LP0436	598093
	598531
LP0444	598017
LP0448	598921
LP0451	598125
LP0456	598133
LP0459	598095
	598133
	598219
LP0460	598266
LP0463	598371
LP0464	598141
LP0465	598239
LP0471	598391
LP0472	598132
LP0475	598497
LP0479	598129
LP0490	598081
LP0491	598080
LP0500	598375
LP0501	598007
LP0505	598127
LP0519	598131
LP0522	598142
LP0523	598141
LP0531	598293
LP0542	598061
LP0557	598240
LP0559	598227
LP0564	598179
LP0565	598180
LP0566	598095
LP0573	598291
LP0576	598291
LP0581	598182
LP0583	598369
LP0585	598039
LP0586	598253
LP0588	598593
LP0590	598183
	598243
LP0594	598138
LP0595	598239
LP0598	598010
LP0602	598231
LP0604	598271
LP0606	598051
	598574



 	
DELPHI (.../...)	
	598786
LP0608	598613
LP0613	598266
LP0616	598054
LP0617	598057
LP0620	598268
LP0625	598053
LP0629	598020
LP0637	598621
LP0639	598015
LP0654	598029
LP0655	598292
LP0667	598295
LP0670	598024
	598628
LP0671	598296
LP0677	598271
LP0696	598081
	598155
	598181
LP0699	598396
LP0702	598039
	598184
	598356
LP0703	598156
LP0707	598123
LP0723	598366
LP0724	598086
LP0743	598274
	598646
LP0766	598036
LP0767	598037
LP0769	598982
LP0771	601021
LP0781	598033
	598034
LP0784	598067
LP0787	598031
LP0788	598061
LP0789	598551
LP0792	598383
LP0793	598074
LP0801	598629
LP0822	598382
LP0823	598714
LP0836	598158
	598396
LP0839	598616
LP0841	598617
LP0851	598011
	598012
LP0868	598240
LP0877	598070
LP0878	598800
LP0881	598013
LP0906	598281

 	
DELPHI (.../...)	
LP0917	598353
LP0919	598695
LP0946	598272
LP0948	598682
LP0975	598668
LP0980	598044
LP0985	598068
LP0986	598069
LP0991	598063
LP0993	598318
LP10	598392
LP100	598144
LP1002	598712
LP1003	598412
LP1006	598041
LP1007	598065
LP1008	598357
LP1009	598636
LP1010	598625
LP1011	598071
LP1012	598449
LP1013	598523
LP1014	598830
LP1015	598534
LP1016	598066
LP1018	598581
LP1019	598482
	598546
LP1020	598476
LP1021	598511
	598838
LP1022	598073
LP1023	598319
LP1027	598095
LP1043	598062
LP1045	598046
LP1046	541664
	598966
LP1051	598360
LP1053	598075
	598081
LP1058	598912
LP106	598111
	598174
	598193
LP1064	598850
LP1066	598646
LP1067	598630
LP1069	598305
LP107	598193
LP1070	598393
LP1072	598817
LP1073	598817
LP1074	598836
LP1076	598629
LP1077	598488



	
DELPHI (.../...)	
LP1079	598619
LP108	598178
LP1081	598043
	598171
LP1082	598212
LP1083	598184
LP1085	598326
LP1092	598675
LP1095	598515
LP110	598165
LP1100	598666
LP1104	598332
	598408
LP1105	598086
LP1107	598311
LP1113	598420
LP1115	598069
LP1116	598466
LP1117	598602
LP1118	598396
LP1124	598449
LP1126	598817
LP1127	598470
LP1128	598055
LP113	598145
LP1133	598726
LP1136	598490
LP1139	598172
	598399
LP114	598147
LP1141	601024
LP1143	598580
LP1145	598528
LP1159	598965
LP1161	598904
LP1162	598965
LP1166	598556
LP117	598109
	598110
LP1189	598516
LP1206	598048
LP1228	598786
LP1230	598187
LP1231	598478
LP1249	598403
LP1252	598328
LP127	598146
LP1299	598442
LP1301	598768
LP1302	598579
LP1304	598361
LP1305	598524
LP1307	598926
LP1308	598535
LP1309	598322
	598454
	598860



	
DELPHI (.../...)	
LP131	598237
LP1315	598317
LP1316	598431
LP132	598374
LP133	598374
LP1385	598605
	601003
LP1390	598316
LP1397	598040
LP1398	598493
LP1399	598614
LP1400	598985
LP1401	598549
	598582
LP1402	598763
LP1403	598444
LP1404	598065
	598880
LP1405	598393
LP1406	598490
LP1407	598067
	598355
LP1408	598308
	598880
LP1409	598330
LP1410	598017
LP1411	598766
LP1412	598330
	598982
LP1413	598065
LP1414	598606
LP1415	598423
	601019
LP1416	598424
LP1417	598036
LP1418	598037
LP1420	598854
LP1421	598018
LP1422	598309
	598772
LP1423	598018
	598753
LP1424	598902
LP1425	598299
LP1426	598207
LP1429	598217
LP1434	598908
LP1435	598450
LP1436	598332
LP1437	598300
LP1438	598865
LP1439	598843
LP1440	598548
LP1441	598183
LP1442	598453
	598733
	598832



	
DELPHI (.../...)	
LP1443	598481
LP1444	598219
LP1448	598521
LP145	598077
	598375
LP1450	598512
LP1452	598835
LP1453	598061
LP1454	598230
LP1455	598482
LP1456	598437
LP1457	598466
LP1458	598479
	601030
LP146	598077
	598085
	598153
LP1461	598496
LP1462	598518
	598520
LP1468	598439
LP1469	598564
LP1470	598563
LP1471	598301
LP1472	598142
	598331
LP1474	598605
LP149	598086
	598366
LP15	598161
	598338
LP1500	598453
LP1501	598443
LP1502	598575
LP1503	598436
	598451
LP1504	598480
	598829
LP1505	598438
LP1507	598682
LP1509	598895
LP1511	598482
	598650
LP1513	598577
LP1514	598408
LP1515	598544
	598965
LP1516	598468
LP1517	598462
LP1518	598629
LP1519	598420
	598726
LP1520	598965
LP1521	598632
LP1522	598543
LP1524	598473



	
DELPHI (.../...)	
LP1525	598486
LP1526	598435
LP1527	598629
	598647
LP1528	598841
LP1529	598858
LP1531	598556
LP1532	598556
LP1533	598433
LP1534	598627
LP1535	598807
LP1536	598985
LP1539	598748
LP154	598168
LP1541	598650
LP1542	598814
LP1543	598988
LP1544	598806
	601002
LP1545	598915
LP1546	598778
LP1547	598883
LP1548	598697
LP1549	598424
LP1551	598856
LP1552	598661
LP1553	598926
LP1554	598420
LP1555	598784
LP1556	598650
	598681
LP1557	598510
LP1558	598677
LP1559	598907
LP1560	598579
LP1582	598432
LP1583	598547
LP1585	598040
	598065
LP1586	598041
LP1587	598065
	598308
	598880
LP1588	598357
LP1589	598636
LP1590	598071
LP1591	598066
	598128
LP1592	598073
LP1593	598319
LP1594	598626
LP1595	598045
LP1596	598046
LP1597	598074
LP1598	598630
LP1599	598634







	
DELPHI (.../...)	
LP160	598375
LP1600	598305
LP1601	598488
LP1602	598619
LP1603	598043
	598171
LP1604	598212
LP1605	598184
LP1606	598069
	598179
	598353
LP1607	598326
LP1608	598310
	598409
LP1609	598458
LP161	598108
LP1610	598726
LP1611	598385
LP1612	598459
LP1613	598303
LP1614	598470
LP1615	598491
LP1616	541662
LP1617	598461
LP1618	598447
LP1623	598851
LP1624	598398
LP1626	598758
LP1628	601020
LP1629	598420
LP1630	598989
LP1631	598484
LP1632	598536
LP1634	598511
LP164	598107
LP1652	598514
LP1653	598465
	598715
LP1654	598419
LP1655	598416
LP1656	598417
LP1657	598413
LP1659	598452
LP1663	598530
LP1665	598504
LP1671	598821
LP1672	598483
LP1673	598322
	598454
	598860
LP1675	598734
	598735
LP1676	598456
LP1677	598457
LP1678	598425
LP1679	598464
	598465



	
DELPHI (.../...)	
LP168	598377
LP1680	598418
LP1681	598584
LP1682	598434
LP1683	598035
	598434
LP1684	598886
LP1685	598407
LP1686	598065
	598880
	598990
LP1687	598483
	598751
LP1688	541655
	598445
LP1691	598520
LP1692	598813
LP1693	598415
LP1695	598470
	598545
	598669
LP1696	598448
LP1697	598446
LP1699	598461
LP17	598374
LP170	598076
LP1701	598472
	598783
	601005
	601044
LP1702	598910
LP1703	598992
LP1704	598887
LP1705	598719
LP1706	598489
LP1707	598676
LP1708	598471
	598566
LP1709	598805
LP1710	598542
LP1711	598541
LP1712	598643
LP1713	598180
	598500
	598674
LP1714	598566
LP1715	598501
LP1716	598500
LP1717	598584
LP1718	598853
LP1719	598633
LP1720	598428
LP1721	598427
	598721
	598426
LP1722	598426
	598670
	598913



	
DELPHI (.../...)	
LP1723	598678
LP1724	598639
LP1725	598434
LP1726	598472
LP1727	598464
LP1728	598667
LP1730	598558
LP1731	598475
	598860
LP1732	598451
LP1733	598650
	598681
LP1734	598605
	601003
LP1735	598071
LP1736	598734
LP1737	598679
LP1738	598862
LP1739	598848
LP1741	598583
LP1742	598737
LP1743	598505
	598759
LP1744	598473
LP1745	598546
LP1746	598537
LP1747	598538
LP1748	598429
LP1749	598430
LP175	598175
LP1750	598568
LP1751	598569
LP1753	598859
LP1754	598720
LP1758	598496
LP1759	598523
LP1760	598483
LP1761	598745
LP1766	598780
LP1767	598669
LP177	598150
LP1771	598866
LP1772	598738
	598889
LP1773	598414
LP1775	598585
LP1776	598586
LP1778	598396
LP1780	598916
LP1782	598857
LP1783	598678
	598808
LP1784	598710
LP1785	598812
LP1786	598665
LP1787	598657
	601030

	
DELPHI (.../...)	
LP1788	598739
LP1789	598824
LP179	598205
LP1790	598570
LP1791	598638
LP1792	598553
LP1793	598411
	598820
LP1794	598410
LP1795	601001
LP1796	598422
LP1797	598823
LP18	598099
	598187
	598270
LP1800	598406
LP1801	598565
LP1802	541717
LP1803	598580
LP1804	598827
LP1806	598757
LP1807	598672
LP1808	598855
LP1813	598767
LP1815	598463
	598674
LP1816	598361
LP1818	598756
LP1819	598842
LP1821	598657
LP1822	598875
LP1824	598752
LP1825	598750
LP1826	541705
LP1828	598659
LP1829	598831
LP1834	598411
LP1835	598657
LP1837	598635
LP1839	598914
LP1840	598736
LP1843	598811
LP1844	598653
LP1845	601029
LP1846	598462
LP1851	598636
	598712
LP1852	598852
LP1853	598506
LP1854	601019
LP1855	601019
LP1858	598919
LP1859	598755
LP1860	598671
	601004
LP1861	598860



	
DELPHI (.../...)	
LP1862	598824
LP1863	598658
LP1864	598680
LP1865	598641
LP1866	598557
LP1868	598637
LP1869	598649
LP189	598389
LP1890	598662
LP1891	598501
	598663
LP1892	598664
LP1895	598644
LP1896	598917
LP1898	598715
LP1899	598670
	598913
LP1902	598744
LP1903	598992
LP1904	598635
LP1906	598833
LP1908	598944
LP1910	598874
LP1911	598671
LP1913	598651
LP1914	598651
	598652
LP1915	598703
LP1917	598810
LP1919	598453
LP1920	601004
LP1921	598863
LP1922	598779
LP1923	598699
LP1924	598701
LP1925	598700
LP1926	598702
LP1927	598754
	598885
LP1928	598870
LP1929	598696
LP193	598207
LP1932	598705
LP1933	598707
LP1934	598761
LP1935	598741
LP1936	598742
LP1938	598795
LP1939	598765
LP1940	598861
LP1942	598673
LP1943	598822
LP1947	598764
LP1948	598704
LP1949	598718
LP195	598208



	
DELPHI (.../...)	
LP1950	598940
LP1951	598868
LP1952	598867
LP1955	541736
LP1958	598472
	598783
	601044
LP1965	598722
LP1969	598935
LP197	598366
LP1972	601043
LP1977	601035
LP1979	601034
LP1983	541728
LP1984	598876
LP1985	598925
LP1987	598942
LP1988	598941
LP199	598614
LP1990	598839
LP1991	598939
LP1992	598891
LP1994	598892
LP1995	598899
LP1997	598656
LP1999	598929
LP20	598111
LP2003	601037
LP2005	598896
	601026
LP2006	601052
LP2008	598928
LP2013	598987
LP2039	541734
LP204	598212
LP2054	541738
LP2067	601027
LP208	598185
LP2080	601047
LP2082	601048
LP2084	601049
LP21	598187
LP210	598591
LP211	598497
LP213	598129
LP2137	601017
LP214	598117
LP2148	601013
LP2152	601045
LP216	598391
LP219	598123
	598379
LP221	598110
LP224	598124
LP225	598128
LP226	598161
	598338



	
DELPHI (.../...)	
LP228	598149
LP229	598148
	598292
LP232	598162
LP234	598612
LP235	601016
LP238	598168
LP241	598168
LP249	598169
LP250	598217
LP253	598090
LP254	598118
LP255	598166
	598171
	598212
LP259	598384
LP261	598278
LP275	598219
LP286	598220
LP29	598088
LP30	598090
	598603
LP305	598091
	598093
LP306	598163
LP345	598364
LP347	598362
LP350	598151
LP351	598167
LP352	598186
LP353	598091
	598219
LP355	598131
LP358	598123
LP373	598122
LP378	598153
LP382	598081
LP39	598337
LP401	598780
LP403	598052
LP404	598094
LP41	598129
LP412	598615
LP415	598182
	598356
LP418	598130
LP420	598124
LP421	598128
LP422	598363
LP424	598004
	598205
LP427	598109
LP428	598107
	598187
LP429	598017
LP432	598130



	
DELPHI (.../...)	
LP433	598126
	598160
LP435	598116
LP436	598093
LP437	598221
LP440	598105
LP441	598080
	598104
	598107
LP442	598103
LP443	598187
LP444	598017
	598230
LP445	598047
LP448	598921
LP45	598129
	598391
LP451	598125
	598142
LP453	598205
	598214
LP454	598787
	598817
LP455	598241
LP457	598120
	598335
LP458	598220
LP459	598091
	598095
	598135
	598141
	598219
LP460	598266
LP463	598371
LP464	598094
	598141
LP465	598239
LP467	598224
LP468	598205
	598613
LP475	598497
LP477	598113
LP481	598129
LP484	598351
LP485	598115
LP488	598032
	598166
LP489	598082
LP490	598002
	598075
	598081
	598177
	598181
LP491	598080
LP493	598119
	598176
	598714



	
DELPHI (.../...)	
LP496	598093
	598133
	598219
LP499	598044
	598315
LP501	598007
	598374
LP504	598086
LP505	598127
LP506	598623
LP507	598240
LP509	598091
LP517	598093
	598271
LP518	598080
LP519	598131
LP522	598125
	598141
	598142
LP523	598125
	598141
LP525	598248
LP527	598021
LP531	598293
LP533	598964
LP536	598084
	598176
	598181
LP538	598402
	598614
LP539	598175
LP542	598002
	598061
LP543	598123
	598618
LP546	598296
LP548	598027
LP551	598406
LP553	598091
LP555	598103
	598259
LP556	598095
LP557	598121
	598240
LP559	598227
LP56	598077
	598085
LP560	598289
LP562	598053
LP563	598030
	598156
LP564	598179
LP565	598125
	598180
	598463
LP566	598095

	
DELPHI (.../...)	
LP568	598374
LP569	598134
LP571	598180
	598463
LP573	598291
LP574	598983
LP575	598102
LP576	598291
LP579	598230
LP580	598374
LP581	598182
LP583	598369
LP584	540436
	598369
LP585	598184
LP586	598253
LP587	598335
LP588	598593
LP589	598594
LP590	598183
	598243
LP591	598043
	598171
LP593	598052
LP594	598138
	598153
LP595	598239
	598250
LP597	598241
LP598	598006
LP599	598498
LP602	598231
	598811
LP603	598186
LP604	598271
LP605	598248
LP606	598051
	598574
LP607	598947
LP608	598315
LP61	598106
LP610	598122
LP611	598540
	598984
LP612	598984
LP613	598266
	598402
LP616	598054
	598450
LP617	598057
LP618	598019
	598022
LP619	598022
LP620	598268
	598274
LP624	598846

	
DELPHI (.../...)	
LP625	598053
LP628	598248
LP629	598020
LP633	598220
	598597
LP635	598384
LP637	598621
LP639	598015
LP640	598620
LP643	598257
LP644	598135
LP645	598786
LP647	598018
LP651	598391
LP652	598030
	598156
LP653	598254
LP654	598029
LP655	598292
LP666	598294
LP667	598062
	598295
LP668	598025
LP669	598039
LP670	598024
LP671	598296
LP673	598172
LP674	598003
LP676	598666
LP677	598271
LP684	598023
LP687	598123
LP692	598000
	598005
LP693	598135
LP695	598154
LP696	598075
	598081
	598155
	598181
LP697	598613
LP698	598613
LP699	598396
LP702	598039
	598356
LP703	598156
	598360
LP704	598052
LP705	598440
LP706	598230
LP707	598123
LP710	598018
	598107
LP712	598115
LP713	598345
LP720	598047

	
DELPHI (.../...)	
LP726	598618
LP731	598237
LP732	598091
LP734	598788
LP735	598000
	598613
LP736	598626
LP737	598695
LP740	598028
	598294
LP741	598280
LP742	598815
LP743	598274
	598646
LP745	598122
LP76	598099
LP766	598036
LP767	598037
LP769	598982
LP770	598004
	598016
	598330
LP771	601021
LP772	598437
LP777	598762
LP778	598016
	598017
	598252
LP779	598014
LP780	598642
LP781	598033
LP782	598034
LP783	598628
LP784	598067
	598355
LP785	598048
LP786	598269
LP787	598031
LP788	598061
LP789	598551
LP792	598383
LP793	598038
	598074
LP794	598034
	598120
LP800	598250
LP801	598629
LP802	598290
LP803	598625
LP804	598628
LP8040	541641
LP806	598826
LP807	598826
LP809	598494
LP810	598495
	598760



DELPHI (.../...)	
LP812	598787
LP813	598691
LP814	598828
LP821	598055
LP822	598382
LP823	598714
LP825	598080
	598396
LP828	598112
LP834	598540
LP838	598002
LP839	598616
LP841	598617
LP844	598601
LP846	598103
LP847	598602
LP848	598256
LP849	598859
LP850	598180
LP851	598011
	598012
LP853	598035
LP854	598897
LP86	598099
LP862	598599
LP867	598809
LP868	598312
LP869	598056
LP87	598108
LP871	598517
LP872	598627
LP873	598050
LP874	598351
LP875	598010
LP877	598070
LP878	598800
LP88	598375
LP880	598903
LP881	598013
LP884	598017
LP885	598002
	598084
LP891	598600
LP892	598600
LP900	598008
LP901	598017
LP907	598386
LP909	598064
LP910	598502
LP911	598022
LP913	598441
LP914	598499
LP915	598345
LP918	598048
	598622
	598814



DELPHI (.../...)	
LP92	598389
LP930	598476
LP931	598624
LP940	598809
LP941	598496
LP946	598272
LP948	598682
	598911
LP952	598840
LP954	598519
LP955	598834
	598866
LP961	598266
LP962	598393
LP963	598777
LP964	598460
LP965	598507
	598661
LP967	598533
LP968	598844
LP97	598090
LP970	598598
LP975	598668
LP978	598355
LP979	598258
LP980	598044
LP981	598590
LP986	598069
	598467
LP989	598947
LP99	598085
LP991	598063
LP992	598320
LP993	598318
FERODO	
FDB100	598363
FDB1000	598064
FDB1001	598712
FDB1002	598073
FDB1003	598502
FDB101	598090
FDB1011	598836
FDB1013	598844
FDB1015	598460
FDB1017	598507
FDB102	598094
	598141
FDB1020	598533
FDB1021	598777
FDB1034	598695
FDB1038	598044
FDB1040	598040
	598607
FDB1040B	598040
	598607



FERODO (.../...)	
FDB1044	598062
FDB1049	598357
FDB105	598099
FDB1050	598636
FDB1052	598065
	598308
	598990
FDB1052B	598065
	598308
	598990
FDB1054	598066
FDB1055	598067
	598463
FDB1056	598040
	598041
	601003
FDB1056B	598040
	598041
	601003
FDB106	598077
	598078
	598085
FDB1062	598068
FDB1063	598069
	598467
FDB1067	598184
FDB1068	598305
FDB1069	598385
FDB1070	598207
FDB1072	598258
FDB1072G	598258
FDB1073	598310
	598409
	598811
FDB1075	598311
FDB1081	598212
FDB1083	598180
	598463
FDB1085	598061
FDB1091	598071
FDB1092	598320
FDB1094	598332
FDB1096	598450
FDB1098	598556
FDB1099	598965
FDB11	598017
	598111
FDB1100	598830
FDB1101	598488
FDB1104	598668
FDB1109	598156
FDB1112	598326
FDB1113	598125
	598141
	598142
	598219
	598331



FERODO (.../...)	
FDB1114	598420
FDB1116	598361
FDB1117	598183
	598187
FDB1117B	598183
	598187
FDB1124	598470
FDB1129	598906
FDB113	598077
	598078
	598085
FDB1134	598880
FDB1135	598726
FDB114	598077
	598085
FDB1156	598528
FDB1157	598854
FDB116	598108
FDB1160	598605
FDB1162	598329
FDB1166	598806
	601002
FDB1167	598355
FDB1168	598074
FDB11X	598111
FDB123	598375
FDB1254	598904
FDB126	598147
FDB1263	598452
FDB1264	598459
FDB1265	598458
FDB1276	598399
FDB1278	598328
FDB128	598099
	598106
	598109
FDB1285	598616
FDB1288	598403
FDB1289	598017
FDB1291	598512
FDB1293	598322
FDB1294	598926
FDB1295	598454
FDB130	598174
	598375
FDB1300	598018
FDB1301	598753
FDB1303	598549
FDB1304	598299
FDB1305	598301
FDB1307	598766
FDB1308	598768
FDB1310	598763
FDB1311	598444
FDB1312	598330
FDB1318	598317







 	
FERODO (.../...)	
FDB1319	598431
FDB1319B	598431
FDB1321	598478
FDB1322	598447
FDB1323	598483
FDB1324	598425
FDB1325	598406
FDB1326	598575
FDB1327	598530
FDB1333	598895
FDB1334	598772
FDB1336	598902
FDB1337	598316
FDB1349	598407
FDB1355	598632
FDB1356	598582
FDB1357	598549
FDB1368	598606
FDB1370	598462
FDB1376	598424
FDB1377	598424
FDB1378	598461
FDB1379	598466
FDB1380	598527
FDB1382	601030
FDB1383	598480
FDB1392	598737
FDB1393	598563
FDB1394	598564
FDB1395	598577
FDB1398	598408
FDB1399	598464
FDB1400	598442
FDB1401	598443
FDB1407	598750
FDB1409	598557
FDB1410	598417
FDB1411	598419
FDB1412	598416
FDB1413	598418
FDB1414	598638
FDB1415	598063
	598664
FDB1416	598434
FDB1419	598667
FDB142	598178
FDB1420	598473
FDB1421	598843
FDB1422	598522
FDB1423	598453
FDB1424	598456
FDB1425	598433
FDB1426	598445
	598659
FDB1427	598446



 	
FERODO (.../...)	
FDB1428	598448
FDB1429	598448
FDB143	598109
FDB1433	598476
FDB1434	598523
FDB1439	598436
FDB1440	598566
	601012
FDB1441	598471
FDB1442	598543
FDB1444	598907
FDB1445	598515
FDB1446	598516
FDB1447	598653
FDB1451	598484
FDB1454	598449
FDB1455	598548
FDB1456	598535
FDB1457	598865
FDB1458	598579
FDB1459	598991
FDB1460	598967
FDB1463	598180
	598486
FDB1466	598426
FDB1467	598427
	598698
	598721
FDB1468	598428
FDB1469	598633
FDB1470	601001
FDB1471	601029
FDB1472	598457
FDB1473	598514
FDB1475	598755
FDB1476	598465
FDB1477	598398
FDB1481	598681
FDB1482	598482
	598650
	598681
FDB1483	598580
FDB1485	598439
FDB1486	598438
FDB149	598165
FDB1491	598180
FDB1493	598764
FDB1494	598765
FDB1495	598481
FDB1496	598489
FDB1497	598565
FDB1499	598413
FDB1500	598643
FDB1501	598856
FDB1502	598393
FDB1505	598627



 	
FERODO (.../...)	
FDB1506	598758
FDB1508	598988
FDB1510	598415
FDB1511	598661
FDB1512	598719
FDB1513	598736
FDB1514	598536
FDB1515	598545
FDB1517	598735
FDB1520	598678
FDB1521	598584
FDB1523	598510
FDB1524	598677
FDB1526	598637
FDB1527	598784
FDB1528	598827
FDB1529	598541
FDB1530	598542
FDB1531	598673
FDB1532	598733
	598832
FDB1533	598848
FDB1535	598475
FDB1536	598511
FDB1540	598472
FDB1541	598471
FDB1542	598500
FDB1543	598501
FDB1544	598558
FDB1545	598468
FDB1551	598697
FDB1554	598912
FDB1556	598553
	598793
FDB1559	598912
FDB1564	601023
FDB1565	598534
FDB1569	598841
FDB1570	598778
FDB1573	598679
FDB1574	598680
FDB1580	598451
FDB1581	598761
FDB1582	598761
FDB1593	598704
FDB1594	598649
FDB1595	598821
FDB1596	598521
FDB1597	598658
FDB1599	598462
FDB160	598375
FDB1600	598745
FDB1601	598435
FDB1603	598518
FDB1604	598520
FDB1605	598505
	598759

 	
FERODO (.../...)	
FDB1606	598748
FDB1607	598989
FDB1608	598813
FDB161	598107
FDB1610	601025
FDB1612	598915
FDB1613	598742
FDB1615	598741
FDB1617	598641
FDB162	598187
FDB1620	598862
FDB1621	598886
FDB1625	598655
FDB1626	598656
FDB1627	598770
FDB1628	598410
FDB1629	598652
	598779
FDB163	598107
FDB1630	598012
FDB1631	598657
FDB1632	598829
FDB1633	598734
FDB1634	598805
FDB1635	598408
FDB1636	598752
FDB1637	598463
FDB1639	598853
FDB164	598107
	598187
FDB1640	598860
FDB1641	598635
FDB1645	598674
FDB1646	598523
FDB1648	598665
FDB1649	598812
FDB1651	601003
FDB1652	598696
FDB1654	598801
FDB1655	601004
FDB1658	598757
FDB1661	598659
FDB1662	598720
FDB1663	598772
FDB1666	598670
	598913
FDB1667	598861
FDB1668	598483
	598751
FDB1669	598887
FDB167	598168
FDB1670	598506
FDB1672	598820
FDB1673	598411
FDB1675	601005
FDB1676	598643



 	
FERODO (.../...)	
FDB1679	598682
FDB1693	598672
FDB1698	598857
FDB1698	598644
FDB1700	598883
FDB1702	598855
FDB1703	601022
FDB1704	598824
FDB1706	598822
FDB1709	598992
FDB1711	598439
FDB1713	598438
FDB1717	598751
FDB1721	598780
FDB1725	598662
FDB1726	598663
FDB1727	598664
FDB1728	598715
FDB173	598182
	598356
FDB1733	598744
FDB1735	598654
FDB1736	598823
FDB1737	598574
FDB1738	598318
FDB1742	598767
FDB1745	598889
FDB1747	598699
FDB1749	598704
FDB175	598124
	598128
	598205
FDB1750	598795
FDB1751	598700
FDB1753	598035
FDB1757	598515
FDB176	598076
FDB1765	598863
FDB1766	598472
	598783
FDB1770	598180
FDB1773	598640
FDB1781	598002
FDB1782	598583
FDB1783	598707
FDB1784	598702
FDB1787	598553
FDB1788	598180
	598463
FDB1790	598718
FDB1794	598772
FDB1795	601029
FDB1796	601029
FDB1797	598727
FDB1798	598727
FDB1805	598729



 	
FERODO (.../...)	
FDB1806	598701
FDB1807	598703
FDB1808	598885
FDB1826	598940
FDB1827	598484
	598751
FDB1830	598728
FDB1831	598802
FDB1832	598845
FDB1833	598808
FDB1835	598770
FDB1838	598939
FDB1839	598852
FDB1840	598781
FDB1858	598722
FDB1859	598803
FDB186	598614
FDB1861	598875
FDB1862	598849
FDB1865	598993
FDB1866	601012
FDB1867	598753
FDB1868	598710
FDB1869	598842
FDB1875	598804
FDB1877	598994
FDB1881	598738
FDB1885	598740
FDB1889	598874
FDB1890	601026
FDB1892	598819
FDB1894	598746
FDB1895	598810
FDB1896	598859
FDB1897	598879
FDB1898	601007
FDB190	598113
FDB1902	598706
FDB1907	601034
FDB1910	598932
FDB1911	598944
FDB1917	598935
FDB1918	598928
FDB1919	598839
FDB192	598108
FDB1920	598825
FDB1922	598722
FDB1931	598472
	598783
	601044
FDB1932	598935
FDB1933	598935
FDB1934	598942
FDB1935	598941
FDB1936	601035
FDB194	598377



 	
FERODO (.../...)	
FDB1944	598987
FDB1945	601015
FDB1946	598426
FDB1947	598929
FDB195	598389
FDB1950	598708
FDB1955	598868
FDB1956	598867
FDB196	598207
FDB1968	598919
FDB1969	598361
FDB197	598364
FDB1970	598834
	598866
FDB1971	598997
FDB1972	598998
FDB1973	598936
FDB1974	598699
FDB1976	601031
FDB198	598208
FDB1980	601051
FDB1982	598476
FDB1985	598917
FDB1988	598873
FDB1990	598821
FDB1992	598852
FDB1997	598738
FDB1999	598871
FDB201	598148
FDB203	598592
FDB206	598212
FDB208	598185
FDB212	598120
	598166
	598212
FDB22	598088
FDB221	598093
FDB222	598125
FDB225	598123
	598379
FDB230	598220
FDB235	598081
FDB240	598168
FDB241	598612
FDB243	598110
FDB253	598150
FDB256	598080
	598104
FDB257	598162
FDB264	598090
FDB268	598163
FDB272	598149
FDB274	598118
FDB275	598217
FDB276	598120
	598335



 	
FERODO (.../...)	
FDB284	598817
FDB285	598131
FDB286	598168
FDB288	598921
FDB289	598169
FDB29	598603
FDB293	598278
FDB296	598103
FDB2H	598050
	598099
	598270
FDB300	598047
FDB308	598266
FDB316	598384
FDB317	598221
FDB318	598402
FDB328	598105
FDB340	598123
FDB346	598091
	598219
FDB347	598351
FDB348	598113
FDB349	598130
FDB350	598093
	598168
FDB357	598224
FDB359	598160
FDB361	598094
FDB363	598091
	598093
	598271
FDB365	598167
FDB368	598220
FDB370	598091
	598141
	598219
FDB372	598780
FDB375	598182
	598356
FDB385	598127
FDB391	598115
FDB392	598124
	598127
FDB393	598002
	598075
	598081
	598177
	598181
FDB393D	598081
FDB396	598021
FDB398	598240
FDB3M	598099
	598187
FDB4001	598888
FDB4003	598927
FDB4004	598180







 	
FERODO (.../...)	
FDB4014	598705
FDB402	598175
FDB4023	598893
FDB4035	601017
FDB4041	601028
FDB4042	598933
FDB4045	598996
FDB4046	601040
FDB4055	598995
FDB4056	598709
FDB406	598061
FDB4060	598877
FDB4066	598464
FDB4074	598924
FDB4076	598052
FDB4077	598878
FDB408	598121
FDB4080	598925
FDB4081	601052
FDB410	598134
FDB4110	598999
FDB412	598214
FDB4136	601037
FDB4148	601013
FDB415	598315
FDB4177	598738
FDB4178	598463
FDB4179	598999
FDB4182	601000
FDB4183	598474
FDB4184	601014
FDB4185	601010
FDB4188	598678
FDB419	598127
	598128
	598181
FDB4191	601027
FDB4192	598752
FDB4193	598945
FDB42	598174
FDB420	598371
FDB4221	598898
FDB423	598375
FDB424	598375
FDB428	598151
FDB428B	598151
FDB434	598119
	598714
FDB435	598052
FDB440	598080
	598396
FDB441	598130
FDB442	598126
FDB445	598227
FDB448	598115
FDB454	598248



 	
FERODO (.../...)	
FDB455	598084
	598119
	598176
	598181
FDB456	598125
	598141
FDB470	598983
FDB471	598497
FDB472	598053
	598437
FDB478	598540
	598984
FDB487	598293
FDB507	598964
FDB509	598271
FDB519	598271
FDB520	598129
	598497
	598498
FDB524	598095
FDB525	598183
FDB527	598406
FDB534	598082
FDB535	598030
	598156
FDB536	598102
FDB540	598179
	598353
FDB541	598180
FDB542	598006
FDB546	598289
FDB55	601016
FDB550	598296
FDB556	598597
FDB558	598158
	598396
	598570
FDB565	598010
FDB576	598250
FDB577	598231
	598440
FDB578	598259
FDB579	598335
FDB58	598362
FDB581	598186
FDB584	598184
FDB585	598047
FDB586	598183
	598253
FDB588	598666
FDB589	598043
FDB590	598355
FDB593	598003
FDB595	598135
FDB597	598268
FDB598	598248



 	
FERODO (.../...)	
FDB600	598051
	598786
FDB602	598266
FDB603	598254
FDB604	598054
FDB608	598019
FDB609	598183
	598243
FDB613	598022
FDB614	598029
	598385
FDB615	598292
FDB617	598172
	598399
FDB619	598063
	598295
FDB621	598053
FDB622	598237
FDB623	598294
FDB628	598257
FDB630	598846
FDB632	598039
FDB634	598620
FDB638	598817
FDB641	598123
	598618
FDB643	598122
FDB644	598272
FDB646	598601
FDB647	598005
FDB649	598809
FDB651	598135
FDB654	598290
	598624
FDB660	598241
FDB667	598024
	598054
	598450
FDB669	598241
FDB671	598015
FDB676	598621
FDB678	598020
FDB686	598256
FDB691	598051
	598786
	598787
FDB707	598057
FDB708	598052
FDB71	598193
FDB712	598023
FDB714	598646
FDB715	598274
FDB717	598123
FDB719	598155
	598181
FDB720	598154

 	
FERODO (.../...)	
FDB721	598859
	598988
FDB723	598108
FDB725	598018
FDB729	598075
	598081
	598155
	598177
	598181
FDB730	598075
	598155
	598181
FDB732	598039
	598356
FDB742	598028
FDB745	598156
FDB746	598280
FDB749	601021
FDB759	598626
FDB763	598628
FDB764	598625
FDB765	598517
	601020
FDB766	598033
	598034
	598619
FDB767	598033
FDB774	598004
	598016
	598330
FDB775	598017
	598252
FDB776	598494
FDB777	598495
	598760
FDB779	598231
FDB780	598296
FDB789	598691
FDB790	598828
FDB796	598826
FDB797	598393
	598897
FDB799	598617
FDB804	598519
FDB815	598374
FDB817	598374
FDB819	598161
	598193
	598338
FDB840	598116
FDB844	598497
FDB845	598002
	598084
FDB846	598120
FDB850	598386
FDB854	598013



 	
FERODO (.../...)	
FDB857	598411
FDB859	598014
FDB867	598551
FDB869	598290
FDB871	598623
FDB872	598762
FDB874	598031
FDB875	598383
FDB876	598038
	598074
FDB877	598158
	598396
FDB878	598055
FDB880	598382
FDB881	598080
FDB884	598034
FDB901	598050
FDB904	598056
FDB905	598627
FDB909	598602
FDB915	598312
FDB917	598903
FDB925	598011
	598012
FDB930	598496
FDB937	598851
FDB939	598250
FDB940	598840
FDB943	598815
FDB950	598629
FDB951	598982
FDB953	598281
FDB954	598017
FDB956	598682
	598911
FDB96	598389
FDB969	598303
FDB972	598599
FDB973	598183
FDB974	601024
FDB977	598600
FDB979	598345
FDB98	598145
FDB980	598441
FDB981	598499
FDB985	598355
FDB99	598146
FDB992	598642
FDB993	598293
FDB994	598308
FDB995	598581
FDB997	598412
FDB998	598412



 	
FTE	
BL1002A1	598274
BL1003A1	598099
	598187
BL1005A1	598111
BL1007A1	598099
	598187
BL1009A2	598293
BL1011A2	598129
	598498
BL1012A1	598090
	598603
BL1013A1	598088
BL1014A2	598984
BL1017A1	598338
BL1020A1	598618
	598851
BL1022A1	598270
BL1024A3	598025
	598048
BL1024B3	598025
	598048
BL1027A1	598497
	598623
BL1028A2	598174
BL1030A2	598497
BL1031A1	598148
	598292
BL1032A1	598695
BL1034A3	598004
	598016
BL1035A3	598017
	598252
BL1035B3	598017
	598252
BL1037A2	598386
BL1040A1	598762
BL1041A1	598099
BL1042A1	598099
BL1043A2	598382
BL1046A1	598375
BL1047A1	598375
BL1049A1	598362
BL1052A1	598094
BL1053A1	598146
BL1057A1	598115
BL1058A1	598077
	598085
BL1059A2	598110
BL1061A1	598085
BL1062A2	598147
BL1064A1	598129
	598391
BL1065A1	598364
BL1066A1	598371
BL1067A1	598207
BL1069A2	598109



 	
FTE (.../...)	
BL1070A2	598109
	598110
BL1072A1	598337
BL1073A1	598055
BL1074A1	598165
BL1075A2	598187
BL1076A2	598107
BL1077A2	598107
BL1078A2	598086
BL1079A2	598178
	598193
BL1080A2	598187
BL1083A1	598076
BL1087A2	598366
BL1088A1	598168
BL1096A3	598214
BL1097A3	598128
	598205
BL1098A1	598148
	598292
BL1101A2	598338
BL1105A2	598150
BL1110A2	598104
BL1112A1	598396
BL1113A2	598151
BL1114A1	598120
	598166
	598212
BL1114B1	598120
	598166
	598212
BL1118A1	598048
BL1118A2	598807
BL1122A3	598004
BL1123A3	598004
	598017
BL1123B3	598004
	598017
BL1125A2	598103
BL1125B2	598103
BL1128A2	598149
BL1129A2	598620
BL1131A2	598091
	598093
BL1134A1	598614
BL1135A1	598185
BL1137A1	598221
BL1138A4	598153
BL1140A1	598105
BL1140B1	598105
BL1141A1	598345
BL1142A2	598129
	598132
BL1143A1	598612
BL1144A2	598117
BL1146A2	598166



 	
FTE (.../...)	
BL1150A2	598133
BL1151A4	598093
	598095
	598141
	598219
BL1152A1	598141
BL1153A2	598163
BL1154A1	598921
BL1155A1	598172
BL1158A1	598167
BL1160A2	598217
BL1161A1	598122
BL1163A3	598266
	598402
BL1164A2	598162
BL1167A3	598124
	598128
BL1167B3	598124
	598128
BL1168A3	598258
BL1169A3	598128
BL1169B3	598128
BL1170A3	598127
BL1170B3	598127
BL1174B2	598182
BL1175A4	598017
BL1175B4	598017
BL1176A1	598120
	598335
BL1177A2	598120
BL1179A2	598113
BL1181A2	598375
BL1183A2	598061
BL1184A2	598086
BL1185A2	598182
BL1186A1	598130
BL1187A2	598091
BL1187B2	598091
BL1188A2	598375
BL1189A1	598220
BL1191A1	598384
BL1192A1	598278
	598296
BL1193A3	598180
	598463
	598474
BL1194A3	598180
	598463
BL1194A4	598681
BL1197A3	598027
BL1198A1	598240
BL1199U1	598556
BL1200A2	598075
	598081
	598177
	598181
	598338







 	
FTE (.../...)	
BL1200B2	598075
	598081
	598177
	598181
	598338
BL1201A2	598155
	598181
BL1202A2	598155
	598181
BL1202B2	598075
	598155
	598181
BL1203A2	598119
	598176
BL1204A2	598103
	598259
BL1204B2	598103
	598259
BL1205A2	598115
BL1207A1	598102
BL1209A1	598052
BL1209A2	598051
	598052
BL1212A4	598315
BL1212B4	598315
BL1217A1	598183
	598187
BL1218A1	598243
BL1219A4	598241
BL1219B4	598241
BL1220A2	598231
BL1221A1	598237
	598269
BL1223A2	598121
	598240
	598312
BL1224A2	598176
BL1224B2	598176
BL1226A2	598082
BL1227A2	598291
BL1228A2	598133
	598134
	598135
BL1229A2	598080
BL1229B2	598080
BL1230A1	598142
BL1231A2	598095
BL1231B2	598095
BL1232A1	598141
BL1233A2	598374
BL1236A2	598123
BL1238A1	598964
BL1241A2	598126
	598160
BL1242A4	598230
BL1243A1	598253



 	
FTE (.../...)	
BL1243B1	598253
BL1245A1	598021
BL1246A3	598125
	598142
	598180
BL1246B3	598125
	598142
	598180
BL1247A2	598006
BL1248A2	598601
BL1249A2	598269
BL1250A4	598003
BL1251A2	598402
	598614
	598947
BL1253A2	598289
BL1254A1	598406
BL1255A1	598172
BL1255A2	598172
	598399
BL1255B1	598172
BL1257A2	598030
	598156
BL1258A2	598135
BL1259A4	598135
BL1260A2	598184
BL1260B2	598184
BL1261A1	598271
BL1262A2	598271
BL1263A2	598272
BL1263B2	598272
BL1264A1	598043
	598171
BL1264B1	598043
	598171
BL1265A2	598138
BL1266A2	598179
BL1267A2	598281
BL1268A1	598015
BL1269A2	598278
BL1270A3	598186
BL1271A1	598257
BL1277A2	598616
BL1278A2	598039
	598063
	598502
BL1279A2	598295
BL1279A3	598063
BL1280A1	598024
BL1281A2	598103
BL1282A2	598018
BL1283A2	598029
BL1284A2	598294
BL1287A2	598617
BL1288A2	598053
	598682



 	
FTE (.../...)	
BL1291A2	598248
BL1293A2	598666
BL1296A2	598296
BL1297A2	598123
	598618
BL1298A2	598047
BL1299A1	598039
	598356
BL1299B1	598039
	598356
BL1300A2	598268
BL1301A2	598239
BL1302A1	601021
BL1303A2	598982
BL1303B2	598982
BL1305A3	598256
BL1306A2	598266
	598402
BL1307A2	598597
BL1309A2	598250
BL1310A2	598010
BL1311A1	598621
BL1313A2	598061
BL1315A1	598034
	598630
BL1316A1	598050
BL1318A2	598038
BL1319A1	598012
BL1319A2	598011
	598987
BL1320A4	598013
BL1320B4	598013
BL1322A2	598154
BL1323A2	598002
	598084
BL1324A1	598037
BL1324A2	598037
BL1325A1	598036
BL1325A2	598036
BL1327A3	598622
BL1327A4	598814
BL1327B3	598622
BL1328A3	598602
BL1329A2	598580
BL1330A2	598691
BL1331A2	598788
BL1332A2	598023
BL1333A2	598028
BL1334A2	598280
BL1335A3	598512
BL1335A4	598022
	598436
BL1336A2	598051
	598786
BL1337A2	598646
	598786

 	
FTE (.../...)	
BL1338A2	598020
BL1339A1	598057
BL1340A1	598054
BL1342A2	598817
BL1343A1	598846
BL1344A1	598624
BL1345A2	598787
BL1347A3	598112
BL1349A2	598630
BL1351A2	598599
BL1352A3	598158
BL1353A2	598551
	598579
	598809
BL1354A2	598714
BL1355A2	598355
BL1356A2	598120
BL1357A1	598014
BL1358A2	598031
BL1359A2	598383
BL1360A2	598065
	598308
	598990
BL1361A2	598034
BL1361A4	598033
BL1362A2	598625
BL1363A1	598626
BL1363A2	598626
BL1364A2	598627
BL1365A2	598274
BL1366A2	598628
BL1367A3	598217
BL1368A2	598357
BL1369A2	598636
BL1369B2	598636
BL1370A2	598393
	598897
BL1373A2	598494
BL1374A2	598495
	598760
BL1375A2	598828
BL1376A2	598519
	598834
	598866
BL1378A2	598668
	598826
BL1379A2	598840
BL1380A2	598682
	598911
BL1381A4	598068
BL1382A2	598051
	598574
	598786
BL1383A2	598240
	598312
BL1384A2	598826



 	
FTE (.../...)	
BL1385A2	598250
	598629
BL1386A2	598983
BL1387A1	598290
	598846
BL1388A2	598517
	601020
BL1389A2	598070
BL1390A2	598800
BL1391A2	598064
BL1392A1	598305
BL1393A2	598540
	598984
BL1394A2	598177
	598496
BL1396A2	598519
BL1398A2	598460
BL1399A1	598488
BL1399A2	598805
BL1399B1	598488
BL1400A1	598066
BL1400B1	598066
BL1401A2	598507
BL1402A2	598056
BL1403A1	598482
BL1404A3	598318
BL1405A2	598041
BL1406A1	598605
BL1406A2	598040
BL1407A1	598809
BL1409A2	598071
BL1410A1	598556
BL1410U1	598556
BL1411A2	598613
BL1412A4	598019
BL1427U1	598965
BL1428U1	598491
BL1429U2	598600
BL1435A2	598000
BL1436A4	598008
BL1438A2	598044
BL1440A2	598045
BL1441A2	598046
BL1447A2	598007
BL1448A2	598598
BL1449A2	598132
BL1450A2	598380
BL1451A2	598598
BL1452A2	598596
BL1453A2	598369
BL1461A2	540436
BL1462A3	598254
BL1465A2	598115
BL1466A2	598351
BL1467A2	598062
BL1470A2	598310
	598409



 	
FTE (.../...)	
BL1471A2	598311
BL1472A2	598712
BL1474A3	598330
BL1475A3	598017
BL1475A4	598484
BL1475B3	598017
BL1475B4	598484
BL1476A1	598675
BL1476A2	598676
BL1477A1	598067
BL1477A2	598489
BL1479A1	598619
BL1480A1	598043
	598171
BL1481A1	598212
BL1481B1	598212
BL1482A2	598073
BL1483A3	598398
BL1483A4	598326
BL1484A1	598038
	598074
BL1485A1	598156
	598360
BL1487A4	598069
	598467
BL1488A2	598594
BL1489A2	598080
	598396
BL1490A4	598319
BL1493A1	598780
BL1496A2	598815
BL1498A2	598897
BL1499A2	598986
BL1500A1	598777
BL1503A2	598393
BL1504A1	598947
BL1505A2	598691
BL1506A2	598533
BL1507A2	598830
BL1511U2	598600
BL1512U1	598595
BL1513U1	598509
BL1514U2	598906
BL1519U2	598458
BL1520U2	598459
BL1524A1	598303
BL1524A2	598486
BL1525A1	598403
BL1525B1	598403
BL1526A2	598322
BL1527A2	598454
BL1528A1	598271
BL1529A4	598320
BL1531A2	598470
BL1538A3	598581
BL1541A2	598440



 	
FTE (.../...)	
BL1542A4	598903
BL1544A2	598437
BL1552A2	598355
BL1553U1	598965
BL1554U2	598904
BL1556U1	598965
BL1591A1	598183
BL1593A3	598270
	598338
BL1594A4	598353
BL1596A2	598859
BL1605A4	598010
	598985
BL1612A2	598018
BL1613A2	598386
	598753
BL1614A1	598332
BL1614A2	598408
BL1614B1	598332
BL1617A4	598483
	598751
BL1626A2	598844
BL1628A2	598836
BL1629A2	598835
BL1631A1	601024
BL1633A2	598634
BL1634A2	598850
BL1635A2	598989
BL1638A3	598441
BL1639A3	598499
BL1640A2	598522
BL1641A2	598040
BL1643A2	598534
BL1644A2	598412
BL1645A2	598523
BL1649A2	598449
BL1651A1	598763
BL1652A4	598726
BL1657A3	598142
	598331
BL1658A2	598308
BL1659A2	598309
	598772
BL1661A4	598420
BL1662A1	598423
BL1662A2	601019
BL1663A2	598424
BL1664A1	598423
BL1664A2	601019
BL1665A1	598317
BL1665B1	598317
BL1666A3	598431
BL1667A2	598435
BL1668A1	598451
BL1668A4	598436
	598451



 	
FTE (.../...)	
BL1669A2	598682
	598758
BL1671A2	598586
BL1672A2	541662
	541683
BL1673A2	598548
BL1676A2	598515
BL1678A1	598444
BL1679A2	598447
BL1680A2	598299
BL1681A2	598442
BL1682A4	598443
	598813
BL1683A1	598450
BL1684A2	598926
BL1685A4	598493
BL1687A1	598328
BL1688A1	598490
BL1690A2	598305
	598475
BL1691A4	598329
BL1693A1	598735
BL1693A2	598734
BL1694A2	598880
BL1695A4	598549
BL1696A4	598549
BL1697A4	598991
BL1700A2	598466
BL1702A1	598579
BL1703A2	598478
BL1704A2	598361
BL1705A3	598902
BL1706A1	598316
BL1708A2	598841
BL1711A2	598575
BL1712A2	598452
BL1713A2	598524
BL1714A2	598843
BL1715A2	598606
BL1716A1	598479
BL1717A1	598480
BL1727A2	598184
BL1728A3	598473
BL1731A4	598448
BL1732A4	598448
BL1733A1	598301
BL1736A2	598766
BL1737A2	598768
BL1738A2	598811
BL1739A2	598456
BL1740A1	598444
BL1741A2	598300
BL1742A1	598607
BL1743A1	598607
	601003
BL1744A2	541655
	598445







 	
FTE (.../...)	
BL1745A2	598475
BL1747A2	598719
BL1750A3	598583
BL1751A2	598753
BL1752A1	598433
BL1753A4	598457
BL1754A2	598446
BL1755A2	598858
BL1762A2	541641
BL1767A2	598992
BL1769A4	598432
BL1770A1	598422
	598424
BL1771A4	598482
BL1773A4	598650
	598681
BL1774A2	598565
BL1775A2	598632
BL1776A1	598563
BL1777A1	598564
BL1778A4	598453
BL1779A2	598006
BL1780A1	598545
	598669
BL1780A2	598470
	598545
BL1781A3	598566
	601012
BL1782A3	598471
BL1783A3	598471
BL1784A1	598472
	598783
BL1785A3	598183
BL1786A2	598413
BL1787U2	598543
BL1788A2	598806
	601002
BL1789U1	598544
BL1790A3	598434
BL1791A2	598883
BL1792A2	598530
BL1794A3	598465
BL1795A4	598429
	598430
BL1796A4	598426
	598670
	598913
BL1797A2	598410
BL1798A2	598411
BL1799A2	598820
BL1800A3	598500
BL1801A3	598501
BL1802A4	598417
BL1803A4	598419
BL1804A4	598416
BL1805A1	598418



 	
FTE (.../...)	
BL1806A2	598887
BL1807A2	598682
	601043
BL1808A2	598907
BL1809A2	598518
BL1810A2	598520
BL1811A2	598778
BL1812A4	598429
	598430
BL1813A1	598422
BL1814A1	598425
BL1815A1	598639
BL1816A2	598483
BL1817A2	598678
BL1818A2	598678
	598808
BL1819A2	598767
BL1821A3	598538
BL1822A2	598655
BL1823A2	598656
BL1824A2	598770
BL1825A1	598537
BL1826U2	598510
BL1827U1	598677
BL1828A3	598584
BL1828A4	598584
BL1829A2	598638
BL1829A4	598638
BL1830A2	598659
BL1830A4	598659
BL1831A2	598637
BL1832A2	598643
BL1833A2	598454
	598860
BL1834A2	598661
BL1838A2	598750
BL1839U2	598415
BL1840A4	598547
BL1841A1	598514
BL1842A2	598733
	598832
BL1843A1	598407
BL1844A1	598633
BL1845A2	598737
	598917
BL1846A4	598674
BL1847A4	598382
BL1848A2	598745
BL1850A3	598780
BL1851A2	598647
BL1853A2	598784
BL1854A2	598915
BL1855A2	598895
BL1856A2	598697
BL1857A3	598698
BL1857A4	598427
	598721



 	
FTE (.../...)	
BL1858A4	598428
BL1859A4	598568
BL1860A4	598569
BL1861A3	598570
BL1862A2	598988
BL1863A2	598658
BL1864A2	598489
	598801
BL1865A2	598856
BL1866A2	598736
BL1868A2	541717
BL1869A2	541705
BL1870A2	598651
BL1871A1	598652
BL1871A2	598652
BL1872A3	601004
BL1872A4	598671
BL1873A4	598667
	598720
BL1874A2	598640
BL1875A2	598754
BL1876A3	598641
BL1876A4	598847
BL1878A2	598679
BL1879A1	598827
BL1880A2	598577
BL1881A2	598680
BL1883A2	598541
BL1884A2	598542
BL1885A2	598744
BL1886A1	598756
BL1887U1	598755
BL1889A4	598035
BL1890A3	598546
BL1891A3	598461
BL1892A3	598462
BL1893A2	598065
	598990
BL1894A4	598553
BL1895A2	598635
BL1896A4	598752
BL1899A3	598557
BL1900A3	598558
BL1901A2	598853
BL1902A2	598739
	598781
BL1905A3	598780
BL1906A2	598779
BL1907A4	598582
BL1909A1	598829
BL1910A1	598649
BL1911A3	598463
BL1912A1	598644
BL1913A1	598874
BL1914A2	598848
BL1916A2	598886

 	
FTE (.../...)	
BL1917A2	598852
BL1918A1	598521
BL1919A2	598496
BL1921A1	598862
BL1922A1	598536
BL1923A2	598857
BL1924A2	598889
BL1925A2	598672
	601009
BL1926A4	541664
	598966
BL1927A3	598464
BL1928A3	598761
BL1929A2	598505
	598759
BL1930A2	598748
BL1931A2	598757
BL1932A2	598910
BL1933A2	598821
BL1934A2	598511
BL1935A2	598842
BL1936A3	598761
BL1937A3	598696
BL1938A4	598699
BL1939A2	598810
BL1941U2	598905
BL1942A2	598824
BL1945A2	541663
BL1951A4	598764
BL1952A4	598765
BL1953A2	598707
BL1954A2	598706
BL1955U2	598833
BL1956A2	598673
BL1957A4	601001
BL1958A3	601029
BL1959A2	598665
BL1960A2	598812
BL1961A2	598708
BL1965A4	598705
BL1966A1	598472
	598783
	601005
	601044
BL1967A4	598453
BL1968A3	598740
BL1969A4	598873
BL1970A3	598464
BL1971A1	598715
BL1972A3	598702
BL1973A4	598662
BL1974A2	598663
BL1975A3	598664
BL1976A4	598793
BL1977A2	598729
BL1979A2	598654



 	
FTE (.../...)	
BL1980A2	598823
BL1981A2	598868
BL1982A2	598867
BL1983A1	598518
BL1984A4	598704
BL1985A4	598704
BL1986A4	598795
BL1987A2	598728
BL1988A2	598802
BL1989A2	601034
BL1991A2	598779
BL1992A2	598845
BL1993A2	598863
BL1994A2	598940
BL1995A2	598946
	598967
BL1996A2	598709
BL1997A2	598770
BL2000U2	598920
BL2001A2	598700
BL2002A2	598703
BL2003A2	598885
BL2004A3	601029
BL2005A1	601030
BL2006A1	598657
BL2008A4	598741
BL2009A4	598742
BL2010A4	598825
BL2011A4	598876
BL2013A3	598727
BL2014A3	598727
BL2016A4	598804
BL2017A4	598426
	598913
BL2022A3	598892
BL2026A2	598995
BL2032U2	601032
BL2034U2	601033
BL2038A4	598701
BL2040A2	598898
BL2043A4	598816
BL2044A4	598818
BL2045A4	541736
BL2048A3	598935
BL2053A2	598942
BL2054A2	598941
BL2062A2	598738
BLF1418B1	598212
JURID	
2900109561	541641
2907604530	541664
2912104531	541662
2912114530	541717
2912309560	541705



 	
JURID (.../...)	
2916009560	541663
2935709560	541662
571202J	598405
571204J	598338
571205J	598088
	598099
	598187
	598584
	598941
571206D	598174
571206J	598111
	598174
	598193
571210J	598144
571210J-AS	598144
571212D	598392
571212J	598392
571213J	598050
	598099
	598113
	598187
	598270
571215D	598111
571215J	598111
571217J	598593
571217J-AS	598593
	598594
571218D	598193
571218J	598193
571218J-AS	598193
571219J	598145
571220J	598146
571221D	598099
571221J	598099
	598270
571222J	598099
	598375
571223J	598090
571224J	598077
	598078
	598085
571225J	598147
571226J	598088
571227J	598077
	598375
571228D	598178
571228J	598178
571232J	598099
571233J	598391
571234D	598337
571234J	598337
571236D	598106
	598111
571236J	598106
	598111
571243J	598085
	598142



 	
JURID (.../...)	
571244D	598165
571244J	598165
571245J	598375
	598777
571246J	598366
571246J-AS	598366
571247D	598168
571247J	598168
571248J	598375
571250D	598007
	598129
	598596
571250J	598007
	598129
	598596
571251J	598076
571252J	598592
571253J	598161
	598187
	598338
571254J	598113
571255D	598109
	598110
571255J	598109
	598110
571255J-AS	598109
	598110
571260J	598107
571261J	598107
571261J-AS	598107
571262D	598175
571262J	598077
	598085
	598175
571263J	598150
571264D	598148
	598292
571264J	598148
	598292
571264J-AS	598148
	598292
571265J	598389
571271D	598108
571271J	598108
571271J-AS	598108
571272D	598109
	598613
571272J	598109
	598613
571276D	598182
571276J	598182
571276J-AS	598182
571278D	598110
571278J	598110
571279D	598099
571279J	598099



 	
JURID (.../...)	
571284J	598168
571285J	598081
571286J	598162
571288J	598377
571288J-AS	598377
571291D	598166
	598171
	598212
	598334
571291J	598166
	598212
571294J	598116
571296J	598149
571297D	598091
	598093
	598219
571297J	598091
	598093
571298J	598168
571300J	598103
	598291
571300J-AS	598103
	598291
571301J	598094
	598125
	598133
	598141
	598142
	598219
571302D	598151
571302J	598151
571303J	598163
571304J	598153
571305J	598371
571306J	598086
571306J-AS	598086
571307J	598126
	598160
571308J	598169
	598217
571309D	598006
	598012
	598091
	598093
	598095
	598134
	598135
	598141
	598219
571309J	598006
	598012
	598091
	598093
	598095
	598134
	598135
	598141







 	
JURID (.../...)	
	598219
571312J	598167
571313J	598061
571314J	598130
571315D	598127
	598258
571315J	598127
	598258
571315J-AS	598127
	598258
571316D	598124
571316J	598124
571316J-AS	598124
571317D	598128
571317J	598128
571317J-AS	598128
571318J	598090
	598091
	598603
571319D	598119
571319J	598119
	598176
	598714
571320D	598176
571320J	598176
571321J	598007
	598374
571322J	598375
571323J	598375
571325J	598007
571327J	598084
571327J-AS	598002
	598084
571330D	598095
	598219
571330J	598095
	598219
571331D	598080
571331J	598080
571332D	598075
	598081
	598177
	598179
	598338
	598366
571332J	598081
	598177
	598179
571333D	598081
571333J	598081
571334D	598396
571334J	598158
	598396
571335J	598396
571335J-AS	598396
571336D	598032
	598166



 	
JURID (.../...)	
571336J	598032
571337D	598078
	598085
571337J	598078
	598085
571339D	598082
571339J	598082
571340J	598594
571340J-AS	598594
571341J	598126
	598130
	598160
571342J	598107
571344J	598105
571346J	598406
571347J	598135
571349J	598111
571349J-AS	598111
571350J	598125
	598142
571351D	598033
	598034
	598120
	598335
571351J	598033
	598034
	598120
	598335
	598630
571353D	598241
571353J	598241
571353J-AS	598241
571355D	598231
	598310
571355J	598231
	598310
571355J-AS	598231
	598310
571356D	598017
571356J	598017
571356J-AS	598017
571357D	598017
	598252
571357J	598017
	598252
571357J-AS	598017
	598252
571359D	598179
571359J	598179
571359J-AS	598179
571361D	598180
	598463
571361J	598180
	598463
571361J-AS	598180
	598463



 	
JURID (.../...)	
571362J	598090
	598603
571363J	598148
	598292
571364J	598003
571365J	598006
571366J	598294
571367D	598030
	598156
571367J	598030
	598156
	598181
571367J-AS	598030
	598156
571368J-AS	598112
571369J	598029
571370J	598222
	598257
571372D	598109
571372J	598109
571372J-AS	598109
571374J	598187
571375D	598205
	598214
571375J	598205
	598214
571375J-AS	598205
	598214
571376D	598004
	598016
571376J	598004
	598016
	598252
	598330
571376J-AS	598004
	598016
	598330
571379J	598007
	598129
	598132
	598596
571380D	598027
571380J	598027
571380J-AS	598027
571381J	598115
571382D	598315
571382J	598315
	598602
571382J-AS	598315
571384J	598099
	598113
571385J	598351
571386J	598131
571387D	598103
	598259
	598386

 	
JURID (.../...)	
571387J	598103
	598259
	598386
571387J-AS	598103
	598259
	598386
571388J	598272
571389J	598183
	598243
571390J	598183
	598243
571391D	598184
571391J	598039
	598184
571391J-AS	598184
571392J	598186
571392J-AS	598186
571393J	598138
571393J-AS	598138
571394J	598440
571395J	598753
571395J-AS	598039
	598502
571398D	598295
571398J	598295
571400J	598024
	598123
571401J	598118
571402J	598230
571402J-AS	598230
571404D	598221
571404J	598221
571405D	598154
	598353
571405J	598154
571406D	598714
571406J	598714
571407D	598253
571407J	598050
	598253
571408J	598121
	598240
	598312
571409J	598142
	598219
	598331
571410J	598008
	598289
571411J	598018
571412J	598043
	598171
571413J	598601
571413J-AS	598601
571414J	598015
571415J	598102
571416J	598598

 	
JURID (.../...)	
571417J	598270
	598338
	598621
571418J	598621
571419J	540436
571420J	598281
571421J	598057
571422J	598596
571424J	598595
571424J-AS	598595
571425D	598055
571425J	598055
571425J-AS	598055
571426D	598134
	598135
571426J	598134
	598135
571427J	598859
571428D	598291
571428J	598291
571429J	598103
	598187
571433J	598000
	598005
571435J	598272
571436J	598254
571437J	598019
	598022
571438J	598019
	598022
	598436
	598512
571439D	598129
	598498
571439J	598129
	598498
571440J	598497
571442J	598132
	598380
	598498
571444J	598132
	598380
571446J	540436
	598369
571447J	598596
	598598
571448D	598271
571448J	598271
571449D	598271
571449J	598271
571450J	598115
571452J	598133
571453J	598093
	598533
571454J	598093
	598531

 	
JURID (.../...)	
571455J	598093
571456D	598695
571456J	598695
571457D	598616
571457J	598616
571458J	598048
571460J	598025
	598048
571461J	598130
571462J	598016
	598125
	598142
571463D	598603
571463J	598603
571464J	598091
	598160
571465J	598237
	598269
571471J	598006
	598010
	598135
571472J	598010
	598985
571473D	598156
571473J	598030
	598156
571473J-AS	598156
571474J	598125
	598141
571475J	598094
571476D	598061
571476J	598061
571488J	598187
571488J-AS	598187
571491D	598128
	598205
571491J	598128
	598205
571491J-AS	598128
	598205
571492D	598039
	598356
571492J	598039
	598184
	598356
571492J-AS	598039
	598356
571493J	598256
571509D	598038
	598074
571509J	598038
	598074
571510J	598353
571510J-AS	598353
571511J	598085
	598382

 	
JURID (.../...)	
571512J	598483
571513J	598180
571513J-AS	598180
571514J	598600
571518J	598965
571519J	598491
571521J	598112
571521J-AS	598000
	598112
571522D	598033
	598034
	598619
571522J	598033
	598034
	598036
	598619
571523D	598011
571523J	598011
571524D	598075
	598181
571524J	598075
	598081
	598177
	598181
571525D	598181
571525J	598181
571525J-AS	598181
571526D	598002
	598084
571526J	598002
	598084
571527J	598103
	598386
571528D	598012
571528J	598012
571529J	598104
571530J	598050
571530J-AS	598050
571531J	598117
571532J	598374
571532J-AS	598374
571533D	598374
571533J	598374
571533J-AS	598374
571535J	598237
	598269
571535J-AS	598237
	598269
571536D	598212
571536J	598212
	598838
571539J	598182
571539J-AS	598182
571540D	598217
571540J	598217
571542J	598104

 	
JURID (.../...)	
571542J-AS	598104
571543J	598108
	598115
571545J	598103
571545J-AS	598103
571546J	598103
	598259
	598311
571546J-AS	598103
	598259
571549J	598116
571550J	598599
571555J-AS	598345
571559J-AS	598241
571560J-AS	598315
571722J	598617
571722J-AS	598617
571725J	598172
571725J-AS	598172
571726D	598172
571726J	598172
571726J-AS	598172
571733J	598280
571734J	598151
571736J	598294
571741J	598028
	598385
571743D	598155
571743J	598155
571744J	598396
571744J-AS	598396
571745D	598036
571745J	598036
571746D	598037
571746J	598037
571747D	598158
571747J	598158
571747J-AS	598158
571748J	598080
	598396
571748J-AS	598080
	598396
571749D	598012
	601021
571749J	598012
	601021
571752J	598294
571753J	598345
571754J	598035
571755D	598035
571755J	598035
571756J	598383
571757J	598031
571800J	598187
571803J	598497
571809J	598077







Valeo	
JURID (.../...)	
571816J	601016
571820J	598391
571827J	598623
571828D	598013
571828J	598013
571828J-AS	598013
571832D	598033
	598034
	598630
571832J	598033
	598034
	598619
	598630
571833D	598182
571833J	598182
571833J-AS	598182
571835J	598018
571837J	598502
571838J	598064
571838J-AS	598064
571839D	598070
571839J	598070
571840D	598800
571840J	598800
571843J	598073
571844J	598044
571844J-AS	598044
571845J	598062
571845J-AS	598062
571846J	598045
571846J-AS	598045
571847D	598622
571847J-AS	598622
571848D	598258
571848J	598258
571849J	598033
	598034
	598120
571850J	598240
571851J	598630
571855J	598121
	598240
	598312
571856J	598303
	598982
571861J	598351
571862J	598095
571864J	598399
571867J	598081
	598177
571868J	598241
571872J	598712
571872J-AS	598712
571873J	598412
571873J-AS	598412
571875J	598482



Valeo	
JURID (.../...)	
571875J-AS	598482
571876J	598636
571876J-AS	598636
571877J	598357
571877J-AS	598357
571880J	598231
	598310
	598409
571880J-AS	598310
571882J	598040
	598483
571883J	598041
571884J	598065
	598308
571887J	598040
571888J	598065
571890J	598363
571891J	598362
571892J	598364
571893J	598012
571894J	598985
571895J	598591
571896J	598207
571897D	598068
571897J	598068
571898D	598069
571898J	598069
571899D	598063
571899J	598063
571900J	598048
	598067
	598303
571902J	598038
	598074
571902J-AS	598038
	598074
571903J	598385
571904J	598353
571904J-AS	598353
571905J	598010
	598219
571906D	598180
	598463
571906J	598180
	598463
571907J	598145
571908J	598581
571910J	598044
	598046
571910J-AS	598044
	598046
571911D	598075
	598081
571911J	598075
	598081
571912J	598156
	598360



Valeo	
JURID (.../...)	
571913J	598043
	598171
571914J	598212
571915D	598066
571915J	598066
	598128
571916J	601019
571917J	598423
	601019
571918J	598580
571918J-AS	598259
	598580
571919D	598326
571919J	598326
571919J-AS	598326
571920J	598305
571921J	598355
571922J	598470
571922J-AS	598470
571923J	598488
571924J	598039
	598356
571925J	598444
571925J-AS	598444
571929J	598332
571931J	598726
571931J-AS	598726
571932J	598490
571932J-AS	598490
571933D	598880
571933J	598880
571934J	598675
571935J	598303
571936J	598311
571937J	598441
571938J	598903
571939D	598403
571939J	598403
571940J	598318
571941J	598319
571942J	598320
571943J	598844
571944J	598549
571944J-AS	598549
571945J	598549
571945J-AS	598549
571946J	598299
571947J	598301
571947J-AS	598301
571948J	598048
571949J	598605
571950J	598300
571950J-AS	598300
571951J	598308
571952J	598772
571954D	598461

Valeo	
JURID (.../...)	
571954J	598461
571954J-AS	598461
571955J	598017
571959D	598018
571959J	598018
571959J-AS	598018
571960J	598753
571960J-AS	598753
571961J-AS	541655
	598445
571962J-AS	598446
571963J	598328
571964D	598399
571964J	598399
571965J	598462
571966J	598398
571967D	598317
571967J	598317
571968J	598322
571969J	598330
571971D	598408
571971J	598408
571972J	598605
	598607
571973J	601003
571974J	598424
571975J	598454
	598860
571976D	598022
571976J	598022
571977D	598053
571977J	598053
571979D	598142
	598331
571979J	598331
571980D	598632
571980J	598632
571981J	598453
571981J-AS	598453
571982D	598483
	598751
571982J	598483
	598751
571984J	598486
571985J	598332
571986J	598448
571986J-AS	598448
571987J	598448
571987J-AS	598448
571988J	598447
571988J-AS	598447
571989J	598637
571989J-AS	598637
571990J	598410
571990J-AS	598410
571991J	598820



 	
JURID (.../...)	
571991J-AS	598820
571992J	598413
571992J-AS	598413
571994J	598811
571994J-AS	598811
571995J	598329
571996D	598563
571996J	598563
571997J	598305
	598475
571998D	598431
571998J	598431
571999J	598466
572100J	598268
572127J	598817
572129J	598817
572134J	598437
572135J	598053
572136J	598053
572137J	598053
572138J	598627
	598682
	598911
572140J	598897
572144J	598293
572145J	598274
	598293
572146J	598274
	598646
572149J	598612
572154J	598826
572155J	598826
572159J	598964
572161J	598290
572162J	598624
572163J	598624
	598835
572166J	598023
572169J	598780
	598846
572175J	598983
572178J	598921
572179J	598532
	598666
572180J	598131
572182J	598540
	598984
572186J	598519
	598834
	598866
572188J	598540
	598984
572189J	598384
572193J	598266
	598780
572197J	598828



 	
JURID (.../...)	
572200J	598519
572206J	598278
	598379
572207J	598278
572209J	598224
572210J	598628
572216J	598220
572217J	598986
572221J	598507
572226J	598021
	598023
572227J	598020
572229J	598208
572230J	598123
	598379
572232J	598379
572233J	598123
	598379
572236J	598296
572237J	598047
572238J	598047
572245J	598777
572247J	598533
572250J	598185
572253J	598393
572255J	598266
	598402
	598551
	598815
572256J	598266
	598551
572257J	598014
572258J	598615
572260J	601022
572266J	598266
572268J	598052
572269J	598052
	598817
572271J	598020
572272J	598020
572275J	598476
	598691
572276J	598021
572280J	598597
572281J	598220
	598597
572284J	598047
	598248
572290J	598851
572293J	598627
572295J	598220
	598620
	598626
572299J	598620
572304J	598496
572309J	598047
	598056



 	
JURID (.../...)	
	598227
572310J	598054
572311J	598227
572312J	598112
	598123
572313J	598123
572317J	598250
572319J	598239
572320J	598239
572322J	598507
572323J	598532
572324J	598495
572325J	598629
572326J	598614
572327J	598815
572329J	598248
572330J	598022
	598047
	598056
	598248
572333J	598551
572336J	598250
572339J	598786
572340J	598494
572342J	598496
572343J	598786
572345J	598786
	598787
572346J	598787
572347J	598051
	598574
	598786
572348J	598460
572349J	598788
572350J	598056
	598627
572354J	598627
572355J	598402
572357J	598809
572360J	598122
572361J	598122
	598123
572362J	598122
572364J	601023
572365J	598947
572367J	598947
572370J	598517
	598597
	601020
572373J	598123
	598618
572375J	598626
572376J	598668
	598826
572377J	598691
572381J	598625



 	
JURID (.../...)	
572382J	598602
572388J	598989
572393J	598056
	598627
572394J	598897
572396J	598071
572397J	598840
572398J	598449
572399J	598830
572400J	598478
572401J	598575
572402J	598316
572404J	598606
572405J	598737
572406J	598902
572407J	598361
	598902
572409J	598850
572411J	598634
572416J	598528
572417J	598854
572418J	598991
572419J	598522
572420J	598534
572422J	598450
572423J	598530
572424J	598895
572428J	598451
572428J-AS	598451
572429J	598436
572429J-AS	598436
572430J	598022
572432J	598907
572433J	598697
572434J	598629
572437J	598548
572442J	598908
572447J	601020
572448J	598524
572449J	598887
572450J	598577
572453J	598505
	598759
572464J	598435
572464J-AS	598435
572466J	598452
572468J	598579
572471J	598733
	598832
572473J	598437
572478J	598758
572480J	598824
572480J-AS	598824
572481J	598653
572485J	598665
572487J	598536







  Valeo	
JURID (.../...)	
572488J	598673
572490J	598780
572491J	598679
572494J	598762
572495J	598523
572496J	598574
572497J	598518
572498J	598520
572499J	598521
572500J	598855
572501J	598672
572502J	598745
572504J	598757
572507J	598658
572508J	598919
572510J	598736
572512J	598542
572513J	598781
572514J	598744
572515J	598857
	601023
572516J	598812
572517J	598827
572519J	598778
572520J	598810
572521J	598741
572522J	598742
572526J	598707
572528J	598535
	598777
572529J	598875
572532J	598821
572533J	598589
572534J	598504
572536J	598511
572537J	598784
572539J	598644
572540J	598506
572541J	598806
572543J	598579
572544J	601043
572545J	598848
572546J	598541
572547J	598852
572548J	598865
572549J	598823
572550J	598853
572551J	598889
572552J	598883
572553J	598862
572554J	598710
572556J	598841
572557J	598748
572558J	598914
572560J	598910
572564J	541733



  Valeo	
JURID (.../...)	
572565J	598856
572566J	598915
572568J	598642
572569J	601037
572570J	598942
572574J	598893
572575J	598738
572576J	601026
572577J	598842
572578J	598896
572579J	598803
572580J	598849
573000J	598467
573000J-AS	598467
573001J	598468
573002J	598409
573002J-AS	598409
573003J	598479
573003J-AS	598479
573004J	598420
573005J	598180
573006J	598484
573007J	598180
	598463
573008J	598473
573009J	598457
573010J	598926
573011J	598456
573012J	598434
573013J	598433
573014J	598407
573015J	598432
573016J	598566
573017J	598471
573018J	598472
	598783
	598425
573019J	598425
573020J	598433
573021J	598480
573022J	598489
573023J	598439
573023J-AS	598439
573025J	598471
573026J	598417
573027J	598419
573028J	598418
573029J	598416
573030J	598464
573030J-AS	598464
573031J	598465
573032J	598180
	598463
573033J	598543
573034J	598442
573035J	598443
573036J	598462



  Valeo	
JURID (.../...)	
573036J-AS	598462
573037J	598483
	598751
573038J	598650
	598681
573039J	598493
573040J	598735
573041J	598564
573042J	598065
	598308
	598990
573043J	598766
573044J	598768
573045J	598801
	598858
573046J	598807
573046J-AS	598807
573047J	598565
573047J-AS	598565
573048J	598650
573049J	598482
	598650
573050J	598814
573051J	598461
573052J	598481
573053J	598763
573055J	598538
573056J	598643
573058J	598545
573058J-AS	598545
573059J	598546
573060J	598429
573061J	598430
573062J	598459
573063J	598458
573064J	598483
	598992
573065J	598681
573066J	598460
	598661
573067J	598499
573068J	598762
573069J	598965
573071J	598556
573072J	598556
573074D	598426
573074J	598426
573075D	598427
573075J	598427
573076D	598428
573076J	598428
573077J	598510
573078J	598677
573079J	598988
573080J	598411
573081J	598586

  Valeo	
JURID (.../...)	
573082J	598583
573083J	598500
573084J	598501
573085J	598639
573086J	598658
573089D	598678
	598860
573089J	598678
	598860
573090J	598808
573091J	598638
573092J	598659
573092J-AS	598445
	598659
573093J	598444
573093J-AS	598444
573094J	598424
573095J	598470
573095J-AS	598470
573096J	598553
573097J	598468
573098J	598463
573099J	598669
573099J-AS	598669
573100J	598582
573101J	598667
573102J	598514
573105J	598633
573106J	598676
573107J	598537
573109J	601019
573110D	598547
573110J	598547
573111J	598805
573112J	598674
573113J	598568
573114J	598569
573115D	598570
573115J	598570
573116J	601001
573117J	601029
573118J	598756
573119J	598415
573120J	598434
573122J	598584
573123J	598557
573124J	598558
573125J	598641
573126J	598734
573127J	598720
573128J-AS	598635
573131J-AS	598663
573132J-AS	598662
573133J-AS	598664
573134J-AS	598715
573135J-AS	598718



 	
JURID (.../...)	
573136J-AS	598701
573137J-AS	598699
573138J-AS	598700
573139J	598703
573139J-AS	598703
573142J-AS	601030
573143J-AS	598657
573144J	598761
573145J	598750
573146J	598305
	598475
573147J	598719
573148J	598813
573151J	598640
573151J-AS	598640
573152J-AS	598659
573153J	598860
573158J	598752
573159J-AS	598651
573160J-AS	598652
573161J-AS	598811
573164J	598426
573165J	598721
573166J	598722
573168J	598696
573169J	598012
573170J	598913
573171J	598698
573172J	598670
573173J	598729
573174J	598585
573175J-AS	598728
573177J-AS	601034
573178J-AS	598995
573179J-AS	601007
573181J-AS	601027
573183J-AS	598464
573184J-AS	598465
573186J	598472
	598783
	601005
	601044
573188J-AS	598640
573189J-AS	598410
573190J-AS	598044
573192J	598997
573193J	598998
573194J	598936
573196J	598779
	598845
573197J	598863
573198J	598779
573199J	598822
573201J-AS	598879
573202J	598802
573203J	598512



 	
JURID (.../...)	
573204J	598825
573206J	598489
	598801
573207J-AS	598845
573209J	598649
573210J-AS	598898
573211J	601031
573212J	598633
573214J	598035
573216J	598874
573217J	598793
573218J	598740
573219J	601004
573220J	598671
573221J	598764
573222J	598765
573224J	598754
573226J	598704
573227J	598770
573228J	598411
573229J	598768
573230J	598795
573234J	598925
573235J	598702
573236J	598829
573238J	598415
573250J	598928
573252J	601029
573253J	598861
573256J	598438
573266J	601015
573267J	598987
573272J	601011
MGA	
100	601016
102	598391
103	598129
106	598168
109	598165
11	598111
112	598076
115	598160
116	598113
117	598161
	598338
118	598366
119	598168
12	598099
	598187
120	598148
122	598377
123	598150
126	598592
128	598091
	598093



 	
MGA (.../...)	
129	598219
13	598099
	598187
130	598182
132	598613
136	598375
138	598107
139	598187
140	598107
141	598187
142	598108
144	598389
146	598175
147	598162
148	598117
149	598116
150	598149
151	598090
152	598144
153	598124
154	598128
155	598374
156	598212
157	598166
	598168
	598171
	598334
159	598123
	598379
161	598153
162	598163
164	598151
166	598375
167	598612
168	598391
17	598392
170	598016
	598125
171	598217
172	598169
173	598168
175	598205
176	598093
	598133
177	598129
178	598091
	598219
179	598125
	598141
180	598241
181	598105
182	598110
184	598141
	598219
185	598127
186	598126



 	
MGA (.../...)	
187	598130
188	598113
189	598351
190	598167
191	598066
	598124
192	598128
193	598118
194	598075
	598081
	598177
195	598104
196	598103
197	598115
198	598093
20	598161
	598338
201	598119
	598714
202	598080
204	598185
205	598257
206	598221
207	598315
208	598120
	598335
209	598121
	598240
21	598614
210	598002
	598061
211	598146
212	598396
213	598082
214	598086
215	598030
	598156
216	598007
217	598032
	598166
218	598594
219	598081
	598177
220	598176
221	598138
222	598179
223	598180
	598463
224	598095
225	598406
227	598134
229	598214
231	598291
232	598293
233	598239
234	598250







	
MGA (.../...)	
235	598029
236	598231
	598310
237	598103
	598259
	598502
238	598278
239	598266
	598402
240	598294
241	598008
	598289
242	598292
243	598135
244	598271
245	598142
246	598183
247	598183
	598243
248	598184
249	598062
	598295
250	598491
	598595
251	598131
252	598047
253	598248
254	598052
259	598620
260	598224
261	598220
262	598384
263	598296
264	598122
266	598921
269	598613
271	598185
274	598043
275	598227
277	598172
278	598123
279	598597
280	598003
281	598010
	598985
282	598155
	598181
283	598018
284	598025
285	598154
286	598254
287	598024
288	598054
289	598057
29	598363
290	598075
	598155



	
MGA (.../...)	
	598181
291	598055
292	598815
293	598156
294	598019
295	598028
	598280
296	598015
297	598028
298	598695
3	598603
302	598006
303	598022
	598436
304	598000
	598005
305	598053
306	598382
307	598714
308	598061
309	598039
	598356
310	598281
311	598027
	598106
312	598274
313	598017
314	598004
	598016
	598017
	598252
315	598034
317	598033
	598619
318	598625
319	598011
	598012
320	598080
	598396
321	598158
322	598038
323	598230
324	598120
325	598002
	598084
326	601021
327	598180
328	598240
	598312
33	598174
	598193
330	598035
331	598031
332	598383
333	598179
	598353



	
MGA (.../...)	
334	598496
335	598599
336	598070
337	598800
338	598064
339	598787
340	598602
342	598495
	598760
343	598494
345	598014
346	598491
347	598013
348	598600
349	598036
35	598178
350	598037
351	598073
352	598067
354	598043
355	598040
356	598068
357	598065
	598308
	598880
358	598069
359	598318
	598493
36	598144
361	598498
364	598622
365	598071
366	598449
367	598319
368	598044
369	598266
	598402
370	598385
371	598048
372	598617
373	598642
374	598250
375	598551
	598579
376	598051
	598786
377	598393
	598897
378	598627
379	598056
38	598362
380	598682
	598911
381	598616
382	598338
384	598020

	
MGA (.../...)	
385	598066
	598128
386	598488
388	598357
389	598636
390	598626
391	598326
392	598360
393	598135
	598677
394	598065
395	601019
396	598424
397	598180
	598463
398	598399
399	598212
400	598630
402	598629
403	598305
404	598303
	598486
405	598454
406	598322
407	598332
408	598345
409	598253
410	598272
411	598045
412	598112
413	598227
414	598788
415	598184
416	598256
417	598183
418	598303
	598355
419	598483
	598750
	598751
420	598050
421	598646
422	598786
423	598258
424	598332
425	598461
426	598726
427	598074
428	598063
429	598470
430	598490
431	598311
432	598386
434	598830
435	598809
436	598540
	598810



 	
MGA (.../...)	
	598984
437	598052
438	598623
439	598497
44	598364
440	598499
441	598458
442	598328
443	598926
444	598420
445	598581
446	598330
447	598017
	598484
448	598675
449	598290
45	598146
451	598046
452	598763
453	598549
454	598310
455	598065
	598985
456	598050
	598460
457	598482
	598675
459	598762
460	598441
461	598331
462	598478
463	598534
464	598668
	598826
466	598517
	601020
467	598519
	598834
468	598519
469	598844
	598964
470	598320
471	598777
472	598507
473	598838
474	598915
475	598828
476	598530
477	598403
478	598018
479	598753
480	598317
481	598431
482	598316
483	598361
484	598065
	598309



 	
MGA (.../...)	
	598772
486	598476
	598691
487	598408
488	598456
489	598575
490	598424
491	598780
492	598437
493	598464
494	598412
495	598486
496	598629
498	598355
499	598607
	601003
500	598726
501	598926
502	598450
503	598535
504	598865
505	598843
506	598524
507	598735
508	598616
509	598425
51	598193
510	598407
	598570
511	598504
512	598510
513	598511
514	598543
515	598947
516	598528
517	598854
518	598299
519	598301
520	598300
521	598676
	598858
522	598650
523	598432
524	598903
525	598418
526	598624
527	598466
528	598305
	598475
530	598166
	598334
531	598416
	598419
533	598308
534	598436
535	598758



 	
MGA (.../...)	
536	598409
537	598479
538	598480
540	598606
541	598548
542	598444
543	598447
544	598632
545	598448
546	598564
547	598563
548	598605
549	598460
	598661
550	598435
551	598462
552	598453
553	598433
554	598434
555	598737
556	598471
557	598472
558	598468
559	598465
56	598371
560	598473
561	598461
562	598484
563	598500
564	598501
565	598427
	598722
566	598426
567	598413
568	598719
569	598531
57	598375
570	598131
	598666
571	598691
572	598532
573	598270
	598338
	598621
574	598674
575	598463
576	598681
577	598817
578	598621
579	601002
58	598106
580	598574
	598781
581	598269
582	598627
584	598601



 	
MGA (.../...)	
585	598103
586	598580
587	598411
588	598807
589	598489
590	598481
591	598751
592	598518
593	598515
595	598910
597	598836
598	598835
599	598814
60	598337
600	598544
601	598429
	598430
602	598430
603	598546
604	598697
605	598412
606	598712
607	598523
609	541664
	598966
611	598398
612	598902
613	598841
614	598582
615	541662
616	598579
617	598452
618	598442
619	598443
620	598813
622	598908
624	598734
625	598856
626	598858
627	598733
	598832
628	598462
629	598895
630	598907
631	598577
632	598827
633	598748
634	598748
635	598760
	598887
636	598834
	598866
638	598992
640	598482
641	598650
642	541655
	598445







	
MGA (.../...)	
643	598446
644	598505
	598759
645	598506
646	598547
647	598456
648	598720
649	598527
65	598077
	598085
652	598520
654	598415
655	598755
656	598536
657	598583
658	598537
659	598542
66	598085
660	598821
661	598514
662	598679
663	598417
664	598538
665	598545
666	598669
668	598565
669	598673
671	598521
672	598410
673	598428
674	598633
675	598643
676	598680
677	598848
678	598672
680	601029
681	601001
682	598553
683	598678
684	598757
	598824
685	598853
686	598541
687	598584
688	598569
689	598568
690	598566
691	598917
692	598558
693	598558
694	598557
695	598639
696	598820
697	598570
698	598811
699	598641



	
MGA (.../...)	
7	598207
700	598638
701	598471
702	598736
703	598545
704	598422
	601017
705	598424
706	598467
707	598217
708	598509
71	598145
710	598649
711	598829
712	598654
713	598990
714	598463
	598752
715	598860
717	598667
718	598658
719	598665
72	598146
720	598635
721	598647
723	598653
724	598708
725	598644
726	598464
727	598715
	598892
729	598795
730	598012
731	598696
732	598662
733	598663
734	598664
735	598805
736	598761
737	598640
739	598652
740	598671
741	598842
742	598823
743	601030
744	598756
746	598845
747	598707
75	598109
750	598702
752	598706
755	598772
757	598779
758	598754
76	598099
760	598874



	
MGA (.../...)	
761	598870
762	598793
763	541717
764	541705
765	601003
766	598643
767	598824
768	598822
769	598781
77	598099
770	598748
771	598744
772	598705
773	598919
774	598912
776	598738
777	598808
778	601004
779	598655
780	598656
781	598770
785	598861
786	598453
789	598852
790	598833
791	598778
793	598699
794	598701
795	598700
796	598703
797	598940
798	598847
799	598657
8	598208
801	598967
802	598740
803	598741
805	598618
806	598783
807	598739
808	598889
809	598868
810	598867
811	598872
812	598878
813	598875
814	598885
815	598849
816	601044
817	598361
819	598744
821	598920
823	598738
824	598727
826	598729
827	598730

	
MGA (.../...)	
829	598746
831	598745
834	601043
837	598722
839	598804
840	541683
841	601020
842	598702
843	598892
844	598879
847	598891
848	598877
849	598839
850	598825
851	598882
852	541728
854	601031
855	598816
856	598818
857	541736
858	598994
859	598750
861	598035
863	598928
864	601007
865	598935
868	598997
869	598803
870	598871
873	598898
875	598318
878	598899
879	598925
880	601026
883	541733
885	598942
886	598941
887	601039
890	601028
891	541735
895	601015
896	598987
897	598901
900	598932
901	598993
902	601012
903	598752
904	598855
905	598934
907	598893
909	598895
	598929
910	598651
911	601010
915	598927
918	598937



 	
MGA (.../...)	
921	601038
922	598894
924	598946
928	601041
931	598996
934	598888
936	541737
937	541738
938	598738
94	598593
940	601011
943	598678
944	598801
945	598914
949	598634
954	601009
96	598108
960	601042
961	598999
964	541734
965	601045
966	601000
97	598375
98	598147
99	598148
MINTEX	
MDB1002	598099
	598113
	598187
	598270
MDB1003	598111
	598183
	598256
MDB1004	598187
MDB1005	598106
	598180
MDB1008	598088
MDB1012	598088
	598099
	598187
	598584
MDB1013	598090
	598603
MDB1027	598078
	598085
	598146
MDB1029	598144
MDB1035	601016
MDB1058	598077
MDB1065	598085
MDB1068	598099
MDB1072	598351
MDB1074	598405
MDB1076	598145



 	
MINTEX (.../...)	
MDB1077	598146
MDB1081	598099
MDB1083	598099
MDB1086	598593
	598594
MDB1087	598090
	598219
MDB1088	598094
	598125
	598141
MDB1096	598363
MDB1099	598108
MDB1101	598147
MDB1102	598375
MDB1103	598077
	598174
	598375
MDB1104	598375
MDB1108	598178
	598193
MDB1109	598110
MDB1110	598165
MDB1111	598086
	598366
MDB1112	598081
MDB1114	598109
MDB1115	598107
MDB1116	598187
MDB1118	598076
	598377
MDB1120	598148
	598292
MDB1121	598107
MDB1129	598364
MDB1134	598113
MDB1135	598207
MDB1138	598620
MDB1139	598897
	598921
MDB1141	598182
	598184
MDB1142	598592
MDB1143	598366
MDB1144	598614
	598947
MDB1145	598815
MDB1146	598161
	598338
MDB1150	598205
MDB1151	598077
	598085
MDB1153	598108
MDB1155	598150
MDB1156	598389
MDB1162	598122
MDB1169	598124



 	
MINTEX (.../...)	
MDB1171	598162
MDB1172	598377
MDB1174	598166
	598334
MDB1175	598166
	598212
MDB1176	598166
	598591
MDB1177	598145
MDB1180	598109
	598110
MDB1181	598144
MDB1183	598123
	598379
MDB1184	598185
MDB1185	598208
MDB1186	598220
MDB1188	598612
MDB1189	598091
	598093
	598531
	598603
MDB1190	598017
MDB1191	598125
	598142
MDB1192	598111
	598174
	598193
MDB1194	598117
MDB1196	598163
MDB1203	598090
MDB1204	598122
MDB1205	598153
MDB1206	598149
MDB1207	598278
	598296
MDB1209	598151
MDB1211	598169
MDB1212	598217
MDB1214	598002
	598084
MDB1215	598081
MDB1217	598214
MDB1218	598090
	598091
	598219
MDB1219	598384
MDB1220	598817
MDB1221	598105
MDB1222	598105
	598272
	598601
MDB1224	598118
MDB1225	598167
MDB1228	598130
	598160



 	
MINTEX (.../...)	
MDB1229	598221
MDB1230	598104
MDB1235	598111
MDB1236	598120
	598172
	598335
MDB1237	598220
	598224
	598626
MDB1239	598103
MDB1240	598093
	598095
	598141
	598219
MDB1241	598047
	598052
MDB1243	598047
	598248
	598495
MDB1244	598131
MDB1245	598613
MDB1250	598266
MDB1251	598266
	598402
	598551
	598815
MDB1253	598004
MDB1256	598371
MDB1257	598219
MDB1258	598094
	598125
	598141
MDB1259	598047
	598052
	598131
MDB1261	598208
MDB1262	598239
MDB1266	598124
	598128
MDB1267	598127
	598128
MDB1273	598127
	598258
MDB1274	598113
MDB1276	598093
	598133
	598219
MDB1278	598093
	598133
	598219
MDB1279	598123
MDB1280	598123
MDB1282	598224
MDB1286	598121
	598240
	598312







 	
MINTEX (.../...)	
MDB1287	598121 598240
MDB1290	598120 598335
MDB1291	598002 598075 598081 598177 598181 598338 598366
MDB1293	598017
MDB1298	598052
MDB1299	598130
MDB1300	598176
MDB1301	598115
MDB1304	598375
MDB1307	598007 598374
MDB1309	598141 598142 598219 598331
MDB1312	598315
MDB1313	598964
MDB1315	598077 598085 598175
MDB1316	598002 598061 598294
MDB1318	598021
MDB1325	598983
MDB1326	598983 598984
MDB1327	598119 598176 598714
MDB1331	598080
MDB1332	598131
MDB1333	598086 598158
MDB1334	598402 598614 598947
MDB1339	598158 598396
MDB1340	598369
MDB1341	598032 598166
MDB1342	598227
MDB1344	598248
MDB1348	598293
MDB1350	598780
MDB1353	598406
MDB1355	598082



 	
MINTEX (.../...)	
MDB1356	598000 598126 598160
MDB1357	598126 598130
MDB1360	598053
MDB1362	598027 598106
MDB1367	540436 598138 598369
MDB1369	598103 598259 598311
MDB1371	598017
MDB1372	598618
MDB1373	598003
MDB1374	598248
MDB1376	598179 598353
MDB1377	598180 598463 598681
MDB1378	598239
MDB1380	598123
MDB1382	598180 598463
MDB1384	598095
MDB1385	598253
MDB1386	598039 598184
MDB1387	598138
MDB1388	598138 598153
MDB1389	598296
MDB1390	598102
MDB1391	598006 598135
MDB1392	598230
MDB1393	598231
MDB1395	598268 598274
MDB1396	598826
MDB1397	598615
MDB1398	598947
MDB1400	598266
MDB1401	598499
MDB1402	598241
MDB1403	598289
MDB1404	598043 598171
MDB1405	598122
MDB1406	598266
MDB1407	598619
MDB1408	598296
MDB1409	598019 598022



 	
MINTEX (.../...)	
MDB1411	598053
MDB1412	598186
MDB1414	598624
MDB1415	598257
MDB1417	598051 598786
MDB1419	598254
MDB1421	598020
MDB1423	598054
MDB1425	598292
MDB1426	598029
MDB1430	598271
MDB1431	598052
MDB1436	598315
MDB1437	598315
MDB1438	598846
MDB1441	598063 598250
MDB1442	598063 598295
MDB1443	598024
MDB1445	598055 598080 598085
MDB1446	598220 598597
MDB1447	598597 598620
MDB1449	598590
MDB1450	598817
MDB1451	598787
MDB1452	598851
MDB1454	598294
MDB1455	598111 598256
MDB1459	598291
MDB1460	598269
MDB1464	598023
MDB1465	598496
MDB1466	598015
MDB1467	598621
MDB1470	598613
MDB1471	598086
MDB1474	598666
MDB1475	598384
MDB1476	598846
MDB1479	598594
MDB1481	598519 598834
MDB1482	598123 598618
MDB1483	598030 598156
MDB1484	598135
MDB1485	598230
MDB1488	598051 598574

 	
MINTEX (.../...)	
MDB1489	598786 598057
MDB1491	598133 598134 598135
MDB1492	598107
MDB1493	598172
MDB1495	598626
MDB1496	598691
MDB1497	598828
MDB1501	598601 598668
MDB1502	598628
MDB1503	598601
MDB1504	598815
MDB1505	598135
MDB1506	598039 598502
MDB1507	598052 598817
MDB1509	598625
MDB1510	598627 598788
MDB1511	598000 598005 598142
MDB1513	598271
MDB1514	598614
MDB1516	598440
MDB1518	598010
MDB1519	598075 598081 598155 598181
MDB1520	598154 598353
MDB1521	598362
MDB1523	598595
MDB1524	598007 598139 598374
MDB1526	598028 598294
MDB1527	598280
MDB1528	598091 598093
MDB1530	598274 598646 601018
MDB1531	598751 598992
MDB1532	598695
MDB1533	598788
MDB1535	598897
MDB1537	598025 598048



 	
MINTEX (.../...)	
MDB1538	598018
MDB1539	598517
	601020
MDB1540	598256
MDB1542	598237
	598269
MDB1543	598627
MDB1545	598496
MDB1547	598496
MDB1548	598826
MDB1549	598291
MDB1552	598103
	598411
	598580
MDB1555	598623
MDB1556	598039
	598184
	598356
MDB1557	598030
	598156
	598360
MDB1558	598036
	598345
MDB1559	598037
MDB1560	598345
MDB1561	598369
	598598
MDB1563	598025
	598048
MDB1564	598642
	598682
	598911
MDB1565	598272
MDB1569	598642
MDB1570	598004
	598016
MDB1571	598017
	598252
	598982
MDB1572	598259
	598386
MDB1573	601021
MDB1574	598921
MDB1575	598646
MDB1578	598551
MDB1582	598250
MDB1585	598613
MDB1587	598532
MDB1588	598035
MDB1589	598056
	598227
	598627
MDB1590	598840
MDB1603	598556
MDB1605	598379
MDB1606	598219



 	
MINTEX (.../...)	
MDB1607	598620
MDB1610	598494
MDB1611	598714
MDB1612	598281
MDB1613	598061
MDB1614	598616
MDB1615	598047
	598495
	598760
MDB1616	598053
	598437
	598911
MDB1617	598113
MDB1618	598115
MDB1620	598034
MDB1622	598033
MDB1623	598014
MDB1625	598601
MDB1627	598617
MDB1628	598002
MDB1629	598031
MDB1630	598383
MDB1631	598382
MDB1632	598982
MDB1633	598859
MDB1635	598056
	598627
MDB1637	598630
MDB1638	598695
MDB1639	598312
MDB1640	598013
MDB1641	598120
MDB1642	598013
	598357
MDB1644	598596
MDB1645	598762
MDB1646	598519
MDB1647	598393
	598897
MDB1649	598000
MDB1651	598183
	598243
MDB1652	598353
MDB1654	598022
MDB1657	598602
MDB1658	598551
	598579
	598809
MDB1659	598022
MDB1662	598038
	598074
MDB1663	598599
MDB1666	598011
	598012
MDB1668	598080
	598396



 	
MINTEX (.../...)	
MDB1673	598903
MDB1676	598080
MDB1677	598158
	598396
MDB1678	598250
	598629
MDB1680	598290
MDB1682	598622
	598814
MDB1683	598050
MDB1684	598809
MDB1685	598460
MDB1686	598836
MDB1687	601024
MDB1688	598476
	598691
MDB1690	598533
MDB1691	598844
MDB1695	598393
MDB1696	598777
MDB1698	598507
MDB1699	598129
	598132
MDB1700	598982
MDB1701	598441
MDB1702	598064
MDB1703	598070
MDB1704	598800
MDB1705	598835
MDB1706	598008
MDB1707	598668
	598826
MDB1708	601023
MDB1710	601022
	601025
MDB1717	598985
MDB1718	598600
MDB1720	598628
MDB1721	598374
MDB1722	598626
MDB1723	598338
MDB1725	598614
MDB1726	598320
MDB1727	598318
MDB1729	598001
MDB1730	540436
	598369
MDB1731	598068
MDB1732	598069
	598467
MDB1733	598040
	598607
MDB1734	598041
	601003
MDB1735	598065
	598308
	598990



 	
MINTEX (.../...)	
MDB1736	598357
MDB1737	598045
MDB1738	598046
MDB1739	598044
MDB1740	598830
MDB1741	598067
	598303
	598355
	598481
MDB1742	598142
	598581
MDB1745	598412
MDB1746	598712
MDB1747	598838
MDB1748	598476
MDB1749	598523
MDB1750	598534
MDB1754	598989
MDB1760	598071
MDB1762	598634
MDB1769	598491
MDB1773	598965
MDB1774	598595
MDB1783	598556
MDB1784	598904
MDB1785	598603
MDB1786	598906
MDB1793	598258
MDB1794	598530
MDB1802	541664
	598966
MDB1804	598066
MDB1805	598488
MDB1806	598360
MDB1807	598075
	598181
MDB1808	598038
	598074
MDB1810	598630
MDB1811	598332
MDB1812	598326
MDB1813	598305
MDB1814	598675
MDB1815	598073
MDB1817	598310
	598409
MDB1818	598450
MDB1822	598048
MDB1823	598522
MDB1824	598458
MDB1825	598459
MDB1826	598125
	598483
	598750
	598751
MDB1827	598528
	598988







 	
MINTEX (.../...)	
MDB1828	598040
MDB1829	598040
	598041
	598065
MDB1830	598515
MDB1831	598319
MDB1832	598449
MDB1834	598063
MDB1837	598461
MDB1841	598519
	598834
MDB1842	598172
	598399
MDB1844	598806
	601002
MDB1845	598518
MDB1846	598393
MDB1854	598385
MDB1855	598062
MDB1858	598763
MDB1859	598919
MDB1862	598850
MDB1863	598122
MDB1866	598682
MDB1868	598330
MDB1869	598179
	598353
MDB1871	598636
MDB1872	598403
MDB1873	598766
MDB1874	598768
MDB1876	598142
	598331
MDB1877	598988
MDB1878	598281
MDB1879	598311
	598753
MDB1880	598965
MDB1881	598207
MDB1882	598466
MDB1883	598212
MDB1884	598043
	598171
MDB1888	598311
	598386
	598753
MDB1889	598184
MDB1892	598478
MDB1893	598835
MDB1895	598619
MDB1897	598579
MDB1899	598902
MDB1900	598361
MDB1901	598018
MDB1902	598524
MDB1903	598908



 	
MINTEX (.../...)	
MDB1905	598865
MDB1906	598535
	598777
MDB1907	598454
MDB1908	598322
MDB1909	598018
	598496
MDB1910	598856
MDB1911	598351
MDB1912	598271
MDB1913	598217
MDB1914	598470
MDB1917	598915
MDB1918	598183
MDB1919	598017
MDB1922	598841
MDB1924	598549
MDB1925	598328
MDB1926	598444
MDB1928	598912
MDB1932	598406
MDB1934	598065
	598880
MDB1936	598442
MDB1937	598443
MDB1938	598575
MDB1939	598420
MDB1940	598305
	598475
MDB1941	598316
MDB1943	598480
MDB1944	598479
MDB1945	598843
MDB1946	598548
MDB1947	598393
MDB1948	598424
MDB1949	598423
	601019
MDB1950	598309
	598772
MDB1951	598308
MDB1954	598858
MDB1956	598605
	598607
MDB1957	598854
MDB1958	598317
MDB1959	598431
MDB1960	598461
MDB1962	598125
	598141
MDB1965	598778
MDB1967	598299
MDB1972	598512
MDB1975	598452
MDB1982	598439
MDB1983	598438



 	
MINTEX (.../...)	
MDB1984	598616
MDB1985	598661
MDB1986	598883
MDB1987	598733
	598832
MDB1988	598435
MDB1989	598436
	598451
MDB1990	598682
	598758
MDB1991	598447
MDB1993	598490
MDB1994	598540
	598984
MDB1995	598493
MDB1996	598521
MDB1997	598300
MDB1999	598895
MDB2000	598036
MDB2001	598037
MDB2002	598301
MDB2003	598453
MDB2004	598580
MDB2006	598606
MDB2008	601025
MDB2010	598989
MDB2011	598632
MDB2012	598462
MDB2013	598827
MDB2014	598577
MDB2026	541662
	541683
MDB2028	598589
MDB2029	598737
	598917
MDB2033	598329
MDB2034	598332
MDB2035	598647
	598648
MDB2036	598748
MDB2038	598767
MDB2040	598408
MDB2041	598408
	598486
MDB2042	598425
MDB2043	598887
MDB2044	598907
MDB2048	598504
MDB2049	598586
MDB2050	598910
MDB2051	598407
MDB2053	598784
MDB2054	598629
MDB2055	598726
MDB2056	598697
MDB2057	598735

 	
MINTEX (.../...)	
MDB2059	598563
MDB2060	598564
MDB2061	598432
MDB2062	598433
MDB2063	598505
	598759
MDB2064	541655
	598445
	598659
MDB2066	598834
	598866
MDB2067	598398
MDB2068	598065
	598308
	598990
MDB2070	598448
MDB2071	598446
MDB2073	598456
MDB2074	598473
MDB2075	598484
MDB2076	598422
	598424
MDB2078	598547
MDB2080	598520
MDB2081	598434
MDB2082	598543
MDB2089	598468
MDB2091	598813
MDB2094	598511
MDB2095	598807
MDB2096	598650
	598681
MDB2101	598965
MDB2102	598489
MDB2104	598676
MDB2105	598482
	598650
MDB2107	598409
MDB2111	598583
MDB2112	598719
MDB2113	598482
	598650
MDB2115	598542
MDB2117	598451
MDB2118	598674
	598681
MDB2119	598821
MDB2122	598523
MDB2123	601003
MDB2126	598565
MDB2129	598270
MDB2130	598926
MDB2131	598461
	598553
MDB2133	598990
MDB2134	598886



	
MINTEX (.../...)	
MDB2135	598944
MDB2144	598071
MDB2145	598483
MDB2146	598734
MDB2150	598453
MDB2152	598514
MDB2153	598510
MDB2154	598677
MDB2155	598536
MDB2156	598585
MDB2157	598429
	598430
MDB2158	598429
	598430
MDB2159	598470
	598545
MDB2160	598673
MDB2162	598413
MDB2163	598643
MDB2167	598187
MDB2168	598457
MDB2174	601020
MDB2177	598814
MDB2180	598889
MDB2183	598464
MDB2186	598465
MDB2187	598419
MDB2188	598416
MDB2189	598417
MDB2190	598418
MDB2193	598630
MDB2194	598006
	598010
	598985
MDB2206	598605
MDB2215	598414
MDB2216	598415
MDB2217	598755
MDB2221	598859
MDB2223	598584
MDB2225	598471
MDB2226	598566
MDB2227	598658
MDB2231	598481
	598483
	598751
MDB2238	598633
MDB2239	598426
	598670
MDB2240	598427
	598721
MDB2241	598428
MDB2248	598745
MDB2252	598855
MDB2253	598500
MDB2254	598501



	
MINTEX (.../...)	
MDB2256	598180
	598463
	598681
MDB2257	598679
MDB2258	598546
MDB2261	598672
MDB2262	598678
MDB2263	598862
MDB2265	598757
	598824
MDB2266	598541
MDB2267	598744
MDB2268	598537
MDB2269	598538
MDB2271	598859
MDB2272	598639
MDB2274	598853
MDB2277	598518
MDB2278	598720
	598805
MDB2279	598434
MDB2281	598472
	598783
	601005
MDB2282	541705
MDB2283	598464
MDB2291	598827
MDB2294	598667
MDB2308	598648
MDB2309	598780
MDB2314	598564
MDB2315	598905
MDB2317	598475
MDB2326	598848
MDB2327	598558
MDB2328	598568
MDB2329	598569
MDB2336	598750
MDB2338	598823
MDB2339	598654
MDB2342	598914
MDB2349	598509
MDB2351	598051
	598786
MDB2352	598817
MDB2353	598355
MDB2357	598584
MDB2358	598992
MDB2362	601001
MDB2369	598643
MDB2376	598833
MDB2417	598767
MDB2418	598410
	598580
MDB2419	598820
MDB2425	598077
	598078



	
MINTEX (.../...)	
	598085
MDB2454	598208
MDB2470	598499
MDB2484	598012
MDB2494	598156
	598360
MDB2506	598851
MDB2514	598155
MDB2526	598091
MDB2531	598553
MDB2532	598422
MDB2534	598580
MDB2538	598720
MDB2539	598638
MDB2540	598570
MDB2542	598781
MDB2543	601030
MDB2544	598671
MDB2545	598665
MDB2546	598812
MDB2547	598678
	598808
MDB2553	598857
MDB2555	598158
	598396
MDB2558	598710
MDB2561	598473
MDB2563	598361
MDB2564	598669
MDB2565	598756
MDB2566	598674
MDB2569	598411
MDB2571	541717
MDB2576	598657
MDB2577	598875
MDB2580	598752
MDB2584	598462
MDB2585	598654
MDB2587	598637
MDB2588	598831
MDB2590	598823
MDB2591	598557
MDB2592	598919
MDB2595	598641
MDB2596	598680
MDB2598	598659
MDB2599	598423
	598824
MDB2600	598471
MDB2604	598635
MDB2605	598506
MDB2608	598842
MDB2609	598736
MDB2611	598874
MDB2612	598852
MDB2613	598829



	
MINTEX (.../...)	
MDB2615	598423
MDB2616	598423
MDB2617	601019
MDB2620	598811
MDB2622	598653
MDB2624	601029
MDB2625	598801
	598858
MDB2628	598464
MDB2633	598860
MDB2634	598649
MDB2636	598439
MDB2637	598644
MDB2638	598671
MDB2639	598643
MDB2641	598438
MDB2642	598651
MDB2643	598582
MDB2644	598913
MDB2645	598845
MDB2648	598779
MDB2655	598696
MDB2656	598761
MDB2663	598698
MDB2664	598652
MDB2670	598439
MDB2671	598795
MDB2672	598715
MDB2673	601004
MDB2674	598772
MDB2675	598470
	598669
MDB2676	598481
MDB2677	598863
MDB2678	598764
MDB2679	598765
MDB2681	598701
MDB2682	598699
MDB2683	598703
MDB2684	598700
MDB2685	598704
MDB2686	598472
	598783
	601044
MDB2688	598044
MDB2689	598303
MDB2691	598740
MDB2692	598640
MDB2693	598702
MDB2694	598779
MDB2699	598640
MDB2700	598663
MDB2701	598662
MDB2702	598664
MDB2703	598705
MDB2707	598810







 	
MINTEX (.../...)	
MDB2708	598873
MDB2709	598453
MDB2712	598741
MDB2713	598742
MDB2715	598738
MDB2716	598730
MDB2717	598885
MDB2719	598754
MDB2720	598707
MDB2725	598861
MDB2726	598802
MDB2728	598888
MDB2729	598728
MDB2732	598929
MDB2733	598868
MDB2734	598867
MDB2739	598994
MDB2741	598709
MDB2742	598770
MDB2743	598718
MDB2744	598870
MDB2745	598940
MDB2746	598527
MDB2747	601035
MDB2749	598822
MDB2750	598655
MDB2751	598656
MDB2752	598770
MDB2754	598793
MDB2757	598629
MDB2758	598006
MDB2759	598243
MDB2762	598708
MDB2763	598753
MDB2764	598808
MDB2765	598820
MDB2766	598318
MDB2767	598493
MDB2769	598896
	601026
MDB2775	601034
MDB2776	601052
MDB2777	598937
MDB2779	598722
MDB2782	598180
MDB2784	598479
MDB2785	598943
MDB2787	598819
MDB2788	598890
MDB2790	598729
MDB2791	598803
MDB2793	598639
MDB2796	598847
MDB2797	598804
MDB2799	598706
MDB2800	598727



 	
MINTEX (.../...)	
MDB2801	598898
MDB2802	541728
MDB2803	598882
MDB2816	598925
MDB2820	598180
MDB2821	598995
MDB2822	598967
MDB2841	598726
MDB2845	601051
MDB2846	598891
MDB2850	598892
MDB2853	541736
MDB2854	598825
MDB2855	598932
MDB2856	601031
MDB2858	598939
MDB2863	598928
MDB2864	598941
MDB2865	598934
MDB2866	598945
MDB2869	601046
MDB2870	601047
MDB2871	601048
MDB2872	598942
MDB2880	598894
MDB2882	598893
MDB2884	598993
MDB2887	598935
MDB2888	598752
MDB2890	598997
MDB2892	598936
MDB2895	598839
MDB2901	598899
MDB2903	601039
MDB2907	541734
MDB2923	598943
	601040
MDB2925	598933
MDB2943	598651
MDB2958	598946
MDB2962	601017
MDB2967	601013
MDB3030	601050
MDB3047	598994
MGB443	598374
MGB521	598374
MGB533	598161
	598270
	598338
MGB535	598168
MGB560	598193
MGB576	598337
MGB585	598374
MGB633	598168
MGB642	598168
MGB692	598168



 	
MINTEX (.../...)	
MGB693	598168
MLB105	598497
MLB114	598623
MLB115	598129
	598498
MLB116	598129
	598497
	598498
MLB37	598392
MLB40	598129
	598132
	598391
MLB41	598129
MLB43	598497
MLB65	598116
MLB72	598391
MLB76	598129
MLB79	598391
MLB81	598116
MLB85	598380
	598391
PAGID	
B7100-319	598112
B71003191C	598112
C3002	598086
C3004	598112
C3006	598112
C3016	541728
C4000	540436
	598369
C4012	540436
	598138
	598369
C4014	598369
C4026	541641
C4028	541664
	598966
C4030	541662
	541683
C4030P8517	541662
	541683
C4030P8518	541662
	541683
C4030P8550	541662
	541683
C4064	541705
C4068	541664
C4070	541663
C4074	541717
C4077	541662
	541683
C6006	598596
C6010	598369
	598598

 	
PAGID (.../...)	
C6018	598586
C6020	598585
C6023	541734
C6024	598882
C6026	598881
C6027	598876
C6029	541735
C9005	541737
J1244	601048
T0001	598131
T0004	598112
	598123
T0006	598293
T0008	598047
	598495
T0009	598123
	598618
T0012	598248
T0014	598296
T0015	598615
T0017	598983
	598984
T0020	598532
T0032	598666
T0034	598053
T0035	598268
	598274
T0040	598007
	598139
	598374
T0042	598266
T0044	598220
	598597
T0046	598115
T0047	598497
T0048	598129
	598132
T0052	601016
T0053	598063
	598250
T0062	598380
	598391
T0063	598129
	598497
	598498
T0084	598623
T0085	598129
	598498
T0115	598149
T0123	598362
T0125	598166
	598591
T0129	598145
T0130	598146
T0132	598145
T0134	598144



 	
PAGID (.../...)	
T0135	598150
T0139	598364
T0140	598363
T0150	598148
	598292
T0153	598147
T0204	598377
T0210	598374
T0213	598217
T0215	598169
T0221	598093
	598095
	598141
	598219
T0223	598161
	598338
T0230	598161
	598270
	598338
T0232	598374
T0249	598093
	598133
	598219
T0263	598193
T0264	598111
	598174
	598193
T0278	598612
T0287	598168
T0290	598153
T0291	598205
T0296	598076
	598377
T0303	598111
	598256
T0307	598103
T0310	598371
T0311	598613
T0311-ECO	598613
T0311P8011	598613
T0312	598144
T0316	598384
T0317	598278
	598296
T0318	598266
	598402
	598551
	598815
T0319	598379
T0322	598239
T0324	598052
	598131
T0325	598123
T0331	598402
	598614
	598947



 	
PAGID (.../...)	
T0340	598817
T0348	598032
	598166
T0350	598021
T0351	598128
T0352	598241
T0352-ECO	598241
T0353	598095
T0353-ECO	598095
T0355	598224
T0357	598122
T0359	598220
	598224
T0360	598964
T0364	598851
T0365	598248
T0366	598052
	598817
T0368	598227
T0370	598056
	598227
T0371	598131
T0375	598182
T0375-ECO	598182
T0380	598208
T0381	598129
T0385	598595
T0388	598258
T0388-ECO	598258
T0389	598036
T0390	598037
T0391	598817
T0392	598051
	598786
T0393	598540
	598984
T0394	598024
T0395	598496
T0397	598691
T0398	598625
T0399	598646
T0405	598099
T0412	598103
	598187
T0412-ECO	598103
T0413	598104
T0413-ECO	598104
T0426	598375
T0448	598187
T0449	598099
T0449-ECO	598099
T0451	598099
T0455	598088
	598099
	598187
	598584



 	
PAGID (.../...)	
T0456	598108
T0465	598108
T0475	598111
	598183
	598256
T0481	598099
	598113
	598187
	598270
T0481-ECO	598099
	598113
	598187
T0489	598375
T0494	598107
T0499	598163
T0510	598116
T0559	598129
T0569	598392
T0571	598129
	598132
	598391
T0609	598088
T0616	598090
	598603
T0616-ECO	598090
	598603
T0624	598090
	598091
	598091
	598219
T0624-ECO	598091
T0628	598085
T0644	598592
T0649	598081
T0658	598090
T0659	598094
	598125
	598141
T0669	598086
	598366
T0671	598077
	598078
	598085
T0672	598165
T0697	598077
	598085
T0698	598592
T0699	598366
T0810	598405
T0816	598207
T0825	598389
T0834	598208
T0835	598620
T0838	598123
	598379
T0841	598182
T0841-ECO	598182



 	
PAGID (.../...)	
T0854	598185
T0859	598122
T0863	598220
T0865	598122
T0882	598921
T1003	598167
T1004	598105
	598601
T1004-ECO	598105
T1005	598120
	598335
T1006	598120
	598335
T1010	598303
	598345
T1014	598272
T1014-ECO	598272
T1015	598243
T1015-ECO	598243
T1016	598183
	598243
T1016-ECO	598183
	598243
T1021	598184
T1022	598043
	598171
T1022-ECO	598043
	598171
T1023	598115
T1025	598130
T1026	598231
T1026-ECO	598231
T1027	598103
	598259
	598311
T1027-ECO	598103
	598259
T1029	598271
T1030	598271
T1034	598183
	598253
T1034-ECO	598253
T1035	598751
	598992
T1036	598601
T1037	598018
T1037-ECO	598018
T1038	598063
	598295
T1039	598259
	598386
T1040	598291
T1045	598039
	598356
T1045-ECO	598039
	598356







 	
PAGID (.../...)	
T1050	598617
T1050-ECO	598617
T1052	598269
T1056	598351
T1058	598115
T1059	598115
T1060	598113
T1061	598033
	598630
T1062	598034
T1065	598080
T1075	598038
	598074
T1078	598616
T1079	598050
T1080	598120
T1081	598033
T1082	598184
T1082-ECO	598182
	598184
T1085	598305
T1087	598013
T1088	598440
T1089	598039
	598502
T1090	598030
	598156
	598360
T1091	598357
T1091-ECO	598357
T1092	598636
T1092-ECO	598636
T1093	598355
T1093-ECO	598355
T1094	598488
T1094-ECO	598488
T1095	598041
	601003
T1097	598066
T1097-ECO	598066
T1098	598040
	598607
T1099	598065
	598308
	598990
T1100	598556
T1101	598332
T1103	598310
	598409
T1104	598311
	598753
T1105	598630
T1106	598067
	598303
	598355
	598481



 	
PAGID (.../...)	
T1106-ECO	598067
T1107	598675
T1107-ECO	598675
T1110	598303
T1111	598044
T1111P8027	598044
T1112	598305
	598475
T1113	598043
	598171
T1113-ECO	598043
	598171
T1114	598040
T1116	598281
T1117	598580
T1120	598103
	598411
	598580
T1122	598305
	598475
T1124	598046
T1124P8027	598046
T1125	598062
T1127	598619
T1129	598600
T1131	598965
T1132	598491
T1133	598989
T1135	598712
T1136	598412
T1137	598038
	598074
T1138	598156
	598360
T1139	598763
T1140	598040
	598041
	598065
T1141	598212
T1141-ECO	598212
T1142	598045
T1142P8027	598045
T1143	598403
T1143-ECO	598403
T1145	598454
T1146	598271
T1147	598423
T1148	598423
	601019
T1149	598125
	598483
	598750
	598751
T1150	598065
	598880
T1151	598605



 	
PAGID (.../...)	
T1152	598447
T1153	598444
T1154	598408
	598486
T1156	598735
T1159	598906
T1160	598423
T1161	598424
T1163	598408
T1163-ECO	598408
T1164	598322
T1165	598332
T1165-ECO	598332
T1166	598308
T1167	598317
T1167-ECO	598317
T1168	598299
T1169	598301
T1170	598300
T1171	598442
T1172	598443
T1174	598445
	598659
T1175	598446
T1176	598329
T1177	598018
T1177-ECO	598018
T1178	598311
	598386
	598753
T1179	598858
T1184	598270
T1185	601019
T1188	598719
T1189	598479
T1190	598480
T1191	598183
	598243
T1192	598563
T1193	598564
T1194	598489
T1195	598565
T1196	598676
T1196-ECO	598676
	598858
T1197	598632
T1198	598444
T1200	598440
T1202	598811
T1203	598475
T1204	598734
T1205	598992
T1206	598183
T1207	598753
T1208	598308
T1210	598433

 	
PAGID (.../...)	
T1211	598434
T1212	598566
	601012
T1213	598471
T1214	598471
T1215	598472
	598783
	601005
T1216	598422
	598424
T1218	598750
T1219	598006
T1220	598413
T1221	598643
T1223	598779
T1224	598845
T1225	598454
	598860
T1226	598605
	598607
T1228	598813
T1229	598579
T1230	598410
	598580
T1231	598767
T1233	598658
T1234	598678
T1236	598501
T1237	598411
T1238	598841
T1240	598407
T1241	598535
	598777
T1242	598908
T1243	598865
T1244	598895
T1245	598461
	598553
T1246	598538
T1247	598678
	598808
T1250	598518
T1251	598614
T1252	598018
	598496
T1253	598902
T1254	598778
T1255	598682
	598758
T1256	598827
T1257	598521
T1258	598441
T1259	598499
T1260	598425
T1261	598639
T1262	598854



 	
PAGID (.../...)	
T1263	598682
T1264	598528
	598988
T1265	598821
T1266	598374
T1268	598629
T1269	598733
	598832
T1271	598515
T1273	598452
T1274	598886
T1275	598843
T1276	598520
	598852
T1277	598511
T1280	598907
T1281	598536
T1282	598784
T1283	598514
T1284	598887
T1285	598315
T1287	598720
	598805
T1293	598820
T1294	598944
T1295	598462
T1296	598510
T1297	598677
T1299	598835
T1302	598603
T1304	598504
T1305	598748
T1307	598505
	598759
T1309	598834
	598866
T1310	598537
T1314	598414
T1315	598415
T1318	598659
T1319	598710
T1320	598915
T1323	601023
T1324	598500
T1325	598445
T1326	601003
T1328	598483
T1330	598827
T1331	598853
T1332	598541
T1333	598757
	598824
T1334	598672
	601009
T1335	598910
T1336	598745



 	
PAGID (.../...)	
T1338	598855
T1343	598542
T1345	598422
T1348	598795
T1349	598406
T1350	598863
T1351	598463
T1354	598568
T1355	598569
T1356	598570
T1357	598384
T1359	598862
T1362	598654
T1363	598823
T1366	598754
T1367	598781
T1368	598857
T1369	598553
T1370	598524
T1371	598673
T1372	541733
T1373	598558
T1374	598557
T1375	598589
T1376	598635
T1377	598752
T1378	598842
T1380	598801
	598858
T1382	598764
T1383	598765
T1384	598889
T1386	598914
T1387	598409
T1388	598481
	598483
	598751
T1389	598820
T1390	598546
T1392	598674
T1393	598736
T1394	598829
T1395	598852
T1396	598506
T1397	598423
	598824
T1398	598680
T1399	598641
T1401	598823
T1403	598831
T1404	598917
T1409	598361
T1410	601004
T1412	598744
T1414	598709
T1416	598845



 	
PAGID (.../...)	
T1418	598653
T1421	598755
T1422	598464
T1423	598848
T1424	598470
	598545
T1428	598780
T1432	598651
T1435	598912
T1436	598649
T1438	598518
T1439	598990
T1440	598761
T1441	598761
T1442	598696
T1443	598644
T1444	598699
T1445	598701
T1446	598700
T1447	598703
T1448	598640
T1449	598465
	598698
T1450	598643
T1451	598584
T1452	598704
T1453	598704
T1454	598995
T1455	598802
T1456	598919
T1457	598652
T1458	598874
T1460	598770
T1461	598662
T1462	598663
T1463	598429
	598664
T1466	598810
T1468	598464
T1469	598671
T1470	598833
T1471	598642
T1472	598647
	598648
T1473	601030
T1475	601025
T1478	598940
T1481	598671
T1485	598044
T1486	598453
T1487	598779
T1488	598657
T1489	598472
	598678
	598783
	601005
	601044



 	
PAGID (.../...)	
T1490	598859
T1491	601020
T1492	598752
T1494	598885
T1495	598715
T1496	598702
T1499	598994
T1501	598913
T1502	601033
T1504	601032
T1508	598654
T1509	598640
T1511	598451
T1512	598438
T1513	598741
T1514	598742
T1515	598905
T1516	598728
T1519	598705
T1520	598873
T1522	598738
T1523	598730
T1528	598639
T1530	598583
T1531	598718
T1532	598861
T1533	598870
T1534	598740
T1537	598035
	598613
T1538	598527
T1541	601035
T1543	598929
T1547	598822
T1548	598772
T1549	601034
T1551	598808
T1552	598707
T1553	598706
T1554	598859
T1555	598919
T1557	598250
	598629
T1562	598708
T1563	598580
T1564	598318
T1565	598493
T1566	598896
	601026
T1567	598523
T1568	601029
T1569	598849
T1570	598793
T1575	598439
T1577	598180
	598474







	
PAGID (.../...)	
T1578	598039
T1579	598479
T1580	598943
T1582	598819
T1585	598729
T1586	598803
T1587	598481
T1590	598878
T1591	598868
T1592	598867
T1593	598888
T1594	598847
T1595	598875
T1596	598898
T1597	598831
T1598	598925
T1599	598755
T1600	598877
T1601	598896
T1602	598937
T1604	598722
T1605	598890
T1606	598727
T1607	598727
T1609	598946
	598967
T1612	598739
T1616	598804
T1629	598002
T1631	598678
T1634	598726
T1637	601051
T1640	598816
T1641	598818
T1642	541736
T1643	598180
T1644	598180
	598463
	598681
T1647	598825
T1648	598426
	598913
T1649	601031
T1650	601031
T1652	598939
T1653	598879
T1655	598892
T1657	598891
T1658	598928
T1659	598941
T1660	598934
T1661	598945
T1663	601049
T1664	601007
T1668	601046
T1669	601047



	
PAGID (.../...)	
T1670	601048
T1672	598932
T1676	598942
T1679	598738
T1684	598894
T1687	598999
T1688	598893
T1690	598993
T1693	601012
T1694	598904
T1696	598935
T1698	598768
T1699	598752
T1701	598997
T1702	598998
T1703	598936
T1704	598839
T1708	598899
T1710	601039
T1713	598531
T1716	601028
T1721	541738
T1722	598744
T1726	598943
	601040
T1728	598933
T1729	601038
T1731	598901
T1738	601041
T1751	598738
T1754	598652
T1755	598651
T1758	598946
T1759	598702
T1760	598996
T1764	601052
T1766	598927
T1770	601027
T1772	601017
T1773	601010
T1774	601011
T1777	601013
T1778	598999
T1783	601036
T1788	601042
T1808	601014
T1813	598636
T1824	598046
T1826	598045
T1827	598699
T1832	601015
T1835	598044
T1850	601000
T1851	601050
T1898	598994
T1899	598637



	
PAGID (.../...)	
T1911	598361
T1926	598640
T2006	598119
	598176
	598714
T2006-ECO	598119
	598176
T2008	598168
T2017	598176
T2017-ECO	598176
T3000	598626
T3002	598250
	598629
T3003	598020
T3004	598628
T3006	598846
T3007	598023
T3009	598787
T3010	598496
T3011	598393
	598897
T3013	598551
	598579
	598809
T3014	598274
	601018
T3015	598056
T3016	598627
T3017	598642
	598682
	598911
T3018	598494
T3019	598519
T3021	598828
T3022	598014
T3023	598788
T3024	598495
	598760
T3025	598517
	601020
T3026	598840
T3027	598840
T3028	598668
	598826
T3031	598519
	598834
T3032	598624
T3033	598460
T3034	598507
T3035	598056
	598627
T3036	598634
T3037	598602
T3038	598071
T3039	598320
T3040	598318

	
PAGID (.../...)	
T3041	598051
	598574
	598786
T3042	598844
T3043	598290
	598846
T3044	598809
T3045	598826
T3046	598983
T3049	601022
	601025
T3052	598780
T3053	598551
T3054	598815
T3057	598897
T3058	598986
T3064	598777
T3070	598627
T3071	598122
T3073	598836
T3074	598266
T3075	598250
T3076	598393
T3077	598476
	598691
T3078	598523
T3081	598533
T3083	598947
T3085	598830
T3086	598458
T3087	598459
T3088	601024
T3089	598478
T3090	598850
T3092	598453
	598991
T3093	598316
T3094	598697
T3095	598493
T3096	598575
T3098	598606
T3099	598737
	598917
T3101	598579
T3103	598856
T3104	598883
T3105	598661
T3106	598361
T3107	598437
T3109	598626
T3111	598436
	598451
T3112	598534
T3113	598668
T3114	598449
T3115	598806
	601002

 	
PAGID (.../...)	
T3116	598476
T3117	598577
	598737
T3118	598760
T3120	598679
T3121	598453
T3122	598435
T3123	598522
T3124	598548
T3125	598530
T3127	598838
T3129	598665
T3130	598812
T4005	598107
	598187
T4006	598168
T4017	598166
	598212
T4017-ECO	598166
	598212
T4019	598166
	598334
T4019-ECO	598166
T4023	598168
T4074	598111
T4081	598077
	598375
T4099	598178
	598193
T4113	598109
	598110
T4113-ECO	598110
T4113-NAU	598110
T4114	598099
T4116	598106
T4135	598109
T4135-ECO	598109
T4141	598109
	598110
T4150	598127
	598258
T4150-ECO	598127
T4151	598124
	598128
T4151-ECO	598124
	598128
T4153	598187
T4154	598127
	598128
T4154-ECO	598128
T4157	598113
T4158	598351
T4161	598107
T4162	598107
T4164	598130
T4170	598115

 	
PAGID (.../...)	
T5003	598214
T5005	598315
T5005-ECO	598315
T5006	598121
	598240
T5006-ECO	598240
T5007	598121
	598240
	598312
T5008	598004
T5009	598017
T5009-ECO	598017
T5012	598027
T5013	598133
	598134
	598135
T5016	598091
	598093
T5018	598007
	598374
T5019	598118
T5021	598017
T5021-ECO	598017
T5022	598180
	598463
	598474
T5022-ECO	598180
	598463
T5024	598221
T5025	598141
	598142
	598219
	598331
T5026	598406
T5027	598179
T5027-ECO	598179
T5028	598010
T5029	598237
	598269
T5030	598256
T5032	598006
T5033	598289
T5034	598003
T5035	598499
T5037	598093
	598133
	598219
T5038	598135
T5039	598138
	598153
T5041	598186
T5046	598135
T5047	598000
	598005
T5048	598025
	598048

 	
PAGID (.../...)	
T5048-ECO	598025
	598048
T5050	598004
	598016
T5050-ECO	598004
	598016
T5051	598017
	598252
	598982
T5051-ECO	598017
	598252
T5052	598230
T5053	598015
T5054	598217
T5055	598102
T5056	598125
	598142
T5056-ECO	598125
	598142
T5058	598010
T5059	598982
T5059-ECO	598982
T5060	598154
	598353
T5061	598621
T5062	598695
T5063	598054
T5064	598057
T5065	598022
T5067	598013
T5067-ECO	598013
T5068	598008
T5070	598859
T5072	598622
	598814
T5072-ECO	598622
	598814
T5073	598254
T5074	598714
T5075	598180
	598463
	598681
T5075-ECO	598180
	598463
	598681
T5076	598312
T5077	598002
	598084
T5077-ECO	598002
	598084
T5078	598070
T5079	598800
T5080	598019
	598022
T5084	598064
T5085	598010
	598985

 	
PAGID (.../...)	
T5086	598599
T5090	598068
T5092	598069
	598467
T5094	598093
	598531
T5095	598330
T5095-ECO	598330
T5098	598017
T5098-ECO	598017
T5099	598326
T5100	598319
T5101	598549
T5102	598581
T5110	598549
T5111	598448
T5112	598448
T5113	598309
	598772
T5114	598142
	598331
T5115	598048
T5115-ECO	598048
T5116	598337
T5117	598179
	598353
T5118	598431
T5119	598988
T5120	598512
T5121	598450
T5122	598484
T5122-ECO	598484
T5123	598767
T5124	598766
T5125	598768
T5127	598470
	598669
T5128	598456
T5129	598807
T5130	598583
T5131	598398
T5132	598439
T5133	598438
T5134	598482
T5135	598650
	598681
T5136	598482
	598650
T5136-ECO	598482
T5137	598482
	598650
T5138	598674
	598681
T5139	598903
T5140	598814
T5142	598466







 Valeo	
PAGID (.../...)	
T5143	598457
T5144	598543
T5145	598965
T5146	598468
T5148	598656
T5149	598655
T5150	598770
T5154	598638
T5155	598637
T5156	601001
T5157	601029
T5158	598584
T5159	598429
	598430
T5160	598667
T5161	598720
T5162	598426
	598670
T5163	598427
	598721
T5164	598428
T5165	598633
T5166	598464
T5167	598465
T5168	598582
T5170	598429
	598430
T6006	598077
	598085
	598175
T6008	598593
	598594
T6015	598162
T6025	598090
T6028	598151
T6031	598085
T6060	598078
T6062	598126
	598160
T6064	598080
T6064-ECO	598080
T6065	598158
	598396
T6088	598002
	598075
	598081
	598177
	598181
	598338
	598366
T6088-ECO	598002
	598075
	598081
	598177
	598181
	598338
	598366



 Valeo	
PAGID (.../...)	
T6089	598082
T6089-ECO	598082
T6112	598002
	598061
T9000	598086
	598158
T9003	598091
T9007	598029
T9008	598292
T9009	598094
	598125
	598141
T9011	598257
T9011-ECO	598257
T9012	598172
T9012-ECO	598172
T9016	598294
T9017	598125
	598141
T9018	598280
T9019	598028
	598294
T9021	601021
T9025	598000
T9026	598035
T9028	598155
	598181
T9029	598075
	598081
	598155
	598181
T9029-ECO	598075
	598081
	598181
T9030	598011
	598987
T9031	598012
T9032	598382
T9033	598061
T9037	598055
	598080
	598085
T9038	598031
T9039	598383
T9049	598158
	598396
T9051	598762
T9052	598497
T9053	598080
	598396
T9054	598073
T9062	598470
T9066	598926
T9068	598385
T9069	598172
	598399



 Valeo	
PAGID (.../...)	
T9069-ECO	598172
	598399
T9070	598726
T9073	598461
	598726
T9075	598490
T9095	598073
	598420
T9096	598462
T9097	598328
T9098	598432
T9099	598036
T9100	598037
T9101	598473
T9103	598419
T9104	598416
T9105	598417
T9106	598418
T9107	598547
QUINTON HAZELL	
BLF061	598830
BLF063	598534
BLF073	598488
BLF1000	598396
BLF1002	598424
BLF1009	598753
BLF101	598338
BLF1013	598271
BLF1018	598580
BLF1019	598018
BLF1020	598355
BLF1021	598303
BLF1022	598483
BLF1023	598475
BLF1024	598515
BLF1025	598516
BLF1026	598012
BLF1028	598859
BLF1029	598466
BLF1030	598586
BLF1035	598965
BLF1037	598355
BLF1042	598459
BLF1043	598906
BLF1044	598581
BLF1045	598522
BLF1047	598065
BLF1048	598065
	598308
BLF1049	598308
BLF1050	598482
BLF1052	598412
BLF1053	598712
BLF1054	598476

 Valeo	
QUINTON HAZELL (.../...)	
BLF1055	598449
BLF1056	598403
BLF1059	598675
BLF1062	598763
BLF1064	598017
BLF1065	598470
BLF1066	598458
BLF1068	598461
BLF1070	598902
BLF1073	598549
BLF1074	541662
BLF1080	598309
BLF1082	598478
BLF1085	598454
BLF1086	598322
BLF1087	598926
BLF1088	598328
BLF1089	598317
BLF1090	598331
BLF1091	598431
BLF1092	598436
BLF1093	598266
BLF1094	598627
BLF1095	598435
BLF1098	598329
BLF1099	598493
BLF110	598337
BLF1100	598447
BLF1115	598575
BLF112	598174
BLF1121	598183
BLF1122	598386
	598753
BLF1124	598423
BLF1127	598399
BLF1130	598460
BLF1131	598605
BLF1137	598075
BLF1138	598596
BLF1141	540436
BLF115	598392
BLF125	598603
BLF126	598099
	598270
BLF130	598187
BLF135	598099
BLF1350	598500
BLF1351	598501
BLF136	598099
BLF138	598165
BLF142	598161
BLF148	598113
BLF152	598592
BLF153	598205
BLF1537	598065
BLF154	598375



 	
QUINTON HAZELL (.../...)	
BLF160	598120
	598166
	598212
BLF161	598212
BLF162	598116
BLF163	598129
BLF167	598147
BLF168	598109
BLF169	598497
BLF170	598391
BLF175	598017
BLF178	598107
BLF183	598149
BLF184	598150
BLF186	598088
BLF192	598131
BLF199	598076
BLF202	598377
BLF203	598366
BLF206	601016
BLF208	598085
BLF209	598163
BLF215	598111
BLF216	598219
BLF217	598090
BLF219	598168
BLF220	598108
BLF221	598379
BLF222	598117
BLF224	598612
BLF227	598391
BLF228	598118
BLF229	598278
BLF230	598384
BLF234	598217
BLF236	598160
BLF241	598187
BLF242	598187
BLF243	598104
BLF245	598364
BLF247	598362
BLF251	598178
BLF252	598175
BLF255	598405
BLF256	598389
BLF260	598144
	598519
BLF265	598148
BLF270	598093
BLF284	598614
BLF287	598613
BLF291	598106
BLF296	598193
BLF297	598374
BLF311	598167
BLF313	598107



 	
QUINTON HAZELL (.../...)	
BLF319	598110
BLF324	598120
	598335
BLF326	598153
BLF327	598921
BLF329	598047
BLF332	598239
BLF335	598266
BLF336	598221
BLF337	598402
BLF342	598105
BLF344	598091
BLF346	598113
BLF352	598220
BLF356	598182
BLF357	598007
BLF359	598127
BLF360	598124
BLF364	598240
BLF369	598142
BLF370	598214
BLF371	598086
BLF372	598044
	598315
BLF374	598128
BLF375	598371
BLF376	598151
BLF377	598119
	598176
BLF379	598080
BLF380	598227
BLF392	598085
BLF399	598017
BLF400	598133
BLF401	598224
BLF402	598094
	598141
BLF403	598134
BLF404	598004
BLF406	598032
BLF412	598131
BLF414	598497
BLF416	598293
BLF427	598250
BLF432	598296
BLF441	598021
BLF443	598947
BLF445	598043
	598171
BLF446	598335
BLF448	598053
BLF449	598183
	598253
BLF450	598184
BLF452	598022
BLF453	598029



 	
QUINTON HAZELL (.../...)	
BLF455	598179
BLF456	598180
	598463
BLF457	598082
BLF459	598183
BLF462	598291
BLF464	598115
BLF467	598095
BLF469	598180
BLF472	598618
BLF473	598231
BLF474	598292
BLF475	598061
BLF482	598183
	598243
BLF483	598375
BLF484	598102
BLF489	598540
	598984
BLF491	598019
BLF492	598027
BLF500	598030
BLF501	598406
BLF503	598374
BLF513	598964
BLF519	598254
BLF520	598172
BLF521	598081
BLF523	598039
	598356
BLF524	598135
BLF525	598000
	598005
BLF526	598130
BLF527	598351
BLF528	598289
BLF529	598126
BLF531	598018
BLF532	598103
	598259
BLF536	598154
BLF537	598155
	598181
BLF540	598138
	598153
BLF543	598010
	598135
	598985
BLF546	598186
BLF548	598047
BLF549	598052
BLF550	598248
BLF551	598051
	598574
BLF552	598052
BLF553	598615



 	
QUINTON HAZELL (.../...)	
BLF555	598440
BLF557	598091
	598093
BLF559	598498
BLF563	598239
BLF564	598268
BLF565	598624
BLF566	598846
BLF567	598274
BLF569	598345
BLF571	598241
BLF572	598597
BLF573	598122
BLF575	598817
BLF577	598057
BLF578	598054
BLF579	598024
	598123
BLF580	598384
BLF581	598295
BLF582	598294
BLF584	598666
BLF588	598266
BLF589	598897
BLF591	598621
BLF592	598015
BLF593	598257
BLF594	598037
BLF595	598036
BLF597	598031
BLF598	601021
BLF599	598033
	598036
	598037
	598619
	598630
BLF600	598034
BLF602	598626
BLF603	598628
BLF604	598038
BLF607	598252
BLF608	598982
BLF611	598594
BLF623	598375
BLF625	598207
BLF640	598185
BLF641	598123
BLF644	598093
BLF657	598112
BLF660	598851
BLF669	598003
	598135
BLF678	598834
	598866
BLF680	598787
BLF682	598051







 	
QUINTON HAZELL (.../...)	
BLF683	598269
BLF685	598125
BLF686	598099
BLF689	598815
BLF692	598016
BLF694	598256
BLF696	598055
BLF697	598625
BLF699	598281
BLF700	598280
BLF701	598025
	598048
BLF702	598048
BLF703	598627
BLF704	598682
BLF706	598617
BLF709	598496
BLF717	598646
BLF718	598788
BLF721	598691
BLF722	598828
BLF730	598272
BLF733	598494
BLF734	598495
BLF736	598840
BLF738	598616
BLF739	598517
BLF741	598056
BLF742	598551
BLF743	598382
BLF744	598691
BLF745	598022
	598903
BLF746	598809
BLF748	598008
BLF750	598002
	598084
BLF751	598629
BLF754	598714
BLF755	598393
BLF756	598061
BLF757	598777
BLF760	598120
BLF761	598519
BLF762	598290
BLF767	598035
BLF768	598013
BLF769	598383
BLF772	598622
BLF779	598028
BLF786	598162
BLF789	598103
BLF790	598634
BLF791	598460
BLF792	598507
BLF793	598050



 	
QUINTON HAZELL (.../...)	
BLF797	598602
BLF798	598844
BLF799	598011
	598012
BLF805	601024
BLF806	598850
BLF810	598070
BLF811	598800
BLF812	598064
BLF813	598502
BLF818	598599
BLF822	598115
BLF824	598351
BLF827	598103
BLF834	598619
	598630
BLF835	598033
BLF836	598437
BLF847	598642
BLF851	598237
BLF859	598695
BLF860	598040
BLF861	598041
BLF862	598880
BLF863	598305
BLF864	598068
BLF865	598069
BLF867	598044
BLF868	598045
BLF869	598046
BLF871	598074
BLF873	598066
BLF875	598043
BLF876	598212
BLF877	598318
BLF878	541664
BLF880	598598
BLF886	598595
BLF887	598509
BLF891	598491
BLF893	598250
BLF901	598581
BLF903	598073
BLF906	598836
BLF907	598835
BLF916	598838
BLF919	598357
BLF920	598636
BLF922	598067
BLF923	598385
BLF924	598207
BLF925	598258
BLF928	598311
BLF929	598062
BLF931	598320
BLF942	598600



 	
QUINTON HAZELL (.../...)	
BLF950	598965
BLF989	598326
BLF995	598110
BLF996	598145
BLF997	598591
BLF998	598396
BP1002	598424
BP1007	598179
	598353
BP1008	598180
BP1009	598386
	598753
BP101	598161
	598338
BP1014	601019
BP1016	598476
BP1019	598018
BP102	598168
BP1022	598483
	598751
BP1023	598305
	598475
BP1024	598515
BP1028	598859
BP1029	598466
BP1030	598586
BP1031	598556
BP1035	598544
	598965
BP1042	598459
BP1045	598522
BP1047	598040
BP1048	598308
BP1050	598650
BP1052	598412
BP1053	598712
BP1054	598476
BP1056	598403
BP1062	598763
BP1063	598330
BP1065	598470
BP1066	598458
BP1067	598726
BP1068	598461
BP1069	598361
BP1070	598902
BP1072	598841
BP1073	598549
BP1074	541662
	541683
BP1075	598579
BP1077	598420
BP1078	598065
BP1080	598309
	598772
BP1081	598452

 	
QUINTON HAZELL (.../...)	
BP1083	598490
BP1084	598444
BP1088	598328
BP1090	598142
	598331
BP1091	598431
BP1092	598436
	598451
BP1093	598682
	598758
BP1094	598548
BP1095	598435
BP1096	598299
BP1097	598450
BP1098	598329
BP1099	598493
BP110	598337
BP1100	598447
BP1101	598843
BP1102	598524
BP1103	598479
BP1104	598480
BP1114	598316
BP1115	598575
	598708
BP1116	598606
BP1117	598462
BP112	598174
	598193
BP1124	598423
BP1131	598605
BP1132	598482
	598546
BP1133	598217
BP1134	598442
BP1135	598443
BP1142	598408
BP1143	598036
BP1144	598037
BP1145	598398
BP1147	598926
BP1149	598514
BP115	598392
BP1150	598465
BP1153	598613
BP1154	598817
BP1156	598219
BP1157	598017
BP1160	598614
BP1161	598266
BP1164	601023
BP1167	598830
BP1168	598523
BP1169	601022
BP1173	598509
BP1177	598528



 	
QUINTON HAZELL (.../...)	
BP1178	598534
BP1179	598915
BP1180	598530
BP1181	598682
	601043
BP1184	598912
BP1185	598406
BP1189	598766
BP1190	598768
BP1191	601002
BP1192	598908
BP1193	598865
BP1194	598535
BP1195	598496
BP1196	598856
BP1199	598858
BP1200	598183
BP1201	598988
BP1203	598616
BP1204	598661
BP1205	598883
BP1206	598589
BP1207	598733
	598832
BP1208	598332
BP1209	598854
BP1210	598301
BP1211	598806
	601002
BP1212	598521
BP1213	598006
BP1214	598531
BP1215	598784
BP1216	598632
BP1217	598887
BP1218	598748
BP1219	598907
BP1220	598991
BP1221	598425
BP1222	598407
BP1223	598422
	598424
BP1224	598735
BP1225	598989
BP1226	598697
BP1227	598737
	598917
BP1228	598473
BP1229	598577
BP1230	598778
BP1231	598647
BP1233	598895
BP1234	598880
BP1235	598629
	598647
BP1236	598607



 	
QUINTON HAZELL (.../...)	
BP1237	598439
BP1238	598438
BP1239	541641
BP1241	598726
BP1242	598504
BP1243	598486
BP1244	598432
BP1245	598505
	598759
BP1246	598300
BP1247	598834
	598866
BP1248	598719
BP1249	598583
BP125	598090
	598603
BP1250	598518
BP1251	598827
BP1252	601025
BP1254	598453
BP1257	598543
BP1258	598451
	598456
BP1259	598456
BP126	598099
	598187
BP1260	598563
BP1261	598564
BP1263	598523
BP1264	598433
BP1265	598510
BP1266	598677
BP1267	598457
BP1268	598992
BP1269	598448
BP127	598085
BP1270	598468
BP1271	598536
BP1272	598676
BP1273	598453
BP1274	598807
BP1275	598814
BP1276	598418
BP1278	598464
BP1279	598484
BP1280	598681
BP1281	598520
BP1282	598434
BP1283	598547
BP1284	598482
BP1285	598482
BP1286	598650
	598681
BP1287	598511
BP1288	598419
BP1289	598416



 	
QUINTON HAZELL (.../...)	
BP129	598108
BP1290	598417
BP1291	598413
BP1292	598643
BP1293	598443
	598813
BP1294	598886
BP1295	598944
BP1297	598445
BP1299	598483
BP130	598099
	598187
BP1300	598734
BP1301	598681
BP1302	598880
BP1303	598065
	598990
BP1304	598461
BP1305	598545
	598669
BP1306	598821
BP1309	598750
BP1312	598910
BP1313	598565
BP1314	598446
BP1315	598426
	598670
	598913
BP1316	598633
BP1317	598428
BP1318	598427
	598721
BP1319	598566
BP1320	598471
BP1321	598471
BP1322	598472
	598783
BP1324	598489
BP1325	598537
BP1326	598538
BP1328	598542
BP1329	598429
	598430
BP1330	598429
	598430
BP1331	598274
BP1332	598811
BP1333	598673
BP1336	598667
BP1337	598308
BP1338	598753
BP1339	598859
BP1340	598040
BP1341	598568
BP1342	598569
BP1343	598570



 	
QUINTON HAZELL (.../...)	
BP1345	598415
BP1346	598755
BP1347	598679
BP1348	598848
BP1349	598827
BP135	598099
BP1350	598500
BP1351	598501
BP1352	598553
BP1353	598065
	598308
	598990
BP1354	598680
BP1355	598472
BP1357	598580
BP1358	598639
BP1359	598644
BP136	598099
BP1360	598745
BP1362	598853
BP1363	598857
BP1364	598638
BP1365	598584
BP1366	598678
BP1368	598541
BP1369	598833
BP137	598375
BP1370	598667
	598720
BP1371	598672
BP1372	598805
BP1373	598862
BP1374	598739
	598781
BP1375	598780
BP1376	598757
BP1377	598558
BP1379	541705
BP138	598165
BP1380	598824
BP1381	598464
BP1382	598607
	601003
BP1384	598708
BP1389	598654
BP1390	598889
BP1392	598808
BP1393	598710
BP1394	598812
BP1395	598665
BP1396	601030
BP1398	598410
BP1399	598820
BP1400	601001
BP1401	598823
BP1402	598422







 	
QUINTON HAZELL (.../...)	
BP1404	598855
BP1406	598462
BP1407	598411
BP1409	601029
BP141	598182
BP1410	598658
BP1412	598641
BP1415	598557
BP1416	598736
BP1417	598674
BP1418	598180
	598463
	598546
	598681
BP1419	598635
BP142	598161
	598163
	598338
BP1420	598752
BP1421	598779
BP1422	601004
BP1423	598811
BP1424	598640
	598754
BP1425	598468
BP1426	598861
BP1427	598649
BP1428	598489
	598801
BP1429	598761
BP1430	598318
BP1431	598659
BP1432	598637
BP1433	598764
BP1434	598765
BP1435	598454
	598860
BP1436	598715
BP1437	598662
BP1438	598663
BP1439	598664
BP1443	598874
BP1444	598744
BP1445	598506
BP1447	598842
BP1449	598914
BP1450	541733
BP1454	541717
BP1455	598651
BP1456	598652
BP1457	598671
BP1458	598653
BP1459	598810
BP146	598375
BP1461	598656
BP1462	598916



 	
QUINTON HAZELL (.../...)	
BP1463	598770
BP1464	598643
BP1466	598754
BP1468	598756
BP1469	598582
BP1470	598655
BP1471	598829
BP1472	598831
BP1474	598704
BP1475	598696
BP1476	598518
BP1477	598738
BP1478	598700
BP1479	598703
BP148	598113
BP1480	598699
BP1482	598795
BP1483	598820
BP1484	598701
BP1486	598919
BP1487	598992
BP1488	598992
BP1489	598470
BP1497	598845
BP1498	598472
	598783
	601044
BP1499	598740
BP1501	598772
BP1502	598729
BP1503	598640
BP1504	598885
BP1505	598718
BP1506	598702
BP1507	598873
BP1508	598793
BP1509	598727
BP151	598146
BP1513	598821
BP1514	598705
BP1515	598707
BP1516	598706
BP1517	598741
BP152	598592
BP1520	601035
BP1524	598728
BP1526	598738
BP1527	598730
BP1528	598816
BP1529	598818
BP153	598205
BP1530	541736
BP1531	598875
BP1532	598847
BP1533	598863
BP1536	598849



 	
QUINTON HAZELL (.../...)	
BP1537	598868
BP1538	598867
BP1540	598888
BP1544	598895
BP1545	598877
BP1546	598878
BP1547	601030
BP1548	598657
BP1549	598722
BP1550	598825
BP1551	598839
BP1553	598876
BP1554	598881
BP1555	598882
BP1556	541728
BP1557	598935
BP1558	598879
BP1559	601007
BP1560	598928
BP1561	598997
BP1562	598936
BP1563	598998
BP1565	598893
BP1566	598994
BP1567	598967
BP1568	598940
BP157	598077
	598078
	598085
BP1572	598899
BP1573	598891
BP1574	598892
BP1576	598987
BP1577	601015
BP1578	598426
BP1579	598942
BP1580	598941
BP1581	598995
BP1582	601051
BP1584	598896
BP1585	601028
BP1587	598939
BP1588	601039
BP1590	601043
BP1591	598845
BP1592	598934
BP1593	598945
BP1594	598932
BP1596	598738
	598889
BP1597	598804
BP1598	598803
BP160	598166
	598171
	598212
	598334

 	
QUINTON HAZELL (.../...)	
BP1602	598819
BP1605	598898
BP1607	598925
BP1609	598453
BP161	598120
	598166
	598212
BP1612	601034
BP1614	598439
BP1617	601052
BP1618	598933
BP1619	598933
BP162	598116
BP1621	598738
BP163	598129
BP1631	541734
BP1632	598901
BP1633	601038
BP164	598374
BP167	598147
BP168	598109
BP169	598497
BP170	598129
	598391
BP175	598004
	598017
BP178	598107
BP183	598149
BP184	598150
BP186	598088
BP189	598168
BP191	598185
BP192	598052
	598131
BP194	598208
BP199	598076
BP200	598002
	598084
BP202	598377
BP203	598366
BP206	601016
BP207	598086
	598366
BP208	598077
	598078
	598081
	598085
	598153
BP209	598163
BP215	598111
BP216	598219
BP217	598090
BP219	598168
BP220	598108
BP221	598123
	598379



 	
QUINTON HAZELL (.../...)	
BP222	598117
BP224	598612
BP227	598391
BP228	598118
BP229	598278
	598296
BP230	598384
BP234	598217
BP235	598169
BP236	598081
BP237	598128
BP238	598124
BP241	598187
BP243	598104
BP244	598103
BP245	598364
BP247	598362
BP251	598178
	598193
BP252	598175
BP256	598389
BP260	598144
BP265	598148
	598292
BP270	598093
BP281	598077
BP284	598614
BP287	598613
BP291	598106
BP295	598007
	598129
	598132
BP296	598193
BP297	598374
BP310	598081
	598177
BP311	598167
BP313	598107
BP316	598122
BP318	598125
	598142
	598180
BP319	598110
BP321	598162
BP324	598120
BP326	598153
BP327	598921
BP329	598047
BP331	598237
BP332	598239
BP335	598266
	598402
BP336	598221
BP337	598402
	598614
	598947



 	
QUINTON HAZELL (.../...)	
BP339	598241
BP342	598105
BP344	598091
	598219
BP346	598113
BP347	598130
BP350	598160
BP352	598220
BP353	598091
	598093
	598095
	598135
	598141
	598141
	598219
BP356	598182
	598356
BP357	598007
	598374
BP358	598257
BP359	598127
BP360	598124
	598128
BP361	598075
	598080
	598081
	598177
	598181
	598338
BP363	598186
BP364	598240
BP365	598175
BP366	598112
	598123
BP368	598121
	598312
BP369	598125
	598142
	598331
BP370	598214
BP371	598086
BP372	598044
	598315
BP374	598128
BP375	598371
BP376	598151
BP377	598119
BP378	598051
	598052
BP379	598080
BP382	598227
BP388	598380
	598391
BP392	598077
	598078
	598085
BP398	598593



 	
QUINTON HAZELL (.../...)	
BP399	598017
BP400	598093
	598133
	598219
BP401	598224
BP402	598125
	598141
BP403	598093
	598095
	598134
	598135
	598141
	598219
BP404	598004
BP405	598176
BP406	598032
	598166
BP407	598176
BP412	598131
BP413	598983
BP414	598497
BP416	598293
BP425	598248
BP427	598250
BP432	598296
BP437	598122
BP441	598021
BP445	598043
	598171
BP446	598120
	598335
BP447	598497
	598623
BP448	598053
	598682
BP449	598183
	598253
BP450	598184
BP451	598144
BP452	598022
BP453	598029
BP454	598061
	598396
BP455	598174
	598179
BP456	598180
	598463
	598546
	598681
BP457	598082
BP459	598183
	598187
BP460	598006
BP461	598369
BP462	598291
BP464	598010
	598115



 	
QUINTON HAZELL (.../...)	
BP466	598122
BP467	598095
BP469	598180
	598463
BP470	598053
BP472	598123
	598618
BP473	598231
BP474	598292
BP475	598002
	598061
BP481	598129
	598498
BP482	598183
	598243
BP483	598375
BP484	598102
BP489	598540
	598984
BP491	598019
	598022
BP492	598027
BP497	598817
BP500	598030
BP501	598406
BP503	598374
BP513	598964
BP519	598254
BP520	598172
BP521	598075
	598155
	598181
BP522	598030
	598156
BP523	598039
	598356
BP524	598135
BP525	598005
BP526	598130
BP527	598351
BP528	598289
BP529	598126
	598160
BP530	598230
BP531	598018
BP532	598103
	598259
BP535	598363
BP536	598154
	598353
BP537	598155
	598181
BP538	598030
	598156
BP540	598138
	598153







 	
QUINTON HAZELL (.../...)	
BP543	598135
BP544	598094
	598141
BP545	598271
BP546	598186
BP547	598208
BP548	598047
	598056
	598227
BP549	598052
BP550	598248
BP551	598051
	598574
	598786
BP552	598052
BP553	598615
BP554	598020
BP555	598440
BP556	598039
	598502
BP557	598091
	598093
BP558	598133
	598134
	598135
BP559	598129
	598497
	598498
BP563	598239
BP564	598268
BP565	598624
BP566	598846
BP567	598274
BP568	598111
BP569	598345
BP570	598315
BP571	598241
BP572	598220
	598597
BP573	598122
BP574	598826
BP575	598817
BP576	598123
BP577	598057
BP578	598054
	598450
BP579	598024
BP580	598384
BP581	598295
BP582	598294
BP584	598666
BP586	598023
BP588	598266
	598402
BP589	598393
	598897



 	
QUINTON HAZELL (.../...)	
BP590	598496
BP591	598621
BP592	598015
BP593	598257
BP594	598037
BP595	598036
BP596	598095
BP597	598031
BP598	598012
	601021
BP599	598033
BP600	598034
BP601	598053
BP602	598626
BP603	598628
BP604	598038
	598074
	598396
BP605	598061
BP606	598016
	598330
BP607	598017
	598252
BP608	598982
BP609	598014
BP610	598383
BP611	598594
BP612	598695
BP620	598386
BP625	598207
BP644	598093
BP649	598620
BP657	598112
BP660	598618
	598851
BP662	598532
BP665	598010
	598985
BP669	598003
BP675	598000
	598613
BP678	598519
	598834
	598866
BP680	598787
BP682	598051
	598786
BP683	598237
	598269
BP685	598125
	598142
	598180
BP686	598270
	598338
BP687	598007
	598374



 	
QUINTON HAZELL (.../...)	
BP689	598815
BP691	598355
BP693	598601
BP694	598256
BP695	598540
	598984
BP696	598055
BP697	598220
	598625
BP699	598281
BP700	598280
BP701	598025
	598048
BP702	598048
BP703	598627
BP704	598682
	598911
BP706	598617
BP712	598296
BP714	598668
	598826
BP717	598646
BP718	598788
BP721	598691
BP722	598828
BP728	598596
BP730	598272
BP731	598338
BP733	598494
BP734	598495
	598760
BP736	598840
BP737	598627
BP738	598616
BP739	598517
	601020
BP740	598010
	598985
BP741	598056
	598788
BP742	598551
	598579
	598809
BP743	598382
BP744	598476
	598691
BP745	598903
BP746	598809
BP748	598008
BP750	598002
	598084
BP751	598250
	598629
BP752	598055
	598158
	598396

 	
QUINTON HAZELL (.../...)	
BP754	598714
BP755	598393
BP757	598777
BP760	598120
BP761	598519
BP762	598290
	598846
BP764	598533
	598534
BP767	598035
BP768	598013
BP771	598121
	598312
BP772	598622
BP778	598004
BP779	598028
BP790	598634
BP791	598460
BP792	598507
BP793	598050
BP797	598602
BP798	598844
BP799	598011
	598012
BP805	601024
BP806	598850
BP810	598070
BP811	598800
BP812	598064
BP813	598039
	598502
BP818	598599
BP822	598115
BP823	598113
BP824	598351
BP827	598103
	598580
BP828	540436
BP829	598132
	598380
BP830	598010
	598985
BP832	598034
	598619
BP833	598240
BP834	598630
BP835	598033
BP836	598437
BP840	598762
BP841	598780
BP847	598642
BP848	598123
BP850	598080
	598396
BP851	598237
	598269



 	
QUINTON HAZELL (.../...)	
BP852	598291
BP854	598986
BP858	598393
BP859	598695
BP860	598040
BP861	598041
BP862	598065
	598308
BP863	598305
BP864	598068
BP865	598069
	598467
BP866	598063
	598295
BP867	598044
BP868	598045
BP869	598046
BP870	598156
	598360
BP871	598038
	598074
BP872	598075
	598081
BP873	598066
BP874	598184
BP875	598043
	598171
BP876	598212
BP877	598318
BP878	541664
	598966
BP880	598598
BP891	598491
BP893	598250
BP897	598499
BP898	598989
BP899	598355
BP901	598581
BP903	598073
BP906	598836
BP907	598835
BP916	598838
BP919	598357
BP920	598636
BP922	598067
	598303
BP923	598385
BP924	598207
BP925	598258
BP926	598310
	598409
	598811
BP927	598311
BP929	598062
BP930	598071
BP942	598600



 	
QUINTON HAZELL (.../...)	
BP956	598600
BP958	598230
BP959	598441
BP960	598320
BP961	598449
BP962	598523
BP963	598614
BP965	598177
	598496
BP966	598482
BP967	598332
BP968	598326
BP969	598985
BP970	598947
BP971	598488
BP973	598319
BP974	598675
BP975	598303
	598355
	598481
	598616
BP977	598271
	598423
BP978	598048
BP979	598017
BP981	598512
BP982	598172
	598399
BP983	598322
BP984	598454
BP985	598926
BP986	598478
BP992	598317
BP997	598591
ROADHOUSE	
2001.02	598178
2002.00	598106
	598111
2002.10	598111
2002.20	598106
2005.01	598351
2005.11	598351
2006.00	598099
	598270
2006.01	598113
2006.02	598113
2006.30	598099
2006.60	598099
	598187
	598270
2006.91	598113
2007.00	598099
	598187
2008.00	598174
	598375



 	
ROADHOUSE (.../...)	
2008.02	598375
2008.12	598375
2008.14	598375
2008.30	598375
2010.20	598109
2010.40	598109
	598110
2011.20	598107
2011.30	598107
2013.02	598161
	598193
	598338
2014.00	598108
2014.01	598115
2014.10	598108
2014.21	598115
2014.40	598719
2014.52	598914
2015.00	598187
2016.00	598187
2017.00	598099
2017.10	598099
2017.20	598099
2021.00	598077
	598078
	598085
2021.04	598077
2021.06	598077
	598078
	598081
	598085
2021.16	598077
	598078
	598081
	598085
2021.36	598085
2021.40	598094
2022.00	598090
	598603
2022.02	598090
	598603
2022.10	598088
2022.40	598266
	598402
2024.02	598090
2025.12	598160
2025.22	598126
2025.30	598125
	598141
	598219
2026.02	598593
2026.12	598594
2027.02	598162
	598592
2027.12	598592
2030.02	598077
	598085



 	
ROADHOUSE (.../...)	
	598175
2031.02	598162
2033.04	598145
2033.14	598145
2034.00	598144
	598519
2034.04	598144
2035.04	598150
2036.00	598374
2039.00	598075
	598081
	598161
	598338
2039.30	598338
2042.00	598337
2044.00	598374
2044.02	598374
2045.32	598174
	598193
2046.00	598128
	598205
2046.10	598205
2046.20	598214
2047.14	598613
2047.22	598369
2047.30	598613
2047.52	540436
2048.00	598112
2048.02	598112
2050.00	598392
2052.10	598497
2056.00	598129
2056.04	598129
2056.11	598391
2056.12	598129
	598132
2056.22	598380
2058.10	598391
2058.12	598391
2060.00	598076
	598377
2061.02	598366
2062.00	598496
2063.00	598168
2063.02	598168
2064.02	598168
2065.00	598540
2068.02	598193
2070.00	598362
2072.00	598146
2073.00	598375
2076.00	598146
2076.04	598146
2078.00	598077
2080.00	598389
	598405







 	
ROADHOUSE (.../...)	
2086.04	598147
2087.00	598363
2088.00	598207
2088.10	598207
2089.00	598364
2090.04	598591
2091.00	598165
2094.40	598620
2101.00	598182
2101.10	598182
2102.00	598148
2102.10	598292
2103.00	598389
21030.01	598635
21030.10	598715
21031.00	598752
21036.02	598860
21038.02	598842
21038.12	598842
2104.02	598377
21041.02	598654
21041.12	598654
21042.02	598823
21043.00	598657
21044.00	598829
21045.01	598652
21045.11	598651
21045.22	598940
21046.02	598665
21047.02	598812
21048.00	598874
21050.02	598810
21051.02	598852
21052.00	598640
	598754
21053.00	598808
21054.02	598653
21056.02	598845
21056.12	598845
2106.00	598220
21068.02	598824
21070.00	601030
21082.00	598649
21085.02	598506
	598871
21099.00	598761
21099.01	601031
2110.00	598208
21100.00	598696
21100.11	598426
	598913
	601015
21101.04	598663
21102.04	598662
21103.00	598664
21106.10	598920



 	
ROADHOUSE (.../...)	
21109.02	598764
2111.00	598185
2111.02	598185
21110.02	598765
21111.02	598873
21113.00	598861
21126.08	601032
21127.08	601033
21129.01	598855
21130.00	598795
21131.00	598699
21132.00	598701
21133.02	598707
21134.02	598705
21135.02	598706
21136.01	598929
21138.00	598702
21139.02	598575
	598708
2114.00	598371
21140.00	598709
21143.00	598710
21144.00	598704
21145.00	598703
21149.10	598740
2115.00	598122
2115.10	598291
21158.00	598741
21159.00	598742
21162.01	598738
2117.00	598123
	598379
2117.02	598123
21176.01	598875
21177.00	598718
21178.00	598727
21179.00	598728
2118.00	601016
21181.02	598888
21183.02	598729
21187.02	598946
	598967
21188.01	598730
2119.00	598212
2119.10	598212
2119.15	598212
2119.20	598120
	598166
	598212
2119.32	598120
	598166
	598171
	598212
	598334
21190.01	598746
21193.00	601034



 	
ROADHOUSE (.../...)	
21194.02	598739
21198.00	598722
21199.00	598706
2120.00	598614
21200.00	598994
21201.00	601035
21202.00	598995
21203.00	598939
21204.02	598744
21205.02	598803
21206.02	598849
21208.02	598868
21209.02	598867
2121.00	598124
2121.10	598128
21215.01	598804
21219.00	598879
21219.11	598996
21219.21	601036
2122.02	598116
21223.02	598361
21224.00	598896
21225.02	598877
21226.02	598937
2123.02	598117
21231.00	598819
21232.00	598943
21234.00	601037
21235.02	598894
21236.00	598928
21237.01	598891
21238.00	598892
21239.02	598932
21241.00	598936
21242.01	598893
21243.00	598881
21244.02	598821
21245.00	598882
21245.02	541737
21245.10	541734
21246.00	541728
21247.00	598876
21248.00	598997
21249.00	598998
2125.04	598149
21250.02	598816
21251.02	598818
21252.02	541736
21256.00	598935
21258.00	601052
2126.00	598612
21260.12	598941
21261.12	598942
2127.02	598163
21277.00	598925
2128.00	598093

 	
ROADHOUSE (.../...)	
2128.12	598093
2128.32	598091
	598093
2128.50	598531
21282.00	541735
21286.02	598933
21289.02	598901
2129.00	598122
2129.10	598122
21290.02	601038
21292.01	598899
21299.00	601039
21302.02	598934
2130302	598945
21305.00	601051
21318.00	598738
2132.00	598921
21323.00	598927
2134.00	598017
2134.02	598017
2134.10	598004
2134.20	598017
2134.40	598017
	598252
2134.42	598982
2134.50	598016
2134.62	598982
21344.00	601041
2135.00	598125
2135.10	598125
2135.20	598125
2135.40	598125
21382.00	601042
21385.02	601047
21386.02	601048
21387.00	601000
21388.04	601049
21389.00	601050
2139.00	598104
2141.02	598002
	598084
	598176
2141.10	598002
	598422
2141.20	598002
2141.24	598154
2141.30	598002
	598780
2141.32	598002
	598084
2142.10	598112
	598613
2142.20	598000
2143.02	598153
2144.06	598396
2144.12	598081
	598177



 	
ROADHOUSE (.../...)	
2144.14	598151
2144.24	598151
2144.32	598080
2144.42	598594
2144.50	598061
	598396
2144.60	598061
	598396
2144.70	598158
	598396
2144.80	598080
2144.92	598080
	598396
2145.00	598241
2146.14	598091
	598135
	598141
	598219
2146.22	598093
	598133
	598219
2146.32	598134
2146.44	598219
2146.52	598003
	598135
2146.80	598219
2147.00	598052
	598131
2147.11	598131
2147.22	598296
	598666
2149.00	598278
2149.10	598278
2151.00	598817
2151.12	598629
2154.00	598217
2154.02	598169
2155.00	598103
	598259
2155.10	598291
2155.20	598291
2156.00	598221
2157.00	598105
2157.10	598345
2163.02	598175
2164.00	598239
2164.02	598239
2167.04	598266
2167.10	598266
2168.00	598167
2169.01	598118
2170.04	598119
2170.12	598176
2170.14	598119
	598176
	598714



 	
ROADHOUSE (.../...)	
2170.24	598714
2171.00	598124
2171.10	598128
	598181
2171.20	598127
2171.60	598258
2172.00	598120
	598335
2172.02	598120
	598335
2172.10	598422
	598424
2172.11	598424
2172.12	598424
2172.22	598120
2172.30	598422
2172.32	601017
2173.00	598186
2174.00	598384
2174.02	598384
2175.00	598224
2176.00	598257
2176.10	598257
2176.20	598257
2179.30	598780
2179.40	598780
2181.04	598615
2182.02	598052
2184.00	598112
	598123
2184.02	598123
2188.00	598220
2189.00	598044
	598315
2189.02	598044
	598315
2189.10	598044
	598315
2190.00	598021
2190.10	598021
2191.12	598691
2192.10	598075
2192.12	598002
	598075
	598081
	598155
	598177
	598181
2192.22	598080
2192.34	598155
	598181
2192.44	598155
	598181
2192.96	598075
2193.00	598047
2193.02	598047



 	
ROADHOUSE (.../...)	
2197.10	598402
	598614
2199.10	598984
2201.02	598983
2201.12	598983
	598984
2202.02	598086
2205.00	598240
2205.02	598121
2205.12	598312
2206.00	598032
	598166
2208.00	598473
2208.02	598002
	598061
2208.12	598061
2209.00	598108
2210.00	598130
2210.02	598130
2211.04	598007
	598374
2211.12	598007
	598139
	598374
2211.22	598596
2212.02	598293
2212.12	598274
2212.32	601018
2212.42	598274
2214.02	598984
2214.04	598540
	598984
2214.14	598540
2214.22	598540
2215.00	598964
2219.00	598296
2219.02	598296
2220.02	598082
2221.00	598406
2221.02	598406
2222.01	598497
2223.00	598027
2224.00	598052
2224.02	598052
2224.22	598052
2228.02	598248
2229.02	598248
2231.00	598125
	598142
	598219
2233.00	598053
2233.02	598053
	598437
2233.20	598437
2233.42	598437
2236.00	598123
	598618



 	
ROADHOUSE (.../...)	
2236.02	598123
	598618
2237.02	598047
	598227
2238.04	598020
2238.14	598020
2238.24	598020
2239.00	598183
2239.10	598183
	598243
2239.40	598183
2239.50	598183
2240.00	598532
2241.02	598002
2247.04	598030
	598156
2247.10	598156
	598360
2247.14	598030
	598156
2247.24	598156
2250.01	598227
2251.12	598022
	598903
2256.00	598122
2257.10	598270
2257.20	598270
2259.02	598289
2259.12	598008
2261.02	598138
	598153
	598179
2262.02	598179
2262.12	598179
	598353
2263.00	598180
	598463
2263.01	598180
	598463
2263.03	598180
	598463
2263.05	598180
	598463
	598474
	598752
2263.10	598180
	598474
2263.14	598474
2263.15	598180
2263.16	598180
2263.20	598180
2263.41	598463
	598674
2263.50	598463
2263.51	598681
2263.74	598180
	598463







 	
ROADHOUSE (.../...)	
2264.02	598095
	598219
2264.42	598095
2265.00	598103
	598259
	598386
2265.10	598039
2265.15	598311
2265.30	598386
	598753
2265.32	598502
2265.40	598753
2265.41	598753
2265.50	598386
2266.00	598623
2267.00	598129
2267.11	598497
	598498
2268.04	598266
2269.00	598146
2270.00	598231
	598440
2270.10	598440
2270.15	598310
	598409
2270.22	598281
2270.25	598409
	598811
2270.40	598230
2271.02	598268
	598274
2272.00	598846
2273.02	598250
	598629
2275.02	598597
2276.22	598230
2277.10	598921
2280.00	598102
2280.10	598237
	598269
2281.00	598271
2281.02	598271
2281.12	598271
2281.32	598423
2281.40	598423
2281.42	601019
2282.00	598183
	598253
2282.10	598183
	598253
2282.20	598272
2283.00	598589
	598590
2283.10	598589
2284.00	598241
2285.10	598043
	598171



 	
ROADHOUSE (.../...)	
2285.20	598043
	598171
2286.10	598184
2286.20	598184
2286.30	598184
2286.50	598184
2287.00	598051
	598786
	598787
2289.12	598023
2291.02	598834
	598866
2292.00	598851
2293.12	598787
2294.12	598817
2294.22	598817
2294.32	598817
2297.00	598621
2297.10	598621
2302.00	598826
2302.12	598826
2303.02	598010
	598135
	598985
2303.12	598135
2304.12	598134
2305.02	598006
2305.12	598006
	598010
	598985
2305.31	598010
2305.32	598985
2305.44	598064
2305.72	598985
2306.00	598496
2306.12	598496
2306.22	598496
2306.32	598177
	598496
2309.00	598015
2309.10	598015
2310.04	598294
2310.14	598029
2311.00	598292
2312.02	598000
	598005
2313.02	598250
2315.04	598393
	598897
2315.14	598393
	598897
2315.22	601043
2316.04	598266
2317.12	598806
	601002
2318.03	598870



 	
ROADHOUSE (.../...)	
2318.05	598051
	598574
2318.12	598051
	598574
2318.22	598786
2318.42	598051
2318.52	598574
2318.82	598574
2318.92	598574
2319.00	598269
2320.00	598054
	598450
2320.20	598054
2321.02	598295
2321.10	598063
2321.22	598062
2324.02	598788
2325.02	598682
	598911
2325.04	601043
2325.12	598682
2325.22	598682
2325.32	598682
	598911
2325.42	598682
2325.52	598682
	601043
2329.00	598624
2330.02	598019
	598022
2331.00	598172
2331.04	598399
2332.02	598815
2333.02	598646
2335.12	598854
2336.00	598254
2337.02	598022
2337.10	598512
2342.02	598828
2343.00	598057
2344.00	598024
	598054
	598123
	598450
2345.00	598055
2345.10	598055
2350.04	598786
2351.02	598627
2351.32	598627
2351.42	598627
2354.02	598517
2354.22	601020
2357.00	598626
2363.02	598840
2364.00	598628
2364.02	598628

 	
ROADHOUSE (.../...)	
2365.21	598916
2366.12	598668
2366.22	598668
2368.00	598695
2368.10	598695
2372.02	598091
	598219
2375.02	598912
2379.00	598601
2379.20	598601
2380.00	598614
2381.00	598103
2381.20	598580
2381.30	598580
2381.40	598411
2381.60	598754
	598885
2381.70	598885
2382.00	598256
2383.00	598025
	598048
2384.00	598018
2384.40	598018
2384.60	598699
	598700
2385.10	598048
2385.11	598807
2389.02	598533
2389.12	598533
	598534
2390.00	598067
2390.01	598303
	598355
2390.02	598483
2390.10	598305
	601006
2390.11	598489
2390.20	598303
2390.22	598483
	598751
2390.32	598305
	598475
2390.40	598355
2390.41	598486
2390.50	598481
	598616
2390.52	598751
2391.00	598036
2391.02	598036
2392.00	598037
2392.02	598037
2393.00	598039
	598356
2393.20	598039
	598356
2396.10	598518



 	
ROADHOUSE (.../...)	
2397.00	598515
2397.22	598515
2399.21	598516
2401.04	598280
2401.14	598028
	598294
2402.02	598551
	598579
	598809
2402.22	598551
2402.42	598551
2403.02	598476
	598691
2405.02	598519
2406.02	598056
	598627
2407.00	598617
2409.02	598382
2409.12	598382
2410.00	598986
2413.00	598777
2413.04	598777
2414.00	601021
2414.01	598011
	598012
	598987
2414.02	598011
	598012
2414.20	598012
2414.21	598987
2415.04	598629
2415.12	598629
2415.32	598910
2416.00	598290
2418.02	598494
2419.02	598495
	598760
2419.22	598760
2421.00	598947
2421.20	598947
2423.02	601023
2424.04	601022
2425.02	598460
2425.22	598460
2425.32	598661
2426.02	598507
2427.00	598809
2427.02	598809
2429.04	598393
2429.14	598393
2431.10	598014
2432.00	598034
2432.02	598033
	598036
	598037
	598619
	598630



 	
ROADHOUSE (.../...)	
2433.02	598035
2433.12	598035
2434.01	598859
2434.02	598859
2434.14	598466
2434.22	598988
2434.30	598480
2434.32	598988
2435.02	598598
2435.12	598586
2436.02	541641
2437.02	598033
2438.04	598031
2439.04	598383
2440.02	598844
2445.02	598013
2446.00	598616
2447.20	598556
2456.02	601023
2459.00	598666
2460.02	598625
2460.12	598625
2461.00	598038
	598074
2461.02	598038
	598074
2461.10	598074
2462.00	598602
2463.00	598595
2467.00	598491
2468.00	598050
2470.02	598509
2478.02	598836
2479.02	598835
2480.00	598622
2480.21	598814
2482.00	598965
2482.40	598544
2483.02	598600
2485.02	598599
2486.02	598070
2486.11	598429
	598430
2487.02	598800
2487.11	598430
2489.00	601024
2490.02	598022
2493.00	598965
2494.02	598634
2499.00	598642
2501.02	598850
2502.22	598989
2508.02	598355
2508.22	598483
2566.22	598459
2570.02	598904



 	
ROADHOUSE (.../...)	
2571.02	598906
2574.00	598581
2575.02	598619
	598630
2576.00	598441
2577.00	598499
2578.00	598044
2579.00	598045
2580.00	598046
2580.10	598046
2581.10	598308
	598581
2581.80	598581
2582.00	598320
2583.00	598522
2584.00	598762
2586.00	598357
2587.00	601003
2587.01	598041
2587.11	598041
2587.12	598065
2588.01	598040
2588.10	598605
2588.11	598040
2588.20	598607
	601003
2588.31	598880
2589.02	598065
	598308
	598880
2589.12	598880
2589.21	598990
2589.22	598308
2589.32	598308
2589.42	598990
2590.02	598318
2590.12	598318
2590.21	598318
2591.00	598482
2591.10	598482
2591.30	598546
2592.02	598071
2592.52	598697
2594.02	598534
2595.02	598830
2596.00	598412
2596.10	598412
2597.00	598712
2598.02	598523
2598.12	598523
2599.04	598476
2599.12	598476
2600.02	598838
2601.00	598636
2602.02	598073
2603.04	598068



 	
ROADHOUSE (.../...)	
2604.02	598069
2604.04	598069
2604.14	598467
2605.12	598319
2607.02	598449
2608.04	598385
2609.00	598066
2609.10	598488
2609.11	598805
2609.20	598403
2610.00	598556
2614.00	541664
	598966
2614.02	541664
2618.00	598675
2618.01	598676
	598858
2620.00	598217
2620.20	598217
2624.02	598528
2629.02	598509
2630.00	598763
2631.00	598330
2631.10	598017
2631.12	598484
2633.00	598332
2633.20	598332
2633.21	598408
2633.31	598408
2633.41	598408
2634.00	598398
2634.04	598326
2636.04	598496
2638.02	598470
2641.02	598458
2643.00	598461
	598726
2643.01	598726
2643.10	598461
2643.20	598461
2645.02	598361
2645.12	598361
2645.32	598361
2646.10	598902
2647.02	598691
	598915
2649.02	598841
2650.00	598549
2650.22	598582
2651.00	541662
2651.02	541683
2651.10	541717
2651.12	541663
2652.00	598579
2653.00	598766
2654.00	598768







 	
ROADHOUSE (.../...)	
2655.02	598530
2659.04	598420
2660.02	598065
2660.11	598880
2660.22	598880
2666.02	598309
	598772
2666.14	598468
2666.22	598772
2666.32	598919
2674.02	598452
2674.12	598452
2675.02	598575
2676.02	598478
2677.00	598490
2678.00	598444
2683.02	598454
	598860
2684.02	598322
2685.02	598926
2685.22	598926
2686.00	598328
2691.00	598317
2692.00	598142
	598331
2693.00	598431
2694.02	598436
	598451
2694.10	598451
2695.02	598682
	598758
2696.00	598316
2697.01	598442
2698.01	598443
2698.11	598813
2699.00	598548
2700.02	598435
2701.00	598299
2702.02	598991
2702.12	598453
2702.21	598453
2703.02	598908
2704.00	598450
2705.02	598329
2706.00	598865
2707.04	598535
2708.02	598493
2709.00	598447
2709.10	598447
2710.02	598843
2711.04	598524
2712.02	598606
2713.00	598479
2714.00	598480
2717.00	598301
2718.00	598735



 	
ROADHOUSE (.../...)	
2718.11	598734
2719.00	598632
2720.02	598856
2721.02	598858
2722.00	598616
2723.02	598883
2724.02	598733
	598832
2724.11	598733
	598832
2726.00	598462
2726.10	598462
2727.00	598425
2727.10	598407
2727.20	598407
2729.02	598895
2730.01	598784
2731.00	598439
2731.10	598439
2732.00	598438
2732.10	598438
2733.00	598300
2734.02	598504
2735.02	598907
2736.02	598510
2739.02	598511
2740.02	598737
2741.02	598577
2742.00	598827
2743.04	601025
2746.02	598748
2746.12	598748
2746.22	598748
2746.32	598748
2747.12	598452
	598887
2748.02	598889
2749.02	598834
	598866
2750.02	598619
	598778
2752.02	598992
2752.22	598992
2753.02	598543
2758.00	598677
2765.00	598563
2766.00	598564
	598639
2766.12	601026
2767.00	598482
2767.01	598482
	598650
2767.10	598482
2767.12	598650
2768.00	598448
2769.00	598445



 	
ROADHOUSE (.../...)	
2769.02	598445
	598659
2770.00	598446
2771.02	598759
2771.12	598505
2771.22	598505
	598871
2771.32	598506
2772.02	598432
2772.12	598547
2772.22	541733
2774.02	598456
2775.00	598667
2775.01	598720
2776.00	598433
2777.00	598434
2777.10	598434
	598527
2800.12	598647
2800.22	598647
2803.02	598520
	598852
2804.12	598886
2807.02	598414
2810.02	598415
2811.00	598755
2812.02	598905
2813.00	598536
2818.00	598583
2819.00	598537
2820.02	598542
2821.02	598821
2821.12	598821
2822.00	598514
2822.12	598679
2827.04	598416
2828.04	598419
2829.04	598417
2830.00	598418
2830.20	598418
2833.00	598538
2834.00	598545
2834.01	598470
2834.10	598545
2834.20	598669
2835.02	598457
2836.02	598565
2839.02	598673
2840.10	598464
2840.20	598464
2840.30	598464
2841.00	598465
2842.00	598472
	598783
2842.20	598472
	598783
	601005

 	
ROADHOUSE (.../...)	
	601008
	601044
2843.00	598471
2843.10	598471
2845.01	598521
2849.00	541705
2850.02	598745
2852.14	598738
2855.00	598944
2857.00	598410
	598898
2857.10	601027
2858.01	598426
2858.10	598913
2858.11	598426
	598670
	598913
2858.31	598825
2859.01	598427
2859.10	598698
2859.11	598721
2859.21	598839
2860.01	598428
2861.00	598633
2862.00	598643
2862.02	601028
2864.00	598413
2874.02	598680
2875.01	598848
2876.01	598672
	601009
2878.00	601029
2879.02	601001
2879.12	598553
2879.31	598793
2880.00	598501
2881.00	598500
2882.00	598756
2883.11	598831
2884.00	598862
2888.00	598678
2888.40	598678
2892.00	598820
2893.02	598781
2897.00	601004
2897.11	598671
2899.00	598757
2951.02	598853
2951.11	598853
2953.02	598744
2953.12	598744
2953.22	598744
2954.00	598541
2957.02	598584
2959.01	598569
	598570



 	
ROADHOUSE (.../...)	
2960.01	598568
2961.00	598570
2961.02	541738
2962.00	598566
	601012
2963.00	598811
2964.02	598750
2964.12	598779
2964.20	598822
2964.32	598863
2970.02	598648
2971.02	598917
2973.02	598833
2976.00	598558
2976.10	598558
2976.20	598558
2977.00	598557
2978.02	598736
2979.00	598658
2982.00	598767
2984.00	598639
2986.00	598644
2987.00	598641
2987.11	598847
2988.00	598857
2990.02	598638
2991.00	598637
2991.10	598802
2994.00	598655
2995.00	598656
2996.00	598770
2996.10	598770
8048.00	598112
8048.01	598112
8101.00	598182
8101.01	598182
8102.00	598292
8119.00	598212
8119.01	598212
8119.02	598120
	598166
	598212
8119.03	598120
	598166
	598212
8129.00	598122
8134.00	598252
8134.01	598016
8134.02	598016
8134.03	598016
8141.00	598084
8141.01	598084
8141.02	598084
8141.03	598154
8141.04	598002
	598084



 	
ROADHOUSE (.../...)	
8141.05	598002
	598084
8141.06	598002
	598084
8143.00	598153
8144.00	598151
8144.01	598080
8144.02	598396
8146.00	598135
	598219
8146.01	598135
	598219
8170.01	598119
8170.02	598119
8170.03	598119
8170.04	598714
8171.00	598124
8171.01	598128
8171.02	598127
8171.03	598258
8171.04	598258
8189.00	598044
	598315
8192.00	598075
8192.01	598081
8192.02	598081
8192.03	598081
8192.05	598155
	598181
8192.06	598155
	598181
8192.07	598155
	598181
8208.00	598061
8208.01	598061
8208.02	598473
8208.03	598061
8208.04	598473
8208.05	598061
8220.00	598082
8220.01	598082
8224.00	598052
8231.00	598142
8247.00	598156
8247.01	598360
8247.02	598030
8261.00	598138
	598153
8262.00	598179
8263.00	598180
	598463
8263.01	598180
	598463
8263.02	598180
8263.03	598180
	598463



 	
ROADHOUSE (.../...)	
8263.04	598180
8264.00	598095
8270.00	598409
	598811
8284.00	598241
8285.00	598043
	598171
8285.01	598043
	598171
8286.00	598184
8286.01	598184
8305.00	598064
8318.00	598051
	598574
8318.01	598051
8321.00	598295
8331.00	598172
8331.01	598399
8337.00	598022
8337.01	598022
8372.00	598091
8384.00	598018
8384.01	598018
8384.02	598018
8390.00	598483
8390.02	598305
8390.03	598355
8390.04	598067
8390.06	598486
8391.00	598036
8391.01	598036
8392.00	598037
8392.01	598037
8393.01	598039
	598356
8393.02	598039
	598356
8393.03	598039
	598356
8414.00	598011
	598012
8432.00	598033
	598036
	598037
	598619
	598630
8438.00	598031
8445.00	598013
8445.01	598013
8445.02	598013
8461.01	598038
8461.02	598074
8462.00	598602
8462.01	598602
8486.00	598070
8486.01	598070



 	
ROADHOUSE (.../...)	
8487.00	598800
8578.00	598044
8578.01	598044
8587.01	598065
8588.00	598040
8602.00	598073
8603.00	598068
8604.00	598069
8608.00	598385
8609.00	598066
8609.01	598488
8609.02	598403
8609.03	598403
8609.04	598403
8614.00	541664
8631.00	598330
8631.01	598017
8631.02	598017
8631.03	598330
8633.00	598332
8633.01	598408
8633.02	598332
8633.03	598332
8633.04	598332
8634.00	598326
8643.00	598726
8643.02	598461
8643.03	598461
8643.04	598461
8643.06	598461
8643.07	598461
8659.00	598420
8659.01	598420
8677.00	598490
8683.00	598454
8684.00	598322
8691.00	598317
8701.00	598299
8705.00	598329
8726.00	598462
8733.00	598300
8733.01	598300
8774.00	598456
8774.01	598456
8774.02	598456
JSX 2436.40	541641
ROULUNDS	
420283	598146
420481	598217
420581	598846
420981	598169
421183	598187
421381	598105
421881	598167







 	
ROULUNDS (.../...)	
422687	598085
	598153
422881	598053
	598437
422981	598237
	598269
423282	598165
423581	598391
423981	598129
424281	598109
424781	598076
424981	598207
425084	598392
425281	598147
425381	598205
425382	598205
425681	598160
425981	598375
426181	598613
426281	598178
426581	598377
426881	598214
426981	598182
427281	598116
427481	598185
427581	598612
427681	598108
427781	598027
427981	598107
428181	598187
428381	598150
428481	598148
428681	598220
428881	598540
	598984
429081	598086
	598366
430181	598389
430781	598614
430981	598212
431181	598166
	598171
	598212
	598334
431381	598168
431581	598168
432181	598278
432283	598145
432481	598172
432781	598017
432881	598017
433181	598123
	598379
433281	598004
433481	598091
	598093
	598219



 	
ROULUNDS (.../...)	
433781	598219
434481	598149
434581	598384
435083	598174
	598193
435281	598151
435881	598396
435981	598168
436181	598091
436481	598124
436681	598128
436881	598127
436981	598125
437081	598118
437381	598091
	598141
	598219
437781	598497
437881	598132
	598380
	598391
438181	598103
438481	598208
438581	598047
438781	598239
439581	598224
439681	598220
440083	601016
440181	598964
440481	598266
440781	598402
441581	598123
441681	598122
442181	598052
	598131
442281	598131
442581	598134
442781	598113
443081	598129
443381	598184
443681	598296
443981	598179
444381	598227
444581	598266
444681	598217
444781	598248
445081	598250
445681	598239
445981	598253
446081	598497
446381	598293
446981	598130
447581	598047
447881	598002
	598061
448181	598463
	598752



 	
ROULUNDS (.../...)	
448281	598095
	598219
448781	598051
	598574
449281	598269
449481	598231
449981	598594
450181	598241
450281	598099
	598187
450981	598292
451181	598291
451182	598291
451585	598088
451681	598817
451981	598624
452084	598090
	598603
453081	598153
453285	598193
453481	598494
454281	598122
454881	598062
	598295
455181	598290
455881	598135
456084	598144
456181	598022
456381	598053
	598437
456581	598254
456781	598019
457081	598621
457481	598616
458581	598000
	598613
458781	598270
458881	598815
459481	598629
459885	598099
460087	598497
460181	598626
460281	598099
460283	598099
	598187
460581	598590
460781	598123
	598618
460888	598099
461181	598113
461381	598351
461581	598161
	598338
461585	598161
	598338
461881	598024

 	
ROULUNDS (.../...)	
461981	598054
	598450
462081	598104
462281	598646
463283	598111
463481	598106
463781	598025
463883	598108
464181	598691
464581	598015
464781	598393
	598614
	598897
465381	598180
465483	598375
465883	598375
465981	601021
466781	598268
467481	598138
	598153
467883	598109
467981	598110
468581	598121
468781	598183
468981	598240
469581	598030
	598156
469881	598103
	598386
470081	598039
	598356
470281	598119
470581	598130
470881	598126
471181	598010
471781	598230
472081	598018
472286	598107
472381	598227
472981	598030
	598156
473287	598077
	598078
	598081
	598085
473681	598221
473881	598270
473981	598257
474181	598345
474281	598044
	598315
474381	598406
474481	598176
475181	598682
	598911
475881	598038

 	
ROULUNDS (.../...)	
476381	598048
476481	598375
476581	598259
477481	598274
478081	598517
	601020
478487	598337
478581	598120
478781	598183
	598243
478981	598335
479181	598625
479481	598834
479781	598597
480581	598828
481381	598983
481681	598551
	598579
481981	598695
482181	598519
482881	598012
483081	598000
	598005
483781	598036
484081	598628
484881	541641
485281	598786
486481	598037
486681	598020
487081	598043
	598171
487281	598495
	598760
487681	598851
487981	598498
488181	598627
488481	598016
488581	598017
	598252
488981	598668
489081	598056
489381	598809
489481	598947
489781	598123
490581	598022
490881	598826
491381	598903
491681	598034
491981	598714
492281	598179
	598353
492681	598061
493081	598033
493781	598013
493881	598142
	598219

 	
ROULUNDS (.../...)	
494981	598374
495481	598374
495981	598014
496081	598094
496181	598133
	598219
496681	598540
496881	598248
497481	598921
497581	598620
497981	598615
498181	598007
	598374
498381	598032
	598166
498581	598591
498681	598154
498881	598129
499181	598052
499481	598593
499581	598371
499681	598086
499881	598496
525581	598592
528281	598080
528781	598175
529481	598075
	598081
	598177
546881	598082
551381	598029
553781	598155
	598181
554581	598294
557281	598280
576481	598037
582881	598011
583781	598036
586481	598037
592481	598031
592581	598383
593481	598028
	598294
600081	598553
600281	598427
600481	598735
600581	598910
600881	598989
601181	598432
601581	598429
601681	598430
601781	598565
601981	598676
602081	598807
602181	598814
602281	598582

 	
ROULUNDS (.../...)	
602381	598583
602581	598679
602881	598568
602981	598670
	598913
603081	598569
603281	598570
603381	598448
603581	598638
603781	598637
603881	598718
603981	598805
604081	598654
604381	598823
604881	598481
	598616
605081	598635
	598682
	598752
605281	598752
605381	598412
605581	598681
605681	598674
605781	598648
606081	598065
	598308
606181	598558
606381	598835
607681	598682
607981	598451
608081	598667
608181	598720
608281	598665
608381	598002
608681	598649
608881	598715
610681	598504
610981	598557
611181	598848
611681	598483
	598751
611881	598489
611981	598482
	598650
613783	598556
618683	598755
619581	598662
619781	598663
619981	598664
620081	598666
620981	598006
	598010
621181	598093
621481	598507
621781	598460
622181	598618

 	
ROULUNDS (.../...)	
622481	598008
	598289
622681	598135
622881	598003
623081	598186
624081	598602
624181	598296
624381	598040
	598142
624681	598623
624881	598762
625181	598303
	598355
625381	598622
625481	598016
	598125
625581	598055
625781	598050
626681	598113
626881	598115
627081	598351
627281	598044
627481	598045
627681	541664
	598966
627781	598046
628281	598596
628581	598256
628781	598305
	601006
629081	598064
629281	598039
629481	598070
629681	598800
630981	598057
631781	598617
631981	598281
632681	598374
632881	598271
633081	598271
633481	598043
	598171
633681	598212
633881	598788
634281	598330
634381	598982
634581	598021
635081	598041
635381	598880
	598990
636981	598310
	598409
	598811
637181	598311
637381	598068
637581	598069
	598467







 Valeo	
ROULUNDS (.../...)	
637781	598357
637981	598320
638081	598318
638181	598332
638381	598634
638681	598063
638881	598835
638981	598836
639081	598636
639281	598272
639981	598071
640281	598840
640881	598642
641281	598817
642181	598074
642281	598316
	598644
642681	598326
643081	598488
643281	598066
643481	598080
	598396
643681	598599
643881	598533
644381	598532
644981	598777
645581	601023
645881	601022
646681	598393
646881	598482
646981	598441
647181	598499
647381	598319
647481	598258
647681	598017
647781	598675
647981	598067
648581	598052
649281	598440
649781	598361
649881	598985
650081	598581
650481	598093
650881	598278
651481	598476
	598691
	598844
652781	598844
653081	598362
653181	598363
653281	598364
653481	598090
	598603
653581	598444
653681	598763
653781	598163
653881	598162



 Valeo	
ROULUNDS (.../...)	
654581	598102
654781	598091
	598093
655881	598595
656081	598384
656381	598185
656681	598122
657081	598248
657281	598052
658381	598108
	598115
658581	598125
	598141
658881	598598
659281	598120
659481	598312
660381	598787
660781	598600
661481	598103
	598580
661681	598826
662481	598250
662781	598786
663681	598518
663781	598515
664581	598787
664681	598491
665081	601023
665381	598830
665881	598065
666181	598902
666281	598322
666681	598454
	598860
666981	598399
667181	598305
	598475
667481	598478
667781	598619
667881	598630
667981	598512
668081	598601
668181	598926
668581	598549
668681	598483
	598489
	598751
668781	598431
668881	598317
669081	598480
669281	598628
672581	598018
672781	598753
672881	598308
672981	598309
	598772



 Valeo	
ROULUNDS (.../...)	
673181	598423
	601019
673281	598726
673481	598479
673681	598575
677381	598490
677481	598493
677581	598142
	598331
677681	598048
677781	598470
677981	598548
678681	598299
678781	598301
678881	598606
	598737
	598917
679181	598577
679481	598806
	601002
679781	598300
679881	598629
680181	598780
680281	598447
680381	598632
680581	598420
680781	598054
	598450
680981	598991
681381	598843
681581	598908
682281	598458
682581	598403
683181	598453
683681	598537
684081	598040
684281	598538
684381	598661
684581	598433
684681	598434
684781	598547
685181	598564
	598639
685381	598563
685981	598821
686281	598566
	601012
686481	598471
686681	598471
686781	598472
	598783
687281	598418
687381	598465
	598698
687481	598468
687681	598332

 Valeo	
ROULUNDS (.../...)	
687781	598408
687881	598734
688181	598461
688281	598605
	601003
688381	598422
	598424
688481	598607
688581	598407
688681	598880
688781	598308
688881	598425
688981	598473
689081	598328
689281	598484
689381	598462
689481	598811
689581	598678
689781	598435
690081	598436
	598451
690581	598448
690781	598522
691081	598482
691181	598482
	598650
691281	598858
691481	598850
691781	598422
	598584
692081	541662
	541683
	541717
692181	598829
692581	598486
692681	598545
	598669
692781	598546
692981	598697
693281	598733
	598832
693581	598500
693681	598501
693781	598426
693981	598633
694081	598428
694281	598860
694781	601030
695081	598449
695381	598452
695681	598672
	601009
695981	598647
696281	598505
	598871
696581	598748



 	
ROULUNDS (.../...)	
696881	598536
697081	598673
697381	598461
697581	598398
697681	598541
697781	598542
698081	598657
698281	598575
	598708
698581	598653
698881	598329
699181	598480
699281	598464
699381	598360
699781	598579
699881	598524
702481	598680
721281	598181
724281	598002
	598084
725081	598035
725981	598382
729281	598502
742581	598073
742881	598158
	598396
763681	598518
763781	598515
765481	598385
769481	598075
783481	598456
786981	598417
787081	598419
787181	598416
790381	598682
	598758
790481	598457
792881	598533
	598534
800081	598736
800181	598514
800281	598896
800381	598466
800581	598413
800681	601028
800781	598643
800881	598812
800981	598641
801083	598459
808381	598616
813081	598658
813281	598580
813481	598841
813781	598865
813881	598445
813981	598543



 	
ROULUNDS (.../...)	
814281	598544
814481	598820
814681	598827
814781	598489
	598801
814981	598639
815181	598445
	598659
815281	601004
815381	598527
815581	598651
815781	598740
815881	598472
	598783
	601005
	601044
820483	598510
820783	598677
827581	598839
827781	598825
827881	598438
832683	598862
832981	598722
834583	598872
838181	598355
838281	598442
838381	598813
838481	598819
838581	598756
838681	601052
838781	598943
838881	598943
	601037
839081	598824
839181	598847
839281	598750
844481	598699
844581	598699
	598700
844781	598701
844881	598703
844981	598925
845081	601041
845181	598640
845281	598939
845381	598702
845681	598882
845781	541728
845881	598863
846081	598889
846181	598738
846381	598874
846481	601007
846581	598879
846681	598935
846781	598928



 	
ROULUNDS (.../...)	
846881	598472
	601005
	601044
846981	598899
847081	598793
847181	598727
847281	598804
847481	598803
847581	598849
847781	598868
847881	598867
847981	598707
848081	598706
848181	598705
848281	598744
848381	598741
848481	598742
848981	601051
849081	598942
849181	598941
849281	598729
849481	598523
849581	598808
853183	601033
856481	598927
856681	598696
856781	601015
856981	598888
857081	598892
857481	598997
857981	598842
858181	598509
858381	601039
858481	598933
858681	601034
858781	598728
858881	598845
858981	598992
859081	598946
859181	598656
859281	598995
859581	598712
859681	598802
860281	598754
860381	598640
	601027
860581	598410
	598898
860681	598757
860781	601038
	601043
861081	598842
861181	598987
861881	598682
861981	598940
862081	598474



 	
ROULUNDS (.../...)	
862181	598770
862381	598996
862481	601040
862581	598933
867781	598998
867881	541734
868081	598652
868681	601042
868981	598831
869481	601010
869681	541737
869781	541738
869881	598678
870481	541735
870581	598934
870681	598945
870781	598914
870881	598361
871181	598881
871281	598994
871681	598967
872181	598710
872281	598894
872681	598739
872881	598893
872981	598932
913181	598818
913381	598816
914181	598439
914381	598439
915281	598671
915681	541736
930583	598520
	598852
937581	598833
939381	598877
947381	598887
948781	598746
957281	598877
958581	598999
960981	598852
972781	598875
TEXTAR	
19706 1797 0 5 D7113	598112
19706 1797 0 5 T016	598112
19706 1797 0 5 T088	598112
20007 15.2 0 4	598374
20008 13.0 0 4	598624
20009 15.0 0 4	598099
	598187
20011 15.0 0 4	598111
20011 150 0 4 T424	598111
	598183
	598256







 	
TEXTAR (.../...)	
20011 19.0 0 4	598106
	598111
2001115004T400	598111
20031 130 0 4	598780
20034 15.0 0 4	598099
	598113
	598187
	598270
20034 15.0 0 5	598099
	598113
	598187
	598270
20038 13.8 0 4	598392
2003813804T4047	598392
20073 17.3 0 4	598090
	598603
2007317304T468	598603
20074 10.0 0 4	598088
20076 155 0 5	598983
	598984
2007615505T4067	598983
	598984
20088 14.4 0 4	598161
	598270
	598338
20098 17.0 0 4	598851
2009817004T4067	598851
20124 19.0 1 4	598025
	598048
20126 15.0 0 4	598099
20140 14.0 0 5	598077
	598078
	598085
20145 17.0 0 5	598174
20153 16.0 0 4	598337
20162 15.4 0 4	598292
20164 18.2 1 4	598695
20164 182 0 4	598695
20166 16.0 0 4	598405
20168 16.2 1 4	598004
	598016
20168 19.6 1 4	598017
	598252
20168 196 1 5	598982
20173 14.5 0 4	598099
20180 16.8 0 5	598386
20207 13.0 0 4	598144
20224 209 0 5	598808
20228 15.2 0 4	598099
20228 18.5 0 4	598099
20236 18.2 1 5	598382
20253 16.4 0 5	598193
20260 15.2 0 4	598174
	598375
20260 15.2 0 5	598375
20260 165 0 4	598077
	598375



 	
TEXTAR (.../...)	
20260 18.5 0 4	598375
20261 193 1 5	598553
20285 07.1 0 4	598362
20288 16.0 0 4	598145
20292 17.0 0 5	598090
20292 170 1 4	598090
20293 12.0 0 4	598094
2029312004T4047	598094
20297 11.7 0 4	598146
20307 10.5 0 4	598363
20315 15.0 0 4	598396
20323 165 0 4	598108
20323 165 0 5	598115
20332 17.0 2 5	598000
	598005
20336 14.0 0 5	598085
20341 17.5 0 4	598110
20344 15.0 0 4	598497
20356 15.5 0 4	598147
20359 18.0 0 4	598129
20359 180 0 5	598129
20359 180 1 4	598129
20361 16.5 2 5	598008
	598289
20364 15.0 0 5	598391
20364 150 2 5	598129
	598391
20366 15.0 0 5	598593
	598594
20371 08.1 0 4	598364
20373 16.5 0 5	598115
20375 16.0 0 4	598371
20379 165 0 5	598115
20380 15.6 0 4	598374
20380 15.6 0 5	598374
20387 150 0 5	598351
20389 16.0 0 4	598207
20392 15.0 0 4	598109
20392 18.5 0 4	598109
	598110
20410 15.0 0 5	598055
	598080
	598396
20421 15.0 0 4	598081
20421 15.0 0 5	598081
20422 17.5 0 4	598165
20436 15.0 0 4	598187
2043615004T477	598187
20437 15.0 0 4	598107
20437 19.0 0 4	598107
2043715004T476	598107
2043719004T4078	598107
20442 18.5 0 5	598086
	598366
20455 19.0 0 5	598178
	598193



 	
TEXTAR (.../...)	
20468 150 0 4	598111
20480 15.5 0 4	598076
	598377
20488 18.5 0 5	598366
20491 15.1 0 4	598168
20494 14.0 0 5	598077
	598085
20547 16.8 0 5	598039
	598356
20573 15.0 1 4	598592
20574 15.3 1 4	598214
20574 19.6 1 4	598205
20575 17.0 0 4	598148
	598292
20576 155 0 4	601016
20579 14.4 0 5	598161
	598187
20588 16.5 0 4	598108
2058816504T4078	598108
20594 13.0 0 4	598150
20628 165 0 4	598122
20629 20.0 0 5	598104
2062920005T476	598104
20631 18.0 0 5	598077
	598085
	598175
20634 15.0 0 4	598080
20635 18.0 0 5	598151
20652 18.2 1 5	598048
20653 180 0 5	598129
	598132
20655 19.5 0 4	598591
20660 15.6 0 4	598389
20667 155 0 4	598145
20669 162 1 4	598004
20669 19.6 1 5	598017
20669 196 1 4	598017
20671 16.5 1 5	598377
20675 17.0 0 5	598103
	598291
2067517005T477	598103
20687 13.5 0 4	598105
20687 15.5 0 4	598345
20690 16.0 0 4	598149
20699 15.2 0 5	598620
20699 152 0 4	598620
20708 16.5 2 4	598093
	598531
20708 16.5 2 5	598093
	598133
	598603
2070816525T4047	598093
	598133
20714 130 0 4	598144
20718 14.3 0 5	598379
20718 143 0 4	598123
	598379

 	
TEXTAR (.../...)	
2071814304T4047	598379
20719 19.6 2 5	598219
20724 15.5 0 4	598220
20729 15.0 0 5	598614
2072915005T4047	598614
20731 15.2 0 4	598185
2073115204T4047	598185
20735 15.1 0 4	598208
2073515104T4047	598208
20741 19.2 1 5	598153
20753 18.0 0 5	598166
	598212
2075318005T403	598166
	598212
20754 15.0 0 5	598116
20755 15.0 0 4	598270
	598621
20755 150 1 4	598270
20760 14.3 0 4	598612
20761 14.5 0 5	598117
20778 19.6 1 4	598017
20783 18.0 0 5	598166
	598212
	598334
20784 18.0 0 4	598613
20833 17.1 2 5	598093
	598095
	598141
	598219
20833 17.2 2 5	598006
	598134
	598219
2083317125T479	598141
	598219
20841 12.0 0 4	598141
20845 16.5 1 4	598163
20852 15.5 0 4	598921
2085215504T4047	598921
20857 17.5 0 5	598167
20861 17.7 1 4	598217
20861 17.7 1 5	598169
20863 17.2 0 4	598122
	598123
20863 17.2 0 5	598122
2086317204T4047	598122
20870 15.0 0 4	598266
	598402
	598579
2087015004T4047	598266
	598402
	598551
	598815
20871 18.0 0 5	598162
20887 15.3 2 5	598124
	598128
20887 17.3 2 5	598258



	
TEXTAR (.../...)	
20887 19.7 2 5	598128
20889 17.3 2 4	598127
20894 150 0 5	598391
20895 14.5 0 5	598131
20905 18.0 0 5	598002
	598075
	598081
	598177
	598181
	598338
20905 18.0 2 5	598081
	598177
20906 18.0 2 5	598075
	598081
	598155
	598181
20906 18.0 4 5	598155
	598181
20906 180 0 5	598075
20907 18.0 0 5	598120
	598335
20908 180 0 5	598120
	598335
20910 15.0 0 4	598187
20910 16.5 0 4	598107
	598187
20911 15.0 0 5	598113
20912 15.0 0 5	598351
20913 16.5 0 4	598375
20913 16.5 0 5	598375
20915 18.0 0 5	598181
20922 15.0 0 4	598111
20926 185 0 5	598086
20937 18.2 1 5	598002
20939 15.4 0 4	598182
20941 19.3 1 4	598044
	598315
20941 193 1 4 T4100	598315
20944 15.0 0 4	598130
20944 15.0 0 5	598130
20946 16.5 2 5	598091
	598093
20950 18.0 0 5	598091
2095018005T468	598091
20955 15.0 0 4	598220
	598620
	598626
20957 16.0 0 4	598384
20957 16.0 0 5	598278
	598384
20958 16.0 0 4	598278
2095816004T4047	598278
20959 14.0 0 4	598047
20959 150 0 4	598047
20959 150 0 5	598047
2095915004T4047	598047



	
TEXTAR (.../...)	
2095915005T4047	598047
20961 15.2 1 4	598180
20961 15.2 3 4	598180
20961 17.2 1 4	598463
20961 17.2 3 4	598180
	598463
20961 17.3 1 4	598180
	598463
20961 174 1 4	598463
2096117215T456	598681
20968 17.5 0 5	598440
20968 20.3 0 5	598231
2096820305T476	598231
20973 11.0 0 5	598158
	598396
20974 110 0 4	598396
20979 19.7 1 4	598027
20981 137 1 4	598240
20989 17.7 0 5	598119
	598176
	598714
20990 20.3 0 5	598409
20995 17.3 0 5	598103
	598259
	598311
20997 16.5 0 5	598115
21000.15.0 0 5	598077
21010 15.8 1 4	598102
21012 14.0 0 4	598052
21012 14.8 0 4	598052
21012 14.8 0 5	598052
	598817
2101214804T4047	598052
2101214805T4047	598052
21016 170 1 4	598082
21035 15.5 0 4	598099
21041 15.0 0 5	598239
21045 150 0 4	598208
2104515004T4047	598208
21048 183 0 5	598007
21050 15.7 0 4	598183
21050 152 0 4	598183
21051 15.7 0 4	598183
	598243
21055 17.9 1 4	598241
21055 179 1 4 T4100	598241
21068 17.7 1 4	598237
	598269
21084 17.5 1 5	598118
21089 15.0 0 5	598291
21093 17.4 2 5	598133
	598134
	598135
2109317425T4078	598133
	598134
21096 150 0 5	598080



	
TEXTAR (.../...)	
21099 17.0 0 4	598112
	598123
21099 17.0 0 5	598123
2109917005T4047	598123
21100 17.0 2 5	598095
2110017025T479	598095
21103 14.4 1 4	598142
21107 12.0 0 4	598141
21122 15.0 0 4	598817
21125 14.5 0 4	598964
21126 15.0 0 4	598224
21127 14.5 0 5	598131
21131 15.0 0 4	598126
	598160
21131 15.0 0 5	598126
	598160
21138 19.5 1 5	598230
21140 15.7 0 4	598183
	598253
21141 18.0 0 4	598032
21142 155 0 4	598021
21144 16.6 1 4	598016
	598125
	598142
2114416614T425	598125
	598142
21147 19.3 2 5	598006
	598985
21153 17.5 0 4	598601
21154 19.5 0 5	598269
21156 17.4 2 5	598003
21158 156 0 4	598402
	598614
	598947
21158 16.0 0 4	598402
	598614
2115815604T4090	598402
	598947
21160 18.0 0 5	598380
	598391
2116018005T4047	598380
21165 165 2 5	598289
21170.17.0 1 4	598406
21171 18.0 0 5	598172
21171 180 0 4	598172
2117118004T403	598172
	598399
21179 16.8 0 5	598030
	598156
21182 19.4 2 5	598010
	598135
21185 19.4 2 5	598135
21188 183 0 5	598007
	598139
	598374
21190 17.5 0 5	598184



	
TEXTAR (.../...)	
21193 18.0 0 5	598271
2119318005T4047	598271
21195 18.0 0 5	598271
21197 15.0 0 4	598272
21202 17.8 0 5	598043
	598171
21205 19.4 1 5	598138
21209 19.4 1 5	598179
	598353
21211 18.7 0 5	598281
21217 17.5 1 4	598015
21217 181 1 4	598015
21225 17.5 0 5	598186
21225 17.5 1 5	598186
2122517515T490	598186
21233 16.7 1 4	598222
	598257
21237 15.0 0 5	598497
	598499
21245 17.4 0 5	598227
21266 17.4 1 4	598221
21267 17.6 0 5	598156
	598360
21273 19.5 0 5	598616
2127319505TX4005	598616
21275 16.9 0 5	598039
	598502
21275 169 1 5	598502
21277 15.0 1 5	598293
21277 150 0 5	598293
21278 17.0 0 5	598063
	598295
21278 170 1 5	598063
21280 16.0 0 4	598024
	598123
21282 17.3 0 5	598103
21296 17.0 0 5	598029
	598294
21298 17.0 1 4	598294
21305 15.5 0 4	598617
21305 155 0 4 T4023	598617
21305 155 0 4 T4140	598617
21305 155 0 4 T4250	598617
21305 160 0 4 T4210	598617
21312 13.0 0 5	598053
2131213005T4067	598053
21322 15.0 0 5	598047
	598248
2132215005T4047	598248
21333 15.0 0 5	598666
21336 150 0 5	598532
21344 16.0 0 5	598296
21347 17.0 0 5	598123
	598618
2134717005T4047	598618
21350 14.8 0 5	598047
	598495







	
TEXTAR (.../...)	
21355 14.5 0 5	598268
21358 19.8 0 5	598619
21363 15.7 0 5	598517
	601020
21365 17.0 0 4	601021
21366 19.6 1 4	598982
21368 18.0 0 5	598256
21368 18.3 1 5	598256
2136818314T4136	598256
21369 15.5 0 5	598496
21370 157 1 4	601020
21372 15.0 0 4	598266
2137215004T4090	598266
21373 16.5 0 5	598597
21376 15.5 0 5	598266
21378 15.0 0 5	598250
21381 180 0 5	598988
2138217305	598859
21385 13.3 1 4	598621
21385 139 1 4	598621
21388 18.3 1 5	598061
21388 183 2 5	598061
21394 18.8 0 5	598034
21394 185 0 5	598034
2139418505T403	598034
21411 17.5 0 5	598050
21414 18.0 0 5	598075
21414 18.5 0 5	598075
21430 17.3 0 5	598038
21436 17.0 0 4	598012
21436 170 1 4	598011
	598987
2143617004T4078	598012
21439 20.3 2 4	598013
21446 17.5 0 5	598056
	598227
21454 185 1 5	598483
21459 18.5 0 5	598129
	598498
21460 18.0 2 5	598154
21463 18.2 2 4	598002
	598084
21463 18.2 3 4	598002
	598084
21463 182 1 4	598002
2146318224T4078	598002
	598084
21468 15.5 0 4	598947
2146815504T4090	598947
21469 19.0 0 4	598037
21469 190 1 4	598037
2146919004T403	598037
21470 19.0 0 4	598036
21470 190 1 4	598036
2147019004T403	598036
21479 19.2 1 4	598622



	
TEXTAR (.../...)	
21479 192 1 5	598814
21481 15.7 1 4	598602
2148217005	598476
	598691
21484 20.8 0 5	598712
2148420805T4205	598712
21486 19.3 0 5	598412
21486 193 0 5 T4374	598412
21486 193 0 5 T4383	598412
2148619305T4124	598412
21487 17.2 0 5	598580
21487 172 0 5 T4140	598580
21487 173 1 5	598580
2148717205T4001	598580
2148717205T4147	598580
2148717315T4071	598580
21490 171 0 5	601023
21491 155 0 5	601022
2149115505T4067	601022
21492 195 0 5	598616
2149219505TX4005	598616
21495 17.0 0 5	598691
2149517005T4047	598915
21497 18.0 0 5	598788
21500 14.8 0 5	598023
	598531
21504 17.0 1 5	598028
	598294
21507 17.0 1 4	598280
21515 18.0 0 5	598022
21515 180 0 4	598512
21515 180 1 5	598022
21518 17.0 1 4	598254
21519 18.0 0 4	598623
21520 18.0 1 5	598019
21526 17.0 0 5	598051
	598786
2152617005T4047	598786
21539 15.0 0 5	598646
21543 16.5 0 5	598020
2154316505T4047	598020
21545 15.6 1 4	598057
2154515614T4047	598057
21546 17.5 0 4	598054
2154617504T4047	598054
21553 14.0 0 5	598817
21557 19.3 2 5	598010
	598985
21558 13.0 0 4	598780
	598846
21559 12.5 0 4	598624
	598835
21561 17.0 0 5	598787
2156117005T4136	598787
21562 170 0 5	601013
21573 14.0 1 5	598000
	598112



	
TEXTAR (.../...)	
21576 20.5 0 5	598044
21576 20.7 0 5	541664
	598044
21576 207 1 5	598044
21580 143 0 5	598914
2158014305T4018	598914
21586 157 1 4	598035
21589 145 1 4	598180
21592 18.8 0 5	598046
21592 188 1 5	598046
21595 18.3 2 5	598599
21597 110 1 5	598158
21601 17.6 0 5	598551
	598579
	598809
2160117605T4090	598551
	598809
21606 16.6 2 4	598581
2160616624T4064	598581
21607 17.3 0 5	598386
	598753
2160717305T4060	598386
21614 18.0 0 5	598714
21621 17.3 0 5	598045
21621 173 1 5	598045
21624 20.4 0 5	598067
	598355
21625 18.0 0 5	598120
21626 15.8 0 4	598014
21631 17.0 1 4	598031
21632 16.0 1 4	598383
21635 182 1 5	598048
21636 19.3 0 5	598065
2163619305T4088	598308
21637 18.8 0 5	598308
21637 190 0 5	598308
2163718805T4088	598308
21643 17.8 0 5	598018
2164317805T4020	598018
21647 16.0 0 5	598625
21650 15.0 0 4	598626
21650 150 1 4	598626
21651 17.3 0 5	598627
21654 15.0 0 5	598274
	601018
21654 153 1 5	598274
21657 16.5 0 5	598628
21662 178 1 4	598217
21664 19.8 0 5	598357
21670 20.3 0 5	598636
21670 203 0 5 T4374	598636
21674 19.3 1 5	598069
	598467
21677 20.3 0 5	598310
	598409
21677 203 0 5 T4374	598310
	598409

	
TEXTAR (.../...)	
2167720305T4070	598310
	598409
21679 15.0 0 5	598897
2167915005T4067	598393
	598897
21682 14.5 1 5	598903
21691 173 0 5	598311
21691 173 0 5 T4140	598311
21694 17.3 0 5	598494
2169417305T4047	598494
21697 158 0 5	598495
	598760
2169715805T4047	598495
2170018505T4047	598627
21703 15.0 0 5	598828
21706 15.5 0 5	598519
	598834
21713 16.4 0 5	598668
	598826
21716 15.9 0 5	598840
21719 14.6 0 5	598682
	598911
2171914605T4067	598682
	598911
21724 19.3 1 5	598068
21725 156 0 5	598870
21725 17.0 0 5	598051
	598574
	598786
2172517005T4047	598051
	598574
21729 13.7 1 5	598121
	598240
	598312
21729 13.7 2 5	598121
	598312
21730 140 0 4	598986
21731 15.5 0 5	598250
21734 14.0 0 5	598826
2173414005T4067	598826
21738 13.0 0 5	598437
21754 16.5 0 5	598629
21759 15.3 0 5	598983
21763 156 0 5	598266
2176315605T819	598266
21766 137 1 4	598290
21766 14.8 0 4	598290
21775 150 0 5	598393
2177515005T4047	598393
21777 15.0 0 5	598897
21780 15.5 0 5	598496
21792 155 0 4	598768
2179215504T4045	598768
21797 19.7 2 5	598070
21799 19.7 2 5	598800
21801 19.3 2 5	598064

 	
TEXTAR (.../...)	
2180718005	598965
21815 193 0 5	598600
2181517005	598600
21820 15.5 0 5	598595
21822 17.2 0 5	598491
21827 17.3 0 5	598038
	598074
21829 20.3 0 5	598305
21830 15.7 0 5	598906
21833 15.5 0 5	598540
	598984
2183315505T4067	598540
	598984
21836 155 0 5	598496
21840 14.0 0 5	598519
21845 16.5 0 5	598460
2184516505T4047	598460
21848 19.7 0 5	598067
	598303
21849 20.6 0 5	598489
21854 150 0 4	598476
21857 170 0 5	598156
	598360
21861 15.3 1 4	598319
2186116815T4127	598319
21862 18.0 0 5	598184
21862 183 0 5	598184
21866 15.3 0 5	598403
21866 17.2 0 5	598488
21866 17.3 0 5	598488
21866 19.7 0 5	598066
21868 172 0 5	598805
21872 14.5 0 5	598844
21875 15.8 0 5	598507
21879 18.5 0 5	598056
21882 17.3 1 4	598482
21883 19.6 0 5	598675
21885 20.6 0 5	598676
21888 184 1 5	598470
21892 18.4 0 5	598838
21898 15.7 0 5	598447
21898 157 0 5 T4080	598447
21898 157 0 5 T4140	598447
21898 157 0 5 T4209	598447
21900 15.8 0 4	598763
21904 16.9 0 5	598062
21907 15.4 0 5	598533
21910 19.8 0 5	598630
2191019805T403	598630
21911 20.6 0 5	598303
21919 15.3 0 4	598444
21919 15.7 0 4	598444
21919 153 0 4 T4140	598444
21919 153 0 4 T4203	598444
21919 157 0 4 T4271	598444
21920 15.1 1 4	598318

 	
TEXTAR (.../...)	
21920 174 1 4	598318
21927 179 0 5	598041
	601003
21927 179 9 5	601003
21929 17.9 0 5	598040
	598065
21930 17.9 0 5	598040
	598041
	598607
	601003
21931 179 0 5	598607
21934 163 0 5	598753
21934 17.3 0 5	598753
21934 173 0 5 T4140	598753
2193417305T4147	598753
21937 155 0 4	598766
2193715504T4045	598766
21938 20.4 0 5	598483
	598751
21938 204 0 5 T4374	598483
	598751
21945 16.2 1 4	598330
21945 19.6 1 4	598017
21945 19.6 1 5	598484
21947 15.0 0 4	598777
2194715004T4067	598777
21948 136 0 5	598815
2194813605T4047	598815
21952 15.6 0 5	598850
2195215605T4067	598850
21955 16.0 0 5	601022
21957 17.0 0 5	601023
21961 155 1 4	598809
2196115504T4047	598809
21962 180 0 5	598271
21965 150 0 5	598328
21968 14.0 0 5	601024
21975 18.2 0 5	598478
2197518205T4068	598478
21980 18.0 2 5	598461
	598726
21980 180 1 5	598726
21983 165 1 4	598493
21983 17.3 1 4	598493
2198317314T4095	598493
21990 20.3 0 5	598409
21999 15.8 1 5	598329
23004 15.5 0 5	598071
23018 20.4 0 5	598483
	598751
23020 17.9 0 4	598301
23021 18.9 0 4	598300
23021 189 1 4	598300
23022 20.9 0 4	598299
23022 209 1 4	598299
23023 15.0 0 5	598449

 	
TEXTAR (.../...)	
23032 155 0 5	598496
2303215505T4047	598496
23034 18.6 0 1	598858
23034 186 0 5	598858
23042 19.0 1 4	598073
2304219014T4059	598073
23043 186 0 5	598556
23055 17.9 1 4	598301
23057 20.4 0 5	598454
2305720405T4097	598454
23063 17.3 0 5	598322
2306317305T4097	598322
23070 165 1 4	598549
23070 165 2 4	598549
23070 17.0 1 4	598549
23070 17.0 2 4	598549
23070 190 2 4	598582
23071 18.5 1 5	598033
23073 18.9 0 5	598479
2307318905TX4005	598479
2307418905	598479
23076 17.5 0 5	598480
2307617505T4067	598480
23078 15.9 0 4	598446
23080 151 1 4	598320
23081 190 0 5	598634
2308119005T4047	598634
23086 17.0 0 5	598523
2308616005	598523
23091 152 1 4	598183
23092 150 0 5	598919
23092 16.0 0 5	598309
23092 160 0 5	598772
23094 170 0 5	598436
	598451
2309417005T4047	598451
23095 170 0 4	598451
23096 172 0 5	598435
23099 18.4 0 5	598669
23099 184 0 4	598545
2309918404T424	598545
23101 17.5 0 5	598043
	598171
2310117505T403	598043
23103 17.5 0 5	598212
23106 18.9 0 5	598481
23112 191 0 5	598632
2311219105T4146	598632
23115 196 0 5	598305
23116 19.6 0 5	598305
	598475
23117 202 0 5	598475
2311720205T4139	598475
23124 19.0 1 5	598326
23124 193 1 5	598326
23126 175 0 5	598440

 	
TEXTAR (.../...)	
23130 19.7 0 5	598332
23131 19.7 0 5	598332
	598408
23135 18.0 1 5	598420
23138 14.6 1 4	598583
23138 146 1 4 T4051	598583
23138 146 1 4 T4099	598583
23140 19.3 0 5	598880
2314019305T4047	598880
23144 19.4 1 5	598448
23144 198 1 5	598448
23144 198 1 5 T4374	598448
23144 198 2 5	598448
23144 198 2 5 T4374	598448
23146 17.0 1 5	598385
23146 170 1 4	598385
23154 19.3 0 5	598317
23157 160 0 4	598719
23157 160 0 4 T4140	598719
23168 19.3 2 5	598010
	598985
2316819325T4005	598010
23169 194 1 5	598353
23172 18.3 1 4	598473
23176 18.2 1 5	598807
23177 14.4 1 4	598142
	598331
23178 160 0 5	598907
2317816005T4047	598907
23181 17.9 0 5	598605
23183 20.3 0 5	598811
23183 203 0 5 T4374	598811
2318320305T4217	598811
23184 145 0 5	598912
23189 16.7 1 5	598443
23190 167 1 5	598813
23193 16.5 1 5	598442
23193 163 1 5	598442
23200 18.8 0 5	598563
23202 18.8 0 5	598564
23215 183 1 5	598566
	601012
23218 18.0 0 5	601019
23219 180 0 5	598423
2321918005T4047	598423
23222 190 0 5	598990
2322219005T4292	598990
23224 17.3 1 4	598650
23224 173 1 5	598482
	598650
23225 17.0 1 5	598456
23227 18.0 0 5	598422
	598424
23229 180 0 5	598006
23230 158 0 5	598528
	598988







Valeo	
TEXTAR (.../...)	
23234 16.9 0 5	598361
23237 14.5 1 4	598902
23238 160 0 5	598575
23241 15.4 0 4	598316
23241 165 0 4	598316
23242 14.2 1 5	598854
23245 183 1 5	598471
23248 183 1 5	598471
23250 165 0 5	598661
2325016505T4047	598661
23253 15.5 0 5	598453
2325315505T4047	598453
23258 16.9 2 5	598926
2325816925T428	598926
23269 20.1 0 5	598565
23271 17.7 0 5	541655
	598445
23271 177 0 5T4374	598445
23273 180 1 4	598416
23276 17.5 1 4	598417
23277 17. 7 1 4	598419
23279 18.4 0 4	598433
23279 184 1 4	598433
23280 183 0 5	598992
23281 18.3 0 5	598413
23281 183 0 5T4374	598413
23284 14.0 1 4	598457
2328414014T4131	598457
23287 17.8 0 5	598018
23287 178 0 5T4374	598018
2328717805T4146	598018
23289 19.3 0 5	598065
	598308
23289 190 0 5	598065
	598308
	598990
2328919305T4088	598990
23290 155 1 4	598522
23294 165 0 4	598579
2329416504T4047	598579
23296 150 0 5	598991
23300 18.0 0 5	598399
23302 175 0 4	598490
23305 15.4 0 4	598418
2330917305T4071	598820
23312 203 0 5	598410
2331220305T4165	598410
23313 203 0 5	601027
23314 14.5 1 4	598534
2331414514T4067	598534
23318 159 0 5	598904
23326 17.7 1 4	601004
23326 177 2 4	598671
23329 170 0 4	598767
2332917004T4045	598767
23331 160 0 4	598944



Valeo	
TEXTAR (.../...)	
2333116005T4146	598944
23332 180 1 5	598462
23334 16.8 0 5	598637
23334 168 0 5T4140	598637
23340 168 1 5	598736
2334016815T4018	598736
23346 19.3 1 4	598398
2334720305T4165	598410
23348 165 0 5	598606
2334816505T4047	598606
23353 14.0 1 4	598431
23354 136 1 4	598836
23358 180 0 5	598458
23361 150 0 5	598459
23384 180 0 5	598989
2338418005T4047	598989
23387 133 1 5	598835
2338713005T4067	598835
23392 20.6 0 5	598486
23394 145 0 5	598735
2339414505T4047	598735
23395 14.5 0 5	598734
23396 18.0 1 4	598462
23397 194 1 5	598658
2339719415T4070	598658
23400 16.5 1 4	598830
2340016514T4067	598830
23402 20.6 0 5	598678
2340220605T4139	598678
23404 20.4 0 5	598678
	598808
23404 204 1 5	598808
23407 19.3 1 5	598500
23409 19.3 1 5	598501
23417 15.2 1 5	598584
23417 152 1 4	598584
23418 196 0 5	598801
23420 165 0 5	598452
2342016505T4047	598452
23423 178 1 4	598439
23424 178 1 4	598438
23429 150 0 4	601025
2342915004T4051	601025
23434 185 1 5	598547
2343418515T4194	598547
23435 185 1 5	541733
23440 171 0 5	598639
23440 176 0 5	598639
2344017605T4149	598639
23442 160 0 5	598511
23446 16.5 1 5	598650
	598681
23447 173 0 5	598411
2344717305T4166	598411
23452 190 1 4	598441
2345219014T4047	598441



Valeo	
TEXTAR (.../...)	
23454 150 0 4	598642
2345415004T4067	598642
23455 130 0 5	598841
23458 150 1 4	598499
2345815014T4047	598499
23463 166 0 4	598450
2346316604T4047	598450
23470 178 1 4	598439
23471 150 0 4	598762
2347115004T4047	598762
23482 16.8 0 5	598472
	598783
2348216805T4140	598472
	601005
23487 155 0 4	598521
2348715504T4047	598521
23488 160 1 4	598518
2348816014T4067	598518
23490 150 1 4	598548
2349015014T4067	598548
23494 140 0 5	598883
23497 155 0 5	598856
23501 172 0 5	598589
2350117205T4136	598589
23502 160 0 5	598806
	601002
2350216005T4067	598806
23507 15.0 0 5	598733
	598832
2350715005T4047	598453
	598733
	601002
23510 15.5 0 5	598737
	598917
2351015505T4047	598737
	598917
23515 160 1 4	598515
23517 16.5 0 4	598407
23517 165 1 4	598407
2351716504T4067	598407
2351817005T4047	598504
23521 14.0 0 5	598577
	598737
23524 177 0 5	598535
2352417705T4067	598535
	598777
2352617504T4136	598827
23527 150 1 4	598682
	598758
2352715014T4067	598682
23532 200 0 5	598543
23536 155 0 5	598908
2353615505T4047	598908
23539 175 0 4	598865
23540 165 1 4	598784
23543 150 0 5	598748

Valeo	
TEXTAR (.../...)	
2354315005T4067	598748
23549 168 1 5	598319
23550 173 0 5	598885
23550 173 0 5T4140	598885
2355017305T4191	598885
23552 180 0 5	598422
	598424
23554 152 1 4	598180
	598463
	598474
23554 17.2 1 4	598180
	598463
23554 172 1 4T4140	598180
	598463
23554 172 1 5	598674
	598681
23557 169 1 4	598527
23557 172 1 4	598434
23558 170 0 5	598530
23561 170 0 5	598965
23569 17.0 0 5	598505
	598759
23572 138 0 5	598895
23575 160 0 5	598468
2357516005T4194	598468
23577 18.5 1 5	598432
23581 190 1 4	598667
23581 190 1 5	598720
23582 155 1 5	598520
	598852
2358215515T4067	598520
23584 160 1 4	598886
2358416014T4047	598886
23585 17.0 0 5	598536
23587 203 0 5	598635
23589 19.0 0 5	598715
23590 190 0 5	601030
2359019005T4136	601030
23593 150 0 5	598778
2359315005T4067	598778
23597 180 1 5	598461
23599 19.0 1 4	598464
23600 19.0 1 4	598465
23601 13.7 0 4	598425
23601 137 1 4	598425
23602 197 2 5	598429
	598430
2360219725T4059	598429
23603 19.7 2 5	598429
	598430
23604 18.8 0 5	598564
23605 15.5 1 5	598453
23608 150 0 5	598866
2361119005	598524
23613 178 0 4	598537
2361317804T4136	598537



	
TEXTAR (.../...)	
23615 175 0 4	598514
2361517504T4136	598514
23620 16.6 0 5	598812
23620 166 1 5	598812
23623 17.4 1 5	598701
23623 174 2 5	598701
23631 178 0 5	598510
23638 175 0 5	598414
23640 180 0 5	598415
23646 160 0 5	598542
23649 162 0 5	598821
23652 14.8 0 5	598682
23656 14.0 0 5	598673
23662 15.0 1 4	598843
2366215014T4067	598843
23669 16.8 1 4	598538
23671 170 1 4	598406
23692 167 0 4	598655
23693 167 0 4	598656
23694 167 0 4	598770
23698 160 0 5	598738
23705 178 1 4	598913
23705 178 1 5	598426
	598670
2370517014T4047	598913
2370517015T4047	598426
	598670
23708 18.2 0 4	598698
23708 18.2 0 5	598427
23708 182 1 4	598465
	598698
23708 182 1 5	598427
	598721
23711 182 1 5	598428
23714 15.5 0 4	598633
23714 155 1 4	598633
23716 163 0 5	598643
2371616305T4047	598643
23720 170 0 5	598824
23723 182 0 5	598649
2372318205T4370	598649
23729 170 0 5	598887
2372917005T4136	598887
23730 173 0 5	598820
23730 173 0 5 T4140	598820
2373017305T4166	598820
23732 173 0 5	598754
2373217305T4161	598754
23738 20.6 0 5	598678
23743 20.5 1 5	598638
23743 205 2 5	598638
23743 205 2 5 T4374	598638
23745 177 0 5	598659
23746 180 0 5	598652
23746 201 0 5	598651
23747 201 0 5	598651



	
TEXTAR (.../...)	
23749 188 0 5	598940
23753 180 0 5	598466
23759 170 0 4	598710
2375917004T4242	598710
23760 17.8 1 4	601029
23760 178 2 4	601029
23761 188 1 4	601001
2376118814T4136	601001
23762 19.5 0 5	598750
23762 204 0 5	598750
23763 203 0 5	598779
23766 178 0 5	598679
23768 19.0 0 5	598665
23768 192 1 5	598665
23775 180 0 5	598423
2377518005T4047	598423
23776 180 0 5	601019
23777 150 0 5	598647
	598648
23780 170 0 5	598915
23793 203 0 5	598640
23794 203 0 5	598640
23794 203 0 5 T4374	598640
2379420305T4190	598640
23795 150 0 5	598697
23798 203 0 5	598475
23801 204 0 5	598863
23816 15.8 1 4	598680
23817 17.0 0 5	598848
23832 196 0 5	598860
23832 20.4 0 5	598860
23836 167 1 4	598541
2383616714T4047	598541
23842 180 0 5	598422
23845 154 1 5	598250
	598629
23863 150 0 4	598745
23864 17.0 0 4	598827
23865 164 0 5	598853
23868 16.9 0 5	598757
	598824
23871 138 0 5	598672
	601009
2387113805T4051	598672
23873 150 0 5	598910
23879 155 0 5	598855
2387915505T4136	598855
23881 201 1 5	598795
23885 205 0 5	598845
23891 169 0 5	598744
23896 204 0 5	598845
23901 188 1 5	598046
23904 166 0 5	598917
23912 185 0 5	598822
23912 204 0 5	598822
23914 17.2 1 4	598752



	
TEXTAR (.../...)	
23914 172 1 4 T4140	598752
23914 172 2 4	598752
23914 172 2 4 T4140	598752
23915 17.8 1 5	598699
23916 178 1 5	598699
23917 18.3 0 5	598568
23917 191 1 5	598568
23919 18.3 0 5	598569
23919 191 1 5	598569
23921 19.1 0 4	598570
23921 201 1 4	598570
23921 201 1 5	541738
23922 210 0 5	598728
23923 180 0 5	598802
23927 17.3 0 5	598703
23927 173 0 5 T4140	598703
23928 170 0 4	598862
2392817004T4136	598862
23930 18.1 1 4	598558
2393018114T4047	598558
23934 181 1 4	598557
2393418114T4047	598557
23935 17.8 0 5	598700
23945 165 0 4	601034
23950 203 0 5	598779
23954 190 1 4	598464
23959 175 1 4	598718
23960 178 0 4	598995
23960 178 0 4 T4374	598995
23961 170 0 4	598709
23966 164 0 5	598842
23970 170 0 5	598889
2397017005T4136	598889
23973 17.3 1 4	598641
23973 173 1 5	598847
2397317314T4018	598641
23974 178 0 4	598644
2397417804T4018	598644
23979 178 1 5	598426
	598913
23980 170 1 4	598546
2398017014T4018	598546
23981 192 1 5	598839
23982 178 1 5	598825
23983 178 0 4	601035
23984 180 1 5	598925
23990 207 0 5	598044
23990 207 1 5	598044
23996 18.3 0 5	598653
2399618305T4018	598653
24007 20.2 0 4	598764
24007 202 1 4	598764
24008 17.7 0 4	598765
24008 177 1 4	598765
24010 167 0 4	598770
24011 177 0 5	598829



	
TEXTAR (.../...)	
2401117705T4051	598829
24013 15.0 1 5	598810
24014 154 1 5	598852
2401415415T4051	598852
24022 177 0 5	601026
24024 178 0 5	598857
2402417805T4051	598857
24031 16.8 0 5	598781
24036 160 0 5	598755
24039 144 0 5	598831
2403914405T4051	598831
24040 144 0 5	598831
24043 163 0 5	598643
24043 163 0 5 T4140	598643
2404316305T4047	598643
24045 130 0 4	598780
24058 158 0 5	598823
24059 166 0 5	598506
24062 176 0 5	598361
2406615404T4136	598518
24071 146 0 4	598874
2407114604T4051	598874
24072 177 1 4	598696
24072 177 1 5	601015
24073 164 1 4	598761
24073 164 1 5	601031
24073 164 2 4	598761
24073 164 2 5	601031
24077 190 1 4	598704
24077 190 2 4	598704
24083 192 1 4	598833
24086 157 1 5	598849
24087 175 1 5	598803
24092 173 0 5	598654
2409217305T4018	598654
24098 160 0 4	598994
24098 171 0 4	598994
24101 190 1 4	598464
24122 192 1 5	598943
	601040
24123 203 0 5	598879
24133 177 1 5	598663
24134 187 1 5	598662
24135 17.8 1 4	598664
24137 16.8 0 5	601044
24137 167 0 5	598472
	598678
	598783
	598783
	601005
	601044
24141 198 0 5	598657
2414119805T4136	598657
24142 187 0 5	601007
24143 150 0 5	598859
24150 17.6 1 4	598702
24155 206 0 5	598678







	
TEXTAR (.../...)	
24161 203 0 5	598898
24162 153 0 4	598861
24163 178 0 4	601033
24166 188 0 4	601032
24190 165 1 4	598438
24191 181 1 4	598741
24192 173 1 4	598742
24218 172 0 5	598705
24227 165 0 5	598738
24229 153 1 5	598873
24240 160 0 5	598730
24253 179 0 5	601051
24260 163 1 4	598740
24271 147 1 5	598929
24273 160 0 5	598772
24275 168 0 5	598707
24276 148 0 5	598706
24277 165 0 5	598708
24283 165 0 5	598999
24289 170 1 5	601041
24294 193 1 5	598793
24298 140 0 5	598746
24301 164 0 4	598878
24317 175 0 5	598868
24320 159 0 5	598867
24323 155 0 5	598888
24331 140 1 4	598875
24333 199 0 5	601036
24336 175 0 4	598943
24338 154 0 4	598819
24339 205 0 5	598729
24346 171 1 4	598877
24348 168 1 4	598727
24348 168 2 4	598727
24349 175 1 4	598722
24350 176 0 4	598890
24355 140 0 5	598755
24367 190 0 5	598946
	598967
24369 170 0 5	598739
24391 160 1 5	598804
24412 191 1 5	601046
24415 191 1 5	601047
24418 172 1 5	601048
24421 167 1 5	601049
24462 167 1 4	598939
24465 188 1 4	598892
24483 172 1 4	598752
24483 172 2 4	598752
24484 189 1 4	598816
24485 189 1 4	598818
24486 173 1 4	541736
24491 160 0 5	598945
24496 169 2 4	598928
24498 154 0 5	598941
24501 166 0 5	598934



	
TEXTAR (.../...)	
24510 169 0 5	598942
24523 164 0 5	598894
24529 160 0 5	598893
24535 183 0 5	601012
24536 183 0 5	598993
24537 157 1 4	598935
24537 157 2 4	598935
24538 188 0 5	598997
24540 164 1 4	598936
24541 155 0 4	598768
24557 190 0 5	598998
24574 150 0 5	601028
24578 166 1 4	601039
24586 178 1 5	598744
24595 183 1 5	598899
24610 143 0 5	598933
24632 170 0 4	598738
24635 165 1 5	601038
24638 190 1 5	598901
24660 178 1 4	598927
24663 140 0 4	598531
24673 180 0 5	601017
24692 150 1 4	601011
24693 187 1 4	601010
24693 187 2 4	601010
24703 16.4 2 4	598761
24706 200 0 5	598996
24708 176 0 4	601052
24710 180 0 5	601050
24722 190 0 5	598636
24727 200 0 5	601014
24737 176 1 4	598702
24739 173 0 5	598045
24765 166 1 4	601042
24820 157 1 4	601000
24862 163 0 5	598637
24864 170 0 5	598361
29001 20.0 0 5	541641
29001 200 0 5 T456	541641
29012 180 0 5 T3078	540436
	598138
	598369
29037 183 0 5 T4047	598369
	598586
	598598
29040 180 0 5 T3078	540436
	598369
29041 183 0 5 T4047	598596
29071 170 0 5 T4047	598112
29076 20.0 1 4	541664
29076 200 1 4 T3011	541664
	598966
29121 170 0 4 T3018	541717
29121 170 0 4 T3035	541717
29121 170 1 4	541717
29121 203 0 4 T3018	541662
	541683



	
TEXTAR (.../...)	
29121 203 1 4	541662
	541683
29121 203 1 5 T3035	541662
	541683
29123 203 0 4 T3078	541705
29123 203 1 4	541705
29123 203 1 4 T3078	541705
29139 183 0 5 T4047	598586
29140 183 0 5 T4047	598585
29153 200 1 4 T3011	541664
29160 199 0 4 T3018	541663
29160 199 1 4	541663
29190 190 0 4	541728
29190 190 1 4	541728
29190 190 1 5 T3035	541728
29192 209 1 4	598882
29192 209 1 4 T3036	598882
29192 209 2 4 T3036	598882
29200 207 1 4	598881
29200 207 1 4 T3035	598881
29200 209 2 4 T3036	598881
29217 206 1 5 T3038	598876
29217 208 1 4	598876
29217 208 1 4 T3035	598876
29229 214 1 4	541734
29229 214 1 4 T4136	541734
29229 214 1 5 T4136	541737
29232 210 1 4	541735
29232 210 1 4 T4136	541735
29706 170 0 5 T4047	598086
29984 170 0 5 T4136	598112
TRW	
GDB100	598111
GDB1003	598787
GDB1004	598384
GDB1005	598024
GDB1008	598786
GDB1009	601002
GDB101	598099
	598187
	598270
GDB1010	598817
GDB1012	598628
GDB1013	598840
GDB1014	598826
GDB1017	598618
GDB102	598099
	598187
GDB1020	598123
GDB1022	598589
	598590
GDB1023	598834
	598866
GDB1024	598274

	
TRW (.../...)	
GDB1025	598846
GDB1029	598646
GDB1030	598061
GDB1031	598156
GDB1033	598155
	598181
GDB1034	598121
	598312
GDB1035	598312
GDB1036	598239
GDB1037	598250
GDB1038	598185
GDB1039	598179
	598353
GDB1040	598039
	598356
GDB1041	598055
GDB1043	598496
GDB1044	598017
	598252
GDB1045	598000
	598005
GDB1048	598016
GDB1049	598483
GDB1050	598125
GDB1052	598010
GDB1054	598003
	598135
GDB1055	598463
GDB1057	598982
GDB1058	598006
	598010
	598985
GDB1059	598014
GDB106	598090
	598603
GDB1060	598642
GDB1061	598056
	598627
GDB1063	598682
GDB1064	598440
GDB1066	598338
GDB1067	598613
GDB1068	598291
GDB107	598088
GDB1071	598146
GDB1073	598180
GDB1075	598375
GDB1078	598081
	598177
GDB1079	598080
GDB1080	598037
GDB1083	598022
GDB1084	598036
GDB1085	598028
GDB1087	598599

 	
TRW (.../...)	
GDB1092	598622
GDB1093	598498
GDB1094	598013
GDB1095	598135
GDB1098	598281
GDB1099	601021
GDB1100	598018
GDB1101	598031
GDB1102	598383
GDB1103	598109
	598110
GDB1104	598038
	598074
GDB1105	598070
GDB1106	598800
GDB1107	598034
GDB1108	598033
	598619
GDB1111	598598
GDB1112	598035
GDB1113	598602
GDB1114	598000
GDB1115	598011
	598012
GDB1117	598985
GDB1118	598614
GDB1119	598103
GDB112	598375
GDB1120	598080
	598396
GDB1121	598180
GDB1123	598617
GDB1126	598517
GDB1127	598519
GDB1128	598625
GDB1129	598626
GDB1139	598629
GDB114	598154
GDB1140	598290
GDB1143	598551
GDB1145	598809
GDB1147	598581
GDB1148	598064
GDB1152	598374
GDB1153	598491
GDB1154	598393
GDB1155	598499
GDB1156	598441
GDB1157	598600
GDB1159	598616
GDB1160	598270
GDB1163	598125
GDB1164	598495
GDB1166	598050
GDB1168	598540
GDB1169	598022
	598903

 	
TRW (.../...)	
GDB1170	598628
GDB1174	598533
GDB1177	598515
GDB1179	598476
	598691
GDB118	598077
	598078
	598085
GDB1180	598056
GDB1182	598777
GDB1183	598494
GDB1184	601023
GDB1185	601022
GDB1186	598460
GDB1187	598507
GDB1189	598386
GDB1191	598859
GDB1193	598068
GDB1194	598069
GDB1195	598496
GDB1196	598463
GDB1197	598320
GDB1198	598318
GDB1200	598303
	598355
GDB1201	598294
GDB1203	598382
GDB1204	598067
GDB1205	598357
GDB1207	598595
GDB1208	598120
GDB1209	598762
GDB1210	598040
GDB1212	598065
	598308
GDB1213	598630
GDB1214	598254
GDB1215	598636
GDB1216	598073
GDB1217	598396
GDB1218	598066
GDB1219	598258
GDB1220	598044
GDB1221	598043
GDB1222	598212
GDB1223	598219
GDB1234	598965
GDB1236	598556
GDB1247	598292
GDB1250	598351
GDB1251	598008
GDB1252	598113
GDB1253	598115
GDB1258	598502
GDB1259	598069
GDB1260	598326

 	
TRW (.../...)	
GDB1261	598412
GDB1262	598045
GDB1263	598046
GDB1264	598310
GDB1265	598311
GDB1266	598017
GDB1267	598463
GDB127	598144
GDB1270	598470
GDB1271	598305
GDB1274	598488
GDB1275	598303
GDB1276	598063
GDB1277	598075
GDB1278	598074
GDB1279	598360
GDB1280	598217
GDB1282	598675
GDB1283	598763
GDB1284	598207
GDB1285	598712
GDB1286	598522
GDB1288	541664
	598966
GDB1289	598062
GDB129	598146
GDB1290	598041
GDB1291	598040
GDB1292	598549
GDB1293	598549
GDB1295	598398
GDB1297	598091
GDB1299	598012
GDB1300	598184
GDB1301	598385
GDB1302	598183
GDB1304	598580
GDB1305	598396
GDB1306	598403
GDB1307	598483
	598751
GDB1308	598458
GDB1309	598459
GDB1310	598125
GDB1311	598463
GDB1312	598330
GDB1313	598493
GDB1314	598319
GDB1315	598581
GDB1317	598318
GDB1319	598512
GDB1321	598726
GDB1322	598074
GDB1324	598482
GDB1325	598482
GDB1326	598650

 	
TRW (.../...)	
GDB1328	598180
GDB1330	598180
	598463
GDB1332	598002
GDB1333	598142
	598331
GDB1334	598447
GDB1335	598444
GDB1336	598420
GDB1337	598065
GDB1338	598880
GDB1339	598605
GDB1340	598423
GDB1341	598424
GDB1342	598475
GDB1343	598386
GDB1344	598753
GDB1345	541662
GDB1346	598183
GDB1347	598271
GDB1348	598018
GDB1349	598399
GDB1350	598454
	598860
GDB1351	598322
GDB1352	598926
GDB1353	598328
GDB1354	598431
GDB1356	598586
GDB1357	598332
GDB1358	598317
GDB1359	598466
GDB1360	598180
GDB1361	598461
GDB1362	598308
GDB1364	598065
GDB1365	598329
GDB1366	598484
GDB1367	598814
GDB1368	598807
GDB1369	598482
	598650
GDB1372	598463
GDB1373	598299
GDB1374	598632
GDB1375	598735
GDB1376	598355
GDB1378	598442
GDB1379	598443
GDB1380	598490
GDB1381	598992
GDB1382	598607
GDB1383	598422
	598424
GDB1384	598425
GDB1385	598462







Valeo	
TRW (.../...)	
GDB1386	598408
GDB1388	598479
GDB1389	598480
GDB139	598077
GDB1390	598398
GDB1391	598676
GDB1392	598988
GDB1393	601019
GDB1394	598766
GDB1395	598768
GDB1396	598407
GDB1397	598408
GDB1398	598438
GDB1399	598300
GDB1401	598439
GDB1402	598726
GDB1403	598486
GDB1404	598409
	598811
GDB1405	598473
GDB1406	598616
GDB1407	598086
GDB1408	598301
GDB1411	598456
GDB1412	598457
GDB1413	598448
GDB1414	598667
GDB1415	598681
GDB1416	598463
GDB1418	598563
GDB1419	598564
	598639
GDB1420	598453
GDB1421	598447
GDB1422	598408
GDB1423	598467
GDB1424	598432
GDB1425	598429
GDB1426	598430
GDB1427	598308
GDB1429	598481
GDB1430	598753
GDB1431	598468
GDB1432	598063
GDB1433	598583
GDB1434	598433
GDB1435	598434
GDB1436	598661
GDB1437	598330
GDB1439	598180
GDB1440	598489
GDB1441	598880
GDB1442	598537
GDB1443	598422
GDB1444	598880
GDB1445	598990



Valeo	
TRW (.../...)	
GDB1446	598406
GDB1447	598417
GDB1448	598419
GDB1449	598416
GDB145	598145
GDB1450	598418
GDB1451	598483
GDB1453	598772
GDB1454	598445
GDB1455	598446
GDB1456	598813
GDB1457	598719
GDB1459	598858
GDB146	598146
GDB1460	598565
GDB1461	598547
GDB1462	598464
GDB1463	598464
GDB1464	598465
GDB1465	598002
GDB1466	598545
GDB1467	598180
	598463
GDB1468	598471
GDB1469	598472
	598783
GDB147	598085
GDB1470	598538
GDB1471	598926
GDB1472	598720
GDB1473	598514
GDB1474	598734
GDB1475	598674
GDB1476	598413
GDB1477	598643
GDB1478	598545
GDB1479	598546
GDB148	598077
	598078
	598081
	598085
GDB1480	598582
GDB1481	598583
GDB1482	598426
GDB1483	598427
GDB1484	598428
GDB1485	598633
GDB1487	601003
GDB1488	598751
GDB1489	601001
GDB149	598085
GDB1490	601029
GDB1491	598436
GDB1492	598678
GDB1495	598500
GDB1496	598501



Valeo	
TRW (.../...)	
GDB1498	598410
GDB1499	598411
GDB1500	598461
GDB1501	598462
GDB1502	598820
GDB1503	598553
GDB1504	598463
GDB1505	598992
GDB1509	598434
GDB151	598174
	598193
GDB1510	598439
GDB1511	598438
GDB1513	598480
GDB1514	598448
GDB1515	598584
GDB1516	601004
GDB1517	598568
GDB1518	598569
GDB1519	598988
GDB1520	598407
GDB1521	598570
GDB1522	598396
GDB1525	598527
GDB1526	598658
GDB1527	598580
GDB1528	598750
GDB1530	598580
GDB1531	598811
GDB1532	598639
GDB1533	598423
GDB1534	541717
GDB1535	541705
GDB1538	598489
	598801
GDB154	598090
GDB1540	598566
GDB1542	598638
GDB1543	598445
	598659
GDB1545	598444
GDB1546	598637
GDB1547	598655
GDB1548	598656
GDB1549	598770
GDB155	598094
GDB1550	598635
GDB1551	598752
GDB1552	598558
GDB1553	598845
GDB1554	598779
GDB1555	598651
GDB1556	598652
GDB1557	598671
GDB1559	598640
GDB156	598193

Valeo	
TRW (.../...)	
GDB1560	598885
GDB1561	598643
GDB1562	598860
GDB1563	598464
GDB1565	598657
GDB1566	598829
GDB1567	598808
GDB1570	598456
GDB1571	598557
GDB1572	598036
GDB1573	598037
GDB1574	598669
GDB1576	601030
GDB1578	598463
GDB1579	598913
GDB1581	598035
GDB1582	598464
GDB1583	598649
GDB1584	598318
GDB1586	598805
GDB1587	598463
GDB1589	598696
GDB159	598375
GDB1590	598670
	598913
GDB1591	598698
GDB1592	598761
GDB1593	598761
GDB1594	598662
GDB1595	598663
GDB1596	598664
GDB1597	598558
GDB1600	598764
GDB1601	598765
GDB1602	598990
GDB1603	598772
GDB1604	598407
GDB1605	598715
GDB1606	598861
GDB1607	598822
GDB1609	541683
GDB1610	541663
GDB1611	598699
GDB1612	598701
GDB1613	598678
GDB1614	598641
GDB1615	598075
GDB1616	598863
GDB1617	598779
GDB1618	598619
GDB1620	598702
GDB1621	598472
	598783
	601044
GDB1622	598752
GDB1623	598464

 	
TRW (.../...)	
GDB1624	598465
GDB1625	598700
GDB1626	598703
GDB1628	598795
GDB1629	598704
GDB1630	598704
GDB1631	598741
GDB1632	598742
GDB1633	598718
GDB1634	598002
GDB1635	598002
GDB1636	598793
GDB1637	598727
GDB1638	598727
GDB164	598593
GDB1642	598728
GDB1643	598802
GDB1644	598859
GDB1646	598407
GDB1647	598729
GDB1648	598772
GDB1649	601029
GDB165	598147
GDB1650	601029
GDB1651	598940
GDB1652	598770
GDB1653	598770
GDB1654	598426
GDB1655	598721
GDB1656	598722
GDB1657	598678
GDB1658	598408
GDB1659	598779
GDB166	598364
GDB1661	601004
GDB1663	598663
GDB1664	598939
GDB1665	598740
GDB1667	598995
GDB1668	598860
GDB1669	598465
GDB1670	598994
GDB1671	598946
GDB1672	598967
GDB1673	598804
GDB1676	598465
GDB1677	598464
GDB1678	598702
GDB1681	598891
GDB1682	598892
GDB1683	598879
GDB1685	598928
GDB1686	598678
GDB1687	601012
GDB1690	598997
GDB1691	598998

 	
TRW (.../...)	
GDB1692	598936
GDB1693	601034
GDB1695	541655
GDB1696	598881
GDB1697	541728
GDB1698	598882
GDB1700	598825
GDB1701	598839
GDB1708	598935
GDB1715	598942
GDB1716	598941
GDB1719	598899
GDB172	598160
GDB1723	598818
GDB1724	598816
GDB1725	541736
GDB1727	598754
GDB173	598178
GDB1747	541734
GDB1749	601017
GDB1781	601048
GDB1782	601047
GDB1784	601049
GDB1789	601045
GDB1790	601050
GDB185	598208
GDB194	598220
GDB197	598123
	598379
GDB199	598182
GDB233	598614
GDB238	598166
	598171
	598212
	598334
GDB240	598113
GDB241	598592
GDB242	598109
GDB243	598366
GDB251	598122
GDB252	598612
GDB253	598117
GDB254	598185
GDB255	598120
	598166
	598212
GDB259	598187
GDB261	598107
GDB262	598207
GDB263	598148
GDB264	598110
GDB265	598389
GDB267	598111
GDB269	598375
GDB270	598107
GDB271	598362

 	
TRW (.../...)	
GDB272	598363
GDB276	598150
GDB277	598144
GDB278	598146
GDB279	598375
GDB280	598175
GDB282	598162
GDB284	598052
	598131
GDB287	598149
GDB288	598278
GDB294	598105
GDB296	598090
GDB297	598091
	598219
GDB298	598104
GDB299	598103
GDB300	601016
GDB301	598120
GDB303	598384
GDB3045	598844
GDB3058	598983
GDB306	598817
GDB3071	598850
GDB308	598081
GDB3086	598496
GDB3088	598780
GDB3089	598634
GDB3091	598830
GDB3092	598057
GDB3101	598786
GDB3103	598836
GDB311	598167
GDB3110	598777
GDB3111	598668
GDB3114	598071
GDB3115	598449
GDB3116	598184
GDB3123	598838
GDB3124	598523
GDB3126	601024
GDB3129	598835
GDB313	598151
GDB3130	598496
GDB3131	598476
GDB3132	598534
GDB3133	598625
GDB3134	598528
GDB3135	598854
GDB314	598591
GDB3147	598551
GDB315	598145
GDB3154	598682
GDB3157	598496
GDB3159	598450
GDB3160	598437

 	
TRW (.../...)	
GDB3161	598020
GDB3162	598460
GDB3163	598478
GDB3164	598540
GDB3165	598575
GDB3167	598452
GDB3168	598450
GDB3169	598051
GDB317	598613
GDB3170	598817
GDB3171	598361
GDB3172	598902
GDB3175	598682
GDB3176	598495
GDB3177	598627
GDB3178	598212
GDB318	598123
GDB3180	598071
GDB3181	598668
GDB3182	598533
	598534
GDB3183	598023
GDB3184	598266
GDB3186	598436
GDB3188	598627
GDB3189	598435
GDB3190	598682
	598758
GDB3191	598682
GDB3192	598629
GDB3193	598548
GDB3195	598316
GDB3196	598627
GDB3197	598535
GDB3198	598865
GDB3200	601020
GDB3201	598908
GDB3202	598531
GDB3203	598841
GDB3204	598579
GDB3205	598691
	598915
GDB3207	598551
GDB3208	598806
GDB3209	598629
GDB3210	598021
GDB3211	598574
GDB3212	598760
GDB3213	598393
	598897
GDB3216	598361
GDB3217	598530
GDB3218	598606
GDB3219	598883
GDB3220	598856
GDB3221	598843







Valeo	
TRW (.../...)	
GDB3222	598524
GDB3223	598895
GDB3224	598989
GDB3227	598451
GDB323	598266
GDB3231	598780
GDB3232	598504
GDB3233	601025
GDB3235	601023
GDB3236	598733
GDB3238	598784
GDB3239	598778
GDB3240	598887
GDB3241	598511
GDB3242	598737
GDB3243	598577
GDB3244	598759
GDB3245	598910
GDB3246	598518
GDB3247	598520
GDB3249	598542
GDB325	598047
GDB3250	598907
GDB3251	598536
GDB3255	598515
GDB3256	598574
GDB3257	598505
GDB3258	598748
GDB3259	598574
GDB3260	598834
	598866
GDB3261	598821
GDB3262	598274
GDB3266	598856
GDB3267	598022
GDB3268	598887
GDB3269	598682
	601043
GDB327	598002
	598075
	598081
	598177
GDB3270	598521
GDB3271	598054
GDB3273	598912
GDB3274	598668
GDB3275	598697
GDB3276	598733
	598832
GDB3279	598673
GDB328	598080
GDB3280	598777
GDB3282	598748
GDB3283	598574
GDB3284	598748
GDB3285	598910



Valeo	
TRW (.../...)	
GDB3286	598944
GDB3287	598886
GDB3288	598679
GDB3289	598680
GDB3290	598848
GDB3291	598451
GDB3292	598472
GDB3293	598452
GDB3294	598672
GDB3297	598505
	598871
GDB3298	598748
GDB3299	598506
GDB3300	598579
GDB3301	598821
GDB3302	598745
GDB3306	598809
GDB3307	598476
GDB3308	598916
GDB3309	598647
GDB3310	598648
GDB3311	598780
GDB3312	598452
GDB3313	598602
GDB3314	598862
GDB3315	598541
GDB3316	598827
GDB3317	598917
GDB332	598392
GDB3324	598736
GDB3325	598757
GDB3327	598523
GDB3328	598853
GDB3330	598644
GDB3331	598052
GDB3332	598641
GDB3334	598810
GDB3335	598653
GDB3336	598665
GDB3337	598812
GDB3340	598889
GDB3341	598852
GDB3342	598842
GDB3343	598654
GDB3344	598823
GDB3345	598361
GDB3348	598874
GDB3349	598919
GDB3350	598914
GDB3351	598733
GDB3352	598744
GDB3353	598784
GDB3355	598824
GDB3357	598831
GDB3358	598873
GDB3359	598733



Valeo	
TRW (.../...)	
GDB336	598116
GDB3363	598453
GDB3364	598857
GDB3365	598870
GDB3367	598705
GDB3368	598817
GDB3369	598707
GDB3370	598706
GDB3371	598853
GDB3373	598929
GDB3377	598708
GDB3378	598781
GDB3380	598855
GDB3383	598393
GDB3386	598744
GDB3387	598748
GDB3389	598493
GDB339	598186
GDB3390	598787
GDB3392	598738
GDB3393	598672
GDB3395	598875
GDB3396	598847
GDB3399	598888
GDB340	598391
GDB3402	598746
GDB3405	598730
GDB3407	598803
GDB3408	598849
GDB341	598129
GDB3410	601035
GDB3412	598871
GDB3414	598710
GDB3418	598937
GDB3419	598932
GDB342	598129
GDB3420	598868
GDB3421	598867
GDB3422	598744
GDB3423	598589
GDB3424	601037
GDB3425	598943
GDB3426	598819
GDB3427	598894
GDB3429	598890
GDB343	598007
	598374
GDB3431	598739
GDB3432	598748
GDB3433	598821
GDB3435	598893
GDB3439	541737
GDB344	598086
GDB3445	598901
GDB3454	598933
GDB3457	601026

Valeo	
TRW (.../...)	
GDB3459	598896
GDB3460	601052
GDB3481	598943
	601040
GDB349	598032
	598166
GDB350	598131
GDB351	598402
	598614
GDB352	598921
GDB353	598130
GDB354	598239
GDB355	598220
GDB358	598047
GDB359	598371
GDB360	598125
	598141
GDB362	598113
GDB364	598115
GDB365	598224
GDB367	598123
GDB371	598120
	598335
GDB373	598052
GDB374	598293
GDB383	598021
GDB384	598983
GDB386	598175
GDB391	598270
GDB392	598291
GDB394	598129
GDB395	598623
GDB397	598594
GDB399	598027
GDB400	598002
GDB4010	598906
GDB4012	598965
GDB4016	598904
GDB403	598214
GDB404	598017
GDB405	598076
	598377
GDB407	598106
GDB4091	598556
GDB4104	598491
GDB4118	598543
GDB4119	598544
GDB4120	598510
GDB4121	598556
GDB4122	598556
GDB4124	598509
GDB4125	598905
GDB4126	598414
GDB4127	598677
GDB4128	598756
GDB4129	598415

 	
TRW (.../...)	
GDB4130	598755
GDB4133	598833
GDB4135	601033
GDB4139	598755
GDB4140	601032
GDB417	598093
GDB422	598091
	598093
GDB425	598002
	598061
GDB428	598118
GDB430	598004
GDB440	598169
GDB442	598621
GDB443	598374
GDB446	598119
	598176
	598714
GDB447	598138
	598153
	598179
GDB454	598128
GDB457	598093
	598133
	598219
GDB458	598091
	598135
	598141
	598219
GDB459	598124
GDB460	598237
GDB463	598127
GDB464	598134
GDB466	598125
	598142
GDB469	598406
GDB471	598121
GDB472	598240
GDB473	598217
GDB478	598596
GDB479	598227
GDB482	598221
GDB483	598006
GDB493	598102
GDB496	598022
GDB497	598019
	598022
GDB499	598053
GDB5062	541641
GDB533	598161
	598338
GDB557	598374
GDB576	598337
GDB585	598374
GDB611	598108
GDB624	598165

 	
TRW (.../...)	
GDB627	598161
	598338
GDB628	598205
GDB632	598377
GDB648	598099
GDB654	598108
GDB656	598099
GDB657	598093
GDB660	598168
GDB663	598099
GDB680	598163
GDB691	598168
GDB693	598168
GDB695	598153
GDB698	598219
GDB729	598597
GDB730	598984
GDB731	598296
GDB733	598227
GDB745	598851
GDB747	598122
GDB748	598122
GDB749	598615
GDB759	598380
GDB763	598248
GDB764	598052
GDB766	598123
	598618
GDB770	598947
GDB773	598268
	598274
GDB774	598682
	598911
GDB775	598053
GDB779	598132
GDB783	598391
GDB785	598620
GDB788	598714
GDB789	598391
GDB790	598714
GDB791	598048
GDB793	598179
GDB794	598030
	598156
GDB796	598280
GDB797	598393
	598897
GDB798	598266
GDB807	598002
	598084
GDB808	598176
GDB809	598002
	598084
GDB812	598015
GDB814	598125
GDB816	598230

 	
TRW (.../...)	
GDB817	598241
GDB818	598044
	598315
GDB823	598180
GDB826	598017
GDB833	598095
	598219
GDB837	598695
GDB848	598054
	598450
GDB852	598095
GDB854	598017
GDB859	598254
GDB862	598025
GDB863	598205
GDB864	598135
GDB867	598532
GDB868	598266
GDB870	598020
GDB878	598815
GDB882	598296
GDB883	598666
GDB887	598624
GDB893	598052
GDB894	598788
GDB895	598051
GDB897	598172
GDB900	598289
GDB901	598126
GDB902	598130
GDB903	598082
GDB905	598158
GDB906	598030
	598156
GDB908	598077
	598078
	598081
GDB909	598375
GDB911	598345
GDB914	598183
	598243
GDB915	598183
GDB916	598231
GDB917	598259
GDB925	598248
GDB945	598964
GDB950	598613
GDB951	598184
GDB952	598253
GDB953	598043
	598171
GDB956	598029
GDB957	598256
GDB958	598271
GDB960	598271
GDB962	598601

 	
TRW (.../...)	
GDB968	598002
GDB969	598269
GDB970	598257
GDB974	598497
GDB976	598497
GDB979	598272
GDB981	598250
GDB982	598826
GDB984	598294
GDB985	598295
GDB986	598292
GDB987	598272
GDB989	598691
GDB990	598828
GDB995	598627



→ Valeo	
ATE	
24.0107-0100.1	186128
24.0107-0105.2	186135
24.0107-0106.2	186140
24.0107-0108.1	186654
24.0107-0109.1	186846
24.0108-0104.1	186228
24.0108-0105.1	186196
24.0108-0106.1	186416
24.0108-0107.1	186130
24.0108-0108.1	186768
24.0108-0109.1	186768
	186775
24.0108-0110.1	186231
24.0108-0111.1	186760
24.0108-0112.1	186796
24.0108-0113.1	197036
24.0108-0114.2	186796
24.0109-0100.2	197002
24.0109-0103.1	186462
24.0109-0108.1	186143
24.0109-0111.1	186432
24.0109-0114.1	186183
	186470
24.0109-0118.1	186184
24.0109-0120.1	186281
24.0109-0121.2	186144
24.0109-0122.1	186586
24.0109-0123.1	186597
24.0109-0124.1	186729
24.0109-0129.1	186564
24.0109-0130.1	186498
24.0109-0131.1	186452
24.0109-0133.1	197011
24.0109-0136.1	186859
24.0109-0137.1	186694
24.0109-0138.1	186848
24.0109-0139.1	186847
24.0109-0140.1	197019
24.0109-0142.1	197111
24.0109-0143.1	197014
24.0109-0149.1	186840
	197002
24.0109-0150.2	186840
24.0109-0151.1	197102
24.0109-0152.1	197112
24.0109-0154.1	197128
24.0109-0155.1	197110
24.0109-0156.1	197113
24.0110-0111.1	186288
24.0110-0115.1	186425
24.0110-0117.1	186125
24.0110-0129.1	186142
24.0110-0136.1	197114
24.0110-0139.1	186226
24.0110-0144.1	186302
24.0110-0148.1	186160
24.0110-0150.1	186117



→ Valeo	
ATE (.../...)	
24.0110-0151.1	186249
24.0110-0152.1	186186
	197150
24.0110-0165.2	186197
24.0110-0178.1	186114
24.0110-0182.1	186292
24.0110-0183.1	186134
24.0110-0186.1	186424
24.0110-0187.1	186200
24.0110-0190.1	186146
24.0110-0191.1	186190
24.0110-0192.1	186374
24.0110-0193.1	186158
24.0110-0196.1	186162
24.0110-0198.1	186131
24.0110-0199.1	186199
24.0110-0201.1	186294
24.0110-0202.1	186295
24.0110-0203.1	186517
24.0110-0204.1	186490
24.0110-0207.1	186114
24.0110-0208.1	186276
24.0110-0209.1	186290
24.0110-0210.1	186773
24.0110-0211.1	186839
24.0110-0212.1	186435
24.0110-0213.1	186428
24.0110-0214.1	186528
24.0110-0215.1	186487
24.0110-0217.1	186469
24.0110-0218.1	186421
24.0110-0219.1	186306
24.0110-0220.1	186307
24.0110-0223.1	186624
24.0110-0224.1	186773
24.0110-0225.1	186565
24.0110-0226.1	186566
24.0110-0227.1	186568
24.0110-0228.1	186552
24.0110-0229.1	186647
24.0110-0230.1	186579
24.0110-0231.1	186204
24.0110-0232.1	186581
24.0110-0234.1	186458
24.0110-0235.1	197157
24.0110-0237.1	186503
24.0110-0239.1	186495
24.0110-0242.1	186504
24.0110-0244.1	186487
24.0110-0249.1	186497
24.0110-0250.1	186593
24.0110-0251.1	186594
24.0110-0258.1	186294
24.0110-0259.1	197124
24.0110-0260.1	197032
24.0110-0261.1	186807
24.0110-0264.1	197120



→ Valeo	
ATE (.../...)	
24.0110-0268.1	186791
24.0110-0269.1	197020
24.0110-0270.1	197016
24.0110-0271.1	186812
24.0110-0272.1	186785
24.0110-0274.1	197009
24.0110-0275.2	186288
24.0110-0276.2	186517
24.0110-0277.1	186857
24.0110-0278.1	197035
24.0110-0279.1	197104
24.0110-0280.1	186858
24.0110-0283.1	186797
24.0110-0286.1	197027
24.0110-0287.1	186295
24.0110-0291.1	186855
24.0110-0295.1	197015
24.0110-0296.1	197103
24.0110-0302.1	186851
24.0110-0303.1	186853
24.0110-0304.1	197129
24.0110-0305.1	186850
24.0110-0310.1	186845
24.0110-0311.1	186849
24.0110-0312.1	197029
24.0110-0318.1	197121
24.0110-0323.1	197008
24.0110-0325.2	186853
24.0110-0328.1	197127
24.0110-0330.1	197116
24.0111-0100.2	186893
24.0111-0101.2	186718
24.0111-0115.1	186171
24.0111-0119.1	186155
24.0111-0122.1	186567
24.0111-0125.1	186777
24.0111-0129.1	186501
24.0111-0130.1	186151
24.0111-0133.1	186488
24.0111-0137.1	186176
24.0111-0141.1	186591
24.0111-0143.1	186596
24.0111-0145.1	197101
24.0111-0148.2	186720
24.0111-0149.1	186155
	186406
24.0111-0152.1	186757
24.0111-0154.1	186844
	197013
24.0111-0155.1	186842
24.0111-0157.1	186893
24.0111-0158.1	186843
24.0111-0159.1	197108
24.0111-0161.1	186720
24.0111-0163.1	186894
24.0111-0164.1	197021
24.0111-0166.2	186720



→ Valeo	
ATE (.../...)	
24.0111-0167.2	186894
24.0112-0102.1	186232
24.0112-0106.1	186245
24.0112-0112.1	186152
24.0112-0116.1	186230
	186803
24.0112-0117.1	186182
24.0112-0118.1	186150
24.0112-0121.1	186299
24.0112-0122.1	186157
24.0112-0124.1	186124
24.0112-0125.1	186173
24.0112-0126.1	186274
24.0112-0127.1	186154
24.0112-0128.1	186298
24.0112-0130.1	186172
24.0112-0133.1	186223
24.0112-0134.1	186225
24.0112-0136.2	186621
24.0112-0137.1	186300
24.0112-0140.1	186510
	186511
24.0112-0141.1	186529
24.0112-0142.1	197033
24.0112-0143.1	186569
24.0112-0144.1	186562
24.0112-0147.1	186453
24.0112-0148.1	186856
24.0112-0152.1	186809
24.0112-0153.1	186784
24.0112-0154.1	186834
24.0112-0155.1	186740
24.0112-0156.1	186724
24.0112-0157.1	186854
24.0112-0158.1	186833
24.0112-0159.1	197125
24.0112-0160.1	186786
24.0112-0162.1	186747
24.0112-0163.1	186713
24.0112-0164.1	197018
24.0112-0166.1	197038
24.0112-0167.1	186798
24.0112-0168.1	197017
24.0112-0169.1	197031
24.0112-0170.1	197098
24.0112-0171.1	186802
	186803
24.0112-0174.1	197010
24.0112-0177.2	186713
24.0112-0178.1	197126
24.0112-0184.1	197028
24.0113-0128.1	186202
24.0113-0137.1	186180
24.0113-0138.1	186115
24.0113-0142.1	186771
24.0113-0153.2	186110
24.0113-0160.1	186113



	
ATE (.../...)	
24.0113-0161.1	186187
	186757
24.0113-0165.1	186454
24.0113-0166.1	186268
24.0113-0167.1	186118
24.0113-0168.1	186205
24.0113-0169.1	186530
24.0113-0174.1	186192
24.0113-0178.1	186251
24.0113-0179.1	186269
24.0113-0181.1	186408
24.0113-0182.1	186681
24.0113-0184.1	186599
24.0113-0185.1	186598
24.0113-0188.1	186285
24.0113-0189.1	186310
24.0113-0190.1	186236
24.0113-0191.1	186642
24.0113-0192.1	186620
24.0113-0193.1	186714
24.0113-0194.1	186801
24.0113-0195.1	186742
24.0113-0196.1	197022
24.0113-0197.1	186642
24.0113-0198.1	186620
24.0114-0100.1	186169
24.0114-0101.1	186254
24.0114-0102.1	186147
24.0114-0103.1	186168
24.0114-0107.1	186207
24.0114-0108.1	186283
	186310
24.0114-0109.2	186614
24.0114-0110.2	186170
24.0114-0112.1	186736
24.0114-0113.1	186687
24.0114-0115.1	186310
24.0114-0116.1	197099
24.0115-0105.1	186270
24.0115-0108.1	186605
24.0115-0109.1	186788
24.0115-0109.3	186788
24.0115-0111.1	186753
24.0116-0101.1	186692
24.0116-0104.1	186770
24.0116-0105.1	186206
24.0116-0106.1	186136
24.0116-0107.2	186178
24.0116-0108.1	186314
24.0116-0109.1	186770
24.0116-0110.1	187045
24.0116-0112.2	187029
24.0116-0113.1	186520
24.0116-0114.1	186708
24.0116-0121.1	197030
24.0116-0123.1	197105
24.0116-0124.1	197023

	
ATE (.../...)	
24.0116-0125.1	197097
24.0116-0126.1	187152
24.0117-0103.1	186505
24.0117-0104.1	186628
24.0117-0105.1	197163
24.0117-0106.1	186805
24.0117-0108.1	197064
24.0117-0109.1	197065
24.0118-0105.1	197218
24.0118-0106.1	186523
24.0118-0107.1	186482
24.0118-0108.1	197217
24.0118-0110.1	186511
24.0118-0111.1	186725
24.0118-0112.1	186476
24.0118-0113.1	186449
24.0118-0117.1	186577
24.0118-0118.1	186576
24.0118-0120.1	186818
24.0118-0122.1	186685
24.0118-0124.1	186875
24.0118-0129.1	186686
24.0118-0130.1	186691
24.0118-0131.1	186587
24.0118-0137.1	186888
24.0118-0140.1	186691
24.0118-0145.1	197096
24.0119-0106.1	186431
24.0119-0107.1	186559
24.0119-0108.1	186861
24.0119-0109.1	186441
24.0119-0114.1	197173
24.0119-0115.1	186879
24.0119-0116.1	186878
24.0120-0108.1	186139
24.0120-0115.1	186188
24.0120-0119.1	186479
24.0120-0120.1	186273
24.0120-0121.1	186446
24.0120-0123.1	186246
24.0120-0125.1	186229
24.0120-0126.1	186214
24.0120-0128.1	186247
24.0120-0129.1	186149
24.0120-0131.1	186195
24.0120-0132.1	186194
24.0120-0133.1	186198
24.0120-0134.1	186219
24.0120-0135.1	186221
24.0120-0139.1	197165
24.0120-0140.1	186282
24.0120-0142.1	186153
24.0120-0143.1	186156
24.0120-0146.1	186426
24.0120-0147.1	186163
	186266
24.0120-0148.1	186163
	186213

	
ATE (.../...)	
24.0120-0152.1	186301
24.0120-0153.1	186637
24.0120-0154.1	186860
24.0120-0155.1	186589
24.0120-0156.1	186137
24.0120-0157.1	186287
24.0120-0158.1	186571
24.0120-0159.1	186644
24.0120-0163.1	186827
24.0120-0166.1	186572
24.0120-0168.1	186547
24.0120-0169.1	197063
24.0120-0173.1	186882
24.0120-0174.1	186790
24.0120-0175.1	186766
24.0120-0177.1	197208
24.0120-0180.1	197047
24.0120-0183.1	197084
24.0120-0184.1	186744
24.0120-0186.1	186781
24.0120-0193.1	186571
24.0120-0195.1	197049
24.0120-0196.1	197050
24.0120-0202.1	197209
24.0120-0204.1	197158
24.0120-0209.1	197191
24.0120-0210.1	197156
24.0120-0211.1	197066
24.0120-0214.1	197181
24.0121-0100.1	186235
24.0121-0101.1	186220
24.0121-0102.1	186234
24.0121-0104.1	186433
24.0121-0105.1	186438
24.0121-0106.1	186208
24.0121-0107.1	186286
24.0121-0108.1	186208
24.0121-0110.1	186234
24.0121-0111.1	197146
24.0121-0113.1	186866
	197146
24.0121-0114.1	186871
24.0122-0100.1	186313
24.0122-0101.1	186519
24.0122-0107.1	186297
24.0122-0108.1	186267
24.0122-0112.1	186116
24.0122-0115.1	186275
24.0122-0118.1	186112
24.0122-0119.2	186103
24.0122-0122.1	186119
24.0122-0123.1	186185
24.0122-0124.1	186177
24.0122-0126.1	197028
24.0122-0128.1	186102
24.0122-0130.1	186148
24.0122-0132.1	186280

	
ATE (.../...)	
24.0122-0133.1	186465
24.0122-0136.1	186460
24.0122-0139.1	186291
24.0122-0141.1	186145
24.0122-0142.1	186296
24.0122-0143.1	186224
24.0122-0145.1	186265
24.0122-0146.1	186485
24.0122-0147.1	186266
24.0122-0148.1	186304
24.0122-0149.1	186305
24.0122-0150.1	186604
24.0122-0151.1	186603
24.0122-0152.1	186582
24.0122-0154.1	186509
24.0122-0156.1	186488
24.0122-0158.1	186701
24.0122-0159.1	186697
24.0122-0160.1	186815
24.0122-0161.1	186774
24.0122-0162.1	186551
24.0122-0163.1	197088
24.0122-0165.1	186451
24.0122-0167.1	186611
24.0122-0168.1	186573
24.0122-0169.1	186440
24.0122-0170.1	186617
24.0122-0172.1	186560
24.0122-0175.1	186653
24.0122-0177.1	186613
24.0122-0178.1	186652
24.0122-0179.1	186821
24.0122-0184.1	186643
24.0122-0185.1	186704
24.0122-0186.2	187058
24.0122-0187.1	187040
24.0122-0188.1	186511
24.0122-0191.1	186442
24.0122-0194.1	186695
24.0122-0196.1	197059
24.0122-0197.1	186590
24.0122-0199.1	197060
24.0122-0200.1	197162
24.0122-0201.1	186865
24.0122-0202.1	186582
24.0122-0204.1	186762
24.0122-0206.1	186814
24.0122-0207.1	197161
24.0122-0208.1	186783
24.0122-0209.1	186883
24.0122-0210.1	186754
24.0122-0211.1	186886
24.0122-0215.1	197243
24.0122-0216.1	186764
24.0122-0218.1	197094
24.0122-0219.1	197139
24.0122-0222.1	197089



ATE (.../...)	
24.0122-0223.1	197140
24.0122-0224.1	197251
24.0122-0225.1	186643
24.0122-0230.1	197067
24.0122-0231.1	197044
24.0122-0232.1	186799
24.0122-0233.1	197132
	197134
24.0122-0234.1	197138
24.0122-0236.1	197175
24.0122-0238.1	186817
24.0122-0239.1	186816
24.0122-0240.1	197184
24.0122-0241.1	197045
24.0122-0243.1	197212
24.0122-0246.1	197147
24.0122-0247.1	197160
24.0122-0248.1	197074
24.0122-0252.1	197135
24.0122-0254.1	197182
24.0122-0256.1	197183
24.0123-0102.1	186439
24.0123-0103.1	186436
	186439
24.0123-0104.1	186778
24.0123-0105.1	186699
24.0123-0107.1	186734
24.0124-0103.1	186218
24.0124-0105.1	186455
24.0124-0110.1	186625
24.0124-0111.1	186191
24.0124-0112.1	186159
24.0124-0113.1	186166
24.0124-0115.1	186189
24.0124-0118.1	186315
24.0124-0120.1	186277
24.0124-0121.1	186165
24.0124-0125.1	186427
24.0124-0126.1	186600
24.0124-0127.1	186418
	197043
24.0124-0128.1	186682
24.0124-0129.1	186457
24.0124-0130.1	186648
24.0124-0131.1	186278
24.0124-0132.1	186537
24.0124-0133.1	186496
24.0124-0136.1	186648
24.0124-0137.1	186210
24.0124-0138.1	197131
	197228
24.0124-0139.1	186532
24.0124-0140.1	186719
24.0124-0143.1	186284
24.0124-0146.1	186648
24.0124-0149.1	186401
24.0124-0152.1	186592



ATE (.../...)	
24.0124-0153.1	186730
24.0124-0154.1	186570
24.0124-0158.1	186655
24.0124-0159.1	186707
24.0124-0161.1	186750
24.0124-0162.1	186688
24.0124-0163.1	186743
24.0124-0164.1	186810
24.0124-0166.1	186759
24.0124-0167.1	186709
24.0124-0168.1	186710
24.0124-0169.1	186715
24.0124-0171.1	186600
24.0124-0172.1	197207
24.0124-0178.1	186730
24.0124-0179.1	186748
24.0124-0181.1	186732
24.0124-0184.1	186825
24.0124-0191.1	197241
24.0124-0192.1	197214
24.0124-0193.1	186570
24.0124-0195.1	197206
24.0124-0197.1	197234
24.0124-0200.1	197073
24.0124-0208.1	197043
24.0124-0706.1	186823
24.0125-0102.1	186272
24.0125-0105.1	197222
24.0125-0108.1	186521
24.0125-0110.1	186467
	186864
24.0125-0113.1	197230
24.0125-0114.1	197236
24.0125-0115.1	186583
24.0125-0116.1	186514
24.0125-0117.1	186819
24.0125-0118.1	186696
24.0125-0119.1	197226
24.0125-0123.1	197246
24.0125-0124.1	197169
24.0125-0125.1	186500
24.0125-0130.1	186439
24.0125-0131.1	186684
24.0125-0133.1	186645
24.0125-0135.1	186640
24.0125-0136.1	197086
24.0125-0137.1	186758
24.0125-0138.1	186731
24.0125-0140.1	186705
24.0125-0141.1	186881
24.0125-0142.1	197244
24.0125-0143.1	186765
24.0125-0144.1	186652
24.0125-0145.1	186755
24.0125-0146.1	186780
24.0125-0147.1	197245
24.0125-0148.1	186869



ATE (.../...)	
24.0125-0149.1	197052
24.0125-0155.1	186877
24.0125-0157.1	197171
24.0125-0158.1	197242
24.0125-0160.1	197083
24.0125-0161.1	186620
24.0125-0162.1	186863
24.0125-0164.1	197224
24.0125-0165.1	186872
24.0125-0167.1	197091
24.0125-0171.1	197222
24.0125-0172.1	186758
24.0125-0173.1	197144
24.0125-0174.1	197145
24.0125-0175.1	197143
24.0125-0176.1	197062
24.0125-0179.1	197203
24.0125-0183.1	197154
24.0125-0184.1	197213
24.0125-0700.1	197170
24.0126-0100.1	186303
24.0126-0102.1	186526
24.0126-0103.1	186405
24.0126-0104.1	186420
	197225
24.0126-0106.1	186533
24.0126-0107.1	197056
24.0126-0108.1	186563
24.0126-0110.1	186585
	197223
24.0126-0111.1	186585
	197223
24.0126-0113.1	186443
24.0126-0115.1	197239
24.0126-0119.1	186800
24.0126-0120.1	186693
24.0126-0121.1	186702
	186746
24.0126-0122.1	186789
24.0126-0123.1	197221
24.0126-0124.1	186813
24.0126-0125.1	186745
24.0126-0126.1	197172
24.0126-0127.1	186824
24.0126-0129.1	186829
24.0126-0130.1	197238
24.0126-0133.1	186443
24.0126-0138.1	197070
24.0126-0139.1	197072
24.0126-0140.1	197232
24.0126-0142.1	197081
24.0126-0146.1	197149
24.0126-0148.1	197185
24.0126-0150.1	197205
24.0128-0100.1	197201
24.0128-0103.1	186461
24.0128-0104.1	197225



ATE (.../...)	
24.0128-0105.1	197227
24.0128-0113.1	186822
24.0128-0114.1	197167
24.0128-0115.1	197166
24.0128-0116.1	197148
24.0128-0118.1	197229
24.0128-0123.1	186741
24.0128-0129.1	186868
24.0128-0132.1	186712
24.0128-0133.1	186804
24.0128-0134.1	197240
24.0128-0135.1	197079
24.0128-0136.1	197219
24.0128-0137.1	186880
24.0128-0140.1	186728
24.0128-0141.1	186751
24.0128-0143.1	197231
24.0128-0144.1	197057
24.0128-0145.1	186890
24.0128-0147.1	197233
24.0128-0148.1	197069
24.0128-0149.1	197090
24.0128-0154.1	197055
24.0128-0155.1	197202
24.0128-0156.1	197249
24.0128-0157.1	197054
24.0128-0159.1	197152
24.0128-0169.1	197051
24.0128-0176.1	186751
24.0128-0177.1	197200
24.0128-0179.1	197137
24.0128-0182.1	186717
24.0128-0183.1	186876
24.0128-0190.1	197168
24.0128-0191.1	197130
24.0128-0192.1	197247
24.0128-0194.1	197071
24.0128-0200.1	197210
24.0128-0201.1	197150
24.0128-0202.1	187146
24.0128-0203.1	187141
24.0128-0211.1	197211
24.0128-0213.1	197248
24.0128-0214.1	197188
24.0128-0216.1	197133
24.0128-0217.1	197186
24.0128-0708.1	197252
24.0128-0722.1	186778
24.0129-0101.1	197190
24.0130-0107.1	186884
24.0130-0109.1	186808
24.0130-0113.1	197198
24.0130-0114.1	186756
24.0130-0115.1	197197
24.0130-0173.1	197193
24.0130-0175.1	197199
24.0130-0176.1	197142



	
ATE (.../...)	
24.0130-0181.1	197046
24.0130-0192.1	197176
24.0130-0193.1	197196
24.0130-0199.1	197178
24.0130-0200.1	197177
24.0132-0110.1	197004
24.0132-0111.1	186638
24.0132-0114.1	186811
24.0132-0116.1	186885
24.0132-0117.1	197087
24.0132-0129.1	197136
24.0132-0152.1	186703
24.0132-0154.1	197093
24.0132-0158.1	197092
24.0132-0701.1	197194
24.0309-0114.1	186183
	186470
24.0310-0151.1	186249
24.0310-0217.1	186469
24.0311-0141.1	186591
24.0312-0106.1	186245
24.0312-0125.1	186173
24.0312-0126.1	186274
24.0312-0141.1	186529
24.0312-0144.1	186562
24.0313-0161.1	186187
	186757
24.0313-0178.1	186251
24.0313-0181.1	186408
24.0315-0105.1	186270
24.0318-0106.1	186523
24.0320-0115.1	186188
24.0320-0123.1	186246
24.0320-0128.1	186247
24.0320-0132.1	186194
24.0320-0133.1	186198
24.0320-0142.1	186153
24.0320-0147.1	186163
24.0320-0175.1	186766
24.0322-0100.1	186313
24.0322-0115.1	186275
24.0322-0122.1	186119
24.0322-0132.1	186280
24.0322-0150.1	186604
24.0322-0151.1	186603
24.0322-0152.1	186582
24.0322-0159.1	186697
24.0322-0160.1	186815
24.0322-0161.1	186774
24.0322-0162.1	186551
24.0322-0168.1	186573
24.0322-0170.1	186617
24.0322-0172.1	186560
24.0322-0199.1	197060
24.0322-0204.1	186762
24.0322-0210.1	186754
24.0324-0115.1	186189

	
ATE (.../...)	
24.0324-0120.1	186277
24.0324-0126.1	186600
24.0324-0152.1	186592
24.0324-0158.1	186655
24.0324-0159.1	186707
24.0324-0161.1	186750
24.0324-0166.1	186759
24.0324-0171.1	186600
24.0324-0181.1	186732
24.0324-0197.1	197234
24.0324-0200.1	197073
24.0325-0105.1	197222
24.0325-0110.1	186467
	186864
24.0325-0113.1	197230
24.0325-0115.1	186583
24.0325-0119.1	197226
24.0325-0123.1	197246
24.0325-0131.1	186684
24.0325-0137.1	186758
24.0325-0138.1	186731
24.0325-0141.1	186881
24.0325-0142.1	197244
24.0325-0145.1	186755
24.0325-0148.1	186869
24.0325-0158.1	197242
24.0325-0171.1	197222
24.0325-0172.1	186758
24.0326-0106.1	186533
24.0326-0107.1	197056
24.0326-0120.1	186693
24.0326-0123.1	197221
24.0328-0123.1	186741
24.0328-0129.1	186868
24.0328-0136.1	197219
24.0328-0137.1	186880
24.0330-0107.1	186884
24.0330-0113.1	197198
24.0330-0173.1	197193
24.1109-0103.1	186462
24.1109-0114.1	186183
	186470
24.1109-0118.1	186184
24.1109-0120.1	186281
24.1109-0123.1	186597
24.1109-0130.1	186498
24.1109-0133.1	197011
24.1110-0111.1	186288
24.1110-0117.1	186125
24.1110-0150.1	186117
24.1110-0151.1	186249
24.1110-0178.1	186114
24.1110-0182.1	186292
24.1110-0201.1	186294
24.1110-0202.1	186295
24.1110-0203.1	186517
24.1110-0207.1	186114

	
ATE (.../...)	
24.1110-0209.1	186290
24.1110-0210.1	186773
24.1110-0211.1	186839
24.1110-0217.1	186469
24.1110-0224.1	186773
24.1110-0226.1	186566
24.1110-0227.1	186568
24.1110-0249.1	186497
24.1110-0258.1	186294
24.1110-0259.1	197124
24.1110-0260.1	197032
24.1110-0261.1	186807
24.1110-0271.1	186812
24.1110-0274.1	197009
24.1110-0275.2	186288
24.1110-0276.2	186517
24.1110-0277.1	186857
24.1110-0278.1	197035
24.1110-0287.1	186295
24.1111-0137.1	186176
24.1111-0158.1	186843
24.1112-0106.1	186245
24.1112-0117.1	186182
24.1112-0124.1	186124
24.1112-0126.1	186274
24.1112-0128.1	186298
24.1112-0142.1	197033
24.1112-0148.1	186856
24.1112-0152.1	186809
24.1112-0154.1	186834
24.1112-0157.1	186854
24.1112-0158.1	186833
24.1112-0166.1	197038
24.1112-0168.1	197017
24.1112-0169.1	197031
24.1112-0169.1	197031
24.1113-0137.1	186180
24.1113-0138.1	186115
24.1113-0142.1	186771
24.1113-0160.1	186113
24.1113-0166.1	186268
24.1113-0167.1	186118
24.1113-0178.1	186251
24.1113-0179.1	186269
24.1113-0181.1	186408
24.1113-0189.1	186310
24.1113-0194.1	186801
24.1113-0197.1	186642
24.1114-0101.1	186254
24.1114-0108.1	186283
	186310
24.1114-0113.1	186687
24.1115-0105.1	186270
24.1115-0111.1	186753
24.1116-0101.1	186692
24.1116-0104.1	186770
24.1116-0108.1	186314
24.1116-0109.1	186770

	
ATE (.../...)	
24.1116-0110.1	187045
24.1118-0105.1	197218
24.1118-0111.1	186725
24.1119-0107.1	186559
24.1119-0108.1	186861
24.1120-0120.1	186273
24.1120-0123.1	186246
24.1120-0128.1	186247
24.1120-0154.1	186860
24.1120-0173.1	186882
24.1120-0183.1	197084
24.1120-0195.1	197049
24.1120-0196.1	197050
24.1120-0204.1	197158
24.1121-0114.1	186871
24.1122-0100.1	186313
24.1122-0101.1	186519
24.1122-0108.1	186267
24.1122-0112.1	186116
24.1122-0115.1	186275
24.1122-0118.1	186112
24.1122-0119.2	186103
24.1122-0122.1	186119
24.1122-0123.1	186185
24.1122-0124.1	186177
24.1122-0132.1	186280
24.1122-0133.1	186465
24.1122-0136.1	186460
24.1122-0139.1	186291
24.1122-0145.1	186265
24.1122-0150.1	186604
24.1122-0152.1	186582
24.1122-0159.1	186697
24.1122-0160.1	186815
24.1122-0161.1	186774
24.1122-0163.1	197088
24.1122-0196.1	197059
24.1122-0201.1	186865
24.1122-0202.1	186582
24.1122-0204.1	186762
24.1122-0209.1	186883
24.1122-0210.1	186754
24.1122-0215.1	197243
24.1122-0218.1	197094
24.1122-0219.1	197139
24.1122-0222.1	197089
24.1122-0223.1	197140
24.1122-0224.1	197251
24.1122-0236.1	197175
24.1122-0243.1	197212
24.1124-0118.1	186315
24.1124-0120.1	186277
24.1124-0128.1	186682
24.1124-0133.1	186496
24.1124-0143.1	186284
24.1124-0159.1	186707
24.1124-0161.1	186750



ATE (.../...)	
24.1124-0181.1	186732
24.1124-0197.1	197234
24.1124-0200.1	197073
24.1125-0102.1	186272
24.1125-0105.1	197222
24.1125-0108.1	186521
24.1125-0110.1	186467
	186864
24.1125-0113.1	197230
24.1125-0115.1	186583
24.1125-0119.1	197226
24.1125-0123.1	197246
24.1125-0125.1	186500
24.1125-0137.1	186758
24.1125-0138.1	186731
24.1125-0141.1	186881
24.1125-0142.1	197244
24.1125-0145.1	186755
24.1125-0158.1	197242
24.1125-0160.1	197083
24.1125-0164.1	197224
24.1125-0167.1	197091
24.1125-0175.1	197143
24.1125-0176.1	197062
24.1126-0102.1	186526
24.1126-0103.1	186405
24.1126-0107.1	197056
24.1126-0115.1	197239
24.1126-0122.1	186789
24.1128-0103.1	186461
24.1128-0105.1	197227
24.1128-0123.1	186741
24.1128-0137.1	186880
24.1128-0141.1	186751
24.1128-0144.1	197057
24.1128-0149.1	197090
24.1128-0169.1	197051
24.1128-0176.1	186751
24.1128-0177.1	197200
24.1130-0107.1	186884
24.1130-0109.1	186808
24.1130-0113.1	197198
24.1130-0114.1	186756
24.1130-0115.1	197197
24.1130-0173.1	197193
24.1130-0176.1	197142
24.1132-0114.1	186811
24.1132-0117.1	197087
24.1132-0154.1	197093
24.1132-0158.1	197092
24012801281	197220
BENDIX	
561003B	186189
561032B	186128
561038B	186202
561039B	186495



BENDIX (.../...)	
561043B	186226
561074B	186171
561086B	186142
561087B	186249
561094B	186240
561099B	186207
561102B	186180
561108B	186115
561114B	186160
561115B	186254
561116B	186256
561117B	186501
561120B	186151
561121B	186169
561126B	186110
561127B	186170
561130B	186172
561132B	186117
561133B	186140
561137B	186197
561141B	186245
561142B	186186
561143B	186242
561145B	186211
561146B	186158
561150B	186152
561157B	186257
561158B	186187
	186757
561159B	186205
561170B	186137
561171B	186218
561175B	186116
561178B	186246
561180B	186103
561181B	186139
561185B	186255
561221B	186143
561235B	186230
	186803
561236B	186135
561237B	186134
561238B	186113
561239B	186273
561240B	186292
561241B	186203
561242B	186140
561244B	186112
561248B	186188
	186790
561252B	186771
561253B	186200
561254B	186210
561256B	186236
	186613
561257B	186228
561266B	186118



BENDIX (.../...)	
561275B	186166
561283B	186692
561289B	197004
561297B	186225
561305B	186776
561312B	186114
561314B	186195
561321B	186206
561324B	186119
561325B	186156
561326B	186157
561327B	186150
561328B	186149
561329B	186146
	186290
561330B	186176
561331B	186185
561332B	186182
561333B	186184
561334B	186214
561336B	186229
561339B	186136
561340B	186290
561345B	186219
561346B	186221
561347B	186213
561349B	186613
561352B	186283
561353B	186310
561355B	186299
561356B	186165
561357B	186165
561358B	186102
561359B	186130
561360B	187029
561364B	186198
561373B	186159
561375B	186425
561378B	186168
561380B	186155
	186406
561383B	186432
	186435
561384B	186431
561385B	186234
	186431
561387B	186266
561388B	186173
561389B	186177
561390B	197165
561403B	197028
561405B	186625
561406B	186191
561407B	186192
561408B	186190
561409B	186194
561410B	186196



BENDIX (.../...)	
561411B	186199
561416B	186231
561417B	186498
561424B	186374
561425B	197114
561430B	186511
561435B	186508
561437B	186770
561442B	186509
	186696
561444B	186637
	186645
561446B	186258
561447B	186311
561448B	186247
561450B	186479
561451B	186424
561460B	186288
561468B	186153
561469B	186154
561470B	186264
561471B	186272
561473B	186235
561474B	186234
	186235
561476B	186124
561477B	186125
561482B	186131
561483B	186455
561485B	186664
561486B	186482
561488B	186189
561489B	186220
561490B	186511
561491B	186251
561492B	186263
561493B	186770
561495B	186232
561496B	186162
561501B	186509
561502B	186547
561505B	186504
561508B	186297
561509B	186145
561510B	186224
561511B	186287
561512B	186289
561513B	186163
561516B	186147
561518B	186530
561519B	186148
561520B	186265
561521B	186441
561530B	186302
561532B	186204
561533B	186665
561534B	186500







	
BENDIX (.../...)	
561535B	186235
561538B	186770
561547B	186270
561548B	197222
561549B	186294
561550B	186274
561551B	186275
561552B	186295
561555B	186196
	186416
561556B	186144
561563B	186440
561565B	186446
561569B	186446
561574B	186465
561575B	186461
561576B	186462
561577B	186178
561582B	186485
561588B	186282
561591B	186768
	186775
561592B	186304
561593B	186600
561594B	186305
561595B	186306
561596B	186307
561601B	186510
561607B	186652
561608B	186519
561609B	186314
561610B	186315
561611B	186311
561612B	186614
561614B	186301
561615B	186487
561616B	186303
561618B	186567
561619B	186313
561620B	186517
561621B	186285
561622B	186286
561623B	186495
561624B	186278
561625B	186537
561628B	186520
561629B	186284
561630B	186433
	186438
561637B	186611
561642B	186617
561643B	186488
561649B	186487
561650B	186505
561652B	186490
561654B	186159
561660B	186223



	
BENDIX (.../...)	
561663B	186300
561664B	186405
561671B	186436
	186439
561672B	186875
561676B	197166
561677B	186460
561678B	186277
561679B	186426
561682B	186276
561684B	186621
561688B	186269
561689B	186291
561690B	186268
	186768
561691B	186267
561694B	186496
561696B	186298
561697B	186280
561698B	186281
561704B	186586
561705B	186296
561709B	186428
561711B	186433
561712B	186439
561713B	186699
561714B	186452
561715B	186454
561716B	186457
561717B	186458
561725B	186564
561726B	186564
561728B	186654
561730B	197225
561733B	186768
561735B	186503
561744B	186652
561745B	197148
561748B	186514
561765B	186653
561795B	186451
561808B	186652
561814B	186778
561815B	186476
561822B	197169
561824B	186648
561827B	186439
561829B	186114
561856B	186521
561857B	197218
561861B	186153
561863B	186807
561866B	186526
561867B	186528
561868B	186775
561871B	186449
561879B	197094



	
BENDIX (.../...)	
561882B	186427
561883B	186612
561884B	186476
561923B	186151
	186155
	186406
561926B	186648
561944B	186453
561948B	197227
561950B	186570
561953B	186640
561960B	197226
561961B	186565
561962B	186566
561963B	186183
	186470
561964B	186421
561965B	186774
561966B	186643
561967B	186420
561968B	186701
561969B	197228
561972B	186299
561978B	186497
561979B	186408
561980B	186581
561981B	186523
561982B	186773
561983B	186311
561984B	186418
561986B	186401
561987B	186443
561992B	186207
	197217
561997B	186208
562003B	186559
562005B	186773
562007B	186839
562011B	186818
562013B	186467
	186647
	186864
562014B	186469
562016B	186432
562019B	186533
562024B	186576
562025B	186577
562027B	186532
562032B	186487
562033B	186589
562035B	186697
562036B	186860
562038B	186529
562039B	186604
562040B	186603
562041B	197230
562042B	186579

	
BENDIX (.../...)	
562043B	197236
562044B	186599
562045B	186198
562048B	186562
562049B	186573
562052B	186583
562053B	186597
562054B	186551
562055B	186598
562056B	186571
562057B	186624
562059B	186647
562060B	186582
562061B	186605
562062B	186568
562063B	197223
562064B	186585
562065B	186552
562067B	186719
562068B	186591
562069B	186592
562070B	186684
562071B	186594
562072B	186593
562073B	186681
562074B	186714
	197221
562075B	186628
562077B	186822
562078B	186560
562079B	186725
562080B	186682
562082B	186620
562085B	197229
562086B	186774
562089B	186294
562090B	186815
562094B	186861
562100B	186753
562103B	186655
562104B	186600
562105B	186688
562107B	186569
562110B	197224
562111B	186642
562114B	186691
562115B	186563
562117B	186827
562119B	186686
562120B	186774
562122B	186781
562124B	186784
562125B	186705
562126B	186702
562127B	186785
562128B	186695
562129B	186693



 	
BENDIX (.../...)	
562130B	186694
562131B	197220
562132B	197246
562133B	197088
562134B	186808
562135B	186809
562136B	186734
562137B	186730
562138B	186742
562139B	186762
562140B	186710
562141B	186709
562142B	197146
562143B	186778
562144B	186777
562147B	197238
562149B	186760
562150B	197240
562152B	186442
562153B	186687
562155B	186859
562156B	197033
562160B	197004
562161B	186488
562163B	186703
562164B	186740
562165B	186814
562166B	197016
562167B	197163
562168B	186704
562169B	186587
562170B	186894
562171B	186729
562173B	186741
562174B	186841
562177B	197011
562178B	186590
562180B	186750
562181B	186791
562182B	186715
562183B	197221
562184B	186718
562187B	186804
562188B	186731
562189B	186736
562190B	186868
562191B	186856
562192B	186807
562193B	186834
562194B	186812
562195B	186757
562196B	186759
562197B	197063
562198B	197239
562199B	186758
562200B	186884
562201B	186786



 	
BENDIX (.../...)	
562205B	197198
562207B	197206
562209B	197086
562211B	186713
562212B	186751
562213B	197035
562214B	197138
562216B	186881
562219B	197104
562220B	186882
562221B	197231
562222B	186880
562224B	197219
562225B	186871
562226B	186788
562227B	186845
562229B	186854
562230B	186764
562231B	197144
562232B	186821
562234B	186756
562235B	186755
562236B	186857
562237B	186754
562238B	186833
562239B	197197
562240B	197244
562241B	186712
562242B	186865
562244B	186789
562245B	186783
562246B	186724
562249B	197060
562251B	186748
562253B	186747
562254B	186855
562255B	197020
562258B	197031
562261B	186847
562262B	186886
562263B	186858
562265B	197199
562266B	186746
562267B	197232
562268B	186764
562269B	186765
562270B	197013
562271B	197052
562273B	197173
562274B	197036
562275B	186797
562276B	197018
562277B	197242
562278B	186869
562282B	197015
562288B	197112
562290B	186790



 	
BENDIX (.../...)	
562292B	197233
562293B	186802
562295B	186745
562296B	186744
562297B	197045
562298B	197136
562299B	197247
562300B	197130
562301B	197098
562302B	197132
562304B	197044
562305B	197044
562306B	197008
562307B	186888
	197247
562308B	186805
	197098
562309B	186798
	186888
562311B	197047
562312B	186799
562313B	186816
562314B	197091
562315B	186869
562316B	197049
562317B	186817
562318B	186883
562319B	197084
562320B	186732
562321B	197232
562322B	186890
562325B	197090
562327B	197251
562330B	197073
562332B	197193
562334B	197175
562335B	197046
562341B	186811
562343B	197092
562350B	197083
562354B	197200
562361B	186842
562363B	186863
562364B	186819
562365B	186713
562366B	186775
562367B	186768
562368B	186720
562370B	186517
562371B	186773
562372B	186288
562373B	186840
562374B	197002
562376B	186796
562377B	186720
562378B	186718
562379B	186853



 	
BENDIX (.../...)	
562380B	186691
562381B	197221
562382B	197239
562383B	186758
562384B	186884
562385B	186880
562387B	197242
562391B	197130
562392B	186890
562393B	197090
562395B	197073
562397B	197193
562398B	197046
562402B	186811
562403B	197092
562409B	186766
562410B	197241
562411B	186843
562414B	186877
562415B	186848
562416B	186851
562418B	186849
562419B	197120
562420B	186846
562421B	197184
562422B	197111
562423B	197150
562425B	186879
562427B	186878
562428B	197096
562430B	197070
567118B	187058
567128B	187040
567760B	186774
567761B	187045
567771B	197033
567810B	197059
569104B	187147
569105B	187148
569106B	187149
569120B	197033
569121B	187045
569122B	186774
569136B	187141
569137B	197030
569138B	187146
569159B	187130
BOSCH	
0 204 173 008	197070
0 986 478 010	186249
0 986 478 011	186245
0 986 478 012	186731
0 986 478 016	186113
0 986 478 017	186246
0 986 478 018	186112
0 986 478 019	186114



	
BOSCH (.../...)	
0 986 478 024	186884
0 986 478 029	186118
0 986 478 032	186115
0 986 478 033	186116
0 986 478 034	186117
0 986 478 036	186119
0 986 478 046	186200
0 986 478 050	186128
0 986 478 051	186142
0 986 478 052	186143
0 986 478 058	186180
0 986 478 063	186151
0 986 478 065	186520
0 986 478 066	186152
0 986 478 067	186205
0 986 478 068	186160
0 986 478 072	186158
0 986 478 079	186189
0 986 478 080	186186
	197150
0 986 478 081	186187
	186757
0 986 478 086	186490
	197226
0 986 478 089	186197
0 986 478 090	186134
0 986 478 091	186202
0 986 478 094	186203
0 986 478 103	186226
0 986 478 105	186230
	186803
0 986 478 107	186405
0 986 478 109	197069
0 986 478 112	186211
0 986 478 113	186218
0 986 478 114	186176
0 986 478 115	186433
0 986 478 121	186240
0 986 478 124	186208
0 986 478 125	186303
0 986 478 128	186291
0 986 478 130	186268
0 986 478 131	186269
0 986 478 132	186294
0 986 478 136	186771
0 986 478 140	186145
0 986 478 141	186144
0 986 478 142	186276
0 986 478 143	186256
0 986 478 144	186254
0 986 478 146	186257
0 986 478 148	186159
0 986 478 160	186278
0 986 478 166	186537
0 986 478 170	186277
0 986 478 174	186438
0 986 478 186	186185

	
BOSCH (.../...)	
0 986 478 187	186182
0 986 478 188	186184
0 986 478 189	186692
0 986 478 190	186169
0 986 478 192	186188
0 986 478 195	186165
0 986 478 196	186424
0 986 478 198	186255
0 986 478 200	186206
0 986 478 211	186195
0 986 478 216	186292
0 986 478 218	186139
0 986 478 224	186770
0 986 478 225	186273
0 986 478 227	186457
0 986 478 228	186102
0 986 478 229	186272
0 986 478 232	186140
0 986 478 234	186136
0 986 478 235	186156
0 986 478 236	186150
0 986 478 237	186149
0 986 478 238	186146
0 986 478 239	186232
0 986 478 240	186234
0 986 478 241	186449
0 986 478 246	186130
0 986 478 252	186453
0 986 478 255	186281
0 986 478 257	186479
0 986 478 262	186298
0 986 478 265	186191
0 986 478 266	186192
0 986 478 267	186190
0 986 478 268	186198
0 986 478 270	186214
0 986 478 273	186228
0 986 478 275	186213
0 986 478 276	186229
0 986 478 277	186476
0 986 478 278	186221
0 986 478 279	186219
0 986 478 280	186224
0 986 478 283	186263
0 986 478 284	186564
0 986 478 286	186743
0 986 478 288	186300
0 986 478 289	186223
0 986 478 295	186509
0 986 478 296	186800
0 986 478 297	186311
0 986 478 299	186709
0 986 478 301	186280
0 986 478 303	186710
0 986 478 307	186776
0 986 478 308	186247
0 986 478 314	186814

	
BOSCH (.../...)	
0 986 478 319	186124
0 986 478 321	186125
0 986 478 325	186183
	186470
0 986 478 326	186625
0 986 478 327	186189
0 986 478 328	186302
0 986 478 329	186251
0 986 478 330	186177
0 986 478 331	186288
0 986 478 332	186517
0 986 478 341	186290
0 986 478 342	186155
	186406
0 986 478 343	186154
0 986 478 344	186425
0 986 478 345	186168
0 986 478 346	186166
0 986 478 350	186435
0 986 478 353	186157
0 986 478 357	186178
0 986 478 358	197165
0 986 478 359	186199
0 986 478 360	186299
0 986 478 370	186194
0 986 478 371	186196
0 986 478 374	186498
0 986 478 376	197114
0 986 478 377	186374
0 986 478 384	186637
0 986 478 385	186511
0 986 478 386	186258
0 986 478 388	186264
0 986 478 390	186225
0 986 478 391	186231
0 986 478 396	186508
0 986 478 397	186696
0 986 478 415	186699
0 986 478 420	186565
0 986 478 421	186624
0 986 478 422	186628
0 986 478 424	186567
0 986 478 425	186568
0 986 478 426	186860
0 986 478 427	186401
0 986 478 429	186454
0 986 478 430	186497
0 986 478 433	187045
0 986 478 434	186418
0 986 478 435	186421
0 986 478 436	186566
0 986 478 437	186585
0 986 478 438	186875
0 986 478 442	186775
0 986 478 447	186234
0 986 478 448	186439
0 986 478 450	186827

	
BOSCH (.../...)	
0 986 478 451	186705
0 986 478 453	186547
0 986 478 454	197056
0 986 478 458	186611
0 986 478 459	186577
0 986 478 460	186443
0 986 478 461	186294
0 986 478 464	186416
0 986 478 467	197246
0 986 478 469	186753
0 986 478 474	186783
0 986 478 475	186760
0 986 478 478	197009
0 986 478 479	186859
0 986 478 480	197032
0 986 478 481	197011
0 986 478 482	197088
0 986 478 483	197224
0 986 478 485	186563
0 986 478 486	197004
0 986 478 487	186488
0 986 478 490	186686
0 986 478 491	186874
0 986 478 492	186729
0 986 478 493	186707
0 986 478 494	186741
0 986 478 495	186841
0 986 478 496	186685
0 986 478 497	186642
0 986 478 501	186162
0 986 478 502	186163
0 986 478 503	186431
0 986 478 505	186500
0 986 478 506	186510
0 986 478 508	186519
0 986 478 511	186274
0 986 478 512	186148
0 986 478 513	186275
0 986 478 515	186153
0 986 478 517	186147
0 986 478 521	186265
0 986 478 523	186455
0 986 478 524	186446
0 986 478 525	186460
0 986 478 526	186461
0 986 478 531	186648
0 986 478 533	186482
0 986 478 534	186301
0 986 478 535	186282
0 986 478 539	186504
0 986 478 541	186652
0 986 478 542	186313
0 986 478 544	186770
0 986 478 545	186270
0 986 478 546	197222
0 986 478 547	186314
0 986 478 548	186315



BOSCH (.../...)	
0 986 478 550	186267
0 986 478 555	197059
0 986 478 556	186204
0 986 478 557	186768
0 986 478 561	186295
0 986 478 564	186487
0 986 478 565	186462
0 986 478 566	186465
0 986 478 567	186485
0 986 478 568	186436
	186439
0 986 478 569	186801
0 986 478 570	186861
0 986 478 571	186815
0 986 478 572	186818
0 986 478 578	186701
0 986 478 580	186638
0 986 478 582	186587
0 986 478 583	186876
0 986 478 584	197169
0 986 478 588	197226
0 986 478 590	186655
0 986 478 591	186299
0 986 478 593	197225
0 986 478 596	186488
0 986 478 598	186304
0 986 478 601	186812
0 986 478 603	186526
0 986 478 604	186586
0 986 478 605	186426
0 986 478 606	186762
0 986 478 608	186694
0 986 478 611	186306
0 986 478 613	197218
0 986 478 615	186408
0 986 478 618	186695
0 986 478 619	186521
0 986 478 620	186581
0 986 478 621	186523
0 986 478 622	197227
0 986 478 624	186467
	186864
0 986 478 626	186469
0 986 478 627	186788
0 986 478 629	186640
0 986 478 632	197166
0 986 478 633	186458
0 986 478 634	186439
0 986 478 635	186653
0 986 478 638	186451
0 986 478 639	186590
0 986 478 641	186839
0 986 478 642	186559
0 986 478 643	186612
0 986 478 647	186614
0 986 478 649	187029
0 986 478 650	186576



BOSCH (.../...)	
0 986 478 652	186648
0 986 478 654	186648
0 986 478 656	186310
0 986 478 657	186286
0 986 478 664	186572
0 986 478 667	186778
0 986 478 668	186605
0 986 478 669	197229
0 986 478 671	186427
0 986 478 672	186428
0 986 478 673	186440
0 986 478 674	186441
0 986 478 675	186617
0 986 478 698	186704
0 986 478 701	186452
0 986 478 704	197124
0 986 478 706	186664
0 986 478 712	186742
0 986 478 713	186691
0 986 478 716	186647
0 986 478 717	186496
0 986 478 718	186750
0 986 478 719	186220
0 986 478 721	186505
0 986 478 725	186652
0 986 478 726	197167
0 986 478 727	186777
0 986 478 728	186821
0 986 478 729	186784
0 986 478 730	186759
0 986 478 731	186791
0 986 478 732	186702
0 986 478 733	186785
0 986 478 734	186600
0 986 478 736	186110
0 986 478 740	186501
0 986 478 742	186170
0 986 478 743	197221
0 986 478 744	186718
0 986 478 745	186688
0 986 478 746	186172
0 986 478 747	186173
0 986 478 749	186135
0 986 478 751	186131
0 986 478 757	186307
0 986 478 759	186773
0 986 478 760	186103
0 986 478 761	186137
0 986 478 770	186207
0 986 478 772	197238
0 986 478 774	186823
0 986 478 776	186530
0 986 478 781	197208
0 986 478 786	186297
0 986 478 787	197161
0 986 478 793	197094
0 986 478 794	186287



BOSCH (.../...)	
0 986 478 799	186503
0 986 478 802	186665
0 986 478 810	186266
0 986 478 811	186495
0 986 478 812	186420
0 986 478 813	186613
0 986 478 819	186236
0 986 478 824	186284
0 986 478 827	186283
0 986 478 830	186532
0 986 478 831	186533
0 986 478 834	186296
0 986 478 836	186564
0 986 478 837	197016
0 986 478 839	197162
0 986 478 840	186621
0 986 478 842	197228
0 986 478 843	197217
0 986 478 844	186719
0 986 478 846	186682
0 986 478 847	186599
0 986 478 848	186697
0 986 478 849	186774
0 986 478 852	186604
0 986 478 853	186603
0 986 478 854	197223
0 986 478 855	186745
0 986 478 856	186529
0 986 478 858	186822
0 986 478 859	186681
0 986 478 861	186551
0 986 478 863	197033
0 986 478 864	186305
0 986 478 865	186654
0 986 478 866	186775
0 986 478 867	197230
0 986 478 868	186597
0 986 478 869	186582
0 986 478 870	186725
0 986 478 872	186583
0 986 478 873	186552
0 986 478 874	186562
0 986 478 875	186573
0 986 478 877	186579
0 986 478 878	186571
0 986 478 879	186569
0 986 478 880	186591
0 986 478 881	186592
0 986 478 882	186594
0 986 478 883	186684
0 986 478 884	186593
0 986 478 885	187058
0 986 478 886	187040
0 986 478 887	186598
0 986 478 888	186773
0 986 478 889	186620
0 986 478 892	186560



BOSCH (.../...)	
0 986 478 893	197236
0 986 478 896	186589
0 986 478 897	186648
0 986 478 898	186647
0 986 478 963	197137
0 986 478 967	197195
0 986 478 968	197168
0 986 478 970	186740
	186868
0 986 478 971	186894
	197003
0 986 478 972	186804
0 986 478 973	186808
0 986 478 974	186808
0 986 478 975	186883
0 986 478 976	197230
0 986 478 979	186693
0 986 478 980	197220
0 986 478 981	186736
0 986 478 982	186780
0 986 478 983	186730
0 986 478 984	197064
0 986 478 985	197198
0 986 478 986	186807
0 986 478 987	186856
0 986 478 988	186603
0 986 478 989	186810
0 986 478 990	186813
0 986 478 991	186687
0 986 478 992	186871
0 986 478 993	186442
0 986 478 996	197063
0 986 478 999	197122
0 986 479 001	186868
0 986 479 006	186743
0 986 479 007	186796
0 986 479 012	186766
0 986 479 013	197206
0 986 479 014	197103
0 986 479 020	197207
0 986 479 024	197231
0 986 479 027	186703
0 986 479 029	186734
0 986 479 030	186728
0 986 479 033	186866
	197146
0 986 479 036	186888
0 986 479 037	197239
0 986 479 038	186751
0 986 479 039	186751
0 986 479 041	197035
0 986 479 042	186865
0 986 479 054	197086
0 986 479 055	186732
0 986 479 056	197084
0 986 479 057	186758
0 986 479 058	197242



 BOSCH (.../...)	
0 986 479 064	186724
0 986 479 066	186708
0 986 479 068	186834
0 986 479 069	186748
0 986 479 070	197013
0 986 479 071	197060
0 986 479 076	186880
0 986 479 077	186869
0 986 479 078	186712
0 986 479 083	186893
0 986 479 084	186877
0 986 479 086	186848
0 986 479 087	186847
0 986 479 088	186755
0 986 479 094	197243
0 986 479 095	197090
0 986 479 096	186885
0 986 479 097	186886
0 986 479 098	186754
0 986 479 099	186857
0 986 479 100	197138
0 986 479 101	186432
0 986 479 102	197022
0 986 479 103	186764
0 986 479 104	186846
0 986 479 105	186845
0 986 479 106	186854
0 986 479 107	186881
0 986 479 108	186720
0 986 479 109	197240
0 986 479 111	186765
0 986 479 113	197244
0 986 479 114	197219
0 986 479 115	197193
0 986 479 117	197233
0 986 479 119	197108
0 986 479 120	186797
0 986 479 121	186744
0 986 479 124	197172
0 986 479 126	197027
0 986 479 127	197207
0 986 479 128	197020
0 986 479 131	186851
0 986 479 132	197245
0 986 479 135	197200
0 986 479 137	186890
0 986 479 138	186858
0 986 479 139	186707
0 986 479 142	186882
0 986 479 144	186713
0 986 479 146	197062
0 986 479 149	197019
0 986 479 155	186833
0 986 479 157	197222
0 986 479 161	187148
0 986 479 162	187147
0 986 479 163	187149

 BOSCH (.../...)	
0 986 479 164	186802
0 986 479 165	186803
0 986 479 166	197251
0 986 479 167	186809
0 986 479 169	186842
0 986 479 170	186843
0 986 479 171	186863
0 986 479 173	186819
0 986 479 178	197021
0 986 479 179	186872
0 986 479 185	186798
0 986 479 186	186799
0 986 479 187	197214
0 986 479 189	186757
0 986 479 190	186790
0 986 479 191	186855
0 986 479 192	197046
0 986 479 193	186746
0 986 479 194	186747
0 986 479 195	186786
0 986 479 196	186853
0 986 479 198	186717
0 986 479 199	197079
0 986 479 200	197018
0 986 479 204	197197
0 986 479 205	197022
0 986 479 206	186879
0 986 479 207	186825
0 986 479 209	197241
0 986 479 210	186789
0 986 479 211	186756
0 986 479 213	186816
0 986 479 214	186817
0 986 479 215	197073
0 986 479 216	197234
0 986 479 218	197049
0 986 479 219	186840
0 986 479 222	197008
0 986 479 223	197044
0 986 479 224	197045
0 986 479 225	197104
0 986 479 227	197145
0 986 479 229	186829
0 986 479 230	197210
0 986 479 232	197209
0 986 479 234	197091
0 986 479 235	197036
0 986 479 236	197129
0 986 479 239	197047
0 986 479 241	197163
0 986 479 242	186849
0 986 479 243	186850
0 986 479 244	186587
0 986 479 245	197171
0 986 479 247	197031
0 986 479 248	197087
0 986 479 252	197038

 BOSCH (.../...)	
0 986 479 253	186843
0 986 479 254	197101
0 986 479 255	197002
0 986 479 257	197125
0 986 479 259	197051
0 986 479 260	197142
0 986 479 261	197055
0 986 479 262	197149
0 986 479 263	197158
0 986 479 265	197176
0 986 479 266	197188
0 986 479 267	197190
0 986 479 268	197191
0 986 479 269	197092
0 986 479 270	186720
0 986 479 271	186713
0 986 479 272	186894
0 986 479 273	186718
0 986 479 274	186853
0 986 479 275	197002
0 986 479 276	186893
0 986 479 277	186720
0 986 479 278	186796
0 986 479 279	186840
0 986 479 280	197003
0 986 479 281	186775
0 986 479 286	197096
0 986 479 287	197155
0 986 479 288	197232
0 986 479 289	197173
0 986 479 290	197130
0 986 479 291	197247
0 986 479 292	197098
0 986 479 293	197247
0 986 479 294	187141
0 986 479 295	197030
0 986 479 296	187146
0 986 479 297	186418
	197043
0 986 479 299	197140
0 986 479 300	197199
0 986 479 301	197052
0 986 479 303	197139
0 986 479 304	197071
0 986 479 307	197054
0 986 479 308	197066
0 986 479 310	197143
0 986 479 311	197010
0 986 479 312	197043
0 986 479 313	197248
0 986 479 314	197131
0 986 479 316	197097
0 986 479 317	197105
0 986 479 318	197116
0 986 479 322	197057
0 986 479 324	197130
0 986 479 326	197132

 BOSCH (.../...)	
0 986 479 327	197134
0 986 479 331	197201
0 986 479 338	197112
0 986 479 340	197072
0 986 479 341	197183
0 986 479 345	197121
0 986 479 348	197083
0 986 479 358	197164
0 986 479 360	197111
0 986 479 362	197106
0 986 479 363	197184
0 986 479 370	186805
0 986 479 371	197029
0 986 479 375	197156
0 986 479 377	197173
0 986 479 378	197098
0 986 479 379	197099
0 986 479 380	197133
0 986 479 381	197159
0 986 479 382	197126
0 986 479 383	197117
0 986 479 387	197117
0 986 479 388	197100
0 986 479 390	187152
0 986 479 392	197249
0 986 479 399	197023
0 986 479 400	197100
0 986 479 402	197028
0 986 479 403	197135
0 986 479 405	186811
0 986 479 406	197203
0 986 479 407	197202
0 986 479 409	197128
0 986 479 410	197127
0 986 479 418	197110
0 986 479 420	197113
0 986 479 425	197185
0 986 479 428	197152
0 986 479 429	197194
0 986 479 430	197147
0 986 479 431	197182
0 986 479 435	186171
0 986 479 436	197178
0 986 479 437	197074
0 986 479 438	197160
0 986 479 439	197175
0 986 479 442	197179
0 986 479 443	197180
0 986 479 449	197102
0 986 479 454	197070
0 986 479 457	197212
0 986 479 459	186878
0 986 479 460	197205
0 986 479 461	197252
0 986 479 467	197213
0 986 479 470	197067
0 986 479 484	197120



BOSCH (.../...)	
0 986 479 485	197194
0 986 479 486	197065
0 986 479 488	186210
0 986 479 490	197148
0 986 479 491	186714
0 986 479 494	186295
0 986 479 497	197181
0 986 479 504	197015
0 986 479 508	197123
0 986 479 518	197107
0 986 479 519	197109
0 986 479 534	197144
0 986 479 537	197174
0 986 479 540	197204
0 986 479 548	197216
0 986 479 553	197192
0 986 479 554	197215
0 986 479 560	197187
0 986 479 743	186715
0 986 AB6 002	197121
0 986 AB6 003	197242
0 986 AB6 040	186701
0 986 AB6 047	186508
0 986 AB6 048	186652
0 986 AB6 051	186765
0 986 AB6 083	186699
0 986 AB6 090	186827
0 986 AB6 091	186829
0 986 AB6 092	197210
0 986 AB6 095	197027
0 986 AB6 099	197029
0 986 AB6 102	186278
0 986 AB6 103	186537
0 986 AB6 104	186529
0 986 AB6 105	197022
0 986 AB6 112	197052
0 986 AB6 113	197199
0 986 AB6 114	197198
0 986 AB6 115	197142
0 986 AB6 116	197140
0 986 AB6 117	186807
0 986 AB6 118	197125
0 986 AB6 119	197038
0 986 AB6 120	186294
0 986 AB6 121	197124
0 986 AB6 122	186773
0 986 AB6 123	197011
0 986 AB6 124	197246
0 986 AB6 125	197088
0 986 AB6 126	197031
0 986 AB6 127	186833
0 986 AB6 138	197200
0 986 AB6 140	186281
0 986 AB6 143	197096
0 986 AB6 144	186572
0 986 AB6 145	186551
0 986 AB6 147	186208



BOSCH (.../...)	
0 986 AB6 148	186884
0 986 AB6 155	186879
0 986 AB6 156	186878
0 986 AB6 157	197172
0 986 AB6 160	186130
0 986 AB6 161	186872
0 986 AB6 171	186759
0 986 AB6 172	186163
0 986 AB6 173	186571
0 986 AB6 185	186232
0 986 AB6 244	186874
0 986 AB6 271	197170
0 986 AB6 306	186728
0 986 AB6 307	186818
0 986 AB6 310	186648
0 986 AB6 316	197223
0 986 AB6 317	186235
0 986 AB6 320	186431
0 986 AB6 322	186439
0 986 AB6 328	186455
0 986 AB6 329	197063
0 986 AB6 333	186452
0 986 AB6 344	186547
0 986 AB6 348	197194
0 986 AB6 351	186640
0 986 AB6 352	186876
0 986 AB6 363	197018
0 986 AB6 376	186564
0 986 AB6 386	186696
0 986 AB6 392	186645
0 986 AB6 395	186866
0 986 AB6 399	186479
0 986 AB6 400	186511
0 986 AB6 403	186458
0 986 BB4 024	186774
0 986 BB4 039	186198
0 986 BB4 040	186200
0 986 BB4 041	186130
0 986 BB4 042	186251
0 986 BB4 046	186153
0 986 BB4 048	186188
0 986 BB4 054	186245
0 986 BB4 055	186155
	186745
0 986 BB4 061	186202
0 986 BB4 063	186228
0 986 BB4 064	186288
0 986 BB4 068	186194
0 986 BB4 072	186208
0 986 BB4 075	186173
0 986 BB4 079	186304
0 986 BB4 081	186199
0 986 BB4 082	186306
0 986 BB4 083	197222
0 986 BB4 086	186229
0 986 BB4 087	197165
0 986 BB4 088	187045



BOSCH (.../...)	
0 986 BB4 091	186195
0 986 BB4 092	186533
0 986 BB4 093	197217
0 986 BB4 094	186418
0 986 BB4 096	186134
0 986 BB4 138	186603
0 986 BB4 164	186282
0 986 BB4 170	186573
BREMBO	
08.1309.10	186189
08.1741.10	186128
08.1976.10	186202
08.1980.20	186495
08.2138.10	186226
08.2559.20	186171
08.2559.24	186171
08.2615.10	186142
08.2631.34	186249
08.2714.20	186240
08.2794.14	186113
08.2938.24	186134
08.2939.10	186135
08.2939.14	186135
08.2950.24	186176
08.2958.14	186230
	186803
08.2958.75	186230
	186803
08.2981.10	186771
08.2985.10	186200
08.2985.14	186200
08.2985.20	186199
08.2985.75	186200
08.3056.10	186207
08.3068.10	186118
08.3069.14	186206
08.3126.14	186146
08.3126.20	186290
08.3126.21	186290
08.3126.24	186290
08.3126.76	186290
08.3129.10	186150
08.3136.10	186136
08.3136.14	186136
08.3147.14	186228
08.3189.20	186180
08.3288.20	186115
08.3439.10	186160
08.3439.14	186160
08.3441.20	186256
08.3441.24	186256
08.3449.10	186501
08.3636.10	186151
08.3636.14	186151
08.3637.10	186169
08.3894.10	186110



BREMBO (.../...)	
08.3907.10	186170
08.3939.10	186172
08.3947.20	186117
08.3947.24	186117
08.3953.10	186140
08.3962.09	186197
08.3962.10	186197
08.3969.10	186143
08.4177.10	186245
08.4177.14	186245
08.4177.75	186245
08.4250.14	186186
	197150
08.4284.10	186211
08.4365.10	186152
08.4472.10	186257
08.4475.10	186187
08.4475.14	186187
	186757
08.4475.75	186187
08.4478.10	186205
08.4738.10	186184
08.4738.14	186184
08.4738.24	186281
08.4748.10	186236
08.4750.34	186182
08.4750.44	186298
08.4753.14	186157
08.4874.14	186114
08.4878.10	186147
08.4917.10	186406
08.4926.10	186192
08.4927.10	186190
08.4929.14	186130
08.4929.75	186130
08.4931.10	186424
08.4931.20	186425
08.4931.24	186425
08.4962.20	186158
08.4982.10	186254
08.4994.10	186374
08.5005.10	186288
08.5005.14	186288
08.5005.20	186517
08.5005.75	186288
08.5013.10	186168
08.5026.10	197114
08.5037.10	186498
08.5079.10	187029
08.5085.14	186155
08.5085.75	186155
08.5086.14	186154
08.5086.75	186154
08.5131.10	186299
08.5141.20	186124
08.5149.10	186251







	
BREMBO (.../...)	
08.5149.14	186251
08.5149.75	186251
08.5164.14	186162
08.5164.24	186162
08.5164.76	186162
08.5174.34	186125
08.5177.10	186770
08.5177.20	186770
08.5178.10	186183
08.5178.20	186470
08.5178.30	186470
08.5178.31	186470
08.5178.77	186470
08.5181.10	186178
08.5186.20	186258
08.5211.10	186173
08.5213.10	186292
08.5213.20	186807
08.5237.10	186311
08.5243.10	186530
08.5243.24	186681
08.5265.10	186131
08.5266.10	186504
08.5309.10	186302
08.5316.10	186310
08.5334.10	186416
08.5334.75	186416
08.5344.20	186204
08.5346.10	186462
08.5347.10	186283
08.5347.14	186283
	186310
08.5352.10	186144
08.5359.14	186274
08.5359.75	186274
08.5366.24	186295
08.5366.76	186295
08.5374.10	186614
08.5396.10	186770
08.5443.10	186487
08.5443.20	186487
08.5443.40	186564
08.5443.60	186564
08.5444.10	186692
08.5456.10	186285
08.5456.20	186285
08.5464.10	186495
08.5497.10	186314
08.5501.10	186520
08.5545.10	186232
08.5559.10	186490
	197226
08.5569.21	186528
08.5569.24	186528
08.5569.76	186528
08.5573.10	186196
08.5583.10	186276



	
BREMBO (.../...)	
08.5636.10	186621
08.5636.20	186569
08.5645.50	186307
08.5645.60	186306
08.5646.20	186225
08.5646.30	186223
08.5651.10	186567
08.5651.20	186596
08.5691.10	186300
08.5691.75	186300
08.5709.10	186269
08.5709.75	186269
08.5714.10	186268
08.5719.10	186432
08.5729.14	186586
08.5741.10	186454
08.5741.20	186454
08.5743.11	186294
08.5743.14	186294
08.5747.14	186270
08.5768.10	197218
08.5775.20	186114
08.5796.10	186453
08.5803.20	186768
	197015
08.5808.10	186428
08.5833.10	186775
08.5833.15	186775
08.5833.20	186775
08.5833.25	186775
08.5834.10	186768
08.5834.15	186768
08.5834.20	186768
08.5834.25	186768
08.5864.10	186510
08.5879.10	186497
08.5898.10	186421
08.5905.14	197217
08.5952.10	187040
08.5959.10	187058
08.6751.10	186408
08.6785.10	186581
08.6837.10	186435
08.6838.10	186642
08.6857.10	186452
08.6897.10	186503
08.6897.14	186503
08.6899.10	186654
08.6903.14	186529
08.6903.75	186529
08.6911.14	186773
08.6911.75	186773
08.6917.10	186568
08.6917.11	186568
08.6918.14	186620
08.6931.10	186579
08.6935.10	186624



	
BREMBO (.../...)	
08.6968.10	186552
08.7014.10	186565
08.7015.10	186566
08.7015.20	186566
08.7015.21	186566
08.7019.80	186809
08.7042.10	186647
08.7042.11	186647
08.7104.10	186435
08.7104.14	186435
08.7106.10	186691
08.7132.10	186725
08.7165.14	186597
08.7165.20	186729
08.7165.75	186597
08.7211.10	186469
08.7211.20	186469
08.7211.21	186469
08.7219.10	187147
08.7237.10	186714
08.7238.10	186599
08.7300.10	187148
08.7300.20	187149
08.7351.14	186598
08.7352.10	186458
08.7354.10	186605
08.7355.10	186846
08.7358.10	186562
08.7626.10	186594
08.7627.10	186593
08.7637.10	186591
08.7716.20	186785
08.7724.10	197033
08.7724.20	197033
08.7725.10	187045
08.7725.20	187045
08.7765.10	186841
08.7765.11	186841
08.7772.10	187130
08.7811.10	186777
08.7814.10	186687
08.7822.10	186742
08.7861.10	186797
08.7861.11	186797
08.7861.75	186797
08.7878.10	197016
08.7936.10	186753
08.7955.10	186724
08.8094.40	186708
08.8094.50	197023
08.8094.60	197097
08.8163.10	186859
08.8302.10	186839
08.8305.10	197009
08.8305.11	197009
08.8405.10	186858
08.8408.10	186773

	
BREMBO (.../...)	
08.8554.20	186642
	197017
08.8638.10	186757
08.8679.10	186798
08.8679.14	186798
08.8682.10	186747
	197010
08.8705.10	186784
08.8727.10	186736
08.8843.20	197125
08.9081.10	197120
08.9083.10	186294
08.9084.10	197032
08.9084.11	197032
08.9136.10	186807
08.9136.11	186807
08.9136.75	186807
08.9138.10	197108
08.9148.10	197011
08.9148.75	197011
08.9163.10	186812
08.9163.11	186812
08.9163.75	186812
08.9176.10	186801
08.9349.10	186729
08.9364.10	197098
08.9364.20	197098
08.9371.10	186740
08.9460.10	197008
08.9461.10	186845
08.9465.10	186786
08.9488.10	186833
08.9502.10	186857
08.9509.14	197030
08.9511.10	186854
08.9511.11	186854
08.9512.10	186840
08.9512.17	186840
08.9512.20	197002
08.9512.27	197002
08.9580.10	197036
08.9584.10	197035
08.9597.10	186713
08.9597.17	186713
08.9600.24	186134
08.9601.14	186206
08.9602.10	186416
08.9604.14	197217
08.9605.10	186435
08.9606.14	186598
08.9621.14	186154
08.9719.10	186694
08.9734.10	186834
08.9739.10	186791
08.9751.10	197124
08.9792.10	186718
08.9792.17	186718



	
BREMBO (.../...)	
08.9826.10	186855
08.9859.80	186295
08.9913.10	197107
08.9918.10	186856
08.9918.20	186856
08.9975.10	186843
08.9975.11	186843
08.A029.10	197021
08.A029.20	186842
08.A029.21	186842
08.A112.10	186851
08.A135.10	186853
08.A135.17	186853
08.A141.10	186796
08.A141.17	186796
08.A202.10	197031
08.A238.10	186720
08.A238.17	186720
08.A238.47	186720
08.A239.10	186893
08.A239.17	186893
08.A239.20	186894
	197003
08.A239.27	186894
	197003
08.A268.10	186802
08.A273.10	186847
08.A297.10	186844
	197013
08735475	186605
09.3023.20	186156
09.3059.10	186137
09.3090.14	186188
09.3090.75	186188
09.3095.20	197163
09.3125.10	186195
09.3140.10	186102
09.3148.14	186229
09.3148.75	186229
09.3149.14	186214
09.3357.10	186218
09.3358.10	186203
09.3946.10	186116
09.4115.10	186103
09.4165.10	186139
09.4481.10	186210
09.4626.10	186220
09.4629.10	186255
09.4765.14	186246
09.4765.75	186246
09.4768.10	186149
09.4777.14	186776
09.4869.34	186185
09.4869.44	186280
09.4883.10	186119
09.4914.34	186159
09.4914.40	186159



	
BREMBO (.../...)	
09.4925.10	186213
09.4930.14	186221
09.4939.14	186266
09.4939.21	186265
09.4939.24	186265
09.4939.34	197045
09.4939.75	186266
09.4939.76	186265
09.4947.20	186191
09.4959.10	186613
09.4987.24	186198
09.4987.76	186198
09.5004.10	186441
09.5009.20	186476
09.5011.20	186234
09.5011.30	186234
09.5017.10	186696
09.5023.10	186431
09.5033.10	186112
09.5036.14	186264
09.5058.14	186297
09.5058.20	186643
09.5058.75	186297
09.5082.10	186263
09.5084.20	186511
09.5084.24	186511
09.5122.10	186219
09.5124.10	186235
09.5125.10	186664
09.5134.10	186166
09.5148.24	186189
09.5148.76	186189
09.5166.14	186247
09.5166.75	186247
09.5173.10	186547
09.5173.14	186547
09.5180.10	186405
09.5180.24	186420
09.5180.30	186745
09.5194.10	186479
09.5196.14	186194
09.5196.75	186194
09.5215.10	186148
09.5220.10	186625
09.5221.10	186500
09.5251.10	186235
09.5252.10	186455
09.5253.10	186482
09.5254.20	186821
09.5264.10	186145
09.5282.10	186440
09.5285.10	186433
09.5285.75	186433
09.5290.14	186436
09.5290.75	186436
09.5296.10	186224
09.5307.10	186287



	
BREMBO (.../...)	
09.5343.10	186273
09.5373.20	186461
09.5390.34	186275
09.5390.77	186275
09.5447.10	186301
09.5449.14	186485
09.5457.10	186286
09.5457.20	186286
09.5488.10	186284
09.5509.14	186438
09.5509.75	186438
09.5527.24	186282
09.5536.20	186875
09.5566.10	186315
09.5568.21	186526
09.5568.24	186526
09.5568.76	186526
09.5570.10	186313
09.5570.75	186313
09.5574.10	186303
09.5577.10	186488
09.5584.14	186457
09.5587.10	186617
09.5587.75	186617
09.5616.10	186509
09.5623.10	197167
09.5623.14	197167
09.5624.10	197166
09.5627.10	186460
09.5632.10	197165
09.5634.10	186446
09.5640.14	186648
09.5640.75	186648
09.5652.20	197028
09.5654.10	186446
09.5676.10	186508
09.5676.20	186511
09.5679.10	186637
09.5694.10	186611
09.5707.14	186277
09.5707.75	186277
09.5708.10	186426
09.5710.10	186267
09.5716.10	186465
09.5730.10	186296
09.5734.10	186272
09.5736.14	186511
	186701
09.5742.10	186640
09.5745.14	197222
09.5745.21	197222
09.5745.24	197222
09.5745.75	197222
09.5745.76	197222
09.5749.10	197225
09.5801.10	186570
09.5802.10	186208



	
BREMBO (.../...)	
09.5802.14	186208
09.5802.24	186208
09.5802.75	186208
09.5802.76	186208
09.5804.10	186439
09.5807.10	186496
09.5809.10	186427
09.5843.10	186590
09.5843.34	197044
09.5844.10	197169
09.5844.24	186877
09.5844.75	197169
09.5845.20	197148
09.5857.14	186505
09.5857.75	186505
09.5866.10	186645
09.5869.14	186449
09.5870.14	186153
09.5870.20	186644
09.5870.34	186589
09.5870.75	186153
09.5875.10	197227
09.5904.14	186418
09.5906.14	197228
09.5914.10	186638
09.5919.20	186299
09.5957.10	186665
09.6705.10	186476
09.6708.10	186876
09.6723.10	186514
09.6725.10	186571
09.6726.10	186439
09.6727.14	186163
09.6727.34	186163
09.6727.77	186163
09.6728.10	186519
09.6728.75	186519
09.6742.10	186822
09.6747.10	186521
09.6753.10	186699
09.6766.10	186401
09.6767.14	186443
09.6769.10	186442
09.6769.20	197138
09.6771.10	186451
09.6771.14	186451
09.6799.14	186523
09.6799.75	186523
09.6803.10	186652
09.6804.10	186572
09.6806.10	186652
09.6816.10	186563
09.6817.10	186653
09.6839.10	197224
09.6841.11	186860
09.6841.14	186860
09.6841.75	186860



	
BREMBO (.../...)	
09.6845.11	186467
09.6845.14	186467
09.6845.75	186467
09.6859.10	186628
09.6866.10	186585
09.6866.20	197223
09.6879.20	186165
09.6879.76	186165
09.6893.10	186778
09.6893.14	186778
09.6924.11	186697
09.6924.14	186697
09.6924.75	186533
	186697
09.6925.14	186533
09.6932.10	186532
09.6934.14	197236
09.6934.75	197236
09.6942.10	186577
09.6943.10	186576
09.6943.75	186576
09.6959.10	186537
09.6967.14	186278
09.6983.10	186551
09.6997.10	197226
09.6997.20	197226
09.6997.21	197226
09.6997.24	197226
09.7010.10	197230
09.7010.20	197230
09.7010.76	197230
09.7011.14	186603
09.7011.20	186603
09.7011.24	186603
09.7011.75	186603
09.7012.14	186604
09.7012.75	186604
09.7043.10	186648
09.7043.20	186648
09.7056.10	186818
09.7056.75	186818
09.7074.10	197229
09.7074.11	197229
09.7117.10	186607
09.7131.14	186314
	186682
09.7157.10	186612
09.7195.10	186583
09.7196.14	186582
09.7225.10	186686
09.7226.10	186704
09.7263.20	187061
09.7279.10	186827
09.7291.20	186177
09.7292.34	186304
09.7292.40	186305
09.7292.77	186304

	
BREMBO (.../...)	
09.7314.14	186774
09.7314.24	186774
09.7359.10	186573
09.7359.20	186573
09.7359.75	186573
09.7367.14	186730
09.7376.10	197004
09.7376.14	197004
09.7377.10	186685
09.7379.10	197063
09.7386.10	186600
09.7386.30	186600
09.7386.34	186600
09.7386.40	186655
09.7386.44	186655
09.7395.10	186705
09.7398.10	197231
09.7398.11	197231
09.7606.10	186811
09.7606.11	186811
09.7628.14	186592
09.7628.75	186592
09.7629.10	186684
09.7629.75	186684
09.7680.10	186703
09.7701.10	186815
09.7701.11	186815
09.7701.75	186815
09.7702.10	186861
09.7702.11	186861
09.7702.75	186861
09.7717.10	186688
09.7719.10	186874
09.7720.10	186707
09.7720.11	186707
09.7720.75	186707
09.7727.10	186559
09.7727.75	186559
09.7764.10	186741
09.7806.14	186560
09.7806.75	186560
09.7807.10	197240
09.7820.10	186743
09.7820.20	186743
09.7821.10	186291
09.7824.10	197161
09.7825.10	186587
09.7825.75	186587
09.7826.10	186810
09.7877.10	197220
09.7879.10	186814
09.7880.10	197246
09.7880.11	197246
09.7880.75	197246
09.7928.10	186780
09.8003.10	197219
09.8004.10	197137

	
BREMBO (.../...)	
09.8071.10	186719
09.8137.14	186600
09.8137.24	186655
09.8137.75	186600
09.8137.76	186655
09.8303.10	186702
	186746
09.8303.75	186702
	186746
09.8317.10	186710
09.8404.10	186890
09.8407.10	197206
09.8411.10	186864
09.8411.11	186864
09.8411.75	186864
09.8475.10	197059
09.8483.10	186888
09.8519.10	186783
09.8545.10	186766
09.8601.10	186759
09.8609.10	186871
09.8616.10	186744
09.8632.10	197157
09.8633.10	186789
09.8633.11	186789
09.8635.10	186790
09.8642.10	197056
09.8642.11	197056
09.8655.10	186762
09.8655.11	186762
09.8655.75	186762
09.8670.10	197046
09.8670.14	197046
09.8680.14	186799
09.8681.10	197091
09.8689.10	197198
09.8689.11	197198
09.8689.75	197198
09.8690.10	186758
09.8690.11	186758
09.8690.75	186758
	197198
09.8695.10	186695
09.8695.14	186695
09.8695.75	186695
09.8697.80	186808
09.8760.10	186693
09.8760.75	186693
09.8837.14	186710
09.8841.30	197142
09.8842.20	197140
	197212
09.8852.10	197238
09.8864.10	197252
09.8864.75	197252
09.8873.30	197155
09.8873.31	197155

	
BREMBO (.../...)	
09.8874.30	197156
09.8874.31	197156
09.8894.14	186781
09.8894.75	186781
09.8931.10	186418
	197043
09.8932.10	197131
	197228
09.8933.10	197136
09.8933.11	197136
09.8936.10	186715
09.8937.10	186712
09.8952.10	186731
09.8952.11	186731
09.8952.75	186731
09.8960.10	186709
09.8961.10	186884
09.8961.20	186884
09.8961.21	186884
09.8977.10	197069
09.9074.10	197221
09.9079.10	197172
09.9080.10	186868
09.9126.10	186778
09.9130.10	186741
09.9130.11	186741
09.9131.10	197245
09.9131.14	197245
09.9133.80	186734
09.9142.10	197065
09.9145.10	186755
09.9145.14	186755
09.9145.75	186755
09.9159.10	186869
09.9159.20	186869
09.9162.10	186880
09.9162.11	186880
09.9162.14	186880
09.9165.10	186881
09.9165.11	186881
09.9165.14	186881
09.9167.10	186754
09.9167.75	186754
09.9172.14	197193
09.9173.14	186732
09.9185.10	186765
09.9362.14	186751
09.9363.10	197247
09.9363.20	197247
09.9365.10	197130
09.9365.20	197130
09.9366.10	197132
09.9366.20	197134
09.9368.10	186728
09.9368.20	186728
09.9369.10	197244
09.9369.11	197244



BREMBO (.../...)	
09.9425.10	197084
09.9442.14	186756
09.9447.14	186885
09.9464.11	186819
09.9464.14	186819
09.9464.24	186872
09.9468.11	186863
	197143
09.9468.14	186863
	197143
09.9503.10	197096
09.9505.10	186882
09.9505.11	186882
09.9508.14	187141
09.9510.14	187146
09.9534.14	197199
09.9537.10	197173
09.9537.20	197173
09.9540.14	197052
09.9541.10	186878
09.9544.10	197144
09.9545.10	197210
09.9554.10	186866
	197146
09.9555.10	186825
09.9555.20	186825
09.9559.14	197171
09.9573.10	197251
09.9574.20	186829
09.9581.10	197083
09.9581.14	197083
09.9582.10	186886
09.9589.14	186748
09.9590.10	186883
09.9598.10	186824
09.9599.10	197064
09.9607.14	186188
09.9608.24	186189
09.9609.24	186420
09.9610.14	186194
09.9611.14	186439
09.9612.10	186303
09.9613.10	186296
09.9614.14	186418
09.9615.14	197228
09.9616.14	186533
09.9618.14	186774
09.9619.10	186693
09.9624.14	186266
09.9624.24	186265
09.9626.14	186297
09.9630.10	186590
09.9631.14	186153
09.9727.14	197162
09.9728.10	186805
09.9728.14	186805
09.9743.10	197233



BREMBO (.../...)	
09.9749.10	197239
09.9750.14	186816
09.9752.14	186817
09.9755.10	197057
09.9772.10	197242
09.9793.10	197049
09.9797.10	186800
09.9799.10	197072
09.9818.10	186804
09.9821.10	186717
09.9821.20	197079
09.9867.11	197087
09.9895.10	197241
09.9908.21	186582
09.9928.14	197047
09.9931.14	197239
09.9935.14	197232
09.9936.14	186438
09.9996.10	186813
09.9998.10	186879
09.A110.10	197168
09.A200.10	197139
09.A204.10	197071
09.A235.10	197248
09.A258.10	186823
09.A259.10	197073
09.A270.10	197175
09.A271.14	197066
09.A272.10	197145
09.A296.14	197135
09.A330.10	197195
09.A350.10	197153
09.A386.10	197166
09.A428.14	197222
09.R104.11	197092
09866510	186750
09907810	186764
8863810	186757
9573610	186701
9772010	186707
9800310	197219
DELPHI	
BG2069	186496
BG2071	186226
BG2081	186495
BG2103	186256
	197168
	197219
BG2107	186128
BG2109	186246
BG2114	186202
BG2116	186245
BG2117	186249
BG2118	186160
BG2121	186240
BG2124	197239



DELPHI (.../...)	
BG2126	186140
BG2128	186139
BG2129	186142
BG2139	186254
BG2147	186151
BG2148	186187
	186757
BG2149	186186
BG2150	186236
	186443
BG2156	186257
	197233
BG2157	186169
BG2176	186171
BG2180	186115
BG2181	186501
BG2185	186110
BG2187	186140
BG2194	186211
	186559
BG2196	186116
BG2199	186103
BG2202	186117
BG2203	186152
BG2206	186213
	186860
BG2207	186255
	186728
	186731
BG2208	186172
BG2213	186200
BG2215	186113
BG2217	186230
BG2220	186135
BG2227	186203
BG2239	186202
	186205
BG2241	186715
	186764
BG2252	186118
BG2253	186206
BG2257	186136
BG2258	186228
BG2259	186180
BG2272	186112
BG2278	186188
	186790
BG2282	186229
BG2283	186214
BG2284	186218
BG2286	186210
BG2288	186176
BG2290	186613
BG2291	186184
BG2292	186195
BG2293	186197
BG2297	186283



DELPHI (.../...)	
BG2299	186143
BG2308	186134
BG2313	186157
BG2314	186182
BG2321	186150
BG2322	186146
BG2323	186149
	186202
BG2327	186232
BG2328	186137
BG2330	186156
BG2331	186165
BG2332	186424
BG2333	186273
BG2336	186234
BG2337	186235
BG2339	186166
BG2341	186776
	197022
	197244
BG2342	186784
	197244
BG2343	186114
BG2344	186784
BG2345	186185
	186461
BG2346	186165
BG2347	186119
BG2349	186168
BG2355	186130
BG2357	186299
BG2365	186479
BG2367	186159
BG2368	186102
BG2371	186213
BG2376	186158
BG2380	186192
BG2381	186190
	197229
	197231
BG2384	186191
BG2386	186290
	186424
BG2387	186198
BG2389	186288
BG2392	186234
BG2394	186441
BG2397	186177
BG2399	186431
BG2400	197114
BG2402	186374
BG2403	186221
BG2407	186266
BG2410	186114
BG2411	186154
BG2412	186147
BG2413	186148



	
DELPHI (.../...)	
BG2416	186665
BG2420	186498
BG2423	186696
BG2424	186511
BG2425	186263
	186791
BG2426	186264
	186614
	186880
BG2430	186124
BG2431	186125
BG2439	186162
BG2440	186163
	197004
BG2441	186266
BG2443	186189
BG2444	186194
BG2445	186196
BG2448	186219
BG2449	186224
BG2451	186232
BG2454	186251
BG2455	186247
BG2456	186220
BG2458	186155
	186406
BG2460	186145
BG2466	186173
BG2468	186770
BG2472	186159
BG2480	186207
BG2483	186214
BG2494	186178
BG2495	186547
BG2496	186258
	186653
	186800
BG2497	186625
BG2510	186183
	186470
BG2512	186265
BG2513	186664
BG2517	186292
	186807
BG2518	186272
BG2524	186488
BG2527	186131
BG2528	186144
BG2538	186432
	186435
BG2541	186235
BG2545	186432
BG2547	186455
BG2548	186446
BG2553	186446
BG2555	186807
BG2556	186692

	
DELPHI (.../...)	
BG2560	197165
BG2561	186653
BG2565	186482
BG2567	186485
BG2571	186302
BG2572	186199
BG2573	186204
BG2574	186231
BG2575	186223
	186579
BG2576	186530
BG2584	186374
	186504
BG2588	186596
BG2591	186637
BG2593	186508
BG2596	186509
	186652
BG2597	186510
	186511
BG2602	186770
BG2612	186284
BG2615	186286
	186719
BG2616	186285
BG2617	186297
BG2619	186500
	197226
BG2622	186274
BG2623	186275
	186487
BG2624	186295
BG2625	186208
	197230
BG2628	186617
BG2632	186301
BG2633	186487
BG2634	186564
BG2635	186490
BG2636	186282
BG2638	186768
BG2640	186768
BG2645	186505
BG2647	186770
BG2657	186440
BG2662	186278
BG2668	186267
BG2673	186433
	186438
BG2675	186461
BG2676	186462
BG2677	186460
BG2683	186300
BG2685	186611
BG2688	186303
BG2689	186621
BG2690	186296

	
DELPHI (.../...)	
BG2691	186586
BG2693	186304
BG2694	186306
BG2695	186305
BG2696	186307
BG2697	186600
	186655
BG2698	186307
BG2699	186277
BG2700	186426
BG2702	186768
	186775
BG2703	186225
BG2711	186652
BG2712	186519
BG2713	186313
BG2714	186517
BG2716	186314
	186750
BG2717	186315
BG2718	186791
BG2719	186289
	197035
BG2724	186276
BG2726	186405
BG2729	186521
	186758
	197222
BG2732	186311
	186751
	186804
BG2740	186465
BG2742	197225
BG2745	186758
	197222
BG2746	186294
BG2749	186270
	197222
BG2750	186496
BG2752	186268
BG2753	186807
BG2757	186299
BG2758	186428
BG2759	186438
BG2761	186281
BG2763	186648
BG2768	186280
BG2769	186298
BG2776	197094
BG2778	186453
BG2779	186457
BG2780	186427
BG2781	186428
BG2782	197166
BG2783	186269
BG2784	186291
BG2798	186436
	186439

	
DELPHI (.../...)	
BG2799	186310
BG2800	186416
BG2802	186449
BG2804	186451
BG2805	186452
BG2806	186458
BG2808	186476
BG2810	186818
BG2814	186699
BG2816	186439
BG2823	186487
BG2824	186223
BG2825	186151
	186287
BG2826	186503
BG2829	197194
BG2830	186153
BG2841	186526
	197104
	197121
BG2842	186528
	197144
BG2843	186643
BG2844	186420
BG2845	197217
BG2846	186418
BG2847	197228
BG2860	197224
BG2871	186532
BG2872	186533
BG2873	186579
BG2879	186497
BG2880	197148
	197169
BG2884	186685
	197169
BG2889	186652
BG2891	186701
BG2898	197218
BG2907	186520
BG2909	186714
BG2910	186681
BG2911	186581
	186834
BG2982	186523
BG2987	186291
	186408
BG302	186170
BG3025	197236
BG3026	186624
	186801
BG3030	186773
BG3034	186597
	197011
BG3035	197230
BG3036	186604
BG3039	197227



DELPHI (.../...)	
BG3040	186839
BG3041	186559
	186697
BG3042	186860
BG3043	186697
BG3044	186568
BG3049	186421
BG3054	186425
	186843
BG3055	186529
BG3056	186401
BG3061	186778
BG3063	186439
BG3070	197120
BG3071	186572
BG3077	186442
BG3078	186443
BG3083	186454
BG3089	186469
BG3095	186476
BG3099	186719
BG310	186771
BG3105	186691
BG3111	186818
BG3112	186647
BG3116	186648
BG3125	186564
BG3126	186654
BG3127	186563
BG3131	186846
BG3134	186577
BG3141	186565
BG3142	197226
BG3143	186488
BG3144	197004
BG3147	186567
BG3158	186628
BG3160	186827
BG3168	186652
BG3172	186514
BG3173	186874
BG3177	197167
BG3187	186560
	186822
BG3189	186876
BG3194	186774
BG3198	186582
BG3199	186583
	186745
BG3202	186648
	186748
	197087
BG3203	186647
	186748
	197090
BG3206	186576
BG3208	186603
	186688



DELPHI (.../...)	
BG3220	197157
BG3222	186589
BG3226	197207
BG3227	186642
BG3235	197033
BG3236	186774
BG3237	187045
BG3239	186469
BG3240	186467
BG3241	186552
BG3245	186607
BG3246	186821
BG3259	186596
BG3262	186620
BG3266	186570
BG3274	186566
BG3296	186551
BG3326	186470
BG3334	186743
BG3337	186777
BG3347	186705
BG3351	186644
BG3353	186587
	186685
BG3359	186560
BG3360	186775
BG3364	186598
BG3365	186278
BG3366	186537
BG3367	186569
BG3378	197223
BG3381	186773
	186807
BG3382	186294
BG3383	186570
	186730
BG3388	186778
BG3391	186585
	197223
BG3393	197063
BG3394	186562
BG3395	186573
BG3398	186753
BG3399	197059
BG3401	186648
BG3402	186591
BG3403	186594
BG3404	186592
BG3405	186684
	197239
BG3406	186593
BG3415	186314
	186725
BG3417	186314
	186682
BG3418	197056
BG3420	186605



DELPHI (.../...)	
BG3421	186599
BG3422	186600
BG3423	186640
BG3424	186875
BG3425	186571
BG3426	186687
BG3430	186655
BG3497	197229
BG3499	197163
BG3501	186707
	186880
BG3503	186814
BG3504	186710
BG3505	186729
	186834
	197124
BG3508	197161
BG3509	186810
BG3513	186789
BG3515	186748
	186841
	187058
BG3516	186780
BG3517	197239
BG3518	186801
BG3519	186587
	186847
BG3520	186766
BG3522	197122
BG3526	186859
BG3527	186815
BG3528	186881
	197246
BG3529	197231
BG3530	186861
BG3535	186686
	186704
BG3536	186686
	186765
BG3537	186750
BG3539	186638
BG3540	186645
BG3548	186299
BG3550	197016
BG3551	186742
BG3553	186688
BG3556	197020
BG3561	197108
BG3563	197206
BG3567	186757
BG3568	186790
BG3569	186759
	186869
BG3574	186590
BG3576	186778
BG3583	186685
BG3596	186821



DELPHI (.../...)	
BG3611	197088
	197198
BG3620	186695
	197220
BG3621	186736
BG3622	186693
BG3628	186808
BG3629	186809
BG3653	186694
BG3654	186693
BG3657	186758
BG3658	186788
BG3659	197238
BG3661	186762
BG3662	186812
BG3663	186834
BG3671	197032
BG3672	197124
BG3673	186807
BG3674	186856
BG3675	197220
BG3676	186709
BG3677	197015
BG3679	197172
BG3680	197027
BG3681	186425
	186740
BG3682	186702
BG3683	186703
BG3684	186785
BG3685	197240
BG3686	186894
BG3688	186839
	197221
BG3689	186718
BG3691	197112
BG3694	197086
BG3695	186603
	186888
BG3696	186800
	197239
BG3699	186745
BG3702	186871
BG3704	186734
BG3706	186695
BG3709	197060
BG3710	186760
BG3713	186881
BG3714	197198
BG3715	197069
BG3716	197233
BG3719	186800
BG3721	197172
BG3723	197137
BG3730	186728
BG3731	186854
BG3733	186715



	
DELPHI (.../...)	
BG3735	197168
BG3737	197062
BG3738	197011
BG3739	197022
BG3740	197219
BG3741	186724
BG3746	197104
BG3747	197144
BG3749	197173
BG3750	186823
BG3755	186751
BG3757	197035
BG3758	186865
BG3762	186764
BG3764	186845
BG3766	186728
BG3767	186713
BG3768	186712
BG3769	186784
BG3770	186648
	197244
BG3771	186791
BG3772	186587
	186880
BG3775	197090
BG3776	186720
BG3777	186850
BG3778	186876
BG3779	197018
BG3781	186877
BG3784	197057
BG3793	197014
	197103
BG3794	197146
BG3799	197121
BG3805	186781
BG3814	197067
BG3816	186728
BG3821	197162
BG3824	186766
BG3826	186748
BG3829	186783
BG3830	186731
BG3831	186883
BG3832	186754
BG3833	186755
BG3834	186857
BG3835	186746
BG3836	186747
BG3838	186890
BG3839	186744
BG3840	186798
BG3841	186418
BG3842	186420
	197228
BG3845	186799
BG3846	197252

	
DELPHI (.../...)	
BG3856	186765
BG3857	186797
BG3858	197210
BG3859	197209
BG3860	186824
BG3863	186825
BG3867	186847
BG3868	186819
BG3869	186582
BG3870	186732
BG3872	197084
BG3873	186844
	197013
BG3874	197245
BG3875	186851
BG3884	186805
BG3885	186855
BG3886	186882
BG3887	186764
BG3888	186796
BG3889	186848
BG3890	186833
BG3893	186886
BG3894	197243
BG3895	186863
BG3896	186842
BG3897	186843
BG3899	186816
BG3900	186817
BG3901	197049
BG3908	197009
BG3909	197091
BG3910	197036
BG3912	186849
BG3913	197072
BG3921	186876
BG3923	186708
BG3927	186872
BG3929	197241
BG3933	186869
BG3934	186878
BG3935	197096
BG3938	197083
BG3939	197199
BG3940	186295
BG3941	197064
BG3942	197052
BG3943	197251
BG3944	197045
BG3945	197008
BG3951	197247
BG3953	197242
BG3954	197031
BG3956	197125
BG3959	197073
BG3961	197175
BG3962	186840

	
DELPHI (.../...)	
BG3969	186858
BG3970	186620
BG3971	197129
BG3974	197019
BG3975	197139
BG3976	197047
BG3977	197153
BG3978	197145
BG3985	197200
BG3989	186869
BG3990	186718
BG3991	197140
BG3992	186786
BG3994	197098
BG3998	197234
BG4004	197044
BG4049	197066
BG4052	197071
BG4059	197248
BG429	187029
BG495	186547
BG649	186614
BG805	186452
BG873	186579
BG9031RS	186713
BG9053RS	197117
BG9514	186741
	186823
	186854
	197173
BG9687	186804
BG9692	186868
BG9722	187058
BG9759	186811
BG9773	197087
BG9843	197136
BG9844	197046
BG9871	197193
BG9891	186756
BG9892	186885
BG9952	197197
BG9955	197142
BG9968	197092
FERODO	
DDF001	186189
DDF011	186128
DDF012	186202
DDF013	186495
DDF016	186226
DDF035	186171
DDF038	186625
DDF041	186142
DDF042	186249
DDF048	186113
DDF051	186134
DDF052	186135

	
FERODO (.../...)	
DDF053	186176
DDF055	186230
	186803
DDF057	186771
DDF059	186200
DDF061	186207
DDF062	186118
DDF063	186206
DDF066	186146
DDF067	186290
DDF068	186150
DDF069	186136
DDF070	186228
DDF071	186180
DDF075	186115
DDF079	186160
DDF080	186256
DDF081	186501
DDF082	186118
DDF083	186151
DDF084	186169
DDF088	186110
DDF089	186170
DDF092	186172
DDF093	186117
DDF094	186140
DDF096	186197
DDF097	186197
DDF100	186143
DDF1000	186599
DDF1003	186582
DDF1006	186304
DDF1008	186704
DDF1009	186686
DDF1010	186682
DDF1011	186725
DDF1014	186583
DDF103	186245
	197056
DDF1030	197004
DDF1031	197056
DDF1033	186294
DDF1034	186562
DDF1035	186573
DDF1037	186753
DDF104	186186
	197150
DDF1040	186591
DDF1041	186592
DDF1042	186684
DDF1043	186594
DDF1044	186593
DDF1057	186605
DDF1058	186846
DDF1062	197229
DDF1064	186705
DDF1065	197231



FERODO (.../...)	
DDF1066	186815
DDF1067	186688
DDF107	186211
DDF1072	186560
DDF1073	186861
DDF1076	186742
DDF1077	186777
DDF1078	186741
DDF1079	186741
DDF1080	186814
DDF1081	197016
DDF1082	197226
DDF1083	186566
DDF1084	186587
DDF1085	186811
DDF109	186152
DDF1094	186875
DDF1096	186208
DDF1097	186743
DDF1100	186687
DDF1104	197161
DDF1105	186810
DDF1106	197220
DDF1109	186719
DDF1112	186710
DDF1113	186709
DDF1114	186703
DDF1115	186785
DDF1116	197009
DDF1117	197163
DDF1118	197246
DDF1119	186780
DDF1122	186745
DDF1123	186600
DDF1124	186655
DDF1125	186750
DDF1126	186834
DDF1127	186762
DDF1128	186812
DDF1129	186757
DDF1130	186790
DDF1131	186759
DDF1132	186702
	186746
DDF1135	186864
DDF1138	186797
DDF1139	197240
DDF1140	186695
DDF1145	186708
DDF1148	186784
DDF1149	186766
DDF115	186257
DDF1151	186871
DDF1152	186693
DDF1154	197088
DDF1155	197011
DDF1156	186758



FERODO (.../...)	
DDF1157	186736
DDF1158	186801
DDF1159	197239
DDF116	186187
	186757
DDF1160	186800
DDF1161	186788
DDF1162	197137
DDF1163	186789
DDF1164	186888
DDF1165	197219
DDF1166	197198
DDF1167	186305
DDF1168	197138
DDF1169	197238
DDF117	186202
	186205
DDF1170	186418
DDF1171	197228
DDF1172	186748
DDF1173	186783
DDF1174	186731
DDF1176	197120
DDF1177	197032
DDF1178	186694
DDF1179	186744
DDF1181	186724
DDF1182	186715
DDF1183	197136
DDF1184	197252
DDF1190	197124
DDF1201	186764
DDF1202	186884
DDF1203	186890
DDF1204	186712
DDF1205	197221
DDF1210	197245
DDF1214	197069
DDF1215	186880
DDF1216	186765
DDF1217	186868
DDF1218	186755
DDF1219	186798
DDF122	186184
DDF1220	186799
DDF1221	197230
DDF1222	186819
DDF1223	186754
DDF1224	186857
DDF1225	186863
DDF1226	186842
DDF1227	186843
DDF1228	186816
DDF1229	186817
DDF123	186236
DDF1231	186866
	197146



FERODO (.../...)	
DDF1232	186807
DDF1233	186729
DDF1234	186858
DDF1236	186869
DDF1238	197142
DDF1239	197172
DDF124	186182
DDF1240	197140
DDF1241	186732
DDF1242	197193
DDF125	186157
DDF1252	186751
DDF1253	186756
DDF1254	186885
DDF1255	186809
DDF1256	186808
DDF1258	197036
DDF1260	197084
DDF1261	197244
DDF1266	197144
DDF1268	197096
DDF1270	186825
DDF1271	197083
DDF1272	186740
DDF1274	197046
DDF1275	186747
DDF1276	186833
DDF1277	197199
DDF128	186114
DDF1280	186883
DDF1282	197162
DDF1283	186791
DDF1284	186295
DDF1286	186886
DDF1287	197064
DDF1288	186854
DDF1289	186882
DDF129	186147
DDF1290	197210
DDF1291	197052
DDF1292	186824
DDF1295	186786
DDF1296	197239
DDF1297	197251
DDF1298	197045
DDF1299	197008
DDF1302	197108
DDF1304	197044
DDF1305	197242
DDF1306	197031
DDF1307	197035
DDF1308	197035
	197125
DDF1309	186877
DDF131	186192
DDF1311	186872
DDF1313	186855



FERODO (.../...)	
DDF1316	197091
DDF132	186130
DDF1346	197195
DDF135	186158
DDF1358	186432
DDF136	186254
DDF1361	186839
DDF1362	186760
DDF1363	197060
DDF1364	186718
DDF1365	197086
DDF1368	197079
DDF1369	186796
DDF137	186288
DDF1372	197233
DDF1374	186869
DDF1379	197062
DDF138	186168
DDF1380	197018
DDF1381	186720
DDF1384	186813
DDF1386	186893
	186894
DDF1399	197067
DDF140	186155
	186406
DDF1400	197122
DDF1401	197070
DDF1405	186804
DDF1406	186849
DDF141	186154
DDF1417	186847
DDF1419	186848
DDF1420	197021
DDF1421	197019
DDF1423	197038
DDF1424	197145
DDF1425	186856
DDF1426	197057
DDF1430	197155
DDF1431	197156
DDF1442	197232
DDF1443	186853
DDF1446	197168
DDF1447	197121
DDF1449	197247
DDF1450	197098
DDF1451	197247
DDF1452	197098
DDF1453	197130
DDF1454	197132
DDF1455	197130
DDF1456	197134
DDF1459	197233
DDF1461	197171
DDF1466	197103
DDF148	186156



 	
FERODO (.../...)	
DDF1484	197170
DDF1486	197112
DDF1488	197015
DDF1489	186850
DDF149	186137
DDF1492	197022
DDF1493	197027
DDF1497	186844
	197013
DDF1498	186713
DDF1500	186851
DDF1502	186802
DDF1503	197139
DDF1508	197072
DDF1509	186805
DDF151	186188
	186790
DDF1511	186717
DDF1513	197241
DDF1514	186775
DDF1515	186775
DDF1516	186768
DDF1517	186768
DDF1518	197017
DDF1520	197066
DDF1521	186727
DDF1522	186829
DDF1523	186840
DDF1526	186582
DDF1527	197047
DDF1529	186879
DDF1533	197092
DDF1535	197073
DDF1536	197234
DDF1537	187152
DDF154	186195
DDF1543	197209
DDF1549	197049
DDF1550	197175
DDF1554	197249
DDF1555	197054
DDF1557	197153
DDF1559	197239
DDF156	186265
DDF1560	197002
DDF1561	186840
DDF1564	197002
DDF1565	186743
DDF1566	197248
DDF1567	197055
DDF1569	186718
DDF157	186102
DDF1570	186853
DDF1571	186796
DDF1574	197097
DDF1577	186823
DDF1578	197107

 	
FERODO (.../...)	
DDF158	186229
DDF1580	197090
DDF1582	197200
DDF1587	197184
DDF1588	197111
DDF1589	197164
DDF159	186214
DDF1591	197087
DDF1594	197071
DDF160	186218
DDF1601	197188
DDF1602	197099
DDF1604	197050
DDF1608	197102
DDF1615	197133
DDF1616	197101
DDF1617	197074
DDF1619	197205
DDF1620	197135
DDF1621	197214
DDF1622	197129
DDF1623	186712
	186713
DDF1625	197190
DDF1629	197211
DDF1632	197173
DDF1634	197176
DDF1636	186878
DDF1641	186720
DDF1644	197149
DDF1645	197109
DDF1646	197152
DDF1649	197143
DDF165	186116
DDF1653	197023
DDF1654	186893
DDF1655	186894
	197003
DDF1656	186720
DDF1664	197196
DDF1668	197185
DDF1677	197222
DDF168	186103
DDF1687	197065
DDF1688	197203
DDF169	186139
DDF1690	197202
DDF1693	197201
DDF172	186210
DDF174	186255
DDF175	186246
DDF176	186149
DDF177	186776
DDF178	186148
DDF180	186165
DDF181	186185
DDF182	186119

 	
FERODO (.../...)	
DDF183	186159
DDF184	186213
DDF186	186221
DDF188	186191
DDF189	186613
DDF191	186177
DDF192	186198
DDF193	186112
DDF194	186264
DDF196	186263
DDF198	186220
DDF199	186219
DDF201	186235
DDF202	186299
DDF203	186232
DDF205	186251
DDF206	186189
DDF207	186247
DDF208	186162
DDF209	186166
DDF210	186124
DDF213	186258
DDF214	186194
DDF216	186292
DDF217	186625
DDF218	186479
DDF220	186266
DDF221	186125
DDF224	186183
DDF225	186178
DDF227	186482
DDF228	186145
DDF229	186131
DDF232	186424
DDF233	186374
DDF236	186287
DDF237	186224
DDF238	186199
DDF239	186190
DDF240	186406
DDF242	186302
DDF244	186416
DDF245	186204
DDF246	186283
DDF247	186144
DDF248	186274
DDF249	186295
DDF250	186692
DDF252	186297
DDF254	186614
DDF256	186273
DDF258	186275
DDF259	186301
DDF260	186485
DDF261	186286
DDF262	186284
DDF263	186196

 	
FERODO (.../...)	
DDF264	186303
DDF265	186114
DDF266	186517
DDF267	186487
DDF268	186461
DDF281	186425
DDF286	186495
DDF309	197004
DDF310	197028
DDF311	186272
DDF316	186276
DDF318	186268
DDF319	186267
DDF320	197222
DDF321	186294
DDF324	186270
DDF328	186282
DDF330	197225
DDF331	186490
DDF332	186313
DDF333	186768
DDF334	186775
DDF339	186519
DDF347	186637
DDF349	186267
	197165
DDF351	186504
DDF353	186223
DDF355	186498
DDF357	186665
DDF359	186530
DDF361	186567
DDF362	186306
DDF364	186277
DDF366	186570
DDF370	186159
DDF373	197114
DDF377	186431
DDF385	186488
DDF389	186441
DDF390	186440
DDF394	186446
DDF395	186455
DDF398	186500
DDF403	186509
DDF411	186508
DDF412	186510
DDF413	186511
DDF416	186696
DDF423	186427
DDF424	186770
DDF426	186314
DDF427	186315
DDF429	186454
DDF432	186311
DDF435	186428
DDF439	186231



FERODO (.../...)	
DDF442	186300
DDF445	186768
DDF446	186140
DDF447	186433
DDF448	186234
DDF450	186436
DDF453	186235
DDF455	186446
DDF457	186460
DDF459	186664
DDF460	186653
DDF466	186508
DDF468	186435
DDF478	186225
DDF479	186426
DDF480	186611
DDF482	186617
DDF489	186296
DDF490	186586
DDF491	186496
DDF492	186438
DDF494	186439
DDF496	186457
DDF497	186449
DDF500	186652
DDF501	197166
DDF502	186652
DDF511	186699
DDF517	186291
DDF518	186269
DDF521	186153
DDF523	186452
DDF524	186458
DDF539	186281
DDF540	186298
DDF542	186770
DDF543	186807
DDF547	186520
DDF548	186462
DDF552	186528
DDF554	186621
DDF556	186307
DDF558	186596
DDF562	197218
DDF563	186114
DDF564	186453
DDF588	186280
DDF596	186547
DDF605	186526
DDF614	186640
DDF619	186439
DDF620	197169
DDF621	197148
DDF623	186505
DDF624	197227
DDF630	186465
DDF658	186648



FERODO (.../...)	
DDF674	186564
DDF678	186503
DDF691	186476
DDF692	186476
DDF693	186585
DDF694	197223
DDF701	186645
DDF702	197167
DDF706	186521
DDF715	186691
DDF717	186564
DDF722	186563
DDF741	186648
DDF746	186628
DDF752	186775
DDF756	186497
DDF757	186421
DDF758	197217
DDF759	186408
DDF760	186420
DDF762	186590
DDF766	186163
DDF767	186418
DDF768	197228
DDF769	186638
DDF770	186299
DDF780	186514
DDF785	186435
DDF790	186654
DDF794	186701
DDF795	186581
DDF797	186643
DDF799	186822
DDF801	186401
DDF802	186443
DDF803	186442
DDF810	197226
DDF811	186566
DDF812	186523
DDF813	186714
DDF814	186565
DDF817	186467
DDF819	186470
DDF826	186572
DDF827	186644
DDF829	186778
DDF830	186773
DDF831	186559
DDF834	186697
DDF835	186568
DDF836	186860
DDF840	186569
DDF841	186533
DDF842	186589
DDF845	186529
DDF846	197236
DDF847	186624



FERODO (.../...)	
DDF848	186278
DDF849	186537
DDF860	186551
DDF861	186552
DDF866	186576
DDF867	186577
DDF869	186579
DDF870	186532
DDF871	186286
DDF873	197224
DDF874	186642
DDF881	186511
DDF885	186648
DDF887	186163
DDF888	186571
DDF927	186603
DDF928	186604
DDF929	186597
DDF948	186874
DDF950	186432
DDF952	186773
DDF963	186469
DDF965	186839
DDF978	186827
DDF995	186598
DRF042	186249
DRF055	186230
	186803
DRF059	186200
DRF066	186146
DRF067	186290
DRF070	186228
DRF083	186151
DRF1003	186582
DRF1006	186304
DRF1014	186583
DRF103	186245
	197056
DRF1033	186294
DRF1035	186573
DRF104	186186
	197150
DRF1066	186815
DRF1072	186560
DRF1073	186861
DRF1078	186741
DRF1082	197226
DRF109	186152
DRF1096	186208
DRF1118	197246
DRF1122	186745
DRF1123	186600
DRF1124	186655
DRF1127	186762
DRF1128	186812
DRF1132	186702
	186746



FERODO (.../...)	
DRF1138	186797
DRF1140	186695
DRF1149	186766
DRF1154	197088
DRF1155	197011
DRF1156	186758
DRF116	186187
	186757
DRF1163	186789
DRF1167	186305
DRF1173	186783
DRF1174	186731
DRF1177	197032
DRF123	186236
DRF125	186157
DRF128	186114
DRF132	186130
DRF135	186158
DRF137	186288
DRF140	186155
	186406
DRF141	186154
DRF148	186156
DRF151	186188
	186790
DRF154	186195
DRF156	186265
DRF158	186229
DRF175	186246
DRF176	186149
DRF183	186159
DRF189	186613
DRF192	186198
DRF193	186112
DRF201	186235
DRF205	186251
DRF206	186189
DRF207	186247
DRF208	186162
DRF209	186166
DRF210	186124
DRF214	186194
DRF216	186292
DRF220	186266
DRF221	186125
DRF240	186406
DRF242	186302
DRF244	186416
DRF248	186274
DRF249	186295
DRF252	186297
DRF256	186273
DRF258	186275
DRF260	186485
DRF261	186286
DRF263	186196
DRF266	186517







	
FERODO (.../...)	
DRF281	186425
DRF286	186495
DRF316	186276
DRF319	186267
DRF321	186294
DRF324	186270
DRF328	186282
DRF331	186490
DRF332	186313
DRF334	186775
DRF339	186519
DRF364	186277
DRF390	186440
DRF423	186427
DRF439	186231
DRF447	186433
DRF450	186436
DRF479	186426
DRF482	186617
DRF489	186296
DRF491	186496
DRF492	186438
DRF494	186439
DRF497	186449
DRF500	186652
DRF501	197166
DRF511	186699
DRF517	186291
DRF518	186269
DRF521	186153
DRF588	186280
DRF605	186526
DRF619	186439
DRF620	197169
DRF624	197227
DRF678	186503
DRF706	186521
DRF727S	186185
DRF752	186775
DRF756	186497
DRF759	186408
DRF762	186590
DRF766	186163
DRF794	186701
DRF795	186581
DRF797	186643
DRF798	186208
DRF799	186822
DRF801	186401
DRF810	197226
DRF812	186523
DRF817	186467
DRF829	186778
DRF830	186773
DRF831	186559
DRF834	186697
DRF841	186533



	
FERODO (.../...)	
DRF845	186529
DRF870	186532
DRF927	186603
DRF928	186604
DRF929	186597
DRF952	186773
DRF995	186598
FCR104A	187029
FCR139A	187058
FCR140A	187040
FCR153A	186774
FCR154A	187045
FCR184A	187061
FCR191A	197059
FCR194A	187147
FCR195A	187148
FCR196A	187149
FCR221A	186178
FCR227A	197033
FCR228A	186774
FCR229A	187045
FCR230A	197033
FCR236A	187130
FCR310A	187141
FCR311A	197030
FCR312A	187146
QUINTON HAZELL	
6013.00	186299
6014.00	197114
6019.00	186160
6020.00	186144
6021.00	186135
6022.00	186140
6023.00	186586
6024.00	186288
6025.00	186517
6030.00	186151
6032.00	186311
6033.00	186226
6040.00	186232
6047.00	186300
6054.00	186453
6057.00	186186
6058.00	186118
6059.00	186187
	186188
6060.00	186530
6061.10	186188
6062.10	186119
6065.00	186240
6066.00	186228
6067.00	186230
6070.00	186130
6072.00	186231
6073.00	186768
6074.00	186768
	186775



	
QUINTON HAZELL (.../...)	
6075.00	186768
6077.00	186211
6080.10	186229
6081.10	186213
6083.00	186435
6084.10	186246
6086.00	186249
6088.01	186245
6089.00	186173
6091.00	186257
6093.10	186102
6094.00	186162
6095.00	186158
6096.10	186163
6097.10	186159
6102.00	186242
6104.00	186236
6105.10	186482
6107.10	186156
6108.10	186433
6109.10	186613
6110.00	186155
6110.01	186406
6111.00	186157
6112.00	186142
6113.10	186301
6117.10	186221
6118.00	186128
6119.00	186143
6120.00	186292
6122.00	186114
6123.00	186294
6128.00	186196
	186416
6129.00	186276
6130.00	186200
6131.10	186194
6133.10	186195
6136.00	186199
6141.00	186621
6142.00	186110
6144.10	186208
6145.10	186611
6147.00	186424
6148.00	186452
6149.00	186146
	186290
6150.00	186146
6152.00	186501
6153.10	186287
6155.00	186425
6156.00	186171
6157.10	186218
6159.00	186223
6160.10	186426
6161.00	186225
6163.00	186168

	
QUINTON HAZELL (.../...)	
6165.00	186567
6166.00	186596
6167.00	186115
6168.00	186205
6169.00	186206
6170.10	186509
	186637
6171.10	186116
6172.00	186251
6173.00	186268
6174.10	186282
6175.10	186247
6176.10	186273
6177.10	186267
6178.10	186189
6179.10	186485
6180.00	186152
6181.00	186113
6182.00	186147
6183.10	186149
6184.10	186451
6185.10	186112
6186.10	186148
6188.10	186488
6189.10	186153
6190.00	186131
6191.00	186154
6192.00	186150
6193.00	186281
6194.00	186184
6195.00	186498
6197.00	186117
6200.00	186487
6201.00	186192
6202.10	186191
6203.10	186457
6204.10	186214
6205.10	186436
	186439
6206.00	186458
6207.00	186490
6208.00	186235
6209.00	186258
6210.10	186139
6211.10	186277
6213.10	186427
6214.10	186165
6215.10	186166
6217.00	186302
6221.00	186176
6224.10	186438
6225.10	186234
6226.10	186286
6227.10	186304
	186655
6227.11	186305
6228.10	186177



 	
QUINTON HAZELL (.../...)	
6229.10	186776
6231.10	186263
6232.00	186197
6234.11	186607
6235.10	186612
6236.10	186219
6237.10	186455
6239.00	186306
6239.02	186307
6240.10	186198
6241.01	186134
6242.00	186170
6243.00	186614
6247.10	186103
6249.00	186190
6250.00	186428
6253.00	186169
6257.00	186172
6261.00	186202
6264.10	186203
6265.10	186145
6268.10	186272
6270.00	186183
6271.00	186462
6272.00	186180
6277.10	186210
6282.00	186207
6283.00	186256
6284.00	186295
6287.00	186269
6290.00	187029
6293.10	186313
6294.10	186519
6295.10	186291
6297.10	186224
6300.10	186625
6301.10	186600
6302.10	186500
6304.10	186289
6305.11	186420
6306.10	186296
6307.10	186303
6310.00	186298
6311.00	186182
6313.10	186280
6314.10	186185
6315.10	186297
6315.11	186643
6316.10	186265
6316.11	186266
6319.10	186496
6320.10	186137
6321.11	186220
6322.10	186235
6323.00	186274
6324.10	186275
6325.10	186264



 	
QUINTON HAZELL (.../...)	
6327.00	186270
6328.10	197222
6329.00	186374
6330.00	186204
6331.00	186504
6333.00	186310
6334.00	186136
6337.10	186479
6338.10	186460
6339.10	197225
6342.00	186125
6343.10	186465
6344.10	186461
6347.00	186124
6350.00	186692
6367.10	186234
6369.10	186431
6370.00	186285
6374.10	186441
6375.10	186617
6376.10	186440
6385.10	186446
6386.10	186449
6394.10	186648
6394.11	186648
6398.00	186503
6399.10	186505
6401.00	186510
	186511
6402.10	186511
6405.10	186696
6408.10	186637
6409.10	186255
6410.10	186526
6411.00	186528
6413.10	186665
6414.00	186314
6415.00	186770
6416.10	186315
6418.00	186581
6419.10	186570
6420.00	187040
6423.10	186576
6424.00	186654
6425.00	186681
6426.10	186523
6427.00	186529
6429.00	186807
6430.10	186577
6431.00	186773
6433.00	186569
6437.10	197165
6439.10	186652
6440.10	186509
6442.10	186644
6442.11	186589
6443.10	186590



 	
QUINTON HAZELL (.../...)	
6444.10	186563
6445.10	186508
6446.10	186664
6447.00	186647
6449.10	186532
6451.00	186620
6453.00	186624
6454.00	186565
6458.10	186559
6460.10	186551
6461.10	186774
6462.10	186719
6464.10	186653
6465.10	186652
6467.00	186470
6468.00	186771
6469.10	186401
6471.00	186552
6472.00	186408
6473.00	197217
6476.10	186418
6478.10	186442
6479.10	186443
6481.00	197218
6484.10	186235
6485.10	186439
6486.10	186533
6487.00	186566
6491.10	186645
6492.10	186628
6493.10	186521
6494.10	197226
6495.10	186467
6496.10	197236
6497.10	186547
6498.00	186579
6500.00	187058
6501.10	186640
6502.00	186421
6504.10	197228
6507.10	186638
6509.10	197227
6514.10	186697
6515.10	186685
6517.10	186571
6518.10	186278
6519.10	186537
6520.10	186572
6521.00	186432
	186435
6522.00	186454
6526.00	186753
6531.00	186564
6532.00	186497
6535.00	186598
6536.00	186599
6537.00	186775



 	
QUINTON HAZELL (.../...)	
6538.00	186714
6539.10	186701
6540.10	197169
6541.10	186822
6542.10	197148
6544.10	197230
6545.10	186603
6546.10	186604
6547.00	186597
6548.10	186582
6549.10	186583
6550.00	186725
6551.10	186682
6554.00	186568
6555.00	186469
6557.10	186818
6560.10	186585
6569.10	186875
6571.10	197167
6575.10	186560
6586.10	186778
6588.10	186860
6596.10	186758
6597.10	197246
6598.10	186731
6599.10	186884
6600.10	186808
6602.10	197233
6603.10	186695
6604.10	186693
6605.00	186724
	186736
6606.00	186742
6607.10	186750
6608.10	186710
6609.10	186709
6610.10	186821
6611.10	186759
6612.10	197221
6613.00	186718
6614.10	186814
6615.00	197016
6616.00	186729
6617.00	186859
6618.10	186587
6619.10	186789
6620.00	186841
6621.00	186784
6622.10	186600
6623.10	197059
6624.10	186762
6625.10	186648
6626.10	197238
6627.00	197120
6629.00	186812
6630.00	186694
6632.00	186809



 	
QUINTON HAZELL (.../...)	
6633.10	186823
6635.10	186766
6637.10	186734
6638.10	197062
6639.10	186813
6640.10	186765
6641.10	186780
6642.10	197064
6643.10	186868
6644.10	186811
6645.10	186883
6646.10	197088
6647.10	186754
6648.10	186755
6649.00	186857
6650.00	186833
6651.10	186816
6652.10	186817
6653.10	186732
6654.10	197084
6657.10	197232
6658.10	197219
6659.00	186801
6660.10	197239
6661.00	186834
6662.10	186748
6666.10	186878
6667.10	197172
6668.10	186829
6670.10	186871
6671.10	186872
6674.00	186798
6675.10	186799
6676.10	186751
6678.00	186858
6679.10	186890
6681.10	186728
6682.10	186712
6683.10	186764
6684.10	186869
6685.10	186869
6686.10	186882
6687.10	186880
6688.00	186854
6689.10	186881
6690.00	186747
6691.10	197046
6692.00	186785
6693.10	186746
6694.10	186717
6695.10	186804
6696.10	197240
6697.10	186715
6698.00	186720
6699.10	197162
6700.00	186849
6701.10	197072

 	
QUINTON HAZELL (.../...)	
6703.10	197171
6705.00	197019
6706.10	197071
6707.10	186886
6708.10	186756
6709.10	186888
6710.10	186819
6711.10	186863
6712.00	186843
BDC1010	186249
BDC1026	186226
BDC1046	186245
BDC1060	186180
BDC1064	186202
BDC3116	186242
BDC3118	186115
BDC3120	186160
BDC3121	186256
BDC3122	186254
BDC3126	186116
BDC3133	186171
BDC3141	186240
BDC3142	186128
BDC3150	186151
BDC3167	186142
BDC3180	186139
BDC3185	186189
BDC3191	186501
BDC3193	186152
BDC3194	186170
BDC3195	186205
BDC3199	186137
BDC3205	186188
	186790
BDC3209	186110
BDC3211	186113
BDC3216	186135
BDC3235	186158
BDC3236	186159
BDC3237	186169
BDC3240	186186
	197150
BDC3243	186218
BDC3245	186211
BDC3247	186134
BDC3249	186230
	186803
BDC3249BD	186230
	186803
BDC3274	186140
BDC3276	186143
BDC3283	186207
BDC3284	186203
BDC3285	186197
BDC3288	186117
BDC3309	186246
BDC3310	186771

 	
QUINTON HAZELL (.../...)	
BDC3310C	186771
BDC3317	186112
BDC3330	186257
BDC3358	186479
BDC3387	186172
BDC3388	186187
	186757
BDC3422	186462
BDC3434	186206
BDC3435	186156
BDC3436	186157
BDC3440	186150
BDC3441	186149
BDC3442	186146
BDC3444	186176
BDC3445	186185
BDC3446	186182
BDC3447	186184
BDC3449	186228
BDC3450	186210
BDC3451	186224
BDC3452	186214
BDC3457	186255
BDC3458	186776
BDC3458C	186776
BDC3460	186374
BDC3464	186118
BDC3468	186195
BDC3470	186236
BDC3471	186613
BDC3473	186283
BDC3477	186200
BDC3480	186119
BDC3481	186232
BDC3501	186102
BDC3502	186103
BDC3503	186265
BDC3504	186146
	186290
BDC3505	186130
BDC3508	186198
BDC3511	186154
BDC3511BD	186154
BDC3512	186136
BDC3513	187029
BDC3517	186165
BDC3518	186424
BDC3519	186168
BDC3542	186192
BDC3543	186191
BDC3544	186190
BDC3546	186229
BDC3550	186213
BDC3552	186219
BDC3553	186221
BDC3554	186498
BDC3555	197114

 	
QUINTON HAZELL (.../...)	
BDC3563	186637
BDC3565	186258
BDC3570	186264
BDC3573	186234
BDC3575	186235
BDC3577	186495
BDC3580	186299
BDC3583	186425
BDC3589	186114
BDC3591	186431
BDC3592	186155
	186406
BDC3593	186153
BDC3597	186177
BDC3598	197165
BDC3602	186220
BDC3603	186696
BDC3605	186247
BDC3605BD	186247
BDC3606	186263
BDC3608	186166
BDC3611	186162
BDC3626	186234
BDC3627	186183
	186470
BDC3629	186292
BDC3630	186273
BDC3635	186272
BDC3639	186124
BDC3640	186125
BDC3648	186131
BDC3649	186435
BDC3653	186173
BDC3657	186455
BDC3667	186692
BDC3675	186482
BDC3680	186189
BDC3681	186302
BDC3682	186625
BDC3684	197028
BDC3688	186194
BDC3689	186196
BDC3690	186199
BDC3691	186231
BDC3692	186225
BDC3693	186223
BDC3696	186500
BDC3698	186511
BDC3704	186508
BDC3712	186288
BDC3712BD	186288
BDC3712C	186288
BDC3712K	186288
BDC3713	186251
BDC3715	186770
BDC3716	186263
BDC3724	186145



QUINTON HAZELL (.../...)	
BDC3725	186144
BDC3727	186163
BDC3731	186148
BDC3733	186446
BDC3736	186446
BDC3737	186530
BDC3740	197114
BDC3744	186441
BDC3747	186665
BDC3755	186596
BDC3762	186510
	186511
BDC3764	186770
BDC3764K	186770
BDC3766	186266
BDC3767	186267
BDC3769	186310
BDC3771	186147
BDC3773	186440
BDC3774	186611
BDC3775	186485
BDC3777	186204
BDC3779	186504
BDC3783	186519
BDC3786	186416
BDC3787	186315
BDC3788	186314
BDC3789	186303
BDC3790	186564
BDC3791	186301
BDC3792	186487
BDC3796	186613
BDC3797	186283
	186284
BDC3800	186286
BDC3801	186285
BDC3803	186274
BDC3803BD	186274
BDC3804	186275
BDC3805	186295
BDC3807	186428
BDC3816	186505
BDC3818	186509
BDC3819	186547
BDC3820	186300
BDC3821	186159
BDC3824	186270
BDC3825	197222
BDC3826	186282
BDC3827	186490
BDC3828	186488
BDC3833	186482
BDC3837	186289
BDC3838	186298
BDC3839	186280
BDC3840	186281
BDC3854	186266
	186297



QUINTON HAZELL (.../...)	
BDC3899	186208
BDC3907	186268
BDC3909	186277
BDC3910	186426
BDC3911	186313
BDC3912	186526
BDC3913	186528
BDC3916	186653
BDC3919	186586
BDC3920	186296
BDC3927	186640
BDC3929	186294
BDC3933	186291
BDC3934	186269
BDC3935	186807
BDC3937	186517
BDC3937K	186517
BDC3944	186276
BDC3951	186457
BDC3955	186617
BDC3958	186685
BDC3959	186458
BDC3960	186449
BDC4183	186441
BDC4242	186178
BDC4254	186768
BDC4267	186520
BDC4282	186487
BDC4294	186451
BDC4300	186452
BDC4306	186406
BDC4308	186266
BDC4312	186208
BDC4313	186235
BDC4321	186460
BDC4330	186648
BDC4334	186198
BDC4336	186306
BDC4337	186307
BDC4338	186304
BDC4338BD	186304
BDC4339	186600
BDC4349	186428
BDC4350	186305
BDC4351	186427
BDC4353	186278
BDC4354	186664
BDC4355	186405
BDC4356	186406
BDC4357	186436
	186438
	186439
BDC4358	186439
BDC4360	186420
BDC4361	186418
	197043
BDC4362	197131
	197228



QUINTON HAZELL (.../...)	
BDC4363	197217
BDC4365	186159
BDC4366	186427
BDC4369	186435
BDC4370	186436
BDC4371	186433
BDC4372	186438
BDC4373	186699
BDC4375	186439
BDC4377	197208
BDC4379	186461
BDC4380	186465
BDC4389	186453
BDC4396	186563
BDC4397	186496
BDC4398	197217
BDC4399	186418
BDC4400	197228
BDC4401	186567
BDC4402	186768
	186775
BDC4403	186304
BDC4404	186305
BDC4405	186307
BDC4406	186600
BDC4409	186287
BDC4410	186714
BDC4414	186570
	186730
BDC4415	186875
BDC4416	197167
BDC4418	186509
BDC4422	197166
BDC4423	186652
BDC4426	186607
BDC4439	197225
BDC4441	186775
BDC4443	186311
BDC4500	186442
BDC4501	186443
BDC4503	186581
BDC4507	186303
BDC4526	186421
BDC4528	186401
BDC4530	186621
BDC4531	186521
BDC4532	186773
BDC4535	186839
BDC4536	186559
BDC4539	186467
	186864
BDC4541	186469
BDC4543	197059
BDC4544	186774
BDC4547	186774
BDC4548	186523
BDC4548BD	186523



QUINTON HAZELL (.../...)	
BDC4552	186773
BDC4556	186497
BDC4561	197227
BDC4572	186707
BDC4572BD	186707
BDC4577	186529
BDC4578	186408
BDC4582	197157
BDC4583	186278
BDC4584	186537
BDC4585	186572
BDC4586	186654
BDC4587	186701
BDC4588	197148
BDC4591	186874
BDC4594	186476
BDC4596	186565
BDC4597	186439
BDC4599	186306
BDC4604	186503
BDC4605	186569
BDC4607	186681
BDC4608	186822
BDC4611	186438
BDC4614	197120
BDC4615	197169
BDC4620	186589
BDC4621	186576
BDC4622	186577
BDC4623	186697
BDC4625	186685
BDC4627	186624
BDC4628	197236
BDC4629	186818
BDC4632	186647
BDC4634	186647
BDC4636	186884
BDC4644	186652
BDC4646	186770
BDC4646K	186770
BDC4647	197218
BDC4655	186614
BDC4659	186614
BDC4662	186533
BDC4663	186579
BDC4664	186532
	186599
BDC4666	186648
BDC4667	186628
BDC4668	186604
BDC4668BD	186604
BDC4669	186603
BDC4669BD	186603
BDC4670	186551
BDC4671	186552
BDC4673	186183
	186470







 	
QUINTON HAZELL (.../...)	
BDC4674	186590
BDC4676	186599
BDC4677	186860
BDC4678	197226
BDC4679	197223
BDC4680	186566
	197009
BDC4681	186644
BDC4682	186620
BDC4684	186643
BDC4699	197033
BDC4700	187045
BDC4726	186310
BDC4727	186163
	186560
BDC4727BD	186163
	186560
BDC4728	186741
BDC4729	186841
BDC4731	186583
BDC4732	186682
BDC4734	186725
BDC4735	197230
BDC4737	186827
BDC4738	186775
BDC4739	197231
BDC4740	186598
BDC4741	186585
	197223
BDC4744	186573
BDC4745	186562
BDC4746	186432
BDC4747	186452
BDC4748	186454
BDC4749	186156
	186571
BDC4750	186568
BDC4752	186582
BDC4753	186597
BDC4753BD	186597
BDC4754	186114
BDC4756	197229
BDC4759	187058
BDC4760	187040
BDC4763	197011
BDC4764	197088
BDC4767	186743
BDC4768	197246
BDC4769	186605
BDC4773	186691
BDC4774	186719
BDC4775	186648
BDC4793	186476
BDC4797	197004
BDC4798	186488
BDC4800	186642
BDC4802	186645



 	
QUINTON HAZELL (.../...)	
BDC4803	186638
BDC4804	197224
BDC4805	186818
BDC4806	186704
BDC4809	186778
BDC4810	197056
BDC4812	186591
BDC4813	186592
BDC4813BD	186592
BDC4814	186684
BDC4815	186594
BDC4816	186593
BDC4844	186778
BDC4849	186514
BDC4850	186821
BDC4851	186846
BDC4852	197094
BDC4876	197063
BDC4878	186476
BDC4886	186648
BDC4892	186564
BDC4921	186686
BDC4940	197207
BDC4980	186719
BDC4991	186705
BDC4992	186511
BDC4997	197220
BDC5001	186778
BDC5004	186821
BDC5005	197059
BDC5010	186758
BDC5030	197163
BDC5039	186845
BDC5040	186687
BDC5042	186742
BDC5043	186729
BDC5047	186435
BDC5058	186753
BDC5067	186485
BDC5071	186564
BDC5082	186511
BDC5089	186876
BDC5091	186509
BDC5094	197194
BDC5102	186454
BDC5108	197195
BDC5109	197122
BDC5117	186587
BDC5118	186814
BDC5141	186637
BDC5143	186655
BDC5145	186730
BDC5146	186815
BDC5147	186861
BDC5148	197161
BDC5149	186810
BDC5157	186859



 	
QUINTON HAZELL (.../...)	
BDC5159	186777
BDC5163	186688
BDC5164	186868
BDC5166	197086
BDC5168	186783
BDC5169	197221
BDC5173	186760
BDC5182	186294
BDC5183	197032
BDC5184	197124
BDC5188	197194
BDC5192	197009
BDC5194	186766
BDC5198	197239
BDC5199	186750
BDC5203	197206
BDC5204	197062
BDC5205	197108
BDC5212	186780
BDC5214	186710
BDC5215	186612
BDC5216	186801
BDC5219	186759
BDC5220	197016
BDC5221	186834
BDC5223	186788
BDC5224	186784
BDC5226	186789
BDC5227	186883
BDC5228	186731
BDC5231	186811
BDC5234	187061
BDC5235	187147
BDC5236	187148
BDC5237	186728
BDC5239	187149
BDC5240	186695
BDC5240BD	186695
BDC5241	186693
BDC5241BD	186693
BDC5242	186736
BDC5243	186720
BDC5243P	186720
BDC5250	186808
BDC5264	186800
BDC5266	186813
BDC5272	197067
BDC5276	197244
BDC5276BD	197244
BDC5277	197240
BDC5278	197198
BDC5279	197079
BDC5280	186765
BDC5282	186888
BDC5282BD	186888
BDC5284	186824
BDC5285	197172

 	
QUINTON HAZELL (.../...)	
BDC5297	186718
BDC5299	197112
BDC5302	186781
BDC5306	186757
BDC5307	186807
BDC5308	186856
BDC5309	186797
BDC5310	186884
BDC5311	186694
BDC5312	186762
BDC5313	186812
BDC5314	186790
BDC5318	197103
BDC5319	186702
BDC5320	186785
BDC5321	186703
BDC5322	186745
BDC5336	186809
BDC5337	197233
BDC5338	197069
BDC5339	186734
BDC5342	186709
BDC5346	186728
BDC5347	197219
BDC5348	186740
BDC5349	186724
BDC5355	197057
BDC5358	186791
BDC5360	197137
BDC5361	197138
BDC5362	197170
BDC5363	197171
BDC5365	186708
BDC5366	186748
BDC5367	186844
	197013
BDC5368	186871
BDC5369	186764
BDC5370	197087
BDC5372	197090
BDC5373	197065
	197162
BDC5379	186877
BDC5382	197238
BDC5385	186786
BDC5386	197146
BDC5390	186851
BDC5391	197020
BDC5396	197245
BDC5397	186851
BDC5401	197173
BDC5403	186823
BDC5406	186825
BDC5407	186829
BDC5408	197027
BDC5409	197121
BDC5410	197064



 	
QUINTON HAZELL (.../...)	
BDC5412	186881
BDC5413	186854
BDC5414	186751
BDC5415	197035
BDC5416	197242
BDC5417	186754
BDC5418	186755
BDC5419	186857
BDC5420	186744
BDC5421	186880
BDC5422	186882
BDC5423	186833
BDC5424	186756
BDC5425	186840
BDC5426	197022
BDC5428	186890
BDC5429	186858
BDC5430	186804
BDC5431	186715
BDC5432	186747
BDC5433	186816
BDC5435	186817
BDC5435BD	186817
BDC5436	197049
BDC5436BD	197049
BDC5438	186798
BDC5439	197036
BDC5440	186799
BDC5441	197091
BDC5444	186746
BDC5445	197096
BDC5449	186879
BDC5450	186878
BDC5451	197029
BDC5452	197214
BDC5453	197129
BDC5454	197060
BDC5455	186869
BDC5456	186855
BDC5457	186732
BDC5458	197193
BDC5459	197084
BDC5462	197210
BDC5463	197209
BDC5464	186751
BDC5466	186865
BDC5467	186805
BDC5468	186893
	186894
BDC5468P	186893
BDC5469	186712
BDC5471	197222
BDC5471BD	197222
BDC5472	186885
BDC5473	186886
BDC5474	186796
BDC5475	197243



 	
QUINTON HAZELL (.../...)	
BDC5481	197018
BDC5482	186847
BDC5483	186848
BDC5484	197019
BDC5485	186620
BDC5486	186819
BDC5487	186863
	197055
BDC5488	197143
BDC5489	186843
BDC5490	186872
BDC5491	197021
BDC5494	186713
BDC5495	197031
BDC5498	197044
BDC5499	197045
BDC5502	197008
BDC5504	197252
BDC5505	186842
BDC5508	197251
BDC5509	197145
BDC5513	186850
BDC5518	197047
BDC5518BD	197047
BDC5519	186849
BDC5520	197232
BDC5522	197054
BDC5523	197249
BDC5524	197055
BDC5526	197241
BDC5527	197234
BDC5528	197073
BDC5529	197176
BDC5530	197158
BDC5531	197175
BDC5532	197247
BDC5533	197130
BDC5535	197083
BDC5542	197164
BDC5544	197072
BDC5545	197199
BDC5546	197052
BDC5547	197125
BDC5548	187152
BDC5551	197030
BDC5552	187141
BDC5553	187146
BDC5554	197182
BDC5555	197113
BDC5556	197142
BDC5557	197038
BDC5561	197101
BDC5562	197055
BDC5565	197102
BDC5570	197149
BDC5571	197184
BDC5573	197111



 	
QUINTON HAZELL (.../...)	
BDC5574	197152
BDC5575	197197
BDC5576	197135
BDC5588	197109
BDC5590	197110
BDC5591	197099
BDC5592	197023
BDC5593	197097
BDC5594	197105
BDC5595	197117
BDC5596	197117
BDC5597	197100
BDC5598	197100
BDC5599	186747
BDC5607	197106
BDC5610	197097
BDC5611	197098
BDC5615	186802
BDC5616	186853
BDC5618	197126
BDC5619	197107
BDC5624	197092
BDC5628	197139
BDC5659	197046
BDC5660	197133
BDC5661	197248
BDC5664	186590
BDC5665	186590
BDC5669	197185
BDC5670	197070
	197187
BDC5671	197183
BDC5673	197168
BDC5676	197147
BDC5678	197071
BDC5681	197144
BDC5682	197153
BDC5686	197089
BDC5691	197140
BDC5695	197132
	197134
BDC5696	197050
BDC5700	197065
BDC5701	197066
BDC5702	197051
BDC5709	197213
BDC5710	197196
BDC5714	197191
BDC5720	197028
BDC5731	197155
BDC5736	197055
BDC5740	197188
BDC5741	197133
BDC5743	197028
BDC5744	197028
BDC5745	197028
BDC5746	197188



 	
QUINTON HAZELL (.../...)	
BDC5752	197123
BDC5757	197174
BSF1010	186249
BSF1026	186226
BSF1046	186245
BSF1060	186180
BSF1064	186202
BSF3116	186242
BSF3118	186115
BSF3120	186160
BSF3121	186256
BSF3122	186254
BSF3126	186116
BSF3133	186171
BSF3141	186240
BSF3142	186128
BSF3150	186151
BSF3167	186142
BSF3180	186139
BSF3185	186189
BSF3191	186501
BSF3193	186152
BSF3194	186170
BSF3195	186205
BSF3199	186137
BSF3205	186188
	186790
BSF3209	186110
BSF3211	186113
BSF3216	186135
BSF3235	186158
BSF3236	186159
BSF3237	186169
BSF3240	186186
	197150
BSF3243	186218
BSF3245	186211
BSF3247	186134
BSF3249	186230
	186803
BSF3274	186140
BSF3276	186143
BSF3283	186207
BSF3284	186203
BSF3285	186197
BSF3288	186117
BSF3309	186246
BSF3310	186771
BSF3310C	186771
BSF3317	186112
BSF3330	186257
BSF3358	186479
BSF3387	186172
BSF3388	186187
	186757
BSF3422	186462
BSF3434	186206



	
QUINTON HAZELL (.../...)	
BSF3435	186156
BSF3436	186157
BSF3440	186150
BSF3441	186149
BSF3442	186146
BSF3444	186176
BSF3445	186185
BSF3446	186182
BSF3447	186184
BSF3449	186228
BSF3450	186210
BSF3451	186224
BSF3452	186214
BSF3457	186255
BSF3458	186776
BSF3458C	186776
BSF3460	186374
BSF3464	186118
BSF3468	186195
BSF3470	186236
BSF3471	186613
BSF3473	186283
BSF3477	186200
BSF3480	186119
BSF3481	186232
BSF3501	186102
BSF3502	186103
BSF3503	186265
BSF3504	186146
	186290
BSF3505	186130
BSF3508	186198
BSF3511	186154
BSF3512	186136
BSF3513	187029
BSF3517	186165
BSF3518	186424
BSF3519	186168
BSF3542	186192
BSF3543	186191
BSF3544	186190
BSF3546	186229
BSF3550	186213
BSF3552	186219
BSF3553	186221
BSF3554	186498
BSF3555	197114
BSF3563	186637
BSF3565	186258
BSF3570	186264
BSF3573	186234
BSF3575	186235
BSF3577	186495
BSF3580	186299
BSF3583	186425
BSF3589	186114
BSF3591	186431

	
QUINTON HAZELL (.../...)	
BSF3592	186155
	186406
BSF3593	186153
BSF3597	186177
BSF3598	197165
BSF3602	186220
BSF3603	186696
BSF3605	186247
BSF3606	186263
BSF3608	186166
BSF3611	186162
BSF3626	186234
BSF3627	186183
	186470
BSF3629	186292
BSF3630	186273
BSF3635	186272
BSF3639	186124
BSF3640	186125
BSF3648	186131
BSF3649	186435
BSF3653	186173
BSF3657	186455
BSF3667	186692
BSF3675	186482
BSF3680	186189
BSF3681	186302
BSF3682	186625
BSF3683	197004
BSF3684	197028
BSF3688	186194
BSF3689	186196
BSF3690	186199
BSF3691	186231
BSF3692	186225
BSF3693	186223
BSF3696	186500
BSF3698	186511
BSF3704	186508
BSF3712	186288
BSF3712C	186288
BSF3713	186251
BSF3715	186770
BSF3716	186263
BSF3724	186145
BSF3725	186144
BSF3727	186163
BSF3731	186148
BSF3733	186446
BSF3736	186446
BSF3737	186530
BSF3740	197114
BSF3744	186441
BSF3747	186665
BSF3755	186596
BSF3762	186510
	186511

	
QUINTON HAZELL (.../...)	
BSF3764	186770
BSF3766	186266
BSF3767	186267
BSF3769	186310
BSF3771	186147
BSF3773	186440
BSF3774	186611
BSF3775	186485
BSF3777	186204
BSF3779	186504
BSF3783	186519
BSF3786	186416
BSF3787	186315
BSF3788	186314
BSF3789	186303
BSF3790	186564
BSF3791	186301
BSF3792	186487
BSF3796	186613
BSF3797	186283
	186284
BSF3800	186286
BSF3801	186285
BSF3803	186274
BSF3804	186275
BSF3805	186295
BSF3807	186428
BSF3816	186505
BSF3818	186509
BSF3819	186547
BSF3820	186300
BSF3821	186159
BSF3824	186270
BSF3825	197222
BSF3826	186282
BSF3827	186490
BSF3828	186488
BSF3833	186482
BSF3837	186289
BSF3838	186298
BSF3839	186280
BSF3840	186281
BSF3854	186266
	186297
BSF3899	186208
BSF3907	186268
BSF3909	186277
BSF3910	186426
BSF3911	186313
BSF3912	186526
BSF3913	186528
BSF3916	186653
BSF3919	186586
BSF3920	186296
BSF3927	186640
BSF3929	186294
BSF3933	186291

	
QUINTON HAZELL (.../...)	
BSF3934	186269
BSF3935	186807
BSF3937	186517
BSF3944	186276
BSF3951	186457
BSF3955	186617
BSF3958	186685
BSF3959	186458
BSF3960	186449
BSF4183	186441
BSF4242	186178
BSF4254	186768
BSF4267	186520
BSF4282	186487
BSF4294	186451
BSF4308	186266
BSF4312	186208
BSF4313	186235
BSF4321	186460
BSF4330	186648
BSF4334	186198
BSF4336	186306
BSF4337	186307
BSF4338	186304
BSF4339	186600
BSF4349	186428
BSF4350	186305
BSF4351	186427
BSF4353	186278
BSF4354	186664
BSF4355	186405
BSF4356	186406
BSF4357	186436
	186438
	186439
BSF4358	186439
BSF4360	186420
BSF4361	186418
	197043
BSF4362	197131
	197228
BSF4363	197217
BSF4365	186159
BSF4366	186427
BSF4369	186435
BSF4370	186436
BSF4371	186433
BSF4372	186438
BSF4373	186699
BSF4375	186439
BSF4377	197208
BSF4379	186461
BSF4380	186465
BSF4389	186453
BSF4396	186563
BSF4397	186496
BSF4398	197217



QUINTON HAZELL (.../...)	
BSF4399	186418
BSF4400	197228
BSF4401	186567
BSF4402	186768
	186775
BSF4403	186304
BSF4404	186305
BSF4405	186307
BSF4406	186600
BSF4409	186287
BSF4410	186714
	197221
BSF4414	186570
	186730
BSF4415	186875
BSF4416	197167
BSF4418	186509
BSF4422	197166
BSF4423	186652
BSF4426	186607
BSF4439	197225
BSF4441	186775
BSF4443	186311
BSF4500	186442
BSF4501	186443
BSF4503	186581
BSF4507	186303
BSF4526	186421
BSF4528	186401
BSF4530	186621
BSF4531	186521
BSF4532	186773
BSF4535	186839
BSF4536	186559
BSF4539	186467
	186864
BSF4541	186469
BSF4543	197059
BSF4544	186774
BSF4547	186774
BSF4548	186523
BSF4552	186773
BSF4556	186497
BSF4561	197227
BSF4572	186707
BSF4577	186529
BSF4578	186408
BSF4582	197157
BSF4583	186278
BSF4584	186537
BSF4585	186572
BSF4586	186654
BSF4587	186701
BSF4588	197148
BSF4591	186874
BSF4596	186565
BSF4597	186439



QUINTON HAZELL (.../...)	
BSF4599	186306
BSF4604	186503
BSF4605	186569
BSF4607	186681
BSF4608	186822
BSF4614	197120
BSF4615	197169
BSF4620	186589
BSF4621	186576
BSF4622	186577
BSF4623	186697
BSF4625	186685
BSF4627	186624
BSF4628	197236
BSF4629	186818
BSF4632	186647
BSF4634	186647
BSF4636	186884
BSF4644	186652
BSF4646	186770
BSF4646K	186770
BSF4647	197218
BSF4655	186614
BSF4659	186614
BSF4662	186533
BSF4663	186579
BSF4664	186532
	186599
BSF4666	186648
BSF4667	186628
BSF4668	186604
BSF4669	186603
BSF4670	186551
BSF4671	186552
BSF4673	186183
	186470
BSF4674	186590
BSF4676	186599
BSF4677	186860
BSF4678	197226
BSF4679	197223
BSF4680	186566
	197009
BSF4681	186644
BSF4682	186620
BSF4684	186643
BSF4699	197033
BSF4700	187045
BSF4726	186310
BSF4727	186163
	186560
BSF4728	186741
BSF4729	186841
BSF4731	186583
BSF4732	186682
BSF4734	186725
BSF4735	197230



QUINTON HAZELL (.../...)	
BSF4737	186827
BSF4738	186775
BSF4739	197231
BSF4740	186598
BSF4741	186585
	197223
BSF4744	186573
BSF4745	186562
BSF4746	186432
BSF4747	186452
BSF4748	186454
BSF4749	186156
	186571
BSF4750	186568
BSF4752	186582
BSF4753	186597
BSF4754	186114
BSF4756	197229
BSF4759	187058
BSF4760	187040
BSF4763	197011
BSF4764	197088
BSF4767	186743
BSF4768	197246
BSF4769	186605
BSF4773	186691
BSF4774	186719
BSF4775	186648
BSF4793	186476
BSF4797	197004
BSF4798	186488
BSF4800	186642
BSF4802	186645
BSF4803	186638
BSF4804	197224
BSF4805	186818
BSF4806	186704
BSF4809	186778
BSF4810	197056
BSF4812	186591
BSF4813	186592
BSF4814	186684
BSF4815	186594
BSF4816	186593
BSF4844	186778
BSF4849	186514
BSF4850	186821
BSF4851	186846
BSF4852	197094
BSF4876	197063
BSF4878	186476
BSF4886	186648
BSF4892	186564
BSF4921	186686
BSF4940	197207
BSF4980	186719
BSF4991	186705



QUINTON HAZELL (.../...)	
BSF4992	186511
BSF4997	197220
BSF5001	186778
BSF5004	186821
BSF5005	197059
BSF5010	186758
BSF5030	197163
BSF5039	186845
BSF5040	186687
BSF5042	186742
BSF5043	186729
BSF5047	186435
BSF5058	186753
BSF5067	186485
BSF5071	186564
BSF5082	186511
BSF5089	186876
BSF5091	186509
BSF5094	197194
BSF5102	186454
BSF5108	197195
BSF5109	197122
BSF5117	186587
BSF5118	186814
BSF5141	186637
BSF5143	186655
BSF5145	186730
BSF5146	186815
BSF5147	186861
BSF5148	197161
BSF5149	186810
BSF5157	186859
BSF5159	186777
BSF5163	186688
BSF5164	186868
BSF5166	197086
BSF5168	186783
BSF5169	197221
BSF5173	186760
BSF5182	186294
BSF5183	197032
BSF5184	197124
BSF5188	197194
BSF5192	197009
BSF5194	186766
BSF5198	197239
BSF5199	186750
BSF5203	197206
BSF5204	197062
BSF5205	197108
BSF5212	186780
BSF5214	186710
BSF5215	186612
BSF5216	186801
BSF5219	186759
BSF5220	197016
BSF5221	186834



 	
QUINTON HAZELL (.../...)	
BSF5223	186788
BSF5224	186784
BSF5226	186789
BSF5227	186883
BSF5228	186731
BSF5231	186811
BSF5234	187061
BSF5235	187147
BSF5236	187148
BSF5237	186728
BSF5239	187149
BSF5240	186695
BSF5241	186693
BSF5242	186736
BSF5243	186720
BSF5243P	186720
BSF5250	186808
BSF5264	186800
BSF5266	186813
BSF5272	197067
BSF5276	197244
BSF5277	197240
BSF5278	197198
BSF5279	197079
BSF5280	186765
BSF5282	186888
BSF5284	186824
BSF5285	197172
BSF5297	186718
BSF5299	197112
BSF5302	186781
BSF5306	186757
BSF5307	186807
BSF5308	186856
BSF5309	186797
BSF5310	186884
BSF5311	186694
BSF5312	186762
BSF5313	186812
BSF5314	186790
BSF5318	197103
BSF5319	186702
BSF5320	186785
BSF5321	186703
BSF5322	186745
BSF5336	186809
BSF5337	197233
BSF5338	197069
BSF5339	186734
BSF5342	186709
BSF5346	186728
BSF5347	197219
BSF5348	186740
BSF5349	186724
BSF5355	197057
BSF5358	186791
BSF5360	197137

 	
QUINTON HAZELL (.../...)	
BSF5361	197138
BSF5362	197170
BSF5363	197171
BSF5365	186708
BSF5366	186748
BSF5367	186844
	197013
BSF5368	186871
BSF5369	186764
BSF5370	197087
BSF5372	197090
BSF5373	197065
	197162
BSF5379	186877
BSF5382	197238
BSF5385	186786
BSF5386	197146
BSF5390	186851
BSF5391	197020
BSF5396	197245
BSF5397	186851
BSF5401	197173
BSF5403	186823
BSF5406	186825
BSF5407	186829
BSF5408	197027
BSF5409	197121
BSF5410	197064
BSF5412	186881
BSF5413	186854
BSF5414	186751
BSF5415	197035
BSF5416	197242
BSF5417	186754
BSF5418	186755
BSF5419	186857
BSF5420	186744
BSF5421	186880
BSF5422	186882
BSF5423	186833
BSF5424	186756
BSF5425	186840
BSF5426	197022
BSF5428	186890
BSF5429	186858
BSF5430	186804
BSF5431	186715
BSF5432	186747
BSF5433	186816
BSF5435	186817
BSF5436	197049
BSF5438	186798
BSF5439	197036
BSF5440	186799
BSF5441	197091
BSF5444	186746
BSF5445	197096

 	
QUINTON HAZELL (.../...)	
BSF5449	186879
BSF5450	186878
BSF5451	197029
BSF5452	197214
BSF5453	197129
BSF5454	197060
BSF5455	186869
BSF5456	186855
BSF5457	186732
BSF5458	197193
BSF5459	197084
BSF5462	197210
BSF5463	197209
BSF5464	186751
BSF5466	186865
BSF5467	186805
BSF5468	186893
	186894
BSF5468P	186893
BSF5469	186712
BSF5471	197222
BSF5472	186885
BSF5473	186886
BSF5474	186796
BSF5475	197243
BSF5481	197018
BSF5482	186847
BSF5483	186848
BSF5484	197019
BSF5485	186620
BSF5486	186819
BSF5487	186863
	197055
BSF5488	197143
BSF5489	186843
BSF5490	186872
BSF5491	197021
BSF5494	186713
BSF5495	197031
BSF5498	197044
BSF5499	197045
BSF5502	197008
BSF5504	197252
BSF5505	186842
BSF5508	197251
BSF5509	197145
BSF5513	186850
BSF5518	197047
BSF5519	186849
BSF5520	197232
BSF5522	197054
BSF5523	197249
BSF5524	197055
BSF5526	197241
BSF5527	197234
BSF5528	197073
BSF5529	197176

 	
QUINTON HAZELL (.../...)	
BSF5530	197158
BSF5531	197175
BSF5532	197247
BSF5533	197130
BSF5535	197083
BSF5542	197164
BSF5544	197072
BSF5545	197199
BSF5546	197052
BSF5547	197125
BSF5548	187152
BSF5551	197030
BSF5552	187141
BSF5553	187146
BSF5554	197182
BSF5555	197113
BSF5556	197142
BSF5557	197038
BSF5561	197101
BSF5562	197055
BSF5565	197102
BSF5570	197149
BSF5571	197184
BSF5573	197111
BSF5574	197152
BSF5575	197197
BSF5576	197135
BSF5588	197109
BSF5590	197110
BSF5591	197099
BSF5592	197023
BSF5593	197097
BSF5594	197105
BSF5595	197117
BSF5596	197117
BSF5597	197100
BSF5598	197100
BSF5599	186747
BSF5607	197106
BSF5610	197097
BSF5611	197098
BSF5615	186802
BSF5616	186853
BSF5618	197126
BSF5619	197107
BSF5624	197092
BSF5628	197139
BSF5659	197046
BSF5660	197133
BSF5661	197248
BSF5664	186590
BSF5665	186590
BSF5669	197185
BSF5670	197070
	197187
BSF5671	197183
BSF5673	197168

	
---	---

QUINTON HAZELL (.../...)	
BSF5676	197147
BSF5678	197071
BSF5681	197144
BSF5682	197153
BSF5686	197089
BSF5691	197140
BSF5695	197132
	197134
BSF5696	197050
BSF5700	197065
BSF5701	197066
BSF5702	197051
BSF5709	197213
BSF5710	197196
BSF5714	197191
BSF5720	197028
BSF5731	197155
BSF5736	197055
BSF5740	197188
BSF5741	197133
BSF5743	197028
BSF5744	197028
BSF5745	197028
BSF5746	197188
BSF5752	197123
BSF5757	197174

ROADHOUSE

6013.00	186299
6014.00	197114
6019.00	186160
6020.00	186144
6021.00	186135
6022.00	186140
6023.00	186586
6024.00	186288
6025.00	186517
6030.00	186151
6032.00	186311
6033.00	186226
6040.00	186232
6047.00	186300
6054.00	186453
6057.00	186186
	197150
6058.00	186118
6059.00	186187
	186188
6060.00	186530
6061.10	186188
6062.10	186119
6065.00	186240
6066.00	186228
6067.00	186230
	186803
6070.00	186130
6072.00	186231

	
---	---

ROADHOUSE (.../...)	
6073.00	186768
6074.00	186768
	186775
6075.00	186768
	186775
6076.00	186189
6077.00	186211
6080.10	186229
6081.10	186213
6082.00	186178
6083.00	186435
6084.10	186246
6086.00	186249
6088.01	186245
6089.00	186173
6091.00	186257
6093.10	186102
6094.00	186162
6095.00	186158
6096.10	186163
6097.10	186159
61002.10	197066
61003.10	197047
61004.00	197113
61005.10	197147
61006.10	197182
61007.00	187147
61008.00	187148
	187149
61009.10	197142
61011.00	197038
61014.00	186840
61014.20	186840
	197002
61019.10	197055
6102.00	186242
61021.10	197249
61022.10	197054
61029.10	197091
61034.10	187141
61035.00	197030
61036.10	187146
61038.10	186805
6104.00	186236
61046.20	186840
61047.00	186853
61047.10	197069
61047.20	186853
61048.20	186720
61049.10	197241
6105.10	186482
61050.10	197070
61052.10	197188
61053.00	197099
61054.10	197133
61055.00	197023
61056.00	197023
	197097



	
---	---



ROADHOUSE (.../...)	
61057.00	197105
61058.00	197117
61060.00	197100
61065.00	197036
61066.10	197203
61068.10	197201
61069.00	197128
6107.10	186156
61070.00	197127
61073.00	186848
61074.00	197110
6108.10	186433
61080.10	197176
61081.10	197074
61087.10	197164
61089.00	197112
6109.10	186613
61092.10	197070
61093.10	197170
61098.00	197116
6110.00	186155
	186406
6110.01	186155
	186406
61101.10	197052
61105.00	197123
6111.00	186157
61110.10	197196
61112.00	197126
6112.00	186142
61121.10	197187
61122.10	197183
61129.10	197154
6113.10	186301
61137.10	197067
61138.10	197200
61144.00	186295
61147.00	197104
61158.00	197018
61160.10	197243
61162.10	186727
61165.10	197092
61167.00	197101
61169.10	197184
6117.10	186221
61170.10	187061
61171.10	186717
61172.10	197139
61173.00	197111
61174.00	197102
61176.00	186786
61178.10	197173
6118.00	186128
61182.10	197191
61183.10	197190
61184.10	197202
61189.10	197152



	
---	---



ROADHOUSE (.../...)	
6119.00	186143
61192.00	186853
61194.10	197159
61195.00	186812
6120.00	186292
61201.00	187152
61202.00	187149
61204.10	197131
	197228
61208.10	197205
61209.00	197028
61217.10	197174
61218.10	197145
61219.00	186495
6122.00	186114
61223.10	197143
61227.10	197222
6123.00	186294
61231.10	197049
61234.10	186804
6128.00	186196
	186416
6129.00	186276
6130.00	186200
6131.10	186194
6133.10	186195
6136.00	186199
6141.00	186621
6142.00	186110
6144.10	186208
6145.10	186611
6147.00	186424
6148.00	186452
6149.00	186146
	186290
6150.00	186146
	186147
	186290
6152.00	186501
6153.10	186287
6155.00	186425
6156.00	186171
6157.10	186218
6159.00	186223
6160.10	186426
6161.00	186214
	186225
6163.00	186168
6165.00	186567
6166.00	186596
6167.00	186115
6168.00	186205
6169.00	186206
6170.10	186509
	186637
	186696
6171.10	186116







 	
ROADHOUSE (.../...)	
6172.00	186251
6173.00	186268
6174.10	186282
6175.10	186247
6176.10	186273
6177.10	186267
6178.10	186189
6179.10	186485
6180.00	186152
6181.00	186113
6182.00	186147
6183.10	186149
6184.10	186451
6185.10	186112
6186.10	186148
6188.10	186488
6189.10	186153
6190.00	186131
6191.00	186154
6192.00	186150
6193.00	186281
6194.00	186184
6195.00	186498
6197.00	186117
6200.00	186487
6201.00	186192
6202.10	186191
6203.10	186457
6204.10	186214
6205.10	186436
	186439
6206.00	186458
6207.00	186490
	197226
6208.00	186235
6209.00	186258
6210.10	186139
6211.10	186277
6213.10	186427
6214.10	186165
6215.10	186166
6217.00	186302
6221.00	186176
6224.10	186438
	186620
6225.10	186234
6226.10	186286
6227.10	186304
	186655
6227.11	186305
6228.10	186177
6229.10	186776
6231.10	186263
6232.00	186197
6233.00	186254
6234.11	186607
6235.10	186612



 	
ROADHOUSE (.../...)	
6236.10	186219
6237.10	186455
6239.00	186306
6239.02	186306
	186307
6240.10	186198
6241.01	186134
6242.00	186170
6243.00	186614
6247.10	186103
6249.00	186190
6250.00	186428
6253.00	186169
6257.00	186172
6261.00	186202
6264.10	186203
6265.10	186145
6268.10	186272
6270.00	186183
6271.00	186462
6272.00	186180
6277.10	186210
6282.00	186207
6283.00	186256
6284.00	186295
6287.00	186269
6290.00	187029
6293.10	186313
6294.10	186519
6295.10	186291
6297.10	186224
6300.10	186625
6301.10	186600
6302.10	186500
6304.10	186289
6305.10	186420
	186443
6305.11	186420
6306.10	186296
6307.10	186303
6310.00	186298
6311.00	186182
6313.10	186280
6314.10	186185
6315.10	186266
	186297
6315.11	186643
6316.10	186265
6316.11	186266
6319.10	186496
6320.10	186137
6321.11	186220
6322.10	186235
6323.00	186274
6324.10	186275
6325.10	186264
6327.00	186270



 	
ROADHOUSE (.../...)	
6328.10	197222
6329.00	186374
6330.00	186204
6331.00	186504
6333.00	186310
6334.00	186136
6337.10	186479
6338.10	186460
6339.10	197225
6340.10	186284
6341.00	186283
6342.00	186125
6343.10	186465
6344.10	186461
6347.00	186124
6350.00	186692
6367.10	186234
6369.10	186431
6370.00	186285
6374.10	186441
6375.10	186617
6376.10	186440
6385.10	186446
6386.10	186449
6392.10	186476
6394.10	186648
6394.11	186648
6398.00	186503
6399.10	186505
6401.00	186510
	186511
6402.10	186511
6405.10	186696
6408.10	186637
6409.10	186255
6410.10	186526
6411.00	186528
6413.10	186665
6414.00	186314
6415.00	186770
6416.10	186315
6418.00	186581
6419.10	186570
	186730
6420.00	187040
6423.10	186576
6424.00	186654
6425.00	186681
6426.10	186523
6427.00	186529
6429.00	186807
6430.10	186577
6431.00	186773
6433.00	186569
6437.10	197165
6439.10	186652
6440.10	186509

 	
ROADHOUSE (.../...)	
6442.10	186644
6442.11	186589
6443.10	186590
6444.10	186563
6445.10	186508
6446.10	186664
6447.00	186647
6449.10	186532
6451.00	186620
6453.00	186624
6454.00	186565
6458.10	186559
6460.10	186551
6461.10	186774
6462.10	186719
6464.10	186653
6465.10	186652
6467.00	186470
6468.00	186771
6469.10	186401
6471.00	186552
6472.00	186408
6473.00	197217
6476.10	186418
	197043
6477.10	186585
6478.10	186442
6479.10	186405
	186443
6481.00	197218
6484.10	186235
6485.10	186439
6486.10	186533
6487.00	186566
6491.10	186645
6492.10	186628
6493.10	186521
6494.10	197226
6495.10	186467
6496.10	197236
6497.10	186547
6498.00	186579
6500.00	187058
6501.10	186640
6502.00	186421
6503.10	197224
6504.10	197228
6506.00	186642
6507.10	186638
6509.10	197227
6512.00	186605
6513.00	186773
6514.10	186697
6515.10	186685
6517.10	186153
	186571
6518.10	186278

 	
ROADHOUSE (.../...)	
6519.10	186537
6520.10	186572
6521.00	186432
	186435
6522.00	186454
6523.10	197208
6526.00	186562
	186753
6527.10	186573
6531.00	186564
6532.00	186497
6535.00	186598
6536.00	186599
6537.00	186775
6538.00	186714
6539.10	186701
6540.10	197169
6541.10	186822
6542.10	197148
6544.10	197230
6545.10	186603
6546.10	186604
6547.00	186597
6548.10	186582
6549.10	186583
6550.00	186725
6551.10	186682
6552.00	186691
6553.10	186827
6554.00	186568
6555.00	186469
6557.10	186818
6560.10	186585
	197223
6561.10	186686
6562.10	186704
6563.10	197229
6564.10	186514
6565.00	197033
6566.00	187045
6567.10	186688
6568.00	186777
6569.10	186875
6570.00	186594
6571.10	197167
6572.10	186592
6573.10	186743
6574.00	186487
6575.10	186560
6577.10	186705
6578.00	186593
6581.10	197004
6583.10	186655
6584.10	186684
6585.10	186707
6586.10	186778
6587.10	197220

 	
ROADHOUSE (.../...)	
6588.10	186860
6589.10	186815
6590.10	197231
6591.10	186741
6595.00	186788
6596.10	186758
6597.10	197246
6598.10	186731
6599.10	186884
6600.10	186808
6602.10	197233
6603.10	186695
6604.10	186693
6605.00	186724
	186736
6606.00	186742
6607.10	186750
6608.10	186710
6609.10	186709
6610.10	186821
6611.10	186759
6612.10	197221
6613.00	186718
6613.20	186718
6614.10	186814
6615.00	197016
6616.00	186729
6617.00	186859
6618.10	186587
6619.10	186789
6620.00	186841
6621.00	186784
6622.10	186600
6623.10	197059
6624.10	186762
6625.10	186648
6626.10	197238
6627.00	197120
6629.00	186812
6630.00	186694
6632.00	186809
6633.10	186823
6635.10	186766
6637.10	186734
6638.10	197062
6639.10	186813
6640.10	186765
6641.10	186780
6642.10	197064
6643.10	186868
6644.10	186811
6645.10	186883
6646.10	197088
6647.10	186754
6648.10	186755
6649.00	186857
6650.00	186833

 	
ROADHOUSE (.../...)	
6651.10	186816
6652.10	186817
6653.10	186732
6654.10	197084
6657.10	197232
6658.10	197219
6659.00	186801
6660.10	197239
6661.00	186834
6662.10	186748
6663.10	186879
6664.00	186757
6665.10	186790
6666.10	186878
6667.10	197172
6668.10	186829
6670.10	186871
6671.10	186872
6673.10	197245
6674.00	186798
6675.10	186799
6676.10	186751
6678.00	186858
6679.10	186890
6681.10	186728
6682.10	186712
6683.10	186764
6684.10	186869
6685.10	186869
6686.10	186882
6687.10	186880
6688.00	186854
6689.10	186881
6690.00	186747
	197010
6691.10	197046
6692.00	186785
6693.10	186702
	186746
6694.10	186717
	197079
	186804
6696.10	197240
6697.10	186715
6698.00	186720
6698.20	186720
6699.10	197065
	197162
6700.00	186849
6701.10	197072
6703.10	197171
6705.00	197019
6706.10	197071
6707.10	186886
6708.10	186756
6709.10	186888
6710.10	186819



 	
ROADHOUSE (.../...)	
6711.10	186863
6712.00	186843
6714.00	186196
6716.00	186839
6718.00	197011
6719.00	186488
6721.00	186687
6722.10	186861
6723.00	197032
6724.00	197124
6728.10	186800
6729.10	197244
6730.10	197198
6731.00	186856
6732.00	197103
6733.00	186713
6733.20	186713
6734.10	186745
6735.00	186740
6736.00	186724
6738.00	186791
6741.00	186708
6742.10	186877
6745.10	186744
6746.00	197022
6748.10	197060
6749.10	186885
6750.00	186796
6750.20	186796
6751.10	186467
	186864
6753.00	186807
6754.10	197195
6756.00	197027
6760.10	186865
6763.10	197144
6764.00	197009
6766.00	197121
6773.10	197087
6784.00	197122
6787.00	197035
6788.00	186845
6789.00	186855
6790.10	197207
6791.10	197197
6793.10	197194
6795.10	197056
6799.00	186753
6800.00	186591
6803.00	186294
6804.10	186699
6805.00	186847
6807.10	197199
6809.00	186802
6812.10	186810
6819.10	186652
	186876



Valeo	
ROADHOUSE (.../...)	
6824.10	186637
6825.10	186874
6826.10	197086
6829.10	186781
6830.00	197108
6831.00	186760
6833.00	197020
6834.10	197161
6842.10	197166
6843.10	197063
6844.10	186866
	197146
6845.10	186439
6846.00	186842
6848.00	186893
	197003
6848.20	186894
	197003
6853.10	197193
6856.10	197137
6859.10	186783
6861.10	197050
6862.10	197168
6863.00	186844
	197013
6866.10	197057
6869.10	186702
	186746
6879.00	197129
6881.00	186851
6885.10	197206
6895.10	197252
6897.10	186824
6906.00	197021
6910.00	186850
6917.00	186114
6938.10	186778
6942.10	197142
6964.10	197247
6965.10	197130
6966.10	197132
	197134
6967.00	197098
6968.00	186797
6969.00	197125
6970.10	197140
	197212
6971.10	197090
6972.10	186758
	197242
6973.00	197031
6974.10	197234
6975.10	197073
6976.10	197175
6977.10	197049
	197158
6978.10	197083



Valeo	
ROADHOUSE (.../...)	
6979.10	197251
6980.10	197214
6981.10	197028
	197044
	197045
6982.10	197045
6983.00	197008
6985.10	197153
6987.10	186825
6990.10	197096
6992.10	197210
6993.10	197209
6994.10	197155
6995.10	197156
6999.00	186893
6999.20	186893
ROULUNDS	
D1113	186170
D1151	187029
D1354	186771
D1423	186741
D1539	197033
D1540	187045
D1559	197194
D1583	186808
D1593	186884
D1607	197221
D1636	186614
D1648	186868
D1649	186740
D2001	186195
D2002	186196
D2003	186194
D2004	186140
D2005	186135
D2006	186198
D2007	186131
D2008	186155
	186406
D2009	186154
D2010	186128
D2011	186130
D2012	186142
D2013	186143
D2014	186200
D2015	186134
D2016	186139
D2017	186205
D2018	186206
D2019	186202
D2020	186197
D2021	186226
D2022	186228
D2023	186230
	186803
D2024	186211



Valeo	
ROULUNDS (.../...)	
D2027	186229
D2028	186219
D2029	186221
D2030	186214
D2032	186213
D2033	186218
D2034	186240
D2036	186249
D2037	186245
D2038	186246
D2039	186112
D2040	186186
D2041	186151
D2042	186160
D2043	186158
D2044	186159
D2045	186162
D2046	186163
D2047	186173
D2049	186180
D2050	186176
D2051	186184
D2052	186182
D2053	186183
D2054	186177
D2055	186187
D2057	186251
D2058	186288
D2059	186256
D2060	186776
D2062	186258
D2063	186311
D2064	186263
D2066	186113
D2070	186117
D2071	186118
D2072	186119
D2073	186124
D2074	186125
D2075	186501
D2076	186199
D2077	186485
D2078	186301
D2079	186188
D2080	186247
D2081	186145
D2082	186207
D2083	186157
D2084	186210
D2086	186276
D2087	186231
D2088	186185
D2090	186189
D2091	186304
D2092	186264
D2093	186136
D2095	186225

Valeo	
ROULUNDS (.../...)	
D2096	186208
D2097	186313
D2098	186137
D2099	186152
D2100	186277
D2103	186166
D2104	186149
D2105	186220
D2107	186273
D2108	186114
D2109	186236
D2110	186115
D2112	186144
D2114	186286
D2115	186285
D2116	186146
	186290
D2117	186178
D2118	186302
D2119	186204
D2120	186224
D2122	186275
D2124	186146
	186290
D2125	186147
D2127	186192
D2128	186191
D2129	186768
D2130	186257
D2133	186268
D2134	186269
D2135	186270
D2136	197222
D2137	186232
D2138	186274
D2139	186150
D2140	186156
D2141	186153
D2142	186172
D2143	186280
D2144	186102
D2147	186116
D2148	186296
D2149	186586
D2150	186303
D2152	186148
D2153	186281
D2154	186298
D2155	186190
D2156	186282
D2158	186203
D2159	186416
D2161	186223
D2162	186768
	186775
D2164	186305
D2165	186306



	
ROULUNDS (.../...)	
D2166	186307
D2168	186600
D2169	186519
D2171	186420
D2172	186421
D2173	186589
D2174	186532
D2175	186533
D2177	197217
D2178	186418
D2179	197228
D2181	186598
D2182	186599
D2183	186579
D2185	186768
D2188	186655
D2190	186569
D2191	186621
D2192	186567
D2193	186596
D2195	186431
D2196	186432
	186435
D2197	186436
	186438
	186439
D2198	186433
D2200	186438
D2201	186439
D2202	186455
D2203	186446
D2205	186457
D2206	186449
D2207	186451
D2208	186458
D2209	186440
D2210	186441
	197173
D2211	186504
D2212	186617
D2216	186110
D2217	186103
D2218	186265
D2219	186266
D2221	186405
D2222	186406
D2223	186605
D2225	186644
D2226	186297
D2227	186643
D2228	186420
	186443
D2229	197229
D2232	186503
D2234	186505
D2236	186292
	186807



	
ROULUNDS (.../...)	
D2237	186287
D2240	186267
D2241	186294
D2242	186523
D2243	186408
D2244	186773
D2245	186773
D2246	186509
D2247	186547
D2249	186517
D2250	197236
D2251	186624
D2252	197230
D2253	186603
D2254	186604
D2255	186597
D2256	186295
D2257	186427
D2258	186529
D2259	186560
D2262	186169
D2263	186425
D2264	186168
D2265	186278
D2267	186426
D2269	186625
D2271	186490
D2272	197225
D2275	186496
	197226
D2276	186565
D2281	186460
D2282	186470
D2285	186498
D2286	186500
D2288	186476
D2289	186818
D2292	186487
D2293	186300
D2296	186701
D2297	186875
D2298	197169
D2299	186637
D2300	186822
D2301	186254
D2302	186255
D2305	186526
D2306	186528
D2307	186648
D2308	186647
D2309	186613
D2311	186479
D2313	186234
D2315	186283
D2316	186310
D2317	186284
D2319	186439



	
ROULUNDS (.../...)	
D2320	186442
D2322	186592
D2323	186684
D2324	186593
D2325	186582
D2326	197246
D2327	197088
D2328	197011
D2329	186521
D2330	186153
	186266
	186571
D2331	186774
D2332	186620
D2334	186775
D2337	186495
D2339	186568
D2343	186770
D2344	186692
D2346	186462
D2347	186469
D2349	186530
D2350	186714
D2351	186681
D2352	186171
D2353	186314
D2355	186581
D2357	197218
D2358	186311
D2359	186424
D2360	186428
D2364	186564
D2370	186687
D2375	197114
D2376	186374
D2380	186591
D2381	186594
D2382	186784
D2383	186777
D2384	197122
D2385	186742
D2386	186114
D2387	186725
D2389	186770
D2390	186729
D2391	186562
D2392	186552
D2394	197004
	197028
D2395	186165
D2397	186159
D2398	197220
D2404	197227
D2405	186860
D2406	186697
D2409	186559
D2410	186815



	
ROULUNDS (.../...)	
D2411	186861
D2412	186315
D2413	186140
D2415	186467
D2422	186707
D2424	186789
D2425	186401
D2426	186165
D2428	186750
D2429	186573
D2430	186551
D2432	186864
D2435	186234
D2437	186778
D2438	186780
D2439	186866
	197146
D2443	186482
D2446	186611
D2449	186563
D2451	186511
D2453	197148
D2454	186637
D2455	186272
D2456	186291
D2457	186488
D2458	197004
D2459	197223
D2460	186585
D2461	186685
D2467	186235
D2468	186235
D2476	197063
D2478	186628
D2479	197064
D2480	197065
	197162
D2485	197165
D2487	186719
D2489	186572
D2491	186570
D2493	186648
D2494	186823
D2497	186648
D2499	186813
D2500	186686
D2501	186705
D2502	186874
D2503	186587
D2504	186696
D2505	197170
D2507	186704
D2508	186765
D2509	197166
D2510	186766
D2512	186688
D2513	186600





 	
ROULUNDS (.../...)	
D2514	186759
D2515	186731
D2517	197195
D2518	186564
	186583
D2519	186682
D2523	186821
D2524	186577
D2525	197238
D2528	197207
D2529	197208
D2532	186278
D2533	186537
D2534	186590
D2535	186453
D2536	186454
D2537	197161
D2538	186810
D2541	197059
D2542	186566
D2544	186510
	186511
D2545	197167
D2546	186640
D2547	186638
D2549	186876
D2558	186859
D2559	197194
D2560	186841
D2561	197056
D2562	186788
D2563	197086
D2564	186801
D2565	186814
D2566	197016
D2567	186693
D2568	186695
D2569	186694
D2570	186702
D2571	186785
D2572	186791
D2573	186576
D2576	186762
D2577	186812
D2578	186781
D2580	186778
D2581	186699
D2582	186695
D2584	186809
D2587	186645
D2589	186736
D2590	186807
D2591	186758
D2592	186856
D2597	186839
D2598	197239
D2604	186804

 	
ROULUNDS (.../...)	
D2605	186894
	197003
D2606	186715
D2607	197221
D2609	186718
D2613	186709
D2614	186710
D2615	186757
D2616	186790
D2637	186642
	197017
D2638	186654
D2639	186753
D2642	186496
D2643	186653
D2644	197224
D2645	186827
D2647	186743
D2650	186720
D2651	197219
D2652	186724
D2653	186764
D2654	186754
TEXTAR	
407106	186140
408108	186768
410139	186226
410150	186117
410178	186114
410186	186424
410190	186146
410209	186290
412126	186274
413128	186202
413166	186768
413167	186118
420111	186203
420147	186163
421102	186234
421105	186438
422141	186145
424120	186277
425100	186495
426100	186296
520128	186247
522145	186265
525105	197222
92005400	186189
92005700	197004
92009200	186142
	186226
92009300	186249
92009500	186180
92010600	186245
92011400	186202
92011600	186115
	186116

 	
TEXTAR (.../...)	
92011900	186160
92012100	186246
92012900	186139
92013500	186110
92014300	186140
92014400	186128
92014900	186169
92015100	186171
92016400	186142
92017200	186218
92018600	186255
92019200	186117
92019300	186151
92019900	186171
	186172
92020300	186692
92020800	186186
92020900	186187
	186757
92022000	186771
92022100	186143
92022800	186453
92022900	186159
92023000	186158
92025900	186113
92026000	186112
92026100	186114
92026200	186273
92026300	186292
92026400	186118
92026500	186119
92026900	186135
92027000	186152
92027100	186202
	186205
92027300	186166
92027400	186176
92029600	186188
	186790
92029800	186199
	186200
92029900	186134
	186197
92031000	186257
92031300	186776
92031400	186256
92031800	186182
92031900	186185
92032000	186184
92032400	186424
92032700	186183
	186470
92032703	186183
	186470
92033100	186210
92033600	186103
92033800	186195

 	
TEXTAR (.../...)	
92034000	186150
92034200	186146
92034300	186156
	186571
92034400	186206
92034500	186157
92035100	186299
92035600	186479
92036000	186228
92036100	186230
	186803
92036200	186229
92036300	186224
92036400	186214
92036600	186374
92036800	186247
92037000	186770
92037200	186272
92037300	186114
92037900	186168
92038000	186192
92038100	186191
	186192
92038200	186190
92038500	186130
92038600	186177
92038900	186178
92039100	186173
92039200	186189
92039300	186625
92040400	186223
92040600	186283
92041400	186155
92041500	186154
	186155
92041700	186251
92041800	186288
92041803	186288
92042000	186302
92042100	186124
92042300	186125
92042303	186125
92042900	186136
92043100	186194
92043200	186196
92043500	186519
92043800	197114
92044100	186102
92044200	186149
92044400	186236
92044500	186613
92046300	186232
92046800	186265
92046900	186290
92047400	197165
92048100	186198
92048200	186199



 Valeo	
TEXTAR (.../...)	
92048500	186498
92049200	186231
92049300	186213
92049400	186219
92049500	186221
92050400	186696
92050600	186258
92050900	186162
92051000	186163
92051200	186263
92051300	186264
92051500	186225
92051600	186234
92052100	186148
92052900	186509
92053000	186770
92053200	186147
92053500	186266
92053800	186500
92054000	186131
92054200	186267
92054400	186145
92054500	186144
92054900	186208
92055000	186416
92055003	186416
92055200	186297
92055400	186289
92055500	186274
92055503	186274
92055600	186275
92055605	186275
92055700	186295
92055703	186295
92055800	186511
92055900	186314
92056000	186315
92056200	186301
92056300	186485
92056400	186487
92056500	186282
92056800	186465
92057000	186490
92057100	186313
92057200	186517
92057300	186460
92057400	186270
92057500	186294
92057503	186294
92057600	197222
92057605	197222
92057700	197225
92057800	186268
92057900	186461
92058000	186462
92058500	197218
92059300	186298



 Valeo	
TEXTAR (.../...)	
92059303	186298
92059400	186280
92059403	186280
92059500	186281
92059503	186281
92059600	186296
92059700	186586
92059900	186621
92060200	186185
92060400	186269
92060600	186291
92060700	186431
92060800	186435
92060900	186438
92061000	186405
92061100	186155
	186406
92061103	186155
	186406
92061300	186284
92061500	186449
92061600	186451
92061700	186452
92061800	186446
92061900	186455
92062000	186457
92062100	186458
92062600	186441
92062700	186617
92062800	186440
92063200	186482
92063300	186300
92063500	186277
92063600	186426
92064200	197094
92064300	186427
92064400	186428
92064500	186303
92064800	186304
92064900	186306
92065000	186305
92065100	186307
92065500	186510
92065600	186287
92065700	186530
92065800	186509
92066000	186504
92066200	186496
92066500	186454
92066600	186453
92066700	186526
92066703	186526
92066800	186528
92066803	186528
92067300	186276
92067700	186165
92067800	186520



 Valeo	
TEXTAR (.../...)	
92068200	186807
92068500	186153
92068600	186220
92068700	186567
92068800	186497
92068900	186652
92069000	186505
92069500	186652
92069600	186590
92069800	186299
92070000	186487
92070300	186768
92070400	186768
92070500	186285
92070600	186286
92070700	186508
92071400	197227
92071403	197227
92071600	186408
92071603	186408
92071900	186581
92071903	186581
92072000	186523
92072003	186523
92072100	186773
92072103	186773
92072300	186839
92072303	186839
92072400	186559
92072403	186559
92072500	186467
92072505	186467
92072700	186469
92072703	186469
92072800	186521
92072900	197124
92073000	186470
92073400	197033
92073600	187045
92073700	197217
92073800	186418
	197043
92073900	197131
	197228
92074000	186420
92074100	186421
92074200	197236
92074203	197236
92074300	186624
92074303	186624
92074400	186551
92074403	186551
92074500	186552
92074503	186552
92074600	186653
92074800	186563
92075000	186697



 Valeo	
TEXTAR (.../...)	
92075005	186697
92075100	186860
92075105	186860
92075300	186529
92075400	186401
92075500	186565
92075600	197226
92075700	186566
92075800	186488
92075900	186585
92076300	186547
	186640
92076400	186628
92076500	186875
92076600	186568
92076603	186568
92076800	186569
92077200	186701
92077400	197169
92077500	186822
	197148
	197169
92077600	197167
92077700	197166
92077703	197166
92077800	186433
92077900	186432
92078000	186286
92078100	186439
92078200	186699
92078600	186532
92078700	186533
92079400	186446
92079600	186665
92079700	186476
92079800	186719
92079900	186564
92080000	186654
92080200	186564
92080400	186637
92080500	186645
92080600	186638
92080700	186579
92080800	186514
92081100	186207
92081200	186775
92081400	186596
92081500	186436
	186439
92081600	186439
92082000	186503
92082100	186476
92082200	186603
92082203	186603
92082300	186604
92082305	186604
92082400	197230







	
TEXTAR (.../...)	
92082500	186597
92082503	186597
92082700	186640
92082800	186311
92082900	186648
92083100	186644
92083200	186643
92083500	186582
92083505	186582
92083600	186583
92083700	186725
92083703	186725
92083800	186682
92083803	186682
92087300	186612
92088000	186589
92088100	186278
92088200	186537
92088400	186425
92088403	186425
92088500	186773
92088503	186773
92089100	186599
92089400	186818
92089800	197059
92089803	197059
92090000	186753
92090003	186753
92090100	186620
92090200	186681
92090300	186571
92090400	186714
92090500	186511
92090800	186294
92090900	186576
92091000	186577
92091200	186562
92091203	186562
92091300	186573
92091303	186573
92091400	186585
	197223
92091500	197004
92091600	186685
92091700	186591
92091800	186592
92091803	186592
92091900	186684
92091903	186684
92092000	186594
92092003	186594
92092100	186593
92092103	186593
92092300	197056
92092600	186495
92092800	186598
92092803	186598



	
TEXTAR (.../...)	
92093100	186691
92093200	186827
92093300	186704
92093500	186686
92093600	197224
92093700	186572
92093800	186442
92093900	186443
92094300	197148
92094500	186611
92094600	186503
92095000	186664
92095200	186642
92096200	186163
	186560
92096203	186560
92096400	186605
92096500	186846
92096800	197063
92096900	186705
92096903	186705
92097100	197231
92097200	186815
92097205	186815
92097300	186861
92097305	186861
92097500	197229
92097600	186859
92097603	186859
92097700	186688
92097900	186874
92098100	186801
92098103	186801
92098200	186729
92098500	197246
92098600	197088
92098603	197088
92099600	186783
92099603	186783
92099700	186760
92099703	186760
92099800	186488
92100200	197009
92100300	186742
92100400	186707
92100500	186789
92100503	186789
92100600	186741
92100603	186741
92100700	186841
92100703	186841
92100900	186208
92101000	186778
92102600	186743
92102800	186777
92102900	186687
92103000	197161



	
TEXTAR (.../...)	
92103100	186810
92103200	186811
92103205	186811
92103400	186814
92103500	197016
92103600	186587
92103700	197108
92103800	186710
92103900	186648
92104100	197124
92104103	197124
92104400	197207
92105200	197033
92105300	187045
92105800	197011
92105803	197011
92105900	186467
	186864
92105903	186864
92106100	186758
92106105	186758
92106200	186807
92106203	186807
92106300	186856
92106303	186856
92106400	186788
92106500	186603
92106600	197230
92106603	197230
92106700	197198
92106705	197198
92106800	186888
92106900	186731
92106905	186731
92107000	186883
92107003	186883
92107100	186884
92107105	186884
92107200	186808
92107203	186808
92107300	186808
92107400	186809
92107403	186809
92107500	186762
92107503	186762
92107600	186812
92107605	186812
92107700	186745
92107703	186745
92107800	197220
92107900	186736
92108200	197233
92108300	197069
92108400	197022
92108700	186730
92109200	186781
92109300	186821

	
TEXTAR (.../...)	
92109400	186728
92109600	186750
92109700	186834
92109800	197239
92109803	197239
92109900	186800
92109903	186800
92110000	186709
92110003	186709
92110100	186780
92110300	186866
	197146
92110800	186784
92110803	186784
92110900	197244
92110903	197244
92111000	186791
92111003	186791
92111100	186759
92111103	186759
92111200	186740
92111300	186757
92111303	186757
92111400	186790
92111403	186790
92111500	186695
92111503	186695
92111600	186693
92111603	186693
92111700	186694
92111703	186694
92111800	186702
92111900	186703
92112000	186785
92112300	197240
92112700	186647
92113300	197163
92113600	197238
92113800	186600
92113900	186655
	186717
92113903	186655
92114700	186797
92114900	197206
92115000	197219
92115100	186751
92115105	186751
92115200	186751
92115205	186751
92115400	197035
92115405	197035
92115500	186865
92115505	186865
92115600	186766
92115700	186871
92115800	197137
92115900	186868



	
TEXTAR (.../...)	
92116000	186712
92116200	186708
92116600	186418
92116700	197228
92116800	197138
92116900	186454
92117100	197120
92117300	197032
92117303	197032
92117900	197157
92118000	186744
92118200	186724
92118300	186880
92118303	186880
92118400	186882
92118403	186882
92118500	186854
92118503	186854
92118600	186805
92118700	186881
92118703	186881
92118900	186715
92119000	197221
92119100	186718
92119200	186764
92119203	186764
92119300	186796
92119400	186804
92119500	186893
	186894
92119600	197136
92119700	197252
92119800	197200
92120500	197242
92120600	197197
92120700	186754
92120705	186754
92120800	186755
92120805	186755
92120900	186857
92120903	186857
92121000	197222
92121003	197222
92121100	186833
92121103	186833
92121200	186756
92121300	186885
92121303	186885
92121400	186886
92121403	186886
92121500	197087
92121505	197087
92121900	197243
92121903	197243
92122000	197090
92122005	197090
92122300	186582



	
TEXTAR (.../...)	
92122305	186582
92122500	186732
92122505	186732
92122600	197193
92122605	197193
92122700	197084
92122703	197084
92124400	186783
92124403	186783
92124500	197060
92124503	197060
92124600	186869
92124603	186869
92124700	186855
92124703	186855
92124800	186748
92124900	197013
92125000	197144
92125100	197104
92125300	197103
92125400	197014
92125500	197245
92125503	197245
92125600	186851
92125603	186851
92125800	186877
92126000	197171
92126100	186848
92126200	186847
92126300	197019
92126600	197057
92126603	197057
92128300	197086
92128500	197173
92128700	186845
92128800	186813
92129300	186869
92129303	186869
92129400	186746
92129500	197046
92129600	186747
92129700	197062
92130200	197020
92130300	186872
92130500	197021
92130800	186823
92131000	197172
92131200	197064
92131500	186774
92131503	186774
92131600	186712
	186713
92131800	186798
92131803	186798
92131900	186799
92131903	186799
92132000	197091



	
TEXTAR (.../...)	
92132003	197091
92132100	197036
92132103	197036
92132200	197052
92132205	197052
92132300	197199
92132305	197199
92132400	197142
92132405	197142
92132500	197125
92132503	197125
92132600	197140
92132603	197140
92132700	186816
92132703	186816
92132800	186817
92133000	197049
92133003	197049
92133200	197232
92133300	186840
92133700	186842
92133703	186842
92133800	186843
92133803	186843
92134000	197027
92134100	186879
92134500	197155
92134800	197214
92134803	197214
92134900	197129
92134903	197129
92135300	186805
92135303	186805
92135400	197166
92135403	197166
92135500	197072
92135503	197072
92135700	186849
92135703	186849
92135800	197168
92135900	186850
92135903	186850
92136400	186824
92136600	186829
92136800	197065
92137000	197038
92137003	197038
92137300	197071
92137500	197033
92137503	197033
92137600	187045
92137603	187045
92137700	197234
92137800	197073
92137900	197175
92137903	197175
92138500	197122



	
TEXTAR (.../...)	
92138600	197015
92139700	186765
92140700	197139
92140703	197139
92140800	197031
92140803	197031
92140900	197145
92141200	186819
92141203	186819
92141300	186863
92141303	186863
92141400	186720
92141500	197083
92141600	197251
92141603	197251
92141900	197047
92141903	197047
92142000	186876
92142003	186876
92142200	186718
92144100	197112
92144200	197018
92144203	197018
92144700	186878
92145000	197247
92145003	197247
92145100	197130
92145200	197098
92145203	197098
92145300	197132
	197134
92145303	197132
	197134
92145700	197044
92145703	197044
92145800	197045
92145803	197045
92145900	197008
92145903	197008
92146000	186295
92146003	186295
92146600	197153
92147100	197096
92147300	197210
92147400	197209
92147600	197156
92148500	197067
92148900	197066
92149100	197143
92149500	197241
92149800	197150
92149803	197150
92150600	197092
92150605	197092
92151800	197249
92151900	197054
92152000	187152





	
TEXTAR (.../...)	
92152200	186582
92153100	186570
92153700	186712
	186713
92153800	186517
92153900	186771
92154000	186768
92154100	186775
92154200	186288
92154203	186288
92154300	186773
92154500	186853
92154900	197158
92155300	197176
92156100	197147
92156200	197182
92156300	197113
92156400	197149
92156600	197135
92156900	197188
92157000	197133
92157100	197099
92157200	197248
92157400	197023
92157500	197097
92157600	197105
92157700	186717
92157905	197074
92158400	197070
92159200	197055
92159300	197101
92159600	197203
92160000	197196
92160100	197126
92161300	197029
92161600	197205
92161700	197123
92161900	197111
92162500	197102
92162700	197107
92163100	197128
92163103	197128
92163200	197202
92163203	197202
92163300	197127
92163700	197185
92163800	197183
92163900	197187
92164000	197109
92164100	197110
92164200	197184
92164900	197050
92165400	197190
92165500	197191
92166200	197174
92167000	197116
92167400	197164

	
TEXTAR (.../...)	
92167500	197106
92168000	197070
92168600	197100
92168700	197117
92174100	197017
92175100	186802
92175700	186894
	197003
93019400	186170
93042801	187029
93084400	186614
93089600	187040
93095100	187058
93104600	187147
93104700	187148
93104800	187149
93117600	187061
93123400	186890
93123500	186858
93127300	187130
93143200	187141
93143300	197030
93143400	187146
98200 0054	186189
98200 0092 0 1	186226
98200 0093 0 1	186249
98200 0095 0 1	186180
98200 0106 0 1	186245
98200 0114 0 1	186202
98200 0116 0 1	186115
	186116
98200 0119 0 1	186160
98200 0121 0 1	186246
98200 0129 0 1	186139
98200 0135 0 1	186110
98200 0143 0 1	186140
98200 0144 0 1	186128
98200 0149 0 1	186169
98200 0151 0 1	186171
98200 0164 0 1	186142
98200 0172 0 1	186218
98200 0186 0 1	186255
98200 0192 0 1	186117
98200 0193 0 1	186151
98200 0194 0 1	186170
98200 0199 0 1	186171
	186172
98200 0203 0 1	186692
98200 0208 0 1	186186
98200 0209 0 1	186187
98200 0220 0 1	186771
98200 0221 0 1	186143
98200 0229 0 1	186159
98200 0230 0 1	186158
98200 0259 0 1	186113
98200 0260 0 1	186112
98200 0261 0 1	186114

	
TEXTAR (.../...)	
98200 0262 0 1	186273
98200 0263 0 1	186292
98200 0264 0 1	186118
98200 0265 0 1	186119
98200 0269 0 1	186135
98200 0270 0 1	186152
98200 0271 0 1	186205
98200 0273 0 1	186166
98200 0274 0 1	186176
98200 0296 0 1	186188
98200 0298 0 1	186200
98200 0299 0 1	186134
	186197
98200 0310 0 1	186257
98200 0313 0 1	186776
98200 0314 0 1	186256
98200 0318 0 1	186182
98200 0319 0 1	186185
98200 0320 0 1	186184
98200 0324 0 1	186424
98200 0327 0 1	186183
	186470
98200 0331 0 1	186210
98200 0336 0 1	186103
98200 0338 0 1	186195
98200 0340 0 1	186150
98200 0342 0 1	186146
98200 0343 0 1	186156
98200 0344 0 1	186206
98200 0345 0 1	186157
98200 0351 0 1	186299
98200 0356 0 1	186479
98200 0360 0 1	186228
98200 0361 0 1	186230
	186803
98200 0362 0 1	186229
98200 0363 0 1	186224
98200 0364 0 1	186214
98200 0366 0 1	186374
98200 0368 0 1	186247
98200 0370 0 1	186770
98200 0372 0 1	186272
98200 0373 0 1	186114
98200 0379 0 1	186168
98200 0380 0 1	186192
98200 0381 0 1	186191
98200 0382 0 1	186190
98200 0385 0 1	186130
98200 0386 0 1	186177
98200 0389 0 1	186178
98200 0391 0 1	186173
98200 0392 0 1	186189
98200 0393 0 1	186625
98200 0404 0 1	186223
98200 0406 0 1	186283
98200 0414 0 1	186155
98200 0415 0 1	186154

	
TEXTAR (.../...)	
98200 0417 0 1	186251
98200 0418 0 1	186288
98200 0420 0 1	186302
98200 0421 0 1	186124
98200 0423 0 1	186125
98200 0428 0 1	187029
98200 0429 0 1	186136
98200 0431 0 1	186194
98200 0432 0 1	186196
98200 0435 0 1	186519
98200 0441 0 1	186102
98200 0442 0 1	186149
98200 0444 0 1	186236
98200 0445 0 1	186613
98200 0463 0 1	186232
98200 0468 0 1	186265
98200 0469 0 1	186290
98200 0474 0 1	197165
98200 0481 0 1	186198
98200 0482 0 1	186199
98200 0485 0 1	186498
98200 0492 0 1	186231
98200 0493 0 1	186213
98200 0494 0 1	186219
98200 0495 0 1	186221
98200 0504 0 1	186696
98200 0509 0 1	186162
98200 0510 0 1	186163
98200 0512 0 1	186263
98200 0513 0 1	186264
98200 0515 0 1	186225
98200 0516 0 1	186234
98200 0521 0 1	186148
98200 0529 0 1	186509
98200 0530 0 1	186770
98200 0532 0 1	186147
98200 0535 0 1	186266
98200 0538 0 1	186500
98200 0540 0 1	186131
98200 0542 0 1	186267
98200 0544 0 1	186145
98200 0545 0 1	186144
98200 0549 0 1	186208
98200 0550 0 1	186416
98200 0552 0 1	186297
98200 0554 0 1	186289
98200 0555 0 1	186274
98200 0556 0 1	186275
98200 0557 0 1	186295
98200 0558 0 1	186511
98200 0559 0 1	186314
98200 0560 0 1	186315
98200 0562 0 1	186301
98200 0563 0 1	186485
98200 0564 0 1	186487
98200 0565 0 1	186282
98200 0568 0 1	186465



 Valeo	
TEXTAR (.../...)	
98200 0570 0 1	186490
98200 0571 0 1	186313
98200 0572 0 1	186517
98200 0573 0 1	186460
98200 0574 0 1	186270
98200 0575 0 1	186294
98200 0576 0 1	197222
98200 0577 0 1	197225
98200 0578 0 1	186268
98200 0579 0 1	186461
98200 0580 0 1	186462
98200 0585 0 1	197218
98200 0593 0 1	186298
98200 0594 0 1	186280
98200 0595 0 1	186281
98200 0596 0 1	186296
98200 0597 0 1	186586
98200 0599 0 1	186621
98200 0602 0 1	186185
98200 0604 0 1	186269
98200 0606 0 1	186291
98200 0607 0 1	186431
98200 0608 0 1	186435
98200 0609 0 1	186438
98200 0610 0 1	186405
98200 0611 0 1	186155
	186406
98200 0613 0 1	186284
98200 0615 0 1	186449
98200 0616 0 1	186451
98200 0617 0 1	186452
98200 0618 0 1	186446
98200 0619 0 1	186455
98200 0620 0 1	186457
98200 0621 0 1	186458
98200 0626 0 1	186441
98200 0627 0 1	186617
98200 0628 0 1	186440
98200 0632 0 1	186482
98200 0633 0 1	186300
98200 0635 0 1	186277
98200 0636 0 1	186426
98200 0642 0 1	197094
98200 0643 0 1	186427
98200 0644 0 1	186428
98200 0645 0 1	186303
98200 0648 0 1	186304
98200 0649 0 1	186306
98200 0650 0 1	186305
98200 0651 0 1	186307
98200 0655 0 1	186510
98200 0656 0 1	186287
98200 0657 0 1	186530
98200 0660 0 1	186504
98200 0662 0 1	186496
98200 0666 0 1	186453
98200 0667 0 1	186526



 Valeo	
TEXTAR (.../...)	
98200 0668 0 1	186528
98200 0673 0 1	186276
98200 0677 0 1	186165
98200 0678 0 1	186520
98200 0682 0 1	186807
98200 0685 0 1	186153
98200 0686 0 1	186220
98200 0687 0 1	186567
98200 0688 0 1	186497
98200 0689 0 1	186652
98200 0690 0 1	186505
98200 0695 0 1	186652
98200 0696 0 1	186590
98200 0698 0 1	186299
98200 0703 0 1	186768
98200 0704 0 1	186768
98200 0705 0 1	186285
98200 0706 0 1	186286
98200 0707 0 1	186508
98200 0714 0 1	197227
98200 0716 0 1	186408
98200 0719 0 1	186581
98200 0720 0 1	186523
98200 0721 0 1	186773
98200 0723 0 1	186839
98200 0724 0 1	186559
98200 0725 0 1	186467
98200 0727 0 1	186469
98200 0728 0 1	186521
98200 0730 0 1	186470
98200 0734 0 1	197033
98200 0736 0 1	187045
98200 0737 0 1	197217
98200 0738 0 1	186418
	197043
98200 0739 0 1	197131
	197228
98200 0740 0 1	186420
98200 0741 0 1	186421
98200 0742 0 1	197236
98200 0743 0 1	186624
98200 0744 0 1	186551
98200 0745 0 1	186552
98200 0746 0 1	186653
98200 0748 0 1	186563
98200 0750 0 1	186697
98200 0751 0 1	186860
98200 0753 0 1	186529
98200 0754 0 1	186401
98200 0755 0 1	186565
98200 0756 0 1	197226
98200 0757 0 1	186566
98200 0758 0 1	186488
98200 0759 0 1	186585
98200 0763 0 1	186547
98200 0764 0 1	186628
98200 0765 0 1	186875



 Valeo	
TEXTAR (.../...)	
98200 0766 0 1	186568
98200 0768 0 1	186569
98200 0772 0 1	186701
98200 0774 0 1	197169
98200 0775 0 1	186822
98200 0776 0 1	197167
98200 0777 0 1	197166
98200 0778 0 1	186433
98200 0779 0 1	186432
98200 0780 0 1	186286
98200 0781 0 1	186439
98200 0782 0 1	186699
98200 0786 0 1	186532
98200 0787 0 1	186533
98200 0794 0 1	186446
98200 0796 0 1	186665
98200 0797 0 1	186476
98200 0798 0 1	186719
98200 0799 0 1	186564
98200 0800 0 1	186654
98200 0802 0 1	186564
98200 0804 0 1	186637
98200 0805 0 1	186645
98200 0806 0 1	186638
98200 0807 0 1	186579
98200 0808 0 1	186514
98200 0811 0 1	186207
98200 0812 0 1	186775
98200 0814 0 1	186596
98200 0815 0 1	186436
	186439
98200 0816 0 1	186439
98200 0820 0 1	186503
98200 0821 0 1	186476
98200 0822 0 1	186603
98200 0823 0 1	186604
98200 0824 0 1	197230
98200 0825 0 1	186597
98200 0827 0 1	186640
98200 0828 0 1	186311
98200 0829 0 1	186648
98200 0831 0 1	186644
98200 0832 0 1	186643
98200 0835 0 1	186582
98200 0836 0 1	186583
98200 0837 0 1	186725
98200 0838 0 1	186682
98200 0844 0 1	186614
98200 0873 0 1	186612
98200 0880 0 1	186589
98200 0881 0 1	186278
98200 0882 0 1	186537
98200 0884 0 1	186425
98200 0885 0 1	186773
98200 0891 0 1	186599
98200 0894 0 1	186818
98200 0896 0 1	187040



 Valeo	
TEXTAR (.../...)	
98200 0898 0 1	197059
98200 0900 0 1	186753
98200 0901 0 1	186620
98200 0902 0 1	186681
98200 0903 0 1	186571
98200 0904 0 1	186714
98200 0908 0 1	186294
98200 0909 0 1	186576
98200 0910 0 1	186577
98200 0912 0 1	186562
98200 0913 0 1	186573
98200 0914 0 1	197223
98200 0915 0 1	197004
98200 0916 0 1	186685
98200 0917 0 1	186591
98200 0918 0 1	186592
98200 0919 0 1	186684
98200 0920 0 1	186594
98200 0921 0 1	186593
98200 0923 0 1	197056
98200 0926 0 1	186495
98200 0928 0 1	186598
98200 0931 0 1	186691
98200 0932 0 1	186827
98200 0933 0 1	186704
98200 0935 0 1	186686
98200 0936 0 1	197224
98200 0937 0 1	186572
98200 0938 0 1	186442
98200 0939 0 1	186443
98200 0943 0 1	197148
98200 0945 0 1	186611
98200 0946 0 1	186503
98200 0950 0 1	186664
98200 0951 0 1	187058
98200 0952 0 1	186642
98200 0962 0 1	186560
98200 0964 0 1	186605
98200 0965 0 1	186846
98200 0968 0 1	197063
98200 0969 0 1	186705
98200 0971 0 1	197231
98200 0972 0 1	186815
98200 0973 0 1	186861
98200 0975 0 1	197229
98200 0976 0 1	186859
98200 0977 0 1	186688
98200 0979 0 1	186874
98200 0981 0 1	186801
98200 0982 0 1	186729
98200 0985 0 1	197246
98200 0986 0 1	197088
98200 0996 0 1	186783
98200 0997 0 1	186760
98200 0998 0 1	186488
98200 1002 0 1	197009
98200 1003 0 1	186742





	
TEXTAR (.../...)	
98200 1004 0 1	186707
98200 1005 0 1	186789
98200 1006 0 1	186741
98200 1007 0 1	186841
98200 1009 0 1	186208
98200 1010 0 1	186778
98200 1026 0 1	186743
98200 1028 0 1	186777
98200 1029 0 1	186687
98200 1030 0 1	197161
98200 1031 0 1	186810
98200 1032 0 1	186811
98200 1034 0 1	186814
98200 1035 0 1	197016
98200 1036 0 1	186587
98200 1037 0 1	197108
98200 1038 0 1	186710
98200 1039 0 1	186648
98200 1041 0 1	197124
98200 1044 0 1	197207
98200 1046 0 1	187147
98200 1047 0 1	187148
98200 1048 0 1	187149
98200 1052 0 1	197033
98200 1058 0 1	197011
98200 1059 0 1	186864
98200 1061 0 1	186758
98200 1062 0 1	186807
98200 1063 0 1	186856
98200 1064 0 1	186788
98200 1065 0 1	186603
98200 1066 0 1	197230
98200 1067 0 1	197198
98200 1068 0 1	186888
98200 1069 0 1	186731
98200 1070 0 1	186883
98200 1071 0 1	186884
98200 1072 0 1	186808
98200 1073 0 1	186808
98200 1074 0 1	186809
98200 1075 0 1	186762
98200 1076 0 1	186812
98200 1077 0 1	186745
98200 1078 0 1	197220
98200 1079 0 1	186736
98200 1082 0 1	197233
98200 1083 0 1	197069
98200 1084 0 1	197022
98200 1087 0 1	186730
98200 1092 0 1	186781
98200 1093 0 1	186821
98200 1094 0 1	186728
98200 1096 0 1	186750
98200 1097 0 1	186834
98200 1098 0 1	197239
98200 1099 0 1	186800
98200 1100 0 1	186709

	
TEXTAR (.../...)	
98200 1101 0 1	186780
98200 1103 0 1	186866
	197146
98200 1108 0 1	186784
98200 1109 0 1	197244
98200 1110 0 1	186791
98200 1111 0 1	186759
98200 1112 0 1	186740
98200 1113 0 1	186757
98200 1114 0 1	186790
98200 1115 0 1	186695
98200 1116 0 1	186693
98200 1117 0 1	186694
98200 1118 0 1	186702
98200 1119 0 1	186703
98200 1120 0 1	186785
98200 1123 0 1	197240
98200 1127 0 1	186647
98200 1133 0 1	197163
98200 1136 0 1	197238
98200 1138 0 1	186600
98200 1139 0 1	186655
98200 1147 0 1	186797
98200 1149 0 1	197206
98200 1150 0 1	197219
98200 1151 0 1	186751
98200 1152 0 1	186751
98200 1154 0 1	197035
98200 1155 0 1	186865
98200 1156 0 1	186766
98200 1157 0 1	186871
98200 1158 0 1	197137
98200 1159 0 1	186868
98200 1160 0 1	186712
98200 1162 0 1	186708
98200 1166 0 1	186418
98200 1168 0 1	197138
98200 1169 0 1	186454
98200 1171 0 1	197120
98200 1173 0 1	197032
98200 1176 0 1	187061
98200 1179 0 1	197157
98200 1180 0 1	186744
98200 1182 0 1	186724
98200 1183 0 1	186880
98200 1184 0 1	186882
98200 1185 0 1	186854
98200 1186 0 1	186805
98200 1187 0 1	186881
98200 1189 0 1	186715
98200 1190 0 1	197221
98200 1191 0 1	186718
98200 1192 0 1	186764
98200 1193 0 1	186796
98200 1194 0 1	186804
98200 1195 0 1	186893
	186894

	
TEXTAR (.../...)	
98200 1196 0 1	197136
98200 1197 0 1	197252
98200 1198 0 1	197200
98200 1205 0 1	197242
98200 1206 0 1	197197
98200 1207 0 1	186754
98200 1208 0 1	186755
98200 1209 0 1	186857
98200 1210 0 1	197222
98200 1211 0 1	186833
98200 1212 0 1	186756
98200 1213 0 1	186885
98200 1214 0 1	186886
98200 1215 0 1	197087
98200 1219 0 1	197243
98200 1220 0 1	197090
98200 1223 0 1	186582
98200 1225 0 1	186732
98200 1226 0 1	197193
98200 1227 0 1	197084
98200 1234 0 1	186890
98200 1235 0 1	186858
98200 1244 0 1	186783
98200 1245 0 1	197060
98200 1246 0 1	186869
98200 1247 0 1	186855
98200 1248 0 1	186748
98200 1249 0 1	197013
98200 1250 0 1	197144
98200 1251 0 1	197104
98200 1253 0 1	197103
98200 1254 0 1	197014
98200 1255 0 1	197245
98200 1256 0 1	186851
98200 1258 0 1	186877
98200 1260 0 1	197171
98200 1261 0 1	186848
98200 1262 0 1	186847
98200 1263 0 1	197019
98200 1266 0 1	197057
98200 1273 0 1	187130
98200 1283 0 1	197086
98200 1285 0 1	197173
98200 1288 0 1	186813
98200 1293 0 1	186869
98200 1294 0 1	186746
98200 1295 0 1	197046
98200 1296 0 1	186747
98200 1297 0 1	197062
98200 1302 0 1	197020
98200 1303 0 1	186872
98200 1305 0 1	197021
98200 1308 0 1	186823
98200 1310 0 1	197172
98200 1312 0 1	197064
98200 1315 0 1	186774
98200 1316 0 1	186712
	186713

	
TEXTAR (.../...)	
98200 1318 0 1	186798
98200 1319 0 1	186799
98200 1320 0 1	197091
98200 1321 0 1	197036
98200 1322 0 1	197052
98200 1323 0 1	197199
98200 1324 0 1	197142
98200 1325 0 1	197125
98200 1326 0 1	197140
98200 1327 0 1	186816
98200 1328 0 1	186817
98200 1330 0 1	197049
98200 1332 0 1	197232
98200 1333 0 1	186840
98200 1337 0 1	186842
98200 1338 0 1	186843
98200 1340 0 1	197027
98200 1341 0 1	186879
98200 1345 0 1	197155
98200 1348 0 1	197214
98200 1349 0 1	197129
98200 1353 0 1	186805
98200 1354 0 1	197166
98200 1355 0 1	197072
98200 1357 0 1	186849
98200 1358 0 1	197168
98200 1359 0 1	186850
98200 1364 0 1	186824
98200 1366 0 1	186829
98200 1368 0 1	197065
98200 1370 0 1	197038
98200 1373 0 1	197071
98200 1375 0 1	197033
98200 1376 0 1	187045
98200 1377 0 1	197234
98200 1378 0 1	197073
98200 1379 0 1	197175
98200 1385 0 1	197122
98200 1386 0 1	197015
98200 1397 0 1	186765
98200 1408 0 1	197031
98200 1409 0 1	197145
98200 1412 0 1	186819
98200 1413 0 1	186863
98200 1414 0 1	186720
98200 1415 0 1	197083
98200 1416 0 1	197251
98200 1419 0 1	197047
98200 1420 0 1	186876
98200 1422 0 1	186718
98200 1432 0 1	187141
98200 1433 0 1	197030
98200 1434 0 1	187146
98200 1441 0 1	197112
98200 1442 0 1	197018
98200 1447 0 1	186878
98200 1450 0 1	197247



 Valeo	
TEXTAR (.../...)	
98200 1451 0 1	197130
98200 1452 0 1	197098
98200 1453 0 1	197132
	197134
98200 1457 0 1	197044
98200 1458 0 1	197045
98200 1459 0 1	197008
98200 1460 0 1	186295
98200 1466 0 1	197153
98200 1471 0 1	197096
98200 1473 0 1	197210
98200 1474 0 1	197209
98200 1476 0 1	197156
98200 1485 0 1	197067
98200 1489 0 1	197066
98200 1491 0 1	197143
98200 1495 0 1	197241
98200 1498 0 1	197150
98200 1506 0 1	197092
98200 1518 0 1	197249
98200 1519 0 1	197054
98200 1520 0 1	187152
98200 1522 0 1	186582
98200 1531 0 1	186570
98200 1537 0 1	186712
	186713
98200 1538 0 1	186517
98200 1539 0 1	186771
98200 1540 0 1	186768
98200 1541 0 1	186775
98200 1542 0 1	186288
98200 1543 0 1	186773
98200 1545 0 1	186853
98200 1549 0 1	197158
98200 1561 0 1	197147
98200 1562 0 1	197182
98200 1563 0 1	197113
98200 1566 0 1	197135
98200 1569 0 1	197188
98200 1570 0 1	197133
98200 1571 0 1	197099
98200 1572 0 1	197248
98200 1574 0 1	197023
98200 1575 0 1	197097
98200 1576 0 1	197105
98200 1577 0 1	186717
98200 1579 0 1	197074
98200 1584 0 1	197070
98200 1592 0 1	197055
98200 1593 0 1	197101
98200 1596 0 1	197203
98200 1600 0 1	197196
98200 1601 0 1	197126
98200 1613 0 1	197029
98200 1616 0 1	197205
98200 1617 0 1	197123
98200 1619 0 1	197111



 Valeo	
TEXTAR (.../...)	
98200 1625 0 1	197102
98200 1627 0 1	197107
98200 1631 0 1	197128
98200 1632 0 1	197202
98200 1633 0 1	197127
98200 1637 0 1	197185
98200 1638 0 1	197183
98200 1639 0 1	197187
98200 1640 0 1	197109
98200 1641 0 1	197110
98200 1642 0 1	197184
98200 1649 0 1	197050
98200 1654 0 1	197190
98200 1655 0 1	197191
98200 1662 0 1	197174
98200 1670 0 1	197116
98200 1674 0 1	197164
98200 1675 0 1	197106
98200 1680 0 1	197070
98200 1686 0 1	197100
98200 1741 0 1	197017
98200 1751 0 1	186802
98200 1757 0 1	186894
	197003
TRW	
DF1001	186142
DF1002	186218
DF1005	186226
DF1010	186211
DF1012	186210
DF1013	186230
DF1013BP	186230
DF1015	186228
DF1016	186229
DF1016BP	186229
DF1017	186214
DF1018	186213
DF1019	186221
DF1020	186224
DF1021	186220
DF1022	186223
DF1023	186231
DF1025	186276
DF1026	186567
DF1027	186596
DF1029	186306
	186307
DF1030	186306
DF1031	186214
	186225
DF1032	186304
	186655
DF1032BP	186304
	186655
DF1033	186600
DF1036	186305



 Valeo	
TRW (.../...)	
DF1104	186137
DF1107	186128
DF1109	186140
DF1113	186143
DF1114	186205
DF1115	186139
DF1117	186135
DF1118	186206
DF1119	186136
DF1120	186130
DF1122	186586
DF1123	186296
DF1203	186202
DF1209	186207
DF1210	186196
	186203
DF1215	186197
DF1216	186134
DF1217	186200
DF1218	186195
DF1220	186198
DF1220BP	186198
DF1221	186194
DF1222	186145
DF1223	186131
DF1224	186196
DF1225	186303
DF1300	186240
DF1400	186299
DF1406	186487
DF1409	186510
	186511
DF1416	186664
DF1418	186547
DF1422	186665
DF1423	186511
DF1428	186617
DF1430	197167
DF1431	197166
DF1435	186621
DF1436	186433
DF1439	186508
DF1443	186648
DF1516	186245
DF1517	186246
DF1517BP	186246
DF1518	186249
DF1521	186113
DF1524S	186771
DF1526	186114
DF1529	186288
DF1529BP	186288
DF1530	186112
DF1530BP	186112
DF1531	186273
DF1532	186251
DF1532BP	186251



 Valeo	
TRW (.../...)	
DF1533	186247
DF1533BP	186247
DF1534	186770
DF1536	186292
DF1537	186274
DF1537BP	186274
DF1538	186275
DF1539	186295
DF1540	186517
DF1540BP	186517
DF1541	186520
DF1544	186770
DF1553	186115
DF1560	186116
DF1561	186117
DF1569	186118
DF1573	186180
DF1581	186182
DF1583	186184
DF1584	186176
DF1585	186185
DF1593	186314
DF1594	186461
DF1595	186462
DF1596	186315
DF1598	186460
DF1599	186692
DF1607	186186
DF1608	186187
DF1608BP	186187
DF1609	186188
DF1612	186192
DF1613	186190
DF1614	186191
DF1619	197004
DF1620	186159
DF1621	186302
DF1622	186278
DF1624	186282
DF1625	186189
DF1627	186500
DF1630	186160
DF1642	186169
DF1647	186165
DF1648	186165
DF1649	186159
DF1651	186424
DF1652	186158
DF1653	186168
DF1654	186425
DF1655	186166
DF1658	186162
DF1662	186530
DF1669	186498
DF1674	186256
DF1679	186257
DF1683	186776







 	
TRW (.../...)	
DF1683S	186776
DF1686	186254
DF1687	186255
DF1688	186264
DF1689	186263
DF1694	186625
DF1696	186311
DF1697	186289
DF1708	186110
DF1716	186103
DF1721	186151
DF1722	186501
DF1723	186171
DF1725	186172
DF1726S	186170
DF1727	186152
DF1734	186102
DF1736	186156
DF1739	186290
DF1740	186155
	186406
DF1742	186149
DF1743	186148
DF1744	186147
DF1745	186155
	186406
DF1747	186154
DF1747BP	186154
DF1748	186173
DF1749	186265
DF1757	186297
DF1758S	186614
DF1763S	187029
DF1769	186405
DF1788	186150
DF1790	186146
	186147
DF1791	186157
DF1802	186310
DF1803	186284
DF1807	186285
DF1810	186232
DF1811	186234
DF1812	186235
DF1828	186236
DF1829	186613
DF1833	186283
DF1856	186495
DF1925	197114
DF1927	186696
DF1953	186374
DF1956	186234
DF1958	186441
DF1963	186431
DF1967	186479
DF2001	186607
DF2002	186611



 	
TRW (.../...)	
DF2008S	186612
DF2011	186219
DF2012	186287
DF2024	186436
	186439
DF2550	186119
DF2550BP	186119
DF2555	186124
DF2557	186125
DF2563	186183
DF2564	186258
DF2566	186266
DF2571	186455
DF2573	186235
DF2575	186440
DF2576	186482
DF2579	186178
DF2579S	186178
DF2580	186199
DF2581	186196
	186416
DF2582	186204
DF2583	186144
DF2586	186208
DF2587	186770
DF2588	186504
DF2590	186301
DF2591	186485
DF2592	186487
DF2596	186465
DF2597	186269
DF2598	186268
DF2599	186267
DF2601	186291
DF2606	186446
DF2607	186446
DF2609	197165
DF2611	186300
DF2614	186490
DF2619	186313
DF2622	186277
DF2623	186426
DF2626	186272
DF2631	186519
DF2639	186428
DF2645	197225
DF2646	186435
DF2647	186428
DF2650	186270
DF2651	186294
DF2652	197222
DF2652BP	197222
DF2653	186281
DF2654	186298
DF2655	186807
DF2656	186280
DF2657	186432
	186435



 	
TRW (.../...)	
DF2658	186701
DF2660	186528
DF2662	186454
DF2665	197218
DF2667	186114
DF2668	186453
DF2671	186526
DF2674	186640
DF2678	186570
	186730
DF2679	186439
DF2681	186496
DF2682	186427
DF2683	197169
DF2684	197148
DF2686	186153
DF2687	197227
DF2688	186497
DF2702	186451
DF2703	186452
DF2704	186457
DF2705	186458
DF2706	186768
	186775
DF2708S	186775
DF2709S	186768
DF2715	186421
DF2716	186420
DF2717	186286
DF2719	186449
DF2721	186418
DF2722	197228
DF2723	186638
DF2726	186299
DF2728	197217
DF2729S	186775
DF2730	186408
DF2734	186590
DF2742	186822
DF2751	186401
DF2752	186529
DF2753	186163
DF2753BP	186163
DF2754	186589
DF2755	186581
DF2757	186470
DF2758	186521
DF2759	186643
DF2760	186442
DF2761	186420
	186443
DF2765	186681
DF2766	197224
DF2767	186559
DF2768	186568
DF2769	186697
DF2771	186773

 	
TRW (.../...)	
DF2772	186565
DF2773	186566
DF2775	186714
DF2776	197236
DF2777	186624
DF2778S	197226
DF2779	186467
DF2780	186523
DF2781	186579
DF2782	186532
DF2783	186860
DF2784	186647
DF2784BP	186647
DF2785	186537
DF2786	186278
DF2787	187040
DF2788S	187058
DF2790	186774
DF2791S	186642
DF2792	186620
DF2794	186552
DF2795	186585
DF2796	186533
DF2797	186551
DF2798	186648
DF2799	186569
DF2803	186603
DF2803BP	186603
DF2804	186604
DF2804BP	186604
DF2805	186597
DF2805BP	186597
DF2806	186582
DF2808	186599
DF2809	186314
	186682
DF2810	186725
DF2813	186469
DF2814	186177
DF2815	186598
DF3018	186564
DF3021	186438
DF3027	186645
DF3028	186514
DF3031	186653
DF3032	186505
DF3035	186637
DF3037	186509
	186696
DF3049	186488
DF3084	186439
DF3092	186503
DF3093	186652
DF3095	186476
DF3109	186699
DF3112	186563
DF3115	186652



 	
TRW (.../...)	
DF3118	186719
DF3119	186572
DF3165	186628
DF4000	186564
DF4004	186435
DF4006	186654
DF4007	186875
DF4018	186577
DF4019	186576
DF4022	186818
DF4025	186605
DF4026	186773
DF4027	197230
DF4028	186778
DF4029	197223
DF4030	186685
DF4032	186648
DF4034	186562
DF4035	186573
DF4036	186560
DF4037	186571
DF4038	186294
DF4039	197032
DF4041	197004
DF4042	186592
DF4042BP	186592
DF4043	186591
DF4045	186583
DF4046	186705
DF4048	186684
DF4049	186488
DF4050	186594
DF4051	186593
DF4052	197011
DF4053S	186741
DF4054	186707
DF4054BP	186707
DF4055	186815
DF4059	197229
DF4062	186729
DF4064	197246
DF4065	197088
DF4066	186841
DF4069	186861
DF4070	197108
DF4075	186691
DF4081	186648
DF4082	186647
DF4087	197033
DF4087S	197033
DF4088S	187045
DF4089	197059
DF4089S	197059
DF4093	186686
DF4100	186876
DF4103	186687
DF4108	186781



 	
TRW (.../...)	
DF4109	186600
DF4110	186655
DF4111	186688
DF4112	186587
DF4113	186874
DF4115	186704
DF4117	186827
DF4119	186810
DF4120	197161
DF4121	197063
DF4122	197120
DF4123	186742
DF4126	197124
DF4130	186785
DF4131	186784
DF4132	186777
DF4133	197122
DF4135	186859
DF4141	197220
DF4142	186702
DF4147	186750
DF4151	186780
DF4152	186866
	197146
DF4153	186637
DF4155	197064
DF4156	197162
DF4158	186823
DF4159	186813
DF4160	197170
DF4161	186765
DF4163	186766
DF4164	186600
DF4165	186759
DF4166	186731
DF4168	197195
DF4169	186821
DF4170	197238
DF4172	197207
DF4173	197208
DF4179	186715
DF4180	186864
DF4182	197194
DF4182S	197194
DF4183	186693
DF4183BP	186693
DF4184	186695
DF4184BP	186695
DF4185	186694
DF4186	186807
DF4187	186808
DF4187S	186808
DF4189	186809
DF4190	186734
DF4191	186432
DF4194S	197062
DF4195	186753

 	
TRW (.../...)	
DF4197	186762
DF4198	186812
DF4200	186791
DF4202	186814
DF4203	197016
DF4204	197168
DF4205	186788
DF4208	186801
DF4209	197198
DF4209S	197198
DF4211	186856
DF4212	186883
DF4213	186839
DF4215	186736
DF4216	186709
DF4217	186710
DF4218	186834
DF4220	197137
DF4221	186871
DF4222	186811
DF4222S	186811
DF4223	186760
DF4224	197060
DF4225	186757
DF4226	197231
DF4227	186718
DF4227BS	186718
DF4228	186894
DF4229	197221
DF4229S	197221
DF4230	197240
DF4231	186804
DF4231S	186804
DF4232	197086
DF4233	197056
DF4234	186740
DF4235	186603
DF4236	186790
DF4237	186703
DF4237S	186703
DF4238	186789
DF4240	186845
DF4245	186708
DF4246	197244
DF4246BP	197244
DF4248	186884
DF4248S	186884
DF4249S	186868
DF4253	186888
DF4255	186655
DF4256	186724
DF4257	197219
DF4258S	197198
DF4259S	186717
DF4260S	197079
DF4261	186751
DF4262S	186758



 	
TRW (.../...)	
DF4263	197035
DF4265	186880
DF4265S	186880
DF4266	186854
DF4267	186764
DF4270	186865
DF4271	186833
DF4272	186720
DF4272BS	186720
DF4273	186713
DF4273BS	186713
DF4273S	186713
DF4274	186796
DF4275S	186712
DF4276	186857
DF4277	186748
DF4278	197020
DF4279	197009
DF4280S	186804
DF4281	197121
DF4284	186882
DF4287	197027
DF4288	197144
DF4291	197172
DF4293	186881
DF4294	186754
DF4295	186755
DF4300	186258
DF4301	186311
DF4306S	197087
DF4308S	186756
DF4309S	186885
DF4310S	186800
DF4312	186886
DF4313	186863
DF4314	186819
DF4315	197163
DF4316	186728
DF4318	186869
DF4321	186774
DF4322	186783
DF4323	197239
DF4331	187061
DF4335	186847
DF4336	197022
DF4337	197050
DF4339	197057
DF4344	186855
DF4346	197233
DF4350S	197197
DF4351	186747
DF4352	197089
DF4356	186858
DF4358	197199
DF4358S	197199
DF4359	186732
DF4360	197084



 → 	
TRW (.../...)	
DF4361	197193
DF4362	186746
DF4363	197232
DF4364	186764
DF4367	186877
DF4369	186813
DF4371	197241
DF4372	186842
DF4373	186890
DF4375	186744
DF4376	186805
DF4377	186745
DF4379	186848
DF4381	186802
DF4382	186803
DF4383	186798
DF4384	186872
DF4386	197245
DF4392S	197083
DF4393	186799
DF4394	197209
DF4395	197210
DF4401	197014
DF4402	197103
DF4404	197019
DF4407	186844
	197013
DF4409	186878
DF4412	197166
DF4413	186893
DF4413BS	186893
DF4414	186853
DF4416	197072
DF4417	186849
DF4419	197021
DF4422	186843
DF4424	186863
DF4425	186843
DF4426	186869
DF4429	197153
DF4432	197145
DF4433	197046
DF4434	197125
DF4440	186797
DF4441	197112
DF4442	186851
DF4443	186824
DF4445	197070
DF4447	186816
DF4449	186817
DF4450	197049
DF4452	186840
DF4452BS	186840
DF4453	197036
DF4454	197091
DF4457	197214
DF4458	197096

 → 	
TRW (.../...)	
DF4459	197234
DF4460	197073
DF4461	197175
DF4461S	197175
DF4463	197129
DF4464	197242
DF4465	186819
DF4469	197047
DF4470	197052
DF4471	197092
DF4471S	197092
DF4474	197129
DF4476	197247
DF4477	197098
DF4478	197130
DF4479	197132
DF4480	186850
DF4487	197090
DF4494	197071
DF4496	197173
DF4505	186743
DF4508	186730
DF4531	186652
DF4534	197016
DF4542	186728
DF4547	186743
DF4548	186564
DF4550	197069
DF4554	197252
DF4558	197031
DF4561	197018
DF4573	186876
DF4690	186720
DF4690BS	186720
DF4691	186786
DF4692	197044
DF4693	197138
DF4695	197142
DF4698	186825
DF4704	197214
DF4710	186829
DF4713	197104
DF4714	197015
DF4718	197243
DF4737	197045
DF4750	197105
DF4754	197139
DF4796	197044

 → 	

 → 	

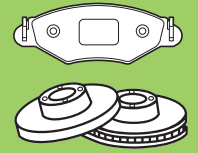
**Pads and Discs**

Plaquettes et Disques

Pastillas y Discos

Pastilas e Discos

Pastiglie e Dischi

Blokjes en Schijven

Bremsbeläge und Bremsscheiben

Klocki i Tarcze

Balatalari ve Diskleri

Колодки и диски

Δισκόφρενα & Δισκόπλακες

刹车片和刹车盘

بطانات و قرص



 Valeo	
ABARTH	
77363958	598721
77363959	598722
77364961	598425
77365113	598721
ALFA ROMEO	
0000794962	598219
0005893947	598008
0005893948	598005
0005895983	598135
00071712910	598581
00077362276	598407
00077362346	598006
00077362675	598407
0009944814	598135
0009945750	598125
0009945775	598581
0009945815	598006
0009945816	598006
0009946023	598135
0009947499	598006
0009947776	598040
0009947935	598065
0009947936	598880
0009947955	598308
0009948030	598309
0009948092	598308
0009948334	598308
0009948577	598581
0009949134	598065
0009949332	598407
0009949334	598407
0009949412	598308
0009950479	598142
0009950637	598065
0009950713	598142
0009950714	598142
0009950778	598065
0009950853	598331
0009950865	598331
0009951155	598772
0009959479	598142
0060711959	598099
0060712608	598187
0060713601	598111
0060714404	598187
0060719983	598115
0060720645	598113
0060720981	598115
0060723584	598111
0060723585	598187
0060724069	598099
0060727286	598099
0060728433	598108
0060728434	598108
0060734810	598115
0060736109	598107



 Valeo	
ALFA ROMEO (.../...)	
0060736182	598107
0060737389	598107
0060741106	598115
0060741331	598115
0060743417	598006
0060743563	598006
0060743564	598003
0060743578	598125
0060749867	598160
0060750413	598289
0060750464	598126
0060750465	598130
0060750760	598130
0060750778	598130
0060750780	598126
0060750795	598126
0060750796	598130
0060750838	598289
0060750872	598130
0060750873	598130
0060760092	598351
0060760093	598115
0060760105	598115
0060760106	598006
0060760114	598003
0060760120	598125
0060760124	598006
0060765018	598000
0060765019	598008
0060765020	598142
0060777264	598289
0060777273	598115
0060777600	598219
0060777601	598142
0060777621	598010
0060778257	598113
0060778263	598099
0060778265	598351
0060778277	598160
0060778279	598126
0060778283	598130
0060778285	598130
0060778470	598115
0060778676	598005
0060810239	598219
0071712910	598581
0077363599	598729
009950479	598142
5892735	598219
5893947	598008
5893948	598005
5895983	598135
60723584	598111
60723585	598187
60724069	598099
60728434	598108
60734810	598115



 Valeo	
ALFA ROMEO (.../...)	
60736109	598107
60736182	598107
60737389	598107
60741106	598115
60750778	598130
60760092	598351
60760093	598115
60760105	598115
60760106	598006
60760114	598003
60760124	598006
60765020	598142
60777264	598289
60777273	598115
60777600	598219
60777601	598142
60777621	598010
60778257	598113
60778263	598099
60778265	598351
60778277	598160
60778279	598126
60778283	598130
60778285	598130
60778470	598115
60778676	598005
71712910	598581
71752987	598581
77362222	598308
77362226	598772
77362228	598308
77362229	598990
77362231	598990
77362239	598988
77362242	598142
77362254	598308
77362257	598581
77362275	598407
77362276	598407
77362300	598040
77362346	598006
77362675	598407
77362683	598990
77362692	598772
77363328	598772
77363341	598407
77363545	598772
77363599	598729
77363818	601029
77363819	601029
77364273	601029
77364393	598426
77364587	598729
77364589	598428
77364590	598633
77364920	598407
794962	598219



 Valeo	
ALFA ROMEO (.../...)	
93806190	598129
93806593	598129
93806594	598007
9945750	598125
9945775	598581
9945816	598006
9946023	598135
9947935	598065
9947936	598880
9948334	598308
9948335	598880
9948577	598581
9948845	598990
9949134	598065
9949332	598407
9949334	598407
9949533	598988
9950479	598142
9950550	598985
9950637	598065
9950778	598065
9950812	598988
9950853	598331
9950865	598331
ARO	
6000039184	598085
AUDI	
171698151B	598099
171698151C	598099
171698151H	598099
1J0698151	598332
1J0698151A	598332
1J0698151B	598332
1J0698151D	598408
1J0698151E	598408
1J0698151F	598408
1J0698151G	598408
1J0698151J	598332
1J0698151M	598486
1J0698451	598463
1J0698451B	598463
1J0698451D	598463
1J0698451F	598180
1J0698451H	598463
1J0698451J	598463
1J0698451N	598180
1K0698151	598635
1K0698151A	598408
1K0698151B	598863
1K0698151E	598635
1K0698151F	598408
1K0698451	598752
1K0698451A	598463
1K0698451C	598463







	
AUDI (.../...)	
1K0698451J	598463
321698151	598128
321698151A	598205
3A0698151A	598303
3C0698151B	598635
431698151D	598017
431698151E	598205
431698151F	598017
431698151G	598017
431698151H	598205
431698151J	598375
431698151L	598205
437698151	598017
443698151D	598017
443698151F	598017
443698151J	598017
443698151K	598017
443698451	598125
443698451A	598125
443698451B	598125
447698151A	598230
447698151F	598230
447698451	598125
447698451A	598125
4A0698451	598125
4B0698151	598483
4B0698151A	598483
4B0698151AB	598483
4B0698151AC	598750
4B0698151AD	598750
4B0698151B	598483
4B0698151C	598483
4B0698151D	598992
4B0698151E	598483
4B0698151H	598483
4B0698151J	598483
4B0698151K	598751
4B0698151L	598992
4B0698151M	598483
4B0698151N	598751
4B0698151R	598750
4B0698151S	598992
4B0698451	598463
4B0698451B	598463
4B0698451E	598463
4B3698451	601004
4D0698151A	598355
4D0698451	598125
4D0698451A	598125
4D0698451B	598125
4D0698451C	598463
4D0698451D	598463
4E0698151	598845
4E0698151A	598845
4E0698151E	598845
4E0698151F	598779
4E0698151J	598845



	
AUDI (.../...)	
4E0698151K	598845
4E0698151M	598779
4E0698451	601004
4F0698151	598751
4F0698151A	598779
4F0698151D	598779
4F0698451	601004
4F0698451A	598752
4F0698451D	598752
4F0698451E	598752
4F0698451F	601004
5K0698151	598635
6X0698451A	598463
7L0698151J	598656
7L0698451B	598770
7L5698451	598770
803698151C	598099
803698151K	598375
803698151M	598375
811698151	598099
811698151A	598205
811698151B	598205
835698151A	598004
853698151	598004
853698151A	598004
855698151B	598214
857698451	598125
859698151	598016
859698151A	598016
859698451	598125
861698151A	598099
8A0698151A	598017
8A0698151B	598017
8A0698151C	598017
8D0698151	598017
8D0698151A	598355
8D0698151C	598355
8D0698151D	598712
8E0698151	598017
8E0698151A	598017
8E0698151B	598484
8E0698151C	598779
8E0698151F	598751
8E0698151G	598779
8E0698151K	598483
8E0698451	598463
8E0698451A	598463
8E0698451B	598180
8E0698451C	601004
8E0698451D	598463
8E0698451E	598463
8E0698451F	598752
8E0698451J	598752
8E0698451L	598474
8E0698451M	598752
8E0698451N	601004
8J0698151	598635



	
AUDI (.../...)	
8J0698151C	598635
8J0698151D	598994
8K0698151A	598996
8N0698151	598303
8N0698151A	598486
8N0698151D	598712
8Z0698151	598734
AUTOBIANCHI	
5888149	598603
5892310	598091
71748384	598091
790605	598603
792489	598219
792561	598091
793470	598219
BEDFORD	
90167765	598182
90398758	598182
91144333	598185
94483220	598020
BMW	
34 11 1 115 02	598375
34 11 1 117 878	598107
34 11 1 118 169	598107
34 11 1 119 176	598107
34 11 1 119 177	598107
34 11 1 150 524	598108
34 11 1 150 527	598108
34 11 1 152 655	598108
34 11 1 152 656	598107
34 11 1 154 611	598104
34 11 1 154 612	598104
34 11 1 155 711	598107
34 11 1 156 462	598104
34 11 1 156 464	598107
34 11 1 157 039	598231
34 11 1 157 561	598104
34 11 1 157 562	598104
34 11 1 157 569	598231
34 11 1 157 813	598231
34 11 1 157 923	598104
34 11 1 158 265	598231
34 11 1 159 249	598108
34 11 1 159 251	598108
34 11 1 159 257	598107
34 11 1 159 259	598231
34 11 1 159 261	598107
34 11 1 159 263	598107
34 11 1 159 279	598231
34 11 1 159 415	598104
34 11 1 159 416	598104
34 11 1 160 356	598018
34 11 1 160 450	598231

	
BMW (.../...)	
34 11 1 160 459	598231
34 11 1 161 437	598018
34 11 1 161 438	598018
34 11 1 161 445	598018
34 11 1 161 446	598018
34 11 1 161 717	598104
34 11 1 162 535	598231
34 11 1 162 884	598712
34 11 1 163 307	598412
34 11 1 163 387	598310
34 11 1 163 850	598018
34 11 1 163 953	598310
34 11 1 164 330	598310
34 11 1 164 331	598310
34 11 1 164 498	598018
34 11 1 164 500	598018
34 11 1 164 627	598409
34 11 1 164 629	598409
34 11 1 164 737	598018
34 11 1 165 227	598412
34 11 1 165 555	598018
34 11 1 165 556	598018
34 11 1 165 557	598018
34 11 1 166 161	598712
34 11 2 226 007	598107
34 11 2 226 009	598107
34 11 2 228 248	598231
34 11 2 282 166	598412
34 11 2 282 554	598231
34 11 2 282 556	598412
34 11 2 283 865	598410
34 11 3 404 362	598811
34 11 3 427 503	598412
34 11 6 750 148	598811
34 11 6 752 482	598018
34 11 6 752 731	598018
34 11 6 753 668	598410
34 11 6 753 799	598712
34 11 6 754 705	598811
34 11 6 756 128	598018
34 11 6 761 237	598018
34 11 6 761 242	598018
34 11 6 761 243	598811
34 11 6 761 244	598018
34 11 6 761 252	598412
34 11 6 761 278	598409
34 11 6 761 279	598310
34 11 6 761 280	598409
34 11 6 761 283	598410
34 11 6 763 089	598410
34 11 6 763 305	598820
34 11 6 763 591	598410
34 11 6 763 617	598640
34 11 6 763 618	598640
34 11 6 764 540	598410
34 11 6 767 143	598699
34 11 6 767 144	598699



	
BMW (.../...)	
34 11 6 767 191	598410
34 11 6 767 580	598410
34 11 6 769 763	598700
34 11 6 769 951	598700
34 11 6 771 837	598699
34 11 6 771 838	598699
34 11 6 771 868	598640
34 11 6 774 050	598699
34 11 6 776 161	598898
34 11 6 780 711	601027
34 11 6 781 873	598410
34 11 6 783 542	598898
34 21 1 152 653	598187
34 21 1 157 334	598259
34 21 1 157 563	598259
34 21 1 157 757	598103
34 21 1 157 758	598103
34 21 1 157 814	598259
34 21 1 157 925	598103
34 21 1 157 926	598103
34 21 1 158 266	598259
34 21 1 158 270	598259
34 21 1 158 562	598259
34 21 1 158 642	598103
34 21 1 158 912	598103
34 21 1 158 919	598103
34 21 1 159 003	598103
34 21 1 159 262	598187
34 21 1 159 265	598187
34 21 1 159 267	598187
34 21 1 159 269	598187
34 21 1 159 273	598103
34 21 1 159 276	598103
34 21 1 159 912	598103
34 21 1 160 198	598103
34 21 1 160 199	598259
34 21 1 160 340	598386
34 21 1 160 341	598386
34 21 1 161 455	598386
34 21 1 161 456	598386
34 21 1 162 446	598386
34 21 1 162 866	598103
34 21 1 163 324	598580
34 21 1 163 326	598580
34 21 1 163 395	598311
34 21 1 164 499	598753
34 21 1 164 501	598753
34 21 1 164 581	598580
34 21 1 164 582	598580
34 21 1 165 233	598386
34 21 1 165 235	598386
34 21 2 226 01	598187
34 21 2 226 013	598103
34 21 3 403 241	598580
34 21 4 398 213	598753
34 21 6 750 160	598580
34 21 6 750 190	598753



	
BMW (.../...)	
34 21 6 757 536	598820
34 21 6 758 870	598411
34 21 6 761 238	598386
34 21 6 761 239	598753
34 21 6 761 240	598580
34 21 6 761 241	598753
34 21 6 761 248	598580
34 21 6 761 253	598259
34 21 6 761 281	598311
34 21 6 761 285	598411
34 21 6 761 286	598820
34 21 6 763 043	598754
34 21 6 763 044	598754
34 21 6 767 145	598701
34 21 6 767 146	598701
34 21 6 767 150	598703
34 21 6 768 471	598820
34 21 6 769 105	598885
34 21 6 773 161	598703
34 21 6 774 692	598703
34 21 6 775 678	598885
34 21 6 777 240	598701
34 21 6 791 938	598885
CADILLAC	
93183140	598783
93188111	598678
93188112	598678
93188113	598808
93190338	598472
CHEVROLET	
96288629	598316
96316582	598316
96391892	598902
96405131	598874
96446176	598316
96446742	598361
96475027	598361
96495227	598361
96534653	598644
96626070	598942
96626076	598941
CHRYSLER	
4423 812	598600
4423 822	598600
4720 644	598965
4762 669	598965
4762 682	598556
4773 264	598556
4773 265	598965
4863 784	598965
4882 107	598556
4897 746AA	598904
5011 631AA	598544



	
CHRYSLER (.../...)	
5017 843AA	598543
5018 208AA	598544
5018 595AA	598556
5018 945AA	598905
5019 803AA	598415
5019 805AA	598755
5071 948AA	598755
5072 216AA	598756
5086 364AA	598543
5086 567AA	598544
5093 021AA	598905
5101 857AA	598415
5114 555AA	598636
5126 300AA	598444
5142 555AA	601032
5142 560AA	601033
5142 561AA	601033
5142 566AA	601033
CITROËN	
4251-10	598064
4251-12	598502
4251-13	598383
4251-17	598070
4251-19	598800
4251-26	598073
4251-28	598360
4251-29	598207
4251-33	598385
4251-37	598075
4251-38	598074
4251-39	598074
4251-40	598075
4251-44	598069
4251-45	598420
4251-46	598396
4251-47	598075
4251-50	598073
4251-55	598326
4251-56	598031
4251-57	598383
4251-58	598385
4251-59	598362
4251-61	598591
4251-62	598145
4251-70	598074
4251-72	598292
4251-83	598292
4251-86	598146
4251-87	598149
4251-89	598360
4251-97	598396
4252-03	598462
4252-11	598420
4252-13	598398
4252-14	598417
4252-15	598419

	
CITROËN (.../...)	
4252-16	598416
4252-17	598418
4252-18	598464
4252-26	598429
4252-27	598430
4252-31	598553
4252-33	598463
4252-34	598398
4252-35	598465
4252-36	598500
4252-37	598501
4252-40	598464
4252-41	598463
4252-43	598568
4252-45	598569
4252-47	598570
4252-48	598419
4252-49	598416
4252-53	598465
4252-55	598468
4252-57	598396
4252-58	598500
4252-72	598075
4252-73	598075
4252-74	598396
4252-85	598360
4252-87	598417
4252-88	598419
4252-89	598416
4252-90	598418
4252-91	598031
4252-92	598383
4252-93	598385
4252-94	598663
4252-95	598028
4252-96	598029
4253-01	598420
4253-05	598461
4253-06	598074
4253-17	598591
4253-21	598030
4253-23	598715
4253-25	598702
4253-28	598718
4253-29	598939
4253-30	598464
4253-31	598465
4253-34	598418
4253-42	598464
4253-44	598715
4253-45	598500
4253-46	598419
4253-56	598891
4253-58	598891
4253-60	598892
4253-61	598997
4253-62	598998







	
CITROËN (.../...)	
4253-64	598899
4253-66	598899
4253-68	601039
4253-69	598500
4253-70	598465
4253-71	598936
4253-72	598501
4253-84	598500
4253-91	598852
4253-97	598998
4253-99	598702
4254-04	598664
4254-05	598783
4254-07	598426
4254-11	598663
4254-13	598997
4254-15	601042
4254-20	598474
4254-23	598464
4254-25	598997
4254-28	598463
4254-29	601042
4254-32	598936
4254-50	598074
4254-53	598064
4254-54	598073
4254-55	598429
4254-56	598430
4254-57	598553
4254-58	598568
4254-59	598569
4254-61	598891
4254-62	598891
4254-67	598463
4254-68	598570
4254-69	598892
4254-71	598465
4254-74	598718
4254-75	598464
4254-77	598998
4254-91	598664
4254-92	598465
4254-97	601039
5423521	598145
5434279	598144
5441971	598144
5453876	598147
75516219	598144
75516220	598144
75519956	598148
75529822	598150
75529823	598363
75530829	598591
75531486	598085
95534349	598362
95542661	598144
95542662	598146



	
CITROËN (.../...)	
95549354	598363
95549355	598363
95551761	598144
95552085	598149
95565562	598147
95565564	598207
95570824	598364
95570825	598364
95574308	598146
95574310	598149
95587471	598148
95588498	598148
95588903	598375
95589273	598151
95600561	598145
95611066	598146
95611498	598119
95616818	598119
95619550	598030
95619601	598156
95623223	598138
95624480	598147
95624481	598148
95624482	598207
95624483	598364
95624484	598151
95624970	598153
95640895	598138
95646300	598030
95647733	598119
95648537	598150
95650872	598292
95650873	598148
95650890	598148
95650935	598030
95650936	598156
95650937	598030
95650938	598156
95650995	598149
95650996	598146
95650997	598145
95651046	598029
95651047	598292
95653061	598144
95654085	598292
95654086	598029
95658557	598154
95658617	598030
95658639	598029
95659340	598155
95659341	598396
95659353	598714
95659616	598155
95659639	598028
95659640	598028
95659641	598029
95659642	598292



	
CITROËN (.../...)	
95661798	598207
95661871	598714
95663072	598363
95663076	598085
95663077	598375
95666894	598353
95666970	598155
95666971	598396
95666972	598029
95666973	598292
95667764	598153
95667765	598138
95667786	598031
95667787	598383
95667788	598292
GX2526802A	598146
GX2526802B	598146
GX2526803A	598146
GX2526803B	598146
GX2532601A	598145
GX2532602A	598145
ZF09937786	598153
ZF09938205	598153
DACIA	
6001547619	598002
6001547911	598002
6001549803	601017
7701207066	598002
7701208265	598002
7701208422	598641
7701209639	598002
7701210142	598002
7711130071	598002
DAEWOO	
11046948322	598039
11046948372	598039
11046952012	598184
48413-05000	598854
96245178	598361
96245179	598902
96253367	598361
96253368	598902
96253382	598361
96288629	598316
96316582	598316
96391892	598902
96405131	598874
96446742	598361
96495227	598361
96534653	598644
S4521001	598902
S4521006	598902

	
DAF	
RTC4812	598129
DAIHATSU	
04465-B1040	598733
04465-B1320	598999
04465-B2040	598873
04491-87209-000	601024
04491-87217-000	601024
04491-87218-000	601024
04491-87228-000	601024
04491-87724-000	598850
04491-87727-000	598850
04491-87728-000	598850
04491-97201-000	598856
04491-97202-000	598883
04491-97205-000	598856
04491-97214-000	598873
04491-97217-000	598733
04491-97401-000	598856
04491-97402-000	598733
04491-97404-000	598733
04492-87101-000	598624
04492-87102-000	598624
DODGE	
5191271AA	598852
F.S.O. / POLSKI	
030633	598603
030636	598088
039532	598603
039533	598603
039540	598088
059957	598603
063576	598095
FIAT	
4333335	598088
4379301	598090
4434816	598603
4434879	598219
4435009	598371
5882984	598271
5888147	598219
5888151	598090
5888153	598219
5888154	598090
5888155	598088
5888528	598271
5888529	598271
5888550	598085
5888553	598371
5888781	598095
5888939	598141
5892309	598091
5892310	598091



	
FIAT (.../...)	
5892330	598095
5892549	598219
5892580	598134
5892601	598141
5892650	598125
5892727	598219
5892728	598219
5892729	598141
5892731	598135
5892732	598219
5892733	598219
5892734	598219
5892735	598219
5892736	598011
5892737	598012
5892738	598219
5892786	601021
5892945	598088
5894112	598271
5951660	598091
5951671	598091
5951868	598088
5983918	598219
71711135	598073
71737178	598011
71738134	601021
71738152	598422
71738153	598271
71738154	598271
71738157	601019
71738158	598423
71742853	598804
71748384	598091
71750033	598804
71752980	598070
71752982	598607
71752984	598142
71752986	601003
71752988	598425
71752993	598800
71753040	598430
71753090	598990
77362091	598426
77362092	598427
77362093	598428
77362149	601003
77362170	598607
77362180	598424
77362185	598012
77362186	598041
77362190	598605
77362193	598065
77362194	598426
77362195	598427
77362196	598428
77362216	598569
77362219	598568



	
FIAT (.../...)	
77362227	598988
77362231	598990
77362235	598430
77362236	598553
77362238	598073
77362242	598142
77362245	598012
77362267	598012
77362269	601003
77362271	598633
77362274	598570
77362479	598012
77362548	598670
77362689	598696
77362691	598696
77362710	598427
77362712	598427
77362743	598698
77362768	598633
77363035	598913
77363321	601003
77363445	598425
77363496	598422
77363518	598633
77363604	598678
77363607	598727
77363610	598727
77363627	598793
77363942	598426
77363956	598553
77363958	598721
77363959	598722
77363974	598426
77363992	598913
77364014	598891
77364016	598892
77364024	598425
77364158	598913
77364160	598891
77364168	598727
77364169	598727
77364224	598678
77364281	598698
77364393	598426
77364394	598426
77364447	598553
77364473	598427
77364477	598426
77364511	598899
77364512	598899
77364513	601039
77364517	598913
77364567	598407
77364588	598426
77364589	598428
77364590	598633
77364599	598427



	
FIAT (.../...)	
77364635	598987
77364636	601015
77364637	598426
77364798	598670
77364839	598407
77364961	598425
77365113	598721
790475	598088
791873	598141
792487	598219
792489	598219
792588	598219
792589	598091
792700	598134
792701	598134
792703	598141
792704	598141
792725	598091
793184	598219
793220	598219
793221	598219
793323	598091
793325	598091
793356	598219
793357	598219
793382	598095
793385	598219
793470	598219
793774	598135
794079	598095
794091	598219
794963	598219
795121	598219
795915	598073
9404251248	598502
9404251518	598073
9404252328	598463
9404252548	598468
9467548887	598899
9467548987	598899
9467549087	601039
9938109	598085
9939503	598125
9939966	598142
9940092	598153
9940566	598138
9940969	598125
9941207	598153
9941605	598142
9941669	598142
9941872	598010
9941873	598125
9942904	598142
9942953	598142
9943830	598095
9944678	598010
9945070	598153



	
FIAT (.../...)	
9945076	598138
9945496	598142
9945629	598125
9945788	598070
9945810	598800
9945821	598142
9945822	598142
9945823	598142
9946016	598064
9946227	598985
9947007	598142
9947118	598040
9947156	598065
9947629	598040
9947630	598041
9947643	598988
9947917	598423
9947934	598605
9947938	598331
9947954	598424
9947996	601019
9948037	601019
9948038	598423
9948045	598012
9948054	598012
9948095	598308
9948131	598424
9948408	598607
9948410	598607
9948417	598425
9948476	598065
9948623	601003
9948626	598429
9948629	598430
9948870	598422
9949048	598041
9949124	598423
9949125	598422
9949173	598142
9949183	598012
9949273	598426
9949276	598427
9949279	598428
9949280	598633
9949335	598425
9949362	598569
9949407	598570
9949482	598568
9949516	598568
9949517	598569
9949552	598553
9949555	601003
9949556	598913
9951217	598990
FORD	
1001095	598067





 →	
FORD (.../...)	
1001096	598463
1010503	598212
1013843	598043
1015598	598172
1022077	598619
1022078	598630
1022079	598033
1027640	598463
1027703	598067
1031843	598067
1039106	598212
1042688	598212
1048308	598399
1048309	598172
1048310	598399
1064762	598043
1064763	598212
1073731	598034
1073732	598033
1074971	598036
1074972	598037
1075558	598317
1075565	598431
1079347	598034
1079348	598033
1079919	598171
1079920	598212
1095201	598034
1095202	598033
1096940	598033
1096942	598034
1097768	598619
1101464	598564
1107698	598431
1111857	598563
1111858	598563
1121894	598433
1121895	598434
1126718	598433
1126719	598434
1128463	598564
1129986	598035
1130120	598434
1130715	598563
1130751	598172
1130753	598399
1130758	598033
1130759	598034
1133445	598489
1133446	598565
1133447	598681
1133448	598681
1133748	598172
1133750	598399
1135167	598432
1136519	598317
1143349	598489

 →	
FORD (.../...)	
1144288	598547
1151377	598801
1152316	598434
1201124	598489
1204845	598434
1205557	598463
1207104	598434
1207518	598681
1207519	598681
1219892	598434
1219894	598434
1227108	598434
1233679	601005
1236880	598564
1250688	598433
1301589	598036
1301592	598037
1318139	598432
1318147	598547
1321517	598649
1324300	601005
1343513	598681
1343514	598463
1345337	598681
1345340	598463
1355950	598639
1356392	598740
1360254	598472
1360303	598639
1360304	598783
1360305	598649
1360306	601044
1368558	598822
1371402	598816
1371403	598818
1371454	541736
1379971	598879
1405511	601007
1423389	601007
1425407	598431
1426143	598928
1426144	598928
1431178	601007
1433952	598816
1433954	598818
1433958	541736
1436498	598879
1437761	598879
1439866	598928
1439867	598935
1458247	598879
1459408	598935
1459450	598928
1465126	598171
1477803	598935
1488962	598816
1503969	598928

 →	
FORD (.../...)	
1508074	598649
1519528	598649
1530602	541736
1550219	598999
1554524	541736
1559697	601015
1559698	598987
1565491	598168
1566096	601044
1571569	598391
1571570	598129
1571571	598129
1571572	598129
1576829	598168
1591096	598168
1591098	598168
1595524	598166
1595913	598168
1610637	598168
1613128	598166
1637872	598240
1638880	598240
1642643	598129
1647730	598335
1647731	598120
1652206	598240
1666624	598312
1666716	598121
1954460	598602
1957042	598602
4077636	598432
4095132	598547
4114749	598547
4346371	598639
4387361	598639
4387371	598472
4427737	598639
4509599	598784
5010540	598391
5010553	598129
5012130	598168
5015916	598165
5015917	598167
5015920	598334
5015923	598338
5015924	598168
5015932	598391
5015935	598129
5018194	598212
5018195	598334
5018897	598165
5018898	598167
5018899	598212
5018900	598166
5018901	598338
5018902	598168
5018905	598168

 →	
FORD (.../...)	
5018907	598391
5018908	598129
5018981	598217
5018982	598169
5020817	598335
5020818	598120
5022397	598391
5022398	598129
5023486	598032
5023994	598212
5023995	598166
5023998	598120
5023999	598120
5025919	598043
5025929	598171
5028763	598036
5028764	598037
5029147	598034
5029148	598033
6080699	598168
6099232	598165
6099237	598168
6099238	598168
6099239	598168
6127521	598168
6130483	598212
6132471	598167
6132807	598212
6150947	598032
6155611	598166
6165965	598129
6166953	598166
6174787	598120
6178479	598212
6180371	598172
6184245	598032
6188427	598043
6189145	598166
6189769	598121
6197738	598036
6197739	598037
6203650	598171
6485895	598312
6500951	598335
6500952	598172
6500954	598172
6511773	598212
6511774	598120
6521375	598120
6567002	598129
6668587	598619
6669780	598035
6687176	598619
6704268	598212
6704269	598335
6704270	598120
6704271	598172

 Valeo	
FORD (.../...)	
6785599	598240
6821708	598120
6877835	598630
6877836	598034
6877837	598033
6882582	598033
6882583	598630
6882584	598034
6962492	598172
6965579	598036
6965580	598037
7017948	598399
7018202	598036
7018203	598037
7075049	598172
7075050	598172
7153477	598035
7204067	598619
7261715	598033
7261716	598630
91AB2K021BB	598172
91AB2K021JA	598172
91AB2K021JB	598172
92VB2K021AB	598036
92VB2K021AC	598036
92VB2K021BB	598037
92VB2K021BC	598037
FORD USA	
3395842	598846
3401278	598250
3868298	598290
3886184	598906
3894048	598629
3898005	598290
3898530	598629
3922123	598629
G.M.E.	
91128990	598185
91144333	598185
GALLOPER	
58101-M2A01	598625
58302-M2A00	598834
	598866
S2000100	598504
SB000100	598504
HONDA	
06022-SP8-000	598053
06430-S5A-E50	598627
06430-S7S-000	598682
06450-S5A-E50	598494
06450-S5A-G00	598494
06450-S5T-E50	598907

 Valeo	
HONDA (.../...)	
06450-S5T-E51	598907
06450-S9A-A00	598757
06450-S9A-A01	598757
06450-S9A-E50	598757
06450-S9A-E51	598757
43022-S04-E00	598437
43022-S04-E01	598437
43022-S04-E03	598437
43022-S1A-E03	598758
43022-S1A-E04	598758
43022-S1A-E50	598758
43022-S2A-000	598682
43022-S2A-E50	598682
43022-S3N-000	598682
43022-S3N-E50	598682
43022-S5A-E50	598682
43022-S5A-J00	598682
43022-S6D-000	598682
43022-S6D-E50	598682
43022-S7S-010	598682
43022-S9A-E00	601043
43022-S9A-E51	598682
43022-S9A-E52	598682
43022-SE0-N50	598053
43022-SEA-E01	598682
43022-SF1-000	598053
43022-SF1-010	598053
43022-SF1-305	598053
43022-SF1-315	598053
43022-SG0-020	598682
43022-SG0-G00	598911
43022-SG0-G01	598911
43022-SH3-930	598053
43022-SH3-931	598053
43022-SH3-932	598053
43022-SH3-G00	598053
43022-SH3-G01	598053
43022-SJF-E00	601043
43022-SL5-000	598911
43022-SM4-950	598682
43022-SM4-G00	598682
43022-SMG-E00	598849
43022-SMG-E01	598849
43022-SN7-000	598682
43022-SP0-E00	598682
43022-SP0-E01	598682
43022-SP0-E02	598682
43022-SP0-E03	598682
43022-SR3-G00	598437
43022-SR3-G01	598437
43022-ST3-E00	598053
43022-ST3-E50	598053
43022-SV4-010	598682
43022-SV4-A00	598682
43022-SV4-A20	598682
43022-SV4-G00	598682
43022-SV4-G20	598682

 Valeo	
HONDA (.../...)	
43022-SV4-G21	598682
43022-SV4-G22	598682
43022-SWW-G01	601038
43022-SX0-A51	598682
43022-SY8-A01	598682
43022-SZ3-A01	598682
43022-SZ3-E50	598682
45022-692-670	598208
45022-692-671	598208
45022-692-672	598208
45022-692-N50	598208
45022-693-600	598208
45022-693-601	598208
45022-S04-G00	598495
45022-S04-J02	598760
45022-S04-V10	598494
45022-S04-V11	598494
45022-S04-V12	598494
45022-S10-A00	598627
45022-S10-E50	598627
45022-S1A-E02	598436
45022-S1A-E20	598627
45022-S1A-E50	598436
45022-S1A-E63	598435
45022-S1A-E70	598627
45022-S1A-E80	598435
45022-S2A-E01	598907
45022-S2A-E10	598907
45022-S2A-E50	598907
45022-S30-A00	598627
45022-S30-A02	598627
45022-S30-G10	598056
45022-S30-G11	598056
45022-S30-G12	598056
45022-S5A-J00	598494
45022-S5B-E00	598494
45022-S6D-E01	598022
45022-S6D-E50	598022
45022-S74-E10	598022
45022-S74-E50	598022
45022-S7A-E00	598887
45022-S9A-A01	598757
45022-S9A-E60	598757
45022-SA0-660	598185
45022-SA0-670	598185
45022-SA0-680	598131
45022-SA0-N50	598185
45022-SA0-N60	598131
45022-SA5-000	598047
45022-SA5-010	598047
45022-SA5-020	598047
45022-SA6-600	598052
45022-SA6-N50	598052
45022-SAA-G00	598760
45022-SB0-505	598047
45022-SB0-670	598047
45022-SB0-671	598047

 Valeo	
HONDA (.../...)	
45022-SB0-672	598047
45022-SB2-670	598047
45022-SB2-671	598047
45022-SB2-672	598047
45022-SB2-673	598047
45022-SB2-674	598047
45022-SB2-675	598047
45022-SE0-508	598056
45022-SE0-518	598056
45022-SE0-528	598056
45022-SE0-G10	598056
45022-SEA-E01	598824
45022-SF1-000	598248
45022-SF1-010	598248
45022-SF1-020	598248
45022-SG9-000	598227
45022-SH3-930	598248
45022-SH3-931	598248
45022-SH3-932	598248
45022-SH3-G00	598047
45022-SH3-G03	598047
45022-SH3-G30	598248
45022-SH3-G31	598248
45022-SH3-G32	598248
45022-SH3-G33	598248
45022-SH3-G50	598047
45022-SH3-N30	598047
45022-SJF-E00	598887
45022-SK3-E00	598022
45022-SL0-G00	598627
45022-SL0-G01	598627
45022-SL0-G02	598627
45022-SM4-A00	598788
45022-SM5-A00	598627
45022-SMG-E00	598803
45022-SMG-E01	598803
45022-SMT-E00	598907
45022-SN7-G40	598056
45022-SN7-G41	598056
45022-SN7-G42	598056
45022-SN7-G50	598627
45022-SN7-Y40	598056
45022-SP0-E00	598627
45022-SR3-910	598047
45022-SR3-920	598047
45022-SR3-G00	598495
45022-SR3-G01	598495
45022-SR3-V00	598494
45022-SR3-V01	598494
45022-SR3-V10	598494
45022-SR3-V11	598494
45022-SR3-V12	598494
45022-SS0-508	598056
45022-SS0-518	598056
45022-SS0-528	598056
45022-SS0-G00	598627
45022-SS0-G01	598627



HONDA (.../...)	
45022-SS0-G02	598627
45022-SS0-G10	598056
45022-ST3-E00	598022
45022-ST3-E01	598022
45022-ST3-E30	598022
45022-ST7-R00	598627
45022-ST7-R01	598627
45022-ST7-R02	598627
45022-SWW-G01	598901
45022-SZ3-G00	598887

HYUNDAI	
58101-02A00	598575
58101-02A10	598708
58101-05A10	598575
58101-0XA01	598707
58101-0XA10	598707
58101-1CA00	598052
58101-1CA10	598052
58101-1G-E00	598868
58101-1HA10	598842
58101-1HA20	598842
58101-1JA10	598868
58101-22A00	598052
58101-22A10	598052
58101-24A00	598052
58101-24B00	598052
58101-24C00	598052
58101-25A10	598052
58101-26A10	598505
58101-26A30	598505
58101-28A00	598051
58101-28A10	598052
58101-28A20	598051
58101-29A00	598051
58101-29A10	598051
58101-29A20	598051
58101-29A30	598051
58101-29A40	598051
58101-29A50	598574
58101-29A90	598574
58101-29B00	598574
58101-2BA10	598937
58101-2CA20	598744
58101-2DA20	598574
58101-2DA40	598781
58101-2DA50	598739
58101-2DA60	598781
58101-2EA11	598744
58101-32300	598052
58101-32310	598052
58101-32B00	598052
58101-33A00	598051
58101-33C00	598051
58101-34A10	598574
58101-34A20	598574
58101-34A21	598574

HYUNDAI (.../...)	
58101-35A10	598051
58101-38A40	598574
58101-38A80	598744
58101-38A81	598744
58101-39A40	598505
58101-3AA20	598759
58101-3K-A40	598744
58101-43A00	598634
58101-44A00	598634
58101-4AA00	598908
58101-4AA26	598505
58101-4AA30	598908
58101-4AA31	598908
58101-4AA32	598908
58101-4AA60	598908
58101-4AA61	598908
58101-4BA00	598634
58101-H1A00	598506
58101-H1A10	598506
58101-H1A80	598506
58101-M2A01	598625
58103-31000	598168
58302-0XA00	598706
58302-17A00	598748
58302-1CA00	598748
58302-1CA10	598748
58302-1G-A00	598867
58302-26A00	598748
58302-26A30	598748
58302-29A00	598817
58302-29A10	598817
58302-2BA20	598932
58302-2DA10	598817
58302-2EA30	598748
58302-38A10	598748
58302-38A20	598748
58302-38A30	598748
58302-39A40	598748
58302-3AA20	598748
58302-3KA30	598748
58302-3KA40	598748
58302-M2A00	598834
	598866
5H103-31000	598168
S2000100	598504
SB000100	598504

INFINITI	
41060-EG090	598738
D4060-EG50C	601009

INNOCENTI	
577201112	598392
5888154	598090
5888528	598271
71738153	598271

ISUZU	
8-94460-851-0	598615
8-94483-220-1	598020
8-97035-257-1	598460
8-97035-266-0	598507
8-97039-269-0	598507
8-97180-525-0	598460
97039269	598507
97113888	598460

IVECO	
1902292	598007
1902294	598129
1902469	598369
1902493	598139
1902494	598132
1906040	540436
1906154	598129
1906155	598007
1906157	598380
1906158	598598
1906159	598596
1906183	541641
1906206	598007
1906207	598132
1906243	598369
1906401	541662
1906428	598586
1906429	598585
2992339	541662
42470835	541717
42470841	541705
42535791	541662
42536101	541663
42555406	541705
42555881	541734
42555917	541735

JAGUAR	
C2C15990	598439
C2C8342	598438
C2S17129	598433
C2S17362	598434
C2S20893	598434
GBP224	598374
JLM1157	598374
JLM11903	598039
JLM1510	598374
JLM1513	598374
JLM1829	598440
JLM21344	598039
JLM536	598374
JLM9727	598374
JLM9728	598374
MJE2001AA	598440
XR812436	598438
XR813324	598439

JAGUAR (.../...)	
XR837417	598439

JEEP	
4713 175	598491
4778 058	598491
4778 058AB	598491
4796 344	598509
4883 344	598491
5011 970AA	598677
5011 970AB	598677
5018 592AA	598510
5066 427AA	598414
5080 868AC	598872
5080 871AB	598920
5083 882AC	598755
5093 183AA	598833
5093 260AA	598833
68003 701AA	598924

KIA	
0K011-33-23Z	598838
0K045-33-23Z	598511
0K2A2-33-23Z	598989
0K2A3-33-23Z	598989
0K2FC-26-28Z	598841
0K2JA-33-28Z	598842
0K2JA-33-28ZA	598842
0K2N1-33-28ZA	598910
0K2Y3-33-23Z	598989
0K553-33-23Z	598491
0K553-33-23ZB	598491
0K56A-33-23Z	598821
0K58A-3323Z	598821
0K72G-33-28Z	598821
0K75A-33-28Z	598821
0K9A0-26-28Z	598841
0K9D0-33-28Z	598910
58101-07-A10	598707
58101-07A20	598707
58101-1DE00	598934
58101-1FE00	598744
58101-1G-E00	598868
58101-1HA00	598842
58101-2F-A20	598705
58101-3CA20	598574
58101-3EE00	598654
58101-3EE01	598654
58101-3K-A40	598744
58101-M2A02	598574
58101-M2A04	598574
58302-07-A00	598706
58302-07-A10	598706
58302-1DE00	598945
58302-1FE00	598748
58302-1G-A00	598867
58302-1HA00	598867

 Valeo	
KIA (.../...)	
58302-2F-A10	598817
58302-2G-A00	598748
58302-38A10	598748
58302-38A20	598748
58302-39A40	598748
58302-3CA10	598748
58302-3ED00	598823
58302-3EE00	598823
58302-M2A01	598866
KOBA2-33-28Z	598274
KK150-33-28Z	598268
MDA19-33-28Z	598268
LADA	
2101-350109001	598405
2108-3501080	598406
2108-3501089	598406
21213-3501090	598389
2121-3501090	598389
LANCIA	
5888150	598093
5888544	598090
5888545	598094
5892310	598091
5892330	598095
5892580	598134
5892601	598141
5892608	598093
5892650	598125
5892728	598219
5892729	598141
5892731	598135
5892732	598219
5892733	598219
5892734	598219
5892735	598219
5892740	598859
5983913	598133
5983919	598219
5983950	598219
71748384	598091
71752984	598142
71752987	598581
77362141	601001
77362185	598012
77362202	598308
77362226	598772
77362231	598990
77362236	598553
77362242	598142
77362248	598012
77362251	598880
77362254	598308
77362272	601001
77362273	601029

 Valeo	
LANCIA (.../...)	
77362276	598407
77362309	598219
77362359	598761
77362360	598761
77362548	598670
77362743	598698
77363035	598913
77363818	601029
77363956	598553
77364024	598425
77364158	598913
77364331	601031
77364332	601031
77364447	598553
77364473	598427
77364589	598428
77364590	598633
77364599	598427
77364929	601014
77364961	598425
77365217	601031
77365218	601031
77365311	601014
792159	598134
792401	598134
792426	598135
792488	598093
792561	598091
792698	598141
792698AR	598141
792698AV	598219
792699AR	598141
792699AV	598219
792700	598134
792701	598134
793132	598134
793132AR	598141
793132AV	598219
793211	598133
793219	598141
793230	598134
793271	598219
793272	598141
793322	598091
793355	598219
793470	598219
793485	598141
793774	598135
794079	598095
794091	598219
82315602	598090
82315603	598094
82357469	598093
9404251248	598502
9404252328	598463
9404252548	598468
9938719	598093

 Valeo	
LANCIA (.../...)	
9939353	598093
9939503	598125
9940969	598125
9941175	598006
9941211	598142
9941718	598093
9941872	598010
9941873	598125
9942904	598142
9942953	598142
9944395	598180
9945496	598142
9945629	598125
9945821	598142
9945822	598142
9945823	598142
9946016	598064
9946227	598985
9946568	598581
9946750	598985
9946788	598006
9947156	598065
9947468	598012
9947482	598219
9947629	598040
9947630	598041
9947916	598581
9947934	598605
9947938	598331
9948054	598012
9948095	598308
9948337	598880
9948338	598407
9948557	598772
9949048	598041
9949173	598142
9949183	598012
9949203	601029
9949293	601001
9949334	598407
9949552	598553
9951050	598772
9951101	598308
9951217	598990
LAND ROVER	
LR003655	598935
LR003657	598935
LR004936	598879
RTC3163	598129
RTC3164	598497
RTC4519	598497
RTC5574	598623
RTC5756	598129
RTC6591	598497
RTC6781	598498
SFC000010	598658

 Valeo	
LAND ROVER (.../...)	
SFC500050	598658
SFP000010	598514
SFP000020	598514
SFP000120	598580
SFP000150	598497
SFP000160	598762
SFP000270	598497
SFP000280	598762
SFP100360	598512
SFP100460	598441
SFP100470	598499
SFP100480	598441
SFP100490	598499
SFP500010	598741
SFP500021	598742
SFP500022	598742
SFP500140	598742
STC1276	598497
STC1601	598762
STC1879	598499
STC1880	598441
STC2952	598623
STC3195	598441
STC3684	598499
STC3685	598441
STC8569	598497
STC8570	598497
STC8571	598498
STC8572	598498
STC9147	598497
STC9148	598497
STC9149	598498
STC9150	598498
STC9188	598497
STC9189	598497
STC9190	598498
STC9191	598498
LEXUS	
04465-22311	601023
04465-22312	601023
04465-30110	601023
04465-30270	601023
04465-30271	601023
04465-30272	601023
04465-30320	601023
04465-48020	598944
04465-48090	598944
04465-53020	601035
04465-60230	598535
04466-22190	598888
04466-30050	601022
04466-30120	601025
04466-30121	601025
04466-30122	601025
04466-30161	601025
04466-30170	601025



LEXUS (.../...)	
04466-30190	601025
04466-53010	598888
04466-60070	598865

LEYLAND	
RTC4812	598129

MARUTI	
55210-78450	598185
55210M84500	598185

MAZDA	
0841-49-230	598077
1E06-33-23Z	598212
1E06-33-23ZA	598212
1E06-33-23ZB	598212
1E07-33-23Z	598564
1E10-33-23Z	598564
B001-49-280A	598612
B0YW-33-23Z	598646
B0YW-33-23ZC	598646
B3YF-33-23Z	598649
B4Y6-33-23Z	598274
B4Y6-33-23ZA	598274
B571-33-23Z	598293
B5Y6-33-23Z	598274
B5Y6-33-23ZA	598274
B5Y6-33-28Z	598274
B5Y6-33-28ZA	598274
B5Y8-33-23Z	598274
B5Y8-33-23ZA	598274
B5Y8-33-28ZB	598274
BCYC-33-23Z	598274
BCYW-33-23Z	598274
BCYW-33-23ZC	598274
BG34-49-280A	598293
BJYD-33-23Z	598548
BJYD-33-28Z	598548
BPYK-26-48Z	601005
BPYK-26-48ZA	601005
BPYK-26-48ZB	601044
BPYK-33-23Z	598649
BPYK-33-23ZA	598649
BRY4-33-23Z	598646
BRY4-33-28Z	598646
BRY7-33-23ZA	598274
BWYH-26-43Z	598624
C2Y3-26-48ZA	601008
CBY0-33-23Z	598629
CBY1-33-23ZA	598629
CBY1-33-23ZD	598629
CBY1-33-23ZE	598629
CBY1-33-23ZF	598629
CBY1-33-23ZG	598629
CBY3-33-23Z	598647
CBY4-33-28Z	598647



MAZDA (.../...)	
CBY9-33-23Z	598629
DA19-33-28ZA	598268
DCY0-33-28Z	601018
DDY2-33-28Z	598564
DFY1-33-28Z	598999
DFY1-33-28ZA	598999
E0Y8-26-43Z	598624
E0Y8-26-43ZA	598624
E0Y8-26-43ZB	598624
F1YA-26-48Z	598831
FB71-26-28ZA	598780
G030-49-280	598239
G1YC-33-28ZB	598647
G1YN-33-23ZA	598647
G5Y6-26-43Z	598290
G5Y6-26-43ZA	598290
GAYE-26-43ZA	598290
GAYE-26-43ZB	598290
GAYR-33-23ZA	598629
GBYH-33-23Z	598629
GCYD-33-23Z	598629
GEYC-26-48ZA	598780
GEYT-33-28Z	598629
GEYT-33-28ZA	598629
GG29-49-280	598239
GGYB-26-43Z	598780
GGYM-26-43Z	598780
GJ87-26-48ZA	598846
GJYA-33-28ZA	598647
GJYB-26-43Z	598780
GJYB-26-48Z	598780
GJYC-33-28Z	598647
GJYF-33-28ZB	598648
GJYF-33-28ZC	598648
GJYF-33-28ZE	598648
GJYG-33-28Z	598648
GN51-33-23Z	598250
GN51-33-28Z	598250
GPYB-26-48Z	598780
JOV1-26-43ZB	598516
LBZ2-33-23Z	598515
LCY4-33-23ZA	598515
LCY4-33-23ZB	598515
LCY4-33-23ZC	598515
LDY3-33-28Z	598515
NOY3-33-23Z	598836
NOY6-26-48Z	598835
NOY7-33-28Z	598745
NOY8-26-43Z	598835
NOY8-26-43ZA	598835
NOY9-33-23Z	598745
NAY0-26-43Z	598624
NAY0-26-43ZA	598624
NAY5-26-43Z	598835
NAY5-26-43ZA	598835
NAY5-26-43ZB	598835
NAY5-26-48Z	598835



MAZDA (.../...)	
NAY5-33-23Z	598836
NAY5-33-23ZA	598836
NAY5-33-23ZB	598836
NAY5-33-28Z	598836
NAY5-33-28ZA	598836
NFY7-26-43Z	598746
UHY1-33-23ZA	598784
UHY1-33-23ZB	598784
UHY1-33-23ZD	598784
UJY6-33-23Z	598784

MCC	
0001431V002	598329
0001431V003000000	598329
4514210010	598329
4544200920	598318
4544201020	598319
4544210010	598493

MERCEDES	
0004205920	598110
0004206020	598110
0004206320	598109
0004206420	598109
0004206520	598109
0004206620	598111
0004206720	598111
0004206820	598109
0004208820	598105
0004209120	598241
0004209420	598110
0004209520	598110
0004209720	598300
0004209820	598345
0004209920	598315
0004209920WC	598315
0004214110	598299
0004214210	598301
0004216110	598764
0004216210	598765
0004230230	598637
0014200120	598105
0014200520	598110
0014201020	598241
0014201420	598613
0014207520	598110
0014207720	598111
0014207820	598109
0014208120	598241
0014209520	598272
0014209620	598241
0014209820	598601
0014209920	598110
0014210910	598764
0014211010	598765
0024200220	598241



MERCEDES (.../...)	
0024200520	598617
0024201520	598601
0024201620	598617
0024202120	598013
0024202220	598013
0024203920	598044
0024204020	598046
0024204120	541664
0024204220	541664
0024204320	598110
0024204420	598357
0024204520	598636
0024204620	598617
0024204820	598062
0024205020	598636
0024205120	598763
0024205220	598447
0024205620	598045
0024206020	598046
0024206920	598045
0024207120	598444
0024207420	598444
0024208020	598617
0024209620	598357
0024209920	598044
0034200020	598062
0034200120	598299
0034200220	598301
0034200520	598445
0034200620	598446
0034201720	541664
0034201820	598445
0034201920	598446
0034202120	598712
0034202420	598300
0034202520	598448
0034202620	598448
0034202720	598444
0034202820	598447
0034203020	598617
0034204220	598445
0034204420	541655
0034204520	598448
0034204820	598617
0034204920	598617
0034205120	598637
0034205220	598447
0034205820	598659
0034205920	598448
0034206020	598448
0034206520	598638
0034208320	598636
0034208320	598636
0034209120	598712
0034209520	598448
0034209920	598638
0044200320	598636
0044200420	598445

	Valeo
MERCEDES (.../...)	
0044200520	598659
0044200720	598636
0044201420	598613
0044202520	598300
0044204020	598728
0044204420	598637
0044205120	601034
0044205220	598802
0044205520	598044
0044206220	598995
0044206920	541728
0044208020	598995
0044208120	598876
0044208220	598881
0044208320	598882
0044208720	598638
0044209020	598659
0054200720	601051
0054202120	598882
0054204320	601051
0054204920	601051
0054207920	598637
0054209320	598637
1634200020	598442
1634200120	598443
1634200320	598442
1634200420	598443
1634200520	598813
1634200620	598445
1634200720	598719
1634200820	598445
1634200920	598719
1644200820	598728
1644201820	598728
1684200020	598549
1684200120	598549
1684200420	598583
1684200720	598549
1684200820	598549
1694200120	598795
1694200220	598704
1694200320	598704
1694200420	598583
1694200720	598704
1694200820	598795
1694201020	598704
1694201120	598583
2104200120	598712
4144200120	598583
4144200220	598582
4604200020	598613
6014207620	598613
6014208720	598613
6014217720	598000
6314200020	598112
6314200220	598112

	Valeo
MG	
EJP1437	598053
GBP90307AF	598392
GBP90323AF	598903
GBP90337AF	598254
SEM100020	598254
SFP000040	598811
SFP000070	598436
SFP000080	598682
SFP000360	598903
SFP000370	598436
SFP000380	598753
SFP000390	598022
SFP000410	598022
SFP10012	598903
SFP100260	598022
SFP100511	598632
SFP100520	598753
MINI	
34 11 1 503 076	598413
34 11 6 761 287	598413
34 11 6 765 446	598413
34 11 6 770 251	598925
34 11 6 770 332	598413
34 11 6 772 892	598699
34 11 6 778 320	598925
34 21 1 503 077	598643
34 21 6 761 288	598643
34 21 6 762 871	598643
34 21 6 770 252	598643
34 21 6 778 327	601041
MITSUBISHI	
4605A041	598518
4605A261	598886
4605A284	598893
4605A447	598520
4605A458	598777
4605A487	598520
4605A491	598886
M620770	598319
M850976	598493
M850978	598319
MB151324	598220
MB193216	598220
MB193295	598620
MB193296	598620
MB193299	598620
MB238509	598620
MB277192	598220
MB295886	598590
MB366284	598220
MB366969	598224
MB377826	598964
MB407430	598220
MB500813	598597

	Valeo
MITSUBISHI (.../...)	
MB500814	598597
MB500815	598597
MB500816	598597
MB500819	598597
MB534995	598964
MB587056	598220
MB587061	598220
MB587284	598220
MB618116	598220
MB618576	598224
MB668398	598220
MB699154	598964
MB699266	598625
MB699453	598517
MB699464	598626
MB699473	598626
MB699474	598626
MB699722	598964
MB699723	598964
MB857336	598834
MB857732	598964
MB858375	598625
MB858380	598519
MB858463	598519
MB895072	598625
MB928049	598517
MB928314	598844
MB928816	598626
MB950350	598834
MC112088	598590
MC894589	598589
MN102628	598520
MN116445	598518
MN125772	598319
MR162521	598224
MR162522	598220
MR162523	598597
MR162524	598597
MR205269	598519
MR235557	598318
MR249240	598320
MR249241	598318
MR389507	598626
MR389523	598597
MR389524	598597
MR389531	598220
MR389532	598625
MR389533	598625
MR389537	598625
MR389541	598625
MR389542	598517
MR389543	598517
MR389544	598517
MR389546	598517
MR389547	598522
MR389548	598517
MR389549	601020

	Valeo
MITSUBISHI (.../...)	
MR389550	598522
MR389555	598620
MR389561	598964
MR389562	598964
MR389565	598844
MR389566	598964
MR389569	598844
MR389571	598519
MR389572	598519
MR389575	598778
MR389578	598834
MR407376	598919
MR407391	598914
MR407944	598320
MR407946	598318
MR475453	598521
MR510544	598520
MR527550	598523
MR527656	598493
MR527675	598886
MR527868	598518
MR569403	598886
MR569597	601020
MR569780	598834
MR955068	598852
MR955351	598493
MR977117	598318
MR977365	598855
MW30620770	598319
MZ690010	598834
NISSAN	
06902656-0	598001
06905294-0	598112
06905294-1	598112
41060-00QAD	598537
41060-00QAE	598545
41060-00QAF	598726
41060-00QAG	598726
41060-01A25	598278
41060-01B25	598384
41060-01B26	598384
41060-03R85	598123
41060-03R86	598123
41060-04B90	598384
41060-04B91	598384
41060-04C85	598123
41060-05B25	598384
41060-05B26	598384
41060-05B90	598384
41060-08N90	598618
41060-08N91	598618
41060-08N92	598618
41060-09W26	598123
41060-09W92	598123
41060-09W93	598123
41060-0F025	598602





 Valeo	
NISSAN (.../...)	
41060-11P86	598123
41060-11P92	598123
41060-11P93	598123
41060-11P94	598123
41060-12A25	598278
41060-13A25	598278
41060-13E85	598123
41060-13E90	598123
41060-16C90	598123
41060-1F025	598014
41060-1N090	598071
41060-1N890	598071
41060-1W385	598452
41060-1W386	598452
41060-1W387	598452
41060-1W486	598452
41060-21P92	598123
41060-23C90	598618
41060-23C91	598618
41060-23C92	598618
41060-25A25	598278
41060-25N25	598123
41060-27N91	598618
41060-2F025	598054
41060-2F026	598054
41060-2F027	598054
41060-2F257	598450
41060-2F525	598450
41060-2F526	598450
41060-2F527	598450
41060-2N390	598806
41060-2N392	598806
41060-2S790	598618
41060-2X825	598602
41060-31E85	598123
41060-31E88	598123
41060-31E90	598123
41060-31E91	598123
41060-31E92	598123
41060-32E91	598123
41060-32R94	598786
41060-37G93	598123
41060-38U90	598523
41060-3S590	598618
41060-3Y690	598912
41060-40U90	598787
41060-40U92	598787
41060-41S86	598379
41060-41S87	598379
41060-41S88	598379
41060-44F92	598786
41060-48R91	598786
41060-4M525	598054
41060-4M526	598054
41060-4U125	598451
41060-4U126	598451
41060-4U127	598451

 Valeo	
NISSAN (.../...)	
41060-50Y91	598628
41060-50Y94	598628
41060-51E86	598123
41060-56L25	598123
41060-58A86	598296
41060-5M325	598450
41060-5M326	598450
41060-5T091	598123
41060-62A90	598278
41060-62A92	598278
41060-62C90	598628
41060-63C90	598628
41060-67A85	598296
41060-67A90	598278
41060-67R86	598840
41060-6F625	598014
41060-6F626	598014
41060-70J25	598024
41060-71J25	598054
41060-71J26	598054
41060-72A85	598296
41060-72A88	598296
41060-72A89	598296
41060-72J25	598024
41060-73A85	598296
41060-74F91	598476
41060-76A87	598296
41060-79E92	598786
41060-80N90	598786
41060-86R85	598840
41060-89A90	598278
41060-89A91	598278
41060-89E91	598787
41060-8H785	598452
41060-94M85	598296
41060-94M86	598296
41060-99B25	598014
41060-99B26	598014
41060-9C025	598123
41060-9C026	598123
41060-9C125	598602
41060-9C525	598602
41060-9C526	598602
41060-9X225	541733
41060-AV125	598451
41060-AV126	598451
41060-AX625	598641
41060-BM425	598054
41060-BM525	598450
41060-C7025	598122
41060-C7090	598122
41060-C7191	598122
41060-C7194	598122
41060-C7892	598122
41060-C8186	598122
41060-CC090	598738
41060-D1485	598379

 Valeo	
NISSAN (.../...)	
41060-D1488	598123
41060-D1490	598379
41060-D4690	598123
41060-D4726	598379
41060-D6090	598123
41060-EB325	598738
41060-EB326	598738
41060-F5025	598379
41060-F5027	598379
41060-F5029	598379
41060-T6425	598122
41060-T7890	598122
41060-T7891	598122
41060-T7893	598122
41060-V5094	598123
41060-V6791	598123
41060-V6794	598123
41060-V7085	598618
41060-V7090	598123
41060-V7091	598618
41060-V7093	598618
41060-VC091	598524
41060-VH385	598452
41060-VJ490	598618
41060-VK190	598889
41060-W1225	598379
41060-W2225	598379
41060-W2727	598379
41060-Y9601	598123
41060-Y9601	598123
41083-AX626	598641
44060-BA00F	598472
44060-00QAE	598538
44060-00QAF	598546
44060-0M890	598449
44060-0N690	598668
44060-20J85	598851
44060-31U90	598668
44060-31U92	598668
44060-32J85	598851
44060-3F025	598057
44060-3F085	598057
44060-4U090	598668
44060-50A86	598826
44060-58Y86	598826
44060-61E91	598817
44060-70J26	598057
44060-73A85	598826
44060-73C91	598668
44060-75C90	598668
44060-7E690	598668
44060-8H385	598672
44060-90E90	598817
44060-99B25	598642
44060-99B85	598642
44060-AL585	598672
44060-AV625	598472
44060-AV725	598472

 Valeo	
NISSAN (.../...)	
44060-BM425	598057
44060-BM426	598057
44060-D3591	598817
44060-EB325	598730
44060-VB190	601002
44060-VC090	601002
D1060-11P27	598123
D1060-11P88	598123
D1060-11P91	598123
D1060-11P92	598123
D1060-11P93	598123
D1060-2S790	598618
D1060-32E25	598123
D1060-3Y690	598912
D1060-76A86	598278
D1060-88E87	598787
D1060-88E91	598787
D1060-8H785	598452
D1060-AX60A	598641
D1060-AX61A	598641
D1060-AX61F	598641
D1060-C7192	598122
D1060-EM10A	601013
D1060-MB600	541737
D1060-V6794	598123
D1060-V7090	598618
D1060-V7091	598618
D1060-VC091	598524
D1060-VK190	598889
D4060-4U090	598668
D4060-8H385	598672
D4060-BM40A	598057
D4060-EM11A	601009
D4060-JA00A	601009
D4060-MA000	541738
D4060-VC090	601002
D40F0-CD026	598914
D40F0-CD094	598914
OPEL	
1605000	598322
1605002	598661
1605003	598050
1605004	598256
1605005	598187
1605006	598183
1605009	598454
1605025	598926
1605026	598183
1605031	598183
1605032	598475
1605033	598256
1605034	598322
1605035	598454
1605036	598305
1605039	598926
1605040	598926



 →	Valeo
OPEL (.../...)	
1605047	598183
1605067	598458
1605070	598322
1605079	598808
1605080	598860
1605081	598456
1605084	598661
1605086	598584
1605087	598356
1605088	598678
1605089	598184
1605091	598322
1605092	598456
1605093	598926
1605094	598678
1605095	598678
1605098	598678
1605099	598860
1605105	598926
1605113	598678
1605117	598783
1605122	598584
1605123	598941
1605136	598678
1605137	598678
1605138	598808
1605139	598678
1605195	598822
1605202	601048
1605252	598860
1605282	598678
1605283	598678
1605321	598108
1605353	598825
1605354	598839
16053540	598839
1605356	598722
1605357	598825
16053590	598825
1605366	601049
1605398	598108
1605434	601046
1605456	598860
1605466	598099
1605516	598111
1605543	598099
1605586	598182
1605612	598186
1605624	601047
1605625	598584
1605670	598182
1605687	598183
1605688	598243
1605703	598182
1605704	598182
1605710	598099
1605712	598099



 →	Valeo
OPEL (.../...)	
1605713	598108
1605714	598108
1605715	598108
1605718	598111
1605722	598111
1605728	598253
1605746	598184
1605760	598186
1605782	598256
1605783	598182
1605787	598182
1605788	598182
1605789	598184
1605790	598186
1605791	598182
1605795	598182
1605799	598183
1605808	598184
1605810	598356
1605820	598182
1605824	598356
1605825	598020
1605848	598460
1605851	598507
1605852	598460
1605855	598050
1605870	598182
1605877	598253
1605878	598243
1605879	598183
1605881	598356
1605883	598183
1605907	598356
1605911	598184
1605912	598305
1605913	598460
1605916	598020
1605924	598183
1605931	598020
1605932	598256
1605939	598459
1605947	598458
1605957	598454
1605959	598322
1605961	598926
1605964	598456
1605965	598457
1605966	598305
1605967	598584
1605972	598678
1605973	598472
1605974	598456
1605976	598453
1605979	598490
1605980	598537
1605982	598538
1605984	598475



 →	Valeo
OPEL (.../...)	
1605992	598860
1605993	598783
1605994	598457
1605995	598584
1605996	598860
1605997	598860
1605998	598860
1777990	598305
4402993	598537
4403271	598086
4403272	598086
4403467	598538
4404585	598537
4414021	598545
4414029	598546
4414519	598545
4414520	598546
4501150	598490
4502797	598490
4704578	598453
4706748	598453
4706835	598453
4708239	598847
4808861	598942
542027	601049
9111271	598086
PEUGEOT	
4245-33	598374
4245-34	598338
4245-35	598374
4245-56	598193
4245-57	598193
4245-67	598085
4245-96	598375
4248-15	598174
4248-16	598193
4248-30	598085
4248-33	598153
4248-34	598178
4248-61	598077
4248-64	598078
4248-68	598375
4248-70	598375
4248-72	598375
4248-86	598375
4248-87	598081
4248-89	598162
4248-91	598099
4248-95	598113
4248-96	598161
4248-97	598163
4248-98	598592
4250-01	598088
4250-02	598111
4250-03	598174
4250-06	598174



 →	Valeo
PEUGEOT (.../...)	
4250-07	598193
4250-08	598193
4250-09	598375
4250-10	598078
4250-11	598078
4250-12	598593
4250-15	598150
4250-16	598178
4250-19	598593
4250-20	598178
4250-21	598175
4250-22	598178
4250-23	598175
4250-24	598178
4250-25	598175
4250-30	598594
4250-32	598081
4250-33	598081
4250-34	598338
4250-35	598081
4250-37	598176
4250-39	598176
4250-40	598178
4250-41	598084
4250-42	598396
4250-43	598177
4250-47	598138
4250-49	598081
4250-50	598081
4250-51	598177
4250-54	598153
4250-55	598179
4250-56	598180
4250-57	598081
4250-58	598138
4250-59	598592
4250-60	598113
4250-61	598161
4250-63	598163
4250-64	598375
4250-65	598162
4250-67	598078
4250-68	598375
4250-69	598177
4250-70	598084
4250-71	598396
4250-72	598081
4250-73	598193
4250-74	598613
4250-75	598081
4250-76	598081
4250-77	598176
4250-78	598179
4250-80	598294
4250-81	598295
4250-82	598176
4250-85	598593



	
PEUGEOT (.../...)	
4250-87	598179
4250-88	598081
4250-89	598280
4250-90	598156
4250-91	598181
4250-92	598181
4250-93	598179
4250-94	598281
4250-95	598179
4250-96	598174
4250-97	598081
4250-99	598153
4251-02	598181
4251-04	598396
4251-05	598138
4251-06	598153
4251-07	598353
4251-08	598180
4251-09	598064
4251-11	598502
4251-15	598150
4251-16	598070
4251-18	598800
4251-20	598181
4251-21	598038
4251-22	598038
4251-25	598073
4251-27	598075
4251-30	598063
4251-31	598068
4251-32	598069
4251-34	598074
4251-35	598179
4251-36	598175
4251-41	598081
4251-42	598074
4251-43	598069
4251-48	598396
4251-51	598073
4251-52	598462
4251-54	598326
4251-60	598069
4251-64	598156
4251-65	598181
4251-67	598074
4251-79	598099
4251-82	598466
4251-93	598295
4251-95	598466
4251-96	598396
4252-04	598461
4252-06	598467
4252-07	598468
4252-08	598063
4252-12	598461
4252-19	598466
4252-20	598553

	
PEUGEOT (.../...)	
4252-21	598464
4252-22	598465
4252-23	598463
4252-24	598429
4252-25	598430
4252-28	598461
4252-29	598462
4252-32	598463
4252-38	598464
4252-39	598464
4252-42	598568
4252-44	598569
4252-46	598570
4252-50	598465
4252-51	598466
4252-52	598465
4252-54	598468
4252-56	598396
4252-59	598464
4252-60	598715
4252-61	598081
4252-62	598081
4252-63	598181
4252-64	598181
4252-65	598181
4252-66	598063
4252-67	598074
4252-68	598068
4252-70	598179
4252-71	598396
4252-75	598075
4252-76	598464
4252-77	598662
4252-78	598663
4252-79	598664
4252-82	598176
4252-84	598156
4252-86	598156
4253-02	598461
4253-03	598461
4253-04	598074
4253-08	598175
4253-09	598594
4253-10	598084
4253-11	598396
4253-12	598593
4253-14	598181
4253-15	598038
4253-16	598038
4253-20	598461
4253-22	598702
4253-26	598664
4253-27	598718
4253-35	598662
4253-36	598663
4253-37	598663
4253-38	598464

	
PEUGEOT (.../...)	
4253-39	598465
4253-40	598702
4253-41	598464
4253-43	598715
4253-47	598662
4253-48	598663
4253-55	598891
4253-57	598891
4253-59	598892
4253-63	598899
4253-65	598899
4253-67	601039
4253-78	598398
4253-83	598663
4253-85	598465
4253-90	598852
4253-93	598927
4253-96	598180
4253-98	598702
4254-01	598702
4254-06	598426
4254-10	598663
4254-12	598997
4254-14	601042
4254-18	598465
4254-19	598702
4254-20	598474
4254-21	598664
4254-22	598662
4254-23	598464
4254-25	598997
4254-26	598927
4254-28	598463
4254-29	601042
4254-50	598074
4254-51	598070
4254-53	598064
4254-54	598073
4254-55	598429
4254-56	598430
4254-57	598553
4254-58	598568
4254-59	598569
4254-61	598891
4254-62	598891
4254-67	598463
4254-68	598570
4254-69	598892
4254-71	598465
4254-74	598718
4254-75	598464
4254-77	598998
4254-88	598715
4254-89	598465
4254-91	598664
4254-92	598465
4254-94	598461

	
PEUGEOT (.../...)	
4254-97	601039
PORSCHE	
911 351 950 02	598111
955 351 939 02	598655
955 351 939 03	598655
955 351 939 04	598655
955 351 939 10	598656
955 351 939 11	598656
955 351 939 12	598656
955 351 939 13	598656
955 351 939 14	598656
955 351 939 50	598709
955 352 939 00	598770
955 352 939 01	598770
955 352 939 02	598770
955 352 939 50	598770
986 351 939 11	598766
986 351 939 13	598766
986 351 939 15	598766
986 352 939 10	598768
987 352 939 00	598768
987 352 939 01	598768
996 352 939 00	598768
996 352 939 03	598768
996 352 949 02	598767
996 352 949 03	598767
PROTON	
MB858375	598625
MB928314	598844
MB928816	598626
MR389507	598626
MR389533	598625
MR389565	598844
RELIANT	
RTGBP3360	598116
RTGBP3400	598391
RTGBP3410	598391
RTGBP6560	598118
RENAULT	
410600012R	601012
410600023R	598738
410600629R	601050
410600756R	598993
410601237R	601012
410603303R	598861
410608713R	598558
440600002R	598783
440600295R	598474
440601416R	601000
440601689R	598783
440603530R	598474
440603734R	601000



Valeo	
RENAULT (.../...)	
440603905R	601045
440608746R	601050
5001000478	598374
5001844747	541683
5001850859	541683
6000004729	598077
6000004734	598085
6000008125	598151
6000008126	598002
6000008304	598151
6000008895	598061
6000008898	598294
6000009332	598294
6000009363	598294
6000061026	598175
6025070807	598002
6025071042	598084
6025071055	598085
6025071056	598085
6025071188	598077
6025170170	598382
6025170585	598085
6025170586	598085
6025170860	598085
6025171456	598382
6025308186	598055
6025315867	598470
6025370398	598470
6025370851	598470
6025371279	598545
6025371650	598180
6025371662	598669
6025407835	598470
602540914	598545
7701050914	598545
7701050918	598546
7701054771	598545
7701054772	598546
7701200360	598085
7701200648	598086
7701200734	598076
7701200884	598086
7701201059	598377
7701201095	598085
7701201159	598076
7701201164	598077
7701201183	598076
7701201296	598077
7701201297	598077
7701201300	598077
7701201309	598085
7701201311	598085
7701201321	598085
7701201464	598377
7701201470	598085
7701201534	598366
7701201622	598374
7701201669	598002

Valeo	
RENAULT (.../...)	
7701201773	598002
7701201774	598002
7701201775	598002
7701201781	598085
7701202044	598086
7701202050	598061
7701202057	598081
7701202148	598085
7701202210	598396
7701202213	598080
7701202216	598081
7701202217	598081
7701202227	598080
7701202283	598081
7701202284	598002
7701202285	598084
7701202289	598002
7701202302	598081
7701202308	598396
7701202308	598081
7701202308	598396
7701202475	598081
7701202481	598082
7701202516	598084
7701202517	598080
7701202518	598081
7701202539	598084
7701202540	598084
7701202662	598396
7701202709	598366
7701202710	598080
7701202711	598081
7701202712	598084
7701202713	598086
7701202785	598082
7701202788	598085
7701202815	598082
7701202847	598081
7701202848	598002
7701202890	598085
7701202891	598080
7701202892	598081
7701202893	598076
7701202894	598084
7701202895	598084
7701202896	598061
7701202903	598077
7701202954	598077
7701202955	598375
7701202956	598086
7701202973	598061
7701202974	598377
7701203068	598085
7701203069	598082
7701203070	598061
7701203071	598374
7701203124	598055
7701203129	598084
7701203282	598084

Valeo	
RENAULT (.../...)	
7701203633	598055
7701203635	598080
7701203668	598158
7701203726	598055
7701203775	598002
7701203795	598002
7701203796	598002
7701203797	598002
7701203842	598080
7701203913	598086
7701203917	598086
7701203918	598086
7701203919	598158
7701203967	598599
7701203968	598061
7701203969	598396
7701204036	598158
7701204066	598002
7701204087	598082
7701204220	598061
7701204357	598002
7701204358	598002
7701204417	598061
7701204530	598081
7701204593	598366
7701204626	598396
7701204664	598396
7701204670	598599
7701204708	598081
7701204833	598002
7701204845	598396
7701204903	598081
7701205014	598366
7701205015	598055
7701205277	598080
7701205294	598490
7701205355	598002
7701205491	598328
7701205513	598726
7701205995	598726
7701205996	598726
7701206288	598061
7701206343	598180
7701206369	598490
7701206379	598473
7701206598	598566
7701206599	598471
7701206609	598472
7701206727	598537
7701206747	598471
7701206763	598538
7701206784	598180
7701206811	598726
7701207034	598396
7701207066	598002
7701207166	598490
7701207187	598527



Valeo	
RENAULT (.../...)	
7701207339	598537
7701207484	598180
7701207615	598471
7701207672	598558
7701207673	598557
7701207695	598180
7701207968	598472
7701207977	598471
7701207996	598783
7701208122	598558
7701208142	598726
7701208182	598471
7701208183	598566
7701208213	598180
7701208218	598861
7701208265	598002
7701208416	598180
7701208421	598180
7701208422	598641
7701209100	601012
7701209101	598993
7701209380	598473
7701209444	598558
7701209639	598002
7701209670	601012
7701209672	598993
7701209735	598474
7701209808	598566
7701209809	598471
7701209810	598471
7701209841	598474
7701209864	601010
7701209869	601011
7701210110	601010
7701210142	598002
7701210174	601010
7701348071	598085
7701348111	598086
7701348478	598366
7701348681	598375
7701348682	598366
7701348683	598085
7701348684	598085
7701348688	598086
7701348689	598085
7701348863	598085
7701349049	598085
7701349255	598374
7701349448	598085
7701349449	598377
7701349751	598002
7701349969	598081
7701349970	598084
7701349973	598084
7711130008	598081
7711130034	598081
7711130036	598002



Valeo	
RENAULT (.../...)	
7711130071	598002
7711130086	601012
8305252531	598491
8308133853	598595
8983502200	598595
D4060-JA00A	601009
ROVER	
EJP1437	598053
GBP242AF	598391
GBP258AF	598116
GBP259AF	598117
GBP264	598185
GBP268	598391
GBP269AF	598185
GBP275	598391
GBP287	598391
GBP289AF	598131
GBP292AF	598391
GBP310AF	598131
GBP311AF	598227
GBP574	598338
GBP656AF	598118
GBP90213	598392
GBP90242	598391
GBP90287	598391
GBP90288	598118
GBP90289	598131
GBP90293	598131
GBP90296AF	598118
GBP90298	598227
GBP90306AF	598116
GBP90307AF	598392
GBP90309AF	598227
GBP90310AF	598131
GBP90311AF	598227
GBP90314AF	598019
GBP90315AF	598022
GBP90316AF	598053
GBP90317AF	598118
GBP90318AF	598254
GBP90320AF	598254
GBP90321AF	598022
GBP90323AF	598903
GBP90324AF	598022
GBP90325AF	598022
GBP90326AF	598019
GBP90328AF	598019
GBP90329AF	598627
GBP90330AF	598056
GBP90331AF	598682
GBP90336AF	598022
GBP90337AF	598254
GBP90338AF	598056
GBP90339AF	598682
GBP90340AF	598022
GBP90341AF	598753



Valeo	
ROVER (.../...)	
GBP90342AF	598632
RTC3163	598129
RTC3164	598497
RTC4519	598497
RTC5756	598129
RTC6591	598497
RTC6781	598498
SEM100020	598254
SFP000040	598811
SFP000070	598436
SFP000080	598682
SFP000360	598903
SFP000370	598436
SFP000380	598753
SFP000390	598022
SFP000410	598022
SFP10012	598903
SFP100180EVA	598022
SFP100190EVA	598022
SFP100260	598022
SFP100511	598632
SFP100520	598753
RVI	
5001844747	541683
5001850859	541683
SAAB	
12759808	601006
12799240	598472
12800120	598678
12802167	598808
12803551	598678
4196317	598291
4467049	598050
4467072	598253
4646899	598050
4778254	598305
4836987	598183
4837241	598183
4839700	598269
4839924	598475
5055371	598475
5055769	598269
5057336	598183
5058110	598753
5062203	598305
5062211	598475
5064795	598475
5124078	598475
5392485	598475
5532544	598475
5533518	598475
7872906	598099
8968018	598237
8968026	598291



Valeo	
SAAB (.../...)	
8968976	598269
8993230	598187
8993719	598269
8993768	598269
8993974	598237
8994832	598187
9102716	598187
93183140	598783
93185751	598678
93188111	598678
93188112	598678
93190338	598472
93190340	598808
93192749	598475
93195754	598822
SANTANA	
00000A00906	598531
55200-56870	598533
55200-63810	598023
SEAT	
191698151E	598127
191698151F	598127
191698151G	598124
191698151H	598128
191698151J	598128
191698451C	598180
191698451D	598180
1H0698151	598128
1H0698151A	598066
1H0698151B	598403
1H0698451	598180
1H0698451A	598180
1H0698451C	598180
1H0698451D	598463
1H0698451E	598180
1H0698451F	598180
1HM698151	598330
1HM698151A	598330
1J0698151	598332
1J0698151A	598332
1J0698151B	598332
1J0698151D	598408
1J0698151E	598408
1J0698151G	598408
1J0698151H	598332
1J0698151J	598332
1J0698151L	598303
1J0698151M	598486
1J0698451	598463
1J0698451C	598463
1J0698451F	598180
1J0698451J	598463
1J0698451M	598180
1J0698451S	598463

Valeo	
SEAT (.../...)	
1K0698151	598635
1K0698151A	598408
1K0698151B	598863
1K0698151E	598635
1K0698151F	598408
1K0698451A	598463
1K0698451C	598463
1K0698451D	598752
1K0698451F	598752
1K0698451G	598752
1K0698451H	598752
1K0698451J	598463
1ML698151	598859
357698151	598017
357698151A	598016
357698151B	598252
357698151E	598330
3980051	598093
3C0698151B	598635
4D0698451C	598463
5888154	598090
6N0698151	598488
6N0698151C	598488
6Q0698151	598332
6Q0698151A	598667
6Q0698151B	598805
6Q0698151C	598720
6Q0698451	598674
6Q0698451B	598674
6X0698451	598463
6X0698451A	598463
790475	598088
7D0698451F	598650
7M0698151	598067
7M0698451	598463
7M3698151	598489
7M3698151A	598565
7M3698151B	598801
7M3698451	598681
7M3698451B	598681
7M3698451C	598681
7M3698451D	598650
867698151	598258
8E0698151K	598483
8E0698151L	598779
8E0698151M	598484
8E0698451J	598752
8E0698451L	598474
8N0698151	598303
8N0698151A	598486
SE021165081A	598091
SE021165081B	598091
SE022165081A	598091
SE127165005A	598603
SE127165081A	598093
SE131165081A	598091
SE141165081A	598091

	
SEAT (.../...)	
SE141165081C	598093
SKODA	
004 532 247A	598217
113 430 282R	601016
115 430 280	598217
115 430 285	598217
1J0698151	598332
1J0698151A	598332
1J0698151B	598332
1J0698151D	598408
1J0698151E	598408
1J0698151G	598408
1J0698151H	598332
1J0698151J	598332
1J0698151L	598303
1J0698151M	598486
1J0698451	598463
1J0698451C	598463
1J0698451F	598180
1J0698451J	598463
1J0698451M	598180
1J0698451S	598463
1K0698151	598635
1K0698151A	598408
1K0698151B	598863
1K0698151D	598408
1K0698151E	598635
1K0698151F	598408
1K0698451	598752
1K0698451C	598463
1K0698451J	598463
3B0698451A	598463
3C0698151B	598635
3C0698151C	598635
4B0698151AB	598483
4B0698151N	598751
5K0698151	598635
6N0698151B	598330
6N0698151C	598488
6Q0698151	598332
6Q0698151A	598667
6Q0698151B	598805
6Q0698151C	598720
6Q0698451	598674
6Q0698451B	598674
6U0698151	598217
6U0698151A	598217
6U0698151B	598217
6U0698151C	598217
6U0698151D	598217
6U0698151E	598217
8E0698151J	598483
8E0698451A	598463
8N0698151	598303
8N0698151A	598486

	
SSANGYONG	
48130-05100	598528
48130-08050	598870
48130-08150	598870
48130-08151	598870
48130-08152	598870
48130-08260	598871
48130-091A0	598505
4813A-21100	598871
48413-05000	598854
48413-21B10	598748
SUBARU	
26296 AA000	598691
26296 AA020	598691
26296 AA040	598691
26296 AA060	598828
26296 AA061	598828
26296 AA062	598828
26296 AA080	598828
26296 AA081	598828
26296 AA082	598828
26296 AA100	598691
26296 AA101	598691
26296 AA120	598691
26296 AA121	598691
26296 AA141	598691
26296 AA142	598691
26296 AA143	598691
26296 AC010	598915
26296 AC011	598915
26296 AC020	598915
26296 AC021	598915
26296 AC041	598530
26296 AC050	598530
26296 AE020	598530
26296 AE140	598530
26296 AE141	598530
26296 AE210	598530
26296 AG040	598853
26296 FA000	598691
26296 FA001	598691
26296 FA040	598476
26296 FA041	598476
26296 FA100	598476
26296 FA101	598476
26296 FA102	598476
26296 FA170	598476
26296 FC002	598895
26296 FE041	598919
26296 FE042	598919
26296 FE070	598476
26296 FE081	598853
26296 FE090	598476
26296 FE100	598919
26296 PA060	598828
26296 SA011	598853
26296 SA020	598853

	
SUBARU (.../...)	
26296 SA030	598853
26296SA010	598853
26696 AG010	598929
26696 AG020	598895
26696 FA000	598916
26696 FC001	598895
26696 FC002	598895
26696 FE001	598914
26696 FE050	598875
26696 FE070	598916
26696 FE080	598914
55200-61880	598666
55200-80E10	598991
55810-84E01	598453
7251 91630	598278
7251 91631	598278
SUZUKI	
00000A00906	598531
00000A01225	598531
55110-80000	598021
55200-50J01	598878
55200-50J02	598878
55200-56831	598533
55200-56870	598533
55200-61880	598666
55200-62810	598296
55200-62840	598666
55200-62851	598986
55200-63810	598023
55200-65D00	598534
55200-65D10	598534
55200-65J00	598877
55200-65J01	598877
55200-65J10	598877
55200-65J11	598877
55200-77E00	598534
55200-80E10	598991
55200-81A10	598021
55200-83830	598532
55210-78450	598185
55210M84500	598185
55800-60G00	598830
55800-60J10	598831
55800-61G60	598830
55800-61G70	598830
55800-62G00	598624
55800-62G01	598624
55800-62G60	598830
55810-54G00	598848
55810-54G50	598848
55810-54G61	598848
55810-60J10	598733
55810-62J00	598847
55810-64G01	598697
55810-75F00	598843
55810-75F10	598843

	
SUZUKI (.../...)	
55810-76A00	598733
55810-76A01	598733
55810-79J00	598804
55810-80G01	598832
55810-80G10	598832
55810-80G12	598733
55810-83E00	598453
55810-84E01	598453
TALBOT	
0030666300	598085
0032708200	598085
0032796000	598085
4245-34	598338
4248-61	598077
4248-64	598078
4248-68	598375
4248-70	598375
4248-72	598375
4248-87	598081
4248-91	598099
4248-92	598187
4248-93	598161
4250-01	598088
4250-02	598111
4250-03	598174
4250-16	598178
4250-22	598178
4250-59	598592
4250-60	598113
4250-61	598161
4250-63	598163
4250-64	598375
4250-65	598162
4250-67	598078
4250-68	598375
4250-73	598193
4250-75	598081
4250-96	598174
4251-79	598099
TOYOTA	
04465-02130	598679
04465-02160	601040
04465-02170	598943
04465-02200	601040
04465-02270	601040
04465-05010	598551
04465-05020	598478
04465-05030	598478
04465-05040	598478
04465-05042	598478
04465-05050	598653
04465-05060	598478
04465-05080	598653
04465-05090	598653





	Valeo
TOYOTA (.../...)	
04465-05110	598478
04465-05130	598665
04465-05131	598665
04465-05140	598665
04465-05170	598665
04465-05210	598665
04465-05220	598665
04465-05221	598665
04465-0D010	598736
04465-0D040	598736
04465-0D050	601026
04465-0H020	598718
04465-0K130	598894
04465-0W050	598917
04465-0W080	598917
04465-10020	598815
04465-10040	598266
04465-10070	598815
04465-12020	598266
04465-12040	598266
04465-12090	598266
04465-12160	598809
04465-12220	598266
04465-12240	598579
04465-12490	598266
04465-12540	598579
04465-12610	598943
04465-13020	598917
04465-13030	598827
04465-13050	598917
04465-14080	601023
04465-14081	601023
04465-16010	598266
04465-16040	598266
04465-16070	598266
04465-16120	598266
04465-17050	598809
04465-17070	598266
04465-17100	598737
04465-17101	598737
04465-17140	598737
04465-20120	598551
04465-20160	598266
04465-20170	598266
04465-20200	598266
04465-20270	598266
04465-20300	598266
04465-20500	598827
04465-20510	598809
04465-26100	598947
04465-26130	598947
04465-26160	598947
04465-26170	598947
04465-26190	598614
04465-26210	598402
04465-26230	598402
04465-26250	598947

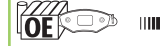

	Valeo
TOYOTA (.../...)	
04465-26300	598947
04465-26301	598947
04465-26330	598402
04465-26340	598947
04465-26370	598947
04465-28040	598496
04465-28130	598496
04465-28160	598177
04465-28170	598496
04465-28171	598496
04465-28340	598496
04465-28350	598496
04465-28490	598710
04465-2B020	598809
04465-2B040	598827
04465-30110	601023
04465-33020	598551
04465-33040	598551
04465-33050	598551
04465-33260	598862
04465-33440	598890
04465-35020	598614
04465-35031	598897
04465-35040	598897
04465-35080	598897
04465-35140	598393
04465-35160	598614
04465-35170	598921
04465-35180	598921
04465-35190	598393
04465-35210	598921
04465-35230	598393
04465-35240	598393
04465-35260	598897
04465-35290	598857
04465-36010	598614
04465-42010	598551
04465-42011	598551
04465-42070	598536
04465-42071	598536
04465-42080	598536
04465-42130	598536
04465-42140	601037
04465-44020	598551
04465-44060	598541
04465-44090	598541
04465-52010	598737
04465-52011	598737
04465-52070	598606
04465-52130	598606
04465-52140	598606
04465-52200	598896
04465-52270	601052
04465-59020	598606
04465-60020	598393
04465-60030	598897
04465-60060	598921



	Valeo
TOYOTA (.../...)	
04465-60120	598535
04465-60130	598897
04465-60140	598535
04465-60150	598535
04465-60151	598535
04465-60160	598535
04465-60230	598535
04465-60240	598535
04465-60270	598857
04466-02010	598810
04466-02060	598810
04466-02070	598680
04466-02160	598680
04466-02170	598933
04466-02190	598933
04466-02191	598933
04466-05010	598812
04466-0D010	601028
04466-12031	598984
04466-12040	598984
04466-12070	598984
04466-12130	598933
04466-17020	598983
04466-17030	598983
04466-17040	598983
04466-17051	598983
04466-17080	598983
04466-20020	598540
04466-20060	598540
04466-20090	598577
04466-20130	598810
04466-20130	598810
04466-28030	598542
04466-28040	598542
04466-28070	598542
04466-28080	598542
04466-30030	601022
04466-30050	601022
04466-30120	601025
04466-30121	601025
04466-32010	598540
04466-33160	598819
04466-42010	598673
04466-42010	598673
04466-42020	598673
04466-42060	598819
04466-52010	598577
04466-52020	598577
04466-52030	598577
04466-52040	598577
04466-52050	598577
04466-52120	598933
04466-52140	598933
04466-52150	598933
04466-60010	598777
04466-60020	598777
04466-60030	598865
04466-60050	598777
04466-60070	598865



	Valeo
TOYOTA (.../...)	
04466-60080	598777
04466-60090	598777
04491-05010	598551
04491-10131	598815
04491-10141	598815
04491-10161	598266
04491-12170	598266
04491-12230	598266
04491-12231	598266
04491-12250	598266
04491-12251	598266
04491-12280	598266
04491-12281	598266
04491-12320	598266
04491-12321	598266
04491-12322	598266
04491-12323	598266
04491-12330	598266
04491-12331	598266
04491-12421	598266
04491-12422	598266
04491-12432	598266
04491-12440	598266
04491-12490	598266
04491-12491	598266
04491-12540	598266
04491-12541	598266
04491-12650	598551
04491-12651	598551
04491-14320	601023
04491-14360	601023
04491-16040	598266
04491-16041	598266
04491-17030	598266
04491-17160	598809
04491-17170	598809
04491-20191	598266
04491-20192	598266
04491-20220	598266
04491-20310	598266
04491-20311	598266
04491-20380	598266
04491-20470	598266
04491-20471	598266
04491-20500	598266
04491-20501	598266
04491-20581	598402
04491-20590	598266
04491-20591	598266
04491-20620	598266
04491-20670	598266
04491-20680	598266
04491-20710	598266
04491-20740	598266
04491-20820	598266
04491-20890	598551
04491-26021	598614







	
VOLKSWAGEN	
171698151B	598099
171698151C	598099
171698151D	598099
171698151E	598099
171698151F	598128
171698151G	598128
171698151H	598099
176698151	598128
191698151	598127
191698151A	598127
191698151B	598124
191698151C	598128
191698151D	598128
191698151E	598127
191698151F	598127
191698151G	598124
191698151H	598128
191698151J	598128
191698451	598180
191698451A	598180
191698451B	598180
191698451C	598180
191698451D	598180
1E0698451	598180
1E0698451A	598180
1H0698151	598128
1H0698151A	598066
1H0698151B	598403
1H0698451	598180
1H0698451A	598180
1H0698451C	598180
1H0698451D	598463
1H0698451E	598180
1H0698451F	598180
1HM698151	598330
1J0698151	598332
1J0698151A	598332
1J0698151B	598332
1J0698151D	598408
1J0698151E	598408
1J0698151F	598408
1J0698151G	598408
1J0698151J	598332
1J0698151K	598486
1J0698151M	598486
1J0698451	598463
1J0698451B	598463
1J0698451C	598463
1J0698451D	598463
1J0698451E	598463
1J0698451F	598180
1J0698451G	598463
1J0698451J	598463
1K0698151	598635
1K0698151A	598408
1K0698151B	598863
1K0698151C	598635



	
VOLKSWAGEN (.../...)	
1K0698151D	598408
1K0698151E	598635
1K0698151F	598408
1K0698451	598752
1K0698451A	598463
1K0698451C	598463
1K0698451J	598463
1K0698451M	598463
211698151F	598111
211698151G	598111
251698151	598106
251698151A	598106
251698151B	598106
251698151C	598027
251698151D	598106
251698151E	598106
251698151F	598027
281698151A	598109
281698151B	598110
291698151	598613
291698151A	598613
2D0698151	598044
2D0698151A	541664
2D0698151B	598966
2D0698151C	598044
2D0698451	598046
2D0698451A	598045
2D0698451B	598300
2D0698451C	598045
2D0698451D	598045
2E0698151	598882
2E0698151A	598881
2E0698451	541728
2E0698451A	598876
311698151B	598187
311698151C	598099
311698151D	598187
321698151A	598205
321698151B	598124
321698151C	598128
321698151D	598124
321698151E	598124
321698151F	598128
321698151G	598128
321698151H	598124
321698151J	598128
357698151	598017
357698151A	598016
357698151B	598252
357698151C	598982
357698151E	598330
3A0698151	598303
3A0698151A	598303
3B0698451A	598463
3B7698151	598712
3C0698151	598635
3C0698151A	598635

	
VOLKSWAGEN (.../...)	
3C0698151B	598635
3C0698151C	598635
3C0698451	598752
3C0698451A	598752
3C0698451B	598752
3C0698451C	598752
3C0698451D	598752
3C0698451E	598752
3D0698151B	598992
411698151E	598099
431698151D	598017
431698151E	598205
431698151F	598017
431698151G	598017
431698151H	598205
431698151J	598375
437698151	598017
437698451	598125
443698151A	598017
443698151C	598017
443698151D	598017
443698151F	598017
443698151G	598017
443698151H	598017
443698151J	598017
443698151K	598017
443698451	598125
443698451A	598125
443698451B	598125
443698451C	598125
447698151A	598230
447698151B	598230
447698151E	598230
447698151F	598230
447698451	598125
447698451A	598125
447698451C	598125
4A0698451	598125
4B0698151E	598483
4B0698151J	598483
4B0698151N	598751
4B0698451	598463
4B0698451B	598463
4B0698451E	598463
4D0698451A	598125
4D0698451C	598463
4E0698151	598845
533698151	598004
533698151A	598004
5K0698151	598635
5N0698151	601036
6E0698151	598735
6N0698151	598488
6N0698151A	598330
6N0698151B	598330
6N0698151C	598488
6Q0698151	598332
6Q0698151A	598667



	
VOLKSWAGEN (.../...)	
6Q0698151B	598805
6Q0698151C	598720
6Q0698451	598674
6Q0698451B	598674
6R0698151A	598332
6U0698151	598217
6U0698151A	598217
6X0698451	598463
6X0698451A	598463
701698151	598048
701698151A	598048
701698151B	598048
701698151C	598025
701698151E	598622
701698151F	598048
701698151G	598048
701698451	598482
7D0698151	598675
7D0698151A	598858
7D0698151B	598814
7D0698151C	598807
7D0698151D	598676
7D0698451	598482
7D0698451A	598482
7D0698451B	598650
7D0698451C	598650
7D0698451D	598482
7D0698451E	598482
7D0698451F	598650
7D0698451G	598482
7D0698451J	598482
7H0698151	598651
7H0698151A	598652
7H0698151B	598651
7H0698151C	598652
7H0698451	598671
7H0698451A	601004
7H0698451B	598671
7H8698451	598946
7L0698151D	598655
7L0698151E	598656
7L0698151F	598655
7L0698151G	598656
7L0698151H	598655
7L0698151J	598656
7L0698451A	598770
7L0698451B	598770
7L6698151	598655
7L6698151A	598656
7L6698151B	598940
7L6698151C	598655
7L6698151D	598656
7L6698151E	598994
7L6698451	598967
7L6698451A	598770
7M0698151	598067
7M0698451	598463



 	
VOLKSWAGEN (.../...)	
7M3698151	598489
7M3698151A	598565
7M3698151B	598801
7M3698451	598681
7M3698451C	598681
7M3698451D	598650
803698151C	598099
803698151K	598375
803698151M	598375
811698151	598099
811698151A	598205
811698151B	598205
853698151	598004
853698151A	598004
857698451	598125
859698451	598125
861698151	598099
861698151A	598099
867698151	598258
8A0698151B	598017
8D0698151A	598355
8D0698151C	598355
8D0698151D	598712
8D0698151F	598355
8E0698151	598017
8E0698151A	598017
8E0698151B	598484
8E0698151C	598779
8E0698451	598463
8E0698451A	598463
8N0698151	598303
8N0698151A	598486
J0449135160	598897
VOLVO	
270163.9	598337
270164.7	598338
270166.2	598270
270195.1	598221
270923.6	598621
271179.4	598257
271182.8	598257
271184.4	598221
271336.0	598338
271349.3	598695
271477	598270
271573.8	598621
271586.0	598270
271587.8	598616
271702.3	598270
271737.9	598695
271739.5	598337
271758.5	598270
271824.5	598270
271829.4	598621
271962.3	598270
272291.6	598621



 	
VOLVO (.../...)	
272343.5	598616
272370	598481
272399.7	598480
272401.1	598479
272407.8	598270
272463.1	598270
272911.9	598270
274285	601030
274330	598829
274331	598657
274528	598829
30620770	598319
30623253	598493
30623259	598493
30623264	598319
30648381	598616
30648382	598480
30648383	598270
30648385	598479
30648387	598479
30665552	598480
30683274	598822
30683554	598649
30714791	598822
30715023	598649
30736322	601007
30742029	598822
30742030	598649
30742031	601044
30793093	598829
30793265	601030
30793941	598879
30794554	598928
30794555	598928
30850976.9	598493
30850978.5	598319
31200229	601007
3277768.2	598205
3342265.0	598205
3342534.9	598291
3343433.3	598102
3344061.1	598015
3344787.1	598015
3345670.8	598318
3345678.1	598319
8623861	598479
8623862	598480
8634921	598479
8634925	598480
8683615	601005
9485267	598616
9485593	598616
YUGO/ZASTAVA	
46600454	598603
790475	598088



 	

	
ABARTH	
46403960	186155
46455892	186266
55700592	197008
ALFA ROMEO	
0046403960	186155
0046425960	186644
0046427948	186643
0046455892	186266
0046469908	186797
0046542702	186797
0046843610	197098
0046843611	197132
0060514881	186102
0060522092	186103
0060526087	186110
0060569163	186265
0060569164	186290
0060571548	186265
0060576335	186406
0060576811	186405
0060602161	186146
0060617106	186605
0060621051	186405
0060622077	186265
0060629865	197229
0060653478	186265
0060653479	186290
0060653487	186605
0060658565	186265
0060658566	186290
0060658567	186605
0060702523	186110
0060800345	186406
0060801754	186149
0060801755	186146
0060801786	186290
0060801787	186290
0060805117	186155
0060806135	186266
0060806137	186153
0060808872	186154
0060810076	186153
0060810227	186149
0060810404	186266
0060811256	186153
0060811266	186153
0060811878	186266
0060811879	186155
0060811890	186297
0060812067	186297
0060812685	186148
0060813443	186265
0060814639	186443
0071711434	186265
0071738421	186155
0071739572	186155

	
ALFA ROMEO (.../...)	
007663465	186155
0082427592	186265
0082433853	186146
0082433860	186149
0082439939	186290
46401356	186590
46403960	186155
46423415	186153
46425960	186644
46427947	186297
46427948	186643
46427949	186297
46445005	186148
46449390	186443
46455892	186266
46469908	186797
46535086	186745
46542702	186797
46765546	186745
46820655	186154
46831041	186590
51733051	197136
51760273	197098
51760274	197132
51760621	197247
51760622	197130
51767378	197098
51767380	197134
51767382	197247
51767384	197130
51768587	197136
60514881	186102
60522092	186103
60526087	186110
60569164	186290
60571548	186265
60576335	186406
60602161	186146
60617106	186605
60621051	186405
60622077	186265
60629865	197229
60658565	186265
60658566	186290
60658567	186605
60801755	186146
60801787	186290
60805117	186155
60810227	186149
60810404	186266
60811878	186266
60812685	186148
71711434	186265
71738145	186153
71738373	186154
71738421	186155
71738906	186297

	
ALFA ROMEO (.../...)	
71738907	186643
71738909	186405
71738911	186290
71739568	186265
71739569	186266
71739572	186406
71739639	186148
71739640	186590
7663465	186155
82434070	186146
8582290	186614
93800492	186170
ARO	
10230001202	186226
AUDI	
171615301	186245
1J0615301C	197230
1J0615301D	186603
1J0615301E	186604
1J0615301P	186604
1J0615301R	197230
1J0615601	186597
1J0615601C	186597
1J0615601D	197011
1J0615601N	186597
1K0615301AA	197242
1K0615301AC	186754
1K0615301AK	186754
1K0615301M	197197
1K0615301S	186754
1K0615301T	186755
1K0615601AC	186833
1K0615601AD	197031
1K0615601K	186857
1K0615601L	186833
1K0615601M	197031
1K0615601N	197139
321615301	186245
321615301C	186246
3B0615301B	186758
437698601	186114
443615301	186113
443615301A	186112
443615301B	186112
443615601	186114
443615601A	186114
447615301A	186272
447615301B	186272
4A0615301B	186270
4A0615301C	197222
4A0615601A	186294
4B0615301A	186758
4B0615301B	197222
4B0615301C	186758

	
AUDI (.../...)	
4B0615601	186294
4B0615601A	197124
4B0615601B	197032
4B3615601	197089
4E0615601	186582
4E0615601E	186582
4E0615601J	186582
4F0615301D	197052
4F0615301E	197199
4F0615301G	197142
4F0615601B	197212
4F0615601E	197125
4F0615601F	197140
6E0615301	186788
7L8615601A	197051
7L8615601C	197090
7L8615601D	197051
811615301	186249
853615301C	186273
853615601	186292
895615301	186268
895615301A	186267
895615601A	186807
8A0615301	186269
8A0615301A	186291
8A0615301D	186269
8A0615301E	186291
8A0615601	186292
8D0615301A	186408
8D0615301J	186758
8D0615301K	197198
8D0615301M	197198
8D0615601A	186773
8D0615601B	186773
8E0615301AD	197198
8E0615301B	186582
8E0615301P	186582
8E0615301Q	197222
8E0615301R	186758
8E0615601B	186807
8E0615601D	186856
8E0615601M	197038
8E0615601P	186807
8E0615601Q	186856
8K0615301	197213
8K0615301A	197196
8K0615601B	197126
8L0615301	197246
8L0615601	197088
8N0615301A	197246
8N0615601B	197088
8Z0615301B	186603
8Z0615301D	186603
AUTOBIANCHI	
4385812	186151
5961814	186157



Valeo	
AUTOBIANCHI (.../...)	
71738422	186151
71738423	186157
BEDFORD	
90008003	186186
94172376	186488
BMW	
34 10 1 166 071	186731
34 11 1 116 675	186115
34 11 1 119 111	186116
34 11 1 119 112	186116
34 11 1 119 248	186115
34 11 1 154 747	186118
34 11 1 154 749	186119
34 11 1 154 750	186119
34 11 1 158 042	186124
34 11 1 159 898	186124
34 11 1 160 673	186274
34 11 1 160 674	186275
34 11 1 160 915	186119
34 11 1 160 981	186275
34 11 1 161 693	186124
34 11 1 162 093	197227
34 11 1 162 282	186275
34 11 1 162 288	186275
34 11 1 163 013	186697
34 11 1 163 081	186697
34 11 1 164 199	186275
34 11 1 164 431	186275
34 11 1 164 539	186815
34 11 1 164 839	186697
34 11 1 164 921	186275
34 11 1 165 455	186275
34 11 1 165 859	186884
34 11 3 400 151	197083
34 11 6 750 713	186808
34 11 6 752 434	186118
34 11 6 753 221	197193
34 11 6 756 045	186808
34 11 6 757 526	186815
34 11 6 757 750	186274
34 11 6 764 021	186732
34 11 6 764 629	186816
34 11 6 764 641	186817
34 11 6 764 643	197234
34 11 6 764 645	197073
34 11 6 765 457	186808
34 11 6 766 036	186808
34 11 6 766 224	186815
34 11 6 766 239	186275
34 11 6 767 059	186884
34 11 6 767 061	186697
34 11 6 767 269	197193
34 11 6 769 305	186731
34 11 6 770 729	197176

Valeo	
BMW (.../...)	
34 11 6 771 985	197177
34 11 6 771 986	197178
34 11 6 772 669	197234
34 11 6 774 875	197159
34 20 1 166 073	186883
34 21 1 119 581	186117
34 21 1 122 282	186117
34 21 1 156 668	186125
34 21 1 158 936	186295
34 21 1 160 809	186839
34 21 1 162 289	186295
34 21 1 162 305	186125
34 21 1 162 315	186559
34 21 1 163 153	186860
34 21 1 163 669	186568
34 21 1 163 835	186568
34 21 1 164 129	186568
34 21 1 164 175	186860
34 21 1 164 511	186295
34 21 1 164 840	186860
34 21 1 164 911	186809
34 21 1 165 211	186559
34 21 1 165 457	186295
34 21 1 165 563	186861
34 21 3 332 217	197251
34 21 6 752 545	186295
34 21 6 753 215	197084
34 21 6 755 407	186117
34 21 6 758 552	186839
34 21 6 764 651	197049
34 21 6 764 653	197158
34 21 6 764 655	197175
34 21 6 765 458	186809
34 21 6 766 225	186295
34 21 6 767 060	186860
34 21 6 771 970	197179
34 21 6 771 971	197180
34 21 6 772 085	197084
34 21 6 778 051	197181
CADILLAC	
93171497	186881
93171500	186880
CHEVROLET	
96284392	186742
96286933	186743
96455424	186742
96625873	197191
96625948	197190
CHRYSLER	
4509 340	186570
4509 994AA	186734
4683 918	197233
4683 918AB	197233

Valeo	
CHRYSLER (.../...)	
4721 023	197022
4721 023AD	197022
4721 023AE	197022
4721 023AF	197022
4721 820	186730
4721 820AC	197069
4721 820AF	197069
5073 069AA	197069
5098 066AA	186470
CITROËN	
4246-C0	197232
4246-H9	186589
4246-J0	197047
4246-J3	186420
4246-J6	186421
4246-J9	197217
4246-K0	197046
4246-K3	197228
4246-L3	186418
4246-L4	186418
4246-L6	186569
4246-L8	186533
4246-N3	186205
4246-N5	186206
4246-N7	186136
4246-P2	197219
4246-P4	186724
4246-R4	186599
4246-R5	186198
4246-R6	197220
4246-R9	186598
4246-T3	186144
4246-T8	197220
4246-T9	186296
4246-V0	186296
4246-W1	186695
4246-W2	186693
4246-W3	197220
4246-W4	186736
4246-W6	186198
4246-X7	186139
4246-X8	186694
4246-Y1	186418
4246-Y3	197228
4246-Z1	186708
4246-Z9	186840
4249-16	186695
4249-18	186693
4249-19	197002
4249-21	197188
4249-23	197099
4249-25	197133
4249-27	197043
4249-29	197248
4249-31	197023
4249-32	197002

Valeo	
CITROËN (.../...)	
4249-33	197232
4249-34	186840
4249-36	197131
4249-40	197097
4249-42	197105
4249-44	197046
4249-45	197117
4249-46	197117
4249-53	186694
4249-55	197047
4249-57	186136
4249-62	197116
4249-65	197100
4249-66	197100
4249-72	186747
4249-74	186590
4249-82	186599
4249-91	197099
4249-92	197133
4249-94	197047
4249-98	197248
4249-99	197043
4249-A0	197131
4249-A1	197023
4249-A2	197097
4249-A9	197046
4249-C0	186724
4249-C1	186747
5416277	186137
5462434	186140
5489362	186140
7538682	186136
75485825	186143
75529364	186139
7910007463	186142
91508338	186200
91517694	186195
91517695	186194
95027199	186130
95030547	186144
95575080	186134
95582061	186135
95582062	186135
95599322	186128
95632048	186198
95637322	186145
95661746	186134
95661747	186194
95661748	186200
95661749	186416
95661796	186621
95661810	186130
95661811	186276
95661812	186145
95661813	186303
95661814	186144
95661849	186135

CITROËN (.../...)	
95661850	186140
95667809	186198
95667810	186296
95667811	186586
95669224	186142
95669225	186195
95669226	186131
96017878	186131
96070525	186200
96099616	186303
AM45123	186128
ZF07568440	186206
ZF07568501	186205
ZF93500520	186206
ZF93500521	186136
DACIA	
6001539659	186727
6001547683	186802
6001547684	186803
6001548578	186208
6001549211	186803
7701204282	186230
7701206339	186208
7701208252	186802
7701466540	186226
DAEWOO	
41441-06210	197195
48401-05101	197122
90121445	186188
96179110	186189
96284392	186742
96286933	186743
96312559	186743
96320531	186742
DAIHATSU	
43512-87215-000	197157
43512-97204-000	197108
43512-97207-000	197108
F.S.O. / POLSKI	
061750	186151
061948	186151
4208311	186151
4385812	186151
71738422	186151
FIAT	
1300500080	197217
1300501080	186418
1307356080	197228
1309392080	186420
1316323080	186589
1317651080	186420

FIAT (.../...)	
1325772080	197219
4208311	186151
4377102	186501
4385812	186151
4448411	186152
4450931	186205
46401356	186590
46403088	186266
46403958	186297
46403959	186266
46403960	186155
46416712	186153
46419204	186571
46423415	186153
46427947	186297
46427949	186297
46445005	186148
46445006	186265
46448168	186266
46455892	186266
46535086	186745
46542383	186590
46765546	186745
46788929	186744
46806233	186418
46806234	197228
46820655	186154
46831041	186590
46831042	186146
46833807	186708
46836489	186854
46836490	186882
46844071	186881
51705749	197248
51728377	197043
51728378	197131
51740244	197043
51740245	197023
51740246	197248
51742727	186744
51749124	186153
51749274	197023
51749275	197097
51749555	197105
51806099	197028
51806103	197028
51848616	197023
5416277	186137
55700398	197028
55700592	197008
55700593	197008
55700918	197028
55700920	197044
55700921	197044
55700922	197045
55700923	197045
5961814	186157

FIAT (.../...)	
60812422	186266
60813038	186266
71738422	186151
71738423	186157
71738905	186418
71738910	197217
71738911	186290
71739568	186265
71739569	186266
71739637	197228
71739638	186136
71739639	186148
71740116	186206
71740117	186708
71742850	197135
71750162	197135
7531819	186206
7538682	186136
7550923	186156
7568440	186206
7568501	186205
7645054	186155
7645056	186153
7650707	186156
7663465	186155
7663466	186154
7685656	186155
7779409	186153
82433789	186148
82433857	186150
82433858	186149
82433859	186146
82433860	186149
82434070	186146
82434169	186147
82440275	186290
82450539	186265
82450657	186266
82451441	186148
82451747	186148
82462136	186297
82464702	186149
92498609	186154
93500520	186206
93500521	186136
93800492	186170
9464222687	186724
9467548387	197188
9467548487	197099
9467548587	197133
9467548588	197133
9566928380	186421
FORD	
1001093	197236
1001094	186624
1013581	186529

FORD (.../...)	
1019604	186163
1023605	186624
1025911	186426
1045994	197236
1045995	186624
1066271	186163
1096104	186159
1102560	186166
1107767	186162
1107768	186163
1108038	186800
1137985	186624
1140278	186801
1141782	197239
1143641	197236
1148202	186560
1197572	186425
1223540	186842
1223543	186842
1223566	186843
1223568	186843
1223663	186819
1223664	186863
1223665	186819
1223666	186863
1253727	186842
1253728	186842
1253729	186819
1253730	186819
1253962	186843
1253963	186843
1253964	186863
1253965	186863
1320347	186842
1320352	186819
1320581	186163
1320582	186163
1320585	186560
1321488	186750
1323102	186834
1323551	186843
1323560	186863
1323620	186560
1323621	186425
1361298	186748
1361300	186748
1362867	197013
1362868	186844
1368548	197143
1371393	197054
1371394	197249
1371420	187152
1373360	186842
1373361	186843
1373369	186819
1373370	186863
1373771	186560

OE	Valeo
FORD (.../...)	
1373781	186425
1376118	186750
1376138	186834
1379931	197101
1379965	197055
1384290	197143
1384689	197055
1385590	197101
1405500	197101
1405510	197055
1420600	197055
1420601	197055
1464031	187152
1469082	186819
1469083	186863
1469084	197055
1469085	197055
1500152	186863
1500158	197055
1501058	186819
1501069	186819
1503287	197054
1503290	197249
1520297	186863
1526694	186624
1541804	186155
1541806	186744
1610869	186159
1619053	186159
1619054	186159
1630012	186424
1644844	186159
1644845	186159
1644857	186158
1652547	186424
3555344	186560
3573537	186560
4041427	186709
4041428	186710
4070864	186401
4070865	186277
4071714	186163
4077455	186560
4083484	186425
4084226	186163
4097477	186750
4097478	186750
4098427	186834
4098428	186834
4110588	186834
4115996	186426
4141711	186834
4143445	186834
4176921	186834
4179398	186750
4179406	186834
4181042	186750

OE	Valeo
FORD (.../...)	
4367104	186748
4367106	186748
4367107	197013
4367108	186844
4395257	186709
4455980	186748
4457985	186748
4457989	197013
4475316	186844
5022648	186158
5022650	186160
5022651	186160
5022652	186162
5022653	186162
5022654	186163
5022658	186158
5022659	186159
5022660	186159
5022661	186166
5022663	186166
5022666	186425
5022668	186165
5022669	186424
5022676	186168
5022677	186169
5022679	186159
5022947	186158
5022949	186424
5023441	186165
5023483	186425
5023573	186159
5023802	186159
5024744	186158
5025610	186278
5025950	186427
5025951	186428
5026784	186277
5026785	186401
5026786	186426
5027175	186424
5027462	186165
5027463	186165
5027464	186424
5027465	186424
5028281	186163
5029815	186278
5029816	186537
5030658	186425
6041696	186169
6077974	186159
6133550	186159
6137291	186158
6156352	186160
6158203	186158
6158215	186424
6166055	186168
6166056	186169

OE	Valeo
FORD (.../...)	
6168109	186165
6169974	186166
6191062	186162
6191063	186162
6191064	186163
6193694	186165
6450826	186165
6691106	186428
7204066	186425
FORD USA	
3395510	186457
3415598	186458
3958455	186457
GALLOPER	
51712-M2000	186648
51712-M2010	186648
HB403101	186653
HONDA	
42510-S1A-E00	197015
42510-S1A-E10	197015
42510-S5A-000	197014
42510-S5T-E00	197104
42510-S6D-E00	197103
42510-SCA-E50	197102
42510-SD2-930	186435
42510-SE0-000	186435
42510-SE0-010	186435
42510-SH3-000	186435
42510-SH3-G00	186435
42510-SK3-305	186435
42510-SK3-E00	186435
42510-SR3-000	186432
42510-SR3-A10	186432
42510-SR3-G00	186432
42510-SR3-J00	186432
45251-S1A-E40	197154
45251-S1A-G00	186780
45251-S1A-G60	186699
45251-S2H-N00	186778
45251-S50-G00	197146
45251-S5D-A10	186438
45251-S6D-E10	186438
45251-S6M-A10	197144
45251-SAA-G10	186866
45251-SAA-G11	186866
45251-SB2-010	186232
45251-SB2-020	186232
45251-SB2-030	186232
45251-SB2-730	186232
45251-SB2-731	186232
45251-SB2-732	186232
45251-SB2-780	186431
45251-SB2-781	186431

OE	Valeo
HONDA (.../...)	
45251-SB2-782	186431
45251-SB2-980	186431
45251-SB2-981	186431
45251-SB2-982	186431
45251-SB2-990	186431
45251-SEA-E00	197153
45251-SEA-E30	197145
45251-SF0-000	186234
45251-SG0-J00	186235
45251-SG9-000	186235
45251-SH0-A00	186433
45251-SH1-A00	186433
45251-SH3-A00	186433
45251-SK3-E00	186286
45251-SK7-A00	186438
45251-SK7-A10	186438
45251-SK7-J00	186438
45251-SM4-000	186436
45251-SM4-010	186436
45251-SM4-020	186436
45251-SM4-G00	186439
45251-SM4-G01	186439
45251-SM4-G02	186439
45251-SM5-A00	186439
45251-SN7-E40	186436
45251-SN7-E50	186439
45251-SP0-000	186778
45251-SP0-E00	186778
45251-SR0-A00	186438
45251-SR0-A10	186438
45251-SR3-A00	186433
45251-SR3-A10	186433
45251-SS0-000	186699
45251-ST3-E10	186438
45251-SWW-G01	197186
45251-SZ3-000	186778
45251-SZ3-E00	186778
HYUNDAI	
51712-02000	186777
51712-02100	186777
51712-0X500	197096
51712-1C000	186879
51712-1C050	186878
51712-1H000	197205
51712-21350	186441
51712-21B00	186441
51712-24100	186441
51712-25060	197173
51712-25061	197173
51712-26100	186824
51712-28300	186617
51712-2D300	186825
51712-2D310	186825
51712-2L500	197174
51712-33001	186440
51712-38100	186823



HYUNDAI (.../...)	
51712-3B000	197172
51712-3D100	186829
51712-3D300	186829
51712-M2000	186648
51712-M2010	186648
58129-44010	186572
58411-1C800	197029
58411-1H300	197123
58411-29300	197120
58411-29310	197120
58411-39300	197121
58411-39600	197121
58411-3A300	197027
HB403101	186653

INNOCENTI	
39726321	186495
4385812	186151
5961814	186157
71738422	186151
71738423	186157

ISUZU	
8-94372-435-0	186488
8-94375-425-1	186685
8-94375-533-4	197223
8-97034-034-3	197223
8-97046-081-1	186685

IVECO	
1904528	186614
1904529	186170
1904531	187029
1908772	187058
1908773	187040
2991646	187148
42470836	187147
42470842	187058
42471034	187149
42471111	187040
42471150	187130
8582290	186614
8584182	187029
93800492	186170

JAGUAR	
C2S4566	186750
C2S9231	186834

JEEP	
52098 672	197238
52128 247AA	197252
52128 411AA	197022

KIA	
OK011-33-251D	197207



KIA (.../...)	
OK01A-33251D	197207
OK01A-33-25XB	197207
OK2AA-33-251A	197208
OK552-33-251	197206
OK58B-33251	197211
51712-07-500	197096
51712-1H000	197205
51712-3E000	197210
51712-3E500	197204
51712-M2000	186648
51712-M2010	186648
58411-1C800	197029
58411-1H300	197123
58411-39600	197121
58411-3A300	197027
58411-3E300	197209
KJ002-33-251C	197206
MDA01-33-251	186454

LADA	
2101-3103002	186171
2101-3501070	186171
2108-3501070	186173
2110-3501070	186781
2121-3501070	186172

LANCIA	
1309392080	186420
1317651080	186420
1325772080	197219
4385812	186151
4448411	186152
46401356	186590
46403088	186266
46423415	186153
46427947	186297
46445005	186148
46445006	186265
46449389	186442
46449390	186443
46455892	186266
46469907	197138
46535086	186745
46554302	186154
46758714	186266
46758715	186146
46765546	186745
46776750	197137
46820655	186154
5961814	186157
60812422	186266
60813038	186266
60814804	186290
60814921	197229
71738421	186155
71738422	186151



LANCIA (.../...)	
71738423	186157
71738906	186297
71738911	186290
71739568	186265
71739569	186266
71739639	186148
71740115	186442
7645056	186153
7663465	186155
7663466	186154
7779409	186153
7789267	186290
82427592	186265
82433789	186148
82433857	186150
82433858	186149
82433859	186146
82433860	186149
82433918	186266
82434070	186146
82434169	186147
82439939	186290
82440275	186290
82440356	186266
82450539	186265
82450657	186266
82451441	186148
82451746	186266
82451747	186148
82462136	186297
82464702	186149
82480447	186443
82487489	186442
9464222687	186724
9566928380	186421

LAND ROVER	
ANR4983	186687
FRC7329	186283
FTC1381	186310
FTC3846	186310
FTC902	186284
LR000571	197055
LR001018	197107
NTC8780	197224
NTC8781	186642
SDB000080	186871
SDB000210	186642
SDB000211	197017
SDB000330	186310
SDB000380	197062
SDB000470	186642
SDB000601	197155
SDB000602	197155
SDB000603	197155
SDB000604	197155
SDB000634	197156



LAND ROVER (.../...)	
SDB000635	197156
SDB000636	197156
SDB100830	186687
SDB101070	186871

LEXUS	
43512-30180	197194
43512-30181	197194
43512-50100	197194
43512-50110	197194
43512-50111	197194
43512-50112	197194
43512-53020	197194

MARUTI	
55511-82000	197114

MAZDA	
1E03-33-251	186529
1E04-33-251	186529
1E06-33-251	186163
1E08-33-251	186163
1E09-33-251	186163
B26Y-26-251	197020
BB4C-26-251C	186452
BB7E-33-25XA	186451
BB7E-33-25XC	186451
BB7E-33-25XD	186451
BB8V-26-251	186452
BJOY-33-25X	197161
BJ1Y-33-25X	186810
BP4Y-26-251B	197021
BP4Y-26-251D	197021
BP4Y-33-25XB	186872
BP4Y-33-25XC	186872
BP4Y-33-25XD	186872
BR74-26-251A	186452
BR74-26-251B	186452
BR74-26-251E	186452
C24Y-26-251B	197021
C24Y-26-251C	197021
C24Y-33-25XB	186872
C24Y-33-25XC	186872
DA01-33-251	186454
DB0Y-33-251	186453
DD32-33-25X	186560
DD59-33-25X	186560
DD63-33-25X	186560
DD63-33-25XA	186560
FB05-33-251	186446
GA2Y-33-25X	186457
GA3Y-26-251	186458
GA4Y-26-251	186458
GA4Y-33-25X	186457
GA4Y-33-25XH	186457
GA4Y-33-25XJ	186457



MAZDA (.../...)

GA5Y-26-251	186458
GA5Y-26-251A	186458
GA5Y-26-251C	186458
GA5Y-26-251D	186458
GA5Y-33-25X	186457
GA5Y-33-25XD	186457
GA8Y-26-251	186458
GF3Y-26-251	186851
GF3Y-26-251A	186851
GFY-26-251	186851
GJ25-33-25XD	186455
GJ6Y-33-25XA	197245
GJ96-33-25XA	186446
GTYF-26-251C	186458
N026-33-25XC	197063
N123-26-251A	186851
NA01-33-25X	186449
NA01-33-25XA	186449
NA75-33-25X	197063
NA75-33-25XC	197063
NF47-26-251	186851
UB39-33-251A	186665

MCC

0004341V001	186859
0004341V002000000	186859
4544200001	197214
4544200072	197129

MERCEDES

1234210012	186180
1244211312	186182
1244211512	186460
1244211612	186185
1244212712	186185
1244230512	186183
1244231112	186469
1294210312	186185
1294210612	186461
1294211012	186461
1294212012	186461
1294212612	186461
1294230012	186462
1294230312	197094
1404230412	186465
1634210112	186753
1634210312	186811
1644210412	197092
1684210112	186562
1684210212	186573
1684210612	186783
1684210712	186783
1684230212	186760
1694210012	186798
1694210112	186799
1694210212	197091



MERCEDES (.../...)

1694230312	197036
2014211212	186176
2014211312	186177
2014211512	186177
2014231212	186184
2024210212	186298
2024210712	186280
2024210912	186280
2024230012	186281
2034210312	186864
2034211312	197200
2034230112	186470
2044210012	197203
2044210712	197202
2044210912	197201
2044230512	197128
2044230612	197127
2044230912	197127
2104210712	186467
2104230312	186469
2104230412	186470
2104230612	186469
2104230912	186470
2104231012	186469
2114210712	186751
2114210812	186751
2114211112	197093
2114230712	197035
2114230912	186865
4144210012	197060
4604210012	186692
6314200172	186612
6314200372	186178
6384210112	186551
6384230112	186552
6394210012	186890
6394230112	186858
9014210312	186774
9014230412	197033
9014230612	197033
9024210312	186774
9024210412	186774
9024210612	186774
9024230112	187045
9024230312	187045
9024230412	187045
9024230512	187045
9044230212	197059
9044230312	197059
9064210012	187141
9064230012	197030
9064230112	187146

MG

EGP1254	186435
FAM8970	186613
GBD90607	186613



MG (.../...)

SDB000440	186620
SDB000870	197016
SDB000990	186438
SDB100500	186620
SDB100600	186438
SDB101100	197016

MINI

34 11 1 502 891	186762
34 11 6 774 985	197074
34 11 6 774 986	197160
34 21 1 503 070	186812
34 21 6 774 987	186812

MITSUBISHI

4605A068	197214
4605A076	197129
4615A035	197116
M818027	186707
MB238495	197165
MB407031	186664
MB407038	186653
MB407039	186653
MB407639	186648
MB618628	186476
MB618629	186476
MB618716	186719
MB618734	186476
MB618735	186476
MB618797	186691
MB668107	186648
MB668886	186648
MB699283	186818
MB928697	186719
MB928994	186648
MB928995	186648
MB950569	186648
MB950570	186648
MB950922	186818
MR128153	186648
MR205585	186648
MR249356	186647
MR334996	197067
MR389722	186648
MR407116	186813
MR407289	186813
MR449769	186818
MR475330	186648
MR569974	197129
MR913846	186647

NISSAN



06100295-0	186607
40206-00QAA	186208
40206-00QAD	186868
40206-00QAE	186712







NISSAN (.../...)



40206-00QAF	186712
40206-00QAJ	186229
40206-01B00	186299
40206-01B01	186299
40206-0M601	186576
40206-0M602	186576
40206-0M801	186577
40206-0M802	186577
40206-17B00	186299
40206-17B01	186299
40206-2F500	186821
40206-2F501	186821
40206-3Y502	186728
40206-3Y503	186728
40206-4U101	186728
40206-4U103	186728
40206-4U105	186728
40206-4U107	186728
40206-58A00	186482
40206-58A01	186482
40206-5F001	186300
40206-5F003	186300
40206-60Y01	186482
40206-71E01	186485
40206-71E02	186485
40206-71E05	186485
40206-71E06	186485
40206-90J01	186301
40206-93J00	186485
40206-93J01	186485
40206-9C100	186563
40206-AX600	186764
40206-AX602	186764
40206-AX603	186764
40206-C7000	186479
40206-C7001	186479
40206-G9500	186479
40206-JD00A	197164
40206-JG00A	197164
40206-Y9503	186611
43206-00QAA	186740
43206-00QAB	186713
43206-00QAC	186713
43206-00QAD	186713
43206-00QAE	186713
43206-42R00	186564
43206-42R01	186564
43206-42R05	186564
43206-54C01	186564
43206-58Y01	186654
43206-58Y02	186654
43206-5F001	186846
432065M311	186487
43206-88E03	186487
43206-99J00	186487
43206-99J01	186487
43206-99J04	186845



	
RENAULT (.../...)	
7700764193	186219
7700767602	186224
7700778126	186596
7700780077	186768
7700780078	186768
7700780892	186208
7700793047	186220
7700793631	186223
7700800002	186306
7700800003	186307
7700801101	186220
7700802231	186600
7700802232	186304
7700802233	186305
7700805006	186775
7700805148	186775
7700813549	186208
7700829553	186768
7700830283	186600
7701204281	186218
7701204282	186230
7701204283	186214
7701204284	186214
7701204285	186228
7701204286	186229
7701204287	186231
7701204288	186567
7701204289	186224
7701204290	186596
7701204293	186768
7701204294	186768
7701204295	186306
7701204296	186307
7701204298	186220
7701204300	186304
7701204301	186305
7701204302	186775
7701204303	186775
7701204304	186208
7701204305	186600
7701204495	186304
7701204496	186305
7701204523	186768
7701204828	186208
7701204901	186768
7701205228	186304
7701205229	186305
7701205231	186600
7701205653	186208
7701205840	186304
7701205841	186305
7701205842	186655
7701205843	186600
7701205844	186306
7701205845	186307
7701206118	186655
7701206198	186600

	
RENAULT (.../...)	
7701206327	186720
7701206328	186720
7701206339	186208
7701206613	186715
7701206614	197221
7701206673	197240
7701206831	186717
7701206845	186712
7701206846	186713
7701206924	186894
7701207227	186786
7701207357	186804
7701207611	186768
7701207795	186764
7701207823	186796
7701207829	186655
7701207897	197241
7701207898	186853
7701208230	186720
7701208252	186802
7701208849	197215
7701466540	186226
7701466541	186142
7701466542	186211
7701466782	186213
7701467306	186225
7701467307	186223
7701467954	186221
7701467955	186219
7701472838	186718
7701713008	186718
7711130076	186713
7711130077	186712
7910007463	186142
8200007121	186715
8200007122	197221
8200010519	186712
8200018407	197003
8200019581	186717
8200177024	186804
8200196263	197081
8200228610	186713
8200242317	197079
8200242318	186804
8200244108	186893
8200367094	186718
8200570191	186804
8200570677	197079
8200649353	186893
8200655249	186718
8200663193	197003
ROVER	
21A2612	186495
EGP1254	186435
FAM8405	186236
FAM8970	186613

	
ROVER (.../...)	
FTC1381	186310
FTC461	186310
GBD90607	186613
GBD90800	186235
GBD90801	186234
GBD90806	186495
GBD90809	186236
GBD90810	186232
GBD90811	186236
GBD90817	186435
GBD90818	186232
GBD90822	186235
GBD90827	186232
GBD90829	186285
GBD90830	186286
GBD90833	186234
GBD90836	186439
GBD90837	186439
GBD90840	186438
GBD90841	186620
GBD90843	186439
GBD90844	186814
GBD90847	197016
NAM7806	186613
SDB000440	186620
SDB000870	197016
SDB000880	186814
SDB000990	186438
SDB090800EVA	186235
SDB10026EVA	186234
SDB100500	186620
SDB100600	186438
SDB100940	186814
SDB101100	197016
RVI	
5001864712	187061
5010260609	187061
SAAB	
32025723	197226
4002143	186500
4241428	186496
4241477	186497
4837019	197226
4839320	197226
4839338	186566
5055389	197244
5057476	197009
5232756	197050
5390786	197226
5391537	197009
5391560	197244
5391578	186566
8951543	186498
8965980	186500

	
SAAB (.../...)	
8970717	186498
9156785	186854
9156807	186881
9184405	197244
9191336	186882
93171497	186881
93171500	186880
SANTANA	
55211-56B00	186628
55211-60A00	186504
55211-80000	186374
SEAT	
1H0615301A	186313
1J0615301C	197230
1J0615301D	186603
1J0615301E	186604
1J0615301K	197230
1J0615301L	186603
1J0615301R	197230
1J0615301S	197230
1J0615601	186597
1J0615601C	186597
1J0615601N	186597
1K0615301AA	197242
1K0615301AC	186754
1K0615301AK	186754
1K0615301M	197197
1K0615301S	186754
1K0615301T	186755
1K0615601AC	186833
1K0615601AD	197031
1K0615601K	186857
1K0615601L	186833
1K0615601M	197031
321615301	186245
321615301C	186246
321615301D	186247
357615301	186251
357615601	186288
357615601B	186517
4B0615301B	197222
4B0615301C	186758
535615301	186519
6N0615301	186581
6N0615301C	186523
6N0615301D	186247
6N0615301F	186523
6N0615601A	186729
6N0615601B	186729
6Q0615301	186888
7D0615601C	186801
7M0615301E	197236
7M0615301G	197236
7M0615601A	186624



SEAT (.../...)

7M0615601B	186624
7M0615601C	186624
7M3615301	186800
7M3615301A	197239
811615301	186249
8E0615301AD	197198
8E0615301P	186582
8E0615301Q	197222
8E0615301R	186758
8E0615601M	197038
8E0615601P	186807
8E0615601Q	186856
8N0615301A	197246
8N0615601B	197088
SE021165002A	186287
SE022165002A	186151
SE022165002B	186501

SKODA

002 415 019	186681
115 430 210	186530
115 430 211	186530
115 430 212	186714
1J0615301C	197230
1J0615301D	186603
1J0615301E	186604
1J0615301K	197230
1J0615301M	186604
1J0615301R	197230
1J0615301S	197230
1J0615601	186597
1J0615601C	186597
1J0615601D	197011
1J0615601N	186597
1K0615301AA	197242
1K0615301AC	186754
1K0615301AK	186754
1K0615301M	197197
1K0615301S	186754
1K0615301T	186755
1K0615601AB	186857
1K0615601AC	186833
1K0615601AD	197031
1K0615601K	186857
1K0615601L	186833
1K0615601M	197031
1K0615601N	197139
4A0615301C	197222
4A0615601A	186294
4B0615301A	186758
4B0615301B	197222
4B0615301C	186758
6Q0615301	186888
6U0615301	186681
8E0615301Q	197222
8E0615601	186294
8N0615301A	197246



SKODA (.../...)

8N0615601B	197088
------------	---------------

SSANGYONG

41441-06211	197195
48401-05101	197122

SUBARU

26310 AA040	186503
26310 AA050	186503
26310 AA051	186503
26700 FE010	186503
26700 FE030	186503
26700 FE080	186503
55311-80F01	186505
55311-80F02	186505
55311-86G02	186805

SUZUKI

55211-56B00	186628
55211-60A00	186504
55211-65D01	197065
55211-65D11	197162
55211-80000	186374
55311-61G00	186827
55311-62J00	197066
55311-75F00	197163
55311-79J01	197135
55311-80F00	186505
55311-80F01	186505
55311-80F02	186505
55311-80G00	197064
55311-83E00	186784
55311-84E01	186805
55311-86G02	186805
55511-82000	197114

TALBOT

0055184514	186240
4246-63	186142
4246-A4	186142
4246-B2	186202
4246-E4	186240
4246-E6	186242
4246-H2	186203

TOYOTA

42431-02070	186848
42431-02080	197019
42431-02081	197019
42431-02170	197109
42431-05030	186849
42431-0D050	186847
42431-0D060	197111
42431-12210	186847
42431-12260	197110
42431-12280	197109



TOYOTA (.../...)

42431-20430	186850
42431-28090	197018
42431-28091	197018
42431-42040	197112
42431-42041	197112
42431-44030	197018
42431-52050	186847
42431-52080	197113
43512-02080	197171
43512-02180	197185
43512-02190	197187
43512-05010	186822
43512-05020	197148
43512-05030	186705
43512-05040	197072
43512-0D010	186587
43512-0D050	186766
43512-0D060	197184
43512-0F010	197070
43512-0F030	197187
43512-0H010	197047
43512-10160	186874
43512-12230	186510
43512-12250	186511
43512-12260	186511
43512-12300	186511
43512-12310	186511
43512-12330	186511
43512-12340	186511
43512-12440	186511
43512-12480	186511
43512-12490	186511
43512-12500	186510
43512-12550	186701
43512-12580	186511
43512-12670	197183
43512-12680	197187
43512-12690	197185
43512-13030	186877
43512-16070	186875
43512-16120	186875
43512-17120	186766
43512-17130	186766
43512-20120	186508
43512-20160	186508
43512-20270	186508
43512-20360	186652
43512-20380	186652
43512-20390	186652
43512-20400	186652
43512-20470	197169
43512-20480	197169
43512-20500	197148
43512-20590	186876
43512-20600	186876
43512-20601	186876
43512-20710	197170



TOYOTA (.../...)

43512-20711	197170
43512-21010	197169
43512-28060	186514
43512-32090	186509
43512-32180	186509
43512-32190	186509
43512-33020	197167
43512-33040	197166
43512-33041	197166
43512-33042	197166
43512-33043	197166
43512-33050	197167
43512-33060	197166
43512-33100	197168
43512-35180	186696
43512-35190	186547
43512-35200	186640
43512-35210	186704
43512-42010	186686
43512-42030	186765
43512-42031	186765
43512-42050	197152
43512-44020	197166
43512-44021	197166
43512-52020	186587
43512-52040	186766
43512-52050	186587
43512-52120	197147
43512-52130	197182
43512-60040	186637
43512-60050	186645
43512-60090	186638
43512-60100	186637
43512-60120	186704
43512-60150	197071
43512-69015	186637
43512-69016	186637

VAUXHALL

90008003	186186
90008005	186187
90008006	186188
90271133	186625
90271134	186191
90271135	186192
90272328	186190
90295087	186189
90348319	186302
90392559	197225
90393496	197225
90421727	186282
90421872	186490
90442513	186496
90487402	186189
90509590	186497
90511111	186188
90511128	186282



VAUXHALL (.../...)	
90512029	197226
90512909	186565
90512910	186566
90542180	186488
90542181	197004
9111038	186868
9111045	186740
9111283	186218
91151563	186685
91159915	186712
91159916	186713
91165426	186712
91166212	186713
9117676	186591
9117677	186592
9117678	186684
9117771	186594
9117772	186593
9160398	186688
9193872	186784
9194477	197244
9195293	197004
9195294	186488
9195981	186757
9195985	186790
9196050	186759
9196587	186594
9196592	186791
93161254	186713
93171497	186881
93171500	186880
93171778	186882
93171848	186854
93175376	186869
93176389	186805
93176548	186855
93179462	186805
93181113	186869
93182282	186189
93182284	197226
93182291	186188
93185817	197150
93188916	197028
93188917	197044
93188918	197045
93188919	197149
93192978	197066
93850649	186713
94172376	186488
96625873	197191
96625948	197190
97034034	197223
97034035	186585
97034036	186685
VOLKSWAGEN	
171615301	186245

VOLKSWAGEN (.../...)	
191615601A	186288
191615601B	186288
1H0615301A	186313
1J0615301C	197230
1J0615301D	186603
1J0615301E	186604
1J0615301K	197230
1J0615301L	186603
1J0615301M	186604
1J0615301P	186604
1J0615301R	197230
1J0615301S	197230
1J0615601	186597
1J0615601C	186597
1J0615601D	197011
1J0615601N	186597
1J0615601P	186597
1JE615301	186603
1K0615301AA	197242
1K0615301AC	186754
1K0615301AK	186754
1K0615301M	197197
1K0615301S	186754
1K0615301T	186755
1K0615601AB	186857
1K0615601AC	186833
1K0615601AD	197031
1K0615601K	186857
1K0615601L	186833
1K0615601M	197031
1K0615601N	197139
251407615	186770
251407615J	186520
251407615Q	186770
251407615R	186520
251407617A	186771
251407617D	186770
251407617F	186770
251407617G	186770
251407617K	186770
251407617L	186770
251407617M	186770
251407617N	186770
2D0615301A	186774
2D0615301B	186774
2D0615301C	186774
2D0615301D	186774
2D0615601	197033
2D0615601A	187045
2D0615601B	197059
2D0615601C	197033
2D0615601D	187045
2E0615301	187141
2E0615601A	197030
321615301	186245
321615301C	186246
321615301D	186247

VOLKSWAGEN (.../...)	
357615301	186251
357615301D	186247
357615601	186288
357615601B	186517
3A0615301	186521
3A0615301A	186521
3D0615601E	186582
443615301	186113
443615301A	186112
443615301B	186112
443615601	186114
443615601A	186114
447615301A	186272
447615301B	186272
4A0615301B	186270
4A0615301C	197222
4A0615301E	197222
4A0615601A	186294
4B0615301A	186758
4B0615301B	197222
4B0615301C	186758
4B3615301A	197141
4B3615601	197089
4E0615601	186582
4E0615601E	186582
4E0615601J	186582
535615301	186519
6E0615301	186788
6N0615301	186581
6N0615301C	186523
6N0615301D	186247
6N0615301E	197086
6N0615301F	186523
6N0615301G	186246
6N0615601	186288
6N0615601A	186729
6N0615601B	186729
6Q0615301	186888
6Q0615301A	186888
6R0615301	186603
701615301	186314
701615301A	186315
701615301B	197218
701615301C	186314
701615301D	186315
701615301E	197218
701615301F	186682
701615301G	186725
7D0615301	197239
7D0615301B	197239
7D0615301C	186682
7D0615601A	186801
7D0615601C	186801
7H0615301D	186756
7H0615301F	186885
7H0615601B	186886
7L6615301D	197087

VOLKSWAGEN (.../...)	
7L6615301J	197087
7L6615601D	197090
7L6615601E	197243
7L6615601G	197243
7L6615601J	197090
7L8615601C	197090
7M0615301E	197236
7M0615301G	197236
7M0615601A	186624
7M0615601B	186624
7M0615601C	186624
7M3615301	186800
7M3615301A	197239
811615301	186249
839615301	186245
853615301C	186273
853615601	186292
895615301A	186267
895615601A	186807
8A0615601	186292
8D0615301J	186758
8D0615601A	186773
8E0615301A	186583
8E0615301B	186582
8E0615301D	186582
8E0615301P	186582
8E0615301Q	197222
8E0615601	186294
8E0615601A	186773
8L0615301	197246
8N0615301A	197246
8N0615601B	197088
J4351235180	186696
J4351235190	186547
VOLVO	
1205780	186254
1228942.7	186254
1359131.8	186255
13591565	186776
1359906.3	186263
1359908.9	186264
270736.2	186256
270737.0	186254
270739.6	186255
270876.6	186776
271788	186526
271788.2	186526
271794.0	186528
272276	197056
272276.7	197056
272403	186789
272404.5	186741
274170	186741
274509	186819
274510	186863
274521	197143

	Valeo
VOLVO (.../...)	
30636074	197057
30666802	186843
30736406	197057
30769056	197055
30769113	186843
30818027.2	186707
30872319.6	186648
30872926.8	186648
30872940.9	186647
31202331	197055
31262718	186819
31262719	186863
3210674.2	186257
3342616.5	186311
3410294.7	186258
3450386.2	186311
3459661.9	186258
6848902.0	186289
9434167.4	186841
YUGO/ZASTAVA	
4385812	186151
46618703	186151
71738422	186151

	Valeo
--	-------

	Valeo
--	-------

	Valeo
--	-------

<p>Every effort has been made to ensure that the information contained in this catalogue is correct at the time of printing, but no warranty or representation is given or made as to the accuracy of such information and Valeo Service UK Ltd does not accept any liability whatsoever for any inaccuracies.</p> <p>Valeo Service UK Ltd reserves the right to alter specifications and/or the final construction of products without notice.</p>	<p>Product references referred to in this catalogue may not be available in all countries.</p> <p>All orders for products are only accepted subject to the terms and conditions of Valeo Service UK Ltd.</p> <p>Photographs and drawings are not binding on Valeo Service UK Ltd. The copyright in this publication belongs to Valeo Service UK Ltd exclusively. No part of this publication may be reproduced by any means without the prior authorisation of Valeo Service UK Ltd.</p>
<p>L'affectation et la préconisation des produits figurant dans nos catalogues prennent en compte l'état du parc automobile au jour de leur parution.</p> <p>La responsabilité de Valeo Service ne saurait être engagée en cas de modification, substitution ou suppression des affectations ou préconisations qui pourraient intervenir notamment à l'initiative des constructeurs de véhicules.</p> <p>Les caractéristiques techniques de nos produits sont susceptibles d'évoluer à tout moment pour tenir compte des améliorations techniques et technologiques.</p>	<p>Certaines références peuvent ne pas être disponibles dans tous les pays.</p> <p>Les commandes sont régies par les conditions générales de vente de Valeo Service.</p> <p>Photos et dessins non contractuels. La reproduction de tout ou partie de cette publication est interdite sans l'autorisation expresse et écrite de Valeo Service.</p>
<p>La aplicación de los productos sobre vehículos y las especificaciones de los productos que figuran en nuestros catálogos se refieren a la situación del parque de automóviles en la fecha de puesta en circulación de los productos.</p> <p>Valeo Service España SA no asume ninguna responsabilidad en caso de modificación, sustitución o supresión de dichas aplicaciones y/o especificaciones que pudieran producirse por iniciativa de los fabricantes de automóviles.</p> <p>Las características técnicas de nuestros productos son susceptibles de evolucionar en cualquier momento para incorporar las mejoras técnicas y tecnológicas que se desarrollen.</p>	<p>Las referencias de productos mencionadas en este catalogo puede que no estén disponibles en todos los países.</p> <p>Los pedidos se regiran por las condiciones generales de venta de Valeo Service España SA.</p> <p>Las fotografías y dibujos que aparecen en nuestros catálogos son meramente indicativas, por lo que no siempre coinciden exactamente con la apariencia externa de nuestros productos. Se prohíbe la reproducción de todo o parte de esta publicación sin la autorización expresa y escrita de Valeo Service España SA.</p>
<p>As prescrições e recomendações relativas ao uso ou utilidade dos produtos constantes de nossos catálogos levam em consideração o estado do parque automotivo à época do lançamento desses produtos.</p> <p>A Valeo Sistemas Automotivos Ltda (Valeo Cibié Service) não será responsável por quaisquer modificações, substituições ou supressões incidentes sobre as prescrições e recomendações relativas ao uso ou utilidade de nossos produtos, que sejam decorrentes de ações dos construtores de veiculos.</p> <p>As características técnicas de nossos produtos são suscetíveis de alteração a qualquer momento para que sejam incorporadas melhorias técnicas e/ou tecnológicas.</p>	<p>Certas referências podem não estar disponíveis em todos os países.</p> <p>Os pedidos feitos pelos clientes são regidos pelas condições gerais de venda da Valeo Sistemas Automotivos Ltda (Valeo Cibié Service).</p> <p>Fotos e desenhos não contratuais. A reprodução do todo ou de parte desta publicação é proibida sem a autorização expressa e por escrito da Valeo Sistemas Automotivos Ltda (Valeo Cibié Service).</p>
<p>Le applicazioni e le specifiche dei prodotti che figurano nei nostri cataloghi si riferiscono alla situazione del parco circolante al momento della pubblicazione.</p> <p>Valeo Service Italia S.p.A. declina qualsiasi responsabilità in caso di modifica, sostituzione o soppressione di applicazioni o specifiche eventualmente apportate, senza preavviso, da parte dei Costruttori.</p> <p>Le caratteristiche tecniche dei nostri prodotti sono suscettibili di modifiche in qualsiasi momento, per apportare migliorie tecniche e tecnologiche.</p>	<p>Alcuni riferimenti presenti in questo catalogo non sono disponibili in tutti i paesi.</p> <p>Gli ordini sono regolamentati dalle condizioni generali di vendita di Valeo Service Italia S.p.A.</p> <p>Le Foto ed i disegni che appaiono nel catalogo sono puramente indicativi. E' vietata la riproduzione della totalità o di una parte della presente pubblicazione senza un'esplicita autorizzazione scritta da parte di Valeo Service Italia S.p.A.</p>
<p>De ter zake van de producten in onze catalogi aangegeven bestemmingen en gedane aanbevelingen zijn gebaseerd op het wagenpark ten tijde van publicatie.</p> <p>Valeo Service Benelux B.V. sluit elke aansprakelijkheid uit met betrekking tot wijziging, vervanging of annulering van de bestemmingen of aanbevelingen, die met name op initiatief van de autofabrikanten kunnen worden doorgevoerd.</p> <p>De technische eigenschappen van onze producten kunnen te allen tijde evolueren teneinde rekening te houden met technische en technologische verbeteringen.</p>	<p>Bepaalde artikelen kunnen in bepaalde landen niet beschikbaar zijn.</p> <p>Orders zijn onderworpen aan de algemene verkoopvoorwaarden van Valeo Service Benelux B.V.</p> <p>Foto's en tekeningen zijn niet bindend.</p> <p>De gehele of gedeeltelijke verveelvoudiging van deze uitgave zonder uitdrukkelijke voorafgaande schriftelijke toestemming van Valeo Service Benelux B.V. is verboden.</p>
<p>Die Verwendungsempfehlungen zu den in diesem Katalog aufgeführten Produkten beziehen sich auf den zum Zeitpunkt des Erscheinens dieses Katalogs existierenden Fahrzeugbestand.</p> <p>Valeo Service Deutschland GmbH übernimmt keine Haftung für Änderungen, Ersetzungen oder Streichungen der Fahrzeuganwendung oder -Empfehlungen, die besonders auf Initiative der Fahrzeughersteller auftreten können.</p> <p>Die technischen Eigenschaften unserer Produkte unterliegen ständiger Entwicklung, um technischen und technologischen Verbesserungen Rechnung zu tragen.</p>	<p>Die Fotos oder Zeichnungen in diesem Katalog dienen ausschliesslich der Veranschaulichung unserer Produkte. Rechtliche Ansprüche können daraus nicht abgeleitet werden.</p> <p>Einige Produktreferenzen sind nicht in allen Ländern verfügbar.</p> <p>Lieferungen unterliegen den Allgemeinen Verkaufsbedingungen von Valeo Service Deutschland GmbH.</p> <p>Die Viervielfältigung dieses Katalogs oder Teilen davon ohne die schriftliche Erlaubnis von Valeo Service Deutschland GmbH ist nicht zulässig.</p>
<p>Przeznaczenie i zalecenia dotyczące produktów figurujących w naszych katalogach biorą pod uwagę stan parku samochodowego w dniu ich wprowadzenia na rynek.</p> <p>Spółka "Valeo Service Eastern Europe Sp.zo.o." nie może być ponosić odpowiedzialności w przypadku zmiany, zastąpienia lub usunięcia wskazań dotyczących przeznaczenia i zaleceń, które mogą wystąpić z inicjatywą producentów samochodów.</p> <p>Dane techniczne naszych produktów mogą być w każdej chwili zmienione w celu uwzględnienia</p>	<p>ulepszeń technicznych i technologicznych.</p> <p>Niektóre modele mogą być niedostępne w niektórych krajach.</p> <p>Zamówienia podlegają ogólnym warunkom umów "Valeo Service Eastern Europe Sp.zo.o.".</p> <p>Wykorzystywanie w całości lub w części zdjęć i rysunków zamieszczonych w naszych katalogach wymaga pisemnej zgody "Valeo Service Eastern Europe Sp.zo.o.".</p>
<p>Učinili jsme všechny kroky nezbytné k tomu, aby informace v tomto dokumentu byly přesné ke dni jeho tisku. Valeo Service Export nezodpovídá za případně neúplné či chyběné informace zde uvedené.</p> <p>Valeo Service Export si vyhrazuje právo úpravy specifikace a / nebo konečné formy výrobku bez předchozího upozornění.</p>	<p>Katalogová čísla obsažená v tomto katalogu nemusí být dostupná k prodeji na všech trzích. Konečné objednávky výrobků se řídí obchodními podmínkami Valeo Service Export.</p> <p>Fotografie a technické náčrty nezávisí na Valeo Service Export. Copyright je exkluzivně Valeo Service Export. Žádná část tohoto katalogu nesmí být kopírována bez autorizace Valeo Service Export.</p>
<p>A VALEO teljes tudásával arra törekszik, hogy a katalógusban szereplő adatok műszaki tartalma teljesen korrekt legyen, ezért a VALEO SERVICE EXPORT nem vállal garanciát azok helyességéért, pontatlanságáért és nem terheli felelősség az esetleges hibákból eredő károkért.</p> <p>A VALEO SERVICE EXPORT fenntartja a jogot a termékváltoztatásokra mellélkel termékinformációt nélkül.</p> <p>A katalógusban szereplő cikkszámok között előfordulhatnak olyanok is, melyek nem minden országban kerülnek forgalomba.</p>	<p>Minden termék rendelés a VALEO SERVICE EXPORT szerződéses feltételei alapján érvényes.</p> <p>A katalógusban szereplő fényképek és rajzok nem a VALEO SERVICE EXPORT készítményei. A szerzői jogok a VALEO SERVICE EXPORT kizárólagos tulajdonát képezik.</p> <p>A kiadvány részét nem képező reprodukciókhoz nem szükséges a VALEO SERVICE EXPORT engedélye.</p>
<p>Назначение и рекомендации по эксплуатации продукции, содержащиеся в наших каталогах, указываются с учетом состояния автомобильного парка на день ее появления.</p> <p>Компания «Valeo Service Eastern Europe Sp.zo.o.» не несет ответственности в случае внесения изменений в рекомендации по эксплуатации продукции или их устранения, произошедших, в частности, по инициативе производителей автомобилей.</p> <p>Технические характеристики нашей продукции могут претерпевать изменения в любой момент, с учетом совершенствования технических и технологических процессов.</p>	<p>Некоторые виды продукции могут не иметься в наличии в отдельных странах.</p> <p>Заказы осуществляются согласно общим правилам торговли, применяемым в компании «Valeo Service Eastern Europe Sp.zo.o.».</p> <p>Фотографии и изображения продукции могут не в полной мере соответствовать оригиналам. Воспроизведение всей или части настоящей публикации запрещено без специального письменного согласия компании «Valeo Service Eastern Europe Sp.zo.o.».</p>
<p>Kataloglarımızda yer alan ürünlerin kullanım ve tanımları, otomobil parkının yayın tarihindeki duruma göre değişir.</p> <p>Valeo Otomotiv Dağıtım AS, özellikle araç, üreticilerinin inisiyatifi sonucu yapılan değişiklikler, ikame veya kaldırılmalardan sorumlu tutulamaz.</p> <p>Ürünlerimizizin teknik özellikleri, teknik ve teknolojik gelişmelere paralel olarak geliştirilebilir.</p>	<p>Bazı referanslar bazı ülkelerde bulunmayabilir.</p> <p>Siparişler, Valeo Otomotiv Dağıtım AS'un genel satış koşullarına uygun olarak ödenir.</p> <p>Fotoğraf ve resimler akdi değildir. İşbu yayının Valeo Otomotiv Dağıtım AS'un önceden verilmiş yazılı izni olmaksızın kısmen veya tamamen çoğaltılması yasaktır.</p>
<p>Ο κατάλογος έχει συσταθεί λαμβάνοντας υπόψη τη σύσταση του στόλου αυτοκινήτων την ημέρα, της κυκλοφορίας του.</p> <p>Η Valeo δε φέρει ευθύνη σε περίπτωση τροποποίησης, αλλαγής ή αντικατάστασης κάποιου αντί/κου που περιέχεται στο κατάλογο, εξαιτίας πρωτοβουλίας του κατασκευαστή του οχήματος.</p> <p>Τα τεχνικά χαρακτηριστικά των προϊόντων ενδέχεται να διαφοροποιηθούν ανά πάσα στιγμή λόγω τεχνολογικών εξελίξεων.</p> <p>Μερικοί κωδικοί αντί/κων μπορεί να μην είναι διαθέσιμοι σε κάποιες χώρες.</p>	<p>Οι παραγγελίες υπόκεινται στους γενικούς όρους πωλήσεων της Valeo.</p> <p>Οι φωτογραφίες και τα σχέδια δεν είναι δεσμευτικά. Η αναπαραγωγή ολόκληρου ή τμήματος αυτού του καταλόγου απαγορεύεται να γίνει χωρίς τη ρητή και γραπτή άδεια της Valeo Service.</p>

EUROPE

FRANCE

VALEO SERVICE FRANCE
70, RUE PLEYEL
93285 SAINT-DENIS CEDEX - FRANCE
TEL. : (+33) 1 49 45 32 32
FAX : (+33) 1 49 45 37 36
S.A.S. au capital de 12 900 000 €
RCS Bobigny B 306 486 408

SPAIN, PORTUGAL

VALEO SERVICE ESPAÑA, S.A.
CALLE RIO ALMANZORA, N°5
AREA EMPRESARIAL ANDALUCIA C.L.A.
28906 GETAFE (MADRID) - ESPAÑA
TEL. : (+34) 91 495 85 00
FAX : (+34) 91 495 86 99
TEL. ATENCIÓN TÉCNICA :
902 011 799
TEL. ATENCIÓN AL CLIENTE :
900 122 657
Valeo Service España Sociedad Anónima
inscrita en el Registro Mercantil de Madrid,
Tomo 972 - Libro 941 de la sección 8ª,
Folio 25 - Hoja 65435 - Inscripción 1ª NIF. A28772978

ITALY

VALEO SERVICE ITALIA SPA
VIA ASTI 89
10026 SANTENA (TO) - ITALIA
TEL. : (+39) 011 94 95 1
FAX : (+39) 011 94 95 280
TEL. LINEA TECNICA : 800 805 046
N. iscrizione al Tribunale di Torino 2009/88 reg. soc.
C.C.I.A.A. 715107 - Capitale sociale € 2.600.000

UNITED KINGDOM

VALEO SERVICE UK LTD
HEMING ROAD - WASHFORD
REDDITCH - WORCS B98 0DZ - ENGLAND
TEL. : (+44) 1527 838 300
FAX : (+44) 1527 523 732
Registration Number : 956685

GERMANY

VALEO SERVICE DEUTSCHLAND GMBH
BRANDENBURGER STRASSE 46
40880 RATINGEN - DEUTSCHLAND
TEL. : (+49) 21 02 865 0
FAX : (+49) 21 02 865 142
Handelsregister Ratingen - HRB 3340

BENELUX

VALEO SERVICE BENELUX B.V.
HEIBLOEMWEG 1
5704 BS HELMOND - THE NETHERLANDS
TEL. BELGIUM (NL) : (+32) 2 366 99 17
TEL. BELGIUM (FR) : (+32) 2 355 14 46
TEL. NETHERLANDS : (+31) 492 580 894
FAX BELGIUM : (+32) 2 366 04 47
FAX NETHERLANDS : (+31) 492 580 828
K.v.K. Eindhoven 33113859

TURKEY

VALEO OTOMOTIV DAĞITIM A.Ş.
AYDINEVLER SANAYI CADDESİ
CENTRUM IS MERKEZİ N°3
KAT: 3, DAIRE N°302-303 KÜÇÜKYALI - MALTEPE
34854 ISTANBUL - TURKEY
TEL. : (+90) 216 518 75 75
FAX : (+90) 216 519 93 14

POLAND, LITHUANIA, LATVIA, ESTONIA, MOLDAVIA, BELARUS, UKRAINE

VALEO SERVICE EASTERN EUROPE SP. ZO.O.
UL. POSTĘPU 13
02-676 WARSZAWA - POLSKA
TEL. : (+48) 22 543 43 00
FAX : (+48) 22 543 43 05
SP. Z O.O. O KAPITALE 4.637.000 PLN
KRS 56793
Sąd Rejonowy dla m.St. Warszawy

RUSSIA

VALEO SERVICE CO LTD
LLC 24/2 RADIO STR. - OFFICE 202
105005 MOSCOW, RUSSIA
TEL. : (+7) 495 981-06-96
FAX. : (+7) 495 787-59-92

SWITZERLAND, AUSTRIA, SWEDEN, FINLAND, NORWAY, DENMARK, ICELAND, GREECE, EASTERN EUROPE, OTHERS

VALEO SERVICE EXPORT
70, RUE PLEYEL
93285 SAINT-DENIS CEDEX - FRANCE
TEL. : (+33) 01 49 45 32 32
FAX : (+33) 01 49 45 36 59

LIAISON OFFICE IN AUSTRIA
MÜHLGASSE 7
2380 PERCHTOLDS DORF - AUSTRIA
TEL. : (+43) 1 480 42 46
FAX. : (+43) 1 480 42 34

LIAISON OFFICE IN CZECH REPUBLIC
DEDINSKA 29
16100 PRAGUE 6 - CZECH REPUBLIC
TEL. : (+420) 220 102 277
FAX. : (+420) 220 102 278

LIAISON OFFICE IN HUNGARY
KOSSUTH UTCA 33
8581 BAKONYJAKO - HUNGARY
TEL. : (+36) 89 350 156
FAX : (+36) 89 350 156

LIAISON OFFICE IN ROMANIA
STR.REGINA ELISABETA NR.15-19
BL.2, SC.2, EJ.3, AP.13
BUCURESTI - ROMANIA
TEL. : (+40) (0)7 54 07 07 65

LIAISON OFFICE IN GREECE
18, KALAMAKIOU AVENUE
174 55 ALIMOS - GREECE
TEL. : (+30) 210 45 27 447
FAX.: (+30) 210 45 27 449

AMERICAS

LATIN AMERICA

VALEO CIBIE SERVICE LTDA
RUA SADAÉ TAKAGI, 2000
BAIRRO COOPERATIVA
09852-070 - SÃO BERNARDO DO CAMPO
SÃO PAULO - BRASIL
TEL. : (+55) 11 43 93 33 54
FAX : (+55) 11 43 93 33 55
C.N.P.J. : 57.010.662/0008-36
Inscrição Estadual : 635.331.124.114

ASIA, AUSTRALIA NEW-ZEALAND

VALEO SERVICE EXPORT
70, RUE PLEYEL
93285 SAINT-DENIS CEDEX - FRANCE
TEL. : (+33) 01 49 45 32 32
FAX : (+33) 01 49 45 36 59

**VALEO AUTO PART TRADING
(SHANGHAI) CO., LTD**
7 FLOOR, INNOV TOWER, 1801 HONG MEI ROAD,
CAOHEJING HI-TECH PARK, XUHUI
DISTRICT, SHANGHAI 200233, CHINA
TEL. : (+86) 21 5171 3576
MP : (+86) 139 1750 0406

AFRICA, MIDDLE EAST, DOM-TOM

VALEO SERVICE EXPORT
70, RUE PLEYEL
93285 SAINT-DENIS CEDEX - FRANCE
TEL. : (+33) 01 49 45 32 32
FAX : (+33) 01 49 45 36 59
S.A.S. au capital de 12 900 000 €
RCS Bobigny B 306 486 408

LIAISON OFFICE IN TUNISIA
CENTRE D'AFFAIRES REGUS
IMMEUBLE CARTHAGE
RUE DU LAC DE CONSTANCE
1053 TUNIS - TUNISIA
TEL. : (216) 71 965 002
FAX : (216) 71 965 137
MOB: (216) 98 34 91 38

Comfort and safety: the Valeo braking range



Your complete offer for comfort and safety



valeo added 

Automotive technology, naturally

Valeo