



[www.vdo.com](http://www.vdo.com)

## Screen and Headlight Washer Systems v 7.0

Scheiben- und Scheinwerfer-Reinigungssysteme

Systèmes de nettoyage pour pare-brise phares

Sistemi tergi-lavavetri per parabrezza e fari

Sistemas de limpeza de faros parabrisas

Очистительные системы для стекол фар



**VDO**



## You really know what you've got: replacement parts from the original equipment manufacturer.

Alongside our many specialised solutions for automotive manufacturers, we also offer comprehensive solutions and services for the aftermarket. Spare parts of matching quality, supplied with the experience and proven expertise of an OEM supplier are a particular strength. Our comprehensive range of spare parts of matching quality is readily available and is synonymous with a perfect fit, simple installation and consistently reliable quality, offering significant advantages for distributors, workshops and consumers alike.

## Da weiß man, was man hat: Ersatzteile vom Erstausrüster.

Neben unseren speziellen und vielfältigen Lösungen für Automobilhersteller bieten wir umfassende Lösungen und Serviceaktivitäten für den Aftermarket. Hierzu zählen insbesondere qualitativ gleichwertige Ersatzteile, die wir mit dem Wissen und der langjährigen Kompetenz eines Erstausrüsters anbieten. Das umfassende und zeitnah verfügbare Leistungsspektrum an Ersatzteilen steht für Passgenauigkeit, einen einfachen Einbau sowie gleichbleibende Qualität. So bieten qualitativ gleichwertige Ersatzteile Großhändlern, Werkstätten und Endkunden gleichermaßen deutliche Vorteile.

## Vous savez vraiment ce que l'on vous fournit : des pièces de rechange d'un équipementier de première monte.

Parallèlement à nos solutions particulières et multiples pour les constructeurs automobile nous offrons des solutions et des activités de service étendues pour l'Aftermarket (marché de pièces de rechange et d'accessoires). En font partie en particulier les pièces détachées qualitativement équivalentes que nous proposons avec le savoir et la compétence de longue durée d'un premier équipementier de série. La gamme étendue de fournitures, disponibles à brève échéance, de pièces détachées représente la précision de l'assemblage, un montage simple ainsi qu'une qualité constante. Ainsi les pièces détachées qualitativement équivalentes offrent des avantages nets de la même manière aux grossistes, aux garages et aux clients finaux.

## Con la certeza de obtener lo mejor: piezas de recambio del fabricante de equipo original

Además de las soluciones especiales y variadas que producimos para fabricantes de automóviles, ofrecemos numerosas soluciones y actividades de servicio para el mercado postventa. Entre éstas destacan en particular los recambios de calidad equivalente, que ofrecemos al mercado con los conocimientos y el nivel de competencia, forjados durante muchos años, de un fabricante de primeros equipos. Nuestro amplísimo espectro de recambios, disponibles al poco tiempo de aparecer en cada modelo de automóvil, se caracterizan por su precisión de ajuste, su montaje sencillo y su calidad constante. Por ello, los recambios de calidad equivalente suponen por igual claras ventajas para mayoristas, talleres y clientes finales.





## Si sa ciò che si ha: i ricambi OEM.







Oltre a numerose soluzioni specializzate per i produttori di automobili offriamo soluzioni e servizi ad ampio spettro per il settore aftermarket (pezzi di ricambio e accessori). Tra questi rientrano in particolare pezzi di ricambio qualitativamente equivalenti che offriamo con il know-how e l'esperienza pluriennale di un fornitore OEM. La vasta gamma di pezzi di ricambio rapidamente disponibili rappresenta una soluzione ottimale, facilmente installabile e di qualità costante. I pezzi di ricambio qualitativamente equivalenti offrono pertanto ai distributori, alle officine e ai clienti finali notevoli vantaggi.

## Уверенность в правильном выборе: запасные детали от предприятия-изготовителя.

Помимо узкоспециальных и широкопрофильных решений для автопроизводителей мы готовы предложить комплексные решения, включая набор сервисных операций, для послепродажного обслуживания автомобилей. В частности, по качеству равноценные оригинальным запасные части, которые мы, как предприятие-изготовитель, предлагаем партнерам на базе наших знаний и многолетнего опыта. С учетом широкого спектра услуг и возможности поставок в кратчайшие сроки гарантирована точность изготовления изделий, простой монтаж и стабильное качество производства. Поэтому приобретая по качеству равноценные оригинальным запасные части у нас, оптовые покупатели, промышленные предприятия и конечные пользователи в одинаковой степени получают очевидные преимущества.



# Contents

	Replacement parts from the original equipment manufacturer	2
	Introduction Screen and Headlight Washer Systems	6
	Product Overview	10
	Product Application trucks	32
	Product Application passenger cars	46
	Cross Reference List	392
	Legend	442



### Immer sauber bleiben: modernste Scheiben- und Scheinwerfer-Reinigungssysteme.

Klare Sicht ist im Straßenverkehr unerlässlich. Unsere Scheiben- und Scheinwerfer-Reinigungssysteme sorgen daher stets für optimalen Durch und damit Überblick. So tragen diese Systeme wesentlich zu einer verbesserten Fahrsicherheit bei. Bei Tag und besonders auch bei Nacht.

### Keep it clean: the most modern screen and headlight washer systems.

Clear visibility is indispensable in road traffic. That is precisely the reason why our windscreen, rear window and headlight washing systems always provide the very best visibility and consequently, an optimal view. Our systems make a considerable contribution to improved driving safety both by day and especially by night.

### Propreté en toutes circonstances : systèmes ultramodernes de nettoyage des glaces et des phares.

Bien voir est indispensable dans la circulation routière. Nos systèmes de nettoyage des glaces et des phares assurent constamment une visibilité optimale et donc une vue dégagée en toutes circonstances. Ainsi, nos systèmes sont une contribution essentielle à la sécurité de conduite pendant la journée et surtout la nuit.

### Manténgalos limpios: sistemas limpiacristales y limpiafaros de vanguardia.

La visibilidad impecable es imprescindible en el tráfico rodado. Por ello, nuestros sistemas limpiacristales y limpiafaros siempre proporcionan la visión de conjunto óptima y, como consecuencia, un control total en cualquier situación. Estos sistemas, por lo tanto, contribuyen substancialmente a una seguridad vial mejorada. Tanto de día como, especialmente, de noche.

### Sempre puliti: Sistemi tergicristalli e tergifarari di ultima generazione.

Una chiara visibilità è essenziale nel traffico stradale. I nostri sistemi tergicristalli e i nostri tergifarari garantiscono una visuale sempre ottimale. Quindi questi sistemi contribuiscono notevolmente a migliorare la sicurezza di guida. Di giorno, e soprattutto anche di notte.

### Чистота всегда: самые современные системы очистки стекол и фар.

Хорошая видимость в дорожном движении обязательна. Поэтому наши системы очистки стекол и фар постоянно заботятся об оптимальной видимости и, тем самым, обзорности при езде. Таким образом, эти системы существенно содействуют повышению безопасности дорожного движения. Днем и особенно ночью.



**Scheiben-Reinigungspumpen – Mono-Pumpen.**

Mono-Pumpen haben einen Förderausgang und versorgen Front- oder Heckscheibe mit Wasser.

**Screen washer pumps – mono pumps.**

Mono pumps have one outlet and supply the front or rear screen with water. Two pumps are needed to supply both screens.

**Pompes de nettoyage des glaces – pompes simples.**

Les pompes simples ont une sortie refoulement et alimentent en liquide le pare-brise et la lunette arrière.

**Bombas de lavado para lunas – monobombas.**

Las monobombas presentan una salida de bombeo y alimentan el parabrisas o la luneta trasera con agua.

**Pompe tergicristalli – Monopompe.**

Le monopompe dispongono di una bocca di mandata e forniscono acqua al parabrezza o al lunotto.

**Насосы стеклоомывателей – мононасосы.**

Мононасосы имеют один подающий выход и снабжают водой либо переднее, либо заднее стекло.

**Scheiben-Reinigungspumpen – Dual-Pumpen.**

Dual-Pumpen haben zwei Förderrichtungen. Mit nur einer Pumpe wird je nach Drehrichtung des Pumpenmotors Reinigungswasser über den einen oder anderen Förderausgang zur Front- oder Heckscheibe gepumpt.

**Screen washer pumps – dual pumps.**

Dual pumps can output fluid in two directions. With only one pump, washer fluid is delivered through one (or both) of the outlets to the front or rear screen.

**Pompes de nettoyage des glaces – pompes tandem.**

Les pompes tandem ont deux dispositifs de refoulement. Avec une seule pompe et en fonction du sens de rotation du moteur de la pompe, le liquide de nettoyage est pompé vers le pare-brise ou la lunette arrière en passant par l'une ou l'autre des sorties refoulement.

**Bombas de lavado para lunas – bombas duales.**

Las bombas duales presentan dos direcciones de bombeo. Según la dirección de giro, con una sola bomba se bombea agua de lavado a través de una salida de alimentación o de la otra hacia el parabrisas o la luneta trasera, respectivamente.

**Pompe tergicristalli – Pompe tandem.**

Le pompe tandem hanno due sensi di mandata. Con un'unica pompa l'acqua viene pompata al parabrezza o al lunotto tramite una delle due bocche di mandata a seconda del senso di rotazione del motore della pompa.

**Насосы стеклоомывателей – двойные насосы.**

Двойные насосы имеют два направления подачи. С помощью только одного насоса, в зависимости от направления вращения двигателя насоса, омывающая жидкость перекачивается через тот или другой выход подачи к переднему или заднему стеклу.



**Scheinwerfer-Reinigungspumpen – Mono-Pumpen.**

Scheinwerfer-Reinigungspumpen dienen der Reinigung der Streuscheiben. Sie versorgen die Streuscheiben- Reinigungsdüsen mit der dafür notwendigen Wassermenge und gewährleisten den erforderlichen hohen Wasserdruck.

**Headlight washer pumps – mono pumps.**

Headlight washer pumps are used for headlight lens cleaning. They supply the headlight lens washer nozzles with a corresponding amount of water and provide the high water pressure needed for this application.

**Pompes de nettoyage des phares – pompes simples.**

Les pompes de nettoyage des phares servent à nettoyer les diffuseurs des phares. Elles fournissent aux buses de nettoyage des diffuseurs la quantité de liquide nécessaire à cet effet en garantissant la haute pression hydraulique requise.

**Bombas de lavado para faros – monobombas.**

Las bombas de lavado para faros se utilizan para la limpieza de los cristales de dispersión. Alimentan las toberas de lavado de los cristales de dispersión con la cantidad de agua necesaria para ello y garantizan la alta presión de agua requerida.

**Pompe tergifari – Monopompe.**

Le pompe tergifari servono per lavare i vetri diffusori dei fari. Forniscono agli ugelli lavavetri diffusori il quantitativo d'acqua necessario e garantiscono l'elevata pressione necessaria dell'acqua.

**Насосы для очистки фар – мононасосы.**

Насосы для очистки фар служат для омывания рассеивателей фар. Они снабжают чистящие форсунки рассеивателей фар должным количеством воды и обеспечивают необходимое высокое давление воды.



**Reinigungsdüsen.**

Reinigungsdüsen dienen der Wasseraufbringung zur Reinigung der Front-/Heckscheiben und der Streuscheiben (Scheinwerfer).

**Washer nozzles.**

Washer nozzles deliver water for cleaning front and rear windshields and headlights. Some nozzles have an anti-drain valve to prevent a return flow of fluid.

**Buses de nettoyage.**

Les buses de nettoyage servent à projeter le liquide de nettoyage du pare-brise, de la lunette arrière et des diffuseurs (des phares).

**Toberas de lavado.**

Las toberas de lavado sirven para la aplicación del agua necesaria para la limpieza del parabrisas/la luneta trasera y de los cristales de dispersión (faros).

**Ugelli spruzzatori.**

Gli ugelli spruzzatori forniscono l'acqua per il lavaggio del parabrezza, del lunotto e dei vetri diffusori dei fari.

**Чистящие форсунки омывателей.**

Чистящие форсунки омывателей служат для нанесения воды для омывания переднего/заднего стекла и рассеивателей фар.



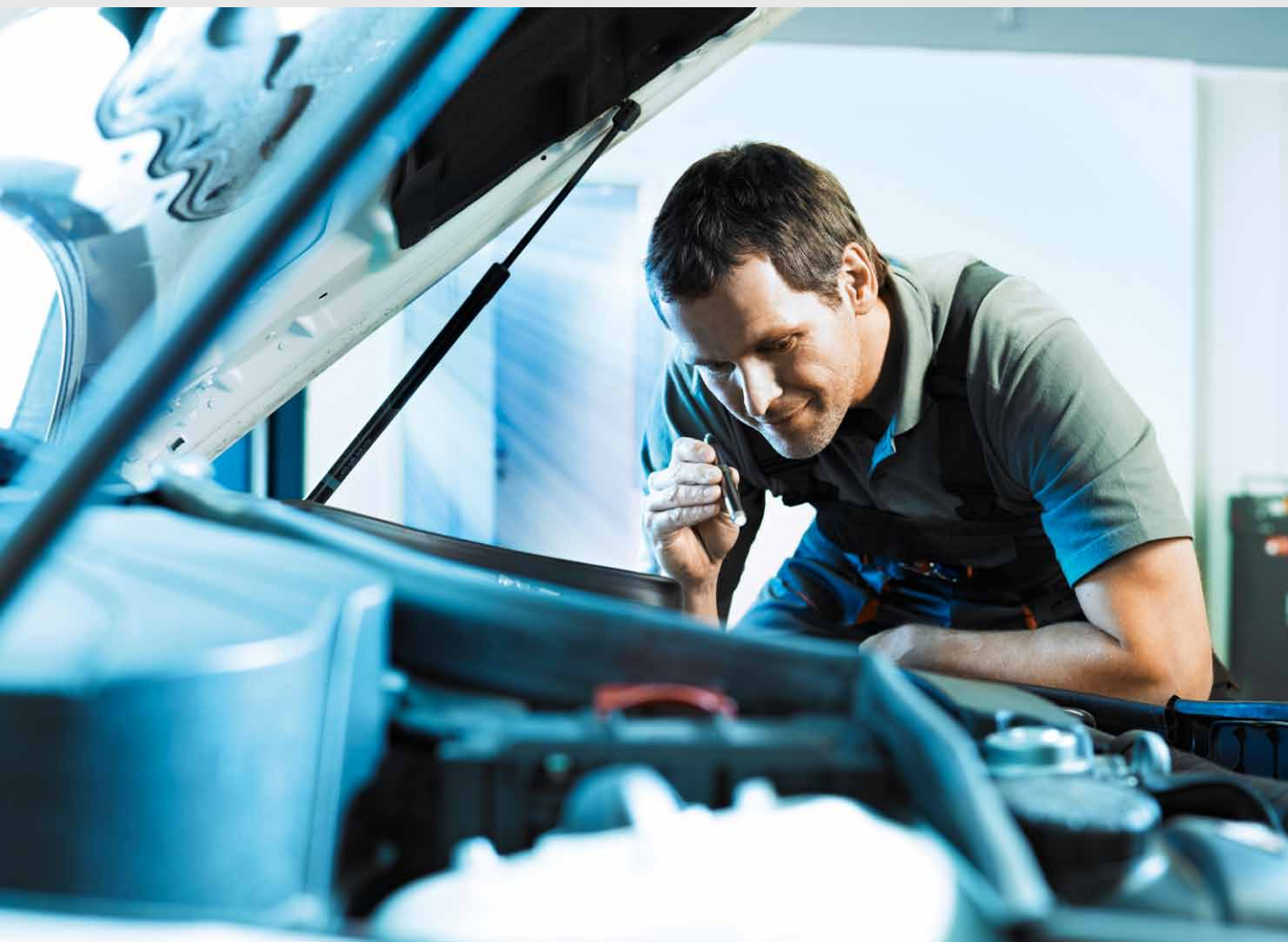

#### Zubehör.

Das Zubehör vervollständigt unser Lieferprogramm für Scheiben- und Scheinwerfer-Reinigungssysteme.

- Niveauschalter
- Verbindungsstücke
- Ventile
- Filter
- Düsenadeln
- Reinigungsflüssigkeits-Behälter

#### Accessories.

Our accessories include a wide range of products for windshield and headlight washer systems.

- Level switches
- Connectors
- Valves
- Filters
- Nozzle needles
- Washer fluid tanks

#### Accessoires.

Les accessoires complètent notre gamme de systèmes de nettoyage des glaces et des phares.

- Détecteurs de niveau
- Pièces de jonction
- Valves
- Filtres
- Pointeaux
- Réservoirs de liquide de nettoyage

#### Accesorios.

Los accesorios completan nuestra gama de productos para los sistemas limpiacristales y limpiafaros

- Conmutador de nivel
- Piezas de conexión
- Válvulas
- Filtros
- Agujas de tobera
- Depósito para líquido de lavado

#### Accessori.

Gli accessori completano il nostro programma di fornitura di sistemi tergicristalli e tergifari.

- Interruttore di livello
- Raccordi
- Valvole
- Filtri
- Aghi ugello
- Serbatoi liquido di lavaggio

#### Принадлежности.

Принадлежности дополняют нашу программу поставки для систем очистки стекол и фар.

- Реле уровня
- Соединительные элементы
- Клапаны
- Фильтр
- Иголки для форсунки
- Бачок для моющей жидкости



**246-060-035-008G**  
**Nozzle Needle (NN)**



**246-061-009-002D**  
**Reservoir (R)**  
— Capacity [Litre] (T3): 1,0



**246-061-022-001C**  
**Reservoir (R)**  
— Capacity [Litre] (T3): 2,0



**246-063-004-001G**  
**Valve (V)**  
— Shape (T6): T-Piece (T7)  
— Valve Type (T9): Non-return Valve (T10)



**246-063-012-001G**

**Valve (V)**

- Shape (T6): I Form (T8)
- Valve Type (T9): Non-return Valve (T10)



**246-063-013-001D**

**Valve (V)**

- Shape (T6): T-Piece (T7)
- Valve Type (T9): Non-return Valve (T10)



**246-068-003-001G**

**Nozzle (N)**

- Design (T15): One-hole Nozzle (T16)



**246-068-013-004D**

**Nozzle (N)**

- Design (T15): One-hole Nozzle (T16)



**246-069-026-001G**

**Nozzle (N)**

— Design (T15): Two-hole Nozzle (T17)

**MERCEDES-BENZ**

/8 (W114); /8 (W115); Saloon (W123); KOMBI Estate (S123); COUPE (C123); S-CLASS (W108, W109)



**246-069-029-004G**

**Nozzle (N)**

— Design (T15): Two-hole Nozzle (T17)



**246-069-050-005D**

**Nozzle (N)**

— Design (T15): Four-hole Nozzle (T18)



**246-069-056-001Z**

**Nozzle (N)**

— Design (T15): Two-hole Nozzle (T17)

**SEAT**

CORDOBA (6K1, 6K2); CORDOBA Vario (6K5); IBIZA II (6K1); INCA (6K9); LEON (1M1); TOLEDO II (1M2)

**VW**

CADDY I (14); CADDY II Box (9K9A); CORRADO (53I); GOLF I Cabriolet (155); GOLF III (1H1); GOLF III Variant (1H5); GOLF III Cabriolet (1E7); GOLF IV Cabriolet (1E7); PASSAT (3A2, 35I); PASSAT Variant (3A5, 35I); POLO (6N1); POLO Box (6NF); POLO CLASSIC (6KV2); POLO Variant (6KV5); POLO (6N2); VENTO (1H2); TRANSPORTER IV Bus (70XB, 70XC, 7DB, 7DW); TRANSPORTER IV Platform/Chassis (70XD)



**246-069-059-001Z**

**Nozzle (N)**

— Design (T15): Two-hole Nozzle (T17)

**BMW**

3 (E36); 3 Compact (E36); 3 Coupe (E36); 3 Convertible (E36); 3 Touring (E36); 5 (E34);  
5 Touring (E34); 7 (E32)



**246-075-010-001C**

**Screen Washer Pump, Mono - Gear-type Pump (SWP-M-G)**

— Operating Voltage (T1): 24  
— Plug Number (T2): 1  
— Pump Type (T20): Mono Pump (T21)  
— Number of pump holder (T23): A

**MAN**

M 2000 L; M 90; G



**246-075-015-001C**

**Screen Washer Pump, Mono - Gear-type Pump (SWP-M-G)**

— Operating Voltage (T1): 12  
— Plug Number (T2): 1  
— Pump Type (T20): Mono Pump (T21)  
— Number of pump holder (T23): A

**PORSCHE**

911; 911 Targa; 914; 928



**246-075-017-002C**

**Screen Washer Pump, Mono - Gear-type Pump (SWP-M-G)**

— Operating Voltage (T1): 12  
— Plug Number (T2): 4  
— Pump Type (T20): Mono Pump (T21)  
— Number of pump holder (T23): C

**MERCEDES-BENZ**

/8 (W114); /8 Coupe (W114); /8 (W115); HECKFLOSSE (W111, W112); COUPE (W111);  
S-CLASS (W108, W109); S-CLASS (W116); PAGODE (W113); CABRIOLET (W111); SL (R107);  
G-CLASS (W460); G-CLASS Cabrio (W463); VITO Bus (638); VITO Box (638); VITO Bus (W639);  
VITO / MIXTO Box (W639); SPRINTER 3-t Bus (903); SPRINTER 3-t Box (903);  
SPRINTER 3-t Platform/Chassis (903); T1 Bus (602); T1 Box (602); T1 Platform/Chassis (602)

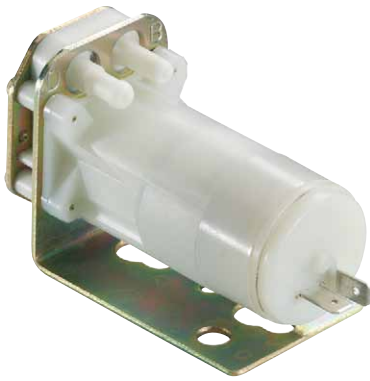

**246-075-021-006C**

**Screen Washer Pump, Mono - Gear-type Pump (SWP-M-G)**

- Operating Voltage (T1): 12
- Plug Number (T2): 1
- Pump Type (T20): Mono Pump (T21)
- Number of pump holder (T23): B

**ALPINA**

B7 Coupe (E24)

**AUDI**

50 (86); 80 (80, 82, B1); 100 Avant (43, C2); 100 (44, 44Q, C3); 100 Avant (44, 44Q, C3); 200 (44, 44Q); 200 Avant (44, 44Q)

**PORSCHE**

924; 944; 944 Convertible

**VW**

DERBY (86); GOLF I (17); JETTA I (16); KAEFER; KARMANN GHIA Convertible (14, 34); K 70 (48); PASSAT (32); PASSAT Variant (33); POLO (86); SCIROCCO (53); 1500,1600 Variant (36); LT 28-35 I Bus (281-363); LT 28-35 I Box (281-363); LT 28-35 I Platform/Chassis (281-363); LT 40-55 I Platform/Chassis (293-909); TRANSPORTER II Bus; TRANSPORTER II Platform/Chassis



**246-075-021-007C**

**Screen Washer Pump, Mono - Gear-type Pump (SWP-M-G)**

- Operating Voltage (T1): 12
- Plug Number (T2): 1
- Pump Type (T20): Mono Pump (T21)
- Number of pump holder (T23): C

**MERCEDES-BENZ**

/8 (W114); /8 Coupe (W114); /8 (W115); S-CLASS (W116); G-CLASS (W460); G-CLASS Cabrio (W463); VITO Bus (638); VITO Box (638); VITO Bus (W639); VITO / MIXTO Box (W639); SPRINTER 3-t Bus (903); SPRINTER 3-t Box (903); SPRINTER 3-t Platform/Chassis (903); T1 Bus (601); T1 Box (601); T1 Bus (602); T1 Box (602); T1 Platform/Chassis (602)

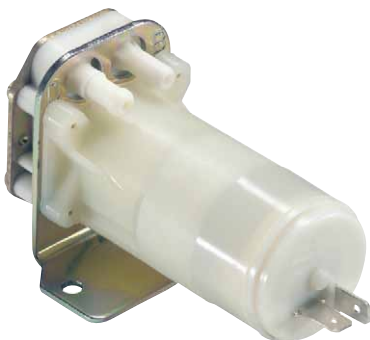

**246-075-023-004C**

**Screen Washer Pump, Mono - Gear-type Pump (SWP-M-G)**

- Operating Voltage (T1): 12
- Plug Number (T2): 1
- Pump Type (T20): Mono Pump (T21)
- Number of pump holder (T23): D

**BMW**

5 (E12); 2000-3.2 Coupe (E9); 2500-3.3 (E3)



**246-075-024-002C**

**Screen Washer Pump, Mono - Gear-type Pump (SWP-M-G)**

- Operating Voltage (T1): 24
- Plug Number (T2): 1
- Pump Type (T20): Mono Pump (T21)
- Number of pump holder (T23): C

**MERCEDES-BENZ**

NG; VITO Bus (638); VITO Box (638); T1 Box (602); T2/L Platform/Chassis; T2/L Box Body / Estate



**246-075-040-020C**

**Screen Washer Pump, Mono - Gear-type Pump (SWP-M-G)**

- Operating Voltage (T1): 24
- Plug Number (T2): 1
- Pump Type (T20): Mono Pump (T21)
- Number of pump holder (T23): F

**VOLVO**

F 10



**246-075-042-001C**

**Screen Washer Pump, Mono - Gear-type Pump (SWP-M-G)**

- Operating Voltage (T1): 12
- Plug Number (T2): 1
- Pump Type (T20): Mono Pump (T21)

**BMW**

6 (E24); 7 (E23)

**PORSCHE**

911 Convertible (964); 924; 928; 944

**VOLVO**

340-360 (343, 345)



**246-075-044-001C**

**Screen Washer Pump, Mono - Gear-type Pump (SWP-M-G)**

- Operating Voltage (T1): 12
- Plug Number (T2): 2
- Pump Type (T20): Mono Pump (T21)

**VOLVO**

740 (744); 740 Kombi (745); 760 (704, 764); 760 Kombi (704, 765); 780; 850 (LS); 850 Estate (LW); 940 (944); 940 Kombi (945); 940 II (944); 940 II Estate (945); 960 (964); 960 Kombi (965); 960 II (964); 960 II Estate (965)



**246-075-044-002A**

**Screen Washer Pump, Mono - Gear-type Pump (SWP-M-G)**

- Operating Voltage (T1): 12
- Plug Number (T2): 2
- Pump Type (T20): Mono Pump (T21)

**VOLVO**

V70 I (P80\_); V90 Estate; 140 (142, 144); 740 Kombi (745); 760 Kombi (704, 765); 850 Estate (LW); 940 Kombi (945); 940 II Estate (945); 960 Kombi (965); 960 II Estate (965)



**246-075-044-003A**

**Screen Washer Pump, Mono - Gear-type Pump (SWP-M-G)**

- Operating Voltage (T1): 24
- Plug Number (T2): 2
- Pump Type (T20): Mono Pump (T21)

**SCANIA**

4 - series; 3 - series



**246-075-050-007C**

**Screen Washer Pump, Mono - Gear-type Pump (SWP-M-G)**

- Operating Voltage (T1): 24
- Plug Number (T2): 1
- Pump Type (T20): Mono Pump (T21)



**246-075-051-007C**

**Screen Washer Pump, Mono - Gear-type Pump (SWP-M-G)**

- Operating Voltage (T1): 24
- Plug Number (T2): 2
- Pump Type (T20): Mono Pump (T21)
- Number of pump holder (T23): F

**VOLVO**

F 10; F 12; F 16





**246-080-003-006D**

**Nozzle, heatable (N-H)**

- Operating Voltage (T1): 12
- Design (T15): Two-hole Nozzle (T17)
- Design (T15): Heated (T19)

**MERCEDES-BENZ**

S-CLASS (W126)



**246-080-010-002Z**

**Nozzle, heatable (N-H)**

- Operating Voltage (T1): 12
- Design (T15): Two-hole Nozzle (T17)
- Design (T15): Heated (T19)

**SEAT**

CORDOBA (6K1, 6K2); IBIZA II (6K1); INCA (6K9); LEON (1M1); TOLEDO I (1L); TOLEDO II (1M2)

**VW**

CADDY I (14); CADDY II Box (9K9A); CORRADO (53I); GOLF I Cabriolet (155); GOLF III (1H1); GOLF III Variant (1H5); GOLF III Cabriolet (1E7); PASSAT (3A2, 35I); PASSAT Variant (3A5, 35I); POLO (6N1); POLO CLASSIC (6KV2); VENTO (1H2); TRANSPORTER IV Bus (70XB, 70XC, 7DB, 7DW); TRANSPORTER IV Box (70XA); TRANSPORTER IV Platform/Chassis (70XD)



**246-080-013-001Z**

**Nozzle, heatable (N-H)**

- Operating Voltage (T1): 12
- Design (T15): Two-hole Nozzle (T17)
- Design (T15): Heated (T19)

**BMW**

3 (E30); 3 Touring (E30); 5 (E34); 6 (E24); 7 (E32)



**246-080-013-003Z**

**Nozzle, heatable (N-H)**

- Operating Voltage (T1): 12
- Design (T15): Two-hole Nozzle (T17)
- Design (T15): Heated (T19)

**BMW**

3 Convertible (E30); 3 (E36); 3 Compact (E36); 3 Coupe (E36); 3 Touring (E36); 5 (E34); 5 Touring (E34); 7 (E32); Z1; Z3 (E36); Z3 Coupe (E36)



**246-082-001-001C**

**Screen Washer Pump, Mono - Centrifugal Pump (SWP-M-C)**

- Operating Voltage (T1): 12
- Plug Number (T2): 2
- Pump Type (T20): Mono Pump (T21)

**SAAB**

900 I Combi Coupe; 900 I (AC4, AM4); 900 I Convertible; 9000 Hatchback; 9000



**246-082-001-002C**

**Screen Washer Pump, Mono - Centrifugal Pump (SWP-M-C)**

- Operating Voltage (T1): 24
- Plug Number (T2): 2
- Pump Type (T20): Mono Pump (T21)



**246-082-005-002C**

**Screen Washer Pump, Mono - Centrifugal Pump (SWP-M-C)**

- Operating Voltage (T1): 12
- Plug Number (T2): 4
- Pump Type (T20): Mono Pump (T21)

**MERCEDES-BENZ**

190 (W201); Saloon (W124); KOMBI Estate (S124); CABRIOLET (A124); Saloon (W123); KOMBI Estate (S123); COUPE (C124); E-CLASS (W124); E-CLASS Estate (S124); E-CLASS Coupe (C124); E-CLASS Convertible (A124); S-CLASS (W126); S-CLASS Coupe (C126); S-CLASS (W140); SL (R107)



**246-082-008-012C**

**Screen Washer Pump, Mono - Centrifugal Pump (SWP-M-C)**

- Operating Voltage (T1): 24
- Plug Number (T2): 1
- Pump Type (T20): Mono Pump (T21)

**MAN**

G

**MERCEDES-BENZ**

MK; LK/LN2; LP; T2/LN1 Box Body / Estate; T2/LN1 Platform/Chassis; T2/LN1 Cab with engine; T2/LN1 Dumptruck; T2/LN1 Bus; VARIO Bus; VARIO Platform/Chassis; VARIO Box Body / Estate; VARIO Dumptruck

**246-082-008-013P****Screen Washer Pump, Mono - Centrifugal Pump (SWP-M-C)**

- Operating Voltage (T1): 12
- Plug Number (T2): 4
- Pump Type (T20): Mono Pump (T21)

**MERCEDES-BENZ**

190 (W201); C-CLASS (W202); C-CLASS Estate (S202); Saloon (W124); KOMBI Estate (S124); CABRIOLET (A124); /8 (W114); /8 (W115); Saloon (W123); KOMBI Estate (S123); COUPE (C123); COUPE (C124); E-CLASS (W124); E-CLASS Estate (S124); E-CLASS Coupe (C124); E-CLASS Convertible (A124); E-CLASS (W210); SL Coupe (C107); S-CLASS (W126); S-CLASS Coupe (C126); S-CLASS (W140); S-CLASS Coupe (C140); S-CLASS Coupe (C215); SL (R107); SL (R129)

**246-082-008-014C****Screen Washer Pump, Mono - Centrifugal Pump (SWP-M-C)**

- Operating Voltage (T1): 12
- Plug Number (T2): 1
- Pump Type (T20): Mono Pump (T21)

**ALFA ROMEO**

146 (930); 155 (167); 156 (932); 156 Sportwagon (932); GT (937); GTV (916C\_); SPIDER (916S\_)

**AUDI**

A6 (4A, C4); A6 Avant (4A, C4); A6 Avant (4B, C5); V8 (44\_, 4C\_); 50 (86); 80 (80, 82, B1); 80 (81, 85, B2); COUPE (81, 85); QUATTRO (85); 80 (89, 89Q, 8A, B3); COUPE (89, 8B); CABRIOLET (8G7, B4); 80 Avant (8C, B4); 90 (81, 85, B2); 90 (89, 89Q, 8A, B3); 100 (C1); 100 (43, C2); 100 Avant (43, C2); 100 (44, 44Q, C3); 100 Avant (44, 44Q, C3); 100 (4A, C4); 100 Avant (4A, C4); 200 (43); 200 (44, 44Q); 200 Avant (44, 44Q)

**FIAT**

DOBLO (119); DOBLO Cargo (223); MAREA (185); PALIO (178BX); PALIO Weekend (178DX); PUNTO Convertible (176C); SIENA (178\_); STRADA (178E); TEMPRA (159); DUCATO Bus (230); DUCATO Box (230L); DUCATO Platform/Chassis (230); DUCATO Bus (244, Z\_); DUCATO Box (244); DUCATO Platform/Chassis (244)

**FORD**

TRANSIT Bus (T\_); TRANSIT Box (T\_); TRANSIT Box (E\_); TRANSIT Box (E\_)

**LADA**

NIVA (2121); SAMARA (2108, 2109); SAMARA FORMA (21099)

**LANCIA**

DEDRA (835); DEDRA SW (835); KAPPA (838A); KAPPA Coupe (838); KAPPA SW (838B); LYBRA (839AX); LYBRA SW (839BX); THESIS (841AX)

**MERCEDES-BENZ**

G-CLASS (W460); V-CLASS (638/2); VITO Bus (638); VITO Box (638); SPRINTER 2-t Bus (901, 902); SPRINTER 2-t Box (901, 902); SPRINTER 2-t Platform/Chassis (901, 902); SPRINTER 3-t Bus (903); SPRINTER 3-t Box (903); SPRINTER 3-t Platform/Chassis (903); SPRINTER 4-t Bus (904); SPRINTER 4-t Box (904); SPRINTER 4-t Platform/Chassis (904); T1 Bus (601); T1 Box (601); T1 Platform/Chassis (601)

**OPEL**

ASCONA C Hatchback (84\_, 89\_); ASCONA C (81\_, 86\_, 87\_, 88\_); ASTRA F Hatchback (53\_, 54\_, 58\_, 59\_); ASTRA F (56\_, 57\_); ASTRA F Estate (51\_, 52\_); ASTRA F Convertible (53\_B); ASTRA F Van (55\_); ASTRA F CLASSIC Hatchback; ASTRA F CLASSIC Saloon; ASTRA F CLASSIC Estate; COMMODORE C (14\_, 19\_); COMMODORE C Estate (61); CORSA A Hatchback (93\_, 94\_, 98\_, 99\_); CORSA A TR (91\_, 92\_, 96\_, 97\_); CORSA A Box; CORSA B (73\_, 78\_, 79\_); CORSA B Estate (F35); CORSA B Box (73\_); KADETT E Hatchback (33\_, 34\_, 43\_, 44\_); KADETT E (39\_, 49\_); KADETT E Estate (35\_, 36\_, 45\_, 46\_); KADETT E Convertible (43B\_); KADETT E Box (37\_, 47\_); KADETT E Combo (38\_, 48\_); OMEGA A (16\_, 17\_, 19\_); OMEGA A Estate (66\_, 67\_); SENATOR B (29\_); VECTRA A (86\_, 87\_)

**PORSCHE**

911; 911 Targa; 911 Convertible; 911 (964); 911 Convertible (964); 911 Convertible (993)

**246-082-008-014C****Screen Washer Pump, Mono - Centrifugal Pump (SWP-M-C)**

- Operating Voltage (T1): 12
- Plug Number (T2): 1
- Pump Type (T20): Mono Pump (T21)

**SAAB**

90; 900 I Combi Coupe; 900 I (AC4, AM4); 9000 Hatchback; 9000

**SEAT**

TOLEDO I (1L)

**VAUXHALL**

ASTRA Mk III (F); CARLTON Mk III; CARLTON Mk III Estate; CAVALIER Mk II Hatchback; CAVALIER Mk II; CAVALIER Mk II Estate; CAVALIER Mk II Convertible; CAVALIER Mk III (87); NOVA; NOVA Hatchback; OMEGA (B); SENATOR Mk II (B)

**VW**

CADDY I (14); CORRADO (53I); DERBY (86); DERBY (86C, 80); GOLF I (17); GOLF I Cabriolet (155); GOLF II (19E, 1G1); ILTIS (183); JETTA I (16); JETTA II (19E, 1G2, 165); PASSAT (32); PASSAT Variant (33); PASSAT (32B); PASSAT Saloon (32B); PASSAT Variant (32B); PASSAT (3A2, 35I); POLO (86); POLO (86C, 80); POLO CLASSIC (86C, 80); POLO Coupe (86C, 80); POLO Box (86CF); POLO (6N1); POLO CLASSIC (6KV2); SANTANA (32B); SCIROCCO (53); SCIROCCO (53B); LT 28-35 I Bus (281-363); LT 28-35 I Box (281-363); LT 28-35 I Platform/Chassis (281-363); LT 40-55 I Box (291-512); LT 28-35 II Bus (2DM); LT 28-46 II Box (2DX0AE); LT 28-46 II Platform/Chassis (2DX0FE); TRANSPORTER III Bus; TRANSPORTER III Box; TRANSPORTER III Platform/Chassis; TRANSPORTER IV Bus (70XB, 70XC, 7DB, 7DW); TRANSPORTER IV Box (70XA); TRANSPORTER IV Platform/Chassis (70XD)

**246-082-008-021G****Screen Washer Pump, Mono - Centrifugal Pump (SWP-M-C)**

- Operating Voltage (T1): 12
- Plug Number (T2): 6
- Pump Type (T20): Mono Pump (T21)

**OPEL**

ASTRA G Coupe (F07\_); CORSA B (73\_, 78\_, 79\_); CORSA C (F08, F68); OMEGA B (25\_, 26\_, 27\_); TIGRA (95\_); VECTRA B (36\_); VECTRA C GTS; VECTRA C; ZAFIRA A (F75\_)

**SEAT**

INCA (6K9)

**VAUXHALL**

OMEGA (B); VECTRA (B); VECTRA (B) Hatchback

**VW**

GOLF III Variant (1H5); GOLF III Cabriolet (1E7); GOLF IV Variant (1J5); GOLF IV Cabriolet (1E7); PASSAT (3A2, 35I); PASSAT (3B2); VENTO (1H2); TRANSPORTER IV Bus (70XB, 70XC, 7DB, 7DW); TRANSPORTER IV Box (70XA); TRANSPORTER IV Platform/Chassis (70XD)

**246-082-008-025G****Screen Washer Pump, Mono - Centrifugal Pump (SWP-M-C)**

— Operating Voltage (T1): 12

**AUDI**

A2 (8Z0); A3 Convertible (8P7); A4 (8D2, B5); A4 Avant (8D5, B5); A4 (8E2, B6); A4 Avant (8E5, B6); A4 Convertible (8H7, B6, 8HE, B7); A4 (8EC, B7); A4 (8K2, B8); A4 Allroad (8KH, B8); A5 (8T3); A5 Sportback (8TA); A5 Convertible (8F7); A6 (4B, C5); A6 (4F2, C6); A6 Allroad (4FH, C6); A7 Sportback (4GA); A8 (4E\_); A8 (4H\_); R8; R8 Spyder; TT (8N3); TT Roadster (8N9); TT (8J3); TT Roadster (8J9)

**BMW**

1 (E81, E87); 1 (F20, F21); 3 (E36); 3 Compact (E36); 3 Coupe (E36); 3 Convertible (E36); 3 Touring (E36); 3 (E46); 3 Compact (E46); 3 Coupe (E46); 3 Convertible (E46); 3 Touring (E46); 3 (E90); 3 Touring (E91); 5 (E39); 5 Touring (E39); 5 (E60); 5 Touring (E61); 5 Touring (F11); 7 (E38); 7 (E65, E66); X1 (E84); X3 (E83); X3 (F25); X5 (E53); Z3 (E36); Z3 Coupe (E36); Z4 (E85); Z4 Coupe (E86); Z8 (E52)

**FORD**

MONDEO III Saloon (B4Y)

**HONDA**

CIVIC VIII Hatchback (FN, FK); CIVIC VIII Saloon (FD, FA)

**MERCEDES-BENZ**

C-CLASS (W202); C-CLASS Estate (S202); C-CLASS (W203); C-CLASS T-Model (S203); C-CLASS Coupe (CL203); C CLASS (W204); C-CLASS Coupe (C204); CLK (C208); CLK Convertible (A208); CLK (C209); CLK Convertible (A209); CLS (C219); 170 (W170); E-CLASS (W210); E-CLASS Estate (S210); E-CLASS (W211); E-CLASS T-Model (S211); E-CLASS (W212); E-CLASS Coupe (C207); E-CLASS Convertible (A207); S-CLASS (W140); S-CLASS Coupe (C140); S-CLASS (W220); S-CLASS Coupe (C215); S-CLASS (W221); S-CLASS Coupe (C216); SL (R129); SL (R230); SLK (R170); SLK (R171); M-CLASS (W163); G-CLASS (W461); G-CLASS (W463); G-CLASS Cabrio (W463); VIANO (W639); VITO Bus (W639); VITO / MIXTO Box (W639)

**SEAT**

CORDOBA (6K1, 6K2); CORDOBA Vario (6K5); CORDOBA (6K2); CORDOBA Vario (6K5); CORDOBA (6L2); EXEO (3R2); EXEO ST (3R5); IBIZA II (6K1); IBIZA III (6K1); IBIZA IV (6L1); IBIZA V (6J5); IBIZA V SPORTCOUPE (6J1); IBIZA V ST (6J8); INCA (6K9); LEON (1M1); TOLEDO II (1M2)

**SKODA**

FABIA (6Y2); FABIA Saloon (6Y3); FABIA; OCTAVIA (1U2); OCTAVIA Combi (1U5); OCTAVIA (1Z3); OCTAVIA Combi (1Z5); ROOMSTER (5J); SUPERB (3U4); SUPERB (3T4)

**SMART**

FORTWO Cabrio (451)

**VW**

AMAROK; BORA (1J2); BORA Estate (1J6); CADDY II Estate (9K9B); CADDY II Box (9K9A); CADDY II Pickup (9U7); CADDY III Estate (2KB, 2KJ, 2CB, 2CJ); CADDY III Box (2KA, 2KH, 2CA, 2CH); EOS (1F7, 1F8); FOX (5Z1, 5Z3); GOLF III Cabriolet (1E7); GOLF IV (1J1); GOLF IV Cabriolet (1E7); GOLF V (1K1); GOLF VI Variant (AJ5); JETTA III (1K2); NEW BEETLE (9C1, 1C1); NEW BEETLE Convertible (1Y7); PASSAT (3A2, 351); PASSAT Variant (3A5, 351); PASSAT (3B2); PASSAT Variant (3B5); PASSAT (3B3); PASSAT Variant (3B6); PASSAT (3C2); PASSAT Variant (3C5); PASSAT CC (357); PHAETON (3D\_); POLO (6N1); POLO CLASSIC (6KV2); POLO PLAYA; POLO (6N2); POLO (9N\_); POLO Saloon (9A4); VENTO (1H2); TRANSPORTER IV Bus (70XB, 70XC, 7DB, 7DW); TRANSPORTER IV Box (70XA); TRANSPORTER V Bus (7HB, 7HJ, 7EB, 7EJ, 7EF); TRANSPORTER V Box (7HA, 7HH, 7EA, 7EH); TRANSPORTER V Platform/Chassis (7JD, 7JE, 7JL, 7JY, 7JZ, 7FD)

**246-083-001-004C****Screen Washer Pump, Dual - Centrifugal Pump (SWP-D-C)**

- Operating Voltage (T1): 12
- Plug Number (T2): 1
- Pump Type (T20): Dual Pump (T22)

**ALFA ROMEO**

145 (930); 146 (930); 147 (937); 156 (932); 156 Sportwagon (932)

**FIAT**

BRAVA (182); BRAVO I (182); COUPE (FA/175); DOBLO (119); DOBLO Cargo (223); IDEA;  
MAREA (185); MAREA Weekend (185); MULTIPLA (186); PALIO (178BX); PALIO Weekend (178DX);  
PANDA (169); PUNTO (176); PUNTO Convertible (176C); PUNTO Van (176L); PUNTO (188);  
PUNTO Van (188AX); STILO (192); STILO Multi Wagon (192); TEMPRA (159); TEMPRA S.W. (159);  
TIPO (160)

**LANCIA**

DEDRA (835); DEDRA SW (835); DELTA II (836); LYBRA (839AX); LYBRA SW (839BX); MUSA (350);  
Y (840A); YPSILON (843)

**OPEL**

ASTRA F Hatchback (53\_, 54\_, 58\_, 59\_); ASTRA F (56\_, 57\_); ASTRA F Estate (51\_, 52\_);  
ASTRA F Convertible (53\_B); CALIBRA A (85\_); COMBO (71\_);  
CORSA A Hatchback (93\_, 94\_, 98\_, 99\_); CORSA B (73\_, 78\_, 79\_);  
KADETT E Hatchback (33\_, 34\_, 43\_, 44\_); KADETT E (39\_, 49\_); KADETT E Convertible (43B\_);  
OMEGA B Estate (21\_, 22\_, 23\_); TIGRA (95\_); VECTRA A Hatchback (88\_, 89\_)

**VAUXHALL**

ASTRA Mk III (F); ASTRA Mk III (F) Hatchback; ASTRA Mk III (F) Estate; CALIBRA;  
CAVALIER Mk III Hatchback; CAVALIER Mk III (87); COMBO Mk I (B); CORSA Mk I (B);  
CORSA Convertible; CORSAVAN Mk I (B); OMEGA (B) Estate; TIGRA Mk I (F07)

**246-083-001-006C****Screen Washer Pump, Dual - Centrifugal Pump (SWP-D-C)**

- Operating Voltage (T1): 24
- Plug Number (T2): 1
- Pump Type (T20): Dual Pump (T22)

**MAN**

F 2000; L 2000

**246-083-002-006G****Screen Washer Pump, Dual - Centrifugal Pump (SWP-D-C)**

- Operating Voltage (T1): 12
- Plug Number (T2): 1
- Pump Type (T20): Dual Pump (T22)

**VW**

CORRADO (53I); PASSAT Variant (32B); PASSAT Variant (3A5, 35I); POLO (86C, 80);  
POLO Coupe (86C, 80); TRANSPORTER IV Bus (70XB, 70XC, 7DB, 7DW)

**246-083-002-014G****Screen Washer Pump, Dual - Centrifugal Pump (SWP-D-C)**

- Operating Voltage (T1): 12
- Plug Number (T2): 6
- Pump Type (T20): Dual Pump (T22)

**FORD**

GALAXY (WGR)

**OPEL**

AGILA (A) (H00); ASTRA F Van (55\_); ASTRA F CLASSIC Hatchback; ASTRA F CLASSIC Estate; ASTRA G Hatchback (F48\_, F08\_); ASTRA G Saloon (F69\_); ASTRA G Estate (F35\_); ASTRA G Box (F70); COMBO (71\_); COMBO Tour; CORSA B (73\_, 78\_, 79\_); CORSA C (F08, F68); MERIVA; OMEGA B Estate (21\_, 22\_, 23\_); TIGRA (95\_); VECTRA B Hatchback (38\_); VECTRA B Estate (31\_); VECTRA C GTS; VECTRA C; ZAFIRA A (F75\_)

**SEAT**

ALHAMBRA (7V8, 7V9); IBIZA II (6K1); INCA (6K9)

**VAUXHALL**

AGILA Mk I (A); ASTRA Mk IV (G) Hatchback; ASTRA Mk IV (G) Estate; CORSA Mk I (B); OMEGA (B) Estate; VECTRA (B) Estate; ZAFIRA Mk I (A) (F75)

**VW**

CADDY II Box (9K9A); CORRADO (53I); GOLF II (19E, 1G1); GOLF III (1H1); GOLF III Variant (1H5); JETTA II (19E, 1G2, 165); PASSAT (3A2, 35I); PASSAT Variant (3A5, 35I); PASSAT (3B2); POLO (86C, 80); POLO Coupe (86C, 80); POLO Box (86CF); POLO (6N1); POLO CLASSIC (6KV2); POLO Variant (6KV5); SHARAN (7M8, 7M9, 7M6); VENTO (1H2); TRANSPORTER IV Bus (70XB, 70XC, 7DB, 7DW); TRANSPORTER IV Box (70XA); TRANSPORTER IV Platform/Chassis (70XD)

**246-083-002-022G****Screen Washer Pump, Dual - Centrifugal Pump (SWP-D-C)****AUDI**

A1 (8X1); A3 (8L1); A3 (8P1); A3 Sportback (8PA); A4 (8D2, B5); A4 Avant (8D5, B5); A4 (8E2, B6); A4 Avant (8E5, B6); A4 (8EC, B7); A4 Avant (8ED, B7); A4 Avant (8K5, B8); A4 Allroad (8KH, B8); A6 (4B, C5); A6 Avant (4B, C5); ALLROAD (4BH, C5); A6 (4F2, C6); A6 Avant (4F5, C6); A6 Allroad (4FH, C6); Q5 (8R); Q7 (4L)

**BMW**

3 Compact (E36); 3 Touring (E36); Z3 Coupe (E36)

**MERCEDES-BENZ**

B-CLASS (W245); C CLASS (W204); C CLASS T-Model (S204); E-CLASS T-Model (S212)

**SEAT**

ALHAMBRA (7V8, 7V9); ALTEA (5P1); ALTEA XL (5P5, 5P8); AROSA (6H); CORDOBA Vario (6K5); CORDOBA (6K2); CORDOBA Vario (6K5); CORDOBA (6L2); IBIZA II (6K1); IBIZA III (6K1); IBIZA IV (6L1); IBIZA V (6J5); IBIZA V SPORTCOUPE (6J1); IBIZA V ST (6J8); INCA (6K9); LEON (1M1); LEON (1P1); TOLEDO II (1M2); TOLEDO III (5P2)

**SKODA**

FABIA (6Y2); FABIA Combi (6Y5); FABIA Praktik; FABIA; FABIA Combi; OCTAVIA (1U2); OCTAVIA Combi (1U5); OCTAVIA (1Z3); OCTAVIA Combi (1Z5); ROOMSTER (5J); YETI (5L)

**SMART**

CABRIO (450); CITY-COUPE (450); FORTWO Coupe (451)

**VW**

BORA (1J2); BORA Estate (1J6); CADDY II Estate (9K9B); CADDY II Box (9K9A); CADDY III Estate (2KB, 2KJ, 2CB, 2CJ); CADDY III Box (2KA, 2KH, 2CA, 2CH); FOX (5Z1, 5Z3); GOLF II (19E, 1G1); GOLF III (1H1); GOLF III Variant (1H5); GOLF IV (1J1); GOLF IV Variant (1J5); GOLF V (1K1); GOLF V Variant (1K5); GOLF VI (5K1); GOLF VI Variant (AJ5); GOLF PLUS (5M1, 521); JETTA II (19E, 1G2, 165); LUPO (6X1, 6E1); PASSAT (3A2, 35I); PASSAT Variant (3A5, 35I); PASSAT (3B2); PASSAT Variant (3B5); PASSAT (3B3); PASSAT Variant (3B6); PASSAT (3C2); PASSAT Variant (3C5); POLO Box (86CF); POLO (6N1); POLO Box (6NF); POLO CLASSIC (6KV2); POLO Variant (6KV5); POLO (6N2); POLO (9N\_); POLO Saloon (9A4); SHARAN (7M8, 7M9, 7M6); SHARAN (7N); TIGUAN (5N\_); TOUAREG (7LA, 7L6, 7L7); TOUAREG (7P5); TOURAN (1T1, 1T2); TOURAN (1T3); TRANSPORTER IV Bus (70XB, 70XC, 7DB, 7DW); TRANSPORTER IV Box (70XA); TRANSPORTER V Bus (7HB, 7HJ, 7EB, 7EJ, 7EF); TRANSPORTER V Box (7HA, 7HH, 7EA, 7EH); TRANSPORTER V Platform/Chassis (7JD, 7JE, 7JL, 7JY, 7JZ, 7FD)



**246-086-001-002C**

**Headlight Washer Pump (HLWP)**

- Operating Voltage (T1): 12
- Plug Number (T2): 3
- Pump Type (T20): Mono Pump (T21)

**AUDI**

A3 (8L1); A4 (8D2, B5); A4 Avant (8D5, B5); A6 (4A, C4); A6 Avant (4A, C4); A6 (4B, C5); A6 Avant (4B, C5); A8 (4D2, 4D8); TT (8N3); TT Roadster (8N9); 80 (89, 89Q, 8A, B3); COUPE (89, 8B); CABRIOLET (8G7, B4); 80 (8C, B4); 80 Avant (8C, B4); 100 (4A, C4); 100 Avant (4A, C4)

**MITSUBISHI**

SPACE STAR (DG\_A)

**PORSCHE**

911 (964); 911 Convertible (964); 911 (996); 911 Convertible (996); 911 Targa (996); 924; 928; 944; 944 Convertible; 959; BOXSTER (986)

**SEAT**

ALHAMBRA (7V8, 7V9); CORDOBA (6K1, 6K2); CORDOBA (6K2); IBIZA II (6K1); IBIZA III (6K1); INCA (6K9); LEON (1M1); TOLEDO II (1M2)

**SKODA**

FABIA (6Y2); OCTAVIA (1U2); OCTAVIA Combi (1U5)

**VW**

BORA (1J2); BORA Estate (1J6); CADDY I (14); GOLF III (1H1); GOLF III Variant (1H5); GOLF III Cabriolet (1E7); GOLF IV (1J1); GOLF IV Variant (1J5); GOLF IV Cabriolet (1E7); NEW BEETLE (9C1, 1C1); PASSAT (3A2, 35I); PASSAT Variant (3A5, 35I); PASSAT (3B2); PASSAT Variant (3B5); POLO (86C, 80); POLO Coupe (86C, 80); POLO Box (86CF); POLO (6N1); POLO Box (6NF); POLO CLASSIC (6KV2); POLO Variant (6KV5); POLO (6N2); SHARAN (7M8, 7M9, 7M6); LT 28-46 II Box (2DX0AE); LT 28-46 II Platform/Chassis (2DX0FE); TRANSPORTER IV Bus (70XB, 70XC, 7DB, 7DW); TRANSPORTER IV Box (70XA); TRANSPORTER IV Platform/Chassis (70XD)



**246-086-001-007C****Headlight Washer Pump (HLWP)**

- Operating Voltage (T1): 12
- Plug Number (T2): 3b
- Pump Type (T20): Mono Pump (T21)

**AUDI**

A2 (8Z0); A3 (8L1); A3 (8P1); A3 Sportback (8PA); A3 Convertible (8P7); A4 (8D2, B5); A4 Avant (8D5, B5); A4 (8E2, B6); A4 Avant (8E5, B6); A4 Convertible (8H7, B6, 8HE, B7); A6 (4B, C5); A6 Avant (4B, C5); ALLROAD (4BH, C5); A6 Avant (4F5, C6); A6 Allroad (4FH, C6); A8 (4D2, 4D8); A8 (4H\_); Q5 (8R); Q7 (4L); TT (8N3); TT Roadster (8N9); TT (8J3); TT Roadster (8J9); 80 (81, 85, B2); COUPE (81, 85); QUATTRO (85); 80 (89, 89Q, 8A, B3); COUPE (89, 8B); 80 (8C, B4); 90 (81, 85, B2); 90 (89, 89Q, 8A, B3); 100 (43, C2); 100 Avant (43, C2); 100 (44, 44Q, C3); 100 Avant (44, 44Q, C3); 100 (4A, C4); 100 Avant (4A, C4); 200 (43); 200 (44, 44Q); 200 Avant (44, 44Q)

**BMW**

1 (E81, E87); 1 Coupe (E82); 1 Convertible (E88); 3 (E36); 3 Compact (E36); 3 Coupe (E36); 3 Convertible (E36); 3 Touring (E36); 3 (E46); 3 Compact (E46); 3 Coupe (E46); 3 Convertible (E46); 3 Touring (E46); 3 (E90); 3 Touring (E91); 3 Coupe (E92); 3 Convertible (E93); 5 (E39); 5 Touring (E39); 5 (E60); 5 Touring (E61); 6 (E63); 6 Convertible (E64); 7 (E38); 7 (E65, E66); X1 (E84); X3 (E83); X5 (E53); X5 (E70); X6 (E71, E72); Z4 (E85); Z4 Coupe (E86)

**PORSCHE**

911 (997); 911 Convertible (997); 911 Targa (997); BOXSTER (987); CARRERA GT; CAYMAN (987); PANAMERA

**SEAT**

ALHAMBRA (7V8, 7V9); ALHAMBRA (710); ALTEA (5P1); ALTEA XL (5P5, 5P8); CORDOBA (6K1, 6K2); CORDOBA Vario (6K5); CORDOBA (6K2); CORDOBA Vario (6K5); CORDOBA (6L2); EXEO (3R2); EXEO ST (3R5); IBIZA II (6K1); IBIZA III (6K1); IBIZA IV (6L1); IBIZA V (6J5); IBIZA V SPORTCOUPE (6J1); IBIZA V ST (6J8); INCA (6K9); LEON (1M1); LEON (1P1); TOLEDO II (1M2); TOLEDO III (5P2)

**SKODA**

FABIA Saloon (6Y3); FABIA Combi (6Y5); FABIA Praktik; FABIA Combi; OCTAVIA (1U2); OCTAVIA Combi (1U5); OCTAVIA (1Z3); OCTAVIA Combi (1Z5); ROOMSTER (5J); SUPERB (3U4); SUPERB (3T4); SUPERB Estate (3T5); YETI (5L)

**VW**

BORA (1J2); CADDY I (14); CADDY II Estate (9K9B); CADDY II Box (9K9A); CADDY II Pickup (9U7); CADDY III Estate (2KB, 2KJ, 2CB, 2CJ); CADDY III Box (2KA, 2KH, 2CA, 2CH); CORRADO (53I); DERBY (86); DERBY (86C, 80); EOS (1F7, 1F8); GOLF I (17); GOLF I Cabriolet (155); GOLF II (19E, 1G1); GOLF III (1H1); GOLF III Variant (1H5); GOLF III Cabriolet (1E7); GOLF IV (1J1); GOLF IV Variant (1J5); GOLF IV Cabriolet (1E7); GOLF V (1K1); GOLF V Variant (1K5); GOLF VI (5K1); GOLF VI Variant (AJ5); GOLF PLUS (5M1, 521); JETTA I (16); JETTA II (19E, 1G2, 165); JETTA III (1K2); LUPO (6X1, 6E1); NEW BEETLE (9C1, 1C1); NEW BEETLE Convertible (1Y7); PASSAT (32B); PASSAT Saloon (32B); PASSAT Variant (32B); PASSAT (3A2, 35I); PASSAT Variant (3A5, 35I); PASSAT (3B2); PASSAT (3B3); PASSAT (3C2); PASSAT Variant (3C5); POLO (86); POLO (86C, 80); POLO CLASSIC (86C, 80); POLO Coupe (86C, 80); POLO (6N1); POLO CLASSIC (6KV2); POLO (9N\_); POLO Saloon (9A4); SANTANA (32B); SCIROCCO (53B); SHARAN (7M8, 7M9, 7M6); SHARAN (7N); TIGUAN (5N\_); TOUAREG (7LA, 7L6, 7L7); TOUAREG (7P5); TOURAN (1T1, 1T2); VENTO (1H2); LT 28-35 I Bus (281-363); LT 28-35 I Box (281-363); LT 28-35 I Platform/Chassis (281-363); LT 28-35 II Bus (2DM); LT 28-46 II Box (2DX0AE); LT 28-46 II Platform/Chassis (2DX0FE); TRANSPORTER II Bus; TRANSPORTER II Box; TRANSPORTER II Platform/Chassis; TRANSPORTER III Bus; TRANSPORTER III Platform/Chassis; TRANSPORTER IV Bus (70XB, 70XC, 7DB, 7DW); TRANSPORTER IV Box (70XA); TRANSPORTER IV Platform/Chassis (70XD); TRANSPORTER V Bus (7HB, 7HJ, 7EB, 7EJ, 7EF); TRANSPORTER V Box (7HA, 7HH, 7EA, 7EH); TRANSPORTER V Platform/Chassis (7JD, 7JE, 7JL, 7JY, 7JZ, 7FD)



**395-060-017-001C**  
**Fluid-level Switch (FLS)**  
— Operating Voltage (T1): 12



**395-060-017-002C**  
**Fluid-level Switch (FLS)**  
— Operating Voltage (T1): 24



**395-060-025-001C**  
**Fluid-level Switch (FLS)**  
— Operating Voltage (T1): 12; 24



**88-205-001**  
**Connector (C)**  
— Shape (T6): T-Piece (T7)



**88-243-005**  
**Connector (C)**  
— Shape (T6): I Form (T8)



**88-326-004**  
**Connector (C)**  
— Shape (T6): T-Piece (T7)



**89-602-050**  
**Gasket (G)**  
— Equipment (T11): with filter (T12)



**A2C53030219**  
**Screen Washer Pump, Mono - Centrifugal Pump (SWP-M-C)**  
— Pump Type (T20): Mono Pump (T21)

**CITROËN**  
C5 (RD\_); C5 Break (TD\_); C6 (TD\_)

**PEUGEOT**  
407 (6D\_); 407 SW (6E\_); 407 Coupe (6C\_)



**A2C53030301**

**Screen Washer Pump, Dual - Centrifugal Pump (SWP-D-C)**

— Pump Type (T20): Dual Pump (T22)

**CITROËN**

C3 (FC\_); C3 II; C4 (LC\_); C4 Picasso (UD\_); C4 Grand Picasso (UA\_); C5 (DC\_); C5 (RC\_); C8 (EA\_, EB\_); JUMPY; XSARA PICASSO (N68)

**FIAT**

SCUDO (270\_); SCUDO Box (270\_); SCUDO Platform/Chassis (270\_); ULYSSE (179AX)

**LANCIA**

PHEDRA (179)

**PEUGEOT**

307 (3A/C); 307 Break (3E); 307 SW (3H); 308 (4A\_, 4C\_); 308 SW; 407 SW (6E\_); 807 (E); EXPERT (224); EXPERT Box (222)



**A2C53240114**

**Screen Washer Pump, Mono - Centrifugal Pump (SWP-M-C)**

— Operating Voltage (T1): 12

— Operating Model (T4): Electric (T5)

**CHEVROLET**

AVEO Saloon (T300); CRUZE (J300); CRUZE Hatchback (J305); MALIBU (V300); ORLANDO (J309); VOLT

**OPEL**

AMPERA; ASTRA J Saloon; INSIGNIA; INSIGNIA Saloon

**VAUXHALL**

AMPERA; ASTRA Mk VI (J) Saloon; INSIGNIA; INSIGNIA Saloon



**A2C53240479Z**

**Screen Washer Pump, Mono - Centrifugal Pump (SWP-M-C)**

— Operating Voltage (T1): 12

— Operating Model (T4): Electric (T5)

— Pump Type (T20): Mono Pump (T21)

**BMW**

1 (E81, E87); 1 Coupe (E82); 1 Convertible (E88); 3 (E90); 3 Touring (E91); 3 Coupe (E92); 3 Convertible (E93); 3 (F30); 3 Touring (F31); 5 (E60); 5 Touring (E61); 5 GRAN TURISMO (F07); 5 (F10); 5 Touring (F11); 6 (E63); 6 Convertible (E64); 6 Convertible (F12); 6 Coupe / Gran Coupe (F13, F06); 7 (E65, E66); 7 (F01, F02, F03, F04); X1 (E84); X3 (F25); X5 (E70); X6 (E71, E72); Z4 (E89)



**A2C53304876**

**Headlight Washer Pump (HLWP)**

— Operating Voltage (T1): 12

— Operating Model (T4): Electric (T5)

**AUDI**

A4 Allroad (8KH, B8); A5 Convertible (8F7)

**BMW**

1 (F20, F21); 3 (F30); 3 Touring (F31); 5 GRAN TURISMO (F07); 5 (F10); 5 Touring (F11); 6 Convertible (F12); 6 Coupe / Gran Coupe (F13, F06); 7 (F01, F02, F03, F04); X3 (F25); X5 (E70); X6 (E71, E72); Z4 (E89)



**X10-729-002-004**

**Screen Washer Pump, Mono - Centrifugal Pump (SWP-M-C)**

- Operating Voltage (T1): 12
- Plug Number (T2): 9
- Pump Type (T20): Dual Pump (T22)

**FORD**

COUGAR (EC\_); ESCORT IV (GAF, AWF, ABFT); ESCORT V (GAL); ESCORT V Estate (GAL, AVL); ESCORT V Convertible (ALL); ESCORT VI (GAL); ESCORT VI Estate (GAL); ESCORT VII (GAL, AAL, ABL); ESCORT VII Estate (GAL, ANL); ESCORT VII Convertible (ALL); FIESTA III (GFJ); FIESTA IV (JA\_, JB\_); FOCUS (DAW, DBW); FOCUS Saloon (DFW); FOCUS Estate (DNW); KA (RB\_); MONDEO I (GBP); MONDEO I Estate (BNP); MONDEO II (BAP); MONDEO II Estate (BNP); PUMA (EC\_); SCORPIO I Estate (GGE); TRANSIT Box (FA\_); TRANSIT Platform/Chassis (FM\_ , FN\_ )

**MAZDA**

121 III (JASM, JBSM)



**X10-729-002-005**

**Screen Washer Pump, Mono - Centrifugal Pump (SWP-M-C)**

- Operating Voltage (T1): 12
- Plug Number (T2): 9
- Pump Type (T20): Mono Pump (T21)

**FORD**

ESCORT IV (GAF, AWF, ABFT); ESCORT IV Estate (AWF, AVF); ESCORT IV Convertible (ALF); ESCORT V (GAL); FIESTA I (GFBT); FIESTA II (FBD); FIESTA III (GFJ); FIESTA Box (F3L, F5L); MONDEO II (BAP); MONDEO II Saloon (BFP); MONDEO II Estate (BNP); ORION II (AFF); ORION III (GAL); SCORPIO I (GAE, GGE); SCORPIO I Saloon (GGE); SCORPIO II (GFR, GGR); SCORPIO II Estate (GNR, GGR); SIERRA (GBG, GB4); SIERRA Estate (BNG); STREET KA; TRANSIT Bus (FD\_ , FB\_ , FS\_ , FZ\_ , FC\_ ); TRANSIT Box (FA\_ ); TRANSIT Platform/Chassis (FM\_ , FN\_ )



**X10-729-002-006**

**Screen Washer Pump, Mono - Centrifugal Pump (SWP-M-C)**

- Operating Voltage (T1): 12
- Plug Number (T2): 10
- Pump Type (T20): Mono Pump (T21)

**RENAULT**

CLIO I (B/C57\_ , 5/357\_); ESPACE II (J/S63\_); KANGOO Express (FC0/1\_); MEGANE I Classic (LA0/1\_); MEGANE I Cabriolet (EA0/1\_); RAPID Box (F40\_ , G40\_); SAFRANE I (B54\_); SAFRANE II (B54\_); SPORT SPIDER (EF0\_); 19 I (B/C53\_); 19 I Chamade (L53\_); 21 (B48\_); 21 Saloon (L48\_); 21 Estate (K48\_); TRAFIC Platform/Chassis (PXX)



**X10-729-002-007**

**Screen Washer Pump, Mono - Centrifugal Pump (SWP-M-C)**

- Operating Voltage (T1): 12
- Plug Number (T2): 11
- Pump Type (T20): Mono Pump (T21)

**CITROËN**

AX (ZA\_); BERLINGO Box (M\_); JUMPY (U6U); JUMPY Box (BS\_ , BT\_ , BY\_ , BZ\_); JUMPY Platform/Chassis (BU\_ , BV\_ , BW\_ , BX\_); XANTIA (X1); XANTIA Break (X1); XANTIA (X2); XANTIA Break (X2); XM (Y3); XM Break (Y3); XM (Y4); XM Break (Y4); ZX (N2)

**PEUGEOT**

106 I (1A, 1C); 206 CC (2D); 306 Hatchback (7A, 7C, N3, N5); 306 (7B, N3, N5); 306 Convertible (7D, N3, N5); 406 (8B); 406 Break (8E/F); 406 Coupe (8C); 605 (6B); EXPERT (224); EXPERT Box (222); PARTNER Box (5)



**X10-729-002-008**

**Screen Washer Pump, Mono - Centrifugal Pump (SWP-M-C)**

- Operating Voltage (T1): 12
- Plug Number (T2): 12
- Pump Type (T20): Mono Pump (T21)

**FORD**

ESCORT III (GAA); ESCORT III Convertible (ALD); FIESTA I (GFBT); FIESTA II (FBD);  
SCORPIO I (GAE, GGE); SIERRA Hatchback (GBC); SIERRA Hatchback (GBC, GBG);  
TRANSIT Platform/Chassis (V\_ \_); TRANSIT Bus (V\_ \_); TRANSIT Box (V\_ \_); TRANSIT Bus (T\_ \_);  
TRANSIT Box (T\_ \_); TRANSIT Platform/Chassis (T\_ \_); TRANSIT Bus (E\_ \_); TRANSIT Box (E\_ \_);  
TRANSIT Platform/Chassis (E\_ \_); TRANSIT Bus (E\_ \_); TRANSIT Box (E\_ \_);  
TRANSIT Platform/Chassis (E\_ \_)



**X11-246-000-001**

**Valve (V)**

- Shape (T6): I Form (T8)
- Valve Type (T9): Non-return Valve (T10)



**X11-246-003-013**

**Adapter (A)**

- Operating Model (T4): Electric (T5)



**X11-246-003-014**

**Adapter (A)**

- Operating Model (T4): Electric (T5)

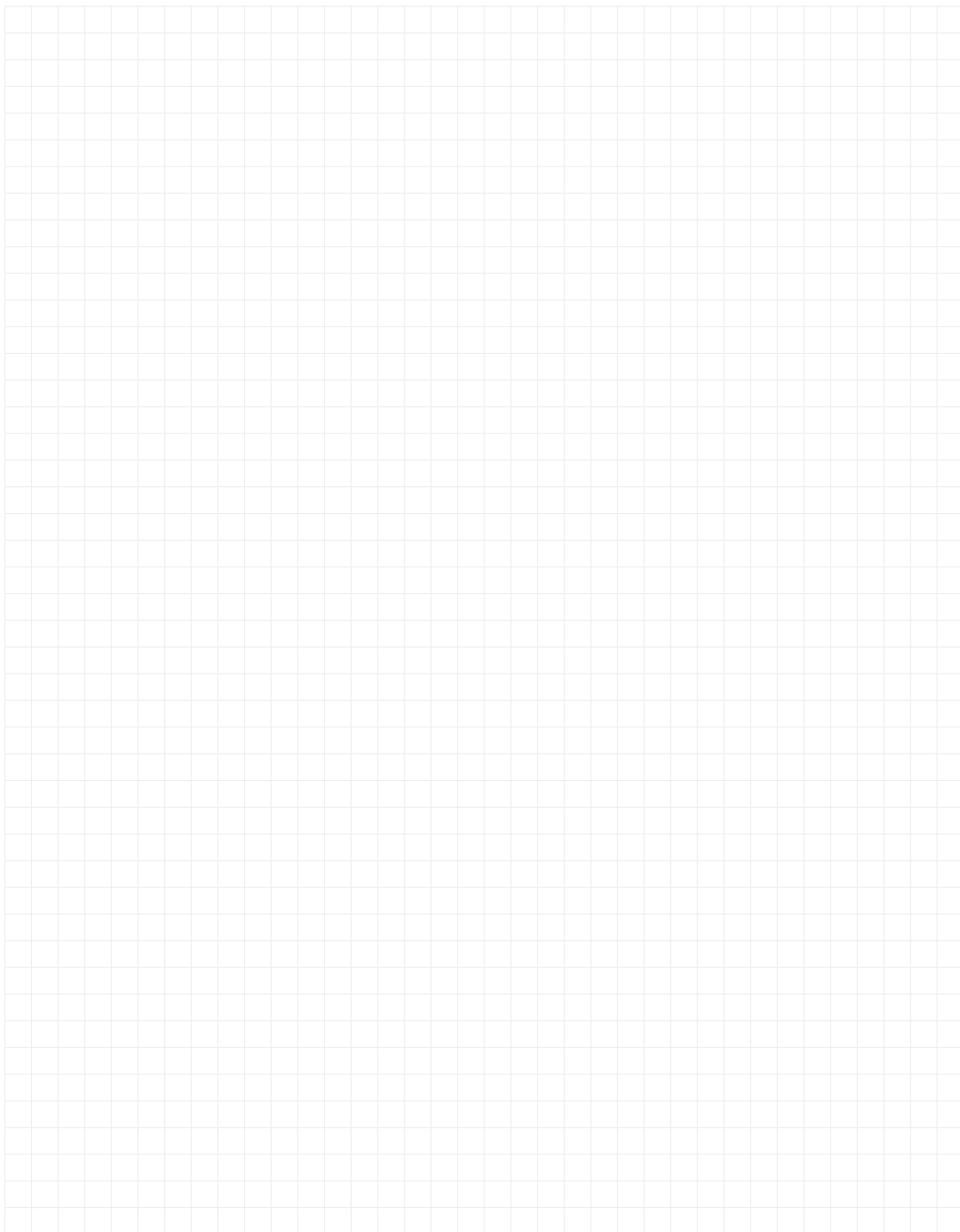



			<b>VDO</b>	
Date	Engine Code	Chassis No.	Article No.	Product Information

**MAN****F 2000**

<b>19.233 FCNG (170 kW   Platform / Chassis   4x2   19 t)</b>				
-	NG		246-083-001-006C	SWP-D-C Plug Number (T2): 1
<b>19.273 F, FL, FLL (198 kW   Platform / Chassis   4x2   19 t)</b>				
01.94 -	N63 M10 A		246-083-001-006C	SWP-D-C Plug Number (T2): 1
<b>19.273 FK (198 kW   Dump Truck   4x2   19 t)</b>				
01.94 -	AAH		246-083-001-006C	SWP-D-C Plug Number (T2): 1
<b>19.273 FS,19.273 FLS (198 kW   Truck Tractor   4x2   19 t)</b>				
01.94 - 12.95	ABC		246-083-001-006C	SWP-D-C Plug Number (T2): 1
<b>19.293 FC,19.293 FLC,19.293 FLLC (213 kW   Platform / Chassis   4x2   19 t)</b>				
01.94 -	AAH		246-083-001-006C	SWP-D-C Plug Number (T2): 1
<b>19.293 FK,19.293 FLK (213 kW   Dump Truck   4x2   19 t)</b>				
01.94 -	AAR		246-083-001-006C	SWP-D-C Plug Number (T2): 1
<b>19.293 FS,19.293 FLS,19.293 FLLS (213 kW   Truck Tractor   4x2   19 t)</b>				
01.94 -	AAN		246-083-001-006C	SWP-D-C Plug Number (T2): 1
<b>19.314 FC, FLC, FLLC, FLLW, FRC, FLRC, FLLRC, FLL, FLLR, F-N (228 kW   Platform / Chassis   4x2   19 t)</b>				
06.98 -	W		246-083-001-006C	SWP-D-C Plug Number (T2): 1
<b>19.314 FK, FLK, F-KI, FL-KI (228 kW   Dump Truck   4x2   19 t)</b>				
06.98 -	AN		246-083-001-006C	SWP-D-C Plug Number (T2): 1
<b>19.314 FS, FLS, FLLS, FRS, FLRS, FLLRS (228 kW   Truck Tractor   4x2   19 t)</b>				
06.98 -	AT		246-083-001-006C	SWP-D-C Plug Number (T2): 1
<b>19.323 FC,19.323 FLC,19.323 FLLC (235 kW   Platform / Chassis   4x2   19 t)</b>				
01.94 - 12.95	AAZ		246-083-001-006C	SWP-D-C Plug Number (T2): 1
<b>19.323 FK,19.323 FLK (235 kW   Dump Truck   4x2   19 t)</b>				
01.94 - 12.95	ABT		246-083-001-006C	SWP-D-C Plug Number (T2): 1
<b>19.323 FS,19.323 FLS,19.323 FLLS (235 kW   Truck Tractor   4x2   19 t)</b>				
01.94 - 12.95	ABM		246-083-001-006C	SWP-D-C Plug Number (T2): 1
<b>19.343 FC,19.343 FLC,19.343 FLLC (250 kW   Platform / Chassis   4x2   19 t)</b>				
01.94 -	ACE		246-083-001-006C	SWP-D-C Plug Number (T2): 1
<b>19.343 FK,19.343 FLK (250 kW   Dump Truck   4x2   19 t)</b>				
01.94 -	LPA, LP1		246-083-001-006C	SWP-D-C Plug Number (T2): 1
<b>19.343 FS,19.343 FLS,19.343 FLLS (250 kW   Truck Tractor   4x2   19 t)</b>				
01.94 -	ABC		246-083-001-006C	SWP-D-C Plug Number (T2): 1
<b>19.364 FC, FLC, FLLC, FLLW, FRC, FLRC, FLLRC, FLL, FLLR, F-N (265 kW   Platform / Chassis   4x2   19 t)</b>				
06.98 -	B 16 A		246-083-001-006C	SWP-D-C Plug Number (T2): 1
<b>19.364 FK, FLK, F-KI, FL-KI (265 kW   Dump Truck   4x2   19 t)</b>				
06.98 -	B 18		246-083-001-006C	SWP-D-C Plug Number (T2): 1
<b>19.364 FS, FLS, FLLS, FRS, FLRS, FLLRS (265 kW   Truck Tractor   4x2   19 t)</b>				
06.98 -	B 18 A		246-083-001-006C	SWP-D-C Plug Number (T2): 1
<b>19.373 FC, FLC, FLLC, FRC, FLRC, F-NL (272 kW   Platform / Chassis   4x2   19 t)</b>				
01.94 -	ACE		246-083-001-006C	SWP-D-C Plug Number (T2): 1
<b>19.373 FK, FLK, F-KI, FL-KI (272 kW   Dump Truck   4x2   19 t)</b>				
01.94 -	N63 M10 A		246-083-001-006C	SWP-D-C Plug Number (T2): 1
<b>19.373 FS, FLS, FLLS, FRS, FLRS, FLLRS (272 kW   Truck Tractor   4x2   19 t)</b>				
01.94 -	LNA		246-083-001-006C	SWP-D-C Plug Number (T2): 1
<b>19.403 FC, FLC, FLLC, FRC, FLRC, F-NL (294 kW   Platform / Chassis   4x2   19 t)</b>				
01.94 -	CN		246-083-001-006C	SWP-D-C Plug Number (T2): 1
<b>19.403 FK, FLK, F-KI, FL-KI (294 kW   Dump Truck   4x2   19 t)</b>				
01.94 -	AAR		246-083-001-006C	SWP-D-C Plug Number (T2): 1
<b>19.403 FS, FLS, FLLS, FRS, FLRS, FLLRS (294 kW   Truck Tractor   4x2   19 t)</b>				
01.94 -	NC		246-083-001-006C	SWP-D-C Plug Number (T2): 1
<b>19.414 FC, FLC, FLLC, FRC, FLRC, FLLRC, FLL, FLLR, F-NL (301 kW   Platform / Chassis   4x2   19 t)</b>				
06.98 -	B 18		246-083-001-006C	SWP-D-C Plug Number (T2): 1
<b>19.414 FK, FLK, F-KI, FL-KI (301 kW   Dump Truck   4x2   19 t)</b>				
06.98 -	B 11		246-083-001-006C	SWP-D-C Plug Number (T2): 1
<b>19.414 FS, FLS, FLLS, FRS, FLRS, FLLRS (301 kW   Truck Tractor   4x2   19 t)</b>				
06.98 -	B 18		246-083-001-006C	SWP-D-C Plug Number (T2): 1
<b>19.423 FC, FLC, FLLC, F-NL (309 kW   Platform / Chassis   4x2   19 t)</b>				
01.94 -	AAE		246-083-001-006C	SWP-D-C Plug Number (T2): 1
<b>19.423 FK, FLK, F-KI, FL-KI (309 kW   Dump Truck   4x2   19 t)</b>				
01.94 -	AAR		246-083-001-006C	SWP-D-C Plug Number (T2): 1
<b>19.423 FS, FLS, FLLS (309 kW   Truck Tractor   4x2   19 t)</b>				
01.94 -	AAN		246-083-001-006C	SWP-D-C Plug Number (T2): 1





			<b>VDO</b>		
Date	Engine Code	Chassis No.	Article No.	Product	Information

**MAN****F 2000****19.463 FC, FLC, FLLC, FRC, FLRC, F-NL (338 kW | Platform / Chassis | 4x2 | 19 t)**

01.94 → AAH 246-083-001-006C SWP-D-C Plug Number (T2): 1

**19.463 FK, FLK, F-KI, FL-KI (338 kW | Dump Truck | 4x2 | 19 t)**

01.94 → AAH 246-083-001-006C SWP-D-C Plug Number (T2): 1

**19.463 FS, FLS, FLLS, FRS, FLRS, FLLRS (338 kW | Truck Tractor | 4x2 | 19 t)**

01.94 → ABC 246-083-001-006C SWP-D-C Plug Number (T2): 1

**19.464 FC, FLC, FLLC, FLL, FRC, FLLR, FLLRC, FLLW, F-NL (338 kW | Platform / Chassis | 4x2 | 19 t)**

06.98 → B 130 246-083-001-006C SWP-D-C Plug Number (T2): 1

**19.464 FK, FLK, F-KI, FL-KI (338 kW | Dump Truck | 4x2 | 19 t)**

06.98 → B 20 E 246-083-001-006C SWP-D-C Plug Number (T2): 1

**19.464 FS, FLS, FLLS, FRS, FLRS, FLLRS (338 kW | Truck Tractor | 4x2 | 19 t)**

06.98 → 246-083-001-006C SWP-D-C Plug Number (T2): 1

**19.603 FLS, 19604 FLS (441 kW | Truck Tractor | 4x2 | 19 t)**

04.96 → KX 246-083-001-006C SWP-D-C Plug Number (T2): 1

**M 2000 L****12.163 LC, LLC, LRC, LLRC (114 kW | Platform / Chassis | 4x2 | 12 t)**

08.95 → 11 SR 246-075-010-001C SWP-M-G Plug Number (T2): 1

**12.163 LK, LRK (114 kW | Dump Truck | 4x2 | 12 t)**

08.95 → 19 S 246-075-010-001C SWP-M-G Plug Number (T2): 1

**12.224 LC, LLC, LRC, LLRC (162 kW | Platform / Chassis | 4x2 | 12 t)**

08.95 → 12 S 246-075-010-001C SWP-M-G Plug Number (T2): 1

**12.224, 12.225, LK, LRK (162 kW | Dump Truck | 4x2 | 12 t)**

08.95 → 16 N 246-075-010-001C SWP-M-G Plug Number (T2): 1

**L 2000****10.150 FOC (114 kW → 118 kW | Bus | 4x2 | 10 t)**

02.95 → 01.96 4RB 246-083-001-006C SWP-D-C Plug Number (T2): 1

**8.103 LC, 8.103 LLC (75 kW | Platform / Chassis | 4x2 | 8 t)**

10.93 → 06.96 M 103.987 246-083-001-006C SWP-D-C Plug Number (T2): 1

**8.103 LK (75 kW | Dump Truck | 4x2 | 8 t)**

10.93 → 06.96 ARD 246-083-001-006C SWP-D-C Plug Number (T2): 1

**8.113 LC, 8.113 LLC (81 kW | Platform / Chassis | 4x2 | 8 t)**

08.95 → 20 SEH 246-083-001-006C SWP-D-C Plug Number (T2): 1

**8.113 LC, 8.113 LLC, LRC, LLRC, (LE110C) (83 kW | Platform / Chassis | 4x2 | 7.4 t)**

09.00 → 246-083-001-006C SWP-D-C Plug Number (T2): 1

**8.113 LK, LRK, L-KI, LR-KI (81 kW | Dump Truck | 4x2 | 8 t)**

08.95 → BRE 246-083-001-006C SWP-D-C Plug Number (T2): 1

**8.145 LC, 8.145 LLC, L-LF (LE140C) (103 kW | Platform / Chassis | 4x2 | 7.4 t)**

09.00 → 246-083-001-006C SWP-D-C Plug Number (T2): 1

**8.145 LRK, L-KI, LR-KILK (LE140C) (103 kW | Dump Truck | 4x2 | 7.4 t)**

09.00 → 6J1 246-083-001-006C SWP-D-C Plug Number (T2): 1

**8.150 FOC, 8.150 FOCL (114 kW → 118 kW | Bus | 4x2 | 8 t)**

02.95 → 16 D, 16 DA 246-083-001-006C SWP-D-C Plug Number (T2): 1

**8.153 LC, 8.153 LLC (114 kW | Platform / Chassis | 4x2 | 8 t)**

10.93 → 07.97 M 111.920, M 111.921 246-083-001-006C SWP-D-C Plug Number (T2): 1

**8.153 LK (114 kW | Dump Truck | 4x2 | 8 t)**

10.93 → 07.97 M 127.984 246-083-001-006C SWP-D-C Plug Number (T2): 1

**8.153 LLS (114 kW | Truck Tractor | 4x2 | 8 t)**

10.93 → 06.96 M 111.961 246-083-001-006C SWP-D-C Plug Number (T2): 1

**8.163 LC, 8.163 LLC (LE160C) (114 kW | Platform / Chassis | 4x2 | 7.4 t)**

09.00 → 246-083-001-006C SWP-D-C Plug Number (T2): 1

**8.163 LC, 8.163 LLC (114 kW → 118 kW | Platform / Chassis | 4x2 | 8 t)**

05.94 → M 130.980, M 130.984 246-083-001-006C SWP-D-C Plug Number (T2): 1

**8.163 LC, 8.163 LLC, LRC, LLRC, L-LF (104 kW | Platform / Chassis | 4x2 | 8 t)**

08.95 → M 129.980, M 129.981 246-083-001-006C SWP-D-C Plug Number (T2): 1

**8.163 LK, LRK, L-KI, LR-KI (114 kW → 118 kW | Dump Truck | 4x2 | 8 t)**

05.94 → M 110.982, M 110.986, M 110.990 246-083-001-006C SWP-D-C Plug Number (T2): 1

**8.163 LLS, LLRS (114 kW → 118 kW | Truck Tractor | 4x2 | 8 t)**

05.94 → TV 17 H 246-083-001-006C SWP-D-C Plug Number (T2): 1

**8.185 LC, 8.185 LLC, LRC, LLRC, L-LF (LE180C) (132 kW | Platform / Chassis | 4x2 | 7.4 t)**

09.00 → 246-083-001-006C SWP-D-C Plug Number (T2): 1



			<b>VDO</b>		
Date	Engine Code	Chassis No.	Article No.	Product	Information

**MAN****L 2000**

<b>8.220 FOC,8.220 FOCL (162 kW   Bus   4x2   8 t)</b>					
04.95 -	A 13 DTE		246-083-001-006C	SWP-D-C	Plug Number (T2): 1
<b>8.223 LC,8.223 LLC (162 kW -&gt; 169 kW   Platform / Chassis   4x2   8 t)</b>					
10.93 - 06.96	LCN		246-083-001-006C	SWP-D-C	Plug Number (T2): 1
<b>8.223 LK (162 kW -&gt; 169 kW   Dump Truck   4x2   8 t)</b>					
10.93 - 06.96	NEN, OHC TL 20 H		246-083-001-006C	SWP-D-C	Plug Number (T2): 1
<b>8.223 LLS (162 kW -&gt; 169 kW   Truck Tractor   4x2   8 t)</b>					
10.93 - 06.96	E 18 NVR		246-083-001-006C	SWP-D-C	Plug Number (T2): 1
<b>8.224 LC,8.224 LLC, LRC, LLRC (162 kW   Platform / Chassis   4x2   8 t)</b>					
05.94 -	M 117.960		246-083-001-006C	SWP-D-C	Plug Number (T2): 1
<b>8.224 LK, LRK, L-KI, LR-KI (162 kW   Dump Truck   4x2   8 t)</b>					
05.94 -	E 18 NVR		246-083-001-006C	SWP-D-C	Plug Number (T2): 1
<b>8.224 LLS, LLRS (162 kW   Truck Tractor   4x2   8 t)</b>					
05.94 -	E 18 NVR		246-083-001-006C	SWP-D-C	Plug Number (T2): 1
<b>8.225 LC,8.225 LLC, LRC, LLRC (LE220C) (162 kW   Platform / Chassis   4x2   7.4 t)</b>					
09.00 -			246-083-001-006C	SWP-D-C	Plug Number (T2): 1
<b>9.153 LC,9.153 LLC (114 kW   Platform / Chassis   4x2   9 t)</b>					
10.93 - 06.96	C 20 NEF		246-083-001-006C	SWP-D-C	Plug Number (T2): 1
<b>9.153 LK (114 kW   Dump Truck   4x2   9 t)</b>					
10.93 - 06.96	YYE		246-083-001-006C	SWP-D-C	Plug Number (T2): 1
<b>9.153 LLS (114 kW   Truck Tractor   4x2   9 t)</b>					
10.93 - 12.95	C 20 NEF		246-083-001-006C	SWP-D-C	Plug Number (T2): 1
<b>9.163 LC (104 kW   Platform / Chassis   4x2   9 t)</b>					
08.95 - 03.97	20 NE		246-083-001-006C	SWP-D-C	Plug Number (T2): 1
<b>9.163 LC,9.163 LLC, LRC, LLRC (114 kW -&gt; 118 kW   Platform / Chassis   4x2   9 t)</b>					
05.94 -	YYN		246-083-001-006C	SWP-D-C	Plug Number (T2): 1
<b>9.163 LK (104 kW   Dump Truck   4x2   9 t)</b>					
08.95 - 03.97	PRN		246-083-001-006C	SWP-D-C	Plug Number (T2): 1
<b>9.163 LK, LRK, L-KI, LR-KI (114 kW -&gt; 118 kW   Dump Truck   4x2   9 t)</b>					
05.94 -	20 NE		246-083-001-006C	SWP-D-C	Plug Number (T2): 1
<b>9.163 LLS, LLRS (114 kW -&gt; 118 kW   Truck Tractor   4x2   9 t)</b>					
05.94 -	20 NE		246-083-001-006C	SWP-D-C	Plug Number (T2): 1
<b>9.185 LC,9.185 LLC, LRC, LLRC (LE180C) (132 kW   Platform / Chassis   4x2   8.9 t)</b>					
09.00 -			246-083-001-006C	SWP-D-C	Plug Number (T2): 1
<b>9.223 LC,9.223 LLC (162 kW -&gt; 169 kW   Platform / Chassis   4x2   9 t)</b>					
10.93 - 06.96	HYF		246-083-001-006C	SWP-D-C	Plug Number (T2): 1
<b>9.223 LK (162 kW -&gt; 169 kW   Dump Truck   4x2   9 t)</b>					
10.93 - 06.96	20 SEH		246-083-001-006C	SWP-D-C	Plug Number (T2): 1
<b>9.223 LLS (162 kW -&gt; 169 kW   Truck Tractor   4x2   9 t)</b>					
10.93 - 06.96	20 SEH		246-083-001-006C	SWP-D-C	Plug Number (T2): 1
<b>9.224 LC,9.224 LLC, LRC, LLRC (162 kW   Platform / Chassis   4x2   9 t)</b>					
05.94 -	20 SEH		246-083-001-006C	SWP-D-C	Plug Number (T2): 1
<b>9.224 LK, LRK, L-KI, LR-KI (162 kW   Dump Truck   4x2   9 t)</b>					
05.94 -	17 DT (TC4EE1), X 17 DT (TC4EE1)		246-083-001-006C	SWP-D-C	Plug Number (T2): 1
<b>9.224 LLS, LLRS (162 kW   Truck Tractor   4x2   9 t)</b>					
05.94 -	EY		246-083-001-006C	SWP-D-C	Plug Number (T2): 1

**M 90**

<b>12.152 F,12.152 FL (110 kW -&gt; 114 kW   Platform / Chassis   4x2   12 t)</b>					
12.88 - 05.94	TKB		246-075-010-001C	SWP-M-G	Plug Number (T2): 1
<b>12.152 FK (110 kW -&gt; 114 kW   Dump Truck   4x2   12 t)</b>					
12.88 - 05.94	HC		246-075-010-001C	SWP-M-G	Plug Number (T2): 1
<b>12.152 FS,12.152 FLS (110 kW -&gt; 114 kW   Truck Tractor   4x2   12 t)</b>					
12.88 - 05.94	GLC, GSF		246-075-010-001C	SWP-M-G	Plug Number (T2): 1
<b>12.192 F,12.192 FL (140 kW   Platform / Chassis   4x2   12 t)</b>					
07.90 - 06.96	JPC		246-075-010-001C	SWP-M-G	Plug Number (T2): 1
<b>12.192 FA (140 kW   Platform / Chassis   4x4   12 t)</b>					
10.92 - 06.96	ZA		246-075-010-001C	SWP-M-G	Plug Number (T2): 1
<b>12.192 FAK (140 kW   Dump Truck   4x4   12 t)</b>					
10.92 - 06.96	ZC		246-075-010-001C	SWP-M-G	Plug Number (T2): 1
<b>12.192 FK (140 kW   Dump Truck   4x2   12 t)</b>					
07.90 - 06.96	ZB, YJ		246-075-010-001C	SWP-M-G	Plug Number (T2): 1



			<b>VDO</b>		
Date	Engine Code	Chassis No.	Article No.	Product	Information

**MAN****M 90****12.192 FS,12.192 FLS (140 kW | Truck Tractor | 4x2 | 12 t)**

07.90 → 06.96 | 198 A3.000 | 246-075-010-001C | SWP-M-G | Plug Number (T2): 1

**12.222 F,12.222 FL (162 kW | Platform / Chassis | 4x2 | 12 t)**

05.94 → 06.96 | SF | 246-075-010-001C | SWP-M-G | Plug Number (T2): 1

**12.222 FA (162 kW | Platform / Chassis | 4x4 | 12 t)**

05.94 → 06.96 | LUD | 246-075-010-001C | SWP-M-G | Plug Number (T2): 1

**12.222 FAK (162 kW | Dump Truck | 4x4 | 12 t)**

05.94 → 06.96 | LTB | 246-075-010-001C | SWP-M-G | Plug Number (T2): 1

**12.222 FK (162 kW | Dump Truck | 4x2 | 12 t)**

05.94 → 06.96 | 246-075-010-001C | SWP-M-G | Plug Number (T2): 1

**12.222 FLS (162 kW | Truck Tractor | 4x2 | 12 t)**

05.94 → 06.96 | DS | 246-075-010-001C | SWP-M-G | Plug Number (T2): 1

**12.232 F,12.232 FL (169 kW | Platform / Chassis | 4x2 | 12 t)**

08.88 → 06.96 | J6B | 246-075-010-001C | SWP-M-G | Plug Number (T2): 1

**12.232 FA (169 kW | Platform / Chassis | 4x4 | 12 t)**

05.90 → 06.96 | J6A, J4B | 246-075-010-001C | SWP-M-G | Plug Number (T2): 1

**12.232 FAK (169 kW | Dump Truck | 4x4 | 12 t)**

05.90 → 06.96 | LJF | 246-075-010-001C | SWP-M-G | Plug Number (T2): 1

**12.232 FK (169 kW | Dump Truck | 4x2 | 12 t)**

08.88 → 06.96 | F6F, F6G | 246-075-010-001C | SWP-M-G | Plug Number (T2): 1

**12.232 FS,12.232 FLS (169 kW | Truck Tractor | 4x2 | 12 t)**

08.88 → 06.96 | RTE, RTF, RTH | 246-075-010-001C | SWP-M-G | Plug Number (T2): 1

**12.262 F,12.262 FL (191 kW | Platform / Chassis | 4x2 | 12 t)**

08.95 → 06.96 | RDA | 246-075-010-001C | SWP-M-G | Plug Number (T2): 1

**12.262 FK (191 kW | Dump Truck | 4x2 | 12 t)**

08.95 → 06.96 | N7A | 246-075-010-001C | SWP-M-G | Plug Number (T2): 1

**12.262 FS,12.262 FLS (191 kW | Truck Tractor | 4x2 | 12 t)**

08.95 → 06.96 | RQB | 246-075-010-001C | SWP-M-G | Plug Number (T2): 1

**12.272 F,12.272 FL (198 kW | Platform / Chassis | 4x2 | 12 t)**

10.92 → 06.96 | J6A, J4B | 246-075-010-001C | SWP-M-G | Plug Number (T2): 1

09.91 → 10.92 | RTE, RTF, RTH | 246-075-010-001C | SWP-M-G | Plug Number (T2): 1

**12.272 FA (198 kW | Platform / Chassis | 4x4 | 12 t)**

10.93 → 04.95 | RFD, RFK | 246-075-010-001C | SWP-M-G | Plug Number (T2): 1

**12.272 FAK (198 kW | Dump Truck | 4x4 | 12 t)**

10.93 → 04.95 | LJF | 246-075-010-001C | SWP-M-G | Plug Number (T2): 1

**12.272 FK (198 kW | Dump Truck | 4x2 | 12 t)**

10.92 → 06.96 | F6F, F6G | 246-075-010-001C | SWP-M-G | Plug Number (T2): 1

09.91 → 10.92 | L1E, L1K | 246-075-010-001C | SWP-M-G | Plug Number (T2): 1

**12.272 FS,12.272 FLS (198 kW | Truck Tractor | 4x2 | 12 t)**

10.92 → 06.96 | N57 D30 A | 246-075-010-001C | SWP-M-G | Plug Number (T2): 1

09.91 → 10.92 | N57S D30 B | 246-075-010-001C | SWP-M-G | Plug Number (T2): 1

**G****6.90 F (66 kW → 66 kW | Platform / Chassis | 4x2 | 6 t)**

10.79 → 09.87 | N8D, NEL | 246-075-010-001C | SWP-M-G | Plug Number (T2): 1

10.79 → 09.87 | N8D, NEL | 246-082-008-012C | SWP-M-C | Plug Number (T2): 1

**6.90 FK (66 kW | Dump Truck | 4x2 | 6 t)**

10.79 → 09.87 | OM 601.940 | 246-075-010-001C | SWP-M-G | Plug Number (T2): 1

10.79 → 09.87 | OM 601.940 | 246-082-008-012C | SWP-M-C | Plug Number (T2): 1

**MERCEDES-BENZ****MK****1222 (160 kW → 165 kW | Platform / Chassis | 4x2 | 12 t)**

07.89 → 08.94 | OM 603.913 | 246-082-008-012C | SWP-M-C | Plug Number (T2): 1

**1222 A, 1222 LA (160 kW → 165 kW | Platform / Chassis | 4x4 | 12 t)**

09.89 → 07.94 | OM 603.912 | 246-082-008-012C | SWP-M-C | Plug Number (T2): 1

**1222 AF (160 kW → 165 kW | General Purpose Vehicle | 4x4 | 12 t)**

09.89 → 09.93 | OM 606.910 | 246-082-008-012C | SWP-M-C | Plug Number (T2): 1

**1222 F (160 kW → 165 kW | General Purpose Vehicle | 4x2 | 12 t)**

07.89 → 08.94 | OM 603.913 | 246-082-008-012C | SWP-M-C | Plug Number (T2): 1



			<b>VDO</b>		
Date	Engine Code	Chassis No.	Article No.	Product	Information

**MERCEDES-BENZ****MK****1222 S, 1222 LS (160 kW -> 165 kW | Truck Tractor | 4x2 | 12 t)**

07.89 - 08.94 | OM 603.912 | 246-082-008-012C | SWP-M-C | Plug Number (T2): 1

**1224 AF (170 kW -> 177 kW | General Purpose Vehicle | 4x4 | 12 t)**

02.93 - 09.96 | 8FP (EP3) | 246-082-008-012C | SWP-M-C | Plug Number (T2): 1

**1224 AF (180 kW | General Purpose Vehicle | 4x4 | 12 t)**

02.93 - 09.96 | OM 603.963 | 246-082-008-012C | SWP-M-C | Plug Number (T2): 1

**1226 AF (180 kW -> 200 kW | General Purpose Vehicle | 4x4 | 12 t)**

02.93 - 09.96 | OM 603.960 | 246-082-008-012C | SWP-M-C | Plug Number (T2): 1

**1226 AF (195 kW -> 218 kW | General Purpose Vehicle | 4x4 | 12 t)**

02.90 - 09.93 | 5FV (EP6CDT) | 246-082-008-012C | SWP-M-C | Plug Number (T2): 1

**1226 AF (250 kW | General Purpose Vehicle | 4x4 | 12 t)**

02.93 - 09.96 | M 102.922 | 246-082-008-012C | SWP-M-C | Plug Number (T2): 1

**1227 A (200 kW | Platform / Chassis | 4x4 | 12 t)**

01.92 - 07.92 | M 111.940 | 246-082-008-012C | SWP-M-C | Plug Number (T2): 1

**1234 AF (250 kW | General Purpose Vehicle | 4x4 | 12 t)**

01.92 - 09.96 | M 111.960 | 246-082-008-012C | SWP-M-C | Plug Number (T2): 1

**NG****1013 (96 kW | Platform / Chassis | 4x2 | 10 t)**

02.76 - 12.84 | AR 01655, AR 11671 | 246-075-024-002C | SWP-M-G | Plug Number (T2): 1

**1013 A (96 kW | Platform / Chassis | 4x4 | 10 t)**

02.76 - 12.86 | AR 01699 | 246-075-024-002C | SWP-M-G | Plug Number (T2): 1

**1013 AK (96 kW | Dump Truck | 4x4 | 10 t)**

02.76 - 12.84 | AR 10538 | 246-075-024-002C | SWP-M-G | Plug Number (T2): 1

**1013 K (96 kW | Dump Truck | 4x2 | 10 t)**

02.76 - 12.84 | AR 00536 | 246-075-024-002C | SWP-M-G | Plug Number (T2): 1

**1013 KO (96 kW | General Purpose Vehicle | 4x2 | 10 t)**

02.76 - 12.84 | AR 00530 | 246-075-024-002C | SWP-M-G | Plug Number (T2): 1

**1013 S (96 kW | Truck Tractor | 4x2 | 10 t)**

02.76 - 12.84 | AR 00526 S | 246-075-024-002C | SWP-M-G | Plug Number (T2): 1

**2028 LS (206 kW | Truck Tractor | 6x2/4 | 20 t)**

01.80 - 06.89 | CFFB | 246-075-024-002C | SWP-M-G | Plug Number (T2): 1

**LK/LN2****709 (63 kW -> 66 kW | Platform / Chassis | 4x2 | 7 t)**

03.84 - 12.98 | A 20 DTR | 246-082-008-012C | SWP-M-C | Plug Number (T2): 1

**709 K (63 kW -> 66 kW | Dump Truck | 4x2 | 7 t)**

03.84 - 10.90 | 246-082-008-012C | SWP-M-C | Plug Number (T2): 1

**711 (77 kW | Platform / Chassis | 4x2 | 7 t)**

03.94 - 12.98 | AR 30184 | 246-082-008-012C | SWP-M-C | Plug Number (T2): 1

**711 (90 kW | Platform / Chassis | 4x2 | 7 t)**

03.96 - 12.98 | AR 30164 | 246-082-008-012C | SWP-M-C | Plug Number (T2): 1

**809 (63 kW -> 66 kW | Platform / Chassis | 4x2 | 8 t)**

03.84 - 12.98 | AR 30168 | 246-082-008-012C | SWP-M-C | Plug Number (T2): 1

**809 K (63 kW -> 66 kW | Dump Truck | 4x2 | 8 t)**

03.84 - 12.98 | AR 30124 | 246-082-008-012C | SWP-M-C | Plug Number (T2): 1

**811 (77 kW | Platform / Chassis | 4x2 | 8 t)**

03.94 - 12.98 | AR 30128 | 246-082-008-012C | SWP-M-C | Plug Number (T2): 1

**811 (90 kW | Platform / Chassis | 4x2 | 8 t)**

03.96 - 12.98 | AR 30146 | 246-082-008-012C | SWP-M-C | Plug Number (T2): 1

**811 K (77 kW | Dump Truck | 4x2 | 8 t)**

03.94 - 12.98 | AR 30558 | 246-082-008-012C | SWP-M-C | Plug Number (T2): 1

**811 K (90 kW | Dump Truck | 4x2 | 8 t)**

03.96 - 12.98 | AR 30585 | 246-082-008-012C | SWP-M-C | Plug Number (T2): 1

**814 F (100 kW | General Purpose Vehicle | 4x2 | 8 t)**

03.96 - 12.98 | AR 30558, AR 30737 | 246-082-008-012C | SWP-M-C | Plug Number (T2): 1

**814 F (103 kW | General Purpose Vehicle | 4x2 | 8 t)**

03.94 - 12.98 | AR 30588 | 246-082-008-012C | SWP-M-C | Plug Number (T2): 1

**814 F (95 kW -> 100 kW | General Purpose Vehicle | 4x2 | 8 t)**

05.86 - 12.98 | AR 30146, AR 30508, AR 30588 | 246-082-008-012C | SWP-M-C | Plug Number (T2): 1

**814 K (100 kW | Dump Truck | 4x2 | 8 t)**

03.96 - 12.98 | AR 30550 | 246-082-008-012C | SWP-M-C | Plug Number (T2): 1



			<b>VDO</b>		
Date	Engine Code	Chassis No.	Article No.	Product	Information

**MERCEDES-BENZ****LK/LN2**

<b>814 K (103 kW   Dump Truck   4x2   8 t)</b>					
03.94 - 12.98	AR 30168, AR 30587		246-082-008-012C	SWP-M-C	Plug Number (T2): 1
<b>814 K (95 kW -&gt; 100 kW   Dump Truck   4x2   8 t)</b>					
03.84 - 12.98	AR 30588		246-082-008-012C	SWP-M-C	Plug Number (T2): 1
<b>814 LO (100 kW   Bus   4x2   8 t)</b>					
03.96 - 12.98	AR 30737, AR 30736		246-082-008-012C	SWP-M-C	Plug Number (T2): 1
<b>814 O, 814 LO (95 kW -&gt; 100 kW   Bus   4x2   8 t)</b>					
01.84 - 12.98	AR 30753, AR 30755		246-082-008-012C	SWP-M-C	Plug Number (T2): 1
<b>814 S (100 kW   Truck Tractor   4x2   8 t)</b>					
03.96 - 12.98	AR 30520		246-082-008-012C	SWP-M-C	Plug Number (T2): 1
<b>814 S (103 kW   Truck Tractor   4x2   8 t)</b>					
03.94 - 12.98	AR 30504, AR 30143		246-082-008-012C	SWP-M-C	Plug Number (T2): 1
<b>814 S (95 kW -&gt; 100 kW   Truck Tractor   4x2   8 t)</b>					
03.84 - 12.98	AR 30146, AR 30508, AR 30588		246-082-008-012C	SWP-M-C	Plug Number (T2): 1
<b>814,814 L (103 kW   Platform / Chassis   4x2   8 t)</b>					
01.84 - 12.98	AR 30502, AR 30586		246-082-008-012C	SWP-M-C	Plug Number (T2): 1
<b>814,814L (100 kW   Platform / Chassis   4x2   8 t)</b>					
03.96 - 12.98	AR 30558		246-082-008-012C	SWP-M-C	Plug Number (T2): 1
<b>814,814L (95 kW -&gt; 100 kW   Platform / Chassis   4x2   8 t)</b>					
01.84 - 12.98			246-082-008-012C	SWP-M-C	Plug Number (T2): 1
<b>O 814, O 814 L (103 kW   Bus   4x2   8 t)</b>					
01.84 - 12.98	AR 30753, AR 30755		246-082-008-012C	SWP-M-C	Plug Number (T2): 1

**LP**

<b>LP 709, LPL 709 (63 kW   Platform / Chassis   4x2   7 t)</b>					
09.63 - 12.84	M50 B25, M50 B25 (Vanos), M50 B25 TU		246-082-008-012C	SWP-M-C	Plug Number (T2): 1
<b>LP 809, LPL 808, LPL 809 (63 kW   Platform / Chassis   4x2   8 t)</b>					
09.63 - 12.84	AR 01646		246-082-008-012C	SWP-M-C	Plug Number (T2): 1
<b>LP 811 (81 kW   Platform / Chassis   4x2   8 t)</b>					
10.69 - 02.73	JTDA, JTDB		246-082-008-012C	SWP-M-C	Plug Number (T2): 1
<b>LPK 709 (63 kW   Dump Truck   4x2   7 t)</b>					
11.77 - 12.84	M51 D25 (Inter.)		246-082-008-012C	SWP-M-C	Plug Number (T2): 1
<b>LPK 809 (63 kW   Dump Truck   4x2   8 t)</b>					
11.77 - 12.84	JQDA, JQDB		246-082-008-012C	SWP-M-C	Plug Number (T2): 1
<b>LPKF 709 (63 kW   General Purpose Vehicle   4x2   7 t)</b>					
11.77 - 12.84	M50 B25 (Vanos), M50 B25, M50 B25 TU		246-082-008-012C	SWP-M-C	Plug Number (T2): 1
<b>LPO 709 (63 kW   Bus   4x2   7 t)</b>					
11.77 - 12.84	M51 D25		246-082-008-012C	SWP-M-C	Plug Number (T2): 1
<b>LPS 709, LPLS 709 (63 kW   Truck Tractor   4x2   7 t)</b>					
09.63 - 12.84	PNDA		246-082-008-012C	SWP-M-C	Plug Number (T2): 1
<b>LPS 811 (81 kW   Truck Tractor   4x2   8 t)</b>					
10.69 - 02.73	T3DA, T3DB		246-082-008-012C	SWP-M-C	Plug Number (T2): 1

**SCANIA****4 - series**

<b>94 C/260 (191 kW   Dump Truck   4x2   18 t)</b>					
12.96 -	KA24-E	1257631→	246-075-044-003A	SWP-M-G	Plug Number (T2): 2
<b>94 C/260 (191 kW   Dump Truck   4x4   18 t)</b>					
12.96 -	TD27	1257631→	246-075-044-003A	SWP-M-G	Plug Number (T2): 2
<b>94 C/260 (191 kW   Dump Truck   6x4   26 t)</b>					
12.96 -	CCSA, CMXA	1257631→	246-075-044-003A	SWP-M-G	Plug Number (T2): 2
<b>94 C/260 (191 kW   Dump Truck   6x6   26 t)</b>					
12.96 -	CAYB	1257631→	246-075-044-003A	SWP-M-G	Plug Number (T2): 2
<b>94 C/260 (191 kW   Dump Truck   8x4/4   32 t)</b>					
12.96 -	G4EH	1257631→	246-075-044-003A	SWP-M-G	Plug Number (T2): 2
<b>94 C/260 (191 kW   Platform / Chassis   4x2   18 t)</b>					
12.96 -	ERH	1257631→	246-075-044-003A	SWP-M-G	Plug Number (T2): 2



			<b>VDO</b>		
Date	Engine Code	Chassis No.	Article No.	Product	Information

**SCANIA****4 - series**

<b>94 C/260 (191 kW   Platform / Chassis   6x4   26 t)</b>					
12.96 --	FEY9	1257631--	246-075-044-003A	SWP-M-G	Plug Number (T2): 2
<b>94 C/310 (228 kW   Dump Truck   4x2   18 t)</b>					
08.96 --	ERH	1257631--	246-075-044-003A	SWP-M-G	Plug Number (T2): 2
<b>94 C/310 (228 kW   Dump Truck   4x4   18 t)</b>					
08.96 --	MX	1257631--	246-075-044-003A	SWP-M-G	Plug Number (T2): 2
<b>94 C/310 (228 kW   Dump Truck   6x4   26 t)</b>					
08.96 --	ELF	1257631--	246-075-044-003A	SWP-M-G	Plug Number (T2): 2
<b>94 C/310 (228 kW   Dump Truck   6x6   26 t)</b>					
08.96 --	Y	1257631--	246-075-044-003A	SWP-M-G	Plug Number (T2): 2
<b>94 C/310 (228 kW   Dump Truck   8x4/4   32 t)</b>					
08.96 --	K00	1257631--	246-075-044-003A	SWP-M-G	Plug Number (T2): 2
<b>94 C/310 (228 kW   Platform / Chassis   4x2   18 t)</b>					
08.96 --	ERH	1257631--	246-075-044-003A	SWP-M-G	Plug Number (T2): 2
<b>94 C/310 (228 kW   Platform / Chassis   6x2   26 t)</b>					
08.96 --	J8S	1257631--	246-075-044-003A	SWP-M-G	Plug Number (T2): 2
<b>94 C/310 (228 kW   Platform / Chassis   6x4   26 t)</b>					
08.96 --	ENC	1257631--	246-075-044-003A	SWP-M-G	Plug Number (T2): 2
<b>94 C/310 (228 kW   Truck Tractor   4x2   18 t)</b>					
08.96 --	R2	1257631--	246-075-044-003A	SWP-M-G	Plug Number (T2): 2
<b>94 D/220 (162 kW   Platform / Chassis   4x2   18 t)</b>					
08.96 --	FECK	1257631--	246-075-044-003A	SWP-M-G	Plug Number (T2): 2
<b>94 D/220 (162 kW   Platform / Chassis   6x2/2/4   25 t)</b>					
08.96 --	F10A	1257631--	246-075-044-003A	SWP-M-G	Plug Number (T2): 2
<b>94 D/220 (162 kW   Truck Tractor   4x2   18 t)</b>					
08.96 --	G10BB, G10B	1257631--	246-075-044-003A	SWP-M-G	Plug Number (T2): 2
<b>94 D/230 (169 kW   Platform / Chassis   4x2   18 t)</b>					
08.99 --	152A (XD3T)	1257631--	246-075-044-003A	SWP-M-G	Plug Number (T2): 2
<b>94 D/230 (169 kW   Platform / Chassis   6x2/2/4   25 t)</b>					
08.99 --	152B (XD3TE)	1257631--	246-075-044-003A	SWP-M-G	Plug Number (T2): 2
<b>94 D/230 (169 kW   Truck Tractor   4x2   18 t)</b>					
08.99 --	112 (ZM)	1257631--	246-075-044-003A	SWP-M-G	Plug Number (T2): 2
<b>94 D/260 (191 kW   Platform / Chassis   4x2   18 t)</b>					
08.96 --		1257631--	246-075-044-003A	SWP-M-G	Plug Number (T2): 2
<b>94 D/260 (191 kW   Platform / Chassis   6x2/2/4   25 t)</b>					
08.96 --	EDR	1257631--	246-075-044-003A	SWP-M-G	Plug Number (T2): 2
<b>94 D/260 (191 kW   Truck Tractor   4x2   18 t)</b>					
08.96 --	EDM	1257631--	246-075-044-003A	SWP-M-G	Plug Number (T2): 2
<b>94 D/310 (228 kW   Platform / Chassis   4x2   18 t)</b>					
12.96 --	A15MF	1257631--	246-075-044-003A	SWP-M-G	Plug Number (T2): 2
<b>94 D/310 (228 kW   Platform / Chassis   6x2/2/4   26 t)</b>					
01.98 --	G15MF	1257631--	246-075-044-003A	SWP-M-G	Plug Number (T2): 2
<b>94 D/310 (228 kW   Truck Tractor   4x2   18 t)</b>					
12.96 --	G15MF	1257631--	246-075-044-003A	SWP-M-G	Plug Number (T2): 2
<b>94 G/220 (162 kW   Platform / Chassis   4x2   18 t)</b>					
08.96 --	G15B, G4DJ	1257631--	246-075-044-003A	SWP-M-G	Plug Number (T2): 2
<b>94 G/220 (162 kW   Platform / Chassis   6x2/2/4   25 t)</b>					
01.98 --	G15B, G4DJ	1257631--	246-075-044-003A	SWP-M-G	Plug Number (T2): 2
<b>94 G/220 (162 kW   Truck Tractor   4x2   18 t)</b>					
08.96 --	G15B, G4DJ	1257631--	246-075-044-003A	SWP-M-G	Plug Number (T2): 2
<b>94 G/260 (191 kW   Platform / Chassis   4x2   18 t)</b>					
08.96 --	353,18	1257631--	246-075-044-003A	SWP-M-G	Plug Number (T2): 2
<b>94 G/260 (191 kW   Platform / Chassis   6x2/2/4   25 t)</b>					
01.98 --	4VO7,2/7,5GRF	1257631--	246-075-044-003A	SWP-M-G	Plug Number (T2): 2
<b>94 G/260 (191 kW   Truck Tractor   4x2   18 t)</b>					
08.96 --	353,18	1257631--	246-075-044-003A	SWP-M-G	Plug Number (T2): 2
<b>94 G/310 (228 kW   Platform / Chassis   4x2   18 t)</b>					
08.96 --	353,18	1257631--	246-075-044-003A	SWP-M-G	Plug Number (T2): 2
<b>94 G/310 (228 kW   Platform / Chassis   6x2/2/4   26 t)</b>					
08.96 --	EPE, HX	1257631--	246-075-044-003A	SWP-M-G	Plug Number (T2): 2
<b>94 G/310 (228 kW   Truck Tractor   4x2   18 t)</b>					
08.96 --	MX	1257631--	246-075-044-003A	SWP-M-G	Plug Number (T2): 2



			<b>VDO</b>		
Date	Engine Code	Chassis No.	Article No.	Product	Information

**SCANIA****4 - series**

<b>94 L/310 (228 kW   Platform / Chassis   4x2   18 t)</b>					
08.96 -	N57 D30 B	1257631-	246-075-044-003A	SWP-M-G	Plug Number (T2): 2
<b>94 L/310 (228 kW   Platform / Chassis   6x2/2/4   26 t)</b>					
08.96 -	N47 D20 D	1257631-	246-075-044-003A	SWP-M-G	Plug Number (T2): 2
<b>94 L/310 (228 kW   Platform / Chassis   6x4   26 t)</b>					
08.96 -	CA20E	1257631-	246-075-044-003A	SWP-M-G	Plug Number (T2): 2
<b>94 L/310 (228 kW   Truck Tractor   4x2   18 t)</b>					
08.96 -	SR20DET	1257631-	246-075-044-003A	SWP-M-G	Plug Number (T2): 2
<b>94 L/310 (228 kW   Truck Tractor   6x4   26 t)</b>					
08.96 -	ED 10	1257631-	246-075-044-003A	SWP-M-G	Plug Number (T2): 2

**3 - series**

<b>93 H/220 (162 kW   Platform / Chassis   4x2   18 t)</b>					
12.91 - 12.96			246-075-044-003A	SWP-M-G	Plug Number (T2): 2
<b>93 H/250 (185 kW   Concrete Mixer   6x4   26 t)</b>					
01.90 - 12.96	RFX (XU10J2C)		246-075-044-003A	SWP-M-G	Plug Number (T2): 2
<b>93 H/250 (185 kW   Dump Truck   4x4   17 t)</b>					
03.88 - 12.89	ACK, ALG, AMX, APR, AQD		246-075-044-003A	SWP-M-G	Plug Number (T2): 2
<b>93 H/250 (185 kW   Dump Truck   4x4   18 t)</b>					
01.90 - 12.96	RFV (XU10J4R)		246-075-044-003A	SWP-M-G	Plug Number (T2): 2
<b>93 H/250 (185 kW   Dump Truck   6x4   24 t)</b>					
01.89 - 12.89	420T		246-075-044-003A	SWP-M-G	Plug Number (T2): 2
<b>93 H/250 (185 kW   Dump Truck   6x4   26 t)</b>					
01.90 - 12.96	RGX (XU10J2TE)		246-075-044-003A	SWP-M-G	Plug Number (T2): 2
<b>93 H/250 (185 kW   Platform / Chassis   4x2   18 t)</b>					
01.90 - 12.96	TBBA		246-075-044-003A	SWP-M-G	Plug Number (T2): 2
<b>93 H/250 (185 kW   Platform / Chassis   6x4   26 t)</b>					
01.90 - 12.96	P8C (XUD11BTE)		246-075-044-003A	SWP-M-G	Plug Number (T2): 2
<b>93 H/280 (207 kW -&gt; 208 kW   Concrete Mixer   6x4   26 t)</b>					
12.91 - 12.96	AR 67204		246-075-044-003A	SWP-M-G	Plug Number (T2): 2
<b>93 H/280 (207 kW -&gt; 208 kW   Dump Truck   6x4   18 t)</b>					
12.91 - 12.96	182 A1.000		246-075-044-003A	SWP-M-G	Plug Number (T2): 2
<b>93 H/280 (207 kW -&gt; 208 kW   Dump Truck   6x4   26 t)</b>					
12.91 - 12.96	AR 67204		246-075-044-003A	SWP-M-G	Plug Number (T2): 2
<b>93 H/280 (207 kW -&gt; 208 kW   Platform / Chassis   4x2   18 t)</b>					
12.91 - 12.96	182 A5.000		246-075-044-003A	SWP-M-G	Plug Number (T2): 2
<b>93 H/280 (207 kW -&gt; 208 kW   Platform / Chassis   6x4   26 t)</b>					
12.91 - 12.96	230 A2.000		246-075-044-003A	SWP-M-G	Plug Number (T2): 2
<b>93 M/210 (155 kW   Platform / Chassis   4x2   17 t)</b>					
03.88 - 12.91	4E-FE		246-075-044-003A	SWP-M-G	Plug Number (T2): 2
<b>93 M/220 (162 kW   Platform / Chassis   4x2   18 t)</b>					
12.91 - 12.96	B00		246-075-044-003A	SWP-M-G	Plug Number (T2): 2
<b>93 M/220 (162 kW   Platform / Chassis   6x2/2/4   25 t)</b>					
12.91 - 12.96	R00		246-075-044-003A	SWP-M-G	Plug Number (T2): 2
<b>93 M/220 (162 kW   Truck Tractor   4x2   18 t)</b>					
12.91 - 12.96	L00		246-075-044-003A	SWP-M-G	Plug Number (T2): 2
<b>93 M/230 (167 kW   Platform / Chassis   4x2   17 t)</b>					
03.88 - 12.89	3UR-FE		246-075-044-003A	SWP-M-G	Plug Number (T2): 2
<b>93 M/230 (167 kW   Platform / Chassis   4x2   18 t)</b>					
01.90 - 12.91	M62 B44, M62 448 S2, M62 B44 TU		246-075-044-003A	SWP-M-G	Plug Number (T2): 2
<b>93 M/230 (167 kW   Platform / Chassis   6x2   24 t)</b>					
03.88 - 12.89			246-075-044-003A	SWP-M-G	Plug Number (T2): 2
<b>93 M/230 (167 kW   Platform / Chassis   6x2   25 t)</b>					
01.90 - 12.91	M 111.920, M 111.921		246-075-044-003A	SWP-M-G	Plug Number (T2): 2
<b>93 M/230 (167 kW   Truck Tractor   4x2   17 t)</b>					
03.88 - 12.89	M51 D25 (Inter.)		246-075-044-003A	SWP-M-G	Plug Number (T2): 2
<b>93 M/230 (167 kW   Truck Tractor   4x2   18 t)</b>					
01.90 - 12.91	M 111.941, M 111.945		246-075-044-003A	SWP-M-G	Plug Number (T2): 2
<b>93 M/250 (185 kW   Concrete Mixer   6x4   26 t)</b>					
10.90 - 12.96	RGX (XU10J2TE)		246-075-044-003A	SWP-M-G	Plug Number (T2): 2
<b>93 M/250 (185 kW   Dump Truck   4x4   18 t)</b>					
01.90 - 12.96	OM 604.910		246-075-044-003A	SWP-M-G	Plug Number (T2): 2



			<b>VDO</b>		
Date	Engine Code	Chassis No.	Article No.	Product	Information

## SCANIA

### 3 - series

<b>93 M/250 (185 kW   Dump Truck   6x4   26 t)</b>					
01.90 - 12.96	LFY (XU7JP4)		246-075-044-003A	SWP-M-G	Plug Number (T2): 2
<b>93 M/250 (185 kW   Platform / Chassis   4x2   17 t)</b>					
03.88 - 12.89	OM 605.960		246-075-044-003A	SWP-M-G	Plug Number (T2): 2
<b>93 M/250 (185 kW   Platform / Chassis   4x2   18 t)</b>					
01.90 - 12.96	425 CLIRS/X		246-075-044-003A	SWP-M-G	Plug Number (T2): 2
<b>93 M/250 (185 kW   Platform / Chassis   6x2/2/4   24 t)</b>					
03.88 - 12.89	ACK, ALG, AMX, APR, AQD		246-075-044-003A	SWP-M-G	Plug Number (T2): 2
<b>93 M/250 (185 kW   Platform / Chassis   6x2/2/4   25 t)</b>					
01.90 - 12.96	G4FC		246-075-044-003A	SWP-M-G	Plug Number (T2): 2
<b>93 M/250 (185 kW   Platform / Chassis   6x4   26 t)</b>					
01.90 - 12.96	182 A2.000		246-075-044-003A	SWP-M-G	Plug Number (T2): 2
<b>93 M/250 (185 kW   Truck Tractor   4x2   17 t)</b>					
03.88 - 12.89	ACK, AMX, APR, AQD		246-075-044-003A	SWP-M-G	Plug Number (T2): 2
<b>93 M/250 (185 kW   Truck Tractor   4x2   18 t)</b>					
01.90 - 12.96	ERH		246-075-044-003A	SWP-M-G	Plug Number (T2): 2
<b>93 M/280 (207 kW -&gt; 208 kW   Concrete Mixer   6x4   26 t)</b>					
01.90 - 12.96	182 A6.000		246-075-044-003A	SWP-M-G	Plug Number (T2): 2
<b>93 M/280 (207 kW -&gt; 208 kW   Dump Truck   6x4   26 t)</b>					
01.90 - 12.96	182 A2.000		246-075-044-003A	SWP-M-G	Plug Number (T2): 2
<b>93 M/280 (207 kW -&gt; 208 kW   Platform / Chassis   4x2   18 t)</b>					
01.90 - 12.96	DHX (XUD9TF/BTF), D8B (XUD9TF), DHY (XUD9TE/Y)		246-075-044-003A	SWP-M-G	Plug Number (T2): 2
<b>93 M/280 (207 kW -&gt; 208 kW   Platform / Chassis   6x2/2/4   25 t)</b>					
01.90 - 12.96	176 B1.000, 176 B4.000		246-075-044-003A	SWP-M-G	Plug Number (T2): 2
<b>93 M/280 (207 kW -&gt; 208 kW   Platform / Chassis   6x4   26 t)</b>					
01.90 - 12.96	182 A5.000		246-075-044-003A	SWP-M-G	Plug Number (T2): 2
<b>93 M/280 (207 kW -&gt; 208 kW   Truck Tractor   4x2   18 t)</b>					
01.90 - 12.96	TBBA		246-075-044-003A	SWP-M-G	Plug Number (T2): 2
<b>93 M/280 (207 kW   Platform / Chassis   4x2   17 t)</b>					
03.88 - 12.89	ACK, ALG, AMX, APR, AQD		246-075-044-003A	SWP-M-G	Plug Number (T2): 2
<b>93 M/280 (207 kW   Platform / Chassis   6x2   24 t)</b>					
03.88 - 12.89	ACK, ALG, AMX, APR, AQD		246-075-044-003A	SWP-M-G	Plug Number (T2): 2
<b>93 M/280 (207 kW   Truck Tractor   4x2   17 t)</b>					
03.88 - 12.89	ACK, ALG, AMX, APR, AQD		246-075-044-003A	SWP-M-G	Plug Number (T2): 2

## VOLVO

### F 10

<b>F 10/260 (192 kW -&gt; 200 kW   Dump Truck   4x2   16 t)</b>					
02.82 - 06.85	H23A2		246-075-040-020C	SWP-M-G	Plug Number (T2): 1
02.82 - 06.85	H23A2	314 000→	246-075-051-007C	SWP-M-G	Plug Number (T2): 2
<b>F 10/260 (192 kW -&gt; 200 kW   Platform / Chassis   4x2   16 t)</b>					
02.82 - 06.85	B20A1		246-075-040-020C	SWP-M-G	Plug Number (T2): 1
02.82 - 06.85	B20A1	314 000→	246-075-051-007C	SWP-M-G	Plug Number (T2): 2
<b>F 10/260 (192 kW -&gt; 200 kW   Platform / Chassis   6x2   22 t)</b>					
02.82 - 06.85	B20A5		246-075-040-020C	SWP-M-G	Plug Number (T2): 1
02.82 - 06.85	B20A5	314 000→	246-075-051-007C	SWP-M-G	Plug Number (T2): 2
<b>F 10/260 (192 kW -&gt; 200 kW   Platform / Chassis   6x4   22 t)</b>					
01.83 - 06.85	B16A2		246-075-040-020C	SWP-M-G	Plug Number (T2): 1
01.83 - 06.85	B16A2	314 000→	246-075-051-007C	SWP-M-G	Plug Number (T2): 2
<b>F 10/260 (192 kW -&gt; 200 kW   Truck Tractor   4x2   16 t)</b>					
02.82 - 06.85	L20A		246-075-040-020C	SWP-M-G	Plug Number (T2): 1
02.82 - 06.85	L20A	314 000→	246-075-051-007C	SWP-M-G	Plug Number (T2): 2
<b>F 10/260 (192 kW -&gt; 200 kW   Truck Tractor   6x2   22 t)</b>					
02.82 - 06.85	B20A9		246-075-040-020C	SWP-M-G	Plug Number (T2): 1
02.82 - 06.85	B20A9	314 000→	246-075-051-007C	SWP-M-G	Plug Number (T2): 2
<b>F 10/260 (192 kW -&gt; 200 kW   Truck Tractor   6x4   22 t)</b>					
02.82 - 06.85	L24		246-075-040-020C	SWP-M-G	Plug Number (T2): 1
02.82 - 06.85	L24	314 000→	246-075-051-007C	SWP-M-G	Plug Number (T2): 2





			<b>VDO</b>		
Date	Engine Code	Chassis No.	Article No.	Product	Information

**VOLVO****F 10****F 10/280 (206 kW -> 207 kW | Dump Truck | 4x2 | 16 t)**

08.77 - 02.82	F20A4		246-075-040-020C	SWP-M-G	Plug Number (T2): 1
08.77 - 02.82	F20A4	314 000→	246-075-051-007C	SWP-M-G	Plug Number (T2): 2

**F 10/280 (206 kW -> 207 kW | Platform / Chassis | 4x2 | 16 t)**

08.77 - 02.82	LD20		246-075-040-020C	SWP-M-G	Plug Number (T2): 1
08.77 - 02.82	LD20	314 000→	246-075-051-007C	SWP-M-G	Plug Number (T2): 2

**F 10/280 (206 kW -> 207 kW | Platform / Chassis | 6x2 | 22 t)**

08.77 - 02.82	D16Z6, D16Y8		246-075-040-020C	SWP-M-G	Plug Number (T2): 1
08.77 - 02.82	D16Z6, D16Y8	314 000→	246-075-051-007C	SWP-M-G	Plug Number (T2): 2

**F 10/280 (206 kW -> 207 kW | Truck Tractor | 4x2 | 16 t)**

08.77 - 02.82	B20A3		246-075-040-020C	SWP-M-G	Plug Number (T2): 1
08.77 - 02.82	B20A3	314 000→	246-075-051-007C	SWP-M-G	Plug Number (T2): 2

**F 10/280 (206 kW -> 207 kW | Truck Tractor | 6x2 | 22 t)**

08.77 - 02.82	VG30E		246-075-040-020C	SWP-M-G	Plug Number (T2): 1
08.77 - 02.82	VG30E	314 000→	246-075-051-007C	SWP-M-G	Plug Number (T2): 2

**F 10/300 (215 kW -> 220 kW | Platform / Chassis | 4x2 | 17 t)**

01.87 - 12.87	LD28		246-075-040-020C	SWP-M-G	Plug Number (T2): 1
01.87 - 12.87	LD28	314 000→	246-075-051-007C	SWP-M-G	Plug Number (T2): 2

**F 10/300 (215 kW -> 220 kW | Platform / Chassis | 6x2 | 22 t)**

01.84 - 12.86	EW2		246-075-040-020C	SWP-M-G	Plug Number (T2): 1
01.84 - 12.86	EW2	314 000→	246-075-051-007C	SWP-M-G	Plug Number (T2): 2

**F 10/300 (215 kW -> 220 kW | Platform / Chassis | 6x2 | 24 t)**

01.87 - 12.87	L24E, L24S		246-075-040-020C	SWP-M-G	Plug Number (T2): 1
01.87 - 12.87	L24E, L24S	314 000→	246-075-051-007C	SWP-M-G	Plug Number (T2): 2

**F 10/300 (215 kW -> 220 kW | Truck Tractor | 4x2 | 16 t)**

01.84 - 12.86	L24		246-075-040-020C	SWP-M-G	Plug Number (T2): 1
01.84 - 12.86	L24	314 000→	246-075-051-007C	SWP-M-G	Plug Number (T2): 2

**F 10/300 (215 kW -> 220 kW | Truck Tractor | 6x2 | 22 t)**

01.84 - 12.86	EW2		246-075-040-020C	SWP-M-G	Plug Number (T2): 1
01.84 - 12.86	EW2	314 000→	246-075-051-007C	SWP-M-G	Plug Number (T2): 2

**F 10/300 (215 kW -> 221 kW | Platform / Chassis | 4x2 | 16 t)**

10.83 - 12.86	L20A		246-075-040-020C	SWP-M-G	Plug Number (T2): 1
10.83 - 12.86	L20A	314 000→	246-075-051-007C	SWP-M-G	Plug Number (T2): 2

**F 10/320 (228 kW -> 235 kW | Dump Truck | 4x2 | 17 t)**

10.87 - 12.90	C32A2		246-075-040-020C	SWP-M-G	Plug Number (T2): 1
10.87 - 12.90	C32A2	314 000→	246-075-051-007C	SWP-M-G	Plug Number (T2): 2

**F 10/320 (228 kW -> 235 kW | Dump Truck | 4x2 | 18 t)**

12.90 - 12.94	ET4, ET3		246-075-040-020C	SWP-M-G	Plug Number (T2): 1
12.90 - 12.94	ET4, ET3	314 000→	246-075-051-007C	SWP-M-G	Plug Number (T2): 2

**F 10/320 (228 kW -> 235 kW | Dump Truck | 6x4 | 26 t)**

12.90 - 12.94	ET2, ET3		246-075-040-020C	SWP-M-G	Plug Number (T2): 1
12.90 - 12.94	ET2, ET3	314 000→	246-075-051-007C	SWP-M-G	Plug Number (T2): 2

**F 10/320 (228 kW -> 235 kW | Platform / Chassis | 4x2 | 17 t)**

10.87 - 12.90	CA20S		246-075-040-020C	SWP-M-G	Plug Number (T2): 1
10.87 - 12.90	CA20S	314 000→	246-075-051-007C	SWP-M-G	Plug Number (T2): 2

**F 10/320 (228 kW -> 235 kW | Platform / Chassis | 4x2 | 18 t)**

12.90 - 12.94	C27A1		246-075-040-020C	SWP-M-G	Plug Number (T2): 1
12.90 - 12.94	C27A1	314 000→	246-075-051-007C	SWP-M-G	Plug Number (T2): 2

**F 10/320 (228 kW -> 235 kW | Platform / Chassis | 6x2 | 24 t)**

10.87 - 12.90	C25A1		246-075-040-020C	SWP-M-G	Plug Number (T2): 1
10.87 - 12.90	C25A1	314 000→	246-075-051-007C	SWP-M-G	Plug Number (T2): 2

**F 10/320 (228 kW -> 235 kW | Platform / Chassis | 6x2 | 25 t)**

12.90 - 12.94	C32A2		246-075-040-020C	SWP-M-G	Plug Number (T2): 1
12.90 - 12.94	C32A2	314 000→	246-075-051-007C	SWP-M-G	Plug Number (T2): 2

**F 10/320 (228 kW -> 235 kW | Truck Tractor | 4x2 | 17 t)**

10.87 - 12.90	CA20E		246-075-040-020C	SWP-M-G	Plug Number (T2): 1
10.87 - 12.90	CA20E	314 000→	246-075-051-007C	SWP-M-G	Plug Number (T2): 2

**F 10/320 (228 kW -> 235 kW | Truck Tractor | 4x2 | 18 t)**

12.90 - 12.94	EL, EL14		246-075-040-020C	SWP-M-G	Plug Number (T2): 1
12.90 - 12.94	EL, EL14	314 000→	246-075-051-007C	SWP-M-G	Plug Number (T2): 2

**F 10/320 (228 kW -> 235 kW | Truck Tractor | 6x2 | 24 t)**

10.87 - 12.90	C27A1		246-075-040-020C	SWP-M-G	Plug Number (T2): 1
10.87 - 12.90	C27A1	314 000→	246-075-051-007C	SWP-M-G	Plug Number (T2): 2



			<b>VDO</b>		
Date	Engine Code	Chassis No.	Article No.	Product	Information

**VOLVO****F 10****F 10/320 (228 kW -> 235 kW | Truck Tractor | 6x2 | 25 t)**

12.90 - 12.94	CA18D		246-075-040-020C	SWP-M-G	Plug Number (T2): 1
12.90 - 12.94	CA18D	314 000→	246-075-051-007C	SWP-M-G	Plug Number (T2): 2

**F 12****F 12/320 (235 kW | Dump Truck | 4x2 | 17 t)**

01.87 - 12.87	CA18DET	314 000→	246-075-051-007C	SWP-M-G	Plug Number (T2): 2
---------------	---------	----------	------------------	---------	---------------------

**F 12/320 (235 kW | Platform / Chassis | 4x2 | 17 t)**

01.87 - 12.87	VG30ET	314 000→	246-075-051-007C	SWP-M-G	Plug Number (T2): 2
---------------	--------	----------	------------------	---------	---------------------

**F 12/320 (235 kW | Platform / Chassis | 6x2 | 24 t)**

01.87 - 12.87	VG30DETT	314 000→	246-075-051-007C	SWP-M-G	Plug Number (T2): 2
---------------	----------	----------	------------------	---------	---------------------

**F 12/320 (235 kW | Platform / Chassis | 6x4 | 24 t)**

01.87 - 12.87	VG30DETT	314 000→	246-075-051-007C	SWP-M-G	Plug Number (T2): 2
---------------	----------	----------	------------------	---------	---------------------

**F 12/320 (235 kW | Truck Tractor | 4x2 | 17 t)**

01.87 - 12.87	GA16DS	314 000→	246-075-051-007C	SWP-M-G	Plug Number (T2): 2
---------------	--------	----------	------------------	---------	---------------------

**F 12/320 (235 kW | Truck Tractor | 6x2 | 24 t)**

01.87 - 12.87	SR20DE	314 000→	246-075-051-007C	SWP-M-G	Plug Number (T2): 2
---------------	--------	----------	------------------	---------	---------------------

**F 12/320 (235 kW | Truck Tractor | 6x4 | 24 t)**

01.87 - 12.87	FJ20E	314 000→	246-075-051-007C	SWP-M-G	Plug Number (T2): 2
---------------	-------	----------	------------------	---------	---------------------

**F 12/320,F 12/330 (235 kW -> 243 kW | Dump Truck | 4x2 | 16 t)**

08.77 - 12.86	F22B5	314 000→	246-075-051-007C	SWP-M-G	Plug Number (T2): 2
---------------	-------	----------	------------------	---------	---------------------

**F 12/320,F 12/330 (235 kW -> 243 kW | Platform / Chassis | 4x2 | 16 t)**

08.77 - 12.86	D14A2, D14A8	314 000→	246-075-051-007C	SWP-M-G	Plug Number (T2): 2
---------------	--------------	----------	------------------	---------	---------------------

**F 12/320,F 12/330 (235 kW -> 243 kW | Platform / Chassis | 6x2 | 22 t)**

08.77 - 12.86	D16Z9, D16Y6	314 000→	246-075-051-007C	SWP-M-G	Plug Number (T2): 2
---------------	--------------	----------	------------------	---------	---------------------

**F 12/320,F 12/330 (235 kW -> 243 kW | Platform / Chassis | 6x4 | 22 t)**

08.77 - 12.86	D15B7	314 000→	246-075-051-007C	SWP-M-G	Plug Number (T2): 2
---------------	-------	----------	------------------	---------	---------------------

**F 12/320,F 12/330 (235 kW -> 243 kW | Truck Tractor | 4x2 | 16 t)**

08.77 - 12.86	VG30E	314 000→	246-075-051-007C	SWP-M-G	Plug Number (T2): 2
---------------	-------	----------	------------------	---------	---------------------

**F 12/320,F 12/330 (235 kW -> 243 kW | Truck Tractor | 6x2 | 22 t)**

08.77 - 12.86	F22B5	314 000→	246-075-051-007C	SWP-M-G	Plug Number (T2): 2
---------------	-------	----------	------------------	---------	---------------------

**F 12/320,F 12/330 (235 kW -> 243 kW | Truck Tractor | 6x4 | 22 t)**

08.77 - 12.86	F20B3	314 000→	246-075-051-007C	SWP-M-G	Plug Number (T2): 2
---------------	-------	----------	------------------	---------	---------------------

**F 12/360 (262 kW | Dump Truck | 4x2 | 17 t)**

01.88 - 12.90	F22A3	314 000→	246-075-051-007C	SWP-M-G	Plug Number (T2): 2
---------------	-------	----------	------------------	---------	---------------------

**F 12/360 (262 kW | Dump Truck | 4x2 | 18 t)**

12.90 - 12.94	GA16DS	314 000→	246-075-051-007C	SWP-M-G	Plug Number (T2): 2
---------------	--------	----------	------------------	---------	---------------------

**F 12/360 (262 kW | Dump Truck | 6x4 | 26 t)**

01.91 - 12.94	D16Z6	314 000→	246-075-051-007C	SWP-M-G	Plug Number (T2): 2
---------------	-------	----------	------------------	---------	---------------------

**F 12/360 (262 kW | Platform / Chassis | 4x2 | 17 t)**

01.88 - 12.90	D16A6	314 000→	246-075-051-007C	SWP-M-G	Plug Number (T2): 2
---------------	-------	----------	------------------	---------	---------------------

**F 12/360 (262 kW | Platform / Chassis | 4x2 | 18 t)**

12.90 - 12.94	F22A3	314 000→	246-075-051-007C	SWP-M-G	Plug Number (T2): 2
---------------	-------	----------	------------------	---------	---------------------

**F 12/360 (262 kW | Platform / Chassis | 6x2 | 24 t)**

01.88 - 12.90	F20A6	314 000→	246-075-051-007C	SWP-M-G	Plug Number (T2): 2
---------------	-------	----------	------------------	---------	---------------------

**F 12/360 (262 kW | Platform / Chassis | 6x2 | 25 t)**

12.90 - 12.94	F20A7	314 000→	246-075-051-007C	SWP-M-G	Plug Number (T2): 2
---------------	-------	----------	------------------	---------	---------------------

**F 12/360 (262 kW | Platform / Chassis | 6x4 | 24 t)**

01.88 - 12.90	LD28	314 000→	246-075-051-007C	SWP-M-G	Plug Number (T2): 2
---------------	------	----------	------------------	---------	---------------------

**F 12/360 (262 kW | Platform / Chassis | 6x4 | 25 t)**

12.90 - 12.94	F22A8	314 000→	246-075-051-007C	SWP-M-G	Plug Number (T2): 2
---------------	-------	----------	------------------	---------	---------------------

**F 12/360 (262 kW | Truck Tractor | 4x2 | 17 t)**

01.88 - 12.90	F20A2, F20A3	314 000→	246-075-051-007C	SWP-M-G	Plug Number (T2): 2
---------------	--------------	----------	------------------	---------	---------------------

**F 12/360 (262 kW | Truck Tractor | 4x2 | 18 t)**

12.90 - 12.94	F22A7	314 000→	246-075-051-007C	SWP-M-G	Plug Number (T2): 2
---------------	-------	----------	------------------	---------	---------------------

**F 12/360 (262 kW | Truck Tractor | 6x2 | 24 t)**

01.88 - 12.90	RD28	314 000→	246-075-051-007C	SWP-M-G	Plug Number (T2): 2
---------------	------	----------	------------------	---------	---------------------

**F 12/360 (262 kW | Truck Tractor | 6x2 | 25 t)**

12.90 - 12.94	D13B2	314 000→	246-075-051-007C	SWP-M-G	Plug Number (T2): 2
---------------	-------	----------	------------------	---------	---------------------

**F 12/360 (262 kW | Truck Tractor | 6x4 | 24 t)**

01.88 - 12.90	F20A4, F20A8	314 000→	246-075-051-007C	SWP-M-G	Plug Number (T2): 2
---------------	--------------	----------	------------------	---------	---------------------

**F 12/360 (262 kW | Truck Tractor | 6x4 | 25 t)**

10.90 - 12.94	D15Z1, D15B2	314 000→	246-075-051-007C	SWP-M-G	Plug Number (T2): 2
---------------	--------------	----------	------------------	---------	---------------------



			<b>VDO</b>		
Date	Engine Code	Chassis No.	Article No.	Product	Information

**VOLVO****F 12****F 12/370 (272 kW | Platform / Chassis | 4x2 | 16 t)**

08.77 - 12.86 | GA16DE | 314 000→ | 246-075-051-007C | SWP-M-G | Plug Number (T2): 2

**F 12/370 (272 kW | Platform / Chassis | 4x2 | 17 t)**

01.87 - 12.87 | L28 | 314 000→ | 246-075-051-007C | SWP-M-G | Plug Number (T2): 2

**F 12/370 (272 kW | Platform / Chassis | 6x2 | 22 t)**

08.77 - 12.86 | Z24i | 314 000→ | 246-075-051-007C | SWP-M-G | Plug Number (T2): 2

**F 12/370 (272 kW | Platform / Chassis | 6x2 | 24 t)**

01.87 - 12.87 | L28 | 314 000→ | 246-075-051-007C | SWP-M-G | Plug Number (T2): 2

**F 12/370 (272 kW | Platform / Chassis | 6x4 | 22 t)**

08.77 - 12.86 | TD25 | 314 000→ | 246-075-051-007C | SWP-M-G | Plug Number (T2): 2

**F 12/370 (272 kW | Platform / Chassis | 6x4 | 24 t)**

01.87 - 12.87 | L28 | 314 000→ | 246-075-051-007C | SWP-M-G | Plug Number (T2): 2

**F 12/370 (272 kW | Truck Tractor | 4x2 | 16 t)**

08.77 - 12.86 | TD27T | 314 000→ | 246-075-051-007C | SWP-M-G | Plug Number (T2): 2

**F 12/370 (272 kW | Truck Tractor | 4x2 | 17 t)**

01.87 - 12.87 | SD33 | 314 000→ | 246-075-051-007C | SWP-M-G | Plug Number (T2): 2

**F 12/370 (272 kW | Truck Tractor | 6x2 | 22 t)**

08.77 - 12.86 | KA24E | 314 000→ | 246-075-051-007C | SWP-M-G | Plug Number (T2): 2

**F 12/370 (272 kW | Truck Tractor | 6x2 | 24 t)**

01.87 - 12.87 | SD33 | 314 000→ | 246-075-051-007C | SWP-M-G | Plug Number (T2): 2

**F 12/370 (272 kW | Truck Tractor | 6x4 | 22 t)**

08.77 - 12.86 | Z24i | 314 000→ | 246-075-051-007C | SWP-M-G | Plug Number (T2): 2

**F 12/370 (272 kW | Truck Tractor | 6x4 | 24 t)**

01.87 - 12.87 | SD33T | 314 000→ | 246-075-051-007C | SWP-M-G | Plug Number (T2): 2

**F 12/400 (291 kW | Platform / Chassis | 4x2 | 17 t)**

01.88 - 12.90 | SR20DI | 314 000→ | 246-075-051-007C | SWP-M-G | Plug Number (T2): 2

**F 12/400 (291 kW | Platform / Chassis | 4x2 | 18 t)**

12.90 - 12.94 | GA16DS | 314 000→ | 246-075-051-007C | SWP-M-G | Plug Number (T2): 2

**F 12/400 (291 kW | Platform / Chassis | 6x2 | 24 t)**

01.88 - 12.90 | B16A2 | 314 000→ | 246-075-051-007C | SWP-M-G | Plug Number (T2): 2

**F 12/400 (291 kW | Platform / Chassis | 6x4 | 24 t)**

01.88 - 12.90 | SR20DE | 314 000→ | 246-075-051-007C | SWP-M-G | Plug Number (T2): 2

**F 12/400 (291 kW | Truck Tractor | 4x2 | 17 t)**

01.88 - 12.90 | CD20 | 314 000→ | 246-075-051-007C | SWP-M-G | Plug Number (T2): 2

**F 12/400 (291 kW | Truck Tractor | 6x2 | 25 t)**

12.90 - 12.94 | D16Z6, D16Z7 | 314 000→ | 246-075-051-007C | SWP-M-G | Plug Number (T2): 2

**F 12/400 (291 kW | Truck Tractor | 6x4 | 24 t)**

01.88 - 12.90 | SR20DI | 314 000→ | 246-075-051-007C | SWP-M-G | Plug Number (T2): 2

**F 12/400,F 12/410 (291 kW -> 298 kW | Platform / Chassis | 6x2 | 25 t)**

12.90 - 12.94 | SR20DI | 314 000→ | 246-075-051-007C | SWP-M-G | Plug Number (T2): 2

**F 12/400,F 12/410 (291 kW -> 298 kW | Platform / Chassis | 6x4 | 25 t)**

12.90 - 12.94 | CD20 | 314 000→ | 246-075-051-007C | SWP-M-G | Plug Number (T2): 2

**F 12/400,F 12/410 (291 kW -> 298 kW | Truck Tractor | 4x2 | 18 t)**

12.90 - 12.94 | D15B2, D15Z1 | 314 000→ | 246-075-051-007C | SWP-M-G | Plug Number (T2): 2

**F 12/400,F 12/410 (291 kW -> 298 kW | Truck Tractor | 6x2 | 24 t)**

01.88 - 12.94 | GA16DS | 314 000→ | 246-075-051-007C | SWP-M-G | Plug Number (T2): 2

**F 12/400,F 12/410 (291 kW -> 298 kW | Truck Tractor | 6x4 | 25 t)**

12.90 - 12.94 | B16A2 | 314 000→ | 246-075-051-007C | SWP-M-G | Plug Number (T2): 2

**F 16****F 16/470 (342 kW | Platform / Chassis | 4x2 | 17 t)**

01.88 - 12.89 | KA24E | 246-075-051-007C | SWP-M-G | Plug Number (T2): 2

**F 16/470 (342 kW | Platform / Chassis | 6x2 | 24 t)**

01.88 - 12.89 | A15 | 246-075-051-007C | SWP-M-G | Plug Number (T2): 2

**F 16/470 (342 kW | Truck Tractor | 4x2 | 17 t)**

01.88 - 12.89 | Z24i | 246-075-051-007C | SWP-M-G | Plug Number (T2): 2

**F 16/470 (342 kW | Truck Tractor | 6x4 | 24 t)**

01.88 - 12.89 | Z24i | 246-075-051-007C | SWP-M-G | Plug Number (T2): 2

**F 16/485 (357 kW | Platform / Chassis | 4x2 | 18 t)**

01.90 - 12.92 | LD20 | 246-075-051-007C | SWP-M-G | Plug Number (T2): 2

**F 16/485 (357 kW | Platform / Chassis | 6x2 | 25 t)**

01.90 - 12.92 | LD20 | 246-075-051-007C | SWP-M-G | Plug Number (T2): 2



			<b>VDO</b>		
Date	Engine Code	Chassis No.	Article No.	Product	Information

**VOLVO****F 16****F 16/485 (357 kW | Platform / Chassis | 6x4 | 25 t)**

01.90 - 12.92 | GA16DE | | 246-075-051-007C | SWP-M-G | Plug Number (T2): 2

**F 16/485 (357 kW | Truck Tractor | 4x2 | 18 t)**

01.90 - 12.92 | SR20DET | | 246-075-051-007C | SWP-M-G | Plug Number (T2): 2

**F 16/485 (357 kW | Truck Tractor | 6x2 | 25 t)**

01.90 - 12.92 | SR20DE | | 246-075-051-007C | SWP-M-G | Plug Number (T2): 2

**F 16/485 (357 kW | Truck Tractor | 6x4 | 25 t)**

01.90 - 12.92 | SR20DE | | 246-075-051-007C | SWP-M-G | Plug Number (T2): 2

**F 16/500 (368 kW | Platform / Chassis | 4x2 | 18 t)**

01.92 - 12.94 | AB 30 | | 246-075-051-007C | SWP-M-G | Plug Number (T2): 2

**F 16/500 (368 kW | Platform / Chassis | 6x2 | 25 t)**

01.92 - 12.94 | AD 10 | | 246-075-051-007C | SWP-M-G | Plug Number (T2): 2

**F 16/500 (368 kW | Platform / Chassis | 6x4 | 26 t)**

01.92 - 12.94 | ED 10 | | 246-075-051-007C | SWP-M-G | Plug Number (T2): 2

**F 16/500 (368 kW | Truck Tractor | 4x2 | 18 t)**

01.92 - 12.94 | ED 10 K | | 246-075-051-007C | SWP-M-G | Plug Number (T2): 2

**F 16/500 (368 kW | Truck Tractor | 6x2 | 24 t)**

01.92 - 12.94 | ED 10 | | 246-075-051-007C | SWP-M-G | Plug Number (T2): 2

**F 16/500 (368 kW | Truck Tractor | 6x4 | 25 t)**

01.92 - 12.94 | CL 10 | | 246-075-051-007C | SWP-M-G | Plug Number (T2): 2

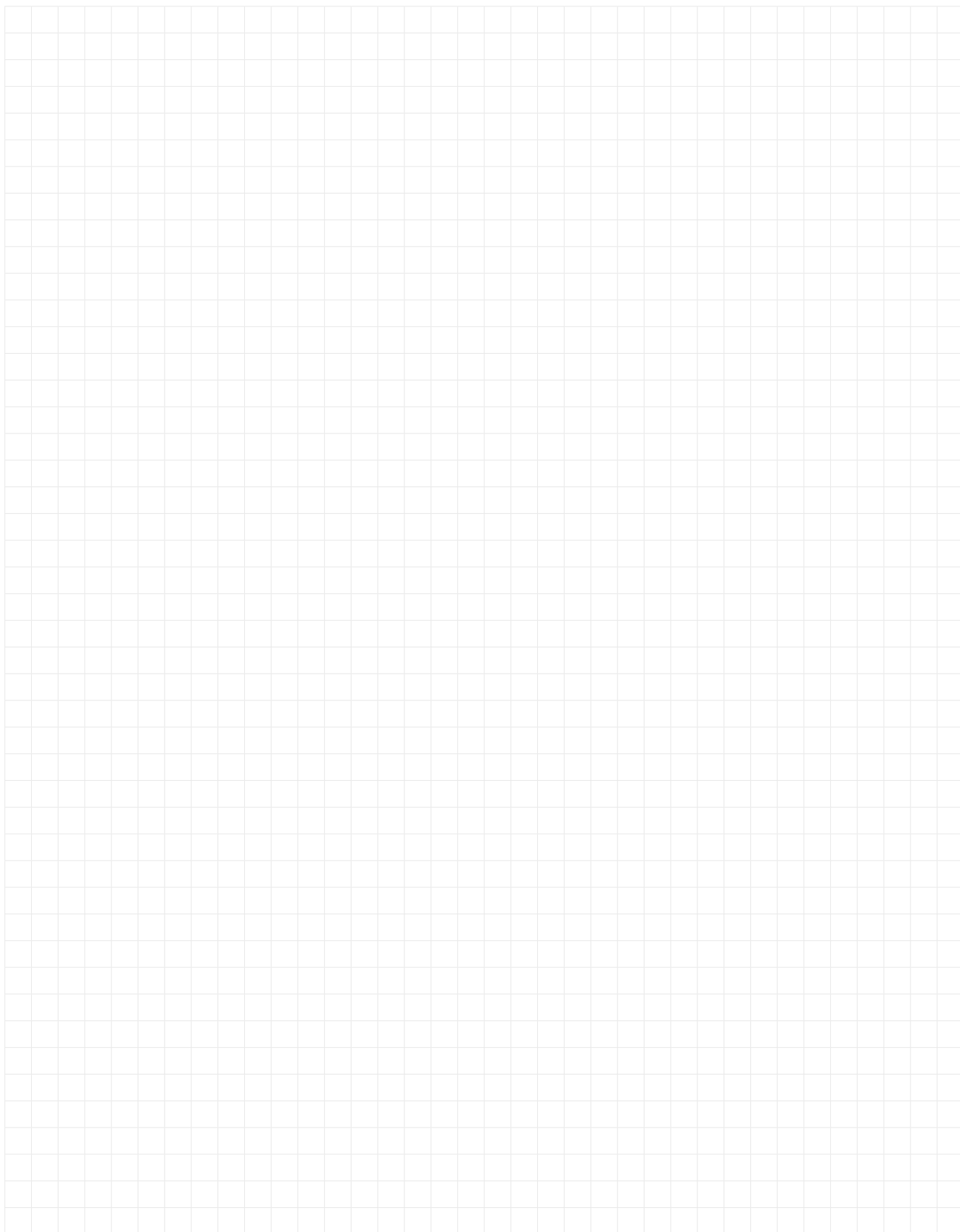



			<b>VDO</b>		
Date	Engine Code	Chassis No.	Article No.	Product	Information

**ALFA ROMEO****145 (930)**

<b>1.4 i.e. (66 kW   1.4 Litre)</b>					
07.94 - 12.96	AR 33501		246-083-001-004C	SWP-D-C	Plug Number (T2): 1
<b>1.4 i.e. 16V T.S. (76 kW   1.4 Litre)</b>					
12.96 - 01.01	AR 33503, AR 38501		246-083-001-004C	SWP-D-C	Plug Number (T2): 1
<b>1.6 i.e. (76 kW   1.6 Litre)</b>					
10.94 - 12.96	AR 33201		246-083-001-004C	SWP-D-C	Plug Number (T2): 1
<b>1.6 i.e. 16V T.S. (88 kW   1.6 Litre)</b>					
12.96 - 01.01	AR 67601, AR 38201		246-083-001-004C	SWP-D-C	Plug Number (T2): 1
<b>1.7 i.e. 16V (95 kW   1.7 Litre)</b>					
10.94 - 12.96	AR 33401		246-083-001-004C	SWP-D-C	Plug Number (T2): 1
<b>1.8 i.e. 16V (106 kW   1.8 Litre)</b>					
03.98 - 01.01	AR 32201		246-083-001-004C	SWP-D-C	Plug Number (T2): 1
<b>1.8 i.e. 16V T.S. (103 kW   1.8 Litre)</b>					
12.96 - 12.98	AR 67106, AR 38401		246-083-001-004C	SWP-D-C	Plug Number (T2): 1
<b>1.9 JTD (77 kW   1.9 Litre)</b>					
02.99 - 01.01	AR 32302		246-083-001-004C	SWP-D-C	Plug Number (T2): 1
<b>1.9 TD (66 kW   1.9 Litre)</b>					
10.94 - 02.99	AR 67501, AR 33601		246-083-001-004C	SWP-D-C	Plug Number (T2): 1
<b>2.0 16V Quadrifoglio (114 kW   2.0 Litre)</b>					
03.98 - 01.01	AR 32301		246-083-001-004C	SWP-D-C	Plug Number (T2): 1
<b>2.0 16V T.S. (110 kW   2.0 Litre)</b>					
10.95 - 01.01	AR 67204		246-083-001-004C	SWP-D-C	Plug Number (T2): 1

**146 (930)**

<b>1.4 i.e. (66 kW   1.4 Litre)</b>					
12.94 - 12.96	8140.43S		246-082-008-014C	SWP-M-C	Plug Number (T2): 1
12.94 - 12.96	AR 33501		246-083-001-004C	SWP-D-C	Plug Number (T2): 1
<b>1.4 i.e. 16V T.S. (76 kW   1.4 Litre)</b>					
11.96 - 01.01	8140.43S		246-082-008-014C	SWP-M-C	Plug Number (T2): 1
12.97 - 01.01	AR 33503, AR 38501		246-083-001-004C	SWP-D-C	Plug Number (T2): 1; Vehicle Equipment (T31): with rear-window wiper (T34)
<b>1.6 i.e. (76 kW   1.6 Litre)</b>					
12.94 - 12.96	8140.43S		246-082-008-014C	SWP-M-C	Plug Number (T2): 1
12.94 - 12.96	AR 33201		246-083-001-004C	SWP-D-C	Plug Number (T2): 1
<b>1.6 i.e. 16V T.S. (88 kW   1.6 Litre)</b>					
11.96 - 01.01	8140.43S		246-082-008-014C	SWP-M-C	Plug Number (T2): 1
12.97 - 01.01	AR 67601, AR 38201		246-083-001-004C	SWP-D-C	Plug Number (T2): 1; Vehicle Equipment (T31): with rear-window wiper (T34)
<b>1.7 i.e. 16V (95 kW   1.7 Litre)</b>					
12.94 - 12.96	8140.43S		246-082-008-014C	SWP-M-C	Plug Number (T2): 1
12.94 - 12.96	AR 33401		246-083-001-004C	SWP-D-C	Plug Number (T2): 1
<b>1.8 i.e. 16V T.S. (103 kW   1.8 Litre)</b>					
11.96 - 01.01	8140.43S		246-082-008-014C	SWP-M-C	Plug Number (T2): 1
12.97 - 01.01	AR 67106, AR 38401		246-083-001-004C	SWP-D-C	Plug Number (T2): 1; Vehicle Equipment (T31): with rear-window wiper (T34)
<b>1.8 i.e. 16V T.S. (106 kW   1.8 Litre)</b>					
03.98 - 01.01	8140.43S		246-082-008-014C	SWP-M-C	Plug Number (T2): 1
03.98 - 01.01	AR 32201		246-083-001-004C	SWP-D-C	Plug Number (T2): 1; Vehicle Equipment (T31): with rear-window wiper (T34)
<b>1.9 D (68 kW   1.9 Litre)</b>					
05.95 - 09.96	8140.43S		246-082-008-014C	SWP-M-C	Plug Number (T2): 1
<b>1.9 JTD (77 kW   1.9 Litre)</b>					
02.99 - 01.01	AR 32302		246-082-008-014C	SWP-M-C	Plug Number (T2): 1
02.99 - 01.01	AR 32302		246-083-001-004C	SWP-D-C	Plug Number (T2): 1; Vehicle Equipment (T31): with rear-window wiper (T34)
<b>1.9 TD (66 kW   1.9 Litre)</b>					
12.94 - 02.99	8140.43S		246-082-008-014C	SWP-M-C	Plug Number (T2): 1
12.97 - 02.99	AR 67501, AR 33601		246-083-001-004C	SWP-D-C	Plug Number (T2): 1; Vehicle Equipment (T31): with rear-window wiper (T34)
<b>2.0 16V Quadrifoglio (114 kW   2.0 Litre)</b>					
03.98 - 01.01	8140.43S		246-082-008-014C	SWP-M-C	Plug Number (T2): 1
03.98 - 01.01	AR 32301		246-083-001-004C	SWP-D-C	Plug Number (T2): 1; Vehicle Equipment (T31): with rear-window wiper (T34)



			<b>VDO</b>		
Date	Engine Code	Chassis No.	Article No.	Product	Information

**ALFA ROMEO****146 (930)****2.0 16V T.S. (110 kW | 2.0 Litre)**

10.95 - 01.01	8140.43S		246-082-008-014C	SWP-M-C	Plug Number (T2): 1
12.97 - 01.01	AR 67204		246-083-001-004C	SWP-D-C	Plug Number (T2): 1; Vehicle Equipment (T31): with rear-window wiper (T34)

**147 (937)****1.6 16V T.SPARK (937AXB1A) (88 kW | 1.6 Litre)**

01.01 -	AR 32104		246-083-001-004C	SWP-D-C	Plug Number (T2): 1
---------	----------	--	------------------	---------	---------------------

**1.6 16V T.SPARK ECO (937AXA1A) (77 kW | 1.6 Litre)**

01.01 -	AR 37203		246-083-001-004C	SWP-D-C	Plug Number (T2): 1
---------	----------	--	------------------	---------	---------------------

**1.9 JTD (74 kW | 1.9 Litre)**

06.03 -	182 B9.000		246-083-001-004C	SWP-D-C	Plug Number (T2): 1
---------	------------	--	------------------	---------	---------------------

**1.9 JTD (937AXD1A) (85 kW | 1.9 Litre)**

04.01 -	937 A2.000		246-083-001-004C	SWP-D-C	Plug Number (T2): 1
---------	------------	--	------------------	---------	---------------------

**1.9 JTD 16V (103 kW | 1.9 Litre)**

11.02 -	192 A5.000		246-083-001-004C	SWP-D-C	Plug Number (T2): 1
---------	------------	--	------------------	---------	---------------------

**1.9 JTDM 16V (110 kW | 1.9 Litre)**

07.05 -	937 A5.000		246-083-001-004C	SWP-D-C	Plug Number (T2): 1
---------	------------	--	------------------	---------	---------------------

**1.9 JTDM 8V (88 kW | 1.9 Litre)**

07.05 -	937 A3.000		246-083-001-004C	SWP-D-C	Plug Number (T2): 1
---------	------------	--	------------------	---------	---------------------

**2.0 16V T.SPARK (937AXC1\_) (110 kW | 2.0 Litre)**

01.01 -	AR 32310		246-083-001-004C	SWP-D-C	Plug Number (T2): 1
---------	----------	--	------------------	---------	---------------------

**3.2 GTA (184 kW | 3.2 Litre)**

02.03 -	932 A.000		246-083-001-004C	SWP-D-C	Plug Number (T2): 1
---------	-----------	--	------------------	---------	---------------------

**155 (167)****1.6 16V T.S. (88 kW | 1.6 Litre)**

05.96 - 12.97	8140.43S		246-082-008-014C	SWP-M-C	Plug Number (T2): 1
---------------	----------	--	------------------	---------	---------------------

**1.7 T.S. (167.A4D, 167.A4H) (85 kW | 1.7 Litre)**

04.93 - 04.96	AR 67105		246-082-008-014C	SWP-M-C	Plug Number (T2): 1
---------------	----------	--	------------------	---------	---------------------

**1.7 T.S. (83 kW | 1.7 Litre)**

04.93 - 04.96	8140.43S		246-082-008-014C	SWP-M-C	Plug Number (T2): 1
---------------	----------	--	------------------	---------	---------------------

**1.7 T.S. 16V (103 kW | 1.7 Litre)**

05.96 - 12.97	8140.43S		246-082-008-014C	SWP-M-C	Plug Number (T2): 1
---------------	----------	--	------------------	---------	---------------------

**1.8 T.S. (77 kW | 1.8 Litre)**

02.92 - 12.97	AR 67402		246-082-008-014C	SWP-M-C	Plug Number (T2): 1
---------------	----------	--	------------------	---------	---------------------

**1.8 T.S. (95 kW | 1.8 Litre)**

02.92 - 06.93	AR 67101		246-082-008-014C	SWP-M-C	Plug Number (T2): 1
---------------	----------	--	------------------	---------	---------------------

**1.8 T.S. Sport (167.A4A, 167.A4C, 167.A4E) (93 kW | 1.8 Litre)**

01.92 - 12.96	AR 67101, AR 67102		246-082-008-014C	SWP-M-C	Plug Number (T2): 1
---------------	--------------------	--	------------------	---------	---------------------

**1.9 TD (167.A3) (66 kW | 1.9 Litre)**

04.93 - 12.97	AR 67501, HB		246-082-008-014C	SWP-M-C	Plug Number (T2): 1
---------------	--------------	--	------------------	---------	---------------------

**2.0 16V Turbo Q4 (140 kW | 2.0 Litre)**

01.92 - 12.97	AR 67203		246-082-008-014C	SWP-M-C	Plug Number (T2): 1
---------------	----------	--	------------------	---------	---------------------

**2.0 16V Turbo Q4 (167.A2B, 167.A2C, 167.A2E) (137 kW | 2.0 Litre)**

01.92 - 12.97	AR 67203		246-082-008-014C	SWP-M-C	Plug Number (T2): 1
---------------	----------	--	------------------	---------	---------------------

**2.0 T.S. (167.A2) (106 kW | 2.0 Litre)**

02.92 - 04.93	AR 67201, HH		246-082-008-014C	SWP-M-C	Plug Number (T2): 1
---------------	--------------	--	------------------	---------	---------------------

**2.0 T.S. (167.A2A) (104 kW | 2.0 Litre)**

02.92 - 02.95	AR 67202, HC		246-082-008-014C	SWP-M-C	Plug Number (T2): 1
---------------	--------------	--	------------------	---------	---------------------

**2.0 T.S. 16V (167.A2G) (110 kW | 2.0 Litre)**

03.95 - 12.97	8140.43S		246-082-008-014C	SWP-M-C	Plug Number (T2): 1
---------------	----------	--	------------------	---------	---------------------

**2.5 TD (167.A1A) (92 kW | 2.5 Litre)**

04.93 - 12.97	VM 07 B, VM 31 B		246-082-008-014C	SWP-M-C	Plug Number (T2): 1
---------------	------------------	--	------------------	---------	---------------------

**2.5 V6 (167.A1) (121 kW | 2.5 Litre)**

02.92 - 09.96	AR 67301		246-082-008-014C	SWP-M-C	Plug Number (T2): 1
---------------	----------	--	------------------	---------	---------------------

**2.5 V6 (167.A1C, 167.A1E) (120 kW | 2.5 Litre)**

10.92 - 12.97	AR 67302, AR 67303		246-082-008-014C	SWP-M-C	Plug Number (T2): 1
---------------	--------------------	--	------------------	---------	---------------------

**156 (932)****1.6 16V T.SPARK (932A4) (88 kW | 1.6 Litre)**

09.97 - 09.05	8140.43S		246-082-008-014C	SWP-M-C	Plug Number (T2): 1
---------------	----------	--	------------------	---------	---------------------



			<b>VDO</b>		
Date	Engine Code	Chassis No.	Article No.	Product	Information

**ALFA ROMEO****156 (932)****1.6 16V T.SPARK (932A4) (88 kW | 1.6 Litre)**

09.97 - 09.05	AR 67601, AR 32102, AR 32104, AR 32103		246-083-001-004C	SWP-D-C	Plug Number (T2): 1
---------------	----------------------------------------	--	------------------	---------	---------------------

**1.8 16V T.SPARK (932A3) (106 kW | 1.8 Litre)**

09.97 - 10.00	8140.43S		246-082-008-014C	SWP-M-C	Plug Number (T2): 1
09.97 - 10.00	AR 32201		246-083-001-004C	SWP-D-C	Plug Number (T2): 1

**1.8 16V T.SPARK (932A31\_) (103 kW | 1.8 Litre)**

10.00 - 09.05	AR 32205		246-082-008-014C	SWP-M-C	Plug Number (T2): 1
10.00 - 09.05	AR 32205		246-083-001-004C	SWP-D-C	Plug Number (T2): 1

**1.9 JTD (100 kW | 1.9 Litre)**

11.02 - 11.04	8140.43S		246-082-008-014C	SWP-M-C	Plug Number (T2): 1
---------------	----------	--	------------------	---------	---------------------

**1.9 JTD (110 kW | 1.9 Litre)**

07.04 - 09.05	8140.43S		246-082-008-014C	SWP-M-C	Plug Number (T2): 1
---------------	----------	--	------------------	---------	---------------------

**1.9 JTD (93 kW | 1.9 Litre)**

11.03 - 09.05	8140.43S		246-082-008-014C	SWP-M-C	Plug Number (T2): 1
---------------	----------	--	------------------	---------	---------------------

**1.9 JTD (932A2B, 932A2C) (85 kW | 1.9 Litre)**

05.01 - 09.05	8140.43S		246-082-008-014C	SWP-M-C	Plug Number (T2): 1
05.01 - 09.05	937 A2.000		246-083-001-004C	SWP-D-C	Plug Number (T2): 1

**1.9 JTD (932A2B\_) (81 kW | 1.9 Litre)**

10.00 - 05.01	AR 37101		246-082-008-014C	SWP-M-C	Plug Number (T2): 1
10.00 - 05.01	AR 37101		246-083-001-004C	SWP-D-C	Plug Number (T2): 1

**1.9 JTD (932B2) (77 kW | 1.9 Litre)**

09.97 - 10.00	8140.43S		246-082-008-014C	SWP-M-C	Plug Number (T2): 1
09.97 - 10.00	AR 32302		246-083-001-004C	SWP-D-C	Plug Number (T2): 1

**1.9 JTD 16V (103 kW | 1.9 Litre)**

11.02 - 09.05	8140.43S		246-082-008-014C	SWP-M-C	Plug Number (T2): 1
11.02 - 09.05	192 A5.000		246-083-001-004C	SWP-D-C	Plug Number (T2): 1

**2.0 16V T.SPARK (932A2) (114 kW | 2.0 Litre)**

09.97 - 10.00	8140.43S		246-082-008-014C	SWP-M-C	Plug Number (T2): 1
09.97 - 10.00	AR 32301		246-083-001-004C	SWP-D-C	Plug Number (T2): 1

**2.0 16V T.SPARK (932A21\_) (110 kW | 2.0 Litre)**

10.00 - 03.02	AR 32310		246-082-008-014C	SWP-M-C	Plug Number (T2): 1
10.00 - 03.02	AR 32310		246-083-001-004C	SWP-D-C	Plug Number (T2): 1

**2.0 JTS (932AXA) (122 kW | 2.0 Litre)**

03.02 - 09.05	8140.43S		246-082-008-014C	SWP-M-C	Plug Number (T2): 1
03.02 - 09.05	937 A1.000		246-083-001-004C	SWP-D-C	Plug Number (T2): 1

**2.0 Twin Spark (118 kW | 2.0 Litre)**

11.97 - 04.00	8140.43S		246-082-008-014C	SWP-M-C	Plug Number (T2): 1
---------------	----------	--	------------------	---------	---------------------

**2.4 JTD (120 kW | 2.4 Litre)**

06.03 - 09.05	8140.43S		246-082-008-014C	SWP-M-C	Plug Number (T2): 1
---------------	----------	--	------------------	---------	---------------------

**2.4 JTD (129 kW | 2.4 Litre)**

10.03 - 09.05	8140.43S		246-082-008-014C	SWP-M-C	Plug Number (T2): 1
10.03 - 09.05	841 G.000		246-083-001-004C	SWP-D-C	Plug Number (T2): 1

**2.4 JTD (932A1B\_) (103 kW | 2.4 Litre)**

10.00 - 09.05	839 A6.000		246-082-008-014C	SWP-M-C	Plug Number (T2): 1
10.00 - 09.05	839 A6.000		246-083-001-004C	SWP-D-C	Plug Number (T2): 1

**2.4 JTD (932AXC) (110 kW | 2.4 Litre)**

03.02 - 09.05	8140.43S		246-082-008-014C	SWP-M-C	Plug Number (T2): 1
03.02 - 09.05	841 C000		246-083-001-004C	SWP-D-C	Plug Number (T2): 1

**2.4 JTD (932B1) (100 kW | 2.4 Litre)**

09.97 - 10.00	8140.43S		246-082-008-014C	SWP-M-C	Plug Number (T2): 1
09.97 - 10.00	AR 32501		246-083-001-004C	SWP-D-C	Plug Number (T2): 1

**2.5 V6 24V (932A1) (140 kW | 2.5 Litre)**

09.97 - 12.01	8140.43S		246-082-008-014C	SWP-M-C	Plug Number (T2): 1
09.97 - 12.01	AR 32401, AR 32402		246-083-001-004C	SWP-D-C	Plug Number (T2): 1

**2.5 V6 24V (932A11\_) (141 kW | 2.5 Litre)**

10.00 - 09.05	AR 32405		246-082-008-014C	SWP-M-C	Plug Number (T2): 1
10.00 - 09.05	AR 32405		246-083-001-004C	SWP-D-C	Plug Number (T2): 1

**3.2 GTA (932AXB) (184 kW | 3.2 Litre)**

03.02 - 09.05	8140.43S		246-082-008-014C	SWP-M-C	Plug Number (T2): 1
03.02 - 09.05	932 A.000		246-083-001-004C	SWP-D-C	Plug Number (T2): 1





			<b>VDO</b>		
Date	Engine Code	Chassis No.	Article No.	Product	Information

**ALFA ROMEO****156 Sportwagon (932)****1.6 16V T.SPARK. (932A4) (88 kW | 1.6 Litre)**

05.00 - 05.06	AR 32102, AR 32103, AR 32104, AR 67601		246-082-008-014C	SWP-M-C	Plug Number (T2): 1
05.00 - 05.06	AR 32102, AR 67601, AR 32104, AR 32103		246-083-001-004C	SWP-D-C	Plug Number (T2): 1

**1.8 16V T.SPARK (932A3) (106 kW | 1.8 Litre)**

05.00 - 10.00	AR 32201		246-082-008-014C	SWP-M-C	Plug Number (T2): 1
05.00 - 10.00	AR 32201		246-083-001-004C	SWP-D-C	Plug Number (T2): 1

**1.8 16V T.SPARK (932B31\_) (103 kW | 1.8 Litre)**

10.00 - 05.06	AR 32205		246-082-008-014C	SWP-M-C	Plug Number (T2): 1
10.00 - 05.06	AR 32205		246-083-001-004C	SWP-D-C	Plug Number (T2): 1

**1.9 JTD (100 kW | 1.9 Litre)**

11.02 - 11.04	8140.43S		246-082-008-014C	SWP-M-C	Plug Number (T2): 1
---------------	----------	--	------------------	---------	---------------------

**1.9 JTD (93 kW | 1.9 Litre)**

11.03 - 05.06	8140.43S		246-082-008-014C	SWP-M-C	Plug Number (T2): 1
---------------	----------	--	------------------	---------	---------------------

**1.9 JTD (932B2) (77 kW | 1.9 Litre)**

05.00 - 10.00	AR 32302		246-082-008-014C	SWP-M-C	Plug Number (T2): 1
05.00 - 10.00	AR 32302		246-083-001-004C	SWP-D-C	Plug Number (T2): 1

**1.9 JTD (932B2B, 932B2C) (85 kW | 1.9 Litre)**

05.01 - 05.06	8140.43S		246-082-008-014C	SWP-M-C	Plug Number (T2): 1
05.01 - 05.06	937 A2.000		246-083-001-004C	SWP-D-C	Plug Number (T2): 1

**1.9 JTD (932B2B\_) (81 kW | 1.9 Litre)**

10.00 - 05.01	AR 37101		246-082-008-014C	SWP-M-C	Plug Number (T2): 1
10.00 - 05.01	AR 37101		246-083-001-004C	SWP-D-C	Plug Number (T2): 1

**1.9 JTD 16V (103 kW | 1.9 Litre)**

11.02 - 05.06	8140.43S		246-082-008-014C	SWP-M-C	Plug Number (T2): 1
11.02 - 05.06	192 A5.000		246-083-001-004C	SWP-D-C	Plug Number (T2): 1

**1.9 JTD 16V Q4 (110 kW | 1.9 Litre)**

07.04 - 05.06	8140.43S		246-082-008-014C	SWP-M-C	Plug Number (T2): 1
07.04 - 05.06	937 A5.000		246-083-001-004C	SWP-D-C	Plug Number (T2): 1

**2.0 (119 kW | 2.0 Litre)**

03.02 - 05.06	8140.43S		246-082-008-014C	SWP-M-C	Plug Number (T2): 1
---------------	----------	--	------------------	---------	---------------------

**2.0 16V T.SPARK (932A2) (114 kW | 2.0 Litre)**

05.00 - 10.00	AR 32301		246-082-008-014C	SWP-M-C	Plug Number (T2): 1
05.00 - 10.00	AR 32301		246-083-001-004C	SWP-D-C	Plug Number (T2): 1

**2.0 16V T.SPARK (932B21\_) (110 kW | 2.0 Litre)**

10.00 - 03.02	AR 32310		246-082-008-014C	SWP-M-C	Plug Number (T2): 1
10.00 - 03.02	AR 32310		246-083-001-004C	SWP-D-C	Plug Number (T2): 1

**2.0 JTS (932BXA) (122 kW | 2.0 Litre)**

03.02 - 05.06	8140.43S		246-082-008-014C	SWP-M-C	Plug Number (T2): 1
03.02 - 05.06	937 A1.000		246-083-001-004C	SWP-D-C	Plug Number (T2): 1

**2.4 JTD (120 kW | 2.4 Litre)**

06.03 - 05.06	8140.43S		246-082-008-014C	SWP-M-C	Plug Number (T2): 1
---------------	----------	--	------------------	---------	---------------------

**2.4 JTD (129 kW | 2.4 Litre)**

10.03 - 05.06	8140.43S		246-082-008-014C	SWP-M-C	Plug Number (T2): 1
10.03 - 05.06	841 G.000		246-083-001-004C	SWP-D-C	Plug Number (T2): 1

**2.4 JTD (932B1) (100 kW | 2.4 Litre)**

05.00 - 10.00	AR 32501		246-082-008-014C	SWP-M-C	Plug Number (T2): 1
05.00 - 10.00	AR 32501		246-083-001-004C	SWP-D-C	Plug Number (T2): 1

**2.4 JTD (932B1B\_) (103 kW | 2.4 Litre)**

10.00 - 05.06	839 A6.000		246-082-008-014C	SWP-M-C	Plug Number (T2): 1
10.00 - 05.06	839 A6.000		246-083-001-004C	SWP-D-C	Plug Number (T2): 1

**2.4 JTD (932BXC) (110 kW | 2.4 Litre)**

03.02 - 05.06	8140.43S		246-082-008-014C	SWP-M-C	Plug Number (T2): 1
03.02 - 05.06	841 C000		246-083-001-004C	SWP-D-C	Plug Number (T2): 1

**2.5 V6 24V (932A1) (140 kW | 2.5 Litre)**

05.00 - 10.00	AR 32401		246-082-008-014C	SWP-M-C	Plug Number (T2): 1
05.00 - 10.00	AR 32401		246-083-001-004C	SWP-D-C	Plug Number (T2): 1

**2.5 V6 24V (932B11\_) (141 kW | 2.5 Litre)**

10.00 - 05.06	AR 32405		246-082-008-014C	SWP-M-C	Plug Number (T2): 1
10.00 - 05.06	AR 32405		246-083-001-004C	SWP-D-C	Plug Number (T2): 1

**3.2 GTA (932BXC) (184 kW | 3.2 Litre)**

03.02 - 05.06	8140.43S		246-082-008-014C	SWP-M-C	Plug Number (T2): 1
---------------	----------	--	------------------	---------	---------------------



			<b>VDO</b>		
Date	Engine Code	Chassis No.	Article No.	Product	Information

**ALFA ROMEO****156 Sportwagon (932)****3.2 GTA (932BXB) (184 kW | 3.2 Litre)**

03.02 - 05.06	932 A.000		246-083-001-004C	SWP-D-C	Plug Number (T2): 1
---------------	-----------	--	------------------	---------	---------------------

**GT (937)****1.8 TS (103 kW | 1.8 Litre)**

11.03 - 09.10	8140.43S		246-082-008-014C	SWP-M-C	Plug Number (T2): 1
---------------	----------	--	------------------	---------	---------------------

**1.9 JTD (110 kW | 1.9 Litre)**

11.03 - 09.10	8140.43S		246-082-008-014C	SWP-M-C	Plug Number (T2): 1
---------------	----------	--	------------------	---------	---------------------

**2.0 JTS (121 kW | 2.0 Litre)**

11.03 - 09.10	8140.43S		246-082-008-014C	SWP-M-C	Plug Number (T2): 1
---------------	----------	--	------------------	---------	---------------------

**3.2 GTA (176 kW | 3.2 Litre)**

11.03 - 09.10	8140.43S		246-082-008-014C	SWP-M-C	Plug Number (T2): 1
---------------	----------	--	------------------	---------	---------------------

**GTV (916C\_)****1.8 16V (916C3) (106 kW | 1.8 Litre)**

05.98 - 10.05	8140.43S		246-082-008-014C	SWP-M-C	Plug Number (T2): 1
---------------	----------	--	------------------	---------	---------------------

**2.0 JTS (121 kW | 2.0 Litre)**

04.03 - 10.05	8140.43S		246-082-008-014C	SWP-M-C	Plug Number (T2): 1
---------------	----------	--	------------------	---------	---------------------

**2.0 T.SPARK 16V (916.C2\_, 916C2C00) (110 kW | 2.0 Litre)**

06.95 - 10.05	8140.43S		246-082-008-014C	SWP-M-C	Plug Number (T2): 1
---------------	----------	--	------------------	---------	---------------------

**2.0 T.SPARK 16V (916C2C) (114 kW | 2.0 Litre)**

05.98 - 08.00	8140.43S		246-082-008-014C	SWP-M-C	Plug Number (T2): 1
---------------	----------	--	------------------	---------	---------------------

**2.0 V6 Turbo (916.C2A) (148 kW | 2.0 Litre)**

06.95 - 09.98	8140.43S		246-082-008-014C	SWP-M-C	Plug Number (T2): 1
---------------	----------	--	------------------	---------	---------------------

**3.0 V6 24V (916.C1) (162 kW | 3.0 Litre)**

10.96 - 10.00	8140.43S		246-082-008-014C	SWP-M-C	Plug Number (T2): 1
---------------	----------	--	------------------	---------	---------------------

**3.0 V6 24V (916.C1B\_) (160 kW | 3.0 Litre)**

10.00 - 10.05	AR 16105		246-082-008-014C	SWP-M-C	Plug Number (T2): 1
---------------	----------	--	------------------	---------	---------------------

**3.2 V6 24V (176 kW | 3.2 Litre)**

04.03 - 10.05	8140.43S		246-082-008-014C	SWP-M-C	Plug Number (T2): 1
---------------	----------	--	------------------	---------	---------------------

**SPIDER (916S\_)****1.8 16V (916S3) (106 kW | 1.8 Litre)**

05.98 - 04.05	8140.43S		246-082-008-014C	SWP-M-C	Plug Number (T2): 1
---------------	----------	--	------------------	---------	---------------------

**2.0 JTS (121 kW | 2.0 Litre)**

04.03 - 04.05	8140.43S		246-082-008-014C	SWP-M-C	Plug Number (T2): 1
---------------	----------	--	------------------	---------	---------------------

**2.0 T.SPARK 16V (916S2B) (114 kW | 2.0 Litre)**

05.98 - 08.00	8140.43S		246-082-008-014C	SWP-M-C	Plug Number (T2): 1
---------------	----------	--	------------------	---------	---------------------

**2.0 V6 Turbo (916S2A) (148 kW | 2.0 Litre)**

05.98 - 04.05	8140.43S		246-082-008-014C	SWP-M-C	Plug Number (T2): 1
---------------	----------	--	------------------	---------	---------------------

**3.0 V6 (916S1B00) (160 kW | 3.0 Litre)**

10.00 - 04.05	AR 16105		246-082-008-014C	SWP-M-C	Plug Number (T2): 1
---------------	----------	--	------------------	---------	---------------------

**3.0 V6 24V (162 kW | 3.0 Litre)**

01.99 - 10.00	AR 16102		246-082-008-014C	SWP-M-C	Plug Number (T2): 1
---------------	----------	--	------------------	---------	---------------------

**3.2 V6 24V (176 kW | 3.2 Litre)**

04.03 - 04.05	8140.43S		246-082-008-014C	SWP-M-C	Plug Number (T2): 1
---------------	----------	--	------------------	---------	---------------------

**ALPINA****B7 Coupe (E24)****3.5 (235 kW | 3.5 Litre)**

10.86 - 06.88			246-075-021-006C	SWP-M-G	Plug Number (T2): 1
---------------	--	--	------------------	---------	---------------------

**3.5 (243 kW | 3.5 Litre)**

05.82 - 08.87			246-075-021-006C	SWP-M-G	Plug Number (T2): 1
---------------	--	--	------------------	---------	---------------------



			<b>VDO</b>		
Date	Engine Code	Chassis No.	Article No.	Product	Information

**AUDI****A1 (8X1)****1.2 TFSI (63 kW | 1.2 Litre)**

05.10 - CBZA 246-083-002-022G SWP-D-C

**1.4 TFSI (90 kW | 1.4 Litre)**

05.10 - CAXA 246-083-002-022G SWP-D-C

**1.6 TDI (77 kW | 1.6 Litre)**

05.10 - CAYC 246-083-002-022G SWP-D-C

**A2 (8Z0)****1.2 TDI (45 kW | 1.2 Litre)**

04.01 - 08.05 ANY 246-082-008-025G SWP-M-C

03.01 - 08.05 ANY 246-086-001-007C HLWP Plug Number (T2): 3b; T26: X11-246-003-014

**1.4 (55 kW | 1.4 Litre)**

02.00 - 08.05 AUA, BBY 246-082-008-025G SWP-M-C T26: 1J0 955 665 H

02.00 - 08.05 AUA, BBY 246-086-001-007C HLWP Plug Number (T2): 3b; T26: X11-246-003-014

**1.4 TDI (55 kW | 1.4 Litre)**

02.00 - 08.05 BHC 246-082-008-025G SWP-M-C

02.00 - 08.05 AMF, BHC 246-086-001-007C HLWP Plug Number (T2): 3b; T26: X11-246-003-014

**1.4 TDI (66 kW | 1.4 Litre)**

11.03 - 08.05 ATL 246-082-008-025G SWP-M-C

11.03 - 08.05 ATL 246-086-001-007C HLWP Plug Number (T2): 3b

**1.6 FSI (81 kW | 1.6 Litre)**

05.02 - 08.05 BAD 246-082-008-025G SWP-M-C

05.02 - 08.05 BAD 246-086-001-007C HLWP Plug Number (T2): 3b; T26: X11-246-003-014

**A3 (8L1)****1.6 (74 kW | 1.6 Litre)**

09.96 - 07.98 AEH, AKL, APF 246-083-002-022G SWP-D-C

09.96 - 07.98 AEH, AKL, APF 246-086-001-002C HLWP Plug Number (T2): 3

09.96 - 08.00 AEH, AKL, APF 246-086-001-007C HLWP Plug Number (T2): 3b; T26: X11-246-003-014

**1.6 (75 kW | 1.6 Litre)**

08.00 - AVU, BFQ 246-083-002-022G SWP-D-C

08.00 - AVU, BFQ 246-086-001-007C HLWP Plug Number (T2): 3b; T26: X11-246-003-014

**1.8 (92 kW | 1.8 Litre)**

09.96 - 07.98 AGN, APG 246-083-002-022G SWP-D-C

09.96 - 07.98 AGN, APG 246-086-001-002C HLWP Plug Number (T2): 3

09.96 - AGN, APG 246-086-001-007C HLWP Plug Number (T2): 3b; T26: X11-246-003-014

**1.8 T (110 kW | 1.8 Litre)**

12.96 - 12.96 AGU, AQA, ARZ, AUM 246-083-002-022G SWP-D-C

12.96 - 05.99 AGU, AQA, ARZ, AUM 246-086-001-002C HLWP Plug Number (T2): 3

12.96 - AGU, AQA, ARZ, AUM 246-086-001-007C HLWP Plug Number (T2): 3b; T26: X11-246-003-014

**1.8 T (132 kW | 1.8 Litre)**

12.98 - AJQ, APP, ARY, AUQ 246-086-001-002C HLWP Plug Number (T2): 3

12.98 - AJQ, APP, ARY, AUQ 246-086-001-007C HLWP Plug Number (T2): 3b; T26: X11-246-003-014

**1.8 T quattro (110 kW | 1.8 Litre)**

07.98 - AGU, AQA, ARX 246-083-002-022G SWP-D-C

08.97 - 07.98 AGU, AQA, ARX 246-086-001-002C HLWP Plug Number (T2): 3

12.96 - AGU, AQA, ARX 246-086-001-007C HLWP Plug Number (T2): 3b; T26: X11-246-003-014

**1.8 T quattro (132 kW | 1.8 Litre)**

10.98 - ARY 246-083-002-022G SWP-D-C

11.98 - AJQ, ARY 246-086-001-002C HLWP Plug Number (T2): 3

10.98 - AJQ, ARY 246-086-001-007C HLWP Plug Number (T2): 3b; T26: X11-246-003-014

**1.9 TDI (66 kW | 1.9 Litre)**

09.96 - 07.01 AGR, ALH 246-083-002-022G SWP-D-C

09.96 - 08.99 AGR, ALH 246-086-001-002C HLWP Plug Number (T2): 3

09.96 - 07.01 AGR, ALH 246-086-001-007C HLWP Plug Number (T2): 3b; T26: X11-246-003-014

**1.9 TDI (74 kW | 1.9 Litre)**

10.00 - AXR 246-083-002-022G SWP-D-C

10.00 - ATD, AXR 246-086-001-007C HLWP Plug Number (T2): 3b; T26: X11-246-003-014

**1.9 TDI (81 kW | 1.9 Litre)**

08.97 - 07.01 AHF, ASV 246-083-002-022G SWP-D-C

08.97 - 07.98 AHF, ASV 246-086-001-002C HLWP Plug Number (T2): 3

08.97 - 07.01 AHF, ASV 246-086-001-007C HLWP Plug Number (T2): 3b; T26: X11-246-003-014



					
Date	Engine Code	Chassis No.	Article No.	Product	Information

**AUDI****A3 (8L1)****1.9 TDI (96 kW | 1.9 Litre)**

08.00 →	ASZ	8L-21008 400→	246-083-002-022G	SWP-D-C	
08.00 →	ASZ		246-086-001-007C	HLWP	Plug Number (T2): 3b; T26: X11-246-003-014

**1.9 TDI quattro (96 kW | 1.9 Litre)**

08.00 →	ASZ		246-083-002-022G	SWP-D-C	
08.00 →	ASZ		246-086-001-007C	HLWP	Plug Number (T2): 3b; T26: X11-246-003-014

**S3 quattro (154 kW | 1.8 Litre)**

03.99 →	APY		246-083-002-022G	SWP-D-C	
03.99 →	APY, AMK, AUL		246-086-001-002C	HLWP	Plug Number (T2): 3
03.99 →	APY, AMK, AUL		246-086-001-007C	HLWP	Plug Number (T2): 3b; T26: X11-246-003-014

**S3 quattro (165 kW | 1.8 Litre)**

10.01 →	BAM		246-083-002-022G	SWP-D-C	
10.01 →	BAM		246-086-001-007C	HLWP	Plug Number (T2): 3b

**A3 (8P1)****1.2 TSI (77 kW | 1.2 Litre)**

04.10 →	CBZB		246-083-002-022G	SWP-D-C	
04.10 →	CBZB		246-086-001-007C	HLWP	Plug Number (T2): 3b

**1.4 TFSI (92 kW | 1.4 Litre)**

09.07 →	CAXC		246-083-002-022G	SWP-D-C	
09.07 →	CAXC, CMSA		246-086-001-007C	HLWP	Plug Number (T2): 3b

**1.6 (75 kW | 1.6 Litre)**

05.03 →	BSE		246-083-002-022G	SWP-D-C	
05.03 →	BGU, BSE, BSF, CCSA, CMXA		246-086-001-007C	HLWP	Plug Number (T2): 3b

**1.6 FSI (85 kW | 1.6 Litre)**

08.03 →	BLP		246-083-002-022G	SWP-D-C	
08.03 →	BAG, BLF, BLP		246-086-001-007C	HLWP	Plug Number (T2): 3b

**1.6 TDI (66 kW | 1.6 Litre)**

05.09 →	CAYB		246-083-002-022G	SWP-D-C	
05.09 →	CAYB		246-086-001-007C	HLWP	Plug Number (T2): 3b

**1.6 TDI (77 kW | 1.6 Litre)**

05.09 →	CAYC		246-083-002-022G	SWP-D-C	
05.09 →	CAYC		246-086-001-007C	HLWP	Plug Number (T2): 3b

**1.8 TFSI (118 kW | 1.8 Litre)**

11.06 →	BYT, BZB, CDAA		246-083-002-022G	SWP-D-C	
11.06 →	BYT, BZB, CDAA		246-086-001-007C	HLWP	Plug Number (T2): 3b

**1.8 TFSI quattro (118 kW | 1.8 Litre)**

07.08 →	CDAA		246-083-002-022G	SWP-D-C	
07.08 →	CDAA		246-086-001-007C	HLWP	Plug Number (T2): 3b

**1.9 TDI (77 kW | 1.9 Litre)**

05.03 →	BKC, BLS, BXE		246-083-002-022G	SWP-D-C	
05.03 →	BKC, BLS, BXE		246-086-001-007C	HLWP	Plug Number (T2): 3b

**2.0 FSI (110 kW | 2.0 Litre)**

05.03 →	AXW		246-083-002-022G	SWP-D-C	
05.03 →	AXW, BLR, BLX, BLY, BMB, BVY, BVZ		246-086-001-007C	HLWP	Plug Number (T2): 3b

**2.0 TDI (100 kW | 2.0 Litre)**

05.03 →	AZV, CBAA, CFFA		246-083-002-022G	SWP-D-C	
05.03 →	AZV, CBAA, CFFA		246-086-001-007C	HLWP	Plug Number (T2): 3b

**2.0 TDI (103 kW | 2.0 Litre)**

06.05 →	BMM		246-083-002-022G	SWP-D-C	
06.05 →	BMM		246-086-001-007C	HLWP	Plug Number (T2): 3b

**2.0 TDI (120 kW | 2.0 Litre)**

06.06 → 06.08	BUY		246-083-002-022G	SWP-D-C	
06.06 → 06.08	BUY		246-086-001-007C	HLWP	Plug Number (T2): 3b

**2.0 TDI (125 kW | 2.0 Litre)**

03.06 →	BMN, CBBB, CFGB		246-083-002-022G	SWP-D-C	
03.06 →	BMN, CBBB, CFGB		246-086-001-007C	HLWP	Plug Number (T2): 3b

**2.0 TDI 16V (103 kW | 2.0 Litre)**

05.03 →	BKD, CBAB, CFFB, CLJA		246-083-002-022G	SWP-D-C	
05.03 →	BKD, CBAB, CFFB, CLJA		246-086-001-007C	HLWP	Plug Number (T2): 3b

**2.0 TDI 16V quattro (103 kW | 2.0 Litre)**

08.04 →	BKD, CBAB, CFFB		246-083-002-022G	SWP-D-C	
---------	-----------------	--	------------------	---------	--



			<b>VDO</b>		
Date	Engine Code	Chassis No.	Article No.	Product	Information

**AUDI****A3 (8P1)****2.0 TDI 16V quattro (103 kW | 2.0 Litre)**

08.04 →	BKD, CBAB, CFFB		246-086-001-007C	HLWP	Plug Number (T2): 3b
---------	-----------------	--	------------------	------	----------------------

**2.0 TDI quattro (100 kW | 2.0 Litre)**

05.03 →	AZV		246-083-002-022G	SWP-D-C	
05.03 →	AZV		246-086-001-007C	HLWP	Plug Number (T2): 3b

**2.0 TDI quattro (103 kW | 2.0 Litre)**

01.06 →	BMM		246-083-002-022G	SWP-D-C	
01.06 →	BMM		246-086-001-007C	HLWP	Plug Number (T2): 3b

**2.0 TDI quattro (125 kW | 2.0 Litre)**

03.06 →	BMN, CBBB, CFGB		246-083-002-022G	SWP-D-C	
03.06 →	BMN, CBBB, CFGB		246-086-001-007C	HLWP	Plug Number (T2): 3b

**2.0 TFSI (147 kW | 2.0 Litre)**

09.04 →	BWA		246-083-002-022G	SWP-D-C	
09.04 →	AXX, BWA, CAWB, CCZA		246-086-001-007C	HLWP	Plug Number (T2): 3b

**2.0 TFSI quattro (147 kW | 2.0 Litre)**

09.04 →	BWA		246-083-002-022G	SWP-D-C	
09.04 →	AXX, BWA, CCZA		246-086-001-007C	HLWP	Plug Number (T2): 3b

**3.2 V6 quattro (184 kW | 3.2 Litre)**

07.03 →	BDB, BMJ, BUB	F 8P-5B003 751 →	246-083-002-022G	SWP-D-C	
07.03 →	BDB, BMJ, BUB		246-086-001-007C	HLWP	Plug Number (T2): 3b

**S3 quattro (188 kW | 2.0 Litre)**

02.07 →	BZC, CDLC		246-083-002-022G	SWP-D-C	
02.07 →	BZC, CDLC		246-086-001-007C	HLWP	Plug Number (T2): 3b

**S3 quattro (195 kW | 2.0 Litre)**

11.06 →	BHZ, CDLA		246-083-002-022G	SWP-D-C	
11.06 →	BHZ, CDLA		246-086-001-007C	HLWP	Plug Number (T2): 3b

**A3 Sportback (8PA)****1.2 TSI (77 kW | 1.2 Litre)**

04.10 →	CBZB		246-083-002-022G	SWP-D-C	
04.10 →	CBZB		246-086-001-007C	HLWP	Plug Number (T2): 3b

**1.4 TFSI (92 kW | 1.4 Litre)**

09.07 →	CAXC		246-083-002-022G	SWP-D-C	
09.07 →	CAXC, CMSA		246-086-001-007C	HLWP	Plug Number (T2): 3b

**1.6 (75 kW | 1.6 Litre)**

09.04 →	CCSA		246-083-002-022G	SWP-D-C	
09.04 →	BGU, BSE, BSF, CCSA, CMXA		246-086-001-007C	HLWP	Plug Number (T2): 3b

**1.6 FSI (85 kW | 1.6 Litre)**

09.04 →	BLP, BLF	F 8P-5B003 751 →	246-083-002-022G	SWP-D-C	
09.04 →	BLF, BLP		246-086-001-007C	HLWP	Plug Number (T2): 3b

**1.6 TDI (66 kW | 1.6 Litre)**

05.09 →	CAYB		246-083-002-022G	SWP-D-C	
05.09 →	CAYB		246-086-001-007C	HLWP	Plug Number (T2): 3b

**1.6 TDI (77 kW | 1.6 Litre)**

05.09 →	CAYC		246-083-002-022G	SWP-D-C	
05.09 →	CAYC		246-086-001-007C	HLWP	Plug Number (T2): 3b

**1.8 TFSI (118 kW | 1.8 Litre)**

11.06 →	BYT		246-083-002-022G	SWP-D-C	
11.06 →	BYT, BZB, CDAA		246-086-001-007C	HLWP	Plug Number (T2): 3b

**1.8 TFSI quattro (118 kW | 1.8 Litre)**

07.08 →	CDAA		246-083-002-022G	SWP-D-C	
07.08 →	CDAA		246-086-001-007C	HLWP	Plug Number (T2): 3b

**1.9 TDI (77 kW | 1.9 Litre)**

09.04 →	BKC, BLS, BXE		246-083-002-022G	SWP-D-C	
09.04 →	BKC, BLS, BXE		246-086-001-007C	HLWP	Plug Number (T2): 3b

**2.0 FSI (110 kW | 2.0 Litre)**

09.04 →	BLX, BLY, BLR, BVY, BVZ, BMB	→8P-6B025 000	246-083-002-022G	SWP-D-C	
09.04 →	BLR, BLX, BLY, BMB, BVY, BVZ		246-086-001-007C	HLWP	Plug Number (T2): 3b

**2.0 TDI (100 kW | 2.0 Litre)**

09.04 →	AZV, CBAA, CFFA		246-083-002-022G	SWP-D-C	
09.04 →	AZV, CBAA, CFFA		246-086-001-007C	HLWP	Plug Number (T2): 3b

**2.0 TDI (103 kW | 2.0 Litre)**

06.05 →	BMM		246-083-002-022G	SWP-D-C	
---------	-----	--	------------------	---------	--



			<b>VDO</b>		
Date	Engine Code	Chassis No.	Article No.	Product	Information

**AUDI****A3 Sportback (8PA)****2.0 TDI (103 kW | 2.0 Litre)**

06.05 →	BMM		246-086-001-007C	HLWP	Plug Number (T2): 3b
---------	-----	--	------------------	------	----------------------

**2.0 TDI (120 kW | 2.0 Litre)**

06.06 → 06.08	BUY		246-083-002-022G	SWP-D-C	
06.06 → 06.08	BUY		246-086-001-007C	HLWP	Plug Number (T2): 3b

**2.0 TDI (125 kW | 2.0 Litre)**

03.06 →	BMN, CBBB, CFFB		246-083-002-022G	SWP-D-C	
03.06 →	BMN, CBBB, CFFB		246-086-001-007C	HLWP	Plug Number (T2): 3b

**2.0 TDI 16V (103 kW | 2.0 Litre)**

09.04 →	BKD, CBAB, CFFB, CLJA		246-083-002-022G	SWP-D-C	
09.04 →	BKD, CBAB, CFFB, CLJA		246-086-001-007C	HLWP	Plug Number (T2): 3b

**2.0 TDI 16V quattro (103 kW | 2.0 Litre)**

11.05 →	BKD, CBAB, CFFB		246-083-002-022G	SWP-D-C	
11.05 →	BKD, CBAB, CFFB		246-086-001-007C	HLWP	Plug Number (T2): 3b

**2.0 TDI quattro (103 kW | 2.0 Litre)**

01.06 →	BMM		246-083-002-022G	SWP-D-C	
01.06 →	BMM		246-086-001-007C	HLWP	Plug Number (T2): 3b

**2.0 TDI quattro (125 kW | 2.0 Litre)**

03.06 →	BMN, CBBB, CFFB		246-083-002-022G	SWP-D-C	
03.06 →	BMN, CBBB, CFFB		246-086-001-007C	HLWP	Plug Number (T2): 3b

**2.0 TFSI (147 kW | 2.0 Litre)**

09.04 →	CAWB		246-083-002-022G	SWP-D-C	
09.04 →	AXX, BPY, BWA, CAWB, CBFA, CCZA		246-086-001-007C	HLWP	Plug Number (T2): 3b

**2.0 TFSI quattro (147 kW | 2.0 Litre)**

09.04 →	AXX, BWA, CCZA	→8P-7-120 000	246-083-002-022G	SWP-D-C	
09.04 →	AXX, BWA, CCZA		246-086-001-007C	HLWP	Plug Number (T2): 3b

**3.2 V6 quattro (184 kW | 3.2 Litre)**

09.04 →	BMJ, BUB	→8P-6B025 000	246-083-002-022G	SWP-D-C	
09.04 →	BMJ, BUB		246-086-001-007C	HLWP	Plug Number (T2): 3b

**S3 quattro (188 kW | 2.0 Litre)**

07.08 →	CDLC		246-083-002-022G	SWP-D-C	
07.08 →	CDLC		246-086-001-007C	HLWP	Plug Number (T2): 3b

**S3 quattro (195 kW | 2.0 Litre)**

06.08 →	BHZ, CDLA		246-083-002-022G	SWP-D-C	
06.08 →	BHZ, CDLA		246-086-001-007C	HLWP	Plug Number (T2): 3b

**A3 Convertible (8P7)****1.2 TFSI (77 kW | 1.2 Litre)**

03.10 →	CBZB		246-082-008-025G	SWP-M-C	
03.10 →	CBZB		246-086-001-007C	HLWP	Plug Number (T2): 3b

**1.6 (75 kW | 1.6 Litre)**

09.08 →	BSE		246-082-008-025G	SWP-M-C	
09.08 →	BSE		246-086-001-007C	HLWP	Plug Number (T2): 3b

**1.6 TDI (77 kW | 1.6 Litre)**

05.09 →	CAYC		246-082-008-025G	SWP-M-C	
05.09 →	CAYC		246-086-001-007C	HLWP	Plug Number (T2): 3b

**1.8 TFSI (118 kW | 1.8 Litre)**

04.08 →	BZB, CDAA		246-082-008-025G	SWP-M-C	
04.08 →	BZB, CDAA		246-086-001-007C	HLWP	Plug Number (T2): 3b

**1.9 TDI (77 kW | 1.9 Litre)**

04.08 →	BLS		246-082-008-025G	SWP-M-C	
04.08 →	BLS		246-086-001-007C	HLWP	Plug Number (T2): 3b

**2.0 TDI (100 kW | 2.0 Litre)**

04.08 →	CBAA, CFFA		246-082-008-025G	SWP-M-C	
04.08 →	CBAA, CFFA		246-086-001-007C	HLWP	Plug Number (T2): 3b

**2.0 TDI (103 kW | 2.0 Litre)**

04.08 →	CBAB, CFFB		246-082-008-025G	SWP-M-C	
04.08 →	CBAB, CFFB		246-086-001-007C	HLWP	Plug Number (T2): 3b

**2.0 TFSI (147 kW | 2.0 Litre)**

04.08 →	CAWB, CCZA		246-082-008-025G	SWP-M-C	
04.08 →	CAWB, CCZA		246-086-001-007C	HLWP	Plug Number (T2): 3b



			<b>VDO</b>		
Date	Engine Code	Chassis No.	Article No.	Product	Information

**AUDI****A4 (8D2, B5)****1.6 (74 kW | 1.6 Litre)**

11.94 - 10.00	ADP, AHL, ANA, ARM		246-082-008-025G	SWP-M-C	
11.94 - 07.99	ADP, AHL, ANA, ARM		246-086-001-002C	HLWP	Plug Number (T2): 3
11.94 - 10.00	ADP, AHL, ANA, ARM		246-086-001-007C	HLWP	Plug Number (T2): 3b; T26: X11-246-003-014

**1.6 (75 kW | 1.6 Litre)**

07.00 - 11.00	ALZ		246-086-001-007C	HLWP	Plug Number (T2): 3b; T26: X11-246-003-014
---------------	-----	--	------------------	------	--------------------------------------------

**1.8 (85 kW | 1.8 Litre)**

04.95 - 11.00	AFY		246-082-008-025G	SWP-M-C	
07.95 - 12.98	AFY		246-086-001-002C	HLWP	Plug Number (T2): 3
04.95 - 11.00	AFY		246-086-001-007C	HLWP	Plug Number (T2): 3b; T26: X11-246-003-014

**1.8 (92 kW | 1.8 Litre)**

01.95 - 11.00	ADR, APT, ARG, AVV		246-082-008-025G	SWP-M-C	
01.95 - 07.99	ADR, APT, ARG, AVV		246-086-001-002C	HLWP	Plug Number (T2): 3
01.95 - 11.00	ADR, APT, ARG, AVV		246-086-001-007C	HLWP	Plug Number (T2): 3b; T26: X11-246-003-014

**1.8 (95 kW | 1.8 Litre)**

01.95 - 11.00			246-086-001-007C	HLWP	Plug Number (T2): 3b; T26: X11-246-003-014
---------------	--	--	------------------	------	--------------------------------------------

**1.8 quattro (85 kW | 1.8 Litre)**

07.95 - 11.00	AFY		246-082-008-025G	SWP-M-C	
07.95 - 12.98	AFY		246-086-001-002C	HLWP	Plug Number (T2): 3
07.95 - 11.00	AFY		246-086-001-007C	HLWP	Plug Number (T2): 3b; T26: X11-246-003-014

**1.8 quattro (92 kW | 1.8 Litre)**

01.95 - 11.00	ADR, APT, ARG		246-082-008-025G	SWP-M-C	
01.95 - 07.99	ADR, APT, ARG		246-086-001-002C	HLWP	Plug Number (T2): 3
01.95 - 11.00	ADR, APT, ARG		246-086-001-007C	HLWP	Plug Number (T2): 3b; T26: X11-246-003-014

**1.8 T (110 kW | 1.8 Litre)**

01.95 - 11.00	AEB, ARK, APU, ANB, AWT		246-082-008-025G	SWP-M-C	
01.95 - 07.99	AEB, ARK, APU, ANB, AWT		246-086-001-002C	HLWP	Plug Number (T2): 3
01.95 - 11.00	AEB, ARK, APU, ANB, AWT		246-086-001-007C	HLWP	Plug Number (T2): 3b; T26: X11-246-003-014

**1.8 T (132 kW | 1.8 Litre)**

12.97 - 11.00	AJL		246-082-008-025G	SWP-M-C	
12.97 - 12.98	AJL		246-086-001-002C	HLWP	Plug Number (T2): 3
12.97 - 11.00	AJL		246-086-001-007C	HLWP	Plug Number (T2): 3b; T26: X11-246-003-014

**1.8 T quattro (110 kW | 1.8 Litre)**

01.95 - 11.00	AEB, ANB, APU, ARK, AWT		246-082-008-025G	SWP-M-C	
01.95 - 07.99	AEB, ANB, APU, ARK, AWT		246-086-001-002C	HLWP	Plug Number (T2): 3
01.95 - 11.00	AEB, ANB, APU, ARK, AWT		246-086-001-007C	HLWP	Plug Number (T2): 3b; T26: X11-246-003-014

**1.8 T quattro (132 kW | 1.8 Litre)**

12.97 - 11.00	AJL		246-082-008-025G	SWP-M-C	
12.97 - 12.98	AJL		246-086-001-002C	HLWP	Plug Number (T2): 3
12.97 - 11.00	AJL		246-086-001-007C	HLWP	Plug Number (T2): 3b; T26: X11-246-003-014

**1.9 TDI (55 kW | 1.9 Litre)**

12.95 - 11.00	AFF		246-082-008-025G	SWP-M-C	
12.95 - 12.98	AFF		246-086-001-002C	HLWP	Plug Number (T2): 3
12.95 - 11.00	AFF		246-086-001-007C	HLWP	Plug Number (T2): 3b; T26: X11-246-003-014

**1.9 TDI (66 kW | 1.9 Litre)**

01.95 - 11.00	1Z, AHU, AHH		246-082-008-025G	SWP-M-C	
01.95 - 12.98	1Z, AHU, AHH		246-086-001-002C	HLWP	Plug Number (T2): 3
01.95 - 11.00	1Z, AHU, AHH		246-086-001-007C	HLWP	Plug Number (T2): 3b; T26: X11-246-003-014

**1.9 TDI (81 kW | 1.9 Litre)**

10.95 - 11.00	AVG, AFN		246-082-008-025G	SWP-M-C	
02.96 - 12.98	AVG, AFN		246-086-001-002C	HLWP	Plug Number (T2): 3
10.95 - 11.00	AVG, AFN		246-086-001-007C	HLWP	Plug Number (T2): 3b; T26: X11-246-003-014

**1.9 TDI (85 kW | 1.9 Litre)**

03.00 - 11.00	AJM		246-083-002-022G	SWP-D-C	
03.00 - 11.00	AJM		246-086-001-007C	HLWP	Plug Number (T2): 3b; T26: X11-246-003-014

**1.9 TDI quattro (81 kW | 1.9 Litre)**

09.96 - 11.00	AFN, AVG		246-082-008-025G	SWP-M-C	
02.99 - 07.99	AFN, AVG		246-086-001-002C	HLWP	Plug Number (T2): 3
09.96 - 11.00	AFN, AVG		246-086-001-007C	HLWP	Plug Number (T2): 3b; T26: X11-246-003-014

**1.9 TDI quattro (85 kW | 1.9 Litre)**

03.00 - 11.00	AJM, ATJ		246-086-001-007C	HLWP	Plug Number (T2): 3b; T26: X11-246-003-014
---------------	----------	--	------------------	------	--------------------------------------------

**2.4 (120 kW | 2.4 Litre)**

08.97 - 11.00	AJG, APZ, AMM		246-086-001-007C	HLWP	Plug Number (T2): 3b; T26: X11-246-003-014
---------------	---------------	--	------------------	------	--------------------------------------------



					
Date	Engine Code	Chassis No.	Article No.	Product	Information

## AUDI

### A4 (8D2, B5)

#### 2.4 (121 kW | 2.4 Litre)

03.97 - 11.00	AGA, ALF, AML, ARJ, APS		246-082-008-025G	SWP-M-C	
03.97 - 07.99	AGA, ALF, AML, ARJ, APS		246-086-001-002C	HLWP	Plug Number (T2): 3
03.97 - 11.00	AGA, ALF, AML, ARJ, APS		246-086-001-007C	HLWP	Plug Number (T2): 3b; T26: X11-246-003-014

#### 2.4 quattro (120 kW | 2.4 Litre)

08.97 - 11.00	APZ		246-086-001-007C	HLWP	Plug Number (T2): 3b; T26: X11-246-003-014
---------------	-----	--	------------------	------	--------------------------------------------

#### 2.4 quattro (121 kW | 2.4 Litre)

03.97 - 11.00	AGA, ALF, AML, ARJ, APS		246-082-008-025G	SWP-M-C	
08.97 - 07.99	AGA, ALF, AML, ARJ, APS		246-086-001-002C	HLWP	Plug Number (T2): 3
03.97 - 11.00	AGA, ALF, AML, ARJ, APS		246-086-001-007C	HLWP	Plug Number (T2): 3b; T26: X11-246-003-014

#### 2.5 TDI (110 kW | 2.5 Litre)

09.97 - 11.00	AFB, AKN		246-082-008-025G	SWP-M-C	
11.97 - 07.99	AFB, AKN		246-086-001-002C	HLWP	Plug Number (T2): 3
09.97 - 11.00	AFB, AKN		246-086-001-007C	HLWP	Plug Number (T2): 3b; T26: X11-246-003-014

#### 2.5 TDI quattro (110 kW | 2.5 Litre)

09.97 - 11.00	AFB, AKN		246-082-008-025G	SWP-M-C	
11.97 - 07.99	AFB, AKN		246-086-001-002C	HLWP	Plug Number (T2): 3
09.97 - 11.00	AFB, AKN		246-086-001-007C	HLWP	Plug Number (T2): 3b; T26: X11-246-003-014

#### 2.6 (110 kW | 2.6 Litre)

01.95 - 11.00	ABC		246-082-008-025G	SWP-M-C	
01.95 - 07.98	ABC		246-086-001-002C	HLWP	Plug Number (T2): 3
01.95 - 11.00	ABC		246-086-001-007C	HLWP	Plug Number (T2): 3b; T26: X11-246-003-014

#### 2.6 quattro (110 kW | 2.6 Litre)

01.95 - 11.00	ABC		246-082-008-025G	SWP-M-C	
01.95 - 12.98	ABC		246-086-001-002C	HLWP	Plug Number (T2): 3
01.95 - 11.00	ABC		246-086-001-007C	HLWP	Plug Number (T2): 3b; T26: X11-246-003-014

#### 2.8 (128 kW | 2.8 Litre)

09.95 - 07.97	AAH		246-086-001-002C	HLWP	Plug Number (T2): 3
09.95 - 07.97	AAH		246-086-001-007C	HLWP	Plug Number (T2): 3b; T26: X11-246-003-014

#### 2.8 (142 kW | 2.8 Litre)

10.96 - 11.00	ACK, ALG, AMX, APR, AQD		246-082-008-025G	SWP-M-C	
10.96 - 12.98	ACK, ALG, AMX, APR, AQD		246-086-001-002C	HLWP	Plug Number (T2): 3
10.96 - 11.00	ACK, ALG, AMX, APR, AQD		246-086-001-007C	HLWP	Plug Number (T2): 3b; T26: X11-246-003-014

#### 2.8 quattro (128 kW | 2.8 Litre)

01.95 - 07.97	AAH		246-086-001-002C	HLWP	Plug Number (T2): 3
01.95 - 07.97	AAH		246-086-001-007C	HLWP	Plug Number (T2): 3b; T26: X11-246-003-014

#### 2.8 quattro (142 kW | 2.8 Litre)

10.96 - 11.00	ACK, ALG, AMX, APR, AQD		246-082-008-025G	SWP-M-C	
08.97 - 07.99	ACK, ALG, AMX, APR, AQD		246-086-001-002C	HLWP	Plug Number (T2): 3
10.96 - 11.00	ACK, ALG, AMX, APR, AQD		246-086-001-007C	HLWP	Plug Number (T2): 3b; T26: X11-246-003-014

#### S4 quattro (195 kW | 2.7 Litre)

09.97 - 11.00	AGB		246-082-008-025G	SWP-M-C	
10.97 - 01.99	AGB, AZB		246-086-001-002C	HLWP	Plug Number (T2): 3
09.97 - 11.00	AGB, AZB		246-086-001-007C	HLWP	Plug Number (T2): 3b; T26: X11-246-003-014

### A4 Avant (8D5, B5)

#### 1.6 (74 kW | 1.6 Litre)

11.94 - 09.01	ADP, AHL, ANA, ARM		246-082-008-025G	SWP-M-C	
11.94 - 09.01	ADP, AHL, ANA, ARM		246-083-002-022G	SWP-D-C	
11.94 - 07.99	ADP, AHL, ANA, ARM		246-086-001-002C	HLWP	Plug Number (T2): 3
11.94 - 09.01	ADP, AHL, ANA, ARM		246-086-001-007C	HLWP	Plug Number (T2): 3b; T26: X11-246-003-014

#### 1.6 (75 kW | 1.6 Litre)

07.00 - 09.01	ALZ		246-083-002-022G	SWP-D-C	
07.00 - 09.01	ALZ		246-086-001-007C	HLWP	Plug Number (T2): 3b; T26: X11-246-003-014

#### 1.8 (85 kW | 1.8 Litre)

07.95 - 09.01	AFY		246-082-008-025G	SWP-M-C	
07.95 - 09.01	AFY		246-083-002-022G	SWP-D-C	
07.95 - 07.97	AFY		246-086-001-002C	HLWP	Plug Number (T2): 3
07.95 - 09.01	AFY		246-086-001-007C	HLWP	Plug Number (T2): 3b; T26: X11-246-003-014

#### 1.8 (92 kW | 1.8 Litre)

02.96 - 09.01	ADR, APT, ARG, AVV		246-082-008-025G	SWP-M-C	
02.96 - 09.01	ADR, APT, ARG, AVV		246-083-002-022G	SWP-D-C	
02.96 - 07.99	ADR, APT, ARG, AVV		246-086-001-002C	HLWP	Plug Number (T2): 3





					
Date	Engine Code	Chassis No.	Article No.	Product	Information

## AUDI

## A4 Avant (8D5, B5)

## 1.8 (92 kW | 1.8 Litre)

02.96 - 09.01	ADR, APT, ARG, AVV		246-086-001-007C	HLWP	Plug Number (T2): 3b; T26: X11-246-003-014
---------------	--------------------	--	------------------	------	--------------------------------------------

## 1.8 quattro (85 kW | 1.8 Litre)

07.95 - 09.01	AFY		246-082-008-025G	SWP-M-C	
07.95 - 09.01	AFY		246-083-002-022G	SWP-D-C	
08.97 - 12.98	AFY		246-086-001-002C	HLWP	Plug Number (T2): 3
07.95 - 09.01	AFY		246-086-001-007C	HLWP	Plug Number (T2): 3b; T26: X11-246-003-014

## 1.8 quattro (92 kW | 1.8 Litre)

01.96 - 09.01	ADR, APT, ARG		246-082-008-025G	SWP-M-C	
01.96 - 09.01	ADR, APT, ARG		246-083-002-022G	SWP-D-C	
02.96 - 07.99	ADR, APT, ARG		246-086-001-002C	HLWP	Plug Number (T2): 3
01.96 - 09.01	ADR, APT, ARG		246-086-001-007C	HLWP	Plug Number (T2): 3b; T26: X11-246-003-014

## 1.8 T (110 kW | 1.8 Litre)

03.96 - 09.01	AEB, ANB, APU, ARK, AWT		246-082-008-025G	SWP-M-C	
03.96 - 09.01	AEB, ANB, APU, ARK, AWT		246-083-002-022G	SWP-D-C	
03.96 - 07.99	AEB, ANB, APU, ARK, AWT		246-086-001-002C	HLWP	Plug Number (T2): 3
03.96 - 09.01	AEB, ANB, APU, ARK, AWT		246-086-001-007C	HLWP	Plug Number (T2): 3b; T26: X11-246-003-014

## 1.8 T (132 kW | 1.8 Litre)

12.97 - 09.01	AJL		246-082-008-025G	SWP-M-C	
12.97 - 09.01	AJL		246-083-002-022G	SWP-D-C	
12.97 - 12.98	AJL		246-086-001-002C	HLWP	Plug Number (T2): 3
12.97 - 09.01	AJL		246-086-001-007C	HLWP	Plug Number (T2): 3b; T26: X11-246-003-014

## 1.8 T quattro (110 kW | 1.8 Litre)

01.96 - 09.01	AEB, ANB, APU, ARK, AWT		246-082-008-025G	SWP-M-C	
01.96 - 09.01	AEB, ANB, APU, ARK, AWT		246-083-002-022G	SWP-D-C	
02.96 - 01.99	AEB, ANB, APU, ARK, AWT		246-086-001-002C	HLWP	Plug Number (T2): 3
01.96 - 09.01	AEB, ANB, APU, ARK, AWT		246-086-001-007C	HLWP	Plug Number (T2): 3b; T26: X11-246-003-014

## 1.8 T quattro (132 kW | 1.8 Litre)

12.97 - 09.01	AJL		246-082-008-025G	SWP-M-C	
12.97 - 09.01	AJL		246-083-002-022G	SWP-D-C	
12.97 - 12.98	AJL		246-086-001-002C	HLWP	Plug Number (T2): 3
12.97 - 09.01	AJL		246-086-001-007C	HLWP	Plug Number (T2): 3b; T26: X11-246-003-014

## 1.9 TDI (55 kW | 1.9 Litre)

03.96 - 09.01	AFF		246-082-008-025G	SWP-M-C	
03.96 - 09.01	AFF		246-083-002-022G	SWP-D-C	
08.96 - 12.98	AFF		246-086-001-002C	HLWP	Plug Number (T2): 3
03.96 - 09.01	AFF		246-086-001-007C	HLWP	Plug Number (T2): 3b; T26: X11-246-003-014

## 1.9 TDI (66 kW | 1.9 Litre)

02.96 - 09.01	1Z, AHU, AHH		246-082-008-025G	SWP-M-C	
02.96 - 09.01	1Z, AHU, AHH		246-083-002-022G	SWP-D-C	
02.96 - 12.98	1Z, AHU, AHH		246-086-001-002C	HLWP	Plug Number (T2): 3
02.96 - 09.01	1Z, AHU, AHH		246-086-001-007C	HLWP	Plug Number (T2): 3b; T26: X11-246-003-014

## 1.9 TDI (81 kW | 1.9 Litre)

02.96 - 09.01	AFN, AVG		246-082-008-025G	SWP-M-C	
02.96 - 09.01	AFN, AVG		246-083-002-022G	SWP-D-C	
02.96 - 07.98	AFN, AVG		246-086-001-002C	HLWP	Plug Number (T2): 3
02.96 - 09.01	AFN, AVG		246-086-001-007C	HLWP	Plug Number (T2): 3b; T26: X11-246-003-014

## 1.9 TDI (85 kW | 1.9 Litre)

03.00 - 09.01	AJM		246-082-008-025G	SWP-M-C	
03.00 - 09.01	AJM		246-083-002-022G	SWP-D-C	
03.00 - 09.01	AJM		246-086-001-002C	HLWP	Plug Number (T2): 3
03.00 - 09.01	AJM		246-086-001-007C	HLWP	Plug Number (T2): 3b; T26: X11-246-003-014

## 1.9 TDI quattro (81 kW | 1.9 Litre)

09.96 - 09.01	AFN, AVG		246-082-008-025G	SWP-M-C	
09.96 - 09.01	AFN, AVG		246-083-002-022G	SWP-D-C	
02.99 - 07.99	AFN, AVG		246-086-001-002C	HLWP	Plug Number (T2): 3
09.96 - 09.01	AFN, AVG		246-086-001-007C	HLWP	Plug Number (T2): 3b; T26: X11-246-003-014

## 1.9 TDI quattro (85 kW | 1.9 Litre)

03.00 - 09.01	AJM, ATJ		246-086-001-007C	HLWP	Plug Number (T2): 3b; T26: X11-246-003-014
---------------	----------	--	------------------	------	--------------------------------------------

## 2.4 (120 kW | 2.4 Litre)

08.97 - 09.01	AJG, APZ, AMM		246-083-002-022G	SWP-D-C	
08.97 - 09.01	AJG, APZ, AMM		246-086-001-007C	HLWP	Plug Number (T2): 3b; T26: X11-246-003-014



			<b>VDO</b>		
Date	Engine Code	Chassis No.	Article No.	Product	Information

**AUDI****A4 Avant (8D5, B5)****2.4 (121 kW | 2.4 Litre)**

03.97 - 09.01	AGA, ALF, AML, ARJ, APS		246-082-008-025G	SWP-M-C	
03.97 - 09.01	AGA, ALF, AML, ARJ, APS		246-083-002-022G	SWP-D-C	
03.97 - 07.99	AGA, ALF, AML, ARJ, APS		246-086-001-002C	HLWP	Plug Number (T2): 3
03.97 - 09.01	AGA, ALF, AML, ARJ, APS		246-086-001-007C	HLWP	Plug Number (T2): 3b; T26: X11-246-003-014

**2.4 quattro (120 kW | 2.4 Litre)**

08.97 - 09.01	APZ		246-083-002-022G	SWP-D-C	
08.97 - 09.01	APZ		246-086-001-007C	HLWP	Plug Number (T2): 3b; T26: X11-246-003-014

**2.4 quattro (121 kW | 2.4 Litre)**

03.97 - 09.01	AGA, ALF, AML, ARJ, APS		246-082-008-025G	SWP-M-C	
03.97 - 09.01	AGA, ALF, AML, ARJ, APS		246-083-002-022G	SWP-D-C	
08.97 - 12.98	AGA, ALF, AML, ARJ, APS		246-086-001-002C	HLWP	Plug Number (T2): 3
03.97 - 09.01	AGA, ALF, AML, ARJ, APS		246-086-001-007C	HLWP	Plug Number (T2): 3b; T26: X11-246-003-014

**2.5 TDI (110 kW | 2.5 Litre)**

09.97 - 09.01	AFB, AKN		246-082-008-025G	SWP-M-C	
09.97 - 09.01	AFB, AKN		246-083-002-022G	SWP-D-C	
11.97 - 07.99	AFB, AKN		246-086-001-002C	HLWP	Plug Number (T2): 3
09.97 - 09.01	AFB, AKN		246-086-001-007C	HLWP	Plug Number (T2): 3b; T26: X11-246-003-014

**2.5 TDI quattro (110 kW | 2.5 Litre)**

09.97 - 09.01	AFB, AKN		246-082-008-025G	SWP-M-C	
09.97 - 09.01	AFB, AKN		246-083-002-022G	SWP-D-C	
11.97 - 07.99	AFB, AKN		246-086-001-002C	HLWP	Plug Number (T2): 3
09.97 - 09.01	AFB, AKN		246-086-001-007C	HLWP	Plug Number (T2): 3b; T26: X11-246-003-014

**2.6 (110 kW | 2.6 Litre)**

02.96 - 09.01	ABC		246-082-008-025G	SWP-M-C	
02.96 - 09.01	ABC		246-083-002-022G	SWP-D-C	
02.96 - 07.98	ABC		246-086-001-002C	HLWP	Plug Number (T2): 3
02.96 - 09.01	ABC		246-086-001-007C	HLWP	Plug Number (T2): 3b; T26: X11-246-003-014

**2.6 quattro (110 kW | 2.6 Litre)**

01.96 - 09.01	ABC		246-082-008-025G	SWP-M-C	
01.96 - 09.01	ABC		246-083-002-022G	SWP-D-C	
08.97 - 07.98	ABC		246-086-001-002C	HLWP	Plug Number (T2): 3
01.96 - 09.01	ABC		246-086-001-007C	HLWP	Plug Number (T2): 3b; T26: X11-246-003-014

**2.8 (128 kW | 2.8 Litre)**

03.96 - 09.96	AAH		246-086-001-002C	HLWP	Plug Number (T2): 3
03.96 - 09.96	AAH		246-086-001-007C	HLWP	Plug Number (T2): 3b; T26: X11-246-003-014

**2.8 (142 kW | 2.8 Litre)**

10.96 - 09.01	ACK, ALG, AMX, APR, AQD		246-082-008-025G	SWP-M-C	
10.96 - 09.01	ACK, ALG, AMX, APR, AQD		246-083-002-022G	SWP-D-C	
10.96 - 12.98	ACK, ALG, AMX, APR, AQD		246-086-001-002C	HLWP	Plug Number (T2): 3
10.96 - 09.01	ACK, ALG, AMX, APR, AQD		246-086-001-007C	HLWP	Plug Number (T2): 3b; T26: X11-246-003-014

**2.8 quattro (128 kW | 2.8 Litre)**

01.96 - 09.96	AAH		246-083-002-022G	SWP-D-C	
01.96 - 09.96	AAH		246-086-001-007C	HLWP	Plug Number (T2): 3b; T26: X11-246-003-014

**2.8 quattro (142 kW | 2.8 Litre)**

10.96 - 09.01	ACK, ALG, AMX, APR, AQD		246-082-008-025G	SWP-M-C	
10.96 - 09.01	ACK, ALG, AMX, APR, AQD		246-083-002-022G	SWP-D-C	
08.97 - 07.99	ACK, ALG, AMX, APR, AQD		246-086-001-002C	HLWP	Plug Number (T2): 3
10.96 - 09.01	ACK, ALG, AMX, APR, AQD		246-086-001-007C	HLWP	Plug Number (T2): 3b; T26: X11-246-003-014

**RS4 quattro (280 kW | 2.7 Litre)**

05.00 - 09.01	ASJ, AZR		246-083-002-022G	SWP-D-C	
05.00 - 09.01	ASJ, AZR		246-086-001-007C	HLWP	Plug Number (T2): 3b; T26: X11-246-003-014

**S4 quattro (195 kW | 2.7 Litre)**

09.97 - 09.01	AZB		246-082-008-025G	SWP-M-C	
09.97 - 09.01	AZB		246-083-002-022G	SWP-D-C	
10.97 - 01.99	AGB, AZB		246-086-001-002C	HLWP	Plug Number (T2): 3
09.97 - 09.01	AGB, AZB		246-086-001-007C	HLWP	Plug Number (T2): 3b; T26: X11-246-003-014

**A4 (8E2, B6)****1.6 (75 kW | 1.6 Litre)**

11.00 - 12.04	ALZ		246-086-001-007C	HLWP	Plug Number (T2): 3b; T26: X11-246-003-014
---------------	-----	--	------------------	------	--------------------------------------------

**1.8 T (110 kW | 1.8 Litre)**

11.00 - 07.02	AVJ		246-086-001-007C	HLWP	Plug Number (T2): 3b; T26: X11-246-003-014
---------------	-----	--	------------------	------	--------------------------------------------



			<b>VDO</b>		
Date	Engine Code	Chassis No.	Article No.	Product	Information

**AUDI****A4 (8E2, B6)****1.8 T (120 kW | 1.8 Litre)**

07.02 → 12.04	BFB		246-082-008-025G	SWP-M-C	
07.02 → 12.04	BFB		246-083-002-022G	SWP-D-C	

**1.8 T (125 kW | 1.8 Litre)**

07.01 → 12.04	AMB		246-082-008-025G	SWP-M-C	
07.01 → 12.04	AMB		246-083-002-022G	SWP-D-C	

**1.8 T (140 kW | 1.8 Litre)**

11.02 → 12.04	BEX		246-082-008-025G	SWP-M-C	
11.02 → 12.04	BEX		246-083-002-022G	SWP-D-C	

**1.8 T quattro (110 kW | 1.8 Litre)**

11.00 → 07.02	AVJ		246-086-001-007C	HLWP	Plug Number (T2): 3b; T26: X11-246-003-014
---------------	-----	--	------------------	------	--------------------------------------------

**1.8 T quattro (120 kW | 1.8 Litre)**

07.02 → 12.04	BFB	→8E-5-065-000	246-082-008-025G	SWP-M-C	
07.02 → 12.04	BFB	→8E-5-065-000	246-083-002-022G	SWP-D-C	

**1.8 T quattro (125 kW | 1.8 Litre)**

07.01 → 12.04	AMB	→8E-5-065-000	246-082-008-025G	SWP-M-C	
07.01 → 12.04	AMB	→8E-5-065-000	246-083-002-022G	SWP-D-C	

**1.8 T quattro (140 kW | 1.8 Litre)**

11.02 → 12.04	BEX	→8E-5-065-000	246-082-008-025G	SWP-M-C	
11.02 → 12.04	BEX	→8E-5-065-000	246-083-002-022G	SWP-D-C	

**1.9 TDI (74 kW | 1.9 Litre)**

05.01 → 12.04	AVB	→8E-5-400 000	246-082-008-025G	SWP-M-C	
05.01 → 12.04	AVB		246-086-001-007C	HLWP	Plug Number (T2): 3b; T26: X11-246-003-014

**1.9 TDI (85 kW | 1.9 Litre)**

06.04 → 12.04	BKE	8E-1000 001→	246-082-008-025G	SWP-M-C	
06.04 → 12.04	BKE	8E-1000 001→	246-083-002-022G	SWP-D-C	

**1.9 TDI (96 kW | 1.9 Litre)**

11.00 → 12.04	AVF, AWX		246-086-001-007C	HLWP	Plug Number (T2): 3b; T26: X11-246-003-014
---------------	----------	--	------------------	------	--------------------------------------------

**1.9 TDI quattro (96 kW | 1.9 Litre)**

11.01 → 12.04	AVF	→8E-5-400 000	246-082-008-025G	SWP-M-C	
11.01 → 12.04	AVF		246-086-001-007C	HLWP	Plug Number (T2): 3b; T26: X11-246-003-014

**2.0 (96 kW | 2.0 Litre)**

11.00 → 12.04	ALT		246-086-001-007C	HLWP	Plug Number (T2): 3b; T26: X11-246-003-014
---------------	-----	--	------------------	------	--------------------------------------------

**2.0 FSI (110 kW | 2.0 Litre)**

07.02 → 12.04	AWA		246-082-008-025G	SWP-M-C	
07.02 → 12.04	AWA		246-086-001-007C	HLWP	Plug Number (T2): 3b; T26: X11-246-003-014

**2.4 (120 kW | 2.4 Litre)**

09.01 → 12.04	AMM	8E-2-020 001→	246-082-008-025G	SWP-M-C	
09.01 → 12.04	AMM	8E-2-020 001→	246-083-002-022G	SWP-D-C	

**2.4 (125 kW | 2.4 Litre)**

09.01 → 12.04	BDV	→8E-3-500 000	246-082-008-025G	SWP-M-C	
09.01 → 12.04	BDV		246-086-001-007C	HLWP	Plug Number (T2): 3b; T26: X11-246-003-014

**2.5 TDI (114 kW | 2.5 Litre)**

08.01 → 07.02	AYM	8E-1-000 001→	246-082-008-025G	SWP-M-C	
08.01 → 07.02	AYM		246-086-001-007C	HLWP	Plug Number (T2): 3b; T26: X11-246-003-014

**2.5 TDI (120 kW | 2.5 Litre)**

07.02 → 12.04	BCZ		246-082-008-025G	SWP-M-C	
07.02 → 12.04	BCZ		246-083-002-022G	SWP-D-C	

**2.5 TDI quattro (132 kW | 2.5 Litre)**

11.00 → 12.04	AKE, BAU, BDH		246-086-001-007C	HLWP	Plug Number (T2): 3b; T26: X11-246-003-014
---------------	---------------	--	------------------	------	--------------------------------------------

**3.0 (160 kW | 3.0 Litre)**

04.01 → 12.04	BBJ	→8E-5-065-000	246-082-008-025G	SWP-M-C	
04.01 → 12.04	BBJ	→8E-5-065-000	246-083-002-022G	SWP-D-C	

**3.0 (162 kW | 3.0 Litre)**

11.00 → 12.04	ASN, AVK		246-086-001-007C	HLWP	Plug Number (T2): 3b; T26: X11-246-003-014
---------------	----------	--	------------------	------	--------------------------------------------

**3.0 quattro (160 kW | 3.0 Litre)**

04.01 → 12.04	BBJ		246-082-008-025G	SWP-M-C	
04.01 → 12.04	BBJ		246-083-002-022G	SWP-D-C	

**3.0 quattro (162 kW | 3.0 Litre)**

11.00 → 12.04	ASN, AVK		246-086-001-007C	HLWP	Plug Number (T2): 3b; T26: X11-246-003-014
---------------	----------	--	------------------	------	--------------------------------------------

**S4 quattro (253 kW | 4.2 Litre)**

03.03 → 12.04	BBK		246-082-008-025G	SWP-M-C	
03.03 → 12.04	BBK		246-083-002-022G	SWP-D-C	



			<b>VDO</b>		
Date	Engine Code	Chassis No.	Article No.	Product	Information

**AUDI****A4 Avant (8E5, B6)****1.6 (75 kW | 1.6 Litre)**

09.01 - 12.04	ALZ	8E-2-020 001→	246-083-002-022G	SWP-D-C	
09.01 - 12.04	ALZ		246-086-001-007C	HLWP	Plug Number (T2): 3b; T26: X11-246-003-014

**1.8 T (110 kW | 1.8 Litre)**

09.01 - 07.02	AVJ	→8E-5-065-000	246-083-002-022G	SWP-D-C	
09.01 - 07.02	AVJ		246-086-001-007C	HLWP	Plug Number (T2): 3b; T26: X11-246-003-014

**1.8 T (120 kW | 1.8 Litre)**

07.02 - 12.04	BFB	→8E-5-065-000	246-083-002-022G	SWP-D-C	
---------------	-----	---------------	------------------	---------	--

**1.8 T (140 kW | 1.8 Litre)**

11.02 - 12.04	BEX	→8E-5-065-000	246-083-002-022G	SWP-D-C	
---------------	-----	---------------	------------------	---------	--

**1.8 T quattro (110 kW | 1.8 Litre)**

09.01 - 07.02	AVJ	→8E-5-065-000	246-083-002-022G	SWP-D-C	
09.01 - 07.02	AVJ		246-086-001-007C	HLWP	Plug Number (T2): 3b; T26: X11-246-003-014

**1.8 T quattro (120 kW | 1.8 Litre)**

07.02 - 12.04	BFB	→8E-5-065-000	246-083-002-022G	SWP-D-C	
---------------	-----	---------------	------------------	---------	--

**1.8 T quattro (125 kW | 1.8 Litre)**

09.01 - 12.04	AMB		246-083-002-022G	SWP-D-C	
---------------	-----	--	------------------	---------	--

**1.8 T quattro (140 kW | 1.8 Litre)**

11.02 - 12.04	BEX		246-083-002-022G	SWP-D-C	
---------------	-----	--	------------------	---------	--

**1.9 TDI (74 kW | 1.9 Litre)**

11.01 - 12.04	AVB	8E-1-000 001→	246-083-002-022G	SWP-D-C	
11.01 - 12.04	AVB		246-086-001-007C	HLWP	Plug Number (T2): 3b; T26: X11-246-003-014

**1.9 TDI (85 kW | 1.9 Litre)**

06.04 - 12.04	BKE	8E-1000 001→	246-083-002-022G	SWP-D-C	
---------------	-----	--------------	------------------	---------	--

**1.9 TDI (96 kW | 1.9 Litre)**

09.01 - 12.04	AVF, AWX	8E-1-000 001→	246-083-002-022G	SWP-D-C	
09.01 - 12.04	AVF, AWX		246-086-001-007C	HLWP	Plug Number (T2): 3b; T26: X11-246-003-014

**1.9 TDI quattro (96 kW | 1.9 Litre)**

11.01 - 12.04	AVF	→8E-5-400 000	246-083-002-022G	SWP-D-C	
11.01 - 12.04	AVF		246-086-001-007C	HLWP	Plug Number (T2): 3b; T26: X11-246-003-014

**2.0 (96 kW | 2.0 Litre)**

09.01 - 12.04	ALT	→8E-3-500 000	246-083-002-022G	SWP-D-C	
09.01 - 12.04	ALT		246-086-001-007C	HLWP	Plug Number (T2): 3b; T26: X11-246-003-014

**2.0 FSI (110 kW | 2.0 Litre)**

07.02 - 12.04	AWA	8E-1000 001→	246-083-002-022G	SWP-D-C	
---------------	-----	--------------	------------------	---------	--

**2.4 (120 kW | 2.4 Litre)**

09.01 - 12.04	AMM	8E-2-020 001→	246-083-002-022G	SWP-D-C	
---------------	-----	---------------	------------------	---------	--

**2.4 (125 kW | 2.4 Litre)**

09.01 - 12.04	BDV	→8E-3-500 000	246-083-002-022G	SWP-D-C	
09.01 - 12.04	BDV		246-086-001-007C	HLWP	Plug Number (T2): 3b; T26: X11-246-003-014

**2.5 TDI (114 kW | 2.5 Litre)**

09.01 - 07.02	AYM	→8E-5-400 000	246-083-002-022G	SWP-D-C	
09.01 - 07.02	AYM		246-086-001-007C	HLWP	Plug Number (T2): 3b; T26: X11-246-003-014

**2.5 TDI (120 kW | 2.5 Litre)**

07.02 - 12.04	BFC, BCZ, BDG	F 4B-2-110 001→	246-083-002-022G	SWP-D-C	
---------------	---------------	-----------------	------------------	---------	--

**2.5 TDi (132 kW | 2.5 Litre)**

10.00 - 05.03	AKE	→8E-5-400 000	246-083-002-022G	SWP-D-C	
---------------	-----	---------------	------------------	---------	--

**2.5 TDI quattro (132 kW | 2.5 Litre)**

09.01 - 12.04	AKE, BAU, BDH	F 4B-2-110 001→	246-083-002-022G	SWP-D-C	
09.01 - 12.04	AKE, BAU, BDH		246-086-001-007C	HLWP	Plug Number (T2): 3b; T26: X11-246-003-014

**3.0 (160 kW | 3.0 Litre)**

04.01 - 12.04	BBJ		246-083-002-022G	SWP-D-C	
---------------	-----	--	------------------	---------	--

**3.0 (162 kW | 3.0 Litre)**

09.01 - 12.04	ASN		246-083-002-022G	SWP-D-C	
09.01 - 12.04	ASN		246-086-001-007C	HLWP	Plug Number (T2): 3b; T26: X11-246-003-014

**3.0 quattro (160 kW | 3.0 Litre)**

04.01 - 12.04	BBJ	→8E-5-065-000	246-083-002-022G	SWP-D-C	
---------------	-----	---------------	------------------	---------	--

**3.0 quattro (162 kW | 3.0 Litre)**

09.01 - 12.04	ASN, AVK	→8E-5-065-000	246-083-002-022G	SWP-D-C	
09.01 - 12.04	ASN, AVK		246-086-001-007C	HLWP	Plug Number (T2): 3b; T26: X11-246-003-014

**S4 quattro (253 kW | 4.2 Litre)**

03.03 - 12.04	BBK		246-082-008-025G	SWP-M-C	
03.03 - 12.04	BBK		246-083-002-022G	SWP-D-C	



			<b>VDO</b>		
Date	Engine Code	Chassis No.	Article No.	Product	Information

**AUDI****A4 Convertible (8H7, B6, 8HE, B7)**

<b>1.8 (125 kW   1.8 Litre)</b>					
10.02 → 10.05	AMB		246-082-008-025G	SWP-M-C	
<b>1.8 T (120 kW   1.8 Litre)</b>					
07.02 → 03.09	BFB	→8H-5-006 750	246-082-008-025G	SWP-M-C	
07.02 → 03.09	BFB		246-086-001-007C	HLWP	Plug Number (T2): 3b
<b>1.8 T quattro (120 kW   1.8 Litre)</b>					
05.03 → 03.09	BFB		246-082-008-025G	SWP-M-C	
<b>2.0 (96 kW   2.0 Litre)</b>					
09.04 → 12.05	ALT		246-082-008-025G	SWP-M-C	
<b>2.0 TDI (100 kW   2.0 Litre)</b>					
01.06 → 03.09	BRC		246-082-008-025G	SWP-M-C	
<b>2.0 TDI (103 kW   2.0 Litre)</b>					
01.06 → 03.09	BPW		246-082-008-025G	SWP-M-C	
<b>2.0 TFSI 16V (147 kW   2.0 Litre)</b>					
01.06 → 03.09	BWE		246-082-008-025G	SWP-M-C	
<b>2.4 (120 kW   2.4 Litre)</b>					
04.02 → 12.05	AMM		246-082-008-025G	SWP-M-C	
04.02 → 12.05	AMM		246-086-001-007C	HLWP	Plug Number (T2): 3b
<b>2.4 (125 kW   2.4 Litre)</b>					
04.02 → 12.05	BDV		246-082-008-025G	SWP-M-C	
04.02 → 12.05	BDV		246-086-001-007C	HLWP	Plug Number (T2): 3b
<b>2.5 TDI (120 kW   2.5 Litre)</b>					
08.02 → 12.05	BCZ, BDG, BFC	F 4B-2-110 001→	246-082-008-025G	SWP-M-C	
08.02 → 12.05	BCZ, BDG, BFC		246-086-001-007C	HLWP	Plug Number (T2): 3b
<b>2.7 TDI (132 kW   2.7 Litre)</b>					
06.06 → 03.09	BPP		246-082-008-025G	SWP-M-C	
<b>3.0 (162 kW   3.0 Litre)</b>					
04.02 → 12.05	ASN		246-082-008-025G	SWP-M-C	
04.02 → 12.05	ASN		246-086-001-007C	HLWP	Plug Number (T2): 3b
<b>3.0 quattro (162 kW   3.0 Litre)</b>					
05.03 → 12.05	ASN	→8H-5-006 750	246-082-008-025G	SWP-M-C	
<b>3.0 TDI quattro (150 kW   3.0 Litre)</b>					
01.06 → 03.09	BKN		246-082-008-025G	SWP-M-C	T26: 1J0 955 665 H
<b>3.0 TDI quattro (171 kW   3.0 Litre)</b>					
01.06 → 03.09	ASB		246-082-008-025G	SWP-M-C	
<b>3.2 FSI (188 kW   3.2 Litre)</b>					
01.06 → 03.09	AUK		246-082-008-025G	SWP-M-C	T26: 1J0 955 665 H
<b>3.2 FSI quattro (188 kW   3.2 Litre)</b>					
01.06 → 03.09	AUK		246-082-008-025G	SWP-M-C	T26: 1J0 955 665 H
<b>RS4 quattro (309 kW   4.2 Litre)</b>					
06.06 → 03.09	BNS		246-082-008-025G	SWP-M-C	T26: 1J0 955 665 H
<b>S4 quattro (253 kW   4.2 Litre)</b>					
03.04 → 03.09	BBK		246-082-008-025G	SWP-M-C	

**A4 (8EC, B7)**

<b>1.6 (75 kW   1.6 Litre)</b>					
11.04 → 06.08	ALZ	8E-5-400 001→	246-082-008-025G	SWP-M-C	
11.04 → 06.08	ALZ	8E-5-400 001→	246-083-002-022G	SWP-D-C	
<b>1.8 T (120 kW   1.8 Litre)</b>					
11.04 → 06.08	BFB		246-082-008-025G	SWP-M-C	
11.04 → 06.08	BFB		246-083-002-022G	SWP-D-C	
<b>1.8 T quattro (120 kW   1.8 Litre)</b>					
11.04 → 06.08	BFB	→8E-5-065 000	246-082-008-025G	SWP-M-C	
11.04 → 06.08	BFB	→8E-5-065 000	246-083-002-022G	SWP-D-C	
<b>1.9 TDI (85 kW   1.9 Litre)</b>					
11.04 → 06.08	BKE, BRB	8E-5-400 001→	246-082-008-025G	SWP-M-C	
11.04 → 06.08	BKE, BRB	8E-5-400 001→	246-083-002-022G	SWP-D-C	
<b>2.0 (96 kW   2.0 Litre)</b>					
11.04 → 06.08	ALT	8E-5-400 001→	246-082-008-025G	SWP-M-C	
11.04 → 06.08	ALT	8E-5-400 001→	246-083-002-022G	SWP-D-C	
<b>2.0 FSi (110 kW   2.0 Litre)</b>					
01.05 → 07.05	AWA	8E-1-000 001→	246-082-008-025G	SWP-M-C	



			<b>VDO</b>		
Date	Engine Code	Chassis No.	Article No.	Product	Information

**AUDI****A4 (8EC, B7)****2.0 TDI (100 kW | 2.0 Litre)**

11.04 - 06.08 BNA, BRF

8E-5-400 001→

246-082-008-025G

SWP-M-C

11.04 - 06.08 BNA, BRF

8E-5-400 001→

246-083-002-022G

SWP-D-C

**2.0 TDI (103 kW | 2.0 Litre)**

11.04 - 06.08 BPW

246-082-008-025G

SWP-M-C

**2.0 TDI (120 kW | 2.0 Litre)**

06.06 - 06.08 BVA

246-082-008-025G

SWP-M-C

**2.0 TDI (125 kW | 2.0 Litre)**

06.06 - 06.08 BRD

246-082-008-025G

SWP-M-C

**2.0 TDI (89 kW | 2.0 Litre)**

09.05 - 09.06 BVG

246-082-008-025G

SWP-M-C

T26: 1J0 955 665 H

**2.0 TDI (93 kW | 2.0 Litre)**

11.05 - 11.06 BVF

246-082-008-025G

SWP-M-C

T26: 1J0 955 665 H

**2.0 TDI 16V (103 kW | 2.0 Litre)**

11.04 - 06.08 BLB, BRE

8E-5-400 001→

246-082-008-025G

SWP-M-C

11.04 - 06.08 BLB, BRE

8E-5-400 001→

246-083-002-022G

SWP-D-C

**2.0 TDI quattro (103 kW | 2.0 Litre)**

01.06 - 06.08 BPW

246-082-008-025G

SWP-M-C

**2.0 TDI quattro (120 kW | 2.0 Litre)**

06.06 - 06.08 BVA

246-082-008-025G

SWP-M-C

**2.0 TDI quattro (125 kW | 2.0 Litre)**

06.06 - 06.08 BRD

246-082-008-025G

SWP-M-C

**2.0 TFSI (125 kW | 2.0 Litre)**

10.06 - 06.08 BYK

246-082-008-025G

SWP-M-C

**2.0 TFSI (147 kW | 2.0 Litre)**

11.04 - 06.08 BWE

246-082-008-025G

SWP-M-C

11.04 - 06.08 BWE

246-083-002-022G

SWP-D-C

**2.0 TFSI (162 kW | 2.0 Litre)**

06.05 - 06.08 BUL

246-082-008-025G

SWP-M-C

T26: 8E0 201 263 G

06.05 - 06.08 BUL

246-083-002-022G

SWP-D-C

T26: 8E0 201 263 G

**2.0 TFSI quattro (147 kW | 2.0 Litre)**

11.04 - 06.08 BGB, BWE, BWT, BPG

8E-5-400 001→

246-082-008-025G

SWP-M-C

11.04 - 06.08 BGB, BWE, BWT, BPG

8E-5-400 001→

246-083-002-022G

SWP-D-C

**2.0 TFSI quattro (162 kW | 2.0 Litre)**

06.05 - 06.08 BUL

8E-5-400 001→

246-082-008-025G

SWP-M-C

06.05 - 06.08 BUL

8E-5-400 001→

246-083-002-022G

SWP-D-C

**2.5 TDI (120 kW | 2.5 Litre)**

11.04 - 05.06 BDG

8E-5-400 001→

246-082-008-025G

SWP-M-C

11.04 - 05.06 BDG

8E-5-400 001→

246-083-002-022G

SWP-D-C

**2.7 TDI (120 kW | 2.7 Litre)**

11.05 - 06.08 BSG

246-082-008-025G

SWP-M-C

**2.7 TDI (132 kW | 2.7 Litre)**

01.06 - 06.08 BPP

246-082-008-025G

SWP-M-C

**3.0 (160 kW | 3.0 Litre)**

11.04 - 05.06 BBJ

-8E-5-065 000

246-082-008-025G

SWP-M-C

**3.0 quattro (160 kW | 3.0 Litre)**

11.04 - 07.06 BBJ

246-082-008-025G

SWP-M-C

**3.0 TDI quattro (150 kW | 3.0 Litre)**

11.04 - 06.08 BKN

8E-5-400 001→

246-082-008-025G

SWP-M-C

11.04 - 06.08 BKN

8E-5-400 001→

246-083-002-022G

SWP-D-C

**3.0 TDI quattro (171 kW | 3.0 Litre)**

01.06 - 06.08 ASB

246-082-008-025G

SWP-M-C

**3.2 FSI (188 kW | 3.2 Litre)**

01.05 - 06.08 AUK

8E-5-400 001→

246-082-008-025G

SWP-M-C

01.05 - 06.08 AUK

8E-5-400 001→

246-083-002-022G

SWP-D-C

**3.2 FSI quattro (188 kW | 3.2 Litre)**

01.05 - 06.08 AUK, BKH

8E-5-400 001→

246-082-008-025G

SWP-M-C

01.05 - 06.08 AUK, BKH

8E-5-400 001→

246-083-002-022G

SWP-D-C

**RS4 quattro (309 kW | 4.2 Litre)**

09.05 - 06.08 BNS

246-082-008-025G

SWP-M-C

09.05 - 06.08 BNS

246-083-002-022G

SWP-D-C

**S4 quattro (253 kW | 4.2 Litre)**

11.04 - 06.08 BBK, BHF

246-082-008-025G

SWP-M-C

T26: 1J0 955 665 H



			<b>VDO</b>		
Date	Engine Code	Chassis No.	Article No.	Product	Information

**AUDI****A4 Avant (8ED, B7)**

<b>1.6 (75 kW   1.6 Litre)</b>					
11.04 - 06.08	ALZ	8E-5-400 001→	246-083-002-022G	SWP-D-C	
<b>1.8 T (120 kW   1.8 Litre)</b>					
11.04 - 06.08	BFB	→8E-5-065 000	246-083-002-022G	SWP-D-C	
<b>1.8 T quattro (120 kW   1.8 Litre)</b>					
11.04 - 06.08	BFB		246-083-002-022G	SWP-D-C	
<b>1.9 TDI (85 kW   1.9 Litre)</b>					
11.04 - 06.08	BKE, BRB		246-083-002-022G	SWP-D-C	
<b>2.0 (96 kW   2.0 Litre)</b>					
11.04 - 06.08	ALT		246-083-002-022G	SWP-D-C	
<b>2.0 FSi (110 kW   2.0 Litre)</b>					
01.05 - 07.05	AWA		246-083-002-022G	SWP-D-C	
<b>2.0 TDI (100 kW   2.0 Litre)</b>					
11.04 - 06.08	BNA, BRF	8E-1-000 001→	246-083-002-022G	SWP-D-C	
<b>2.0 TDI (103 kW   2.0 Litre)</b>					
11.04 - 06.08	BPW	8E-1-000 001→	246-083-002-022G	SWP-D-C	
<b>2.0 TDI (120 kW   2.0 Litre)</b>					
06.06 - 06.08	BVA		246-083-002-022G	SWP-D-C	
<b>2.0 TDI (125 kW   2.0 Litre)</b>					
06.06 - 06.08	BRD		246-083-002-022G	SWP-D-C	
<b>2.0 TDI (89 kW   2.0 Litre)</b>					
09.05 - 09.06	BVG	→8E-5-400 000	246-083-002-022G	SWP-D-C	
<b>2.0 TDI (93 kW   2.0 Litre)</b>					
11.05 - 11.06	BVF		246-083-002-022G	SWP-D-C	
<b>2.0 TDI 16V (103 kW   2.0 Litre)</b>					
11.04 - 06.08	BLB, BRE		246-083-002-022G	SWP-D-C	
<b>2.0 TDI quattro (103 kW   2.0 Litre)</b>					
01.06 - 06.08	BPW		246-083-002-022G	SWP-D-C	
<b>2.0 TDI quattro (120 kW   2.0 Litre)</b>					
06.06 - 06.08	BVA		246-083-002-022G	SWP-D-C	
<b>2.0 TDI quattro (125 kW   2.0 Litre)</b>					
06.06 - 06.08	BRD		246-083-002-022G	SWP-D-C	
<b>2.0 TFSI (125 kW   2.0 Litre)</b>					
10.06 - 06.08	BYK, BPJ	8E-1-000 001→	246-083-002-022G	SWP-D-C	
<b>2.0 TFSI (147 kW   2.0 Litre)</b>					
11.04 - 06.08	BGB, BWE	8E-5-400 001→	246-083-002-022G	SWP-D-C	
<b>2.0 TFSI (162 kW   2.0 Litre)</b>					
06.05 - 06.08	BUL		246-083-002-022G	SWP-D-C	T26: 8E0 201 263 G
<b>2.0 TFSI quattro (147 kW   2.0 Litre)</b>					
11.04 - 06.08	BGB, BWE		246-083-002-022G	SWP-D-C	
<b>2.0 TFSI quattro (162 kW   2.0 Litre)</b>					
06.05 - 06.08	BUL		246-083-002-022G	SWP-D-C	
<b>2.5 TDI (120 kW   2.5 Litre)</b>					
11.04 - 05.06	BDG		246-083-002-022G	SWP-D-C	
<b>2.7 TDi (120 kW   2.7 Litre)</b>					
11.05 - 03.08	BSG		246-083-002-022G	SWP-D-C	
<b>2.7 TDI (132 kW   2.7 Litre)</b>					
01.06 - 06.08	BPP		246-083-002-022G	SWP-D-C	
<b>3.0 (160 kW   3.0 Litre)</b>					
11.04 - 05.06	BBJ		246-083-002-022G	SWP-D-C	
<b>3.0 quattro (160 kW   3.0 Litre)</b>					
11.04 - 07.06	BBJ	→8E-5-065 000	246-083-002-022G	SWP-D-C	
<b>3.0 TDI quattro (150 kW   3.0 Litre)</b>					
11.04 - 06.08	BKN		246-083-002-022G	SWP-D-C	
<b>3.0 TDI quattro (171 kW   3.0 Litre)</b>					
01.06 - 06.08	ASB		246-083-002-022G	SWP-D-C	
<b>3.2 FSi (188 kW   3.2 Litre)</b>					
01.05 - 06.08	AUK	8E-5-400 001→	246-083-002-022G	SWP-D-C	
<b>3.2 FSi quattro (188 kW   3.2 Litre)</b>					
01.05 - 06.08	AUK	8E-5-400 001→	246-083-002-022G	SWP-D-C	
<b>RS4 quattro (309 kW   4.2 Litre)</b>					
09.05 - 06.08	BNS	→8E-5-400 000	246-083-002-022G	SWP-D-C	



			<b>VDO</b>		
Date	Engine Code	Chassis No.	Article No.	Product	Information

**AUDI****A4 Avant (8ED, B7)****S4 quattro (253 kW | 4.2 Litre)**

11.04 → 06.08	BBK	→8E-5-400 000	246-083-002-022G	SWP-D-C
---------------	-----	---------------	------------------	---------

**A4 (8K2, B8)****1.8 TFSI (118 kW | 1.8 Litre)**

11.07 →	CABB		246-082-008-025G	SWP-M-C
---------	------	--	------------------	---------

**1.8 TFSI (88 kW | 1.8 Litre)**

01.08 →	CABA, CDHA	8K-8-000 001→	246-082-008-025G	SWP-M-C
---------	------------	---------------	------------------	---------

**1.8 TFSI quattro (118 kW | 1.8 Litre)**

09.08 →	CDHB	8K-8-000 001→	246-082-008-025G	SWP-M-C
---------	------	---------------	------------------	---------

**2.0 TDI (100 kW | 2.0 Litre)**

11.07 →	CAGB		246-082-008-025G	SWP-M-C
---------	------	--	------------------	---------

**2.0 TDI (105 kW | 2.0 Litre)**

11.07 →	CAGA		246-082-008-025G	SWP-M-C
---------	------	--	------------------	---------

**2.0 TDI (120 kW | 2.0 Litre)**

08.08 →	CAHB	8K-8-000 001→	246-082-008-025G	SWP-M-C
---------	------	---------------	------------------	---------

**2.0 TDI quattro (105 kW | 2.0 Litre)**

11.08 →	CAGA	8K-8-000 001→	246-082-008-025G	SWP-M-C
---------	------	---------------	------------------	---------

**2.0 TFSI flexible fuel (132 kW | 2.0 Litre)**

11.09 →	CFKA		246-082-008-025G	SWP-M-C
---------	------	--	------------------	---------

**2.0 TFSI flexible fuel quattro (132 kW | 2.0 Litre)**

11.09 →	CFKA		246-082-008-025G	SWP-M-C
---------	------	--	------------------	---------

**2.7 TDI (120 kW | 2.7 Litre)**

11.07 →	CAMB		246-082-008-025G	SWP-M-C
---------	------	--	------------------	---------

**2.7 TDI (140 kW | 2.7 Litre)**

11.07 →	CAMA		246-082-008-025G	SWP-M-C
---------	------	--	------------------	---------

**3.0 TDI quattro (155 kW | 3.0 Litre)**

06.08 →	CCWB	8K-8-000 001→	246-082-008-025G	SWP-M-C
---------	------	---------------	------------------	---------

**3.0 TDI quattro (176 kW | 3.0 Litre)**

11.07 →	CAPA		246-082-008-025G	SWP-M-C
---------	------	--	------------------	---------

**3.2 FSI (195 kW | 3.2 Litre)**

09.08 →	CALA	8K-8-000 001→	246-082-008-025G	SWP-M-C
---------	------	---------------	------------------	---------

**3.2 FSI quattro (195 kW | 3.2 Litre)**

11.07 →	CALA		246-082-008-025G	SWP-M-C
---------	------	--	------------------	---------

**S4 quattro (245 kW | 3.0 Litre)**

11.08 →	CAKA, CCBA	8K-8-000 001→	246-082-008-025G	SWP-M-C
---------	------------	---------------	------------------	---------

**A4 Avant (8K5, B8)****1.8 TFSI (118 kW | 1.8 Litre)**

04.08 →	CABB, CDHB, CCUA	→8E-8-000 001	246-083-002-022G	SWP-D-C
---------	------------------	---------------	------------------	---------

**1.8 TFSI quattro (118 kW | 1.8 Litre)**

09.08 →	CDHB	8K-8-000 001→	246-083-002-022G	SWP-D-C
---------	------	---------------	------------------	---------

**2.0 TDI (100 kW | 2.0 Litre)**

04.08 →	CAGB	8K-8-000 001→	246-083-002-022G	SWP-D-C
---------	------	---------------	------------------	---------

**2.0 TDI (105 kW | 2.0 Litre)**

04.08 →	CAGA, CMEA, CJCA, CMFA	8K-8-000 001→	246-083-002-022G	SWP-D-C
---------	------------------------	---------------	------------------	---------

**2.0 TDI (120 kW | 2.0 Litre)**

08.08 →	CAHB	8K-8-000 001→	246-083-002-022G	SWP-D-C
---------	------	---------------	------------------	---------

**2.0 TDI (125 kW | 2.0 Litre)**

04.08 →	CAHA	8K-8-000 001→	246-083-002-022G	SWP-D-C
---------	------	---------------	------------------	---------

**2.0 TDI (88 kW | 2.0 Litre)**

06.08 →	CAGC	8K-8-000 001→	246-083-002-022G	SWP-D-C
---------	------	---------------	------------------	---------

**2.0 TDI quattro (105 kW | 2.0 Litre)**

04.08 →	CAGA	8K-8-000 001→	246-083-002-022G	SWP-D-C
---------	------	---------------	------------------	---------

**2.0 TDI quattro (125 kW | 2.0 Litre)**

08.08 →	CAHA	8K-8-000 001→	246-083-002-022G	SWP-D-C
---------	------	---------------	------------------	---------

**2.0 TFSI (132 kW | 2.0 Litre)**

06.08 →	CDNB, CDZA	8K-8-000 001→	246-083-002-022G	SWP-D-C
---------	------------	---------------	------------------	---------

**2.0 TFSI flexible fuel (132 kW | 2.0 Litre)**

11.09 →	CFKA		246-083-002-022G	SWP-D-C
---------	------	--	------------------	---------

**2.0 TFSI flexible fuel quattro (132 kW | 2.0 Litre)**

11.09 →	CFKA		246-083-002-022G	SWP-D-C
---------	------	--	------------------	---------





			<b>VDO</b>		
Date	Engine Code	Chassis No.	Article No.	Product	Information

**AUDI****A4 Avant (8K5, B8)**

<b>2.0 TFSI quattro (155 kW   2.0 Litre)</b>					
06.08 →	CDNC	8K-8-000 001→	246-083-002-022G	SWP-D-C	
<b>2.7 TDI (140 kW   2.7 Litre)</b>					
04.08 →	CAMA, CGKA	8K-8-000 001→	246-083-002-022G	SWP-D-C	
<b>3.0 TDI quattro (155 kW   3.0 Litre)</b>					
06.08 →	CCWB	8K-8-000 001→	246-083-002-022G	SWP-D-C	
<b>3.0 TDI quattro (176 kW   3.0 Litre)</b>					
04.08 →	CAPA, CCWA, CCLA	8K-8-000 001→	246-083-002-022G	SWP-D-C	
<b>3.2 FSI (195 kW   3.2 Litre)</b>					
09.08 →	CALA	8K-8-000 001→	246-083-002-022G	SWP-D-C	
<b>3.2 FSI quattro (195 kW   3.2 Litre)</b>					
04.08 →	CALA	→8E-8-000 001	246-083-002-022G	SWP-D-C	
<b>S4 quattro (245 kW   3.0 Litre)</b>					
11.08 →	CAKA	8K-8-000 001→	246-083-002-022G	SWP-D-C	

**A4 Allroad (8KH, B8)**

<b>2.0 TDI quattro (100 kW   2.0 Litre)</b>					
09.09 →	CAGB		246-082-008-025G	SWP-M-C	
09.09 →	CAGB		246-083-002-022G	SWP-D-C	
<b>2.0 TDI quattro (105 kW   2.0 Litre)</b>					
09.09 →	CAGA		246-082-008-025G	SWP-M-C	
09.09 →	CAGA		246-083-002-022G	SWP-D-C	
<b>2.0 TDI quattro (120 kW   2.0 Litre)</b>					
04.09 →	CAHB		246-082-008-025G	SWP-M-C	
04.09 →	CAHB		246-083-002-022G	SWP-D-C	
<b>2.0 TDI quattro (125 kW   2.0 Litre)</b>					
04.09 →	CAHA		246-082-008-025G	SWP-M-C	
04.09 →	CAHA		246-083-002-022G	SWP-D-C	
<b>2.0 TDI quattro (130 kW   2.0 Litre)</b>					
11.11 →	CGLC		A2C53304876	HLWP	
<b>2.0 TFSI quattro (155 kW   2.0 Litre)</b>					
04.09 →	CDNC		246-082-008-025G	SWP-M-C	
04.09 →	CDNC		246-083-002-022G	SWP-D-C	
<b>3.0 TDI quattro (176 kW   3.0 Litre)</b>					
04.09 →	CCWA		246-082-008-025G	SWP-M-C	
04.09 →	CCWA		246-083-002-022G	SWP-D-C	
<b>3.0 TDI quattro (180 kW   3.0 Litre)</b>					
01.12 →	CKVB, CDUC		A2C53304876	HLWP	

**A5 (8T3)**

<b>1.8 TFSI (118 kW   1.8 Litre)</b>					
05.09 →	CDHB		246-082-008-025G	SWP-M-C	
<b>1.8 TFSI (125 kW   1.8 Litre)</b>					
10.07 →	CABD		246-082-008-025G	SWP-M-C	
<b>2.0 TDI (120 kW   2.0 Litre)</b>					
08.08 →	CAHB		246-082-008-025G	SWP-M-C	
<b>2.0 TDI (125 kW   2.0 Litre)</b>					
08.08 →	CAHA		246-082-008-025G	SWP-M-C	
<b>2.0 TDI quattro (125 kW   2.0 Litre)</b>					
08.08 →	CAHA		246-082-008-025G	SWP-M-C	
<b>2.0 TFSI (132 kW   2.0 Litre)</b>					
11.08 →	CDNB		246-082-008-025G	SWP-M-C	
<b>2.0 TFSI (155 kW   2.0 Litre)</b>					
06.08 →	CDNC		246-082-008-025G	SWP-M-C	
<b>2.0 TFSI quattro (155 kW   2.0 Litre)</b>					
06.08 →	CAEB, CDNC		246-082-008-025G	SWP-M-C	
<b>2.7 TDI (120 kW   2.7 Litre)</b>					
09.07 →	CAMB, CGKB		246-082-008-025G	SWP-M-C	
<b>2.7 TDI (140 kW   2.7 Litre)</b>					
06.07 →	CAMA, CGKA		246-082-008-025G	SWP-M-C	
<b>3.0 TDI quattro (155 kW   3.0 Litre)</b>					
03.08 →	CCWB		246-082-008-025G	SWP-M-C	



			<b>VDO</b>		
Date	Engine Code	Chassis No.	Article No.	Product	Information

**AUDI****A5 (8T3)****3.0 TDI quattro (176 kW | 3.0 Litre)**

06.07 → CAPA, CCWA 246-082-008-025G SWP-M-C

**3.2 FSI (195 kW | 3.2 Litre)**

06.07 → CALA 246-082-008-025G SWP-M-C

**3.2 FSI quattro (195 kW | 3.2 Litre)**

06.07 → CALA 246-082-008-025G SWP-M-C

**S5 quattro (260 kW | 4.2 Litre)**

06.07 → CAUA 246-082-008-025G SWP-M-C

**A5 Sportback (8TA)****1.8 TFSI (118 kW | 1.8 Litre)**

11.09 → CDHB 246-082-008-025G SWP-M-C

**2.0 TDI (100 kW | 2.0 Litre)**

09.09 → CAGB 246-082-008-025G SWP-M-C

**2.0 TDI (105 kW | 2.0 Litre)**

09.09 → CAGA, CMEA 246-082-008-025G SWP-M-C

**2.0 TDI (120 kW | 2.0 Litre)**

09.09 → CAHB 246-082-008-025G SWP-M-C

**2.0 TDI (125 kW | 2.0 Litre)**

09.09 → CAHA 246-082-008-025G SWP-M-C

**2.0 TDI quattro (125 kW | 2.0 Litre)**

09.09 → CAHA 246-082-008-025G SWP-M-C

**2.0 TFSI (132 kW | 2.0 Litre)**

09.09 → CDNB 246-082-008-025G SWP-M-C

**2.0 TFSI (155 kW | 2.0 Litre)**

09.09 → CDNC 246-082-008-025G SWP-M-C

**2.0 TFSI quattro (155 kW | 2.0 Litre)**

09.09 → CDNC 246-082-008-025G SWP-M-C

**2.7 TDI (120 kW | 2.7 Litre)**

09.09 → CGKB 246-082-008-025G SWP-M-C

**2.7 TDI (140 kW | 2.7 Litre)**

09.09 → CGKA 246-082-008-025G SWP-M-C

**3.0 TDI quattro (176 kW | 3.0 Litre)**

09.09 → CCWA 246-082-008-025G SWP-M-C

**3.2 FSI quattro (195 kW | 3.2 Litre)**

09.09 → CALA 246-082-008-025G SWP-M-C

**S5 quattro (245 kW | 3.0 Litre)**

01.10 → CAKA 246-082-008-025G SWP-M-C

**A5 Convertible (8F7)****1.8 TFSI (118 kW | 1.8 Litre)**

09.09 → CDHB 246-082-008-025G SWP-M-C

**2.0 TDI (120 kW | 2.0 Litre)**

05.09 → CAHB 246-082-008-025G SWP-M-C

**2.0 TDI (125 kW | 2.0 Litre)**

05.09 → CAHA 246-082-008-025G SWP-M-C

**2.0 TDI quattro (130 kW | 2.0 Litre)**

01.12 → CGLC A2C53304876 HLWP

**2.0 TFSI (132 kW | 2.0 Litre)**

03.09 → CAEA, CDNB 246-082-008-025G SWP-M-C

**2.0 TFSI (155 kW | 2.0 Litre)**

03.09 → CAEB, CDNC 246-082-008-025G SWP-M-C

**2.0 TFSI quattro (155 kW | 2.0 Litre)**

03.09 → CAEB, CDNC 246-082-008-025G SWP-M-C

**2.7 TDI (120 kW | 2.7 Litre)**

05.09 → CGKB 246-082-008-025G SWP-M-C

**2.7 TDI (140 kW | 2.7 Litre)**

03.09 → CGKA 246-082-008-025G SWP-M-C

**3.0 TDI quattro (176 kW | 3.0 Litre)**

03.09 → CCWA 246-082-008-025G SWP-M-C

**3.2 FSI (195 kW | 3.2 Litre)**

03.09 → CALA 246-082-008-025G SWP-M-C



			<b>VDO</b>		
Date	Engine Code	Chassis No.	Article No.	Product	Information

**AUDI****A5 Convertible (8F7)****3.2 FSI quattro (195 kW | 3.2 Litre)**

03.09 - CALA

246-082-008-025G

SWP-M-C

**S5 quattro (245 kW | 3.0 Litre)**

06.09 - CAKA, CCBA

246-082-008-025G

SWP-M-C

**A6 (4A, C4)****1.8 (92 kW | 1.8 Litre)**

12.95 - 10.97 ADR

246-082-008-014C

SWP-M-C

Plug Number (T2): 1

**1.8 quattro (92 kW | 1.8 Litre)**

12.95 - 03.97 ADR

246-082-008-014C

SWP-M-C

Plug Number (T2): 1

12.95 - 03.97 ADR

246-086-001-002C

HLWP

Plug Number (T2): 3

**1.9 TDI (66 kW | 1.9 Litre)**

06.94 - 10.97 1Z, AHU

246-082-008-014C

SWP-M-C

Plug Number (T2): 1

**2.0 (74 kW | 2.0 Litre)**

06.94 - 10.97 AAE

246-082-008-014C

SWP-M-C

Plug Number (T2): 1

**2.0 (85 kW | 2.0 Litre)**

06.94 - 10.97 ABK

246-082-008-014C

SWP-M-C

Plug Number (T2): 1

**2.0 16V (103 kW | 2.0 Litre)**

06.94 - 10.97 ACE

246-082-008-014C

SWP-M-C

Plug Number (T2): 1

**2.0 16V quattro (103 kW | 2.0 Litre)**

06.94 - 03.97 ACE

246-082-008-014C

SWP-M-C

Plug Number (T2): 1

06.94 - 03.97 ACE

246-086-001-002C

HLWP

Plug Number (T2): 3

**2.3 (98 kW | 2.3 Litre)**

06.94 - 12.95 AAR

246-082-008-014C

SWP-M-C

Plug Number (T2): 1

**2.3 quattro (98 kW | 2.3 Litre)**

08.94 - 12.95 AAR

246-082-008-014C

SWP-M-C

Plug Number (T2): 1

08.94 - 12.95 AAR

246-086-001-002C

HLWP

Plug Number (T2): 3

**2.5 TDI (103 kW | 2.5 Litre)**

08.94 - 10.97 AEL

246-082-008-014C

SWP-M-C

Plug Number (T2): 1

**2.5 TDI (84 kW | 2.5 Litre)**

01.95 - 10.97 AAT

246-082-008-014C

SWP-M-C

Plug Number (T2): 1

**2.5 TDI (85 kW | 2.5 Litre)**

06.94 - 10.97 AAT

246-082-008-014C

SWP-M-C

Plug Number (T2): 1

**2.5 TDI quattro (103 kW | 2.5 Litre)**

10.95 - 03.97 AEL

246-082-008-014C

SWP-M-C

Plug Number (T2): 1

10.95 - 03.97 AEL

246-086-001-002C

HLWP

Plug Number (T2): 3

**2.6 (102 kW | 2.6 Litre)**

06.94 - 10.97 ACZ

246-082-008-014C

SWP-M-C

Plug Number (T2): 1

**2.6 (110 kW | 2.6 Litre)**

06.94 - 10.97 ABC

246-082-008-014C

SWP-M-C

Plug Number (T2): 1

**2.6 quattro (110 kW | 2.6 Litre)**

06.94 - 03.97 ABC

246-082-008-014C

SWP-M-C

Plug Number (T2): 1

06.94 - 03.97 ABC

246-086-001-002C

HLWP

Plug Number (T2): 3

**2.8 (128 kW | 2.8 Litre)**

06.94 - 10.97 AAH, AEJ, AFC

246-082-008-014C

SWP-M-C

Plug Number (T2): 1

**2.8 (142 kW | 2.8 Litre)**

12.95 - 10.97 ACK

246-082-008-014C

SWP-M-C

Plug Number (T2): 1

**2.8 quattro (128 kW | 2.8 Litre)**

07.94 - 03.97 AAH, AEJ

246-082-008-014C

SWP-M-C

Plug Number (T2): 1

07.94 - 03.97 AAH, AEJ

246-086-001-002C

HLWP

Plug Number (T2): 3

**2.8 quattro (142 kW | 2.8 Litre)**

12.95 - 03.97 ACK

246-082-008-014C

SWP-M-C

Plug Number (T2): 1

12.95 - 03.97 ACK

246-086-001-002C

HLWP

Plug Number (T2): 3

**S6 4.2 quattro (213 kW | 4.2 Litre)**

07.94 - 10.97 AEC

246-086-001-002C

HLWP

Plug Number (T2): 3

**S6 Plus quattro (240 kW | 4.2 Litre)**

06.96 - 10.97 AHK

246-086-001-002C

HLWP

Plug Number (T2): 3

**S6 Turbo quattro (169 kW | 2.2 Litre)**

07.94 - 10.97 AAN

246-086-001-002C

HLWP

Plug Number (T2): 3

**A6 Avant (4A, C4)****1.8 (92 kW | 1.8 Litre)**

12.95 - 09.97 ADR

246-082-008-014C

SWP-M-C

Plug Number (T2): 1; T28: Rear (T29)



					
Date	Engine Code	Chassis No.	Article No.	Product	Information

## AUDI

### A6 Avant (4A, C4)

#### 1.8 quattro (92 kW | 1.8 Litre)

12.95 - 09.97	ADR		246-082-008-014C	SWP-M-C	Plug Number (T2): 1; T28: Rear (T29)
12.95 - 09.97	ADR		246-086-001-002C	HLWP	Plug Number (T2): 3

#### 1.9 TDI (66 kW | 1.9 Litre)

07.94 - 09.97	1Z, AHU		246-082-008-014C	SWP-M-C	Plug Number (T2): 1; T28: Rear (T29)
---------------	---------	--	------------------	---------	--------------------------------------

#### 2.0 (74 kW | 2.0 Litre)

07.94 - 09.97	AAE		246-082-008-014C	SWP-M-C	Plug Number (T2): 1; T28: Rear (T29)
---------------	-----	--	------------------	---------	--------------------------------------

#### 2.0 (85 kW | 2.0 Litre)

06.94 - 12.97	ABK		246-082-008-014C	SWP-M-C	Plug Number (T2): 1; T28: Rear (T29)
---------------	-----	--	------------------	---------	--------------------------------------

#### 2.0 16V (103 kW | 2.0 Litre)

07.94 - 09.97	ACE		246-082-008-014C	SWP-M-C	Plug Number (T2): 1; T28: Rear (T29)
---------------	-----	--	------------------	---------	--------------------------------------

#### 2.0 16V quattro (103 kW | 2.0 Litre)

06.94 - 09.97	ACE		246-082-008-014C	SWP-M-C	Plug Number (T2): 1; T28: Rear (T29)
06.94 - 09.97	ACE		246-086-001-002C	HLWP	Plug Number (T2): 3

#### 2.3 (98 kW | 2.3 Litre)

07.94 - 12.95	AAR		246-082-008-014C	SWP-M-C	Plug Number (T2): 1; T28: Rear (T29)
---------------	-----	--	------------------	---------	--------------------------------------

#### 2.3 quattro (98 kW | 2.3 Litre)

08.94 - 12.95	AAR		246-082-008-014C	SWP-M-C	Plug Number (T2): 1; T28: Rear (T29)
08.94 - 12.95	AAR		246-086-001-002C	HLWP	Plug Number (T2): 3

#### 2.5 TDI (103 kW | 2.5 Litre)

08.94 - 09.97	AEL		246-082-008-014C	SWP-M-C	Plug Number (T2): 1; T28: Rear (T29)
---------------	-----	--	------------------	---------	--------------------------------------

#### 2.5 TDI (84 kW | 2.5 Litre)

01.95 - 09.97	AAT		246-082-008-014C	SWP-M-C	Plug Number (T2): 1; T28: Rear (T29)
---------------	-----	--	------------------	---------	--------------------------------------

#### 2.5 TDI (85 kW | 2.5 Litre)

06.94 - 12.97	AAT		246-082-008-014C	SWP-M-C	Plug Number (T2): 1; T28: Rear (T29)
---------------	-----	--	------------------	---------	--------------------------------------

#### 2.5 TDI quattro (103 kW | 2.5 Litre)

07.95 - 09.97	AEL		246-082-008-014C	SWP-M-C	Plug Number (T2): 1; T28: Rear (T29)
07.95 - 09.97	AEL		246-086-001-002C	HLWP	Plug Number (T2): 3

#### 2.6 (102 kW | 2.6 Litre)

06.94 - 02.97	ACZ		246-082-008-014C	SWP-M-C	Plug Number (T2): 1; T28: Rear (T29)
---------------	-----	--	------------------	---------	--------------------------------------

#### 2.6 (110 kW | 2.6 Litre)

07.94 - 09.97	ABC		246-082-008-014C	SWP-M-C	Plug Number (T2): 1; T28: Rear (T29)
---------------	-----	--	------------------	---------	--------------------------------------

#### 2.6 quattro (110 kW | 2.6 Litre)

06.94 - 09.97	ABC		246-082-008-014C	SWP-M-C	Plug Number (T2): 1; T28: Rear (T29)
06.94 - 09.97	ABC		246-086-001-002C	HLWP	Plug Number (T2): 3

#### 2.8 (128 kW | 2.8 Litre)

07.94 - 09.97	AAH, AEJ		246-082-008-014C	SWP-M-C	Plug Number (T2): 1; T28: Rear (T29)
---------------	----------	--	------------------	---------	--------------------------------------

#### 2.8 (142 kW | 2.8 Litre)

12.95 - 09.97	ACK		246-082-008-014C	SWP-M-C	Plug Number (T2): 1; T28: Rear (T29)
---------------	-----	--	------------------	---------	--------------------------------------

#### 2.8 quattro (128 kW | 2.8 Litre)

06.94 - 09.97	AAH, AEJ		246-082-008-014C	SWP-M-C	Plug Number (T2): 1; T28: Rear (T29)
06.94 - 09.97	AAH, AEJ		246-086-001-002C	HLWP	Plug Number (T2): 3

#### 2.8 quattro (142 kW | 2.8 Litre)

12.95 - 09.97	ACK		246-082-008-014C	SWP-M-C	Plug Number (T2): 1; T28: Rear (T29)
12.95 - 12.97	ACK		246-086-001-002C	HLWP	Plug Number (T2): 3

#### S6 4.2 quattro (213 kW | 4.2 Litre)

07.94 - 12.97	AEC		246-082-008-014C	SWP-M-C	Plug Number (T2): 1; T28: Rear (T29)
07.94 - 12.97	AEC		246-086-001-002C	HLWP	Plug Number (T2): 3

#### S6 Plus quattro (240 kW | 4.2 Litre)

06.96 - 12.97			246-082-008-014C	SWP-M-C	Plug Number (T2): 1; T28: Rear (T29)
06.96 - 12.97	AHK		246-086-001-002C	HLWP	Plug Number (T2): 3

#### S6 Turbo quattro (169 kW | 2.2 Litre)

07.94 - 12.97	AAN		246-082-008-014C	SWP-M-C	Plug Number (T2): 1; T28: Rear (T29)
07.94 - 12.97	AAN		246-086-001-002C	HLWP	Plug Number (T2): 3

### A6 (4B, C5)

#### 1.8 (85 kW | 1.8 Litre)

05.97 - 01.05	AFY		246-082-008-025G	SWP-M-C	
05.97 - 04.99	AFY		246-086-001-002C	HLWP	Plug Number (T2): 3
05.97 - 01.05	AFY		246-086-001-007C	HLWP	Plug Number (T2): 3b; T26: X11-246-003-014

#### 1.8 (92 kW | 1.8 Litre)

07.97 - 01.05	AEB		246-082-008-025G	SWP-M-C	
12.97 - 07.99	AJP, AQE, ARH, ANQ		246-086-001-002C	HLWP	Plug Number (T2): 3



			<b>VDO</b>		
Date	Engine Code	Chassis No.	Article No.	Product	Information

**AUDI****A6 (4B, C5)****1.8 (92 kW | 1.8 Litre)**

07.97 - 01.05	AJP, AQE, ARH, ANQ		246-086-001-007C	HLWP	Plug Number (T2): 3b; T26: X11-246-003-014
---------------	--------------------	--	------------------	------	--------------------------------------------

**1.8 T (110 kW | 1.8 Litre)**

01.97 - 01.05	APU		246-082-008-025G	SWP-M-C	
---------------	-----	--	------------------	---------	--

04.97 - 06.99	AEB, AWL, ANB, APU, ARK, AWT		246-086-001-002C	HLWP	Plug Number (T2): 3
---------------	------------------------------	--	------------------	------	---------------------

01.97 - 01.05	AEB, AWL, ANB, APU, ARK, AWT		246-086-001-007C	HLWP	Plug Number (T2): 3b; T26: X11-246-003-014
---------------	------------------------------	--	------------------	------	--------------------------------------------

**1.8 T (132 kW | 1.8 Litre)**

07.98 - 01.05	AJL		246-082-008-025G	SWP-M-C	
---------------	-----	--	------------------	---------	--

12.97 - 07.98	AJL		246-086-001-002C	HLWP	Plug Number (T2): 3
---------------	-----	--	------------------	------	---------------------

12.97 - 01.05	AJL		246-086-001-007C	HLWP	Plug Number (T2): 3b; T26: X11-246-003-014
---------------	-----	--	------------------	------	--------------------------------------------

**1.8 T quattro (110 kW | 1.8 Litre)**

06.99 - 01.05	AEB, ANB, APU, ARK, AWT		246-082-008-025G	SWP-M-C	
---------------	-------------------------	--	------------------	---------	--

04.97 - 06.99	AEB, ANB, APU, ARK, AWT		246-086-001-002C	HLWP	Plug Number (T2): 3
---------------	-------------------------	--	------------------	------	---------------------

02.97 - 01.05	AEB, ANB, APU, ARK, AWT		246-086-001-007C	HLWP	Plug Number (T2): 3b; T26: X11-246-003-014
---------------	-------------------------	--	------------------	------	--------------------------------------------

**1.8 T quattro (132 kW | 1.8 Litre)**

12.97 - 01.05	AJL		246-082-008-025G	SWP-M-C	
---------------	-----	--	------------------	---------	--

12.97 - 07.98	AJL		246-086-001-002C	HLWP	Plug Number (T2): 3
---------------	-----	--	------------------	------	---------------------

12.97 - 01.05	AJL		246-086-001-007C	HLWP	Plug Number (T2): 3b; T26: X11-246-003-014
---------------	-----	--	------------------	------	--------------------------------------------

**1.9 TDI (81 kW | 1.9 Litre)**

04.97 - 10.00	AFN, AVG		246-082-008-025G	SWP-M-C	
---------------	----------	--	------------------	---------	--

04.97 - 08.99	AFN, AVG		246-086-001-002C	HLWP	Plug Number (T2): 3
---------------	----------	--	------------------	------	---------------------

04.97 - 10.00	AFN, AVG		246-086-001-007C	HLWP	Plug Number (T2): 3b; T26: X11-246-003-014
---------------	----------	--	------------------	------	--------------------------------------------

**1.9 TDI (85 kW | 1.9 Litre)**

07.00 - 01.05	AJM		246-082-008-025G	SWP-M-C	
---------------	-----	--	------------------	---------	--

07.00 - 01.05	AJM		246-086-001-002C	HLWP	Plug Number (T2): 3
---------------	-----	--	------------------	------	---------------------

07.00 - 01.05	AJM		246-086-001-007C	HLWP	Plug Number (T2): 3b; T26: X11-246-003-014
---------------	-----	--	------------------	------	--------------------------------------------

**1.9 TDI (96 kW | 1.9 Litre)**

08.01 - 01.05	AWX		246-082-008-025G	SWP-M-C	
---------------	-----	--	------------------	---------	--

08.01 - 01.05	AVF, AWX		246-086-001-007C	HLWP	Plug Number (T2): 3b; T26: X11-246-003-014
---------------	----------	--	------------------	------	--------------------------------------------

**2.0 (96 kW | 2.0 Litre)**

08.01 - 01.05	ALT		246-082-008-025G	SWP-M-C	
---------------	-----	--	------------------	---------	--

08.01 - 01.05	ALT		246-086-001-007C	HLWP	Plug Number (T2): 3b; T26: X11-246-003-014
---------------	-----	--	------------------	------	--------------------------------------------

**2.4 (100 kW | 2.4 Litre)**

07.98 - 01.05	ALW		246-082-008-025G	SWP-M-C	
---------------	-----	--	------------------	---------	--

07.98 - 01.99	ALW, ARN, ASM		246-086-001-002C	HLWP	Plug Number (T2): 3
---------------	---------------	--	------------------	------	---------------------

07.98 - 01.05	ALW, ARN, ASM		246-086-001-007C	HLWP	Plug Number (T2): 3b; T26: X11-246-003-014
---------------	---------------	--	------------------	------	--------------------------------------------

**2.4 (115 kW | 2.4 Litre)**

02.97 - 01.05	APC		246-086-001-007C	HLWP	Plug Number (T2): 3b; T26: X11-246-003-014
---------------	-----	--	------------------	------	--------------------------------------------

**2.4 (120 kW | 2.4 Litre)**

02.97 - 01.05	AJG, APZ, AMM		246-086-001-007C	HLWP	Plug Number (T2): 3b; T26: X11-246-003-014
---------------	---------------	--	------------------	------	--------------------------------------------

**2.4 (121 kW | 2.4 Litre)**

02.97 - 01.05	ALF		246-082-008-025G	SWP-M-C	
---------------	-----	--	------------------	---------	--

04.97 - 07.99	ALF, AGA, ARJ, APS, AML		246-086-001-002C	HLWP	Plug Number (T2): 3
---------------	-------------------------	--	------------------	------	---------------------

02.97 - 01.05	ALF, AGA, ARJ, APS, AML		246-086-001-007C	HLWP	Plug Number (T2): 3b; T26: X11-246-003-014
---------------	-------------------------	--	------------------	------	--------------------------------------------

**2.4 (125 kW | 2.4 Litre)**

08.01 - 01.05	BDV		246-082-008-025G	SWP-M-C	T26: 1J0 955 665 H
---------------	-----	--	------------------	---------	--------------------

08.01 - 01.05	BDV		246-086-001-007C	HLWP	Plug Number (T2): 3b; T26: X11-246-003-014
---------------	-----	--	------------------	------	--------------------------------------------

**2.4 quattro (115 kW | 2.4 Litre)**

08.98 - 07.99	APC		246-082-008-025G	SWP-M-C	
---------------	-----	--	------------------	---------	--

08.98 - 07.99	APC		246-083-002-022G	SWP-D-C	
---------------	-----	--	------------------	---------	--

**2.4 quattro (120 kW | 2.4 Litre)**

02.97 - 01.05	AJG, APZ		246-086-001-007C	HLWP	Plug Number (T2): 3b; T26: X11-246-003-014
---------------	----------	--	------------------	------	--------------------------------------------

**2.4 quattro (121 kW | 2.4 Litre)**

04.97 - 01.05	ALF, AGA, AML, APS, ARJ		246-082-008-025G	SWP-M-C	
---------------	-------------------------	--	------------------	---------	--

04.97 - 07.99	ALF, AGA, AML, APS, ARJ		246-086-001-002C	HLWP	Plug Number (T2): 3
---------------	-------------------------	--	------------------	------	---------------------

02.97 - 01.05	ALF, AGA, AML, APS, ARJ		246-086-001-007C	HLWP	Plug Number (T2): 3b; T26: X11-246-003-014
---------------	-------------------------	--	------------------	------	--------------------------------------------

**2.4 quattro (125 kW | 2.4 Litre)**

08.01 - 01.05	BDV		246-082-008-025G	SWP-M-C	
---------------	-----	--	------------------	---------	--

08.01 - 01.05	BDV		246-086-001-007C	HLWP	Plug Number (T2): 3b; T26: X11-246-003-014
---------------	-----	--	------------------	------	--------------------------------------------

**2.5 TDI (110 kW | 2.5 Litre)**

07.97 - 01.05	AFB		246-082-008-025G	SWP-M-C	
---------------	-----	--	------------------	---------	--

07.97 - 06.99	AFB, AKN		246-086-001-002C	HLWP	Plug Number (T2): 3
---------------	----------	--	------------------	------	---------------------

07.97 - 01.05	AFB, AKN		246-086-001-007C	HLWP	Plug Number (T2): 3b; T26: X11-246-003-014
---------------	----------	--	------------------	------	--------------------------------------------



			<b>VDO</b>		
Date	Engine Code	Chassis No.	Article No.	Product	Information

**AUDI****A6 (4B, C5)****2.5 TDI (114 kW | 2.5 Litre)**

08.01 - 01.05	AYM		246-082-008-025G	SWP-M-C	
08.01 - 01.05	AYM		246-086-001-007C	HLWP	Plug Number (T2): 3b; T26: X11-246-003-014

**2.5 TDI (120 kW | 2.5 Litre)**

07.02 - 01.05	BCZ		246-082-008-025G	SWP-M-C	
07.02 - 01.05	BCZ		246-083-002-022G	SWP-D-C	

**2.5 TDI (132 kW | 2.5 Litre)**

02.00 - 01.05	BAU		246-082-008-025G	SWP-M-C	
02.00 - 01.05	AKE, BDH, BAU, BND		246-086-001-007C	HLWP	Plug Number (T2): 3b; T26: X11-246-003-014

**2.5 TDI quattro (110 kW | 2.5 Litre)**

07.97 - 01.05	AFB, AKN		246-082-008-025G	SWP-M-C	
07.97 - 06.99	AFB, AKN		246-086-001-002C	HLWP	Plug Number (T2): 3
07.97 - 01.05	AFB, AKN		246-086-001-007C	HLWP	Plug Number (T2): 3b; T26: X11-246-003-014

**2.5 TDI quattro (132 kW | 2.5 Litre)**

02.00 - 01.05	BAU		246-082-008-025G	SWP-M-C	
02.00 - 01.05	AKE, BAU, BDH		246-086-001-007C	HLWP	Plug Number (T2): 3b; T26: X11-246-003-014

**2.7 T (169 kW | 2.7 Litre)**

02.99 - 01.05	AJK		246-082-008-025G	SWP-M-C	
02.99 - 01.05	AJK		246-086-001-002C	HLWP	Plug Number (T2): 3
02.99 - 01.05	AJK		246-086-001-007C	HLWP	Plug Number (T2): 3b; T26: X11-246-003-014

**2.7 T quattro (169 kW | 2.7 Litre)**

03.98 - 01.05	AJK		246-082-008-025G	SWP-M-C	
03.98 - 07.98	AJK		246-086-001-002C	HLWP	Plug Number (T2): 3
12.97 - 01.05	AJK		246-086-001-007C	HLWP	Plug Number (T2): 3b; T26: X11-246-003-014

**2.7 T quattro (184 kW | 2.7 Litre)**

08.01 - 01.05	ARE		246-082-008-025G	SWP-M-C	
08.01 - 01.05	ARE, BES		246-086-001-007C	HLWP	Plug Number (T2): 3b; T26: X11-246-003-014

**2.8 (132 kW | 2.8 Litre)**

07.98 - 05.00	AGE		246-082-008-025G	SWP-M-C	
04.98 - 07.98	AGE		246-086-001-002C	HLWP	Plug Number (T2): 3
10.97 - 05.00	AGE		246-086-001-007C	HLWP	Plug Number (T2): 3b; T26: X11-246-003-014

**2.8 (140 kW | 2.8 Litre)**

07.99 - 01.05	ATX, BBG		246-082-008-025G	SWP-M-C	
07.99 - 07.99	ATX, BBG		246-086-001-002C	HLWP	Plug Number (T2): 3
07.99 - 01.05	ATX, BBG		246-086-001-007C	HLWP	Plug Number (T2): 3b; T26: X11-246-003-014

**2.8 (142 kW | 2.8 Litre)**

02.97 - 01.05	ACK		246-082-008-025G	SWP-M-C	
04.97 - 07.99	ALG, ACK, APR, AQD, AMX		246-086-001-002C	HLWP	Plug Number (T2): 3
02.97 - 01.05	ALG, ACK, APR, AQD, AMX		246-086-001-007C	HLWP	Plug Number (T2): 3b; T26: X11-246-003-014

**2.8 quattro (142 kW | 2.8 Litre)**

02.97 - 07.99	ALG, ACK, APR, AQD, AMX		246-082-008-025G	SWP-M-C	
04.97 - 07.99	ALG, ACK, APR, AQD, AMX		246-086-001-002C	HLWP	Plug Number (T2): 3
02.97 - 01.05	ALG, ACK, APR, AQD, AMX		246-086-001-007C	HLWP	Plug Number (T2): 3b; T26: X11-246-003-014

**3.0 (162 kW | 3.0 Litre)**

08.01 - 01.05	ASN		246-082-008-025G	SWP-M-C	
08.01 - 01.05	ASN		246-086-001-007C	HLWP	Plug Number (T2): 3b; T26: X11-246-003-014

**3.0 quattro (162 kW | 3.0 Litre)**

08.01 - 01.05	ASN		246-082-008-025G	SWP-M-C	
08.01 - 01.05	ASN		246-086-001-007C	HLWP	Plug Number (T2): 3b; T26: X11-246-003-014

**3.7 (191 kW | 3.7 Litre)**

03.99 - 01.05	AQG		246-082-008-025G	SWP-M-C	T26: 1J0 955 665 H
03.99 - 01.05	AQG		246-086-001-007C	HLWP	Plug Number (T2): 3b; T26: X11-246-003-014

**3.7 quattro (191 kW | 3.7 Litre)**

03.99 - 01.05	AQG		246-082-008-025G	SWP-M-C	T26: 1J0 955 665 H
03.99 - 01.05	AQG		246-086-001-007C	HLWP	Plug Number (T2): 3b; T26: X11-246-003-014

**4.2 quattro (220 kW | 4.2 Litre)**

04.99 - 01.05	ARS, AWN, ASG		246-082-008-025G	SWP-M-C	
04.99 - 01.05	ARS, AWN, ASG		246-086-001-002C	HLWP	Plug Number (T2): 3
11.98 - 01.05	ARS, AWN, ASG		246-086-001-007C	HLWP	Plug Number (T2): 3b; T26: X11-246-003-014

**RS6 quattro (331 kW | 4.2 Litre)**

07.02 - 01.05	BCY		246-082-008-025G	SWP-M-C	T26: 1J0 955 665
07.02 - 01.05	BCY		246-086-001-007C	HLWP	Plug Number (T2): 3b; T26: X11-246-003-014



					
Date	Engine Code	Chassis No.	Article No.	Product	Information

## AUDI

### A6 (4B, C5)

#### S6 quattro (250 kW | 4.2 Litre)

09.99 - 01.05	AQJ		246-082-008-025G	SWP-M-C	
09.99 - 01.05	ANK, AQJ		246-086-001-007C	HLWP	Plug Number (T2): 3b; T26: X11-246-003-014

### A6 Avant (4B, C5)

#### 1.8 (85 kW | 1.8 Litre)

02.98 - 01.05	AFY		246-083-002-022G	SWP-D-C	
02.98 - 04.99	AFY		246-086-001-002C	HLWP	Plug Number (T2): 3
02.98 - 01.05	AFY		246-086-001-007C	HLWP	Plug Number (T2): 3b; T26: X11-246-003-014

#### 1.8 (92 kW | 1.8 Litre)

02.98 - 01.05	AJP, AQE, ARH		246-083-002-022G	SWP-D-C	
02.98 - 07.99	AJP, AQE, ARH		246-086-001-002C	HLWP	Plug Number (T2): 3
12.97 - 01.05	AJP, AQE, ARH		246-086-001-007C	HLWP	Plug Number (T2): 3b; T26: X11-246-003-014

#### 1.8 T (110 kW | 1.8 Litre)

02.98 - 01.05	AEB, ANB, APU, ARK, AWT		246-083-002-022G	SWP-D-C	
02.98 - 06.99	AEB, ANB, APU, ARK, AWT		246-086-001-002C	HLWP	Plug Number (T2): 3
12.97 - 01.05	AEB, ANB, APU, ARK, AWT		246-086-001-007C	HLWP	Plug Number (T2): 3b; T26: X11-246-003-014

#### 1.8 T (132 kW | 1.8 Litre)

06.01 - 01.05	AJL		246-083-002-022G	SWP-D-C	
04.99 - 01.05	AJL		246-086-001-007C	HLWP	Plug Number (T2): 3b; T26: X11-246-003-014

#### 1.8 T quattro (110 kW | 1.8 Litre)

02.98 - 01.05	AEB, ANB, APU, ARK, AWT		246-083-002-022G	SWP-D-C	
02.98 - 04.99	AEB, ANB, APU, ARK, AWT		246-086-001-002C	HLWP	Plug Number (T2): 3
12.97 - 01.05	AEB, ANB, APU, ARK, AWT		246-086-001-007C	HLWP	Plug Number (T2): 3b; T26: X11-246-003-014

#### 1.8 T quattro (132 kW | 1.8 Litre)

02.98 - 01.05	AJL		246-083-002-022G	SWP-D-C	
02.98 - 07.98	AJL		246-086-001-002C	HLWP	Plug Number (T2): 3
12.97 - 01.05	AJL		246-086-001-007C	HLWP	Plug Number (T2): 3b; T26: X11-246-003-014

#### 1.9 TDI (81 kW | 1.9 Litre)

02.98 - 04.01	AFN		246-083-002-022G	SWP-D-C	
02.98 - 07.98	AFN		246-086-001-002C	HLWP	Plug Number (T2): 3
02.98 - 04.01	AFN		246-086-001-007C	HLWP	Plug Number (T2): 3b; T26: X11-246-003-014

#### 1.9 TDI (85 kW | 1.9 Litre)

07.00 - 01.05	AJM		246-083-002-022G	SWP-D-C	
07.00 - 01.05	AJM		246-086-001-002C	HLWP	Plug Number (T2): 3
07.00 - 01.05	AJM		246-086-001-007C	HLWP	Plug Number (T2): 3b; T26: X11-246-003-014

#### 1.9 TDI (96 kW | 1.9 Litre)

08.01 - 01.05	AWX		246-083-002-022G	SWP-D-C	
08.01 - 01.05	AVF, AWX		246-086-001-007C	HLWP	Plug Number (T2): 3b; T26: X11-246-003-014

#### 2.0 (96 kW | 2.0 Litre)

08.01 - 01.05	ALT		246-083-002-022G	SWP-D-C	
08.01 - 01.05	ALT		246-086-001-007C	HLWP	Plug Number (T2): 3b; T26: X11-246-003-014

#### 2.4 (100 kW | 2.4 Litre)

07.98 - 01.05	ALW, ARN, ASM		246-083-002-022G	SWP-D-C	
07.98 - 01.99	ALW, ARN, ASM		246-086-001-002C	HLWP	Plug Number (T2): 3
07.98 - 01.05	ALW, ARN, ASM		246-086-001-007C	HLWP	Plug Number (T2): 3b; T26: X11-246-003-014

#### 2.4 (115 kW | 2.4 Litre)

12.97 - 01.05	APC		246-083-002-022G	SWP-D-C	
12.97 - 01.05	APC		246-086-001-007C	HLWP	Plug Number (T2): 3b; T26: X11-246-003-014

#### 2.4 (120 kW | 2.4 Litre)

12.97 - 01.05	AJG, APZ, AMM		246-083-002-022G	SWP-D-C	
12.97 - 01.05	AJG, APZ, AMM		246-086-001-007C	HLWP	Plug Number (T2): 3b; T26: X11-246-003-014

#### 2.4 (121 kW | 2.4 Litre)

02.98 - 01.05	ALF, AGA, APS, ARJ, AML		246-083-002-022G	SWP-D-C	
02.98 - 07.99	ALF, AGA, APS, ARJ, AML		246-086-001-002C	HLWP	Plug Number (T2): 3
12.97 - 01.05	ALF, AGA, APS, ARJ, AML		246-086-001-007C	HLWP	Plug Number (T2): 3b; T26: X11-246-003-014

#### 2.4 (125 kW | 2.4 Litre)

08.01 - 01.05	BDV		246-083-002-022G	SWP-D-C	
08.01 - 01.05	BDV		246-086-001-007C	HLWP	Plug Number (T2): 3b; T26: X11-246-003-014

#### 2.4 quattro (115 kW | 2.4 Litre)

08.98 - 05.01	APC		246-082-008-014C	SWP-M-C	Plug Number (T2): 1; T28: Rear (T29)
08.98 - 05.01	APC		246-083-002-022G	SWP-D-C	
08.98 - 05.01	APC		246-086-001-007C	HLWP	Plug Number (T2): 3b



			<b>VDO</b>		
Date	Engine Code	Chassis No.	Article No.	Product	Information

**AUDI****A6 Avant (4B, C5)****2.4 quattro (120 kW | 2.4 Litre)**

12.97 - 01.05	AJG, APZ		246-083-002-022G	SWP-D-C	
12.97 - 01.05	AJG, APZ		246-086-001-007C	HLWP	Plug Number (T2): 3b; T26: X11-246-003-014

**2.4 quattro (121 kW | 2.4 Litre)**

02.98 - 01.05	ALF, AGA, APS, ARJ, AML		246-083-002-022G	SWP-D-C	
02.98 - 06.99	ALF, AGA, APS, ARJ, AML		246-086-001-002C	HLWP	Plug Number (T2): 3
12.97 - 01.05	ALF, AGA, APS, ARJ, AML		246-086-001-007C	HLWP	Plug Number (T2): 3b; T26: X11-246-003-014

**2.4 quattro (125 kW | 2.4 Litre)**

08.01 - 01.05	BDV		246-083-002-022G	SWP-D-C	
08.01 - 01.05	BDV		246-086-001-007C	HLWP	Plug Number (T2): 3b; T26: X11-246-003-014

**2.5 TDI (110 kW | 2.5 Litre)**

12.97 - 01.05	AFB		246-083-002-022G	SWP-D-C	
02.98 - 04.99	AFB, AKN		246-086-001-002C	HLWP	Plug Number (T2): 3
12.97 - 01.05	AFB, AKN		246-086-001-007C	HLWP	Plug Number (T2): 3b; T26: X11-246-003-014

**2.5 TDI (114 kW | 2.5 Litre)**

08.01 - 01.05	AYM		246-083-002-022G	SWP-D-C	
08.01 - 01.05	AYM		246-086-001-007C	HLWP	Plug Number (T2): 3b; T26: X11-246-003-014

**2.5 TDI (120 kW | 2.5 Litre)**

07.02 - 01.05	BFC, BCZ, BDG	F 4B-2-110 001→	246-083-002-022G	SWP-D-C	
07.02 - 01.05	BCZ, BDG, BFC		246-086-001-007C	HLWP	Plug Number (T2): 3b

**2.5 TDI (132 kW | 2.5 Litre)**

02.00 - 01.05	BAU		246-083-002-022G	SWP-D-C	
02.00 - 01.05	AKE, BAU, BDH		246-086-001-007C	HLWP	Plug Number (T2): 3b; T26: X11-246-003-014

**2.5 TDI quattro (110 kW | 2.5 Litre)**

12.97 - 01.05	AFB, AKN		246-083-002-022G	SWP-D-C	
02.98 - 07.98	AFB, AKN		246-086-001-002C	HLWP	Plug Number (T2): 3
12.97 - 01.05	AFB, AKN		246-086-001-007C	HLWP	Plug Number (T2): 3b; T26: X11-246-003-014

**2.5 TDI quattro (132 kW | 2.5 Litre)**

02.00 - 01.05	BAU		246-083-002-022G	SWP-D-C	
02.00 - 01.05	AKE, BAU, BDH		246-086-001-007C	HLWP	Plug Number (T2): 3b; T26: X11-246-003-014

**2.7 T (169 kW | 2.7 Litre)**

02.99 - 01.05	AJK		246-083-002-022G	SWP-D-C	
02.99 - 01.05	AJK		246-086-001-002C	HLWP	Plug Number (T2): 3
02.99 - 01.05	AJK		246-086-001-007C	HLWP	Plug Number (T2): 3b; T26: X11-246-003-014

**2.7 T quattro (169 kW | 2.7 Litre)**

01.99 - 01.05	AJK, AZA		246-083-002-022G	SWP-D-C	
01.99 - 01.05	AJK, AZA		246-086-001-002C	HLWP	Plug Number (T2): 3
12.97 - 01.05	AJK, AZA		246-086-001-007C	HLWP	Plug Number (T2): 3b; T26: X11-246-003-014

**2.7 T quattro (184 kW | 2.7 Litre)**

08.01 - 01.05	ARE, BES		246-083-002-022G	SWP-D-C	
08.01 - 01.05	ARE, BES		246-086-001-007C	HLWP	Plug Number (T2): 3b; T26: X11-246-003-014

**2.8 (132 kW | 2.8 Litre)**

02.98 - 05.00	AGE		246-083-002-022G	SWP-D-C	
02.98 - 07.98	AGE		246-086-001-002C	HLWP	Plug Number (T2): 3
12.97 - 05.00	AGE		246-086-001-007C	HLWP	Plug Number (T2): 3b; T26: X11-246-003-014

**2.8 (140 kW | 2.8 Litre)**

07.99 - 01.05	ATX		246-083-002-022G	SWP-D-C	
07.99 - 07.99	ATX		246-086-001-002C	HLWP	Plug Number (T2): 3
07.99 - 01.05	ATX		246-086-001-007C	HLWP	Plug Number (T2): 3b; T26: X11-246-003-014

**2.8 (142 kW | 2.8 Litre)**

02.98 - 01.05	ALG, ACK, APR, AQD, AMX		246-083-002-022G	SWP-D-C	
02.98 - 07.99	ALG, ACK, APR, AQD, AMX		246-086-001-002C	HLWP	Plug Number (T2): 3
12.97 - 01.05	ALG, ACK, APR, AQD, AMX		246-086-001-007C	HLWP	Plug Number (T2): 3b; T26: X11-246-003-014

**2.8 quattro (142 kW | 2.8 Litre)**

02.98 - 01.05	ALG, ACK, APR, AQD, AMX		246-083-002-022G	SWP-D-C	
02.98 - 07.98	ALG, ACK, APR, AQD, AMX		246-086-001-002C	HLWP	Plug Number (T2): 3
12.97 - 01.05	ALG, ACK, APR, AQD, AMX		246-086-001-007C	HLWP	Plug Number (T2): 3b; T26: X11-246-003-014

**3.0 (162 kW | 3.0 Litre)**

08.01 - 01.05	ASN		246-083-002-022G	SWP-D-C	
08.01 - 01.05	ASN		246-086-001-007C	HLWP	Plug Number (T2): 3b; T26: X11-246-003-014

**3.0 quattro (162 kW | 3.0 Litre)**

08.01 - 01.05	ASN		246-083-002-022G	SWP-D-C	
08.01 - 01.05	ASN		246-086-001-007C	HLWP	Plug Number (T2): 3b; T26: X11-246-003-014





Date	Engine Code	Chassis No.	Article No.	Product	Information

**AUDI****A6 Avant (4B, C5)**

<b>3.7 (191 kW   3.7 Litre)</b>					
03.99 → 01.05	AQG		246-083-002-022G	SWP-D-C	
03.99 → 01.05	AQG		246-086-001-007C	HLWP	Plug Number (T2): 3b; T26: X11-246-003-014
<b>3.7 quattro (191 kW   3.7 Litre)</b>					
03.99 → 01.05	AQG		246-083-002-022G	SWP-D-C	
03.99 → 01.05	AQG		246-086-001-007C	HLWP	Plug Number (T2): 3b; T26: X11-246-003-014
<b>4.2 quattro (220 kW   4.2 Litre)</b>					
04.99 → 01.05	ARS, AWN, ASG		246-083-002-022G	SWP-D-C	
04.99 → 01.05	ARS, AWN, ASG		246-086-001-002C	HLWP	Plug Number (T2): 3
11.98 → 01.05	ARS, AWN, ASG		246-086-001-007C	HLWP	Plug Number (T2): 3b; T26: X11-246-003-014
<b>RS6 plus quattro (353 kW   4.2 Litre)</b>					
04.04 → 01.05	BRV		246-082-008-014C	SWP-M-C	Plug Number (T2): 1; T28: Rear (T29)
04.04 → 01.05	BRV		246-083-002-022G	SWP-D-C	
04.04 → 01.05	BRV		246-086-001-007C	HLWP	Plug Number (T2): 3b
<b>RS6 quattro (331 kW   4.2 Litre)</b>					
07.02 → 01.05	BCY		246-083-002-022G	SWP-D-C	
07.02 → 01.05	BCY		246-086-001-007C	HLWP	Plug Number (T2): 3b; T26: X11-246-003-014
<b>S6 quattro (250 kW   4.2 Litre)</b>					
09.99 → 01.05	ANK, AQJ		246-082-008-014C	SWP-M-C	Plug Number (T2): 1; T28: Rear (T29)
09.99 → 01.05	ANK, AQJ		246-083-002-022G	SWP-D-C	
09.99 → 01.05	ANK, AQJ		246-086-001-002C	HLWP	Plug Number (T2): 3
09.99 → 01.05	ANK, AQJ		246-086-001-007C	HLWP	Plug Number (T2): 3b; T26: X11-246-003-014

**ALLROAD (4BH, C5)**

<b>2.5 TDI quattro (120 kW   2.5 Litre)</b>					
05.03 → 08.05	BCZ		246-083-002-022G	SWP-D-C	
<b>2.5 TDI quattro (132 kW   2.5 Litre)</b>					
05.00 → 08.05	AKE		246-083-002-022G	SWP-D-C	
05.00 → 08.05	AKE, BAU		246-086-001-007C	HLWP	Plug Number (T2): 3b; T26: X11-246-003-014
<b>2.7 T quattro (184 kW   2.7 Litre)</b>					
05.00 → 08.05	ARE, BES		246-083-002-022G	SWP-D-C	
05.00 → 08.05	ARE, BES		246-086-001-007C	HLWP	Plug Number (T2): 3b; T26: X11-246-003-014
<b>4.2 V8 quattro (220 kW   4.2 Litre)</b>					
07.02 → 08.05	BAS		246-083-002-022G	SWP-D-C	
07.02 → 08.05	BAS		246-086-001-007C	HLWP	Plug Number (T2): 3b; T26: X11-246-003-014

**A6 (4F2, C6)**

<b>2.0 TDI (100 kW   2.0 Litre)</b>					
07.04 → 03.11	BNA, BRF, CAGB	→4B-5-050 000	246-082-008-025G	SWP-M-C	
<b>2.0 TDI (103 kW   2.0 Litre)</b>					
07.04 → 10.08	BLB, BRE	4F-5-000 001→	246-082-008-025G	SWP-M-C	
07.04 → 10.08	BLB, BRE	4F-5-000 001→	246-083-002-022G	SWP-D-C	
<b>2.0 TDI (120 kW   2.0 Litre)</b>					
04.09 → 03.11	CAHB		246-082-008-025G	SWP-M-C	
<b>2.0 TDI (125 kW   2.0 Litre)</b>					
11.08 → 03.11	CAHA		246-082-008-025G	SWP-M-C	
<b>2.0 TDI (89 kW   2.0 Litre)</b>					
09.05 → 06.06	BVG	→4B-5-050 000	246-082-008-025G	SWP-M-C	
<b>2.0 TFSI (125 kW   2.0 Litre)</b>					
06.05 → 03.11	BYK		246-082-008-025G	SWP-M-C	
06.05 → 03.11	BYK		246-083-002-022G	SWP-D-C	
<b>2.4 (130 kW   2.4 Litre)</b>					
05.04 → 10.08	BDW		246-082-008-025G	SWP-M-C	
05.04 → 10.08	BDW		246-083-002-022G	SWP-D-C	
<b>2.4 quattro (130 kW   2.4 Litre)</b>					
01.05 → 10.08	BDW	4F-5-000 001→	246-082-008-025G	SWP-M-C	
01.05 → 10.08	BDW	4F-5-000 001→	246-083-002-022G	SWP-D-C	
<b>2.7 TDI (120 kW   2.7 Litre)</b>					
11.04 → 03.11	BSG, CANB	4F-5-000 001→	246-082-008-025G	SWP-M-C	
11.04 → 03.11	BSG, CANB	4F-5-000 001→	246-083-002-022G	SWP-D-C	
<b>2.7 TDI (132 kW   2.7 Litre)</b>					
11.04 → 10.08	BPP	4F-5-000 001→	246-082-008-025G	SWP-M-C	
11.04 → 10.08	BPP	4F-5-000 001→	246-083-002-022G	SWP-D-C	



			<b>VDO</b>		
Date	Engine Code	Chassis No.	Article No.	Product	Information

**AUDI****A6 (4F2, C6)****2.7 TDI (140 kW | 2.7 Litre)**

10.08 → 03.11 CANA, CANC 246-082-008-025G SWP-M-C

**2.7 TDI quattro (120 kW | 2.7 Litre)**

06.05 → 03.11 BSG 246-082-008-025G SWP-M-C

**2.7 TDI quattro (132 kW | 2.7 Litre)**

11.04 → 10.08 BPP 4F-5-000 001→ 246-082-008-025G SWP-M-C

11.04 → 10.08 BPP 4F-5-000 001→ 246-083-002-022G SWP-D-C

**2.7 TDI quattro (140 kW | 2.7 Litre)**

10.08 → 03.11 CANA, CANC 246-082-008-025G SWP-M-C

**2.8 FSI (140 kW | 2.8 Litre)**

10.08 → 03.11 CCDA 246-082-008-025G SWP-M-C

**2.8 FSI (154 kW | 2.8 Litre)**

11.06 → 10.08 BDX 4F-5-000 001→ 246-082-008-025G SWP-M-C

**2.8 FSI (162 kW | 2.8 Litre)**

10.08 → 03.11 CCEA 246-082-008-025G SWP-M-C

**2.8 FSI quattro (140 kW | 2.8 Litre)**

10.08 → 03.11 CCDA 246-082-008-025G SWP-M-C

**2.8 FSI quattro (154 kW | 2.8 Litre)**

06.07 → 10.08 BDX 246-082-008-025G SWP-M-C

**2.8 FSI quattro (162 kW | 2.8 Litre)**

10.08 → 03.11 CCEA 246-082-008-025G SWP-M-C

**3.0 quattro (160 kW | 3.0 Litre)**

05.04 → 05.06 BBJ 4F-5-000 001→ 246-082-008-025G SWP-M-C

**3.0 TDI quattro (155 kW | 3.0 Litre)**

05.04 → 03.11 BNG, CDYB 4F-5-000 001→ 246-082-008-025G SWP-M-C

05.04 → 03.11 BNG, CDYB 4F-5-000 001→ 246-083-002-022G SWP-D-C

**3.0 TDI quattro (165 kW | 3.0 Litre)**

05.04 → 05.06 BMK 4F-5-000 001→ 246-082-008-025G SWP-M-C

05.04 → 05.06 BMK 4F-5-000 001→ 246-083-002-022G SWP-D-C

**3.0 TDI quattro (171 kW | 3.0 Litre)**

06.06 → 10.08 ASB 4F-5-000 001→ 246-082-008-025G SWP-M-C

**3.0 TDI quattro (176 kW | 3.0 Litre)**

10.08 → 03.11 CDYA, CDYC 246-082-008-025G SWP-M-C

**3.0 TFSI quattro (213 kW | 3.0 Litre)**

10.08 → 03.11 CAJA 246-082-008-025G SWP-M-C

**3.2 FSI (188 kW | 3.2 Litre)**

05.04 → 05.09 AUK, BKH 4F-5-000 001→ 246-082-008-025G SWP-M-C

05.04 → 05.09 AUK, BKH 4F-5-000 001→ 246-083-002-022G SWP-D-C

**3.2 FSI quattro (183 kW | 3.2 Litre)**

09.06 → 10.08 BYU 4F-5-000 001→ 246-082-008-025G SWP-M-C

**3.2 FSI quattro (188 kW | 3.2 Litre)**

05.04 → 10.08 BKH 246-082-008-025G SWP-M-C

05.04 → 10.08 BKH 246-083-002-022G SWP-D-C

**4.2 FSI quattro (257 kW | 4.2 Litre)**

06.06 → 03.11 BVJ 4F-5-000 001→ 246-082-008-025G SWP-M-C

**4.2 quattro (246 kW | 4.2 Litre)**

05.04 → 05.06 BAT 246-082-008-025G SWP-M-C

05.04 → 05.06 BAT 246-083-002-022G SWP-D-C

**RS6 quattro (426 kW | 5.0 Litre)**

09.08 → 08.10 BUH 246-082-008-025G SWP-M-C

**S6 quattro (320 kW | 5.2 Litre)**

03.06 → 03.11 BXA 4F-5-000 001→ 246-082-008-025G SWP-M-C

**A6 Avant (4F5, C6)****2.0 TDI (100 kW | 2.0 Litre)**

06.05 → 08.11 BNA, BRF, CAGB →4B-5-050-000 246-083-002-022G SWP-D-C

06.05 → 08.11 BNA, BRF, CAGB 246-086-001-007C HLWP Plug Number (T2): 3b

**2.0 TDI (103 kW | 2.0 Litre)**

06.05 → 10.08 BRE, BLB 4F-5-000 001→ 246-083-002-022G SWP-D-C



06.05 → 10.08 BLB, BRE 246-086-001-007C HLWP Plug Number (T2): 3b

**2.0 TDI (120 kW | 2.0 Litre)**

04.09 → 08.11 CAHB 246-083-002-022G SWP-D-C

04.09 → 08.11 CAHB 246-086-001-007C HLWP Plug Number (T2): 3b



					
Date	Engine Code	Chassis No.	Article No.	Product	Information

## AUDI

## A6 Avant (4F5, C6)

## 2.0 TDI (125 kW | 2.0 Litre)

10.08 - 08.11	CAHA		246-083-002-022G	SWP-D-C	
10.08 - 08.11	CAHA		246-086-001-007C	HLWP	Plug Number (T2): 3b

## 2.0 TDI (89 kW | 2.0 Litre)

09.05 - 06.06	BVG	-4B-5-050 000	246-083-002-022G	SWP-D-C	
09.05 - 06.06	BVG		246-086-001-007C	HLWP	Plug Number (T2): 3b

## 2.0 TFSI (125 kW | 2.0 Litre)

06.05 - 08.11	BPJ		246-083-002-022G	SWP-D-C	
06.05 - 08.11	BPJ		246-086-001-007C	HLWP	Plug Number (T2): 3b

## 2.4 (130 kW | 2.4 Litre)

03.05 - 10.08	BDW		246-083-002-022G	SWP-D-C	T26: 4F0 919 673 C
03.05 - 10.08	BDW		246-086-001-007C	HLWP	Plug Number (T2): 3b

## 2.4 quattro (130 kW | 2.4 Litre)

03.05 - 10.08	BDW		246-083-002-022G	SWP-D-C	
03.05 - 10.08	BDW		246-086-001-007C	HLWP	Plug Number (T2): 3b

## 2.7 TDI (120 kW | 2.7 Litre)

03.05 - 08.11	BSG, CANB	4F-5-000 001→	246-083-002-022G	SWP-D-C	
03.05 - 08.11	BSG, CANB, CAND		246-086-001-007C	HLWP	Plug Number (T2): 3b

## 2.7 TDI (132 kW | 2.7 Litre)

03.05 - 10.08	BPP	4F-5-000 001→	246-083-002-022G	SWP-D-C	
03.05 - 10.08	BPP		246-086-001-007C	HLWP	Plug Number (T2): 3b

## 2.7 TDI (140 kW | 2.7 Litre)

10.08 - 08.11	CANA, CANC		246-083-002-022G	SWP-D-C	
10.08 - 08.11	CANA, CANC		246-086-001-007C	HLWP	Plug Number (T2): 3b

## 2.7 TDI quattro (120 kW | 2.7 Litre)

06.05 - 08.11	BSG, CAND	4F-5-000 001→	246-083-002-022G	SWP-D-C	
06.05 - 08.11	BSG, CANB, CAND		246-086-001-007C	HLWP	Plug Number (T2): 3b

## 2.7 TDI quattro (132 kW | 2.7 Litre)

03.05 - 10.08	BPP	4F-5-000 001→	246-083-002-022G	SWP-D-C	
03.05 - 10.08	BPP		246-086-001-007C	HLWP	Plug Number (T2): 3b

## 2.7 TDI quattro (140 kW | 2.7 Litre)

10.08 - 08.11	CANA, CANC		246-083-002-022G	SWP-D-C	
10.08 - 08.11	CANA, CANC		246-086-001-007C	HLWP	Plug Number (T2): 3b

## 2.8 FSI (140 kW | 2.8 Litre)

10.08 - 08.11	CCDA		246-083-002-022G	SWP-D-C	
10.08 - 08.11	CCDA		246-086-001-007C	HLWP	Plug Number (T2): 3b

## 2.8 FSI (154 kW | 2.8 Litre)

11.06 - 10.08	BDX		246-083-002-022G	SWP-D-C	T26: 8E0 201 263 G
11.06 - 10.08	BDX		246-086-001-007C	HLWP	Plug Number (T2): 3b

## 2.8 FSI (162 kW | 2.8 Litre)

10.08 - 08.11	CCEA		246-083-002-022G	SWP-D-C	
10.08 - 08.11	CCEA		246-086-001-007C	HLWP	Plug Number (T2): 3b

## 2.8 FSI quattro (140 kW | 2.8 Litre)

10.08 - 08.11	CCDA		246-083-002-022G	SWP-D-C	
10.08 - 08.11	CCDA		246-086-001-007C	HLWP	Plug Number (T2): 3b

## 2.8 FSI quattro (154 kW | 2.8 Litre)

06.07 - 10.08	BDX		246-083-002-022G	SWP-D-C	
06.07 - 10.08	BDX		246-086-001-007C	HLWP	Plug Number (T2): 3b

## 2.8 FSI quattro (162 kW | 2.8 Litre)

10.08 - 08.11	CCEA		246-083-002-022G	SWP-D-C	
10.08 - 08.11	CCEA		246-086-001-007C	HLWP	Plug Number (T2): 3b

## 3.0 (160 kW | 3.0 Litre)

03.05 - 05.06	BBJ		246-083-002-022G	SWP-D-C	
03.05 - 05.06	BBJ		246-086-001-007C	HLWP	Plug Number (T2): 3b

## 3.0 quattro (160 kW | 3.0 Litre)

03.05 - 05.06	BBJ		246-083-002-022G	SWP-D-C	T26: 4F0 919 673 C
03.05 - 05.06	BBJ		246-086-001-007C	HLWP	Plug Number (T2): 3b

## 3.0 TDi (171 kW | 3.0 Litre)

06.06 - 08.11	ASB		246-086-001-007C	HLWP	Plug Number (T2): 3b
---------------	-----	--	------------------	------	----------------------

## 3.0 TDI quattro (155 kW | 3.0 Litre)

03.05 - 08.11	BNG, CDYB	4F-5-000 001→	246-083-002-022G	SWP-D-C	
03.05 - 08.11	BNG, CDYB		246-086-001-007C	HLWP	Plug Number (T2): 3b



			<b>VDO</b>		
Date	Engine Code	Chassis No.	Article No.	Product	Information

**AUDI****A6 Avant (4F5, C6)****3.0 TDI quattro (165 kW | 3.0 Litre)**

03.05 - 05.06	BMK	4F-5-000 001→	246-083-002-022G	SWP-D-C	
03.05 - 05.06	BMK		246-086-001-007C	HLWP	Plug Number (T2): 3b

**3.0 TDI quattro (171 kW | 3.0 Litre)**

06.06 - 10.08	ASB		246-083-002-022G	SWP-D-C	
06.06 - 10.08	ASB		246-086-001-007C	HLWP	Plug Number (T2): 3b

**3.0 TDI quattro (176 kW | 3.0 Litre)**

10.08 - 08.11	CDYA, CDYC		246-083-002-022G	SWP-D-C	
10.08 - 08.11	CDYA, CDYC		246-086-001-007C	HLWP	Plug Number (T2): 3b

**3.0 TFSI quattro (213 kW | 3.0 Litre)**

10.08 - 08.11	CAJA		246-083-002-022G	SWP-D-C	
10.08 - 08.11	CAJA		246-086-001-007C	HLWP	Plug Number (T2): 3b

**3.2 FSI (188 kW | 3.2 Litre)**

03.05 - 10.08	AUK	4F-5-000 001→	246-083-002-022G	SWP-D-C	
03.05 - 10.08	AUK		246-086-001-007C	HLWP	Plug Number (T2): 3b

**3.2 FSI quattro (188 kW | 3.2 Litre)**

03.05 - 10.08	AUK	4F-5-000 001→	246-083-002-022G	SWP-D-C	
03.05 - 10.08	AUK		246-086-001-007C	HLWP	Plug Number (T2): 3b

**4.2 FSI quattro (257 kW | 4.2 Litre)**

06.06 - 08.11	BVJ		246-083-002-022G	SWP-D-C	
06.06 - 08.11	BVJ		246-086-001-007C	HLWP	Plug Number (T2): 3b

**4.2 quattro (246 kW | 4.2 Litre)**

03.05 - 05.06	BAT		246-083-002-022G	SWP-D-C	
03.05 - 05.06	BAT		246-086-001-007C	HLWP	Plug Number (T2): 3b

**RS6 quattro (426 kW | 5.0 Litre)**

04.08 - 08.10	BUH		246-083-002-022G	SWP-D-C	
04.08 - 08.10	BUH		246-086-001-007C	HLWP	Plug Number (T2): 3b

**S6 quattro (320 kW | 5.2 Litre)**

03.06 - 08.11	BXA		246-083-002-022G	SWP-D-C	T26: 4F0 919 673 C
03.06 - 08.11	BXA		246-086-001-007C	HLWP	Plug Number (T2): 3b

**A6 Allroad (4FH, C6)****2.7 TDI quattro (120 kW | 2.7 Litre)**

05.06 -	BSG		246-082-008-025G	SWP-M-C	
05.06 -	BSG		246-083-002-022G	SWP-D-C	
05.06 -	BSG		246-086-001-007C	HLWP	Plug Number (T2): 3b

**2.7 TDI quattro (132 kW | 2.7 Litre)**

05.06 -	BPP		246-082-008-025G	SWP-M-C	
05.06 -	BPP		246-083-002-022G	SWP-D-C	
05.06 -	BPP		246-086-001-007C	HLWP	Plug Number (T2): 3b

**2.7 TDI quattro (140 kW | 2.7 Litre)**

10.08 -	CANA		246-082-008-025G	SWP-M-C	
10.08 -	CANA		246-083-002-022G	SWP-D-C	
10.08 -	CANA		246-086-001-007C	HLWP	Plug Number (T2): 3b

**3.0 TDI quattro (155 kW | 3.0 Litre)**

05.06 -	BNG, CDYB	4F-5-000 001→	246-082-008-025G	SWP-M-C	
05.06 -	BNG		246-083-002-022G	SWP-D-C	
05.06 -	BNG		246-086-001-007C	HLWP	Plug Number (T2): 3b

**3.0 TDI quattro (171 kW | 3.0 Litre)**

05.06 -	ASB		246-082-008-025G	SWP-M-C	
05.06 -	ASB		246-083-002-022G	SWP-D-C	
05.06 -	ASB		246-086-001-007C	HLWP	Plug Number (T2): 3b

**3.0 TDI quattro (176 kW | 3.0 Litre)**

10.08 -	CDYA		246-082-008-025G	SWP-M-C	
10.08 -	CDYA		246-083-002-022G	SWP-D-C	
10.08 -	CDYA		246-086-001-007C	HLWP	Plug Number (T2): 3b

**3.0 TFSI quattro (213 kW | 3.0 Litre)**

10.08 -	CAJA		246-082-008-025G	SWP-M-C	
10.08 -	CAJA		246-083-002-022G	SWP-D-C	
10.08 -	CAJA		246-086-001-007C	HLWP	Plug Number (T2): 3b

**3.2 FSI quattro (188 kW | 3.2 Litre)**

05.06 -	AUX		246-082-008-025G	SWP-M-C	
05.06 -	AUK		246-083-002-022G	SWP-D-C	



			<b>VDO</b>		
Date	Engine Code	Chassis No.	Article No.	Product	Information

**AUDI****A6 Allroad (4FH, C6)****3.2 FSI quattro (188 kW | 3.2 Litre)**

05.06 -	AUK		246-086-001-007C	HLWP	Plug Number (T2): 3b
---------	-----	--	------------------	------	----------------------

**4.2 FSI quattro (257 kW | 4.2 Litre)**

05.06 -	BVJ		246-082-008-025G	SWP-M-C	
05.06 -	BVJ		246-083-002-022G	SWP-D-C	
05.06 -	BVJ		246-086-001-007C	HLWP	Plug Number (T2): 3b

**A7 Sportback (4GA)****2.8 FSI quattro (150 kW | 2.8 Litre)**

10.10 -			246-082-008-025G	SWP-M-C	
---------	--	--	------------------	---------	--

**3.0 TDI (150 kW | 3.0 Litre)**

11.10 -			246-082-008-025G	SWP-M-C	
---------	--	--	------------------	---------	--

**3.0 TDI quattro (180 kW | 3.0 Litre)**

10.10 -			246-082-008-025G	SWP-M-C	
---------	--	--	------------------	---------	--

**3.0 TFSI quattro (220 kW | 3.0 Litre)**

10.10 -			246-082-008-025G	SWP-M-C	
---------	--	--	------------------	---------	--

**V8 (44\_, 4C\_)****3.6 quattro (180 kW | 3.6 Litre)**

04.93 - 07.93	PT		246-082-008-014C	SWP-M-C	Plug Number (T2): 1
---------------	----	--	------------------	---------	---------------------

**3.6 quattro (184 kW | 3.6 Litre)**

10.88 - 07.90	PT		246-082-008-014C	SWP-M-C	Plug Number (T2): 1
---------------	----	--	------------------	---------	---------------------

**4.2 quattro (206 kW | 4.2 Litre)**

10.91 - 07.93	ABH		246-082-008-014C	SWP-M-C	Plug Number (T2): 1
---------------	-----	--	------------------	---------	---------------------

**A8 (4D2, 4D8)****2.5 TDI (110 kW | 2.5 Litre)**

06.97 - 11.99	AFB, AKN		246-086-001-002C	HLWP	Plug Number (T2): 3
01.97 - 04.00	AFB, AKN		246-086-001-007C	HLWP	Plug Number (T2): 3b; T26: X11-246-003-014

**2.5 TDI (132 kW | 2.5 Litre)**

09.00 - 09.02	AKE		246-086-001-007C	HLWP	Plug Number (T2): 3b; T26: X11-246-003-014
---------------	-----	--	------------------	------	--------------------------------------------

**2.5 TDI quattro (110 kW | 2.5 Litre)**

07.97 - 04.00	AFB, AKN		246-086-001-007C	HLWP	Plug Number (T2): 3b; T26: X11-246-003-014
---------------	----------	--	------------------	------	--------------------------------------------

**2.5 TDI quattro (132 kW | 2.5 Litre)**

09.00 - 09.02	AKE		246-086-001-007C	HLWP	Plug Number (T2): 3b; T26: X11-246-003-014
---------------	-----	--	------------------	------	--------------------------------------------

**2.8 (120 kW | 2.8 Litre)**

07.95 - 03.96	AEJ		246-086-001-002C	HLWP	Plug Number (T2): 3
07.95 - 03.96	AEJ		246-086-001-007C	HLWP	Plug Number (T2): 3b; T26: X11-246-003-014

**2.8 (128 kW | 2.8 Litre)**

06.94 - 03.96	AAH		246-086-001-002C	HLWP	Plug Number (T2): 3
03.94 - 03.96	AAH		246-086-001-007C	HLWP	Plug Number (T2): 3b; T26: X11-246-003-014

**2.8 (142 kW | 2.8 Litre)**

04.96 - 05.99	ACK, ALG, AMX, APR, AQD		246-086-001-002C	HLWP	Plug Number (T2): 3
04.96 - 09.02	ACK, ALG, AMX, APR, AQD		246-086-001-007C	HLWP	Plug Number (T2): 3b; T26: X11-246-003-014

**2.8 quattro (120 kW | 2.8 Litre)**

07.95 - 03.96	AEJ		246-086-001-007C	HLWP	Plug Number (T2): 3b; T26: X11-246-003-014
---------------	-----	--	------------------	------	--------------------------------------------

**2.8 quattro (128 kW | 2.8 Litre)**

03.94 - 03.96	AAH		246-086-001-007C	HLWP	Plug Number (T2): 3b; T26: X11-246-003-014
---------------	-----	--	------------------	------	--------------------------------------------

**2.8 quattro (142 kW | 2.8 Litre)**

04.96 - 09.02	ACK, AMX, APR, AQD		246-086-001-007C	HLWP	Plug Number (T2): 3b; T26: X11-246-003-014
---------------	--------------------	--	------------------	------	--------------------------------------------

**3.3 TDI quattro (165 kW | 3.3 Litre)**

06.00 - 09.02	AKF		246-086-001-007C	HLWP	Plug Number (T2): 3b; T26: X11-246-003-014
---------------	-----	--	------------------	------	--------------------------------------------

**3.7 (169 kW | 3.7 Litre)**

06.97 - 12.98	AEW		246-086-001-002C	HLWP	Plug Number (T2): 3
07.95 - 12.98	AEW		246-086-001-007C	HLWP	Plug Number (T2): 3b; T26: X11-246-003-014

**3.7 (191 kW | 3.7 Litre)**

11.98 - 12.98	AQG, AKC		246-086-001-002C	HLWP	Plug Number (T2): 3
11.98 - 09.02	AQG, AKC		246-086-001-007C	HLWP	Plug Number (T2): 3b; T26: X11-246-003-014

**3.7 quattro (169 kW | 3.7 Litre)**

07.95 - 11.98	AEW, AKJ		246-086-001-007C	HLWP	Plug Number (T2): 3b; T26: X11-246-003-014
---------------	----------	--	------------------	------	--------------------------------------------

**3.7 quattro (191 kW | 3.7 Litre)**

11.98 - 09.02	AQG, AKC		246-086-001-007C	HLWP	Plug Number (T2): 3b; T26: X11-246-003-014
---------------	----------	--	------------------	------	--------------------------------------------



			<b>VDO</b>		
Date	Engine Code	Chassis No.	Article No.	Product	Information

**AUDI****A8 (4D2, 4D8)**

<b>4.2 quattro (175 kW   4.2 Litre)</b>					
02.99 - 04.00	ARU		246-086-001-007C	HLWP	Plug Number (T2): 3b; T26: X11-246-003-014
<b>4.2 quattro (180 kW   4.2 Litre)</b>					
03.94 - 07.96	AEM		246-086-001-007C	HLWP	Plug Number (T2): 3b; T26: X11-246-003-014
<b>4.2 quattro (220 kW   4.2 Litre)</b>					
03.94 - 11.98	ABZ, AKG		246-086-001-007C	HLWP	Plug Number (T2): 3b; T26: X11-246-003-014
<b>4.2 quattro (228 kW   4.2 Litre)</b>					
11.98 - 09.02	AQF, AUW, AUX		246-086-001-007C	HLWP	Plug Number (T2): 3b; T26: X11-246-003-014
<b>6.0 W12 quattro (309 kW   6.0 Litre)</b>					
04.01 - 09.02	AZC		246-086-001-002C	HLWP	Plug Number (T2): 3
01.01 - 09.02	AZC		246-086-001-007C	HLWP	Plug Number (T2): 3b; T26: X11-246-003-014
<b>S 8 quattro (250 kW   4.2 Litre)</b>					
09.96 - 04.99	AHC, AKH		246-086-001-002C	HLWP	Plug Number (T2): 3
07.96 - 06.99	AHC, AKH		246-086-001-007C	HLWP	Plug Number (T2): 3b; T26: X11-246-003-014
<b>S 8 quattro (265 kW   4.2 Litre)</b>					
06.99 - 09.02	AQH, AVP		246-086-001-002C	HLWP	Plug Number (T2): 3
06.99 - 09.02	AQH, AVP		246-086-001-007C	HLWP	Plug Number (T2): 3b; T26: X11-246-003-014

**A8 (4E\_)**

<b>2.8 FSI (154 kW   2.8 Litre)</b>					
08.07 - 07.10	BDX		246-082-008-025G	SWP-M-C	T26: 1J0 955 665 H
<b>3.0 (160 kW   3.0 Litre)</b>					
07.03 - 05.06	BBJ		246-082-008-025G	SWP-M-C	
<b>3.0 (162 kW   3.0 Litre)</b>					
07.03 - 05.05	ASN		246-082-008-025G	SWP-M-C	
<b>3.0 TDI quattro (155 kW   3.0 Litre)</b>					
11.03 - 07.10	BNG		246-082-008-025G	SWP-M-C	
<b>3.0 TDI quattro (171 kW   3.0 Litre)</b>					
08.03 - 07.10	ASB		246-082-008-025G	SWP-M-C	
<b>3.2 FSI (191 kW   3.2 Litre)</b>					
06.05 - 07.10	BPK		246-082-008-025G	SWP-M-C	
<b>3.2 FSI quattro (191 kW   3.2 Litre)</b>					
06.05 - 07.10	BPK	4E-3-000-001 →	246-082-008-025G	SWP-M-C	
<b>3.7 quattro (206 kW   3.7 Litre)</b>					
10.02 - 05.06	BFL	4E-3-000-001 →	246-082-008-025G	SWP-M-C	
<b>4.0 TDI quattro (202 kW   4.0 Litre)</b>					
05.03 - 07.05	ASE	4E-3-000-001 →	246-082-008-025G	SWP-M-C	
<b>4.2 FSI quattro (257 kW   4.2 Litre)</b>					
06.06 - 07.10	BVJ		246-082-008-025G	SWP-M-C	
<b>4.2 quattro (246 kW   4.2 Litre)</b>					
10.02 - 07.10	BFM	4E-3-000-001 →	246-082-008-025G	SWP-M-C	
<b>4.2 TDI quattro (235 kW   4.2 Litre)</b>					
01.05 - 06.05	BMC		246-082-008-025G	SWP-M-C	
<b>4.2 TDI quattro (240 kW   4.2 Litre)</b>					
07.05 - 07.10	BVN		246-082-008-025G	SWP-M-C	
<b>6.0 W12 quattro (331 kW   6.0 Litre)</b>					
12.03 - 07.10	BHT, BSB, BTE		246-082-008-025G	SWP-M-C	
<b>S8 quattro (331 kW   5.2 Litre)</b>					
06.06 - 07.10	BSM		246-082-008-025G	SWP-M-C	

**A8 (4H\_)**

<b>3.0 TDI quattro (184 kW   3.0 Litre)</b>					
07.10 -	CDTA		246-082-008-025G	SWP-M-C	
07.10 -	CDTA	4H-A-000 001 → →4H-A-010 000	246-086-001-007C	HLWP	Plug Number (T2): 3b
<b>3.0 TFSI quattro (213 kW   3.0 Litre)</b>					
07.10 -	CGWA, CGXA		246-082-008-025G	SWP-M-C	
07.10 -	CGWA, CGXA	4H-A-000 001 → →4H-A-010 000	246-086-001-007C	HLWP	Plug Number (T2): 3b
<b>4.2 FSI quattro (273 kW   4.2 Litre)</b>					
11.09 -	CDRA		246-082-008-025G	SWP-M-C	
11.09 -	CDRA	4H-A-000 001 → →4H-A-010 000	246-086-001-007C	HLWP	Plug Number (T2): 3b



			<b>VDO</b>		
Date	Engine Code	Chassis No.	Article No.	Product	Information

**AUDI****A8 (4H\_)****4.2 TDI quattro (258 kW | 4.2 Litre)**

11.09 -	CDSB		246-082-008-025G	SWP-M-C	
11.09 -	CDSB	4H-A-000 001 - -4H-A-010 000	246-086-001-007C	HLWP	Plug Number (T2): 3b

**Q5 (8R)****2.0 TDI quattro (100 kW | 2.0 Litre)**

08.09 -	CAGB		246-083-002-022G	SWP-D-C	
08.09 -	CAGB		246-086-001-007C	HLWP	Plug Number (T2): 3b

**2.0 TDI quattro (105 kW | 2.0 Litre)**

08.09 -	CAGA		246-083-002-022G	SWP-D-C	
08.09 -	CAGA		246-086-001-007C	HLWP	Plug Number (T2): 3b

**2.0 TDI quattro (120 kW | 2.0 Litre)**

11.08 -	CAHB, CGLA		246-083-002-022G	SWP-D-C	
11.08 -	CAHB, CGLA		246-086-001-007C	HLWP	Plug Number (T2): 3b

**2.0 TDI quattro (125 kW | 2.0 Litre)**

11.08 -	CAHA		246-083-002-022G	SWP-D-C	
11.08 -	CAHA		246-086-001-007C	HLWP	Plug Number (T2): 3b

**2.0 TFSI quattro (132 kW | 2.0 Litre)**

08.09 -	CDNB		246-083-002-022G	SWP-D-C	
08.09 -	CDNB		246-086-001-007C	HLWP	Plug Number (T2): 3b

**2.0 TFSI quattro (155 kW | 2.0 Litre)**

11.08 -	CDNC		246-083-002-022G	SWP-D-C	
11.08 -	CDNC		246-086-001-007C	HLWP	Plug Number (T2): 3b

**3.0 TDI quattro (155 kW | 3.0 Litre)**

11.08 -	CCWB		246-083-002-022G	SWP-D-C	
11.08 -	CCWB		246-086-001-007C	HLWP	Plug Number (T2): 3b

**3.0 TDI quattro (176 kW | 3.0 Litre)**

11.08 -	CCWA		246-083-002-022G	SWP-D-C	
11.08 -	CCWA		246-086-001-007C	HLWP	Plug Number (T2): 3b

**3.2 FSI quattro (199 kW | 3.2 Litre)**

11.08 -	CALB		246-083-002-022G	SWP-D-C	
11.08 -	CALB		246-086-001-007C	HLWP	Plug Number (T2): 3b

**Q7 (4L)****3.0 TDI (150 kW | 3.0 Litre)**

05.10 -	CJGC, CJMA		246-083-002-022G	SWP-D-C	
05.10 -	CJGC, CJMA		246-086-001-007C	HLWP	Plug Number (T2): 3b

**3.0 TDI (155 kW | 3.0 Litre)**

03.06 - 05.10	BUN, CASB		246-083-002-022G	SWP-D-C	
03.06 - 05.10	BUN, CASB		246-086-001-007C	HLWP	Plug Number (T2): 3b

**3.0 TDI (171 kW | 3.0 Litre)**

03.06 - 05.08	BUG		246-083-002-022G	SWP-D-C	
03.06 - 05.08	BUG		246-086-001-007C	HLWP	Plug Number (T2): 3b

**3.0 TDI (176 kW | 3.0 Litre)**

11.07 -	CASA, CCMA		246-083-002-022G	SWP-D-C	
11.07 -	CASA, CCMA		246-086-001-007C	HLWP	Plug Number (T2): 3b

**3.0 TFSI (200 kW | 3.0 Litre)**

05.10 -	CJTC, CJWC		246-083-002-022G	SWP-D-C	
05.10 -	CJTC, CJWC		246-086-001-007C	HLWP	Plug Number (T2): 3b

**3.0 TFSI (245 kW | 3.0 Litre)**

05.10 -	CJTB, CJWB, CNAA		246-083-002-022G	SWP-D-C	
05.10 -	CJTB, CJWB, CNAA		246-086-001-007C	HLWP	Plug Number (T2): 3b

**3.6 FSI (206 kW | 3.6 Litre)**

08.06 - 05.10	BHK		246-083-002-022G	SWP-D-C	
08.06 - 05.10	BHK		246-086-001-007C	HLWP	Plug Number (T2): 3b

**4.2 FSI (257 kW | 4.2 Litre)**

03.06 - 05.10	BAR		246-083-002-022G	SWP-D-C	
03.06 - 05.10	BAR		246-086-001-007C	HLWP	Plug Number (T2): 3b

**4.2 TDI (240 kW | 4.2 Litre)**

03.07 - 06.09	BTR		246-083-002-022G	SWP-D-C	
03.07 - 06.09	BTR		246-086-001-007C	HLWP	Plug Number (T2): 3b



			<b>VDO</b>		
Date	Engine Code	Chassis No.	Article No.	Product	Information

**AUDI****Q7 (4L)****4.2 TDI (250 kW | 4.2 Litre)**

05.09 -	CCFA		246-083-002-022G	SWP-D-C	
05.09 -	CCFA		246-086-001-007C	HLWP	Plug Number (T2): 3b

**6.0 TDI (368 kW | 6.0 Litre)**

09.08 -	CCGA		246-083-002-022G	SWP-D-C	
09.08 -	CCGA		246-086-001-007C	HLWP	Plug Number (T2): 3b

**R8****4.2 FSI quattro (309 kW | 4.2 Litre)**

04.07 - 09.10	BYH		246-082-008-025G	SWP-M-C	
---------------	-----	--	------------------	---------	--

**4.2 FSI quattro (316 kW | 4.2 Litre)**

07.10 -	CNDA		246-082-008-025G	SWP-M-C	
---------	------	--	------------------	---------	--

**5.2 FSI quattro (386 kW | 5.2 Litre)**

04.09 - 05.12	BUJ		246-082-008-025G	SWP-M-C	
---------------	-----	--	------------------	---------	--

**R8 Spyder****4.2 FSI quattro (316 kW | 4.2 Litre)**

09.10 -	CNDA		246-082-008-025G	SWP-M-C	
---------	------	--	------------------	---------	--

**5.2 FSI quattro (386 kW | 5.2 Litre)**

02.10 - 05.12	BUJ		246-082-008-025G	SWP-M-C	
---------------	-----	--	------------------	---------	--

**TT (8N3)****1.8 T (110 kW | 1.8 Litre)**

09.02 - 06.06	AUM		246-082-008-025G	SWP-M-C	
09.02 - 06.06	AUM		246-086-001-007C	HLWP	Plug Number (T2): 3b

**1.8 T (120 kW | 1.8 Litre)**

09.05 - 06.06	BVP		246-082-008-025G	SWP-M-C	
09.05 - 06.06	BVP		246-086-001-007C	HLWP	Plug Number (T2): 3b

**1.8 T (132 kW | 1.8 Litre)**

10.98 - 06.06	AJQ, AUQ, APP, ARY, AWP, ATC	-8N-2-030 000	246-082-008-025G	SWP-M-C	
10.98 - 06.06	AJQ, AUQ, APP, ARY, AWP, ATC		246-086-001-002C	HLWP	Plug Number (T2): 3
10.98 - 06.06	AJQ, AUQ, APP, ARY, AWP, ATC		246-086-001-007C	HLWP	Plug Number (T2): 3b; T26: X11-246-003-014

**1.8 T (140 kW | 1.8 Litre)**

09.05 - 06.06	BVR		246-082-008-025G	SWP-M-C	
09.05 - 06.06	BVR		246-086-001-007C	HLWP	Plug Number (T2): 3b

**1.8 T quattro (132 kW | 1.8 Litre)**

10.98 - 06.06	AJQ, ARY, ATC, AWP	-8N-2-030 000*	246-082-008-025G	SWP-M-C	
10.98 - 06.06	AJQ, ARY, ATC, AWP		246-086-001-002C	HLWP	Plug Number (T2): 3
10.98 - 06.06	AJQ, ARY, ATC, AWP		246-086-001-007C	HLWP	Plug Number (T2): 3b; T26: X11-246-003-014

**1.8 T quattro (140 kW | 1.8 Litre)**

09.05 - 06.06	BVR		246-082-008-025G	SWP-M-C	
09.05 - 06.06	BVR		246-086-001-007C	HLWP	Plug Number (T2): 3b

**1.8 T quattro (165 kW | 1.8 Litre)**

10.98 - 06.06	BAM		246-082-008-025G	SWP-M-C	
10.98 - 06.06	APX, AMU, BAM		246-086-001-002C	HLWP	Plug Number (T2): 3
10.98 - 06.06	APX, AMU, BAM		246-086-001-007C	HLWP	Plug Number (T2): 3b; T26: X11-246-003-014

**1.8 T quattro (176 kW | 1.8 Litre)**

03.05 - 06.06	BFV		246-082-008-025G	SWP-M-C	
03.05 - 06.06	BFV		246-086-001-007C	HLWP	Plug Number (T2): 3b

**3.2 VR6 quattro (184 kW | 3.2 Litre)**

07.03 - 06.06	BPF		246-082-008-025G	SWP-M-C	
07.03 - 06.06	BHE, BPF		246-086-001-007C	HLWP	Plug Number (T2): 3b

**TT Roadster (8N9)****1.8 T (110 kW | 1.8 Litre)**

01.01 - 06.06	AUM	-8N-2-030 000	246-082-008-025G	SWP-M-C	
01.01 - 06.06	AUM		246-086-001-007C	HLWP	Plug Number (T2): 3b; T26: X11-246-003-014

**1.8 T (120 kW | 1.8 Litre)**

09.05 - 06.06	BVP		246-082-008-025G	SWP-M-C	
09.05 - 06.06	BVP		246-086-001-007C	HLWP	Plug Number (T2): 3b

**1.8 T (132 kW | 1.8 Litre)**

10.99 - 06.06	AJQ, AUQ, AWP, ATC, APP	-8N-2-030 000	246-082-008-025G	SWP-M-C	
10.99 - 06.06	AJQ, AUQ, AWP, ATC, APP		246-086-001-002C	HLWP	Plug Number (T2): 3





			<b>VDO</b>		
Date	Engine Code	Chassis No.	Article No.	Product	Information

**AUDI****TT Roadster (8N9)****1.8 T (132 kW | 1.8 Litre)**

10.99 - 06.06	AJQ, AUQ, AWP, ATC, APP		246-086-001-007C	HLWP	Plug Number (T2): 3b; T26: X11-246-003-014
---------------	-------------------------	--	------------------	------	--------------------------------------------

**1.8 T (140 kW | 1.8 Litre)**

09.05 - 06.06	BVR		246-082-008-025G	SWP-M-C	
09.05 - 06.06	BVR		246-086-001-007C	HLWP	Plug Number (T2): 3b

**1.8 T quattro (132 kW | 1.8 Litre)**

02.00 - 06.06	AWP		246-082-008-025G	SWP-M-C	
02.00 - 06.06	AJQ, ATC, ARY, AWP		246-086-001-002C	HLWP	Plug Number (T2): 3
02.00 - 06.06	AJQ, ATC, ARY, AWP		246-086-001-007C	HLWP	Plug Number (T2): 3b; T26: X11-246-003-014

**1.8 T quattro (140 kW | 1.8 Litre)**

09.05 - 06.06	BVR		246-082-008-025G	SWP-M-C	
09.05 - 06.06	BVR		246-086-001-007C	HLWP	Plug Number (T2): 3b

**1.8 T quattro (165 kW | 1.8 Litre)**

10.99 - 06.06	APX		246-082-008-025G	SWP-M-C	
10.99 - 06.06	APX, AMU, BAM		246-086-001-002C	HLWP	Plug Number (T2): 3
10.99 - 06.06	APX, AMU, BAM		246-086-001-007C	HLWP	Plug Number (T2): 3b; T26: X11-246-003-014

**3.2 VR6 quattro (184 kW | 3.2 Litre)**

07.03 - 06.06	BPF		246-082-008-025G	SWP-M-C	
07.03 - 06.06	BHE, BPF		246-086-001-007C	HLWP	Plug Number (T2): 3b

**TT (8J3)****1.8 TFSI (118 kW | 1.8 Litre)**

06.08 -	CDA A		246-082-008-025G	SWP-M-C	
06.08 -	CDA A		246-086-001-007C	HLWP	Plug Number (T2): 3b

**2.0 TDI quattro (125 kW | 2.0 Litre)**

06.08 -	CBBB		246-082-008-025G	SWP-M-C	
06.08 -	CBBB		246-086-001-007C	HLWP	Plug Number (T2): 3b

**2.0 TFSI (147 kW | 2.0 Litre)**

08.06 - 06.10	BWA, BPY, CCTA		246-082-008-025G	SWP-M-C	T26: 1J0 955 665 H
08.06 - 06.10	BPY, BWA, CCTA, CCZA		246-086-001-007C	HLWP	Plug Number (T2): 3b

**2.0 TFSI quattro (147 kW | 2.0 Litre)**

06.08 - 06.10	CCZA		246-082-008-025G	SWP-M-C	
06.08 - 06.10	CCZA		246-086-001-007C	HLWP	Plug Number (T2): 3b

**2.0 TFSI quattro (200 kW | 2.0 Litre)**

05.08 -	CDLB		246-082-008-025G	SWP-M-C	T26: 1J0 955 665 H
05.08 -	CDLB		246-086-001-007C	HLWP	Plug Number (T2): 3b

**2.5 TFSI quattro (250 kW | 2.5 Litre)**

07.09 -	CEPA		246-082-008-025G	SWP-M-C	
07.09 -	CEPA		246-086-001-007C	HLWP	Plug Number (T2): 3b

**3.2 V6 quattro (184 kW | 3.2 Litre)**

08.06 - 06.10	BUB		246-082-008-025G	SWP-M-C	T26: 1J0 955 665 H
08.06 - 06.10	BUB		246-086-001-007C	HLWP	Plug Number (T2): 3b

**TT Roadster (8J9)****1.8 TFSI (118 kW | 1.8 Litre)**

06.08 -	CDA A		246-082-008-025G	SWP-M-C	
06.08 -	CDA A		246-086-001-007C	HLWP	Plug Number (T2): 3b

**2.0 TDI quattro (125 kW | 2.0 Litre)**

06.08 -	CBBB		246-082-008-025G	SWP-M-C	
06.08 -	CBBB		246-086-001-007C	HLWP	Plug Number (T2): 3b

**2.0 TFSI (147 kW | 2.0 Litre)**

03.07 - 06.10	BWA		246-082-008-025G	SWP-M-C	
03.07 - 06.10	BPY, BWA, CCTA, CCZA		246-086-001-007C	HLWP	Plug Number (T2): 3b

**2.0 TFSI quattro (147 kW | 2.0 Litre)**

06.08 - 06.10	CCZA		246-082-008-025G	SWP-M-C	
06.08 - 06.10	CCZA		246-086-001-007C	HLWP	Plug Number (T2): 3b

**2.0 TFSI quattro (200 kW | 2.0 Litre)**

05.08 -	CDLB		246-082-008-025G	SWP-M-C	
05.08 -	CDLB		246-086-001-007C	HLWP	Plug Number (T2): 3b

**2.5 TFSI quattro (250 kW | 2.5 Litre)**

07.09 -	CEPA		246-082-008-025G	SWP-M-C	
07.09 -	CEPA		246-086-001-007C	HLWP	Plug Number (T2): 3b



Date	Engine Code	Chassis No.	Article No.	Product	Information

**AUDI****TT Roadster (8J9)****3.2 V6 quattro (184 kW | 3.2 Litre)**

03.07 - 06.10	BUB		246-082-008-025G	SWP-M-C	
03.07 - 06.10	BUB		246-086-001-007C	HLWP	Plug Number (T2): 3b

**50 (86)****0.8 (25 kW | 0.8 Litre)**

01.76 - 07.78	HE		246-082-008-014C	SWP-M-C	Plug Number (T2): 1
---------------	----	--	------------------	---------	---------------------

**1.1 (37 kW | 1.1 Litre)**

08.74 - 07.78	HB		246-075-021-006C	SWP-M-G	Plug Number (T2): 1
08.74 - 07.78	AR 67501, HB		246-082-008-014C	SWP-M-C	Plug Number (T2): 1

**1.1 (44 kW | 1.1 Litre)**

08.74 - 07.77	HC		246-075-021-006C	SWP-M-G	Plug Number (T2): 1
08.74 - 07.77	AR 67202, HC		246-082-008-014C	SWP-M-C	Plug Number (T2): 1

**1.3 (43 kW | 1.3 Litre)**

01.77 - 07.78	HJ		246-082-008-014C	SWP-M-C	Plug Number (T2): 1
---------------	----	--	------------------	---------	---------------------

**1.3 (44 kW | 1.3 Litre)**

08.77 - 07.78	HH		246-075-021-006C	SWP-M-G	Plug Number (T2): 1
08.77 - 07.78	AR 67201, HH		246-082-008-014C	SWP-M-C	Plug Number (T2): 1

**80 (80, 82, B1)****1.3 (40 kW | 1.3 Litre)**

05.72 - 12.76	ZA	→827 2084 529	246-075-021-006C	SWP-M-G	Plug Number (T2): 1
12.76 - 07.78	X 20 XEV	827 2084 530→	246-082-008-014C	SWP-M-C	Plug Number (T2): 1

**1.3 (44 kW | 1.3 Litre)**

03.73 - 12.76	ZF	→827 2084 529	246-075-021-006C	SWP-M-G	Plug Number (T2): 1
12.76 - 07.78	ZF	827 2084 530→	246-082-008-014C	SWP-M-C	Plug Number (T2): 1

**1.5 (55 kW | 1.5 Litre)**

03.73 - 08.75	ZB, YJ		246-075-021-006C	SWP-M-G	Plug Number (T2): 1
---------------	--------	--	------------------	---------	---------------------

**1.5 (63 kW | 1.5 Litre)**

05.73 - 08.75	ZC		246-075-021-006C	SWP-M-G	Plug Number (T2): 1
---------------	----	--	------------------	---------	---------------------

**1.6 (55 kW | 1.6 Litre)**

09.75 - 12.76	YN	→827 2084 529	246-075-021-006C	SWP-M-G	Plug Number (T2): 1
12.76 - 07.78	YN	827 2084 530→	246-082-008-014C	SWP-M-C	Plug Number (T2): 1

**1.6 GT (74 kW | 1.6 Litre)**

09.73 - 08.75	XX		246-075-021-006C	SWP-M-G	Plug Number (T2): 1
---------------	----	--	------------------	---------	---------------------

**1.6 GTE (81 kW | 1.6 Litre)**

01.76 - 12.76	YS	→827 2084 529	246-075-021-006C	SWP-M-G	Plug Number (T2): 1
12.76 - 07.78	YS	827 2084 530→	246-082-008-014C	SWP-M-C	Plug Number (T2): 1

**80 (81, 85, B2)****1.3 (40 kW | 1.3 Litre)**

09.78 - 07.81	FY		246-082-008-014C	SWP-M-C	Plug Number (T2): 1
09.78 - 07.81	FY		246-086-001-007C	HLWP	Plug Number (T2): 3b; T26: X11-246-003-014

**1.3 (44 kW | 1.3 Litre)**

09.78 - 07.81	FZ		246-082-008-014C	SWP-M-C	Plug Number (T2): 1
08.81 - 07.86	EP		246-082-008-014C	SWP-M-C	Plug Number (T2): 1
09.78 - 07.86	EP		246-086-001-007C	HLWP	Plug Number (T2): 3b; T26: X11-246-003-014

**1.6 (51 kW | 1.6 Litre)**

08.78 - 07.81	YT, YY		246-082-008-014C	SWP-M-C	Plug Number (T2): 1
---------------	--------	--	------------------	---------	---------------------

**1.6 (54 kW | 1.6 Litre)**

02.86 - 07.86	SA		246-082-008-014C	SWP-M-C	Plug Number (T2): 1
02.86 - 07.86	SA		246-086-001-007C	HLWP	Plug Number (T2): 3b; T26: X11-246-003-014

**1.6 (55 kW | 1.6 Litre)**

08.78 - 07.86	YN, WV		246-082-008-014C	SWP-M-C	Plug Number (T2): 1
08.81 - 07.86	DT		246-082-008-014C	SWP-M-C	Plug Number (T2): 1
08.78 - 07.86	DT		246-086-001-007C	HLWP	Plug Number (T2): 3b; T26: X11-246-003-014

**1.6 (63 kW | 1.6 Litre)**

08.78 - 02.83	YP	827 2084 530→	246-082-008-014C	SWP-M-C	Plug Number (T2): 1
08.78 - 02.83	YP		246-086-001-007C	HLWP	Plug Number (T2): 3b; T26: X11-246-003-014

**1.6 D (40 kW | 1.6 Litre)**

08.81 - 08.86	CR, JK		246-082-008-014C	SWP-M-C	Plug Number (T2): 1
08.80 - 08.86	CR, JK		246-086-001-007C	HLWP	Plug Number (T2): 3b; T26: X11-246-003-014



			<b>VDO</b>		
Date	Engine Code	Chassis No.	Article No.	Product	Information

**AUDI****80 (81, 85, B2)****1.6 GLE (81 kW | 1.6 Litre)**

01.79 - 07.82	YZ		246-082-008-014C	SWP-M-C	Plug Number (T2): 1
01.79 - 12.86	YZ		246-086-001-007C	HLWP	Plug Number (T2): 3b; T26: X11-246-003-014

**1.6 TD (51 kW | 1.6 Litre)**

02.82 - 05.86	CY		246-082-008-014C	SWP-M-C	Plug Number (T2): 1
08.81 - 05.86	CY		246-086-001-007C	HLWP	Plug Number (T2): 3b; T26: X11-246-003-014

**1.8 (65 kW | 1.8 Litre)**

02.86 - 07.86	SF		246-082-008-014C	SWP-M-C	Plug Number (T2): 1
02.86 - 07.86	SF		246-086-001-007C	HLWP	Plug Number (T2): 3b; T26: X11-246-003-014

**1.8 (66 kW | 1.8 Litre)**

01.83 - 08.86	DS		246-082-008-014C	SWP-M-C	Plug Number (T2): 1
01.83 - 08.86	DS		246-086-001-007C	HLWP	Plug Number (T2): 3b; T26: X11-246-003-014

**1.8 (68 kW | 1.8 Litre)**

08.83 - 08.86	JN		246-086-001-007C	HLWP	Plug Number (T2): 3b; T26: X11-246-003-014
---------------	----	--	------------------	------	--------------------------------------------

**1.8 CC quattro (85Q) (66 kW | 1.8 Litre)**

08.84 - 08.86	NE, JV		246-082-008-014C	SWP-M-C	Plug Number (T2): 1
08.84 - 08.86	NE, JV		246-086-001-007C	HLWP	Plug Number (T2): 3b; T26: X11-246-003-014

**1.8 CC quattro (85Q) (68 kW | 1.8 Litre)**

08.85 - 08.86	JN		246-086-001-007C	HLWP	Plug Number (T2): 3b; T26: X11-246-003-014
---------------	----	--	------------------	------	--------------------------------------------

**1.8 GTE (81 kW | 1.8 Litre)**

08.85 - 07.86	PV		246-082-008-014C	SWP-M-C	Plug Number (T2): 1
08.85 - 07.86	PV		246-086-001-007C	HLWP	Plug Number (T2): 3b; T26: X11-246-003-014

**1.8 GTE (82 kW | 1.8 Litre)**

10.84 - 08.86	DZ		246-082-008-014C	SWP-M-C	Plug Number (T2): 1
10.84 - 08.86	DZ		246-086-001-007C	HLWP	Plug Number (T2): 3b; T26: X11-246-003-014

**1.8 GTE quattro (85Q) (81 kW | 1.8 Litre)**

03.85 - 08.86	PV		246-082-008-014C	SWP-M-C	Plug Number (T2): 1
03.85 - 08.86	PV		246-086-001-007C	HLWP	Plug Number (T2): 3b; T26: X11-246-003-014

**1.8 GTE quattro (85Q) (82 kW | 1.8 Litre)**

08.84 - 08.86	DZ		246-082-008-014C	SWP-M-C	Plug Number (T2): 1
08.84 - 08.86	DZ		246-086-001-007C	HLWP	Plug Number (T2): 3b; T26: X11-246-003-014

**1.9 CD-5S (85 kW | 1.9 Litre)**

09.81 - 07.83	WN		246-082-008-014C	SWP-M-C	Plug Number (T2): 1
09.81 - 07.83	WN		246-086-001-007C	HLWP	Plug Number (T2): 3b; T26: X11-246-003-014

**2.0 (85 kW | 2.0 Litre)**

10.83 - 09.84	JS, HP		246-082-008-014C	SWP-M-C	Plug Number (T2): 1
10.83 - 09.84	JS, HP		246-086-001-007C	HLWP	Plug Number (T2): 3b; T26: X11-246-003-014

**2.0 quattro (85Q) (85 kW | 2.0 Litre)**

10.83 - 07.84	JS		246-082-008-014C	SWP-M-C	Plug Number (T2): 1
10.83 - 09.84	JS		246-086-001-007C	HLWP	Plug Number (T2): 3b; T26: X11-246-003-014

**2.2 (85 kW | 2.2 Litre)**

10.80 - 07.83	WE		246-082-008-014C	SWP-M-C	Plug Number (T2): 1
10.80 - 07.83	WE		246-086-001-007C	HLWP	Plug Number (T2): 3b; T26: X11-246-003-014

**2.2 quattro (85Q) (100 kW | 2.2 Litre)**

08.82 - 07.84	KK		246-082-008-014C	SWP-M-C	Plug Number (T2): 1
08.82 - 07.84	KK		246-086-001-007C	HLWP	Plug Number (T2): 3b; T26: X11-246-003-014

**2.2 quattro (96 kW | 2.2 Litre)**

08.82 - 07.84	KL		246-082-008-014C	SWP-M-C	Plug Number (T2): 1
---------------	----	--	------------------	---------	---------------------

**COUPE (81, 85)****1.6 (55 kW | 1.6 Litre)**

02.81 - 08.81	YN		246-082-008-014C	SWP-M-C	Plug Number (T2): 1
07.80 - 08.81	YN		246-086-001-007C	HLWP	Plug Number (T2): 3b; T24: GL ↔; T26: X11-246-003-014

**1.8 (55 kW | 1.8 Litre)**

09.82 - 07.83	DD		246-082-008-014C	SWP-M-C	Plug Number (T2): 1
08.81 - 07.83	DD		246-086-001-007C	HLWP	Plug Number (T2): 3b; T24: GL ↔; T26: X11-246-003-014

**1.8 GT (65 kW | 1.8 Litre)**

07.86 - 07.88	SF		246-082-008-014C	SWP-M-C	Plug Number (T2): 1
04.86 - 10.88	SF		246-086-001-007C	HLWP	Plug Number (T2): 3b; T24: GL ↔; T26: X11-246-003-014



			<b>VDO</b>		
Date	Engine Code	Chassis No.	Article No.	Product	Information

**AUDI****COUPE (81, 85)**

<b>1.8 GT (66 kW   1.8 Litre)</b>					
08.84 - 07.88	DS, JV		246-082-008-014C	SWP-M-C	Plug Number (T2): 1
09.82 - 10.88	DS, JV		246-086-001-007C	HLWP	Plug Number (T2): 3b; T24: GL ↔; T26: X11-246-003-014
<b>1.8 GT (68 kW   1.8 Litre)</b>					
01.85 - 07.88	JN		246-086-001-007C	HLWP	Plug Number (T2): 3b; T24: GL ↔; T26: X11-246-003-014
<b>1.8 GT (79 kW   1.8 Litre)</b>					
08.86 - 10.87	PV		246-082-008-014C	SWP-M-C	Plug Number (T2): 1
08.86 - 10.87	PV		246-086-001-007C	HLWP	Plug Number (T2): 3b; T24: GL ↔; T26: X11-246-003-014
<b>1.8 GT (82 kW   1.8 Litre)</b>					
08.86 - 10.88	DZ		246-086-001-007C	HLWP	Plug Number (T2): 3b; T24: GL ↔; T26: X11-246-003-014
<b>1.8 GT quattro (66 kW   1.8 Litre)</b>					
09.85 - 10.88	DS, NE, JN		246-082-008-014C	SWP-M-C	Plug Number (T2): 1
<b>1.8 GT quattro (82 kW   1.8 Litre)</b>					
12.84 - 10.88	DZ		246-082-008-014C	SWP-M-C	Plug Number (T2): 1
<b>1.9 (85 kW   1.9 Litre)</b>					
10.80 - 07.83	WN		246-082-008-014C	SWP-M-C	Plug Number (T2): 1
08.80 - 07.83	WN		246-086-001-007C	HLWP	Plug Number (T2): 3b; T24: GL ↔; T26: X11-246-003-014
<b>2.0 (83 kW   2.0 Litre)</b>					
03.86 - 07.87	SK		246-082-008-014C	SWP-M-C	Plug Number (T2): 1
03.86 - 04.88	SK		246-086-001-007C	HLWP	Plug Number (T2): 3b; T24: GL ↔; T26: X11-246-003-014
<b>2.0 (85 kW   2.0 Litre)</b>					
09.83 - 07.86	JS, HP		246-082-008-014C	SWP-M-C	Plug Number (T2): 1
09.83 - 07.86	JS, HP		246-086-001-007C	HLWP	Plug Number (T2): 3b; T24: GL ↔; T26: X11-246-003-014
<b>2.1 GT (79 kW   2.1 Litre)</b>					
01.81 - 07.83	WE		246-086-001-007C	HLWP	Plug Number (T2): 3b; T24: GL ↔; T26: X11-246-003-014
<b>2.1 GT (96 kW   2.1 Litre)</b>					
09.82 - 08.84	KE, KL		246-082-008-014C	SWP-M-C	Plug Number (T2): 1
09.82 - 08.84	KE, KL		246-086-001-007C	HLWP	Plug Number (T2): 3b; T24: GL ↔; T26: X11-246-003-014
<b>2.2 GT (100 kW   2.2 Litre)</b>					
09.84 - 10.88	KV, HY		246-082-008-014C	SWP-M-C	Plug Number (T2): 1
09.84 - 10.88	KV, HY		246-086-001-007C	HLWP	Plug Number (T2): 3b; T24: GL ↔; T26: X11-246-003-014
<b>2.2 GT (85 kW   2.2 Litre)</b>					
01.85 - 10.87	KX		246-082-008-014C	SWP-M-C	Plug Number (T2): 1
07.81 - 10.87	KX		246-086-001-007C	HLWP	Plug Number (T2): 3b; T24: GL ↔; T26: X11-246-003-014
<b>2.2 quattro (100 kW   2.2 Litre)</b>					
12.84 - 12.87	KV		246-082-008-014C	SWP-M-C	Plug Number (T2): 1
10.84 - 10.88	KV		246-086-001-007C	HLWP	Plug Number (T2): 3b; T24: GL ↔; T26: X11-246-003-014
<b>2.2 quattro (88 kW   2.2 Litre)</b>					
08.85 - 12.87	JT		246-082-008-014C	SWP-M-C	Plug Number (T2): 1
08.85 - 10.88	JT		246-086-001-007C	HLWP	Plug Number (T2): 3b; T24: GL ↔; T26: X11-246-003-014
<b>2.3 (100 kW   2.3 Litre)</b>					
02.87 - 07.88	NG		246-082-008-014C	SWP-M-C	Plug Number (T2): 1
01.87 - 10.88	NG		246-086-001-007C	HLWP	Plug Number (T2): 3b; T24: GL ↔; T26: X11-246-003-014
<b>2.3 quattro (100 kW   2.3 Litre)</b>					
01.87 - 12.87	NG		246-082-008-014C	SWP-M-C	Plug Number (T2): 1
01.87 - 10.88	NG		246-086-001-007C	HLWP	Plug Number (T2): 3b; T24: GL ↔; T26: X11-246-003-014



			<b>VDO</b>		
Date	Engine Code	Chassis No.	Article No.	Product	Information

**AUDI****QUATTRO (85)****2.1 20V Turbo (225 kW | 2.1 Litre)**

05.84 - 07.87	KW		246-082-008-014C	SWP-M-C	Plug Number (T2): 1
05.84 - 07.87	KW		246-086-001-007C	HLWP	Plug Number (T2): 3b; T26: X11-246-003-014

**2.1 Turbo (147 kW | 2.1 Litre)**

07.80 - 07.87	GV, WR		246-082-008-014C	SWP-M-C	Plug Number (T2): 1
07.80 - 07.87	GV, WR		246-086-001-007C	HLWP	Plug Number (T2): 3b; T26: X11-246-003-014

**2.2 20V (162 kW | 2.2 Litre)**

08.89 - 07.91	RR		246-082-008-014C	SWP-M-C	Plug Number (T2): 1
08.89 - 07.91	RR		246-086-001-007C	HLWP	Plug Number (T2): 3b; T26: X11-246-003-014

**2.2 Turbo (147 kW | 2.2 Litre)**

08.87 - 07.89	1B, MB		246-082-008-014C	SWP-M-C	Plug Number (T2): 1
08.87 - 07.89	1B, MB		246-086-001-007C	HLWP	Plug Number (T2): 3b; T26: X11-246-003-014

**80 (89, 89Q, 8A, B3)****1.4 (48 kW | 1.4 Litre)**

08.86 - 07.88	SE		246-082-008-014C	SWP-M-C	Plug Number (T2): 1
---------------	----	--	------------------	---------	---------------------

**1.6 (51 kW | 1.6 Litre)**

08.87 - 08.91	PP		246-082-008-014C	SWP-M-C	Plug Number (T2): 1
08.89 - 08.91	PP		246-086-001-002C	HLWP	Plug Number (T2): 3
08.87 - 09.91	PP		246-086-001-007C	HLWP	Plug Number (T2): 3b; T26: X11-246-003-014

**1.6 (55 kW | 1.6 Litre)**

09.86 - 08.91	RN		246-082-008-014C	SWP-M-C	Plug Number (T2): 1
08.89 - 08.91	RN		246-086-001-002C	HLWP	Plug Number (T2): 3
09.86 - 08.91	RN		246-086-001-007C	HLWP	Plug Number (T2): 3b; T26: X11-246-003-014

**1.6 (75 kW | 1.6 Litre)**

08.90 - 10.91	ABB		246-082-008-014C	SWP-M-C	Plug Number (T2): 1
---------------	-----	--	------------------	---------	---------------------

**1.6 D (40 kW | 1.6 Litre)**

02.87 - 07.89	JK		246-082-008-014C	SWP-M-C	Plug Number (T2): 1
09.86 - 08.91	JK		246-086-001-007C	HLWP	Plug Number (T2): 3b; T26: X11-246-003-014

**1.6 TD (59 kW | 1.6 Litre)**

04.88 - 08.91	RA, SB		246-082-008-014C	SWP-M-C	Plug Number (T2): 1
01.89 - 08.91	RA, SB		246-086-001-002C	HLWP	Plug Number (T2): 3
09.86 - 08.91	RA, SB		246-086-001-007C	HLWP	Plug Number (T2): 3b; T26: X11-246-003-014

**1.8 (55 kW | 1.8 Litre)**

10.86 - 01.90	RU		246-082-008-014C	SWP-M-C	Plug Number (T2): 1
08.89 - 01.90	RU		246-086-001-002C	HLWP	Plug Number (T2): 3
10.86 - 01.90	RU		246-086-001-007C	HLWP	Plug Number (T2): 3b; T26: X11-246-003-014

**1.8 (83 kW | 1.8 Litre)**

09.86 - 07.88	SD		246-082-008-014C	SWP-M-C	Plug Number (T2): 1
09.86 - 07.88	SD		246-086-001-007C	HLWP	Plug Number (T2): 3b; T26: X11-246-003-014

**1.8 E (82 kW | 1.8 Litre)**

09.86 - 08.91	DZ		246-082-008-014C	SWP-M-C	Plug Number (T2): 1
08.89 - 08.91	DZ		246-086-001-002C	HLWP	Plug Number (T2): 3
06.86 - 08.91	DZ		246-086-001-007C	HLWP	Plug Number (T2): 3b; T26: X11-246-003-014

**1.8 E quattro (82 kW | 1.8 Litre)**

09.86 - 08.91	DZ		246-082-008-014C	SWP-M-C	Plug Number (T2): 1
---------------	----	--	------------------	---------	---------------------

**1.8 quattro (83 kW | 1.8 Litre)**

09.86 - 07.88	SD		246-082-008-014C	SWP-M-C	Plug Number (T2): 1
---------------	----	--	------------------	---------	---------------------

**1.8 S (65 kW | 1.8 Litre)**

09.86 - 12.90	SF		246-082-008-014C	SWP-M-C	Plug Number (T2): 1
08.89 - 12.90	SF		246-086-001-002C	HLWP	Plug Number (T2): 3
09.86 - 12.90	SF		246-086-001-007C	HLWP	Plug Number (T2): 3b; T26: X11-246-003-014

**1.8 S (66 kW | 1.8 Litre)**

09.86 - 08.91	PM, JN, NE		246-082-008-014C	SWP-M-C	Plug Number (T2): 1
08.89 - 08.91	PM, JN, NE		246-086-001-002C	HLWP	Plug Number (T2): 3
09.86 - 10.91	PM, JN, NE		246-086-001-007C	HLWP	Plug Number (T2): 3b; T26: X11-246-003-014

**1.8 S quattro (65 kW | 1.8 Litre)**

09.86 - 07.90	SF		246-082-008-014C	SWP-M-C	Plug Number (T2): 1
---------------	----	--	------------------	---------	---------------------

**1.8 S quattro (66 kW | 1.8 Litre)**

09.86 - 07.90	PM, JN, NE		246-082-008-014C	SWP-M-C	Plug Number (T2): 1
---------------	------------	--	------------------	---------	---------------------

**1.9 D (50 kW | 1.9 Litre)**

08.89 - 08.91	1Y		246-082-008-014C	SWP-M-C	Plug Number (T2): 1
08.89 - 08.91	1Y		246-086-001-002C	HLWP	Plug Number (T2): 3



			<b>VDO</b>		
Date	Engine Code	Chassis No.	Article No.	Product	Information

**AUDI****80 (89, 89Q, 8A, B3)****1.9 D (50 kW | 1.9 Litre)**

08.89 - 08.91	1Y		246-086-001-007C	HLWP	Plug Number (T2): 3b; T26: X11-246-003-014
---------------	----	--	------------------	------	--------------------------------------------

**2.0 (82 kW | 2.0 Litre)**

10.90 - 08.91	AAD		246-086-001-007C	HLWP	Plug Number (T2): 3b; T26: X11-246-003-014
---------------	-----	--	------------------	------	--------------------------------------------

**2.0 E (83 kW | 2.0 Litre)**

08.88 - 10.90	3A		246-082-008-014C	SWP-M-C	Plug Number (T2): 1
---------------	----	--	------------------	---------	---------------------

08.89 - 10.90	3A		246-086-001-002C	HLWP	Plug Number (T2): 3
---------------	----	--	------------------	------	---------------------

08.88 - 10.90	3A		246-086-001-007C	HLWP	Plug Number (T2): 3b; T26: X11-246-003-014
---------------	----	--	------------------	------	--------------------------------------------

**2.0 E 16V (101 kW | 2.0 Litre)**

03.90 - 08.91	6A		246-082-008-014C	SWP-M-C	Plug Number (T2): 1
---------------	----	--	------------------	---------	---------------------

03.90 - 08.91	6A		246-086-001-002C	HLWP	Plug Number (T2): 3
---------------	----	--	------------------	------	---------------------

03.90 - 09.91	6A		246-086-001-007C	HLWP	Plug Number (T2): 3b; T26: X11-246-003-014
---------------	----	--	------------------	------	--------------------------------------------

**2.0 E 16V quattro (101 kW | 2.0 Litre)**

03.90 - 08.91	6A		246-082-008-014C	SWP-M-C	Plug Number (T2): 1
---------------	----	--	------------------	---------	---------------------

**2.0 E quattro (83 kW | 2.0 Litre)**

08.88 - 09.90	3A		246-082-008-014C	SWP-M-C	Plug Number (T2): 1
---------------	----	--	------------------	---------	---------------------

**2.0 quattro (82 kW | 2.0 Litre)**

10.90 - 08.91	3A		246-082-008-014C	SWP-M-C	Plug Number (T2): 1
---------------	----	--	------------------	---------	---------------------

**2.0 quattro (85 kW | 2.0 Litre)**

10.90 - 08.91	AAD		246-082-008-014C	SWP-M-C	Plug Number (T2): 1
---------------	-----	--	------------------	---------	---------------------

**COUPE (89, 8B)****1.8 (82 kW | 1.8 Litre)**

08.89 - 07.91	DZ		246-082-008-014C	SWP-M-C	Plug Number (T2): 1
---------------	----	--	------------------	---------	---------------------

08.89 - 07.91	DZ		246-086-001-007C	HLWP	Plug Number (T2): 3b; T26: X11-246-003-014
---------------	----	--	------------------	------	--------------------------------------------

**2.0 (82 kW | 2.0 Litre)**

03.90 - 07.90	3A		246-082-008-014C	SWP-M-C	Plug Number (T2): 1
---------------	----	--	------------------	---------	---------------------

**2.0 (83 kW | 2.0 Litre)**

05.89 - 03.90	3A		246-082-008-014C	SWP-M-C	Plug Number (T2): 1
---------------	----	--	------------------	---------	---------------------

**2.0 (85 kW | 2.0 Litre)**

08.89 - 07.91	AAD, ABK		246-082-008-014C	SWP-M-C	Plug Number (T2): 1
---------------	----------	--	------------------	---------	---------------------

05.89 - 12.96	AAD, ABK		246-086-001-007C	HLWP	Plug Number (T2): 3b; T26: X11-246-003-014
---------------	----------	--	------------------	------	--------------------------------------------

**2.0 16 V (101 kW | 2.0 Litre)**

01.92 - 07.92	6A		246-082-008-014C	SWP-M-C	Plug Number (T2): 1
---------------	----	--	------------------	---------	---------------------

01.92 - 07.92	6A		246-086-001-007C	HLWP	Plug Number (T2): 3b; T26: X11-246-003-014
---------------	----	--	------------------	------	--------------------------------------------

**2.0 16 V (103 kW | 2.0 Litre)**

08.92 - 12.96	ACE		246-086-001-007C	HLWP	Plug Number (T2): 3b; T26: X11-246-003-014
---------------	-----	--	------------------	------	--------------------------------------------

**2.0 20 V (118 kW | 2.0 Litre)**

08.89 - 07.91	NM		246-082-008-014C	SWP-M-C	Plug Number (T2): 1
---------------	----	--	------------------	---------	---------------------

**2.0 20 V quattro (118 kW | 2.0 Litre)**

08.89 - 07.91	NM		246-082-008-014C	SWP-M-C	Plug Number (T2): 1
---------------	----	--	------------------	---------	---------------------

08.89 - 07.91	NM		246-086-001-002C	HLWP	Plug Number (T2): 3
---------------	----	--	------------------	------	---------------------

08.89 - 07.91	NM		246-086-001-007C	HLWP	Plug Number (T2): 3b; T26: X11-246-003-014
---------------	----	--	------------------	------	--------------------------------------------

**2.2 quattro (100 kW | 2.2 Litre)**

11.88 - 07.91	KV		246-082-008-014C	SWP-M-C	Plug Number (T2): 1
---------------	----	--	------------------	---------	---------------------

11.88 - 07.91	KV		246-086-001-002C	HLWP	Plug Number (T2): 3
---------------	----	--	------------------	------	---------------------

11.88 - 07.91	KV		246-086-001-007C	HLWP	Plug Number (T2): 3b; T26: X11-246-003-014
---------------	----	--	------------------	------	--------------------------------------------

**2.3 (100 kW | 2.3 Litre)**

11.88 - 05.94	NG	-M - 040 000	246-082-008-014C	SWP-M-C	Plug Number (T2): 1
---------------	----	--------------	------------------	---------	---------------------

10.88 - 07.94	NG		246-086-001-007C	HLWP	Plug Number (T2): 3b; T26: X11-246-003-014
---------------	----	--	------------------	------	--------------------------------------------

**2.3 (98 kW | 2.3 Litre)**

03.90 - 12.96	NG		246-086-001-007C	HLWP	Plug Number (T2): 3b; T26: X11-246-003-014
---------------	----	--	------------------	------	--------------------------------------------

**2.3 20V (123 kW | 2.3 Litre)**

08.90 - 07.91	7A		246-082-008-014C	SWP-M-C	Plug Number (T2): 1
---------------	----	--	------------------	---------	---------------------

08.90 - 07.91	7A		246-086-001-007C	HLWP	Plug Number (T2): 3b; T26: X11-246-003-014
---------------	----	--	------------------	------	--------------------------------------------

**2.3 20V (125 kW | 2.3 Litre)**

08.89 - 07.91	7A		246-086-001-007C	HLWP	Plug Number (T2): 3b; T26: X11-246-003-014
---------------	----	--	------------------	------	--------------------------------------------

**2.3 20V quattro (123 kW | 2.3 Litre)**

05.90 - 12.96	7A		246-086-001-007C	HLWP	Plug Number (T2): 3b; T26: X11-246-003-014
---------------	----	--	------------------	------	--------------------------------------------

**2.3 20V quattro (125 kW | 2.3 Litre)**

11.88 - 07.91	7A		246-082-008-014C	SWP-M-C	Plug Number (T2): 1
---------------	----	--	------------------	---------	---------------------

11.88 - 07.91	7A		246-086-001-002C	HLWP	Plug Number (T2): 3
---------------	----	--	------------------	------	---------------------

11.88 - 07.91	7A		246-086-001-007C	HLWP	Plug Number (T2): 3b; T26: X11-246-003-014
---------------	----	--	------------------	------	--------------------------------------------



			<b>VDO</b>		
Date	Engine Code	Chassis No.	Article No.	Product	Information

**AUDI****COUPE (89, 8B)****2.3 quattro (100 kW | 2.3 Litre)**

11.88 - 12.92	NG	-M - 040 000	246-082-008-014C	SWP-M-C	Plug Number (T2): 1
11.88 - 12.92	NG		246-086-001-002C	HLWP	Plug Number (T2): 3
11.88 - 12.92	NG		246-086-001-007C	HLWP	Plug Number (T2): 3b; T26: X11-246-003-014

**2.3 quattro (98 kW | 2.3 Litre)**

05.90 - 12.96	NG		246-086-001-007C	HLWP	Plug Number (T2): 3b; T26: X11-246-003-014
---------------	----	--	------------------	------	--------------------------------------------

**2.6 (110 kW | 2.6 Litre)**

08.92 - 01.96	ABC		246-082-008-014C	SWP-M-C	Plug Number (T2): 1
07.94 - 01.96	ABC	S - 000 001→	246-086-001-002C	HLWP	Plug Number (T2): 3
08.92 - 12.96	ABC		246-086-001-007C	HLWP	Plug Number (T2): 3b; T26: X11-246-003-014

**2.6 quattro (110 kW | 2.6 Litre)**

08.92 - 05.95	ABC		246-082-008-014C	SWP-M-C	Plug Number (T2): 1
08.92 - 05.95	ABC		246-086-001-002C	HLWP	Plug Number (T2): 3
08.92 - 12.96	ABC		246-086-001-007C	HLWP	Plug Number (T2): 3b; T26: X11-246-003-014

**2.8 (128 kW | 2.8 Litre)**

09.91 - 03.95	AAH		246-082-008-014C	SWP-M-C	Plug Number (T2): 1
07.94 - 03.95	AAH	S - 000 001→	246-086-001-002C	HLWP	Plug Number (T2): 3
09.91 - 12.96	AAH		246-086-001-007C	HLWP	Plug Number (T2): 3b; T26: X11-246-003-014

**2.8 quattro (128 kW | 2.8 Litre)**

08.91 - 05.95	AAH		246-082-008-014C	SWP-M-C	Plug Number (T2): 1
08.91 - 05.95	AAH		246-086-001-002C	HLWP	Plug Number (T2): 3
08.91 - 12.96	AAH		246-086-001-007C	HLWP	Plug Number (T2): 3b; T26: X11-246-003-014

**S2 quattro (162 kW | 2.2 Litre)**

09.90 - 09.92	3B	-M - 040 000	246-082-008-014C	SWP-M-C	Plug Number (T2): 1
09.90 - 09.92	3B		246-086-001-002C	HLWP	Plug Number (T2): 3
09.90 - 09.92	3B		246-086-001-007C	HLWP	Plug Number (T2): 3b; T26: X11-246-003-014

**S2 quattro (169 kW | 2.2 Litre)**

10.92 - 05.95	ABY		246-082-008-014C	SWP-M-C	Plug Number (T2): 1
10.92 - 05.95	ABY		246-086-001-002C	HLWP	Plug Number (T2): 3
10.92 - 12.96	ABY		246-086-001-007C	HLWP	Plug Number (T2): 3b; T26: X11-246-003-014

**CABRIOLET (8G7, B4)****1.8 (92 kW | 1.8 Litre)**

01.97 - 08.00	ADR		246-082-008-014C	SWP-M-C	Plug Number (T2): 1
04.97 - 07.98	ADR		246-086-001-002C	HLWP	Plug Number (T2): 3

**1.9 TDI (66 kW | 1.9 Litre)**

06.95 - 08.00	1Z, AHU		246-082-008-014C	SWP-M-C	Plug Number (T2): 1
07.95 - 07.98	1Z, AHU		246-086-001-002C	HLWP	Plug Number (T2): 3

**2.0 16V (103 kW | 2.0 Litre)**

06.95 - 07.96	ACE		246-082-008-014C	SWP-M-C	Plug Number (T2): 1
06.95 - 07.96	ACE		246-086-001-002C	HLWP	Plug Number (T2): 3

**2.0 E (85 kW | 2.0 Litre)**

01.93 - 07.98	X 10 XE		246-082-008-014C	SWP-M-C	Plug Number (T2): 1
01.93 - 07.94	ABK		246-086-001-002C	HLWP	Plug Number (T2): 3

**2.3 E (98 kW | 2.3 Litre)**

05.91 - 07.94	NG		246-082-008-014C	SWP-M-C	Plug Number (T2): 1
06.91 - 07.94	NG		246-086-001-002C	HLWP	Plug Number (T2): 3

**2.6 (102 kW | 2.6 Litre)**

05.95 - 07.96	ACZ		246-086-001-002C	HLWP	Plug Number (T2): 3
---------------	-----	--	------------------	------	---------------------

**2.6 (110 kW | 2.6 Litre)**

06.93 - 08.00	ABC		246-082-008-014C	SWP-M-C	Plug Number (T2): 1
01.94 - 12.94	ABC		246-086-001-002C	HLWP	Plug Number (T2): 3

**2.8 (128 kW | 2.8 Litre)**

11.92 - 08.00	AAH		246-082-008-014C	SWP-M-C	Plug Number (T2): 1
11.92 - 12.94	AAH		246-086-001-002C	HLWP	Plug Number (T2): 3

**80 (8C, B4)****1.6 (52 kW | 1.6 Litre)**

08.93 - 12.94	ABM	R - 000 001→	246-086-001-002C	HLWP	Plug Number (T2): 3
09.91 - 12.94	ABM		246-086-001-007C	HLWP	Plug Number (T2): 3b; T26: X11-246-003-014

**1.6 E (74 kW | 1.6 Litre)**

08.93 - 12.94	ADA	R - 000 001→	246-086-001-002C	HLWP	Plug Number (T2): 3
06.93 - 12.94	ADA		246-086-001-007C	HLWP	Plug Number (T2): 3b; T26: X11-246-003-014



					
Date	Engine Code	Chassis No.	Article No.	Product	Information

## AUDI

## 80 (8C, B4)

## 1.9 TD (55 kW | 1.9 Litre)

08.93 - 12.94	AAZ	R - 000 001→	246-086-001-002C	HLWP	Plug Number (T2): 3
09.91 - 12.94	AAZ		246-086-001-007C	HLWP	Plug Number (T2): 3b; T26: X11-246-003-014

## 1.9 TDI (66 kW | 1.9 Litre)

08.93 - 12.94	1Z	R - 000 001→	246-086-001-002C	HLWP	Plug Number (T2): 3
09.91 - 12.94	1Z		246-086-001-007C	HLWP	Plug Number (T2): 3b; T26: X11-246-003-014

## 2.0 (66 kW | 2.0 Litre)

08.93 - 12.94	ABT	R - 000 001→	246-086-001-002C	HLWP	Plug Number (T2): 3
09.91 - 12.94	ABT		246-086-001-007C	HLWP	Plug Number (T2): 3b; T26: X11-246-003-014

## 2.0 E (85 kW | 2.0 Litre)

08.93 - 12.94	ABK	R - 000 001→	246-086-001-002C	HLWP	Plug Number (T2): 3
09.91 - 12.94	ABK		246-086-001-007C	HLWP	Plug Number (T2): 3b; T26: X11-246-003-014

## 2.0 E 16V (103 kW | 2.0 Litre)

08.92 - 12.94	ACE		246-086-001-007C	HLWP	Plug Number (T2): 3b; T26: X11-246-003-014
---------------	-----	--	------------------	------	--------------------------------------------

## 2.0 E 16V quattro (103 kW | 2.0 Litre)

08.94 - 12.94	ACE	S - 000 001→	246-086-001-002C	HLWP	Plug Number (T2): 3
04.92 - 12.94	ACE		246-086-001-007C	HLWP	Plug Number (T2): 3b; T26: X11-246-003-014

## 2.0 E quattro (85 kW | 2.0 Litre)

08.94 - 12.94	ABK	S - 000 001→	246-086-001-002C	HLWP	Plug Number (T2): 3
09.91 - 12.94	ABK		246-086-001-007C	HLWP	Plug Number (T2): 3b; T26: X11-246-003-014

## 2.3 E (98 kW | 2.3 Litre)

08.93 - 12.94	NG	R - 000 001→	246-086-001-002C	HLWP	Plug Number (T2): 3
09.91 - 12.94	NG		246-086-001-007C	HLWP	Plug Number (T2): 3b; T26: X11-246-003-014

## 2.3 E quattro (98 kW | 2.3 Litre)

08.94 - 12.94	NG	S - 000 001→	246-086-001-002C	HLWP	Plug Number (T2): 3
09.91 - 12.94	NG		246-086-001-007C	HLWP	Plug Number (T2): 3b; T26: X11-246-003-014

## 2.6 (110 kW | 2.6 Litre)

08.93 - 12.94	ABC	R - 000 001→	246-086-001-002C	HLWP	Plug Number (T2): 3
07.92 - 12.94	ABC		246-086-001-007C	HLWP	Plug Number (T2): 3b; T26: X11-246-003-014

## 2.6 quattro (110 kW | 2.6 Litre)

08.94 - 12.94	ABC		246-086-001-002C	HLWP	Plug Number (T2): 3
06.92 - 12.94	ABC		246-086-001-007C	HLWP	Plug Number (T2): 3b; T26: X11-246-003-014

## 2.8 (128 kW | 2.8 Litre)

08.93 - 12.94	AAH	R - 000 001→	246-086-001-002C	HLWP	Plug Number (T2): 3
09.91 - 12.94	AAH		246-086-001-007C	HLWP	Plug Number (T2): 3b; T26: X11-246-003-014

## 2.8 quattro (128 kW | 2.8 Litre)

08.94 - 12.94	AAH		246-086-001-002C	HLWP	Plug Number (T2): 3
09.91 - 12.94	AAH		246-086-001-007C	HLWP	Plug Number (T2): 3b; T26: X11-246-003-014

## S2 quattro (169 kW | 2.2 Litre)

08.94 - 12.94	ABY	S - 000 001→	246-086-001-002C	HLWP	Plug Number (T2): 3
02.93 - 12.94	ABY		246-086-001-007C	HLWP	Plug Number (T2): 3b; T26: X11-246-003-014

## 80 Avant (8C, B4)

## 1.6 E (74 kW | 1.6 Litre)

07.93 - 07.95	ADA		246-082-008-014C	SWP-M-C	Plug Number (T2): 1; T28: Rear (T29)
08.93 - 07.95	ADA	R - 000 001→	246-086-001-002C	HLWP	Plug Number (T2): 3

## 1.9 TD (55 kW | 1.9 Litre)

09.91 - 12.94	AAZ		246-082-008-014C	SWP-M-C	Plug Number (T2): 1; T28: Rear (T29)
---------------	-----	--	------------------	---------	--------------------------------------

## 1.9 TDI (66 kW | 1.9 Litre)

08.92 - 07.95	1Z		246-082-008-014C	SWP-M-C	Plug Number (T2): 1; T28: Rear (T29)
08.93 - 07.95	1Z	R - 000 001→	246-086-001-002C	HLWP	Plug Number (T2): 3

## 2.0 (66 kW | 2.0 Litre)

08.92 - 06.95	ABT		246-082-008-014C	SWP-M-C	Plug Number (T2): 1; T28: Rear (T29)
08.93 - 06.95	ABT	R - 000 001→	246-086-001-002C	HLWP	Plug Number (T2): 3

## 2.0 E (85 kW | 2.0 Litre)

08.92 - 07.95	ABK		246-082-008-014C	SWP-M-C	Plug Number (T2): 1; T28: Rear (T29)
08.93 - 07.95	ABK	R - 000 001→	246-086-001-002C	HLWP	Plug Number (T2): 3

## 2.0 E 16V (103 kW | 2.0 Litre)

02.93 - 07.95	ACE		246-082-008-014C	SWP-M-C	Plug Number (T2): 1; T28: Rear (T29)
08.93 - 07.95	ACE	R - 000 001→	246-086-001-002C	HLWP	Plug Number (T2): 3

## 2.0 E 16V quattro (103 kW | 2.0 Litre)

07.93 - 06.95	ACE		246-082-008-014C	SWP-M-C	Plug Number (T2): 1; T28: Rear (T29)
08.94 - 06.95	ACE	S - 000 001→	246-086-001-002C	HLWP	Plug Number (T2): 3





Date	Engine Code	Chassis No.	Article No.	Product	Information

**AUDI****80 Avant (8C, B4)****2.3 E (98 kW | 2.3 Litre)**

08.92 - 06.95	NG		246-082-008-014C	SWP-M-C	Plug Number (T2): 1; T28: Rear (T29)
08.93 - 06.95	NG	R - 000 001→	246-086-001-002C	HLWP	Plug Number (T2): 3

**2.3 E quattro (98 kW | 2.3 Litre)**

08.92 - 11.94	NG		246-082-008-014C	SWP-M-C	Plug Number (T2): 1; T28: Rear (T29)
08.94 - 11.94	NG	S - 000 001→	246-086-001-002C	HLWP	Plug Number (T2): 3

**2.6 (110 kW | 2.6 Litre)**

08.92 - 07.95	ABC		246-082-008-014C	SWP-M-C	Plug Number (T2): 1; T28: Rear (T29)
08.93 - 07.95	ABC	R - 000 001→	246-086-001-002C	HLWP	Plug Number (T2): 3

**2.6 quattro (110 kW | 2.6 Litre)**

08.92 - 06.95	ABC		246-082-008-014C	SWP-M-C	Plug Number (T2): 1; T28: Rear (T29)
08.94 - 06.95	ABC		246-086-001-002C	HLWP	Plug Number (T2): 3

**2.8 (128 kW | 2.8 Litre)**

08.92 - 07.95	AAH		246-082-008-014C	SWP-M-C	Plug Number (T2): 1; T28: Rear (T29)
08.93 - 07.95	AAH	R - 000 001→	246-086-001-002C	HLWP	Plug Number (T2): 3

**2.8 quattro (128 kW | 2.8 Litre)**

08.92 - 06.95	AAH		246-082-008-014C	SWP-M-C	Plug Number (T2): 1; T28: Rear (T29)
08.94 - 06.95	AAH		246-086-001-002C	HLWP	Plug Number (T2): 3

**RS2 quattro (P1) (232 kW | 2.2 Litre)**

03.94 - 05.95	ADU		246-082-008-014C	SWP-M-C	Plug Number (T2): 1; T28: Rear (T29)
03.94 - 05.95	ADU		246-086-001-002C	HLWP	Plug Number (T2): 3

**S2 quattro (169 kW | 2.2 Litre)**

02.93 - 06.95	ABY		246-082-008-014C	SWP-M-C	Plug Number (T2): 1; T28: Rear (T29)
08.94 - 06.95	ABY	S - 000 001→	246-086-001-002C	HLWP	Plug Number (T2): 3

**90 (81, 85, B2)****1.6 TD (51 kW | 1.6 Litre)**

10.85 - 07.86	CY		246-082-008-014C	SWP-M-C	Plug Number (T2): 1
---------------	----	--	------------------	---------	---------------------

**2.0 (83 kW | 2.0 Litre)**

03.86 - 03.87	SK		246-086-001-007C	HLWP	Plug Number (T2): 3b; T26: X11-246-003-014
---------------	----	--	------------------	------	--------------------------------------------

**2.0 (85 kW | 2.0 Litre)**

10.84 - 07.86	JS, HP		246-082-008-014C	SWP-M-C	Plug Number (T2): 1
10.84 - 03.87	JS, HP		246-086-001-007C	HLWP	Plug Number (T2): 3b; T26: X11-246-003-014

**2.2 (100 kW | 2.2 Litre)**

10.84 - 07.86	KV, HY		246-082-008-014C	SWP-M-C	Plug Number (T2): 1
10.84 - 03.87	KV, HY		246-086-001-007C	HLWP	Plug Number (T2): 3b; T26: X11-246-003-014

**2.2 (85 kW | 2.2 Litre)**

01.85 - 07.86	KX		246-082-008-014C	SWP-M-C	Plug Number (T2): 1
01.85 - 03.87	KX		246-086-001-007C	HLWP	Plug Number (T2): 3b; T26: X11-246-003-014

**2.2 E quattro (100 kW | 2.2 Litre)**

11.84 - 03.87	KV		246-082-008-014C	SWP-M-C	Plug Number (T2): 1
---------------	----	--	------------------	---------	---------------------

**2.2 E quattro (88 kW | 2.2 Litre)**

08.85 - 08.86	JT		246-082-008-014C	SWP-M-C	Plug Number (T2): 1
---------------	----	--	------------------	---------	---------------------

**90 (89, 89Q, 8A, B3)****1.6 TD (59 kW | 1.6 Litre)**

04.88 - 09.91	RA, SB		246-082-008-014C	SWP-M-C	Plug Number (T2): 1
04.87 - 09.91	RA, SB		246-086-001-007C	HLWP	Plug Number (T2): 3b; T26: X11-246-003-014

**2.0 (85 kW | 2.0 Litre)**

07.88 - 07.89	PS		246-082-008-014C	SWP-M-C	Plug Number (T2): 1
07.88 - 09.91	PS		246-086-001-007C	HLWP	Plug Number (T2): 3b; T26: X11-246-003-014

**2.0 20 V (118 kW | 2.0 Litre)**

08.89 - 07.91	NM		246-082-008-014C	SWP-M-C	Plug Number (T2): 1
08.89 - 07.91	NM		246-086-001-007C	HLWP	Plug Number (T2): 3b; T26: X11-246-003-014

**2.0 20 V quattro (118 kW | 2.0 Litre)**

08.88 - 09.91	NM		246-082-008-014C	SWP-M-C	Plug Number (T2): 1
08.88 - 09.91	NM		246-086-001-007C	HLWP	Plug Number (T2): 3b; T26: X11-246-003-014

**2.2 E (100 kW | 2.2 Litre)**

04.87 - 07.91	KV		246-082-008-014C	SWP-M-C	Plug Number (T2): 1
04.87 - 07.91	KV		246-086-001-007C	HLWP	Plug Number (T2): 3b; T26: X11-246-003-014

**2.2 E quattro (100 kW | 2.2 Litre)**

04.87 - 09.91	KV		246-082-008-014C	SWP-M-C	Plug Number (T2): 1
04.87 - 09.91	KV		246-086-001-007C	HLWP	Plug Number (T2): 3b; T26: X11-246-003-014



					
Date	Engine Code	Chassis No.	Article No.	Product	Information

**AUDI****90 (89, 89Q, 8A, B3)****2.3 E (100 kW | 2.3 Litre)**

04.87 - 07.91	NG		246-082-008-014C	SWP-M-C	Plug Number (T2): 1
04.87 - 07.91	NG		246-086-001-007C	HLWP	Plug Number (T2): 3b; T26: X11-246-003-014

**2.3 E (98 kW | 2.3 Litre)**

04.87 - 09.91	NG		246-086-001-007C	HLWP	Plug Number (T2): 3b; T26: X11-246-003-014
---------------	----	--	------------------	------	--------------------------------------------

**2.3 E 20V (123 kW | 2.3 Litre)**

04.90 - 07.91	7A		246-082-008-014C	SWP-M-C	Plug Number (T2): 1
04.90 - 07.91	7A		246-086-001-007C	HLWP	Plug Number (T2): 3b; T26: X11-246-003-014

**2.3 E 20V (125 kW | 2.3 Litre)**

08.88 - 07.89	7A		246-082-008-014C	SWP-M-C	Plug Number (T2): 1
08.88 - 07.91	7A		246-086-001-007C	HLWP	Plug Number (T2): 3b; T26: X11-246-003-014

**2.3 E 20V quattro (123 kW | 2.3 Litre)**

04.90 - 09.91	7A		246-086-001-007C	HLWP	Plug Number (T2): 3b; T26: X11-246-003-014
---------------	----	--	------------------	------	--------------------------------------------

**2.3 E 20V quattro (125 kW | 2.3 Litre)**

06.88 - 09.91	7A		246-082-008-014C	SWP-M-C	Plug Number (T2): 1
06.88 - 09.91	7A		246-086-001-007C	HLWP	Plug Number (T2): 3b; T26: X11-246-003-014

**2.3 E quattro (100 kW | 2.3 Litre)**

04.87 - 07.91	NG		246-082-008-014C	SWP-M-C	Plug Number (T2): 1
04.87 - 07.91	NG		246-086-001-007C	HLWP	Plug Number (T2): 3b; T26: X11-246-003-014

**2.3 E quattro (98 kW | 2.3 Litre)**

04.87 - 09.91	NG		246-086-001-007C	HLWP	Plug Number (T2): 3b; T26: X11-246-003-014
---------------	----	--	------------------	------	--------------------------------------------

**100 (C1)****1.6 (63 kW | 1.6 Litre)**

01.75 - 05.76	YM		246-082-008-014C	SWP-M-C	Plug Number (T2): 1
---------------	----	--	------------------	---------	---------------------

**1.8 (59 kW | 1.8 Litre)**

11.68 - 08.71	ZV		246-082-008-014C	SWP-M-C	Plug Number (T2): 1
---------------	----	--	------------------	---------	---------------------

**1.8 (63 kW | 1.8 Litre)**

09.71 - 07.74	ZU		246-082-008-014C	SWP-M-C	Plug Number (T2): 1
---------------	----	--	------------------	---------	---------------------

**1.8 (66 kW | 1.8 Litre)**

11.68 - 07.71	ZX		246-082-008-014C	SWP-M-C	Plug Number (T2): 1
---------------	----	--	------------------	---------	---------------------

**1.8 (74 kW | 1.8 Litre)**

10.70 - 05.76	ZZ		246-082-008-014C	SWP-M-C	Plug Number (T2): 1
---------------	----	--	------------------	---------	---------------------

**1.9 (82 kW | 1.9 Litre)**

09.71 - 05.76	ZJ		246-082-008-014C	SWP-M-C	Plug Number (T2): 1
---------------	----	--	------------------	---------	---------------------

**100 (43, C2)****1.6 (63 kW | 1.6 Litre)**

08.76 - 07.81	YV		246-082-008-014C	SWP-M-C	Plug Number (T2): 1
08.76 - 07.82	YV		246-086-001-007C	HLWP	Plug Number (T2): 3b; T26: X11-246-003-014

**1.9 (74 kW | 1.9 Litre)**

08.80 - 07.82	WH		246-082-008-014C	SWP-M-C	Plug Number (T2): 1
08.80 - 07.82	WH		246-086-001-007C	HLWP	Plug Number (T2): 3b; T26: X11-246-003-014

**2.0 (85 kW | 2.0 Litre)**

06.76 - 07.78	WA		246-082-008-014C	SWP-M-C	Plug Number (T2): 1
06.76 - 08.78	WA		246-086-001-007C	HLWP	Plug Number (T2): 3b; T26: X11-246-003-014

**2.0 D (51 kW | 2.0 Litre)**

08.78 - 07.82	CN		246-082-008-014C	SWP-M-C	Plug Number (T2): 1
08.78 - 07.82	CN		246-086-001-007C	HLWP	Plug Number (T2): 3b; T26: X11-246-003-014

**2.1 (100 kW | 2.1 Litre)**

03.77 - 07.82	WC, WG		246-082-008-014C	SWP-M-C	Plug Number (T2): 1
03.77 - 07.82	WC, WG		246-086-001-007C	HLWP	Plug Number (T2): 3b; T26: X11-246-003-014

**2.1 (85 kW | 2.1 Litre)**

10.77 - 07.82	WB, WE		246-082-008-014C	SWP-M-C	Plug Number (T2): 1
10.77 - 07.82	WB, WE		246-086-001-007C	HLWP	Plug Number (T2): 3b; T26: X11-246-003-014

**100 Avant (43, C2)****1.6 (63 kW | 1.6 Litre)**

07.77 - 07.82	YV		246-082-008-014C	SWP-M-C	Plug Number (T2): 1; T28: Rear (T29)
07.77 - 02.83	YV		246-086-001-007C	HLWP	Plug Number (T2): 3b; T26: X11-246-003-014

**1.9 (74 kW | 1.9 Litre)**

08.80 - 07.82	WH		246-082-008-014C	SWP-M-C	Plug Number (T2): 1; T28: Rear (T29)
08.80 - 07.82	WH		246-086-001-007C	HLWP	Plug Number (T2): 3b; T26: X11-246-003-014



					
Date	Engine Code	Chassis No.	Article No.	Product	Information

## AUDI

### 100 Avant (43, C2)

#### 2.0 (85 kW | 2.0 Litre)

09.77 - 07.78	WA		246-082-008-014C	SWP-M-C	Plug Number (T2): 1; T28: Rear (T29)
08.77 - 07.80	WA		246-086-001-007C	HLWP	Plug Number (T2): 3b; T26: X11-246-003-014

#### 2.0 D (51 kW | 2.0 Litre)

08.81 - 07.82	CN		246-075-021-006C	SWP-M-G	Plug Number (T2): 1; Vehicle Equipment (T31): with power steering (T33)
08.78 - 07.82	CN		246-082-008-014C	SWP-M-C	Plug Number (T2): 1; T28: Rear (T29)
08.78 - 02.83	CN		246-086-001-007C	HLWP	Plug Number (T2): 3b; T26: X11-246-003-014

#### 2.1 (100 kW | 2.1 Litre)

09.77 - 07.82	WC, WG		246-082-008-014C	SWP-M-C	Plug Number (T2): 1; T28: Rear (T29)
07.77 - 02.83	WC, WG		246-086-001-007C	HLWP	Plug Number (T2): 3b; T26: X11-246-003-014

#### 2.1 (85 kW | 2.1 Litre)

09.77 - 02.83	WB, WE		246-082-008-014C	SWP-M-C	Plug Number (T2): 1; T28: Rear (T29)
07.77 - 02.83	WB, WE		246-086-001-007C	HLWP	Plug Number (T2): 3b; T26: X11-246-003-014

### 100 (44, 44Q, C3)

#### 1.8 (55 kW | 1.8 Litre)

08.82 - 12.87	DR, RS		246-075-021-006C	SWP-M-G	Plug Number (T2): 1; Vehicle Equipment (T31): with power steering (T33)
08.82 - 12.87	DR, RS		246-082-008-014C	SWP-M-C	Plug Number (T2): 1
08.82 - 12.87	DR, RS		246-086-001-007C	HLWP	Plug Number (T2): 3b; T26: X11-246-003-014

#### 1.8 (65 kW | 1.8 Litre)

02.86 - 07.88	SH		246-075-021-006C	SWP-M-G	Plug Number (T2): 1; Vehicle Equipment (T31): with power steering (T33)
02.86 - 07.88	SH		246-082-008-014C	SWP-M-C	Plug Number (T2): 1
02.86 - 07.88	SH		246-086-001-007C	HLWP	Plug Number (T2): 3b; T26: X11-246-003-014

#### 1.8 (66 kW | 1.8 Litre)

08.83 - 07.89	DS, NP, JW		246-075-021-006C	SWP-M-G	Plug Number (T2): 1; Vehicle Equipment (T31): with power steering (T33)
08.83 - 07.89	DS, NP, JW		246-082-008-014C	SWP-M-C	Plug Number (T2): 1
08.83 - 07.89	DS, NP, JW		246-086-001-007C	HLWP	Plug Number (T2): 3b; T26: X11-246-003-014

#### 1.8 CAT (66 kW | 1.8 Litre)

04.85 - 07.90	PH, 4B		246-075-021-006C	SWP-M-G	Plug Number (T2): 1; Vehicle Equipment (T31): with power steering (T33)
04.85 - 11.90	PH, 4B		246-082-008-014C	SWP-M-C	Plug Number (T2): 1
03.85 - 11.90	PH, 4B		246-086-001-007C	HLWP	Plug Number (T2): 3b; T26: X11-246-003-014

#### 1.8 quattro (65 kW | 1.8 Litre)

08.86 - 07.88	SH		246-075-021-006C	SWP-M-G	Plug Number (T2): 1; Vehicle Equipment (T31): with power steering (T33)
08.86 - 07.88	SH		246-082-008-014C	SWP-M-C	Plug Number (T2): 1
08.86 - 07.90	SH		246-086-001-007C	HLWP	Plug Number (T2): 3b; T26: X11-246-003-014

#### 1.8 quattro (66 kW | 1.8 Litre)

10.84 - 07.88	NP, JW		246-075-021-006C	SWP-M-G	Plug Number (T2): 1; Vehicle Equipment (T31): with power steering (T33)
10.84 - 07.88	NP, JW		246-082-008-014C	SWP-M-C	Plug Number (T2): 1
10.84 - 07.88	NP, JW		246-086-001-007C	HLWP	Plug Number (T2): 3b; T26: X11-246-003-014

#### 1.8 quattro CAT (66 kW | 1.8 Litre)

01.88 - 11.90	PH, 4B		246-075-021-006C	SWP-M-G	Plug Number (T2): 1; Vehicle Equipment (T31): with power steering (T33)
01.88 - 11.90	PH, 4B		246-082-008-014C	SWP-M-C	Plug Number (T2): 1
08.85 - 11.90	PH, 4B		246-086-001-007C	HLWP	Plug Number (T2): 3b; T26: X11-246-003-014

#### 1.9 (74 kW | 1.9 Litre)

08.82 - 07.84	WH		246-075-021-006C	SWP-M-G	Plug Number (T2): 1; Vehicle Equipment (T31): with power steering (T33)
08.82 - 07.84	WH		246-082-008-014C	SWP-M-C	Plug Number (T2): 1
08.82 - 07.84	WH		246-086-001-007C	HLWP	Plug Number (T2): 3b; T26: X11-246-003-014

#### 2.0 (83 kW | 2.0 Litre)

08.86 - 11.87	SL		246-075-021-006C	SWP-M-G	Plug Number (T2): 1; Vehicle Equipment (T31): with power steering (T33)
08.86 - 11.87	SL		246-082-008-014C	SWP-M-C	Plug Number (T2): 1
08.86 - 11.87	SL		246-086-001-007C	HLWP	Plug Number (T2): 3b; T26: X11-246-003-014



			<b>VDO</b>		
Date	Engine Code	Chassis No.	Article No.	Product	Information

**AUDI****100 (44, 44Q, C3)****2.0 (85 kW | 2.0 Litre)**

08.84 - 12.87	KP		246-075-021-006C	SWP-M-G	Plug Number (T2): 1; Vehicle Equipment (T31): with power steering (T33)
08.84 - 12.87	KP		246-082-008-014C	SWP-M-C	Plug Number (T2): 1
08.84 - 12.87	KP		246-086-001-007C	HLWP	Plug Number (T2): 3b; T26: X11-246-003-014

**2.0 CAT (85 kW | 2.0 Litre)**

01.88 - 07.89	RT		246-075-021-006C	SWP-M-G	Plug Number (T2): 1; Vehicle Equipment (T31): with power steering (T33)
01.88 - 07.89	RT		246-082-008-014C	SWP-M-C	Plug Number (T2): 1
01.88 - 11.90	RT		246-086-001-007C	HLWP	Plug Number (T2): 3b; T26: X11-246-003-014

**2.0 D (51 kW | 2.0 Litre)**

08.82 - 01.88	CN		246-075-021-006C	SWP-M-G	Plug Number (T2): 1; Vehicle Equipment (T31): with power steering (T33)
08.82 - 07.88	CN		246-082-008-014C	SWP-M-C	Plug Number (T2): 1
08.82 - 07.88	CN		246-086-001-007C	HLWP	Plug Number (T2): 3b; T26: X11-246-003-014

**2.0 D Turbo (64 kW | 2.0 Litre)**

08.82 - 01.88	DE		246-075-021-006C	SWP-M-G	Plug Number (T2): 1; Vehicle Equipment (T31): with power steering (T33)
08.82 - 01.88	X 14 XE		246-082-008-014C	SWP-M-C	Plug Number (T2): 1
08.82 - 02.88	DE		246-086-001-007C	HLWP	Plug Number (T2): 3b; T26: X11-246-003-014

**2.0 D Turbo (74 kW | 2.0 Litre)**

03.88 - 11.90	NC		246-075-021-006C	SWP-M-G	Plug Number (T2): 1; Vehicle Equipment (T31): with power steering (T33)
03.88 - 11.90	17 D (4EE1), X 17 D (4EE1)		246-082-008-014C	SWP-M-C	Plug Number (T2): 1
03.88 - 11.90	NC		246-086-001-007C	HLWP	Plug Number (T2): 3b; T26: X11-246-003-014

**2.1 (100 kW | 2.1 Litre)**

08.82 - 07.84	WC		246-075-021-006C	SWP-M-G	Plug Number (T2): 1; Vehicle Equipment (T31): with power steering (T33)
08.82 - 07.84	WC		246-082-008-014C	SWP-M-C	Plug Number (T2): 1
08.82 - 07.84	WC		246-086-001-007C	HLWP	Plug Number (T2): 3b; T26: X11-246-003-014

**2.2 (101 kW | 2.2 Litre)**

08.84 - 12.88	KU		246-075-021-006C	SWP-M-G	Plug Number (T2): 1; Vehicle Equipment (T31): with power steering (T33)
08.84 - 12.88	KU		246-082-008-014C	SWP-M-C	Plug Number (T2): 1
08.84 - 12.88	KU		246-086-001-007C	HLWP	Plug Number (T2): 3b; T26: X11-246-003-014

**2.2 (79 kW | 2.2 Litre)**

08.82 - 07.84	WU		246-075-021-006C	SWP-M-G	Plug Number (T2): 1
08.82 - 07.84	WU		246-082-008-014C	SWP-M-C	Plug Number (T2): 1
08.82 - 07.84	WU		246-086-001-007C	HLWP	Plug Number (T2): 3b

**2.2 (85 kW | 2.2 Litre)**

10.84 - 09.86	KZ		246-075-021-006C	SWP-M-G	Plug Number (T2): 1; Vehicle Equipment (T31): with power steering (T33)
10.84 - 09.86	KZ		246-082-008-014C	SWP-M-C	Plug Number (T2): 1
10.84 - 09.86	KZ		246-086-001-007C	HLWP	Plug Number (T2): 3b; T26: X11-246-003-014

**2.2 (96 kW | 2.2 Litre)**

08.82 - 07.84	KF		246-082-008-014C	SWP-M-C	Plug Number (T2): 1
08.82 - 07.84	KF		246-086-001-007C	HLWP	Plug Number (T2): 3b

**2.2 CAT (101 kW | 2.2 Litre)**

08.89 - 07.90	KU, HX		246-075-021-006C	SWP-M-G	Plug Number (T2): 1; Vehicle Equipment (T31): with power steering (T33)
08.89 - 07.90	KU, HX		246-082-008-014C	SWP-M-C	Plug Number (T2): 1
06.89 - 11.90	KU, HX		246-086-001-007C	HLWP	Plug Number (T2): 3b; T26: X11-246-003-014

**2.2 E quattro (88 kW | 2.2 Litre)**

08.85 - 07.86	PX		246-086-001-007C	HLWP	Plug Number (T2): 3b; T26: X11-246-003-014
---------------	----	--	------------------	------	--------------------------------------------

**2.2 E Turbo quattro (121 kW | 2.2 Litre)**

08.86 - 11.90	MC		246-075-021-006C	SWP-M-G	Plug Number (T2): 1; Vehicle Equipment (T31): with power steering (T33)
08.86 - 11.90	MC		246-082-008-014C	SWP-M-C	Plug Number (T2): 1
08.86 - 11.90	MC		246-086-001-007C	HLWP	Plug Number (T2): 3b; T26: X11-246-003-014

**2.2 quattro (101 kW | 2.2 Litre)**

10.84 - 12.88	KU		246-075-021-006C	SWP-M-G	Plug Number (T2): 1; Vehicle Equipment (T31): with power steering (T33)
10.84 - 12.88	KU		246-082-008-014C	SWP-M-C	Plug Number (T2): 1



			<b>VDO</b>		
Date	Engine Code	Chassis No.	Article No.	Product	Information

**AUDI****100 (44, 44Q, C3)****2.2 quattro (101 kW | 2.2 Litre)**

08.84 - 12.88	KU		246-086-001-007C	HLWP	Plug Number (T2): 3b; T26: X11-246-003-014
---------------	----	--	------------------	------	--------------------------------------------

**2.2 quattro CAT (101 kW | 2.2 Litre)**

06.89 - 11.90	KU, HX		246-086-001-007C	HLWP	Plug Number (T2): 3b; T26: X11-246-003-014
---------------	--------	--	------------------	------	--------------------------------------------

**2.2 Turbo (121 kW | 2.2 Litre)**

08.86 - 11.90	MC		246-075-021-006C	SWP-M-G	Plug Number (T2): 1; Vehicle Equipment (T31): with power steering (T33)
---------------	----	--	------------------	---------	-------------------------------------------------------------------------

08.86 - 11.90	MC		246-082-008-014C	SWP-M-C	Plug Number (T2): 1
---------------	----	--	------------------	---------	---------------------

08.86 - 11.90	MC		246-086-001-007C	HLWP	Plug Number (T2): 3b; T26: X11-246-003-014
---------------	----	--	------------------	------	--------------------------------------------

**2.3 E (100 kW | 2.3 Litre)**

10.86 - 07.90	NF		246-075-021-006C	SWP-M-G	Plug Number (T2): 1; Vehicle Equipment (T31): with power steering (T33)
---------------	----	--	------------------	---------	-------------------------------------------------------------------------

10.86 - 07.90	NF		246-082-008-014C	SWP-M-C	Plug Number (T2): 1
---------------	----	--	------------------	---------	---------------------

10.86 - 11.90	NF		246-086-001-007C	HLWP	Plug Number (T2): 3b; T26: X11-246-003-014
---------------	----	--	------------------	------	--------------------------------------------

**2.3 E (98 kW | 2.3 Litre)**

01.90 - 11.90	AAR		246-086-001-007C	HLWP	Plug Number (T2): 3b; T26: X11-246-003-014
---------------	-----	--	------------------	------	--------------------------------------------

**2.3 E quattro (100 kW | 2.3 Litre)**

08.86 - 11.90	NF		246-075-021-006C	SWP-M-G	Plug Number (T2): 1; Vehicle Equipment (T31): with power steering (T33)
---------------	----	--	------------------	---------	-------------------------------------------------------------------------

08.86 - 11.90	NF		246-082-008-014C	SWP-M-C	Plug Number (T2): 1
---------------	----	--	------------------	---------	---------------------

08.86 - 11.90	NF		246-086-001-007C	HLWP	Plug Number (T2): 3b; T26: X11-246-003-014
---------------	----	--	------------------	------	--------------------------------------------

**2.3 quattro (98 kW | 2.3 Litre)**

01.90 - 11.90	AAR		246-086-001-007C	HLWP	Plug Number (T2): 3b; T26: X11-246-003-014
---------------	-----	--	------------------	------	--------------------------------------------

**2.4 D (60 kW | 2.4 Litre)**

08.90 - 07.91	3D		246-075-021-006C	SWP-M-G	Plug Number (T2): 1; Vehicle Equipment (T31): with power steering (T33)
---------------	----	--	------------------	---------	-------------------------------------------------------------------------

08.90 - 12.90	3D		246-082-008-014C	SWP-M-C	Plug Number (T2): 1
---------------	----	--	------------------	---------	---------------------

08.89 - 07.91	3D		246-086-001-007C	HLWP	Plug Number (T2): 3b; T26: X11-246-003-014
---------------	----	--	------------------	------	--------------------------------------------

**2.5 TDI (88 kW | 2.5 Litre)**

01.90 - 11.90	1T		246-075-021-006C	SWP-M-G	Plug Number (T2): 1; Vehicle Equipment (T31): with power steering (T33)
---------------	----	--	------------------	---------	-------------------------------------------------------------------------

01.90 - 11.90	X 14 XE		246-082-008-014C	SWP-M-C	Plug Number (T2): 1
---------------	---------	--	------------------	---------	---------------------

01.90 - 11.90	1T		246-086-001-007C	HLWP	Plug Number (T2): 3b; T26: X11-246-003-014
---------------	----	--	------------------	------	--------------------------------------------

**100 Avant (44, 44Q, C3)****1.8 (55 kW | 1.8 Litre)**

08.82 - 12.87	DR, RS		246-075-021-006C	SWP-M-G	Plug Number (T2): 1; Vehicle Equipment (T31): with power steering (T33)
---------------	--------	--	------------------	---------	-------------------------------------------------------------------------

08.82 - 12.87	DR, RS		246-082-008-014C	SWP-M-C	Plug Number (T2): 1; T28: Rear (T29)
---------------	--------	--	------------------	---------	--------------------------------------

08.82 - 12.87	DR, RS		246-086-001-007C	HLWP	Plug Number (T2): 3b; T26: X11-246-003-014
---------------	--------	--	------------------	------	--------------------------------------------

**1.8 (65 kW | 1.8 Litre)**

02.86 - 07.90	SH		246-075-021-006C	SWP-M-G	Plug Number (T2): 1; Vehicle Equipment (T31): with power steering (T33)
---------------	----	--	------------------	---------	-------------------------------------------------------------------------

02.86 - 07.90	SH		246-082-008-014C	SWP-M-C	Plug Number (T2): 1; T28: Rear (T29)
---------------	----	--	------------------	---------	--------------------------------------

02.86 - 07.90	SH		246-086-001-007C	HLWP	Plug Number (T2): 3b; T26: X11-246-003-014
---------------	----	--	------------------	------	--------------------------------------------

**1.8 (66 kW | 1.8 Litre)**

08.84 - 07.89	NP, JW, DS		246-075-021-006C	SWP-M-G	Plug Number (T2): 1; Vehicle Equipment (T31): with power steering (T33)
---------------	------------	--	------------------	---------	-------------------------------------------------------------------------

08.84 - 07.89	NP, JW, DS		246-082-008-014C	SWP-M-C	Plug Number (T2): 1; T28: Rear (T29)
---------------	------------	--	------------------	---------	--------------------------------------

08.83 - 07.89	NP, JW, DS		246-086-001-007C	HLWP	Plug Number (T2): 3b; T26: X11-246-003-014
---------------	------------	--	------------------	------	--------------------------------------------

**1.8 CAT (66 kW | 1.8 Litre)**

08.89 - 07.90	PH, 4B		246-075-021-006C	SWP-M-G	Plug Number (T2): 1; Vehicle Equipment (T31): with power steering (T33)
---------------	--------	--	------------------	---------	-------------------------------------------------------------------------

08.89 - 07.90	PH, 4B		246-082-008-014C	SWP-M-C	Plug Number (T2): 1; T28: Rear (T29)
---------------	--------	--	------------------	---------	--------------------------------------

03.85 - 11.90	PH, 4B		246-086-001-007C	HLWP	Plug Number (T2): 3b; T26: X11-246-003-014
---------------	--------	--	------------------	------	--------------------------------------------

**1.8 quattro (65 kW | 1.8 Litre)**

08.86 - 07.90	SH		246-086-001-007C	HLWP	Plug Number (T2): 3b; T26: X11-246-003-014
---------------	----	--	------------------	------	--------------------------------------------

**1.8 quattro (66 kW | 1.8 Litre)**

10.84 - 12.87	NP, JW		246-075-021-006C	SWP-M-G	Plug Number (T2): 1; Vehicle Equipment (T31): with power steering (T33)
---------------	--------	--	------------------	---------	-------------------------------------------------------------------------

10.84 - 12.87	NP, JW		246-082-008-014C	SWP-M-C	Plug Number (T2): 1; T28: Rear (T29)
---------------	--------	--	------------------	---------	--------------------------------------

10.84 - 07.88	NP, JW		246-086-001-007C	HLWP	Plug Number (T2): 3b; T26: X11-246-003-014
---------------	--------	--	------------------	------	--------------------------------------------



			<b>VDO</b>		
Date	Engine Code	Chassis No.	Article No.	Product	Information

**AUDI****100 Avant (44, 44Q, C3)**

<b>1.8 quattro CAT (66 kW   1.8 Litre)</b>					
08.85 - 10.90	PH, 4B		246-086-001-007C	HLWP	Plug Number (T2): 3b; T26: X11-246-003-014
<b>1.9 (74 kW   1.9 Litre)</b>					
02.83 - 07.84	WH		246-075-021-006C	SWP-M-G	Plug Number (T2): 1; Vehicle Equipment (T31): with power steering (T33)
02.83 - 07.84	WH		246-082-008-014C	SWP-M-C	Plug Number (T2): 1; T28: Rear (T29)
02.83 - 07.84	WH		246-086-001-007C	HLWP	Plug Number (T2): 3b; T26: X11-246-003-014
<b>2.0 (83 kW   2.0 Litre)</b>					
09.86 - 11.87	SL		246-075-021-006C	SWP-M-G	Plug Number (T2): 1; Vehicle Equipment (T31): with power steering (T33)
09.86 - 11.87	SL		246-082-008-014C	SWP-M-C	Plug Number (T2): 1; T28: Rear (T29)
09.86 - 11.87	SL		246-086-001-007C	HLWP	Plug Number (T2): 3b; T26: X11-246-003-014
<b>2.0 D (51 kW   2.0 Litre)</b>					
03.83 - 07.89	CN		246-075-021-006C	SWP-M-G	Plug Number (T2): 1; Vehicle Equipment (T31): with power steering (T33)
03.83 - 07.89	CN		246-082-008-014C	SWP-M-C	Plug Number (T2): 1; T28: Rear (T29)
03.83 - 11.90	CN		246-086-001-007C	HLWP	Plug Number (T2): 3b; T26: X11-246-003-014
<b>2.0 E (85 kW   2.0 Litre)</b>					
01.85 - 12.87	KP		246-075-021-006C	SWP-M-G	Plug Number (T2): 1; Vehicle Equipment (T31): with power steering (T33)
01.85 - 12.87	KP		246-082-008-014C	SWP-M-C	Plug Number (T2): 1; T28: Rear (T29)
01.85 - 12.87	KP		246-086-001-007C	HLWP	Plug Number (T2): 3b; T26: X11-246-003-014
<b>2.0 E CAT (85 kW   2.0 Litre)</b>					
01.88 - 07.90	RT		246-075-021-006C	SWP-M-G	Plug Number (T2): 1; Vehicle Equipment (T31): with power steering (T33)
01.88 - 07.90	RT		246-082-008-014C	SWP-M-C	Plug Number (T2): 1; T28: Rear (T29)
01.88 - 11.90	RT		246-086-001-007C	HLWP	Plug Number (T2): 3b; T26: X11-246-003-014
<b>2.0 TD (64 kW   2.0 Litre)</b>					
03.83 - 10.87	DE		246-075-021-006C	SWP-M-G	Plug Number (T2): 1; Vehicle Equipment (T31): with power steering (T33)
03.83 - 10.87	DE		246-082-008-014C	SWP-M-C	Plug Number (T2): 1; T28: Rear (T29)
03.83 - 10.87	DE		246-086-001-007C	HLWP	Plug Number (T2): 3b; T26: X11-246-003-014
<b>2.0 TD (74 kW   2.0 Litre)</b>					
03.88 - 07.90	NC		246-075-021-006C	SWP-M-G	Plug Number (T2): 1; Vehicle Equipment (T31): with power steering (T33)
03.88 - 07.90	NC		246-082-008-014C	SWP-M-C	Plug Number (T2): 1; T28: Rear (T29)
03.88 - 11.90	NC		246-086-001-007C	HLWP	Plug Number (T2): 3b; T26: X11-246-003-014
<b>2.1 (100 kW   2.1 Litre)</b>					
08.82 - 07.84	WC		246-075-021-006C	SWP-M-G	Plug Number (T2): 1; Vehicle Equipment (T31): with power steering (T33)
08.82 - 07.84	WC		246-082-008-014C	SWP-M-C	Plug Number (T2): 1; T28: Rear (T29)
08.82 - 07.84	WC		246-086-001-007C	HLWP	Plug Number (T2): 3b; T26: X11-246-003-014
<b>2.2 (101 kW   2.2 Litre)</b>					
08.84 - 12.88	KU		246-075-021-006C	SWP-M-G	Plug Number (T2): 1; Vehicle Equipment (T31): with power steering (T33)
08.84 - 12.88	KU		246-082-008-014C	SWP-M-C	Plug Number (T2): 1; T28: Rear (T29)
08.84 - 12.88	KU		246-086-001-007C	HLWP	Plug Number (T2): 3b; T26: X11-246-003-014
<b>2.2 (85 kW   2.2 Litre)</b>					
10.84 - 09.86	KZ		246-075-021-006C	SWP-M-G	Plug Number (T2): 1; Vehicle Equipment (T31): with power steering (T33)
10.84 - 09.86	KZ		246-082-008-014C	SWP-M-C	Plug Number (T2): 1; T28: Rear (T29)
10.84 - 09.86	KZ		246-086-001-007C	HLWP	Plug Number (T2): 3b; T26: X11-246-003-014
<b>2.2 CAT (101 kW   2.2 Litre)</b>					
06.89 - 11.90	KU, HX		246-075-021-006C	SWP-M-G	Plug Number (T2): 1; Vehicle Equipment (T31): with power steering (T33)
08.89 - 07.90	KU, HX		246-082-008-014C	SWP-M-C	Plug Number (T2): 1; T28: Rear (T29)
06.89 - 11.90	KU, HX		246-086-001-007C	HLWP	Plug Number (T2): 3b; T26: X11-246-003-014
<b>2.2 E quattro (88 kW   2.2 Litre)</b>					
08.85 - 07.86	PX		246-086-001-007C	HLWP	Plug Number (T2): 3b; T26: X11-246-003-014
<b>2.2 quattro (101 kW   2.2 Litre)</b>					
10.84 - 12.88	KU		246-075-021-006C	SWP-M-G	Plug Number (T2): 1; Vehicle Equipment (T31): with power steering (T33)
10.84 - 12.88	KU		246-082-008-014C	SWP-M-C	Plug Number (T2): 1; T28: Rear (T29)



					
Date	Engine Code	Chassis No.	Article No.	Product	Information

**AUDI****100 Avant (44, 44Q, C3)****2.2 quattro (101 kW | 2.2 Litre)**

08.84 - 12.88	KU		246-086-001-007C	HLWP	Plug Number (T2): 3b; T26: X11-246-003-014
---------------	----	--	------------------	------	--------------------------------------------

**2.2 quattro CAT (101 kW | 2.2 Litre)**

06.89 - 11.90	KU, HX		246-086-001-007C	HLWP	Plug Number (T2): 3b; T26: X11-246-003-014
---------------	--------	--	------------------	------	--------------------------------------------

**2.2 Turbo (121 kW | 2.2 Litre)**

08.86 - 07.90	MC		246-075-021-006C	SWP-M-G	Plug Number (T2): 1; Vehicle Equipment (T31): with power steering (T33)
---------------	----	--	------------------	---------	-------------------------------------------------------------------------

08.86 - 07.90	MC		246-082-008-014C	SWP-M-C	Plug Number (T2): 1; T28: Rear (T29)
---------------	----	--	------------------	---------	--------------------------------------

08.86 - 11.90	MC		246-086-001-007C	HLWP	Plug Number (T2): 3b; T26: X11-246-003-014
---------------	----	--	------------------	------	--------------------------------------------

**2.2 Turbo quattro (121 kW | 2.2 Litre)**

08.86 - 11.90	MC		246-075-021-006C	SWP-M-G	Plug Number (T2): 1; Vehicle Equipment (T31): with power steering (T33)
---------------	----	--	------------------	---------	-------------------------------------------------------------------------

08.86 - 11.90	MC		246-082-008-014C	SWP-M-C	Plug Number (T2): 1; T28: Rear (T29)
---------------	----	--	------------------	---------	--------------------------------------

08.86 - 11.90	MC		246-086-001-007C	HLWP	Plug Number (T2): 3b; T26: X11-246-003-014
---------------	----	--	------------------	------	--------------------------------------------

**2.3 (100 kW | 2.3 Litre)**

10.86 - 07.90	NF		246-075-021-006C	SWP-M-G	Plug Number (T2): 1; Vehicle Equipment (T31): with power steering (T33)
---------------	----	--	------------------	---------	-------------------------------------------------------------------------

10.86 - 07.90	NF		246-082-008-014C	SWP-M-C	Plug Number (T2): 1; T28: Rear (T29)
---------------	----	--	------------------	---------	--------------------------------------

08.86 - 11.90	NF		246-086-001-007C	HLWP	Plug Number (T2): 3b; T26: X11-246-003-014
---------------	----	--	------------------	------	--------------------------------------------

**2.3 (98 kW | 2.3 Litre)**

03.90 - 11.90	AAR		246-086-001-007C	HLWP	Plug Number (T2): 3b; T26: X11-246-003-014
---------------	-----	--	------------------	------	--------------------------------------------

**2.3 E quattro (100 kW | 2.3 Litre)**

08.86 - 11.90	NF		246-075-021-006C	SWP-M-G	Plug Number (T2): 1; Vehicle Equipment (T31): with power steering (T33)
---------------	----	--	------------------	---------	-------------------------------------------------------------------------

08.86 - 11.90	NF		246-082-008-014C	SWP-M-C	Plug Number (T2): 1; T28: Rear (T29)
---------------	----	--	------------------	---------	--------------------------------------

08.86 - 11.90	NF		246-086-001-007C	HLWP	Plug Number (T2): 3b; T26: X11-246-003-014
---------------	----	--	------------------	------	--------------------------------------------

**2.3 quattro (98 kW | 2.3 Litre)**

01.90 - 11.90	AAR		246-086-001-007C	HLWP	Plug Number (T2): 3b; T26: X11-246-003-014
---------------	-----	--	------------------	------	--------------------------------------------

**2.4 D (60 kW | 2.4 Litre)**

08.90 - 11.90	3D		246-075-021-006C	SWP-M-G	Plug Number (T2): 1; Vehicle Equipment (T31): with power steering (T33)
---------------	----	--	------------------	---------	-------------------------------------------------------------------------

08.90 - 11.90	3D		246-082-008-014C	SWP-M-C	Plug Number (T2): 1; T28: Rear (T29)
---------------	----	--	------------------	---------	--------------------------------------

08.89 - 11.90	3D		246-086-001-007C	HLWP	Plug Number (T2): 3b; T26: X11-246-003-014
---------------	----	--	------------------	------	--------------------------------------------

**2.5 TDI (88 kW | 2.5 Litre)**

01.90 - 07.90	1T		246-075-021-006C	SWP-M-G	Plug Number (T2): 1; Vehicle Equipment (T31): with power steering (T33)
---------------	----	--	------------------	---------	-------------------------------------------------------------------------

01.90 - 07.90	1T		246-082-008-014C	SWP-M-C	Plug Number (T2): 1; T28: Rear (T29)
---------------	----	--	------------------	---------	--------------------------------------

01.90 - 11.90	1T		246-086-001-007C	HLWP	Plug Number (T2): 3b; T26: X11-246-003-014
---------------	----	--	------------------	------	--------------------------------------------

**100 (4A, C4)****2.0 (74 kW | 2.0 Litre)**

12.90 - 06.94	AAE		246-086-001-002C	HLWP	Plug Number (T2): 3
---------------	-----	--	------------------	------	---------------------

12.90 - 06.94	AAE		246-086-001-007C	HLWP	Plug Number (T2): 3b; T26: X11-246-003-014
---------------	-----	--	------------------	------	--------------------------------------------

**2.0 E (85 kW | 2.0 Litre)**

01.91 - 06.94	AAD, ABK		246-086-001-002C	HLWP	Plug Number (T2): 3
---------------	----------	--	------------------	------	---------------------

12.90 - 06.94	AAD, ABK		246-086-001-007C	HLWP	Plug Number (T2): 3b; T26: X11-246-003-014
---------------	----------	--	------------------	------	--------------------------------------------

**2.0 E 16V (103 kW | 2.0 Litre)**

01.92 - 06.94	ACE		246-086-001-002C	HLWP	Plug Number (T2): 3
---------------	-----	--	------------------	------	---------------------

01.92 - 06.94	ACE		246-086-001-007C	HLWP	Plug Number (T2): 3b; T26: X11-246-003-014
---------------	-----	--	------------------	------	--------------------------------------------

**2.0 E 16V quattro (103 kW | 2.0 Litre)**

07.92 - 06.94	ACE		246-086-001-007C	HLWP	Plug Number (T2): 3b; T26: X11-246-003-014
---------------	-----	--	------------------	------	--------------------------------------------

**2.0 E quattro (85 kW | 2.0 Litre)**

12.90 - 07.92	AAD		246-086-001-007C	HLWP	Plug Number (T2): 3b; T26: X11-246-003-014
---------------	-----	--	------------------	------	--------------------------------------------

**2.3 E (98 kW | 2.3 Litre)**

12.90 - 06.94	AAR		246-086-001-002C	HLWP	Plug Number (T2): 3
---------------	-----	--	------------------	------	---------------------

12.90 - 06.94	AAR		246-086-001-007C	HLWP	Plug Number (T2): 3b; T26: X11-246-003-014
---------------	-----	--	------------------	------	--------------------------------------------

**2.3 E quattro (98 kW | 2.3 Litre)**

12.90 - 06.94	AAR		246-086-001-007C	HLWP	Plug Number (T2): 3b; T26: X11-246-003-014
---------------	-----	--	------------------	------	--------------------------------------------

**2.4 D (60 kW | 2.4 Litre)**

12.90 - 06.94	AAS		246-086-001-002C	HLWP	Plug Number (T2): 3
---------------	-----	--	------------------	------	---------------------

12.90 - 06.94	AAS		246-086-001-007C	HLWP	Plug Number (T2): 3b; T26: X11-246-003-014
---------------	-----	--	------------------	------	--------------------------------------------

**2.5 TDI (85 kW | 2.5 Litre)**

06.91 - 06.94	AAT, ABP		246-086-001-002C	HLWP	Plug Number (T2): 3
---------------	----------	--	------------------	------	---------------------



			<b>VDO</b>		
Date	Engine Code	Chassis No.	Article No.	Product	Information

**AUDI****100 (4A, C4)****2.5 TDI (85 kW | 2.5 Litre)**

12.90 - 06.94	AAT, ABP		246-086-001-007C	HLWP	Plug Number (T2): 3b; T26: X11-246-003-014
---------------	----------	--	------------------	------	--------------------------------------------

**2.6 (102 kW | 2.6 Litre)**

07.93 - 06.94	ACZ		246-086-001-002C	HLWP	Plug Number (T2): 3
07.93 - 06.94	ACZ		246-086-001-007C	HLWP	Plug Number (T2): 3b; T26: X11-246-003-014

**2.6 (110 kW | 2.6 Litre)**

04.92 - 06.94	ABC		246-086-001-002C	HLWP	Plug Number (T2): 3
03.92 - 06.94	ABC		246-086-001-007C	HLWP	Plug Number (T2): 3b; T26: X11-246-003-014

**2.6 quattro (110 kW | 2.6 Litre)**

04.92 - 06.94	ABC		246-086-001-007C	HLWP	Plug Number (T2): 3b; T26: X11-246-003-014
---------------	-----	--	------------------	------	--------------------------------------------

**2.8 E (128 kW | 2.8 Litre)**

12.90 - 06.94	AAH		246-086-001-002C	HLWP	Plug Number (T2): 3
12.90 - 06.94	AAH		246-086-001-007C	HLWP	Plug Number (T2): 3b; T26: X11-246-003-014

**2.8 E quattro (128 kW | 2.8 Litre)**

07.92 - 06.94	AAH		246-082-008-014C	SWP-M-C	Plug Number (T2): 1
12.90 - 06.94	AAH		246-086-001-007C	HLWP	Plug Number (T2): 3b; T26: X11-246-003-014

**S4 Turbo quattro (169 kW | 2.2 Litre)**

08.91 - 06.94	AAN		246-086-001-007C	HLWP	Plug Number (T2): 3b; T26: X11-246-003-014
---------------	-----	--	------------------	------	--------------------------------------------

**S4 V8 quattro (206 kW | 4.2 Litre)**

10.92 - 06.94	ABH		246-086-001-007C	HLWP	Plug Number (T2): 3b; T26: X11-246-003-014
---------------	-----	--	------------------	------	--------------------------------------------

**S4 V8 quattro (213 kW | 4.2 Litre)**

03.94 - 06.94	AEC		246-086-001-007C	HLWP	Plug Number (T2): 3b; T26: X11-246-003-014
---------------	-----	--	------------------	------	--------------------------------------------

**100 Avant (4A, C4)****2.0 E (74 kW | 2.0 Litre)**

10.91 - 06.94	AAE		246-082-008-014C	SWP-M-C	Plug Number (T2): 1; T28: Rear (T29)
10.91 - 06.94	AAE		246-086-001-002C	HLWP	Plug Number (T2): 3
09.91 - 06.94	AAE		246-086-001-007C	HLWP	Plug Number (T2): 3b; T26: X11-246-003-014

**2.0 E (85 kW | 2.0 Litre)**

10.91 - 06.94	AAD, ABK		246-082-008-014C	SWP-M-C	Plug Number (T2): 1; T28: Rear (T29)
10.91 - 06.94	AAD, ABK		246-086-001-002C	HLWP	Plug Number (T2): 3
09.91 - 06.94	AAD, ABK		246-086-001-007C	HLWP	Plug Number (T2): 3b; T26: X11-246-003-014

**2.0 E quattro (85 kW | 2.0 Litre)**

12.90 - 07.92	AAD		246-086-001-007C	HLWP	Plug Number (T2): 3b; T26: X11-246-003-014
---------------	-----	--	------------------	------	--------------------------------------------

**2.3 E (98 kW | 2.3 Litre)**

10.91 - 06.94	AAR		246-082-008-014C	SWP-M-C	Plug Number (T2): 1; T28: Rear (T29)
10.91 - 06.94	AAR		246-086-001-002C	HLWP	Plug Number (T2): 3
09.91 - 06.94	AAR		246-086-001-007C	HLWP	Plug Number (T2): 3b; T26: X11-246-003-014

**2.3 E quattro (98 kW | 2.3 Litre)**

09.91 - 06.94	AAR		246-082-008-014C	SWP-M-C	Plug Number (T2): 1; T28: Rear (T29)
09.91 - 06.94	AAR		246-086-001-007C	HLWP	Plug Number (T2): 3b; T26: X11-246-003-014

**2.4 D (60 kW | 2.4 Litre)**

10.91 - 06.94	AAS		246-082-008-014C	SWP-M-C	Plug Number (T2): 1; T28: Rear (T29)
10.91 - 06.94	AAS		246-086-001-002C	HLWP	Plug Number (T2): 3
12.90 - 06.94	AAS		246-086-001-007C	HLWP	Plug Number (T2): 3b; T26: X11-246-003-014

**2.5 TDI (85 kW | 2.5 Litre)**

10.91 - 06.94	AAT, ABP		246-082-008-014C	SWP-M-C	Plug Number (T2): 1; T28: Rear (T29)
10.91 - 06.94	AAT, ABP		246-086-001-002C	HLWP	Plug Number (T2): 3
12.90 - 06.94	AAT, ABP		246-086-001-007C	HLWP	Plug Number (T2): 3b; T26: X11-246-003-014

**2.6 (102 kW | 2.6 Litre)**

07.93 - 06.94	ACZ		246-082-008-014C	SWP-M-C	Plug Number (T2): 1; T28: Rear (T29)
07.93 - 06.94	ACZ		246-086-001-002C	HLWP	Plug Number (T2): 3
07.93 - 06.94	ACZ		246-086-001-007C	HLWP	Plug Number (T2): 3b; T26: X11-246-003-014

**2.6 (110 kW | 2.6 Litre)**

04.92 - 06.94	ABC		246-082-008-014C	SWP-M-C	Plug Number (T2): 1; T28: Rear (T29)
04.92 - 06.94	ABC		246-086-001-002C	HLWP	Plug Number (T2): 3
03.92 - 06.94	ABC		246-086-001-007C	HLWP	Plug Number (T2): 3b; T26: X11-246-003-014

**2.6 quattro (110 kW | 2.6 Litre)**

07.92 - 06.94	B202XL		246-082-008-014C	SWP-M-C	Plug Number (T2): 1; T28: Rear (T29)
07.92 - 06.94	ABC		246-086-001-007C	HLWP	Plug Number (T2): 3b; T26: X11-246-003-014

**2.8 E (128 kW | 2.8 Litre)**

10.91 - 06.94	AAH		246-082-008-014C	SWP-M-C	Plug Number (T2): 1; T28: Rear (T29)
10.91 - 06.94	AAH		246-086-001-002C	HLWP	Plug Number (T2): 3





					
Date	Engine Code	Chassis No.	Article No.	Product	Information

**AUDI****100 Avant (4A, C4)****2.8 E (128 kW | 2.8 Litre)**

09.91 - 06.94	AAH		246-086-001-007C	HLWP	Plug Number (T2): 3b; T26: X11-246-003-014
---------------	-----	--	------------------	------	--------------------------------------------

**2.8 E quattro (128 kW | 2.8 Litre)**

09.91 - 06.94	AAH		246-082-008-014C	SWP-M-C	Plug Number (T2): 1; T28: Rear (T29)
09.91 - 06.94	AAH		246-086-001-007C	HLWP	Plug Number (T2): 3b; T26: X11-246-003-014

**S4 Turbo quattro (169 kW | 2.2 Litre)**

09.91 - 06.94	AAN		246-082-008-014C	SWP-M-C	Plug Number (T2): 1; T28: Rear (T29)
09.91 - 06.94	AAN		246-086-001-007C	HLWP	Plug Number (T2): 3b; T26: X11-246-003-014

**S4 V8 quattro (206 kW | 4.2 Litre)**

10.92 - 06.94	ABH		246-086-001-007C	HLWP	Plug Number (T2): 3b; T26: X11-246-003-014
---------------	-----	--	------------------	------	--------------------------------------------

**S4 V8 quattro (213 kW | 4.2 Litre)**

03.94 - 06.94	AEC		246-082-008-014C	SWP-M-C	Plug Number (T2): 1; T28: Rear (T29)
03.94 - 06.94	AEC		246-086-001-007C	HLWP	Plug Number (T2): 3b; T26: X11-246-003-014

**200 (43)****2.1 5 E (100 kW | 2.1 Litre)**

10.79 - 09.82	WC		246-082-008-014C	SWP-M-C	Plug Number (T2): 1
10.79 - 09.82	WC		246-086-001-007C	HLWP	Plug Number (T2): 3b; T26: X11-246-003-014

**2.1 5 T (125 kW | 2.1 Litre)**

10.79 - 08.82	WJ		246-082-008-014C	SWP-M-C	Plug Number (T2): 1
---------------	----	--	------------------	---------	---------------------

**200 (44, 44Q)****2.1 5 E (100 kW | 2.1 Litre)**

08.83 - 07.84	WC		246-075-021-006C	SWP-M-G	Plug Number (T2): 1
08.83 - 07.84	WC		246-082-008-014C	SWP-M-C	Plug Number (T2): 1
08.83 - 07.84	WC		246-086-001-007C	HLWP	Plug Number (T2): 3b; T26: X11-246-003-014

**2.1 Turbo (134 kW | 2.1 Litre)**

08.83 - 01.88	KG		246-075-021-006C	SWP-M-G	Plug Number (T2): 1
08.83 - 01.88	KG		246-082-008-014C	SWP-M-C	Plug Number (T2): 1
08.83 - 01.88	KG		246-086-001-007C	HLWP	Plug Number (T2): 3b; T26: X11-246-003-014

**2.1 Turbo quattro (134 kW | 2.1 Litre)**

10.84 - 09.86	KG		246-075-021-006C	SWP-M-G	Plug Number (T2): 1
10.84 - 09.86	KG		246-082-008-014C	SWP-M-C	Plug Number (T2): 1
08.83 - 09.86	KG		246-086-001-007C	HLWP	Plug Number (T2): 3b; T26: X11-246-003-014

**2.2 (101 kW | 2.2 Litre)**

08.84 - 07.85	KU		246-075-021-006C	SWP-M-G	Plug Number (T2): 1
08.84 - 07.85	KU		246-082-008-014C	SWP-M-C	Plug Number (T2): 1
08.84 - 07.85	KU		246-086-001-007C	HLWP	Plug Number (T2): 3b; T26: X11-246-003-014

**2.2 20V Turbo quattro (162 kW | 2.2 Litre)**

08.89 - 11.90	3B		246-082-008-014C	SWP-M-C	Plug Number (T2): 1
03.89 - 12.90	3B		246-086-001-007C	HLWP	Plug Number (T2): 3b; T26: X11-246-003-014

**2.2 Turbo (121 kW | 2.2 Litre)**

08.85 - 01.88	MC		246-075-021-006C	SWP-M-G	Plug Number (T2): 1
08.85 - 12.90	MC		246-082-008-014C	SWP-M-C	Plug Number (T2): 1
08.85 - 09.91	MC		246-086-001-007C	HLWP	Plug Number (T2): 3b; T26: X11-246-003-014

**2.2 Turbo (140 kW | 2.2 Litre)**

02.88 - 12.90	2B		246-082-008-014C	SWP-M-C	Plug Number (T2): 1
02.88 - 12.90	2B		246-086-001-007C	HLWP	Plug Number (T2): 3b; T26: X11-246-003-014

**2.2 Turbo (147 kW | 2.2 Litre)**

02.88 - 12.90	1B		246-086-001-007C	HLWP	Plug Number (T2): 3b; T26: X11-246-003-014
---------------	----	--	------------------	------	--------------------------------------------

**2.2 Turbo quattro (121 kW | 2.2 Litre)**

08.85 - 11.90	MC		246-082-008-014C	SWP-M-C	Plug Number (T2): 1
01.85 - 12.91	MC		246-086-001-007C	HLWP	Plug Number (T2): 3b; T26: X11-246-003-014

**2.2 Turbo quattro (147 kW | 2.2 Litre)**

02.88 - 11.90	1B		246-082-008-014C	SWP-M-C	Plug Number (T2): 1
02.88 - 11.90	1B		246-086-001-007C	HLWP	Plug Number (T2): 3b; T26: X11-246-003-014

**2.3 (100 kW | 2.3 Litre)**

08.88 - 12.90	NF		246-082-008-014C	SWP-M-C	Plug Number (T2): 1
11.86 - 09.91	NF		246-086-001-007C	HLWP	Plug Number (T2): 3b; T26: X11-246-003-014

**200 Avant (44, 44Q)****2.1 Turbo quattro (134 kW | 2.1 Litre)**

10.84 - 01.88	KG		246-075-021-006C	SWP-M-G	Plug Number (T2): 1
---------------	----	--	------------------	---------	---------------------



			<b>VDO</b>		
Date	Engine Code	Chassis No.	Article No.	Product	Information

**AUDI****200 Avant (44, 44Q)****2.1 Turbo quattro (134 kW | 2.1 Litre)**

09.83 - 01.88	KG		246-082-008-014C	SWP-M-C	Plug Number (T2): 1; T28: Rear (T29)
09.83 - 01.88	KG		246-086-001-007C	HLWP	Plug Number (T2): 3b; T26: X11-246-003-014

**2.2 20V Turbo quattro (162 kW | 2.2 Litre)**

07.89 - 12.90	3B		246-082-008-014C	SWP-M-C	Plug Number (T2): 1; T28: Rear (T29)
07.89 - 12.90	3B		246-086-001-007C	HLWP	Plug Number (T2): 3b; T26: X11-246-003-014

**2.2 Turbo (121 kW | 2.2 Litre)**

08.85 - 09.91	MC		246-086-001-007C	HLWP	Plug Number (T2): 3b; T26: X11-246-003-014
---------------	----	--	------------------	------	--------------------------------------------

**2.2 Turbo quattro (121 kW | 2.2 Litre)**

01.85 - 11.90	MC		246-082-008-014C	SWP-M-C	Plug Number (T2): 1; T28: Rear (T29)
09.83 - 12.90	MC		246-086-001-007C	HLWP	Plug Number (T2): 3b; T26: X11-246-003-014

**2.2 Turbo quattro (147 kW | 2.2 Litre)**

02.88 - 11.90	1B		246-082-008-014C	SWP-M-C	Plug Number (T2): 1; T28: Rear (T29)
02.88 - 12.91	1B		246-086-001-007C	HLWP	Plug Number (T2): 3b; T26: X11-246-003-014

**2.3 (100 kW | 2.3 Litre)**

03.89 - 11.90	NF		246-082-008-014C	SWP-M-C	Plug Number (T2): 1; T28: Rear (T29)
11.86 - 09.91	NF		246-086-001-007C	HLWP	Plug Number (T2): 3b; T26: X11-246-003-014

**BMW****1 (E81, E87)****116 d (85 kW | 2.0 Litre)**

03.09 - 09.12	N47 D20 A, N47 D20 C		246-082-008-025G	SWP-M-C	
03.09 - 09.12	N47 D20 A, N47 D20 C		A2C53240479Z	SWP-M-C	Vehicle Equipment (T31): for vehicles without rear windscreen wiper (T37)

**116 i (85 kW | 1.6 Litre)**

09.04 - 09.12	N45 B16 A, N45 B16 TU2, N45 B16, N43 B16 A		246-082-008-025G	SWP-M-C	
09.04 - 09.12	N45 B16 A, N45 B16 TU2, N45 B16, N43 B16 A		246-086-001-007C	HLWP	Plug Number (T2): 3b
09.04 - 09.12	N43 B16 A, N45 B16, N45 B16 A, N45 B16 TU2		A2C53240479Z	SWP-M-C	

**116 i (90 kW | 1.6 Litre)**

09.07 - 09.12	N45 B16 TU2, N43 B16 A, N45 B16 A		246-082-008-025G	SWP-M-C	
09.07 - 09.12	N 45 B 16 TU2		246-086-001-007C	HLWP	Plug Number (T2): 3b
09.07 - 09.12	N43 B16 A, N45 B16 A, N45 B16 TU2		A2C53240479Z	SWP-M-C	

**116 i (90 kW | 2.0 Litre)**

01.09 - 09.12	N43 B20 A		246-082-008-025G	SWP-M-C	
01.09 - 09.12	N43 B20 A		A2C53240479Z	SWP-M-C	Vehicle Equipment (T31): for vehicles without rear windscreen wiper (T37)

**118 d (100 kW | 2.0 Litre)**

03.07 - 09.12	N47 D20 C, N47 D20 A		246-082-008-025G	SWP-M-C	
03.07 - 09.12	N47 D20 A, N47 D20 C		A2C53240479Z	SWP-M-C	Vehicle Equipment (T31): for vehicles without rear windscreen wiper (T37)

**118 d (105 kW | 2.0 Litre)**

04.07 - 09.12	N47 D20 A, N47 D20 C		246-082-008-025G	SWP-M-C	
04.07 - 09.12	N47D20A		246-086-001-007C	HLWP	Plug Number (T2): 3b
04.07 - 09.12	N47 D20 A, N47 D20 C		A2C53240479Z	SWP-M-C	Vehicle Equipment (T31): for vehicles without rear windscreen wiper (T37)

**118 d (90 kW | 2.0 Litre)**

09.04 - 09.12	M47N 204 D4		246-082-008-025G	SWP-M-C	
09.04 - 09.12	M47N 204 D4		246-086-001-007C	HLWP	Plug Number (T2): 3b
09.04 - 09.12	M47N 204 D4		A2C53240479Z	SWP-M-C	Vehicle Equipment (T31): for vehicles without rear windscreen wiper (T37)

**118 i (100 kW | 2.0 Litre)**

03.07 - 09.12	N46 B20 B		A2C53240479Z	SWP-M-C	
---------------	-----------	--	--------------	---------	--

**118 i (105 kW | 2.0 Litre)**

04.07 - 09.12	N43 B20 A, N46 B20 B		246-082-008-025G	SWP-M-C	
04.07 - 09.12	N 43 B 20 A		246-086-001-007C	HLWP	Plug Number (T2): 3b



			<b>VDO</b>		
Date	Engine Code	Chassis No.	Article No.	Product	Information

**BMW****1 (E81, E87)****118 i (105 kW | 2.0 Litre)**

04.07 - 09.12 N43 B20 A

A2C53240479Z

SWP-M-C

**118 i (95 kW | 2.0 Litre)**

09.04 - 09.12 N46 B20 B, N43 B20 A

246-082-008-025G

SWP-M-C

09.04 - 09.12 N46 B20 B, N43 B20 A

246-086-001-007C

HLWP

Plug Number (T2): 3b

09.04 - 09.12 N42 B20 B, N46 B20

A2C53240479Z

SWP-M-C

**120 d (120 kW | 2.0 Litre)**

09.04 - 09.12 M47N 204 D4, N47 D20 A

246-082-008-025G

SWP-M-C

09.04 - 09.12 M47N 204 D4, N47 D20 A

246-086-001-007C

HLWP

Plug Number (T2): 3b

09.04 - 09.12 M47N 204 D4, N47 D20 A

A2C53240479Z

SWP-M-C

**120 d (130 kW | 2.0 Litre)**

03.07 - 09.12 N47 D20 A, N47 D20 C

246-082-008-025G

SWP-M-C

03.07 - 09.12 N47D20A

246-086-001-007C

HLWP

Plug Number (T2): 3b

03.07 - 09.12 N47 D20 A, N47 D20 C

A2C53240479Z

SWP-M-C

Vehicle Equipment (T31): for vehicles without rear windscreen wiper (T37)

**120 i (110 kW | 2.0 Litre)**

09.04 - 09.12 N42 B20 A, N46 B20

246-082-008-025G

SWP-M-C

09.04 - 09.12 N42 B20 A, N46 B20

246-086-001-007C

HLWP

Plug Number (T2): 3b

09.04 - 09.12 N42 B20 A, N46 B20

A2C53240479Z

SWP-M-C

Vehicle Equipment (T31): for vehicles without rear windscreen wiper (T37)

**120 i (115 kW | 2.0 Litre)**

03.07 - 09.12 N43 B20 A

246-082-008-025G

SWP-M-C

03.07 - 09.12 N43 B20 A

A2C53240479Z

SWP-M-C

Vehicle Equipment (T31): for vehicles without rear windscreen wiper (T37)

**120 i (120 kW | 2.0 Litre)**

03.07 - 09.12 N43 B20 A

246-082-008-025G

SWP-M-C

03.07 - 09.12 N43 B20 A

A2C53240479Z

SWP-M-C

Vehicle Equipment (T31): for vehicles without rear windscreen wiper (T37)

**120 i (125 kW | 2.0 Litre)**

04.07 - 09.12 N43 B20 A

246-082-008-025G

SWP-M-C

04.07 - 09.12 N 43 B 20 A

246-086-001-007C

HLWP

Plug Number (T2): 3b

04.07 - 09.12 N43 B20 A

A2C53240479Z

SWP-M-C

Vehicle Equipment (T31): for vehicles without rear windscreen wiper (T37)

**123 d (150 kW | 2.0 Litre)**

10.07 - 09.12 N47 D20 B

246-082-008-025G

SWP-M-C

10.07 - 09.12 N47D20B

246-086-001-007C

HLWP

Plug Number (T2): 3b

10.07 - 09.12 N47 D20 B

A2C53240479Z

SWP-M-C

**130 i (190 kW | 3.0 Litre)**

03.05 - 09.12 N52 B30 A

246-082-008-025G

SWP-M-C

03.05 - 09.12 N52 B30 A

A2C53240479Z

SWP-M-C

Vehicle Equipment (T31): for vehicles without rear windscreen wiper (T37)

**130 i (195 kW | 3.0 Litre)**

09.05 - 09.12 N52 B30 A, N52 B30

246-082-008-025G

SWP-M-C

09.05 - 09.12 N 52 B 30, N52B30A

246-086-001-007C

HLWP

Plug Number (T2): 3b

09.05 - 09.12 N52 B30, N52 B30 A

A2C53240479Z

SWP-M-C

**1 Coupe (E82)****118 d (100 kW | 2.0 Litre)**

09.09 - N47 D20 C

A2C53240479Z

SWP-M-C

**118 d (105 kW | 2.0 Litre)**

09.09 -

246-086-001-007C

HLWP

Plug Number (T2): 3b

09.09 - N47 D20 C

A2C53240479Z

SWP-M-C

**120 d (120 kW | 2.0 Litre)**

10.07 - N47D20A

246-086-001-007C

HLWP

Plug Number (T2): 3b

10.07 - N47 D20 A

A2C53240479Z

SWP-M-C

**120 d (130 kW | 2.0 Litre)**

10.07 - N47D20A

246-086-001-007C

HLWP

Plug Number (T2): 3b

10.07 - N47 D20 A, N47 D20 C

A2C53240479Z

SWP-M-C

**120 i (125 kW | 2.0 Litre)**

09.09 - N 43 B 20 A

246-086-001-007C

HLWP

Plug Number (T2): 3b

09.09 - N43 B20 A

A2C53240479Z

SWP-M-C

**123 d (150 kW | 2.0 Litre)**

10.07 - N47D20B

246-086-001-007C

HLWP

Plug Number (T2): 3b



			<b>VDO</b>		
Date	Engine Code	Chassis No.	Article No.	Product	Information

**BMW****1 Coupe (E82)****123 d (150 kW | 2.0 Litre)**

10.07 --	N47 D20 B		A2C53240479Z	SWP-M-C	
----------	-----------	--	--------------	---------	--

**125 i (160 kW | 3.0 Litre)**

10.07 --	N53B30A		246-086-001-007C	HLWP	Plug Number (T2): 3b
----------	---------	--	------------------	------	----------------------

10.07 --	N53 B30 A		A2C53240479Z	SWP-M-C	
----------	-----------	--	--------------	---------	--

**135 i (225 kW | 3.0 Litre)**

10.07 --	N54B30A		246-086-001-007C	HLWP	Plug Number (T2): 3b
----------	---------	--	------------------	------	----------------------

10.07 --	N54 B30 A, N55 B30 A		A2C53240479Z	SWP-M-C	
----------	----------------------	--	--------------	---------	--

**M 3.0 (250 kW | 3.0 Litre)**

04.11 -- 06.12	N54 B30 A		A2C53240479Z	SWP-M-C	
----------------	-----------	--	--------------	---------	--

**1 Convertible (E88)****118 d (100 kW | 2.0 Litre)**

09.08 --	N47D20A		246-086-001-007C	HLWP	Plug Number (T2): 3b
----------	---------	--	------------------	------	----------------------

09.08 --	N47 D20 A, N47 D20 C		A2C53240479Z	SWP-M-C	Equipment (T11): for rear windscreen cleaning (T14)
----------	----------------------	--	--------------	---------	-----------------------------------------------------

**118 d (105 kW | 2.0 Litre)**

09.08 --	N47D20A		246-086-001-007C	HLWP	Plug Number (T2): 3b
----------	---------	--	------------------	------	----------------------

09.08 --	N47 D20 A, N47 D20 C		A2C53240479Z	SWP-M-C	Equipment (T11): for rear windscreen cleaning (T14)
----------	----------------------	--	--------------	---------	-----------------------------------------------------

**118 i (105 kW | 2.0 Litre)**

03.08 --	N 43 B 20 A		246-086-001-007C	HLWP	Plug Number (T2): 3b
----------	-------------	--	------------------	------	----------------------

03.08 --	N43 B20 A		A2C53240479Z	SWP-M-C	Equipment (T11): for rear windscreen cleaning (T14)
----------	-----------	--	--------------	---------	-----------------------------------------------------

**120 d (120 kW | 2.0 Litre)**

03.08 --	N47D20A		246-086-001-007C	HLWP	Plug Number (T2): 3b
----------	---------	--	------------------	------	----------------------

03.08 --	N47 D20 A		A2C53240479Z	SWP-M-C	Equipment (T11): for rear windscreen cleaning (T14)
----------	-----------	--	--------------	---------	-----------------------------------------------------

**120 d (130 kW | 2.0 Litre)**

03.08 --	N47D20A		246-086-001-007C	HLWP	Plug Number (T2): 3b
----------	---------	--	------------------	------	----------------------

03.08 --	N47 D20 A, N47 D20 C		A2C53240479Z	SWP-M-C	Equipment (T11): for rear windscreen cleaning (T14)
----------	----------------------	--	--------------	---------	-----------------------------------------------------

**120 d (145 kW | 2.0 Litre)**

03.08 --	N47 D20 C		A2C53240479Z	SWP-M-C	Equipment (T11): for rear windscreen cleaning (T14)
----------	-----------	--	--------------	---------	-----------------------------------------------------

**120 i (115 kW | 2.0 Litre)**

03.08 --	N46 B20 B, N46 B20 C		A2C53240479Z	SWP-M-C	Equipment (T11): for rear windscreen cleaning (T14)
----------	----------------------	--	--------------	---------	-----------------------------------------------------

**120 i (120 kW | 2.0 Litre)**

03.08 --			246-086-001-007C	HLWP	Plug Number (T2): 3b
----------	--	--	------------------	------	----------------------

03.08 --	N43 B20 A		A2C53240479Z	SWP-M-C	Equipment (T11): for rear windscreen cleaning (T14)
----------	-----------	--	--------------	---------	-----------------------------------------------------

**120 i (125 kW | 2.0 Litre)**

03.08 --	N 43 B 20 A		246-086-001-007C	HLWP	Plug Number (T2): 3b
----------	-------------	--	------------------	------	----------------------

03.08 --	N43 B20 A		A2C53240479Z	SWP-M-C	Equipment (T11): for rear windscreen cleaning (T14)
----------	-----------	--	--------------	---------	-----------------------------------------------------

**123 d (150 kW | 2.0 Litre)**

09.08 --	N47D20B		246-086-001-007C	HLWP	Plug Number (T2): 3b
----------	---------	--	------------------	------	----------------------

09.08 --	N47 D20 B		A2C53240479Z	SWP-M-C	Equipment (T11): for rear windscreen cleaning (T14)
----------	-----------	--	--------------	---------	-----------------------------------------------------

**125 i (160 kW | 3.0 Litre)**

03.08 --	N52B30A		246-086-001-007C	HLWP	Plug Number (T2): 3b
----------	---------	--	------------------	------	----------------------

03.08 --	N52 B30 A		A2C53240479Z	SWP-M-C	Equipment (T11): for rear windscreen cleaning (T14)
----------	-----------	--	--------------	---------	-----------------------------------------------------

**135 i (225 kW | 3.0 Litre)**

03.08 --	N54B30A		246-086-001-007C	HLWP	Plug Number (T2): 3b
----------	---------	--	------------------	------	----------------------

03.08 --	N54 B30 A, N55 B30 A		A2C53240479Z	SWP-M-C	Equipment (T11): for rear windscreen cleaning (T14)
----------	----------------------	--	--------------	---------	-----------------------------------------------------

**135 i (240 kW | 3.0 Litre)**

03.08 --	N55 B30 A		A2C53240479Z	SWP-M-C	Equipment (T11): for rear windscreen cleaning (T14)
----------	-----------	--	--------------	---------	-----------------------------------------------------



			<b>VDO</b>		
Date	Engine Code	Chassis No.	Article No.	Product	Information

**BMW****1 (F20, F21)****114 i (75 kW | 1.6 Litre)**

11.11 → N13 B16 A

A2C53304876

HLWP

**116 d (85 kW | 1.6 Litre)**

09.11 → N47 D16 A

A2C53304876

HLWP

**116 d (85 kW | 2.0 Litre)**

12.10 → N47 D20 C

246-082-008-025G

SWP-M-C

12.10 → N47 D20 C

A2C53304876

HLWP

**116 i (100 kW | 1.6 Litre)**

12.10 → N13 B16 A

246-082-008-025G

SWP-M-C

12.10 → N13 B16 A

A2C53304876

HLWP

**118 d (100 kW | 2.0 Litre)**

06.11 → N47 D20 C

A2C53304876

HLWP

**118 d (105 kW | 2.0 Litre)**

06.11 → N47 D20 C

246-082-008-025G

SWP-M-C

06.11 → N47 D20 C

A2C53304876

HLWP

**118 i (125 kW | 1.6 Litre)**

11.10 → N13 B16 A

246-082-008-025G

SWP-M-C

11.10 → N13 B16 A

A2C53304876

HLWP

**120 d (120 kW | 2.0 Litre)**

12.10 → N47 D20 C

A2C53304876

HLWP

**120 d (135 kW | 2.0 Litre)**

12.10 → N47 D20 C

246-082-008-025G

SWP-M-C

12.10 → N47 D20 C

A2C53304876

HLWP

**125 d (155 kW | 2.0 Litre)**

08.11 → N47 D20 D

A2C53304876

HLWP

**125 d (160 kW | 2.0 Litre)**

08.11 → N47 D20 D

A2C53304876

HLWP

**125 i (160 kW | 2.0 Litre)**

02.12 → N20 B20 A

A2C53304876

HLWP

**3 (E30)****316 (66 kW | 1.8 Litre)**

09.82 → 12.87 M10 B18

246-080-013-001Z

N-H

**316 (Ecotronic) (66 kW | 1.8 Litre)**

09.83 → 12.90 M10 B18

246-080-013-001Z

N-H

**3 Touring (E30)****320 i (95 kW | 2.0 Litre)**

01.88 → 12.91 M20 B20

246-080-013-001Z

N-H

**3 Convertible (E30)****318 i (83 kW | 1.8 Litre)**

09.90 → 10.93 M 40 B 18

246-080-013-003Z

N-H

**3 (E36)****316 i (73 kW | 1.6 Litre)**

09.90 → 09.93 M 40 B 16 (Kat.)

246-069-059-001Z

N

09.90 → 09.93 M 40 B 16 (Kat.)

246-080-013-003Z

N-H

**316 i (75 kW | 1.6 Litre)**

09.90 → 09.93 M 40 B 16, M 43 B 16

246-069-059-001Z

N

07.93 → 02.98 M 43 B 16

246-069-059-001Z

N

09.90 → 09.93 M 40 B 16, M 43 B 16

246-080-013-003Z

N-H

07.93 → 03.97 M 43 B 16

246-080-013-003Z

N-H

07.93 → 02.98 M43 B16

246-082-008-025G

SWP-M-C

09.97 → 02.98 M 43 B 16

246-086-001-007C

HLWP

Plug Number (T2): 3b

**318 i (83 kW | 1.8 Litre)**

12.90 → 10.93 M 40 B 18

246-069-059-001Z

N

12.90 → 10.93 M 40 B 18

246-080-013-003Z

N-H

**318 i (85 kW | 1.8 Litre)**

10.93 → 02.98 M 43 B 18

246-069-059-001Z

N

10.93 → 03.97 M 43 B 18

246-080-013-003Z

N-H

10.93 → 02.98 M43 B18

246-082-008-025G

SWP-M-C

09.97 → 02.98 M 43 B 18

246-086-001-007C

HLWP

Plug Number (T2): 3b



			<b>VDO</b>		
Date	Engine Code	Chassis No.	Article No.	Product	Information

**BMW****3 (E36)****318 is (103 kW | 1.8 Litre)**

03.93 - 02.98	M 42 B 18		246-069-059-001Z	N	
03.93 - 02.98	M 42 B 18		246-080-013-003Z	N-H	

**318 is (103 kW | 1.9 Litre)**

09.95 - 02.98	M 44 B 19		246-069-059-001Z	N	
09.95 - 03.97	M 44 B 19		246-080-013-003Z	N-H	
02.98 - 02.98	M44 B19		246-082-008-025G	SWP-M-C	

**318 tds (66 kW | 1.7 Litre)**

01.95 - 02.98	M 41 D 18 (Inter.)		246-069-059-001Z	N	
01.95 - 03.97	M 41 D 18 (Inter.)		246-080-013-003Z	N-H	
01.95 - 02.98	M41 D18 (Inter.)		246-082-008-025G	SWP-M-C	
09.97 - 02.98	M 41 D 18 (Inter.)		246-086-001-007C	HLWP	Plug Number (T2): 3b

**320 i (110 kW | 2.0 Litre)**

09.90 - 02.98	M50 B(20 6 S1), M50 B(20 6 S2) Vanos, M52 B(20 6 S3) Vanos, M50 B20 TU, M50 B20, M52 B20		246-069-059-001Z	N	
09.90 - 02.98	M50 B(20 6 S1), M50 B(20 6 S2) Vanos, M52 B(20 6 S3) Vanos, M50 B20 TU, M50 B20, M52 B20		246-080-013-003Z	N-H	
09.90 - 02.98	M50 B(20 6 S1), M50 B(20 6 S2) Vanos, M52 B(20 6 S3) Vanos, M50 B20 TU, M50 B20, M52 B20		246-082-008-025G	SWP-M-C	
09.97 - 02.98	M50 B(20 6 S1), M50 B(20 6 S2) Vanos, M52 B(20 6 S3) Vanos, M50 B20 TU, M50 B20, M52 B20		246-086-001-007C	HLWP	Plug Number (T2): 3b

**323 i 2.5 (125 kW | 2.5 Litre)**

03.95 - 02.98	M52 B25 (Vanos)		246-069-059-001Z	N	
03.95 - 03.97	M 52 B 25 (Vanos)		246-080-013-003Z	N-H	
02.98 - 02.98	M52 B25 (Vanos)		246-082-008-025G	SWP-M-C	
09.97 - 02.98	M52 B25 (Vanos)		246-086-001-007C	HLWP	Plug Number (T2): 3b

**325 i (141 kW | 2.5 Litre)**

09.90 - 09.95	M50 B25, M50 B25 (Vanos), M50 B25 TU		246-069-059-001Z	N	
09.90 - 09.95	M 50 B 25, M 50 B 25 (Vanos), M 50 B 25 TU		246-080-013-003Z	N-H	

**325 td (85 kW | 2.5 Litre)**

09.91 - 02.98	M51 D25		246-069-059-001Z	N	
09.91 - 03.97	M 51 D 25		246-080-013-003Z	N-H	
09.91 - 02.98	M51 D25		246-082-008-025G	SWP-M-C	
09.97 - 02.98	M51 D25		246-086-001-007C	HLWP	Plug Number (T2): 3b

**325 tds (105 kW | 2.5 Litre)**

05.93 - 02.98	M51 D25 (Inter.)		246-069-059-001Z	N	
05.93 - 03.97	M 51 D 25 (Inter.)		246-080-013-003Z	N-H	
05.93 - 02.98	M51 D25 (Inter.)		246-082-008-025G	SWP-M-C	
09.97 - 02.98	M51 D25 (Inter.)		246-086-001-007C	HLWP	Plug Number (T2): 3b

**328 i (142 kW | 2.8 Litre)**

01.95 - 02.98	M52 B28, M52 B28 TU		246-069-059-001Z	N	
01.95 - 03.97	M 52 B 28, M 52 B 28 TU		246-080-013-003Z	N-H	
02.98 - 02.98	M52 B28, M52 B28 TU		246-082-008-025G	SWP-M-C	
09.97 - 02.98	M52 B28, M52 B28 TU		246-086-001-007C	HLWP	Plug Number (T2): 3b

**M3 3.0 (210 kW | 3.0 Litre)**

08.94 - 09.95	S50 B30		246-069-059-001Z	N	
08.94 - 09.95	S50 B30		246-082-008-025G	SWP-M-C	

**M3 3.2 (236 kW | 3.2 Litre)**

09.95 - 02.98	S50 B32		246-069-059-001Z	N	
09.95 - 03.97	S 50 B 32		246-080-013-003Z	N-H	
09.97 - 02.98	S50 B32		246-082-008-025G	SWP-M-C	
09.97 - 02.98	S50 B32		246-086-001-007C	HLWP	Plug Number (T2): 3b



			<b>VDO</b>		
Date	Engine Code	Chassis No.	Article No.	Product	Information

**BMW****3 Compact (E36)****316 g (75 kW | 1.6 Litre)**

12.95 - 08.00	M43 B16		246-069-059-001Z	N	
12.95 - 03.97			246-080-013-003Z	N-H	
12.95 - 08.00	M43 B16		246-082-008-025G	SWP-M-C	
12.95 - 08.00	M43 B16		246-083-002-022G	SWP-D-C	
09.97 - 08.00	M43 B16		246-086-001-007C	HLWP	Plug Number (T2): 3b

**316 i (75 kW | 1.6 Litre)**

03.94 - 08.00	M43 B16		246-069-059-001Z	N	
03.94 - 03.97	M43 B16		246-080-013-003Z	N-H	
03.94 - 08.00	M43 B16		246-082-008-025G	SWP-M-C	
03.94 - 08.00	M43 B16		246-083-002-022G	SWP-D-C	
09.97 - 08.00	M43 B16		246-086-001-007C	HLWP	Plug Number (T2): 3b

**316 i (77 kW | 1.9 Litre)**

12.98 - 08.00	M43 164 E3, M43 B19 TU		246-069-059-001Z	N	
12.98 - 08.00	M43 164 E3, M43 B19 TU		246-080-013-003Z	N-H	
12.98 - 08.00	M43 164 E3, M43 B19 TU		246-082-008-025G	SWP-M-C	
12.98 - 08.00	M43 164 E3, M43 B19 TU		246-083-002-022G	SWP-D-C	
12.98 - 08.00	M43 164 E3, M43 B19 TU		246-086-001-007C	HLWP	Plug Number (T2): 3b

**318 tds (66 kW | 1.7 Litre)**

01.95 - 08.00	M41 D18 (Inter.)		246-069-059-001Z	N	
01.95 - 03.97	M 41 D 18 (Inter.)		246-080-013-003Z	N-H	
01.95 - 08.00	M41 D18 (Inter.)		246-082-008-025G	SWP-M-C	
01.95 - 08.00	M41 D18 (Inter.)		246-083-002-022G	SWP-D-C	
09.97 - 08.00	M41 D18 (Inter.)		246-086-001-007C	HLWP	Plug Number (T2): 3b

**318 ti (103 kW | 1.8 Litre)**

11.94 - 08.95	M42 B18		246-069-059-001Z	N	
11.94 - 08.95	M 42 B 18		246-080-013-003Z	N-H	
11.94 - 08.95	M42 B18		246-083-002-022G	SWP-D-C	

**318 ti (103 kW | 1.9 Litre)**

07.95 - 08.00	M44 B19		246-069-059-001Z	N	
07.95 - 03.97	M 44 B 19		246-080-013-003Z	N-H	
07.95 - 08.00	M44 B19		246-082-008-025G	SWP-M-C	
07.95 - 08.00	M44 B19		246-083-002-022G	SWP-D-C	
09.97 - 08.00	M44 B19		246-086-001-007C	HLWP	Plug Number (T2): 3b

**323 ti (125 kW | 2.5 Litre)**

08.97 - 08.00	M52 B25 (Vanos)		246-069-059-001Z	N	
08.97 - 08.00	M52 B25 (Vanos)		246-082-008-025G	SWP-M-C	
08.97 - 08.00	M52 B25 (Vanos)		246-083-002-022G	SWP-D-C	
09.97 - 08.00	M52 B25 (Vanos)		246-086-001-007C	HLWP	Plug Number (T2): 3b

**3 Coupe (E36)****316 i (75 kW | 1.6 Litre)**

09.93 - 04.99	M 43 B 16		246-069-059-001Z	N	
09.93 - 03.97	M 43 B 16		246-080-013-003Z	N-H	
09.93 - 11.97	M43 B16		246-082-008-025G	SWP-M-C	
09.97 - 04.99	M 43 B 16		246-086-001-007C	HLWP	Plug Number (T2): 3b

**318 is (103 kW | 1.8 Litre)**

03.92 - 10.95	M 42 B 18		246-069-059-001Z	N	
03.92 - 10.95	M 42 B 18		246-080-013-003Z	N-H	

**318 is (103 kW | 1.9 Litre)**

09.95 - 04.99	M 44 B 19		246-069-059-001Z	N	
09.95 - 03.97	M 44 B 19		246-080-013-003Z	N-H	
09.95 - 04.99	M44 B19		246-082-008-025G	SWP-M-C	
09.97 - 04.99	M 44 B 19		246-086-001-007C	HLWP	Plug Number (T2): 3b

**320 i (110 kW | 2.0 Litre)**

03.92 - 04.99	M 50 B (20 6 S1), M 50 B (20 6 S2) Van, M 50 B 20, M 50 B 20 TU, M 52 B (20 6 S3) Van, M 52 B 20		246-069-059-001Z	N	
03.92 - 03.97	M 50 B (20 6 S1), M 50 B (20 6 S2) Van, M 50 B 20, M 50 B 20 TU, M 52 B (20 6 S3) Van, M 52 B 20		246-080-013-003Z	N-H	



			<b>VDO</b>		
Date	Engine Code	Chassis No.	Article No.	Product	Information

**BMW****3 Coupe (E36)****320 i (110 kW | 2.0 Litre)**

03.92 - 11.97	M52 B(20 6 S3) Vanos, M50 B(20 6 S1), M50 B(20 6 S2) Vanos, M50 B20 TU, M50 B20, M52 B20		246-082-008-025G	SWP-M-C	
09.97 - 04.99	M 50 B (20 6 S1), M 50 B (20 6 S2) Van, M 50 B 20, M 50 B 20 TU, M 52 B (20 6 S3) Van, M 52 B 20		246-086-001-007C	HLWP	Plug Number (T2): 3b

**323 i (125 kW | 2.5 Litre)**

03.95 - 04.99	M 52 B 25 (Vanos)		246-069-059-001Z	N	
03.95 - 03.97	M 52 B 25 (Vanos)		246-080-013-003Z	N-H	
11.97 - 04.99	M52 B25 (Vanos)		246-082-008-025G	SWP-M-C	
09.97 - 04.99	M 52 B 25 (Vanos)		246-086-001-007C	HLWP	Plug Number (T2): 3b

**325 i (141 kW | 2.5 Litre)**

03.92 - 04.99	M 50 B 25, M 50 B 25 (Vanos), M 50 B 25 TU		246-069-059-001Z	N	
03.92 - 03.97	M 50 B 25, M 50 B 25 (Vanos), M 50 B 25 TU		246-080-013-003Z	N-H	
03.92 - 11.97	M50 B25 (Vanos), M50 B25, M50 B25 TU		246-082-008-025G	SWP-M-C	
09.97 - 04.99	M 50 B 25, M 50 B 25 (Vanos), M 50 B 25 TU		246-086-001-007C	HLWP	Plug Number (T2): 3b

**328 i (142 kW | 2.8 Litre)**

01.95 - 04.99	M 52 B 28, M 52 B 28 TU		246-069-059-001Z	N	
01.95 - 03.97	M 52 B 28, M 52 B 28 TU		246-080-013-003Z	N-H	
11.97 - 04.99	M52 B28, M52 B28 TU		246-082-008-025G	SWP-M-C	
09.97 - 04.99	M 52 B 28, M 52 B 28 TU		246-086-001-007C	HLWP	Plug Number (T2): 3b

**M3 3.0 (210 kW | 3.0 Litre)**

10.92 - 01.95	S 50 B 30		246-069-059-001Z	N	
10.92 - 01.95	S 50 B 30		246-080-013-003Z	N-H	

**M3 3.0 (217 kW | 3.0 Litre)**

01.95 - 10.95	S 50 B 30		246-069-059-001Z	N	
01.95 - 10.95	S 50 B 30		246-080-013-003Z	N-H	

**M3 3.2 (236 kW | 3.2 Litre)**

10.95 - 04.99	S 50 B 32		246-069-059-001Z	N	
10.95 - 03.97	S 50 B 32		246-080-013-003Z	N-H	
11.97 - 04.99	S50 B32		246-082-008-025G	SWP-M-C	
09.97 - 04.99	S 50 B 32		246-086-001-007C	HLWP	Plug Number (T2): 3b

**3 Convertible (E36)****318 i (85 kW | 1.8 Litre)**

01.94 - 04.99	M43 B18		246-069-059-001Z	N	
01.94 - 04.99	M43 B18		246-082-008-025G	SWP-M-C	
09.97 - 04.99	M43 B18		246-086-001-007C	HLWP	Plug Number (T2): 3b

**320 i (110 kW | 2.0 Litre)**

12.93 - 04.99	M52 B(20 6 S3) Vanos, M50 B(20 6 S2) Vanos, M50 B20 TU, M50 B20, M52 B20		246-069-059-001Z	N	
12.93 - 11.97	M52 B(20 6 S3) Vanos, M50 B(20 6 S2) Vanos, M50 B20 TU, M50 B20, M52 B20		246-082-008-025G	SWP-M-C	
09.97 - 04.99	M52 B(20 6 S3) Vanos, M50 B(20 6 S2) Vanos, M50 B20 TU, M50 B20, M52 B20		246-086-001-007C	HLWP	Plug Number (T2): 3b

**323 i (125 kW | 2.5 Litre)**

06.95 - 04.99	M52 B25 (Vanos)		246-069-059-001Z	N	
06.95 - 04.99	M52 B25 (Vanos)		246-082-008-025G	SWP-M-C	
09.97 - 04.99	M52 B25 (Vanos)		246-086-001-007C	HLWP	Plug Number (T2): 3b

**325 i (141 kW | 2.5 Litre)**

03.93 - 03.95	M50 B25, M50 B25 TU		246-069-059-001Z	N	
---------------	---------------------	--	------------------	---	--

**328 i (142 kW | 2.8 Litre)**

03.95 - 04.99	M52 B28, M52 B28 TU		246-069-059-001Z	N	
---------------	---------------------	--	------------------	---	--





			<b>VDO</b>		
Date	Engine Code	Chassis No.	Article No.	Product	Information

**BMW****3 Convertible (E36)****328 i (142 kW | 2.8 Litre)**

11.97 → 04.99	M52 B28, M52 B28 TU		246-082-008-025G	SWP-M-C	
09.97 → 04.99	M52 B28, M52 B28 TU		246-086-001-007C	HLWP	Plug Number (T2): 3b

**M3 3.0 (210 kW | 3.0 Litre)**

01.94 → 10.95	S50 B30		246-069-059-001Z	N	
---------------	---------	--	------------------	---	--

**M3 3.2 (236 kW | 3.2 Litre)**

10.95 → 04.99	S50 B32		246-069-059-001Z	N	
10.95 → 04.99	S50 B32		246-082-008-025G	SWP-M-C	
09.97 → 04.99	S 50 B 32		246-086-001-007C	HLWP	Plug Number (T2): 3b

**3 Touring (E36)****316 i (75 kW | 1.6 Litre)**

01.96 → 10.99	M 43 B 16		246-069-059-001Z	N	
01.96 → 03.97	M 43 B 16		246-080-013-003Z	N-H	
11.97 → 10.99	M43 B16		246-082-008-025G	SWP-M-C	
01.96 → 10.99	M43 B16		246-083-002-022G	SWP-D-C	
09.97 → 10.99	M 43 B 16		246-086-001-007C	HLWP	Plug Number (T2): 3b

**318 i (85 kW | 1.8 Litre)**

07.95 → 10.99	M 43 B 18		246-069-059-001Z	N	
07.95 → 03.97	M 43 B 18		246-080-013-003Z	N-H	
07.95 → 10.99	M43 B18		246-082-008-025G	SWP-M-C	
07.95 → 10.99	M43 B18		246-083-002-022G	SWP-D-C	
09.97 → 10.99	M 43 B 18		246-086-001-007C	HLWP	Plug Number (T2): 3b

**318 tds (66 kW | 1.7 Litre)**

01.95 → 10.99	M 41 D 18 (Inter.)		246-069-059-001Z	N	
01.95 → 03.97	M 41 D 18 (Inter.)		246-080-013-003Z	N-H	
01.95 → 10.99	M41 D18 (Inter.)		246-082-008-025G	SWP-M-C	
01.95 → 10.99	M41 D18 (Inter.)		246-083-002-022G	SWP-D-C	
09.97 → 10.99	M 41 D 18 (Inter.)		246-086-001-007C	HLWP	Plug Number (T2): 3b

**320 i (110 kW | 2.0 Litre)**

01.95 → 10.99	M52 B(20 6 S3) Vanos, M50 B20 TU, M50 B20, M52 B20		246-069-059-001Z	N	
01.95 → 10.99	M52 B(20 6 S3) Vanos, M50 B20 TU, M50 B20, M52 B20		246-080-013-003Z	N-H	
01.95 → 10.99	M52 B(20 6 S3) Vanos, M50 B20 TU, M50 B20, M52 B20		246-082-008-025G	SWP-M-C	
01.95 → 10.99	M50 B20, M50 B20 TU, M52 B(20 6 S3) Vanos, M52 B20		246-083-002-022G	SWP-D-C	
09.97 → 10.99	M 50 B 20, M 50 B 20 TU, M 52 B (20 6 S3) Van, M 52 B 20		246-086-001-007C	HLWP	Plug Number (T2): 3b

**323 i (125 kW | 2.5 Litre)**

09.95 → 10.99	M52 B25 (Vanos)		246-069-059-001Z	N	
09.95 → 03.97	M 52 B 25 (Vanos)		246-080-013-003Z	N-H	
09.95 → 10.99	M52 B25 (Vanos)		246-082-008-025G	SWP-M-C	
09.95 → 10.99	M52 B25 (Vanos)		246-083-002-022G	SWP-D-C	
09.97 → 10.99	M 52 B 25 (Vanos)		246-086-001-007C	HLWP	Plug Number (T2): 3b

**325 tds (105 kW | 2.5 Litre)**

01.95 → 10.99	M51 D25 (Inter.)		246-069-059-001Z	N	
01.95 → 03.97	M 51 D 25 (Inter.)		246-080-013-003Z	N-H	
01.95 → 10.99	M51 D25 (Inter.)		246-082-008-025G	SWP-M-C	
01.95 → 10.99	M51 D25 (Inter.)		246-083-002-022G	SWP-D-C	
09.97 → 10.99	M 51 D 25 (Inter.)		246-086-001-007C	HLWP	Plug Number (T2): 3b

**328 i (142 kW | 2.8 Litre)**

01.95 → 10.99	M52 B28, M52 B28 TU		246-069-059-001Z	N	
01.95 → 03.97	M 52 B 28, M 52 B 28 TU		246-080-013-003Z	N-H	
01.95 → 10.99	M52 B28, M52 B28 TU		246-082-008-025G	SWP-M-C	
01.95 → 10.99	M52 B28, M52 B28 TU		246-083-002-022G	SWP-D-C	
09.97 → 10.99	M 52 B 28, M 52 B 28 TU		246-086-001-007C	HLWP	Plug Number (T2): 3b

**3 (E46)****316 i (77 kW | 1.6 Litre)**

04.00 → 02.05	M43 B16 (16 4 E3), M43 B16		246-082-008-025G	SWP-M-C	
04.00 → 02.05	M43 B16 (16 4 E3), M43 B16		246-086-001-007C	HLWP	Plug Number (T2): 3b



			<b>VDO</b>		
Date	Engine Code	Chassis No.	Article No.	Product	Information

**BMW****3 (E46)****316 i (77 kW | 1.9 Litre)**

09.98 - 01.99	M43 164 E3, M43 B19 TU		246-082-008-025G	SWP-M-C	
09.98 - 02.05	M 43 B 19 TU, M43164E3		246-086-001-007C	HLWP	Plug Number (T2): 3b

**316 i (85 kW | 1.6 Litre)**

06.02 - 02.05	N45 B16 A, N45 B16		246-082-008-025G	SWP-M-C	
06.02 - 02.05	N45 B16 A, N45 B16		246-086-001-007C	HLWP	Plug Number (T2): 3b

**316 i (85 kW | 1.8 Litre)**

02.02 - 02.05	N42 B18, N46 B18 A, N46 B18		246-082-008-025G	SWP-M-C	
02.02 - 02.05	N42 B18, N46 B18 A, N46 B18		246-086-001-007C	HLWP	Plug Number (T2): 3b

**318 d (85 kW | 2.0 Litre)**

09.01 - 03.03	M47 204 D1, M47 D20		246-082-008-025G	SWP-M-C	
03.03 - 02.05	M47N 204 D4		246-082-008-025G	SWP-M-C	
09.01 - 03.03	M47 204 D1, M47 D20		246-086-001-007C	HLWP	Plug Number (T2): 3b
03.03 - 02.05	M47N 204 D4		246-086-001-007C	HLWP	Plug Number (T2): 3b

**318 i (105 kW | 2.0 Litre)**

09.01 - 02.05	N42 B20, N46 B20 A, N46 B20		246-082-008-025G	SWP-M-C	
09.01 - 02.05	N42 B20, N46 B20 A, N46 B20		246-086-001-007C	HLWP	Plug Number (T2): 3b

**318 i (87 kW | 1.9 Litre)**

02.98 - 03.98	M43 B19, M43 B19 TU		246-082-008-025G	SWP-M-C	
02.98 - 09.01	M 43 B 19, M 43 B 19 TU		246-086-001-007C	HLWP	Plug Number (T2): 3b

**320 d (100 kW | 2.0 Litre)**

04.98 - 09.01	M47 D20, M47 204 D1		246-082-008-025G	SWP-M-C	
04.98 - 09.01	M47 D20, M47 204 D1		246-086-001-007C	HLWP	Plug Number (T2): 3b

**320 d (110 kW | 2.0 Litre)**

09.01 - 02.05	M47N 204 D4		246-082-008-025G	SWP-M-C	
09.01 - 02.05	M47N 204 D4		246-086-001-007C	HLWP	Plug Number (T2): 3b

**320 i (110 kW | 2.0 Litre)**

03.98 - 09.00	M52 B(20 6 S3) Vanos, M52 B20		246-082-008-025G	SWP-M-C	
03.98 - 09.00	M52 B(20 6 S3) Vanos, M52 B20		246-086-001-007C	HLWP	Plug Number (T2): 3b

**320 i (125 kW | 2.2 Litre)**

09.00 - 02.05	M54 226 S1, M54 B22		246-082-008-025G	SWP-M-C	
09.00 - 02.05	M54 226 S1, M54 B22		246-086-001-007C	HLWP	Plug Number (T2): 3b

**323 i (125 kW | 2.5 Litre)**

03.98 - 09.00	M52 B25 (Vanos), M52 B25 TU		246-082-008-025G	SWP-M-C	
03.98 - 09.00	M52 B25 (Vanos), M52 B25 TU		246-086-001-007C	HLWP	Plug Number (T2): 3b

**325 i (141 kW | 2.5 Litre)**

09.00 - 02.05	M54 256 S5, M54 B25		246-082-008-025G	SWP-M-C	
09.00 - 02.05	M54 256 S5, M54 B25		246-086-001-007C	HLWP	Plug Number (T2): 3b

**325 xi (141 kW | 2.5 Litre)**

09.00 - 02.05	M54 256 S5		246-082-008-025G	SWP-M-C	
09.00 - 02.05	M54 256 S5		246-086-001-007C	HLWP	Plug Number (T2): 3b

**328 i (142 kW | 2.8 Litre)**

02.98 - 06.00	M52 B28		246-082-008-025G	SWP-M-C	
02.98 - 06.00	M52 B28		246-086-001-007C	HLWP	Plug Number (T2): 3b

**330 d (135 kW | 3.0 Litre)**

10.99 - 02.05	M57 D30, M57 306 D1		246-082-008-025G	SWP-M-C	
10.99 - 02.05	M57 D30, M57 306 D1		246-086-001-007C	HLWP	Plug Number (T2): 3b

**330 d (150 kW | 3.0 Litre)**

03.03 - 02.05	M57N 306 D2		246-082-008-025G	SWP-M-C	
03.03 - 02.05	M57N 306 D2		246-086-001-007C	HLWP	Plug Number (T2): 3b

**330 i (170 kW | 3.0 Litre)**

06.00 - 08.00	M54 306 S3, M54 B30		246-082-008-025G	SWP-M-C	
06.00 - 02.05	M54 306 S3, M54 B30		246-086-001-007C	HLWP	Plug Number (T2): 3b

**330 xd (135 kW | 3.0 Litre)**

06.00 - 02.05	M57 D30		246-082-008-025G	SWP-M-C	
06.00 - 02.05	M57 D30		246-086-001-007C	HLWP	Plug Number (T2): 3b

**330 xd (150 kW | 3.0 Litre)**

03.03 - 02.05	M57N 306 D2		246-082-008-025G	SWP-M-C	
03.03 - 02.05	M57N 306 D2		246-086-001-007C	HLWP	Plug Number (T2): 3b

**330 xi (170 kW | 3.0 Litre)**

06.00 - 08.00	M54 306 S3		246-082-008-025G	SWP-M-C	
06.00 - 02.05	M54 306 S3		246-086-001-007C	HLWP	Plug Number (T2): 3b



			<b>VDO</b>		
Date	Engine Code	Chassis No.	Article No.	Product	Information

**BMW****3 Compact (E46)****316 ti (85 kW | 1.8 Litre)**

06.01 - 02.05	N42 B18, N46 B18 A		246-082-008-025G	SWP-M-C	
06.01 - 02.05	N42 B18, N46 B18 A		246-086-001-007C	HLWP	Plug Number (T2): 3b

**318 td (85 kW | 2.0 Litre)**

03.03 - 02.05	M47N 204 D4		246-082-008-025G	SWP-M-C	
03.03 - 02.05	M47N 204 D4		246-086-001-007C	HLWP	Plug Number (T2): 3b

**318 ti (105 kW | 2.0 Litre)**

09.01 - 02.05	N42 B20, N46 B20 A		246-082-008-025G	SWP-M-C	
09.01 - 02.05	N42 B20, N46 B20 A		246-086-001-007C	HLWP	Plug Number (T2): 3b

**320 td (110 kW | 2.0 Litre)**

09.01 - 02.05	M47N 204 D4		246-082-008-025G	SWP-M-C	
09.01 - 02.05	M47N 204 D4		246-086-001-007C	HLWP	Plug Number (T2): 3b

**325 ti (141 kW | 2.5 Litre)**

06.01 - 02.05	M54 256 S5, M54 B25		246-082-008-025G	SWP-M-C	
06.01 - 02.05	M54 256 S5, M54 B25		246-086-001-007C	HLWP	Plug Number (T2): 3b

**3 Coupe (E46)****316 Ci (77 kW | 1.6 Litre)**

04.00 -	M43 B16 (16 4 E3)		246-082-008-025G	SWP-M-C	
04.00 -	M43 B16 (16 4 E3)		246-086-001-007C	HLWP	Plug Number (T2): 3b

**316 Ci (85 kW | 1.6 Litre)**

06.02 -	N45 B16 A		246-082-008-025G	SWP-M-C	
06.02 -	N45 B16 A		246-086-001-007C	HLWP	Plug Number (T2): 3b

**318 Ci (105 kW | 2.0 Litre)**

09.01 -	N42 B20, N46 B20		246-082-008-025G	SWP-M-C	
09.01 -	N42 B20, N46 B20		246-086-001-007C	HLWP	Plug Number (T2): 3b

**318 Ci (110 kW | 2.0 Litre)**

03.05 -	N46 B20 A		246-082-008-025G	SWP-M-C	
03.05 -	N46B20A		246-086-001-007C	HLWP	Plug Number (T2): 3b

**318 Ci (87 kW | 1.9 Litre)**

11.99 - 09.01	M 43 B 19		246-086-001-007C	HLWP	Plug Number (T2): 3b
---------------	-----------	--	------------------	------	----------------------

**320 Cd (110 kW | 2.0 Litre)**

11.03 -	M47N 204 D4		246-082-008-025G	SWP-M-C	
11.03 -	M47N204D4		246-086-001-007C	HLWP	Plug Number (T2): 3b

**320 Ci (110 kW | 2.0 Litre)**

08.99 - 09.00	M52 B(20 6 S4), M52 B20		246-086-001-007C	HLWP	Plug Number (T2): 3b
---------------	-------------------------	--	------------------	------	----------------------

**320 Ci (125 kW | 2.2 Litre)**

09.00 -	M54 226 S1, M54 B22		246-086-001-007C	HLWP	Plug Number (T2): 3b
---------	---------------------	--	------------------	------	----------------------

**323 Ci (125 kW | 2.5 Litre)**

04.99 - 09.00	M52 B25 (Vanos)		246-086-001-007C	HLWP	Plug Number (T2): 3b
---------------	-----------------	--	------------------	------	----------------------

**325 Ci (141 kW | 2.5 Litre)**

09.00 -	M54 256 S5		246-086-001-007C	HLWP	Plug Number (T2): 3b
---------	------------	--	------------------	------	----------------------

**328 Ci (142 kW | 2.8 Litre)**

04.99 - 06.00	M52 B28		246-086-001-007C	HLWP	Plug Number (T2): 3b
---------------	---------	--	------------------	------	----------------------

**330 Cd (150 kW | 3.0 Litre)**

03.03 -	M57N 306 D2		246-082-008-025G	SWP-M-C	
03.03 -	M57N 306 D2		246-086-001-007C	HLWP	Plug Number (T2): 3b

**330 Ci (170 kW | 3.0 Litre)**

06.00 -	M54 306 S3		246-082-008-025G	SWP-M-C	
06.00 -	M54306S3		246-086-001-007C	HLWP	Plug Number (T2): 3b

**330 xi (170 kW | 3.0 Litre)**

06.00 -	M54 306 S3		246-086-001-007C	HLWP	Plug Number (T2): 3b
---------	------------	--	------------------	------	----------------------

**M3 3.2 (252 kW | 3.2 Litre)**

09.01 -	S54 326 S4, S54 B32		246-082-008-025G	SWP-M-C	
06.00 -	S54 326 S4, S54 B32		246-086-001-007C	HLWP	Plug Number (T2): 3b

**M3 CSL (265 kW | 3.2 Litre)**

06.03 -	S54N 326 S4, S54 B32		246-082-008-025G	SWP-M-C	
06.03 -	S54N 326 S4, S54 B32		246-086-001-007C	HLWP	Plug Number (T2): 3b

**3 Convertible (E46)****318 Ci (105 kW | 2.0 Litre)**

09.01 -	N42 B20, N46 B20		246-082-008-025G	SWP-M-C	
09.01 -	N 42 B 20, N 46 B 20		246-086-001-007C	HLWP	Plug Number (T2): 3b



			<b>VDO</b>		
Date	Engine Code	Chassis No.	Article No.	Product	Information

**BMW****3 Convertible (E46)****318 Ci (110 kW | 2.0 Litre)**

02.05 -	N46 B20 B		246-082-008-025G	SWP-M-C	
02.05 -	N46B20B		246-086-001-007C	HLWP	Plug Number (T2): 3b

**320 Cd (110 kW | 2.0 Litre)**

02.05 -	M47N 204 D4		246-082-008-025G	SWP-M-C	
02.05 -	M47N204D4		246-086-001-007C	HLWP	Plug Number (T2): 3b

**320 Ci (125 kW | 2.2 Litre)**

09.00 -	M 54 B 22, M54226S1		246-086-001-007C	HLWP	Plug Number (T2): 3b
---------	---------------------	--	------------------	------	----------------------

**323 Ci (125 kW | 2.5 Litre)**

04.00 - 04.00	M52 B25 (Vanos)		246-082-008-025G	SWP-M-C	
04.00 - 09.00	M 52 B 25 (Vanos)		246-086-001-007C	HLWP	Plug Number (T2): 3b

**325 Ci (141 kW | 2.5 Litre)**

09.00 -	M54256S5		246-086-001-007C	HLWP	Plug Number (T2): 3b
---------	----------	--	------------------	------	----------------------

**330 Cd (150 kW | 3.0 Litre)**

08.05 -	M57N 306 D2		246-082-008-025G	SWP-M-C	
08.05 -	M57N306D2		246-086-001-007C	HLWP	Plug Number (T2): 3b

**330 Ci (170 kW | 3.0 Litre)**

06.00 -	M54 306 S3		246-082-008-025G	SWP-M-C	
06.00 -	M54306S3		246-086-001-007C	HLWP	Plug Number (T2): 3b

**M3 3.2 (252 kW | 3.2 Litre)**

09.01 -	S54 326 S4, S54 B32		246-082-008-025G	SWP-M-C	
---------	---------------------	--	------------------	---------	--

**3 Touring (E46)****316 i (85 kW | 1.6 Litre)**

06.02 - 02.05	N45 B16 A, N45 B16		246-082-008-025G	SWP-M-C	
06.02 - 02.05	N45 B16 A, N45 B16		246-086-001-007C	HLWP	Plug Number (T2): 3b

**316 i (85 kW | 1.8 Litre)**

03.02 - 02.05	N42 B18, N46 B18 A, N46 B18		246-082-008-025G	SWP-M-C	
03.02 - 02.05	N 42 B 18, N 46 B 18, N 46 B 18 A		246-086-001-007C	HLWP	Plug Number (T2): 3b

**318 d (85 kW | 2.0 Litre)**

03.02 - 02.05	M47 204 D1, M47 D20		246-082-008-025G	SWP-M-C	
03.03 - 02.05	M47N 204 D4		246-082-008-025G	SWP-M-C	
03.03 - 02.05	M47N 204 D4		246-086-001-007C	HLWP	Plug Number (T2): 3b

**318 i (105 kW | 2.0 Litre)**

09.01 - 02.05	N42 B20, N46 B20 A, N46 B20		246-082-008-025G	SWP-M-C	
09.01 - 02.05	N 42 B 20, N 46 B 20, N46B20A		246-086-001-007C	HLWP	Plug Number (T2): 3b

**318 i (87 kW | 1.9 Litre)**

10.99 - 09.01	M 43 B 19, M 43 B 19 TU		246-086-001-007C	HLWP	Plug Number (T2): 3b
---------------	-------------------------	--	------------------	------	----------------------

**320 d (100 kW | 2.0 Litre)**

03.00 - 09.01	M47 D20, M47 204 D1		246-082-008-025G	SWP-M-C	
03.00 - 09.01	M 47 D 20, M47204D1		246-086-001-007C	HLWP	Plug Number (T2): 3b

**320 d (110 kW | 2.0 Litre)**

09.01 - 02.05	M47N 204 D4		246-082-008-025G	SWP-M-C	
09.01 - 02.05	M47N204D4		246-086-001-007C	HLWP	Plug Number (T2): 3b

**320 i (110 kW | 2.0 Litre)**

10.99 - 09.00	M 52 B (20 6 S3) Van, M 52 B 20		246-086-001-007C	HLWP	Plug Number (T2): 3b
---------------	---------------------------------	--	------------------	------	----------------------

**320 i (125 kW | 2.2 Litre)**

09.00 - 02.05	M54 226 S1, M54 B22		246-082-008-025G	SWP-M-C	
09.00 - 02.05	M 54 B 22, M54226S1		246-086-001-007C	HLWP	Plug Number (T2): 3b

**325 i (141 kW | 2.5 Litre)**

09.00 - 02.05	M54 256 S5, M54 B25		246-082-008-025G	SWP-M-C	
09.00 - 02.05	M 54 B 25, M54256S5		246-086-001-007C	HLWP	Plug Number (T2): 3b

**325 xi (141 kW | 2.5 Litre)**

09.00 - 02.05	M54 256 S5		246-082-008-025G	SWP-M-C	
09.00 - 02.05	M54256S5		246-086-001-007C	HLWP	Plug Number (T2): 3b

**328 i (142 kW | 2.8 Litre)**

10.99 - 06.00	M 52 B 28		246-086-001-007C	HLWP	Plug Number (T2): 3b
---------------	-----------	--	------------------	------	----------------------

**330 d (135 kW | 3.0 Litre)**

10.99 - 02.05	M57 D30, M57 306 D1		246-082-008-025G	SWP-M-C	
10.99 - 02.05	M 57 D 30, M57306D1		246-086-001-007C	HLWP	Plug Number (T2): 3b

**330 d (150 kW | 3.0 Litre)**

03.03 - 02.05	M57N 306 D2		246-082-008-025G	SWP-M-C	
03.03 - 02.05	M57N 306 D2		246-086-001-007C	HLWP	Plug Number (T2): 3b



			<b>VDO</b>		
Date	Engine Code	Chassis No.	Article No.	Product	Information

**BMW****3 Touring (E46)****330 i (170 kW | 3.0 Litre)**

06.00 - 08.00	M54 306 S3, M54 B30		246-082-008-025G	SWP-M-C	
06.00 - 02.05	M 54 B 30, M54306S3		246-086-001-007C	HLWP	Plug Number (T2): 3b

**330 xd (135 kW | 3.0 Litre)**

06.00 - 02.05	M57 D30		246-082-008-025G	SWP-M-C	
06.00 - 02.05	M 57 D 30		246-086-001-007C	HLWP	Plug Number (T2): 3b

**330 xd (150 kW | 3.0 Litre)**

03.03 - 02.05	M57N 306 D2		246-082-008-025G	SWP-M-C	
03.03 - 02.05	M57N 306 D2		246-086-001-007C	HLWP	Plug Number (T2): 3b

**330 xi (170 kW | 3.0 Litre)**

06.00 - 08.00	M54 306 S3		246-082-008-025G	SWP-M-C	
06.00 - 02.05	M54306S3		246-086-001-007C	HLWP	Plug Number (T2): 3b

**3 (E90)****316 d (85 kW | 2.0 Litre)**

07.09 -			246-086-001-007C	HLWP	Plug Number (T2): 3b
07.09 -	N47 D20 C		A2C53240479Z	SWP-M-C	

**316 i (85 kW | 1.6 Litre)**

02.06 -	N 45 B 16, N 45 B 16 A, N 45 B 16 TU2		246-086-001-007C	HLWP	Plug Number (T2): 3b
02.06 -	N45 B16, N45 B16 A, N45 B16 TU2		A2C53240479Z	SWP-M-C	

**316 i (90 kW | 1.6 Litre)**

09.07 -	N 43 B 16 A		246-086-001-007C	HLWP	Plug Number (T2): 3b
09.07 -	N43 B16 A		A2C53240479Z	SWP-M-C	

**318 d (100 kW | 2.0 Litre)**

07.07 -			246-086-001-007C	HLWP	Plug Number (T2): 3b
07.07 -	N47 D20 C		A2C53240479Z	SWP-M-C	

**318 d (105 kW | 2.0 Litre)**

09.05 -	N47D20A		246-086-001-007C	HLWP	Plug Number (T2): 3b
09.05 -	N47 D20 A, N47 D20 C		A2C53240479Z	SWP-M-C	

**318 d (90 kW | 2.0 Litre)**

09.05 -	M47N204D4		246-086-001-007C	HLWP	Plug Number (T2): 3b
09.05 -	M47N 204 D4		A2C53240479Z	SWP-M-C	

**318 i (105 kW | 2.0 Litre)**

09.07 -	N 43 B 20 A, N 46 B 20 TU2		246-086-001-007C	HLWP	Plug Number (T2): 3b
09.07 -	N43 B20 A		A2C53240479Z	SWP-M-C	

**318 i (95 kW | 2.0 Litre)**

09.05 - 03.07	N 46 B 20, N46B20B		246-086-001-007C	HLWP	Plug Number (T2): 3b
09.05 - 03.07	N46 B20, N46 B20 B		A2C53240479Z	SWP-M-C	

**320 d (110 kW | 2.0 Litre)**

09.05 -	M47N204D4		246-086-001-007C	HLWP	Plug Number (T2): 3b
09.05 -	M47N 204 D4		A2C53240479Z	SWP-M-C	

**320 d (120 kW | 2.0 Litre)**

01.05 -	N47 D20 C		246-082-008-025G	SWP-M-C	
01.05 -	M47N204D4		246-086-001-007C	HLWP	Plug Number (T2): 3b
01.05 -	N47 D20 C		A2C53240479Z	SWP-M-C	

**320 d (130 kW | 2.0 Litre)**

09.07 -	N47D20A		246-086-001-007C	HLWP	Plug Number (T2): 3b
09.07 -	N47 D20 A		A2C53240479Z	SWP-M-C	

**320 d (135 kW | 2.0 Litre)**

01.10 -	N47D20C		246-086-001-007C	HLWP	Plug Number (T2): 3b
01.10 -	N47 D20 C		A2C53240479Z	SWP-M-C	

**320 d xDrive (120 kW | 2.0 Litre)**

07.08 -	N47 D20 C		A2C53240479Z	SWP-M-C	
---------	-----------	--	--------------	---------	--

**320 d xDrive (130 kW | 2.0 Litre)**

09.08 -	N47 D20 C		A2C53240479Z	SWP-M-C	
---------	-----------	--	--------------	---------	--

**320 d xDrive (135 kW | 2.0 Litre)**

01.10 -	N47 D20 C		A2C53240479Z	SWP-M-C	
---------	-----------	--	--------------	---------	--

**320 i (110 kW | 2.0 Litre)**

01.05 - 03.07	N46 B20 A, N46 B20 C, N46 B20		246-082-008-025G	SWP-M-C	
01.05 - 03.07	N 46 B 20, N46B20A, N46B20C		246-086-001-007C	HLWP	Plug Number (T2): 3b
01.05 - 03.07	N46 B20, N46 B20 A, N46 B20 C		A2C53240479Z	SWP-M-C	



			<b>VDO</b>		
Date	Engine Code	Chassis No.	Article No.	Product	Information

**BMW****3 (E90)****320 i (115 kW | 2.0 Litre)**

03.07 → N43 B20 A A2C53240479Z SWP-M-C

**320 i (125 kW | 2.0 Litre)**

09.07 → N 43 B 20 A 246-086-001-007C HLWP Plug Number (T2): 3b

09.07 → N43 B20 A A2C53240479Z SWP-M-C

**320 si (127 kW | 2.0 Litre)**

05.06 → N 45 B 20 A 246-086-001-007C HLWP Plug Number (T2): 3b

05.06 → N45 B20 A A2C53240479Z SWP-M-C

**320 xd (130 kW | 2.0 Litre)**

09.07 → N47 D20 C A2C53240479Z SWP-M-C

**323 i (130 kW | 2.5 Litre)**

04.06 → 06.07 N52B25A, N52NB25A 246-086-001-007C HLWP Plug Number (T2): 3b

04.06 → 06.07 N52 B25 A, N52N B25 A A2C53240479Z SWP-M-C

**323 i (140 kW | 2.5 Litre)**

03.08 → N52 B25 A A2C53240479Z SWP-M-C

**325 d (145 kW | 3.0 Litre)**

09.06 → M57306D3 246-086-001-007C HLWP Plug Number (T2): 3b

09.06 → M57 306 D3 A2C53240479Z SWP-M-C

**325 d (150 kW | 3.0 Litre)**

01.10 → 246-086-001-007C HLWP Plug Number (T2): 3b

01.10 → N57 D30 A A2C53240479Z SWP-M-C

**325 i (141 kW | 2.5 Litre)**

09.07 → 12.08 A2C53240479Z SWP-M-C

**325 i (160 kW | 2.5 Litre)**

01.05 → N52 B25 246-082-008-025G SWP-M-C

01.05 → N 52 B 25, N52B25A 246-086-001-007C HLWP Plug Number (T2): 3b

01.05 → N52 B25, N52 B25 A A2C53240479Z SWP-M-C

**325 i (160 kW | 3.0 Litre)**

09.07 → N 53 B 30, N53B30A 246-086-001-007C HLWP Plug Number (T2): 3b

09.07 → N53 B30, N53 B30 A A2C53240479Z SWP-M-C

**325 i (224 kW | 2.5 Litre)**

09.08 → 12.10 A2C53240479Z SWP-M-C

**325 i xDrive (160 kW | 3.0 Litre)**

09.08 → N53 B30 A A2C53240479Z SWP-M-C

**325 xi (160 kW | 2.5 Litre)**

01.05 → N52B25A 246-086-001-007C HLWP Plug Number (T2): 3b

01.05 → N52 B25 A A2C53240479Z SWP-M-C

**325 xi (160 kW | 3.0 Litre)**

09.07 → N53B30A 246-086-001-007C HLWP Plug Number (T2): 3b

09.07 → N53 B30 A A2C53240479Z SWP-M-C

**328 i (187 kW | 3.0 Litre)**

07.05 → 11.07 N52NB30A 246-086-001-007C HLWP Plug Number (T2): 3b

07.05 → 11.07 N52N B30 A A2C53240479Z SWP-M-C

**330 d (170 kW | 3.0 Litre)**

09.05 → M 57 D 30 TU2, M57306D3 246-086-001-007C HLWP Plug Number (T2): 3b

09.05 → M57 306 D3, M57 D30 TU2 A2C53240479Z SWP-M-C

**330 d (180 kW | 3.0 Litre)**

01.09 → 246-086-001-007C HLWP Plug Number (T2): 3b

01.09 → M57N2 306 D3, N57 D30 A A2C53240479Z SWP-M-C

**330 d xDrive (180 kW | 3.0 Litre)**

01.09 → N57 D30 A A2C53240479Z SWP-M-C

**330 i (175 kW | 3.0 Litre)**

09.06 → 12.07 A2C53240479Z SWP-M-C

**330 i (190 kW | 3.0 Litre)**

01.05 → N52 B30 A 246-082-008-025G SWP-M-C

01.05 → N 52 B 30, N52B30A 246-086-001-007C HLWP Plug Number (T2): 3b

01.05 → N52 B30, N52 B30 A A2C53240479Z SWP-M-C

**330 i (200 kW | 3.0 Litre)**

09.07 → N52B30A, N 53 B 30, N53B30A 246-086-001-007C HLWP Plug Number (T2): 3b

09.07 → N53 B30, N53 B30 A A2C53240479Z SWP-M-C

**330 i xDrive (200 kW | 3.0 Litre)**

09.08 → N53 B30 A A2C53240479Z SWP-M-C



					
Date	Engine Code	Chassis No.	Article No.	Product	Information

**BMW****3 (E90)****330 xd (170 kW | 3.0 Litre)**

09.05 →	M 57 D 30 TU2, M57306D3		246-086-001-007C	HLWP	Plug Number (T2): 3b
09.05 →	M57 306 D3, M57 D30 TU2		A2C53240479Z	SWP-M-C	

**330 xi (190 kW | 3.0 Litre)**

01.05 →	N52B30A		246-086-001-007C	HLWP	Plug Number (T2): 3b
01.05 →	N52 B30 A		A2C53240479Z	SWP-M-C	

**330 xi (200 kW | 3.0 Litre)**

09.07 →	N53B30A		246-086-001-007C	HLWP	Plug Number (T2): 3b
09.07 →	N53 B30 A		A2C53240479Z	SWP-M-C	

**335 d (210 kW | 3.0 Litre)**

09.06 →	M57N306D5		246-086-001-007C	HLWP	Plug Number (T2): 3b
09.06 →	M57N 306 D5		A2C53240479Z	SWP-M-C	

**335 i (220 kW | 3.0 Litre)**

10.06 →			246-086-001-007C	HLWP	Plug Number (T2): 3b
10.06 →	N54 B30 A, N55 B30 A		A2C53240479Z	SWP-M-C	

**335 i (225 kW | 3.0 Litre)**

09.06 →	N54B30A		246-086-001-007C	HLWP	Plug Number (T2): 3b
09.06 →	N54 B30 A, N55 B30 A		A2C53240479Z	SWP-M-C	

**335 i xDrive (225 kW | 3.0 Litre)**

09.08 →	N54 B30 A, N55 B30 A		A2C53240479Z	SWP-M-C	
---------	----------------------	--	--------------	---------	--

**335 xi (225 kW | 3.0 Litre)**

09.07 →	N54B30A		246-086-001-007C	HLWP	Plug Number (T2): 3b
09.07 →	N54 B30 A, N55 B30 A		A2C53240479Z	SWP-M-C	

**M3 4.0 (309 kW | 4.0 Litre)**

03.07 →	S65B40		246-086-001-007C	HLWP	Plug Number (T2): 3b
03.07 →	S65 B40		A2C53240479Z	SWP-M-C	

**3 Touring (E91)****316 d (85 kW | 2.0 Litre)**

09.09 →	N47 D20 C		246-082-008-025G	SWP-M-C	
09.09 →	N47 D20 C		A2C53240479Z	SWP-M-C	Equipment (T11): for windscreen cleaning (T13)

**316 i (90 kW | 1.6 Litre)**

09.07 →	N43 B16 A		246-082-008-025G	SWP-M-C	
09.07 →	N 43 B 16 A		246-086-001-007C	HLWP	Plug Number (T2): 3b
09.07 →	N43 B16 A		A2C53240479Z	SWP-M-C	Equipment (T11): for windscreen cleaning (T13)

**318 d (100 kW | 2.0 Litre)**

07.07 →	N47 D20 C		246-082-008-025G	SWP-M-C	
07.07 →			246-086-001-007C	HLWP	Plug Number (T2): 3b
07.07 →	N47 D20 C		A2C53240479Z	SWP-M-C	Equipment (T11): for windscreen cleaning (T13)

**318 d (105 kW | 2.0 Litre)**

09.07 →	N47 D20 A, N47 D20 C		246-082-008-025G	SWP-M-C	
09.07 →	N47D20A		246-086-001-007C	HLWP	Plug Number (T2): 3b
09.07 →	N47 D20 A, N47 D20 C		A2C53240479Z	SWP-M-C	Equipment (T11): for windscreen cleaning (T13)

**318 d (90 kW | 2.0 Litre)**

09.05 →	M47N 204 D4		246-082-008-025G	SWP-M-C	
09.05 →	M47N204D4		246-086-001-007C	HLWP	Plug Number (T2): 3b
09.05 →	M47N 204 D4		A2C53240479Z	SWP-M-C	Equipment (T11): for windscreen cleaning (T13)

**318 i (100 kW | 2.0 Litre)**

09.07 →	N46 B20 B		A2C53240479Z	SWP-M-C	Equipment (T11): for windscreen cleaning (T13)
---------	-----------	--	--------------	---------	------------------------------------------------

**318 i (105 kW | 2.0 Litre)**

09.07 →	N43 B20 A		246-082-008-025G	SWP-M-C	
09.07 →	N 43 B 20 A, N 46 B 20 TU2		246-086-001-007C	HLWP	Plug Number (T2): 3b
09.07 →	N43 B20 A		A2C53240479Z	SWP-M-C	Equipment (T11): for windscreen cleaning (T13)

**318 i (95 kW | 2.0 Litre)**

01.06 →	N46 B20 B, N46 B20		246-082-008-025G	SWP-M-C	
01.06 →	N 46 B 20, N46B20B		246-086-001-007C	HLWP	Plug Number (T2): 3b
01.06 →	N46 B20, N46 B20 B		A2C53240479Z	SWP-M-C	Equipment (T11): for windscreen cleaning (T13)

**320 d (110 kW | 2.0 Litre)**

09.05 →	M47N 204 D4, M47 D20 TU		246-082-008-025G	SWP-M-C	
09.05 →	M 47 D 20 TU, M47N204D4		246-086-001-007C	HLWP	Plug Number (T2): 3b
09.05 →	M47 D20 TU, M47N 204 D4		A2C53240479Z	SWP-M-C	Equipment (T11): for windscreen cleaning (T13)

**320 d (120 kW | 2.0 Litre)**

09.05 →	M47N 204 D5, N47 D20 A		246-082-008-025G	SWP-M-C	
---------	------------------------	--	------------------	---------	--



			<b>VDO</b>		
Date	Engine Code	Chassis No.	Article No.	Product	Information

**BMW****3 Touring (E91)****320 d (120 kW | 2.0 Litre)**

09.05 →	M47N204D5, N47D20A		246-086-001-007C	HLWP	Plug Number (T2): 3b
09.05 →	M47N 204 D5, N47 D20 A		A2C53240479Z	SWP-M-C	Equipment (T11): for windscreen cleaning (T13)

**320 d (130 kW | 2.0 Litre)**

09.07 →	N47 D20 A		246-082-008-025G	SWP-M-C	
09.07 →	N47D20A		246-086-001-007C	HLWP	Plug Number (T2): 3b
09.07 →	N47 D20 A		A2C53240479Z	SWP-M-C	Equipment (T11): for windscreen cleaning (T13)

**320 d (135 kW | 2.0 Litre)**

01.10 →	N47 D20 C		246-082-008-025G	SWP-M-C	
01.10 →	N47D20C		246-086-001-007C	HLWP	Plug Number (T2): 3b
01.10 →	N47 D20 C		A2C53240479Z	SWP-M-C	Equipment (T11): for windscreen cleaning (T13)

**320 d xDrive (120 kW | 2.0 Litre)**

07.09 →	N47 D20 C		246-082-008-025G	SWP-M-C	
07.09 →	N47 D20 C		A2C53240479Z	SWP-M-C	Equipment (T11): for windscreen cleaning (T13)

**320 d xDrive (135 kW | 2.0 Litre)**

01.10 →	N47 D20 C		246-082-008-025G	SWP-M-C	
01.10 →	N47 D20 C		A2C53240479Z	SWP-M-C	Equipment (T11): for windscreen cleaning (T13)

**320 i (110 kW | 2.0 Litre)**

09.05 →	N46 B20 A, N46 B20 C, N46 B20		246-082-008-025G	SWP-M-C	
09.05 →	N 46 B 20, N46B20A, N46B20C		246-086-001-007C	HLWP	Plug Number (T2): 3b
09.05 →	N46 B20, N46 B20 A, N46 B20 C		A2C53240479Z	SWP-M-C	Equipment (T11): for windscreen cleaning (T13)

**320 i (115 kW | 2.0 Litre)**

09.05 →	N43 B20 A		A2C53240479Z	SWP-M-C	Equipment (T11): for windscreen cleaning (T13)
---------	-----------	--	--------------	---------	------------------------------------------------

**320 i (125 kW | 2.0 Litre)**

09.07 →	N43 B20 A		246-082-008-025G	SWP-M-C	
09.07 →	N 43 B 20 A		246-086-001-007C	HLWP	Plug Number (T2): 3b
09.07 →	N43 B20 A		A2C53240479Z	SWP-M-C	Equipment (T11): for windscreen cleaning (T13)

**320 xd (130 kW | 2.0 Litre)**

09.07 →	N47 D20 A		246-082-008-025G	SWP-M-C	
09.07 →	N47D20A		246-086-001-007C	HLWP	Plug Number (T2): 3b
09.07 →	N47 D20 A		A2C53240479Z	SWP-M-C	Equipment (T11): for windscreen cleaning (T13)

**320d xDrive (130 kW | 2.0 Litre)**

09.08 →	N47 D20 C		246-082-008-025G	SWP-M-C	
09.08 →	N47 D20 C		A2C53240479Z	SWP-M-C	Equipment (T11): for windscreen cleaning (T13)

**323 i (130 kW | 2.5 Litre)**

04.06 → 06.07	N52N B25 A		246-082-008-025G	SWP-M-C	
04.06 → 06.07	N52NB25A		246-086-001-007C	HLWP	Plug Number (T2): 3b
04.06 → 06.07	N52N B25 A		A2C53240479Z	SWP-M-C	Equipment (T11): for windscreen cleaning (T13)

**325 d (145 kW | 3.0 Litre)**

09.06 →	M57 306 D3, M57 D30 TU2		246-082-008-025G	SWP-M-C	
09.06 →	M 57 D 30 TU2, M57306D3		246-086-001-007C	HLWP	Plug Number (T2): 3b
09.06 →	M57 306 D3, M57 D30 TU2		A2C53240479Z	SWP-M-C	Equipment (T11): for windscreen cleaning (T13)

**325 d (150 kW | 3.0 Litre)**

04.10 →	N57 D30 A, M57N2 306 D3		246-082-008-025G	SWP-M-C	
04.10 →			246-086-001-007C	HLWP	Plug Number (T2): 3b
04.10 →	M57N2 306 D3, N57 D30 A		A2C53240479Z	SWP-M-C	Equipment (T11): for windscreen cleaning (T13)

**325 i (155 kW | 2.5 Litre)**

01.12 →	N53 B30 A		A2C53240479Z	SWP-M-C	Equipment (T11): for windscreen cleaning (T13)
---------	-----------	--	--------------	---------	------------------------------------------------

**325 i (160 kW | 2.5 Litre)**

09.05 →	N52 B25 C, N52 B25 A, N52 B25		246-082-008-025G	SWP-M-C	
09.05 →	N 52 B 25, N52B25A, N52B25C		246-086-001-007C	HLWP	Plug Number (T2): 3b
09.05 →	N52 B25, N52 B25 A, N52 B25 C		A2C53240479Z	SWP-M-C	Equipment (T11): for windscreen cleaning (T13)

**325 i (160 kW | 3.0 Litre)**

09.07 →	N53 B30 A, N53 B30		246-082-008-025G	SWP-M-C	
09.07 →	N 53 B 30, N53B30A		246-086-001-007C	HLWP	Plug Number (T2): 3b
09.07 →	N53 B30, N53 B30 A		A2C53240479Z	SWP-M-C	Equipment (T11): for windscreen cleaning (T13)

**325 i xDrive (160 kW | 3.0 Litre)**

09.08 →	N53 B30 A		246-082-008-025G	SWP-M-C	
09.08 →	N53 B30 A		A2C53240479Z	SWP-M-C	Equipment (T11): for windscreen cleaning (T13)

**325 xi (160 kW | 2.5 Litre)**

09.05 →	N52 B25 C		246-082-008-025G	SWP-M-C	
09.05 →	N52B25C		246-086-001-007C	HLWP	Plug Number (T2): 3b
09.05 →	N52 B25 C		A2C53240479Z	SWP-M-C	Equipment (T11): for windscreen cleaning (T13)





			<b>VDO</b>		
Date	Engine Code	Chassis No.	Article No.	Product	Information

**BMW****3 Touring (E91)****325 xi (160 kW | 3.0 Litre)**

09.07 -	N53 B30 A		246-082-008-025G	SWP-M-C	
09.07 -	N53B30A		246-086-001-007C	HLWP	Plug Number (T2): 3b
09.07 -	N53 B30 A		A2C53240479Z	SWP-M-C	Equipment (T11): for windscreen cleaning (T13)

**330 d (170 kW | 3.0 Litre)**

09.05 -	M57 306 D3		246-082-008-025G	SWP-M-C	
09.05 -	M57306D3		246-086-001-007C	HLWP	Plug Number (T2): 3b
09.05 -	M57 306 D3		A2C53240479Z	SWP-M-C	Equipment (T11): for windscreen cleaning (T13)

**330 d (180 kW | 3.0 Litre)**

01.09 -	N57 D30 A, M57N2 306 D3		246-082-008-025G	SWP-M-C	
01.09 -			246-086-001-007C	HLWP	Plug Number (T2): 3b
01.09 -	M57N2 306 D3, N57 D30 A		A2C53240479Z	SWP-M-C	Equipment (T11): for windscreen cleaning (T13)

**330 i (190 kW | 3.0 Litre)**

09.05 -	N52 B30 A, N52 B30		246-082-008-025G	SWP-M-C	
09.05 -	N 52 B 30, N52B30A		246-086-001-007C	HLWP	Plug Number (T2): 3b
09.05 -	N52 B30, N52 B30 A		A2C53240479Z	SWP-M-C	Equipment (T11): for windscreen cleaning (T13)

**330 i (200 kW | 3.0 Litre)**

09.07 -	N53 B30		246-082-008-025G	SWP-M-C	
09.07 -	N52B30A, N 53 B 30		246-086-001-007C	HLWP	Plug Number (T2): 3b
09.07 -	N53 B30		A2C53240479Z	SWP-M-C	Equipment (T11): for windscreen cleaning (T13)

**330 i xDrive (200 kW | 3.0 Litre)**

09.08 -	N53 B30 A		246-082-008-025G	SWP-M-C	
09.08 -	N53 B30 A		A2C53240479Z	SWP-M-C	Equipment (T11): for windscreen cleaning (T13)

**330 xd (170 kW | 3.0 Litre)**

09.05 -	M57 306 D3, M57 D30 TU2		246-082-008-025G	SWP-M-C	
09.05 -	M 57 D 30 TU2, M57306D3		246-086-001-007C	HLWP	Plug Number (T2): 3b
09.05 -	M57 306 D3, M57 D30 TU2		A2C53240479Z	SWP-M-C	Equipment (T11): for windscreen cleaning (T13)

**330 xd (180 kW | 3.0 Litre)**

01.09 -	N57 D30 A, M57N2 306 D3		246-082-008-025G	SWP-M-C	
01.09 -			246-086-001-007C	HLWP	Plug Number (T2): 3b
01.09 -	M57N2 306 D3, N57 D30 A		A2C53240479Z	SWP-M-C	Equipment (T11): for windscreen cleaning (T13)

**330 xi (190 kW | 3.0 Litre)**

09.05 -	N52 B30 A		246-082-008-025G	SWP-M-C	
09.05 -	N52B30A		246-086-001-007C	HLWP	Plug Number (T2): 3b
09.05 -	N52 B30 A		A2C53240479Z	SWP-M-C	Equipment (T11): for windscreen cleaning (T13)

**330 xi (200 kW | 3.0 Litre)**

09.07 -	N53 B30 A		246-082-008-025G	SWP-M-C	
09.07 -	N53B30A		246-086-001-007C	HLWP	Plug Number (T2): 3b
09.07 -	N53 B30 A		A2C53240479Z	SWP-M-C	Equipment (T11): for windscreen cleaning (T13)

**335 d (210 kW | 3.0 Litre)**

09.06 -	M57N 306 D5		246-082-008-025G	SWP-M-C	
09.06 -	M57N306D5		246-086-001-007C	HLWP	Plug Number (T2): 3b
09.06 -	M57N 306 D5		A2C53240479Z	SWP-M-C	Equipment (T11): for windscreen cleaning (T13)

**335 i (225 kW | 3.0 Litre)**

09.06 -	N54 B30 A, N55 B30 A		246-082-008-025G	SWP-M-C	
09.06 -	N54B30A		246-086-001-007C	HLWP	Plug Number (T2): 3b
09.06 -	N54 B30 A, N55 B30 A		A2C53240479Z	SWP-M-C	Equipment (T11): for windscreen cleaning (T13)

**335 i xDrive (225 kW | 3.0 Litre)**

09.08 -	N54 B30 A, N55 B30 A		246-082-008-025G	SWP-M-C	
09.08 -	N54 B30 A, N55 B30 A		A2C53240479Z	SWP-M-C	Equipment (T11): for windscreen cleaning (T13)

**335 xi (225 kW | 3.0 Litre)**

09.07 -	N54 B30 A, N55 B30 A		246-082-008-025G	SWP-M-C	
09.07 -	N54B30A		246-086-001-007C	HLWP	Plug Number (T2): 3b
09.07 -	N54 B30 A, N55 B30 A		A2C53240479Z	SWP-M-C	Equipment (T11): for windscreen cleaning (T13)

**3 Coupe (E92)****316 i (90 kW | 1.6 Litre)**

09.07 -	N43 B16 A		A2C53240479Z	SWP-M-C	
---------	-----------	--	--------------	---------	--

**318 i (105 kW | 2.0 Litre)**

03.10 -	N43 B20 A		A2C53240479Z	SWP-M-C	
---------	-----------	--	--------------	---------	--

**320 d (130 kW | 2.0 Litre)**

03.07 -	N47D20A		246-086-001-007C	HLWP	Plug Number (T2): 3b
03.07 -	N47 D20 A		A2C53240479Z	SWP-M-C	



			<b>VDO</b>		
Date	Engine Code	Chassis No.	Article No.	Product	Information

**BMW****3 Coupe (E92)**

<b>320 d (135 kW   2.0 Litre)</b>					
01.10 -	N47D20C		246-086-001-007C	HLWP	Plug Number (T2): 3b
01.10 -	N47 D20 C		A2C53240479Z	SWP-M-C	
<b>320 d xDrive (130 kW   2.0 Litre)</b>					
09.08 -	N47 D20 C		A2C53240479Z	SWP-M-C	
<b>320 d xDrive (135 kW   2.0 Litre)</b>					
01.10 -	N47 D20 C		A2C53240479Z	SWP-M-C	
<b>320 i (110 kW   2.0 Litre)</b>					
11.06 - 06.07	N46B20A, N46NB20B		246-086-001-007C	HLWP	Plug Number (T2): 3b
11.06 - 06.07	N46 B20 A, N46N B20 B		A2C53240479Z	SWP-M-C	
<b>320 i (115 kW   2.0 Litre)</b>					
06.07 -	N43 B20 A		A2C53240479Z	SWP-M-C	
<b>320 i (125 kW   2.0 Litre)</b>					
03.07 -	N 43 B 20 A		246-086-001-007C	HLWP	Plug Number (T2): 3b
03.07 -	N43 B20 A		A2C53240479Z	SWP-M-C	
<b>320 xd (130 kW   2.0 Litre)</b>					
03.07 -	N47D20A		246-086-001-007C	HLWP	Plug Number (T2): 3b
03.07 -	N47 D20 A		A2C53240479Z	SWP-M-C	
<b>325 d (145 kW   3.0 Litre)</b>					
03.07 -	M 57 D 30 TU2, N57N306D3		246-086-001-007C	HLWP	Plug Number (T2): 3b
03.07 -	M57 D30 TU2, N57N 306 D3		A2C53240479Z	SWP-M-C	
<b>325 d (150 kW   3.0 Litre)</b>					
04.10 -			246-086-001-007C	HLWP	Plug Number (T2): 3b
04.10 -	M57N2 306 D3, N57 D30 A		A2C53240479Z	SWP-M-C	
<b>325 i (160 kW   2.5 Litre)</b>					
09.06 -	N 52 B 25, N52B25A, N52B25C		246-086-001-007C	HLWP	Plug Number (T2): 3b
09.06 -	N52 B25, N52 B25 A, N52 B25 C		A2C53240479Z	SWP-M-C	
<b>325 i (160 kW   3.0 Litre)</b>					
09.07 -	N 53 B 30, N53B30A		246-086-001-007C	HLWP	Plug Number (T2): 3b
09.07 -	N53 B30, N53 B30 A		A2C53240479Z	SWP-M-C	
<b>325 i xDrive (160 kW   3.0 Litre)</b>					
09.08 -	N53 B30 A		A2C53240479Z	SWP-M-C	
<b>325 xi (160 kW   2.5 Litre)</b>					
09.06 -	N52B25A, N52B25C		246-086-001-007C	HLWP	Plug Number (T2): 3b
09.06 -	N52 B25 A, N52 B25 C		A2C53240479Z	SWP-M-C	
<b>325 xi (160 kW   3.0 Litre)</b>					
09.07 -	N53B30A		246-086-001-007C	HLWP	Plug Number (T2): 3b
09.07 -	N53 B30 A		A2C53240479Z	SWP-M-C	
<b>328 i (187 kW   3.0 Litre)</b>					
08.06 - 11.07	N52NB30A		246-086-001-007C	HLWP	Plug Number (T2): 3b
08.06 - 11.07	N52N B30 A		A2C53240479Z	SWP-M-C	
<b>330 d (170 kW   3.0 Litre)</b>					
09.06 -	M 57 D 30 TU2, M57306D3		246-086-001-007C	HLWP	Plug Number (T2): 3b
09.06 -	M57 306 D3, M57 D30 TU2		A2C53240479Z	SWP-M-C	
<b>330 d (180 kW   3.0 Litre)</b>					
01.09 -			246-086-001-007C	HLWP	Plug Number (T2): 3b
01.09 -	M57N2 306 D3, N57 D30 A		A2C53240479Z	SWP-M-C	
<b>330 d xDrive (180 kW   3.0 Litre)</b>					
01.09 -	N57 D30 A		A2C53240479Z	SWP-M-C	
<b>330 i (190 kW   3.0 Litre)</b>					
09.06 -	N52 B30 A		A2C53240479Z	SWP-M-C	
<b>330 i (200 kW   3.0 Litre)</b>					
09.06 -	N52B30A, N 53 B 30, N53B30A		246-086-001-007C	HLWP	Plug Number (T2): 3b
09.06 -	N53 B30, N53 B30 A		A2C53240479Z	SWP-M-C	
<b>330 i xDrive (200 kW   3.0 Litre)</b>					
09.08 -	N53 B30 A		A2C53240479Z	SWP-M-C	
<b>330 xd (170 kW   3.0 Litre)</b>					
09.06 -	M 57 D 30 TU2, M57306D3		246-086-001-007C	HLWP	Plug Number (T2): 3b
09.06 -	M57 306 D3, M57 D30 TU2		A2C53240479Z	SWP-M-C	
<b>330 xd X (180 kW   3.0 Litre)</b>					
01.09 -			246-086-001-007C	HLWP	Plug Number (T2): 3b
01.09 -	M57N2 306 D3, N57 D30 A		A2C53240479Z	SWP-M-C	



Date	Engine Code	Chassis No.	Article No.	Product	Information

**BMW****3 Coupe (E92)****330 xi (190 kW | 3.0 Litre)**

09.06 → N52 B30 A A2C53240479Z SWP-M-C

**330 xi (200 kW | 3.0 Litre)**

09.06 → N52B30A 246-086-001-007C HLWP Plug Number (T2): 3b

09.06 → N52 B30 A A2C53240479Z SWP-M-C

**335 d (210 kW | 3.0 Litre)**

09.06 → M57N306D5 246-086-001-007C HLWP Plug Number (T2): 3b

09.06 → M57N 306 D5 A2C53240479Z SWP-M-C

**335 i (225 kW | 3.0 Litre)**

09.06 → N54B30A 246-086-001-007C HLWP Plug Number (T2): 3b

09.06 → N54 B30 A, N55 B30 A A2C53240479Z SWP-M-C

**335 i xDrive (225 kW | 3.0 Litre)**

09.08 → N54 B30 A, N55 B30 A A2C53240479Z SWP-M-C

**335 xi (225 kW | 3.0 Litre)**

09.06 → N54B30A 246-086-001-007C HLWP Plug Number (T2): 3b

09.06 → N54 B30 A, N55 B30 A A2C53240479Z SWP-M-C

**M3 4.0 (309 kW | 4.0 Litre)**

03.07 → S65B40 246-086-001-007C HLWP Plug Number (T2): 3b

03.07 → S65 B40 A2C53240479Z SWP-M-C

**M3 GTS (331 kW | 4.4 Litre)**

03.07 → S65 B44 A A2C53240479Z SWP-M-C

**3 Convertible (E93)****318 i (105 kW | 2.0 Litre)**

03.10 → N43 B20 A A2C53240479Z SWP-M-C

**320 d (130 kW | 2.0 Litre)**

03.07 → N47D20A 246-086-001-007C HLWP Plug Number (T2): 3b

03.07 → N47 D20 A A2C53240479Z SWP-M-C

**320 d (135 kW | 2.0 Litre)**

01.10 → N47D20C 246-086-001-007C HLWP Plug Number (T2): 3b

01.10 → N47 D20 C A2C53240479Z SWP-M-C

**320 i (110 kW | 2.0 Litre)**

03.07 → 08.07 N 46 B 20, N46NB20B 246-086-001-007C HLWP Plug Number (T2): 3b

03.07 → 08.07 N46 B20, N46N B20 B A2C53240479Z SWP-M-C

**320 i (125 kW | 2.0 Litre)**

03.07 → N 43 B 20 A 246-086-001-007C HLWP Plug Number (T2): 3b

03.07 → N43 B20 A A2C53240479Z SWP-M-C

**325 d (145 kW | 3.0 Litre)**

03.07 → M 57 D 30 TU2, N57306D3 246-086-001-007C HLWP Plug Number (T2): 3b

03.07 → M57 D30 TU2, N57 306 D3 A2C53240479Z SWP-M-C

**325 d (150 kW | 3.0 Litre)**

03.10 → N57 D30 A A2C53240479Z SWP-M-C

**325 i (160 kW | 2.5 Litre)**

03.07 → N 52 B 25, N52B25A 246-086-001-007C HLWP Plug Number (T2): 3b

03.07 → N52 B25, N52 B25 A A2C53240479Z SWP-M-C

**325 i (160 kW | 3.0 Litre)**

03.07 → N 53 B 30, N53B30A 246-086-001-007C HLWP Plug Number (T2): 3b

03.07 → N53 B30, N53 B30 A A2C53240479Z SWP-M-C

**330 d (170 kW | 3.0 Litre)**

03.07 → M 57 D 30 TU2, N57N306D3 246-086-001-007C HLWP Plug Number (T2): 3b

03.07 → M57 D30 TU2, N57N 306 D3 A2C53240479Z SWP-M-C

**330 d (180 kW | 3.0 Litre)**

01.09 → 246-086-001-007C HLWP Plug Number (T2): 3b

01.09 → M57N2 306 D3, N57 D30 A A2C53240479Z SWP-M-C

**330 i (190 kW | 3.0 Litre)**

03.07 → N52N B30 B A2C53240479Z SWP-M-C

**330 i (200 kW | 3.0 Litre)**

03.07 → N52B30A, N 53 B 30, N53B30A 246-086-001-007C HLWP Plug Number (T2): 3b

03.07 → N53 B30, N53 B30 A A2C53240479Z SWP-M-C

**335 i (225 kW | 3.0 Litre)**

03.07 → N54B30A, N54B30B 246-086-001-007C HLWP Plug Number (T2): 3b

03.07 → N54 B30 A, N54 B30 B, N55 B30 A A2C53240479Z SWP-M-C



					
Date	Engine Code	Chassis No.	Article No.	Product	Information

**BMW****3 Convertible (E93)****M3 4.0 (309 kW | 4.0 Litre)**

03.07 --	S65B40		246-086-001-007C	HLWP	Plug Number (T2): 3b
03.07 --	S65 B40		A2C53240479Z	SWP-M-C	

**3 (F30)****2.3 D1dI (182 kW | 2.3 Litre)**

01.12 --			A2C53240479Z	SWP-M-C	Equipment (T11): for rear windscreen cleaning (T14)
01.12 --			A2C53304876	HLWP	

**316 d (85 kW | 2.0 Litre)**

02.12 --	N47 D20 C		A2C53240479Z	SWP-M-C	Equipment (T11): for rear windscreen cleaning (T14)
02.12 --	N47 D20 C		A2C53304876	HLWP	

**318 d (105 kW | 2.0 Litre)**

02.12 --	N47 D20 C		A2C53240479Z	SWP-M-C	Equipment (T11): for rear windscreen cleaning (T14)
02.12 --	N47 D20 C		A2C53304876	HLWP	

**320 d (120 kW | 2.0 Litre)**

10.11 --	N47 D20 C		A2C53240479Z	SWP-M-C	Equipment (T11): for rear windscreen cleaning (T14)
10.11 --	N47 D20 C		A2C53304876	HLWP	

**320 d (135 kW | 2.0 Litre)**

10.11 --	N47 D20 C		A2C53240479Z	SWP-M-C	Equipment (T11): for rear windscreen cleaning (T14)
10.11 --	N47 D20 C		A2C53304876	HLWP	

**320 i (135 kW | 2.0 Litre)**

02.12 --	N20 B20 A		A2C53240479Z	SWP-M-C	Equipment (T11): for rear windscreen cleaning (T14)
02.12 --	N20 B20 A		A2C53304876	HLWP	

**320 i xDrive (135 kW | 2.0 Litre)**

11.11 --	N20 B20 A		A2C53240479Z	SWP-M-C	Equipment (T11): for rear windscreen cleaning (T14)
11.11 --	N20 B20 A		A2C53304876	HLWP	

**328 i (180 kW | 2.0 Litre)**

10.11 --	N20 B20 A, N26 B20 A		A2C53240479Z	SWP-M-C	Equipment (T11): for rear windscreen cleaning (T14)
10.11 --	N20 B20 A, N26 B20 A		A2C53304876	HLWP	

**335 i (225 kW | 3.0 Litre)**

10.11 --	N55 B30 A		A2C53240479Z	SWP-M-C	Equipment (T11): for rear windscreen cleaning (T14)
10.11 --	N55 B30 A		A2C53304876	HLWP	

**3 Touring (F31)****316 d (85 kW | 2.0 Litre)**

06.12 --	N47 D20 C		A2C53240479Z	SWP-M-C	Equipment (T11): for rear windscreen cleaning (T14)
06.12 --	N47 D20 C		A2C53304876	HLWP	

**318 d (105 kW | 2.0 Litre)**

06.12 --	N47 D20 C		A2C53240479Z	SWP-M-C	Equipment (T11): for rear windscreen cleaning (T14)
06.12 --	N47 D20 C		A2C53304876	HLWP	

**320 d (135 kW | 2.0 Litre)**

06.12 --	N47 D20 C		A2C53240479Z	SWP-M-C	Equipment (T11): for rear windscreen cleaning (T14)
06.12 --	N47 D20 C		A2C53304876	HLWP	

**320 i (135 kW | 2.0 Litre)**

06.12 --	N20 B20 B		A2C53240479Z	SWP-M-C	Equipment (T11): for rear windscreen cleaning (T14)
06.12 --	N20 B20 B		A2C53304876	HLWP	

**328 i (180 kW | 2.0 Litre)**

06.12 --	N20 B20 A		A2C53240479Z	SWP-M-C	Equipment (T11): for rear windscreen cleaning (T14)
06.12 --	N20 B20 A		A2C53304876	HLWP	



			<b>VDO</b>		
Date	Engine Code	Chassis No.	Article No.	Product	Information

**BMW****3 Touring (F31)****330 d (190 kW | 3.0 Litre)**

06.12 -	N57 D30 A		A2C53240479Z	SWP-M-C	Equipment (T11): for rear windscreen cleaning (T14)
06.12 -	N57 D30 A		A2C53304876	HLWP	

**5 (E12)****518 (66 kW | 1.8 Litre)**

07.74 - 05.81	M10 B18		246-075-023-004C	SWP-M-G	Plug Number (T2): 1
---------------	---------	--	------------------	---------	---------------------

**520 (85 kW | 2.0 Litre)**

08.72 - 08.77	M10 B20		246-075-023-004C	SWP-M-G	Plug Number (T2): 1
---------------	---------	--	------------------	---------	---------------------

**520 i (92 kW | 2.0 Litre)**

08.76 - 05.77	M10 B20		246-075-023-004C	SWP-M-G	Plug Number (T2): 1
---------------	---------	--	------------------	---------	---------------------

**520 i (96 kW | 2.0 Litre)**

10.72 - 10.75	M10 B20		246-075-023-004C	SWP-M-G	Plug Number (T2): 1
---------------	---------	--	------------------	---------	---------------------

**520/6 (90 kW | 2.0 Litre)**

09.77 - 05.81	M20 B20		246-075-023-004C	SWP-M-G	Plug Number (T2): 1
---------------	---------	--	------------------	---------	---------------------

**525 (107 kW | 2.5 Litre)**

08.73 - 10.76	M30 B25		246-075-023-004C	SWP-M-G	Plug Number (T2): 1
---------------	---------	--	------------------	---------	---------------------

**525 (110 kW | 2.5 Litre)**

08.76 - 05.81	M30 B25		246-075-023-004C	SWP-M-G	Plug Number (T2): 1
---------------	---------	--	------------------	---------	---------------------

**528 (121 kW | 2.8 Litre)**

01.75 - 07.77	M30 B28		246-075-023-004C	SWP-M-G	Plug Number (T2): 1
---------------	---------	--	------------------	---------	---------------------

**528 (125 kW | 2.8 Litre)**

01.75 - 08.77	M 30 B 28		246-075-023-004C	SWP-M-G	Plug Number (T2): 1
---------------	-----------	--	------------------	---------	---------------------

**528 i (130 kW | 2.8 Litre)**

04.77 - 05.81	M30 B28		246-075-023-004C	SWP-M-G	Plug Number (T2): 1
---------------	---------	--	------------------	---------	---------------------

**528 i (135 kW | 2.8 Litre)**

04.77 - 05.81	M 30 B 28		246-075-023-004C	SWP-M-G	Plug Number (T2): 1
---------------	-----------	--	------------------	---------	---------------------

**M 3.4 (160 kW | 3.4 Litre)**

06.80 - 05.81	M30 B35 (Motronic,9.3:1)		246-075-023-004C	SWP-M-G	Plug Number (T2): 1
---------------	--------------------------	--	------------------	---------	---------------------

**5 (E34)****518 i (83 kW | 1.8 Litre)**

08.89 - 09.95	M 40 B 18		246-069-059-001Z	N	
---------------	-----------	--	------------------	---	--

09.90 - 09.95	M 40 B 18		246-080-013-003Z	N-H	
---------------	-----------	--	------------------	-----	--

**518 i (85 kW | 1.8 Litre)**

08.89 - 09.95	M 43 B 18		246-069-059-001Z	N	
---------------	-----------	--	------------------	---	--

09.90 - 09.95	M 43 B 18		246-080-013-003Z	N-H	
---------------	-----------	--	------------------	-----	--

**520 i (95 kW | 2.0 Litre)**

01.88 - 08.91	M20 B20		246-069-059-001Z	N	
---------------	---------	--	------------------	---	--

01.88 - 08.91	M20 B20		246-080-013-001Z	N-H	
---------------	---------	--	------------------	-----	--

09.90 - 08.91	M20 B20		246-080-013-003Z	N-H	
---------------	---------	--	------------------	-----	--

**520 i 24V (110 kW | 2.0 Litre)**

09.89 - 09.95	M50 B(20 6 S1), M50 B(20 6 S2) Vanos, M50 B20 TU, M50 B20		246-069-059-001Z	N	
---------------	-----------------------------------------------------------------	--	------------------	---	--

09.89 - 09.95	M50 B(20 6 S1), M50 B(20 6 S2) Vanos, M50 B20 TU, M50 B20		246-080-013-001Z	N-H	
---------------	-----------------------------------------------------------------	--	------------------	-----	--

09.90 - 09.95	M50 B(20 6 S1), M50 B(20 6 S2) Vanos, M50 B20 TU, M50 B20		246-080-013-003Z	N-H	
---------------	-----------------------------------------------------------------	--	------------------	-----	--

09.90 - 09.95	M50 B(20 6 S1), M50 B(20 6 S2) Vanos, M50 B20 TU, M50 B20		246-080-013-003Z	N-H	
---------------	-----------------------------------------------------------------	--	------------------	-----	--

09.90 - 09.95	M50 B(20 6 S1), M50 B(20 6 S2) Vanos, M50 B20 TU, M50 B20		246-080-013-003Z	N-H	
---------------	-----------------------------------------------------------------	--	------------------	-----	--

09.90 - 09.95	M50 B(20 6 S1), M50 B(20 6 S2) Vanos, M50 B20 TU, M50 B20		246-080-013-003Z	N-H	
---------------	-----------------------------------------------------------------	--	------------------	-----	--

09.90 - 09.95	M50 B(20 6 S1), M50 B(20 6 S2) Vanos, M50 B20 TU, M50 B20		246-080-013-003Z	N-H	
---------------	-----------------------------------------------------------------	--	------------------	-----	--

09.90 - 09.95	M50 B(20 6 S1), M50 B(20 6 S2) Vanos, M50 B20 TU, M50 B20		246-080-013-003Z	N-H	
---------------	-----------------------------------------------------------------	--	------------------	-----	--

09.90 - 09.95	M50 B(20 6 S1), M50 B(20 6 S2) Vanos, M50 B20 TU, M50 B20		246-080-013-003Z	N-H	
---------------	-----------------------------------------------------------------	--	------------------	-----	--

09.90 - 09.95	M50 B(20 6 S1), M50 B(20 6 S2) Vanos, M50 B20 TU, M50 B20		246-080-013-003Z	N-H	
---------------	-----------------------------------------------------------------	--	------------------	-----	--

09.90 - 09.95	M50 B(20 6 S1), M50 B(20 6 S2) Vanos, M50 B20 TU, M50 B20		246-080-013-003Z	N-H	
---------------	-----------------------------------------------------------------	--	------------------	-----	--

09.90 - 09.95	M50 B(20 6 S1), M50 B(20 6 S2) Vanos, M50 B20 TU, M50 B20		246-080-013-003Z	N-H	
---------------	-----------------------------------------------------------------	--	------------------	-----	--

09.90 - 09.95	M50 B(20 6 S1), M50 B(20 6 S2) Vanos, M50 B20 TU, M50 B20		246-080-013-003Z	N-H	
---------------	-----------------------------------------------------------------	--	------------------	-----	--

09.90 - 09.95	M50 B(20 6 S1), M50 B(20 6 S2) Vanos, M50 B20 TU, M50 B20		246-080-013-003Z	N-H	
---------------	-----------------------------------------------------------------	--	------------------	-----	--

09.90 - 09.95	M50 B(20 6 S1), M50 B(20 6 S2) Vanos, M50 B20 TU, M50 B20		246-080-013-003Z	N-H	
---------------	-----------------------------------------------------------------	--	------------------	-----	--

09.90 - 09.95	M50 B(20 6 S1), M50 B(20 6 S2) Vanos, M50 B20 TU, M50 B20		246-080-013-003Z	N-H	
---------------	-----------------------------------------------------------------	--	------------------	-----	--

09.90 - 09.95	M50 B(20 6 S1), M50 B(20 6 S2) Vanos, M50 B20 TU, M50 B20		246-080-013-003Z	N-H	
---------------	-----------------------------------------------------------------	--	------------------	-----	--

09.90 - 09.95	M50 B(20 6 S1), M50 B(20 6 S2) Vanos, M50 B20 TU, M50 B20		246-080-013-003Z	N-H	
---------------	-----------------------------------------------------------------	--	------------------	-----	--

09.90 - 09.95	M50 B(20 6 S1), M50 B(20 6 S2) Vanos, M50 B20 TU, M50 B20		246-080-013-003Z	N-H	
---------------	-----------------------------------------------------------------	--	------------------	-----	--

09.90 - 09.95	M50 B(20 6 S1), M50 B(20 6 S2) Vanos, M50 B20 TU, M50 B20		246-080-013-003Z	N-H	
---------------	-----------------------------------------------------------------	--	------------------	-----	--



			<b>VDO</b>	
Date	Engine Code	Chassis No.	Article No.	Product Information

**BMW****5 (E34)****525 iX 24V (141 kW | 2.5 Litre)**

10.91 → 09.95 M52 B25 (Vanos)

246-069-059-001Z

N

10.91 → 09.95 M52 B25 (Vanos)

246-080-013-003Z

N-H

**525 td (85 kW | 2.5 Litre)**

04.93 → 09.95 M51 D25

246-069-059-001Z

N

04.93 → 09.95 M 51 D 25

246-080-013-003Z

N-H

**525 tds (105 kW | 2.5 Litre)**

09.91 → 09.95 M51 D25 (Inter.)

246-069-059-001Z

N

09.91 → 09.95 M 51 D 25 (Inter.)

246-080-013-003Z

N-H

**530 i (138 kW | 3.0 Litre)**

01.88 → 08.91 M30 B30

246-069-059-001Z

N

**530 i V8 (160 kW | 3.0 Litre)**

09.92 → 09.95 M60 B30

246-069-059-001Z

N

09.92 → 09.95 M 60 B 30

246-080-013-003Z

N-H

**535 i (155 kW | 3.4 Litre)**

01.88 → 09.95 M30 B35

246-069-059-001Z

N

09.90 → 09.95 M 30 B 35

246-080-013-003Z

N-H

**540 i V8 (210 kW | 4.0 Litre)**

09.92 → 09.95 M60 B40

246-069-059-001Z

N

09.92 → 09.95 M 60 B 40

246-080-013-003Z

N-H

**M 3.6 (232 kW | 3.6 Litre)**

10.88 → 05.92 S38 B36

246-069-059-001Z

N

**M 3.6 CAT (232 kW | 3.6 Litre)**

10.88 → 05.92 S38 B36

246-069-059-001Z

N

09.90 → 05.92 S 38 B 36 (Kat)

246-080-013-003Z

N-H

**M 3.8 (250 kW | 3.8 Litre)**

03.92 → 09.95 S38 B38

246-069-059-001Z

N

03.92 → 09.95 S 38 B 38

246-080-013-003Z

N-H

**5 Touring (E34)****518 g (85 kW | 1.8 Litre)**

11.95 → 06.96 M 43 B 18

246-069-059-001Z

N

11.95 → 06.96 M 43 B 18

246-080-013-003Z

N-H

**518 i (83 kW | 1.8 Litre)**

03.93 → 09.94 M 40 B 18

246-069-059-001Z

N

03.93 → 09.94 M 40 B 18

246-080-013-003Z

N-H

**518 i (85 kW | 1.8 Litre)**

09.94 → 01.97 M 43 B 18

246-069-059-001Z

N

09.94 → 01.97 M 43 B 18

246-080-013-003Z

N-H

**520 i (110 kW | 2.0 Litre)**11.91 → 01.97 M 50 B (20 6 S1),  
M 50 B (20 6 S2) Van, M 50 B 20,  
M 50 B 20 TU

246-069-059-001Z

N

11.91 → 01.97 M 50 B (20 6 S1),  
M 50 B (20 6 S2) Van, M 50 B 20,  
M 50 B 20 TU

246-080-013-003Z

N-H

**525 i (141 kW | 2.5 Litre)**

11.91 → 01.97 M 50 B 25, M 50 B 25 TU

246-069-059-001Z

N

11.91 → 01.97 M 50 B 25, M 50 B 25 TU

246-080-013-003Z

N-H

**525 ix (141 kW | 2.5 Litre)**

02.92 → 01.97 M 50 B 25, M 52 B 25 (Vanos)

246-069-059-001Z

N

02.92 → 01.97 M 50 B 25, M 52 B 25 (Vanos)

246-080-013-003Z

N-H

**525 td (85 kW | 2.5 Litre)**

03.93 → 01.97 M 51 D 25

246-069-059-001Z

N

03.93 → 01.97 M 51 D 25

246-080-013-003Z

N-H

**525 tds (105 kW | 2.5 Litre)**

12.91 → 01.97 M 51 D 25 (Inter.)

246-069-059-001Z

N

12.91 → 01.97 M 51 D 25 (Inter.)

246-080-013-003Z

N-H

**530 i V8 (160 kW | 3.0 Litre)**

09.92 → 01.97 M 60 B 30

246-069-059-001Z

N

09.92 → 01.97 M 60 B 30

246-080-013-003Z

N-H

**540 i (210 kW | 4.0 Litre)**

09.93 → 01.97 M 60 B 40

246-069-059-001Z

N



			<b>VDO</b>		
Date	Engine Code	Chassis No.	Article No.	Product	Information

**BMW****5 Touring (E34)****540 i (210 kW | 4.0 Litre)**

09.93 - 01.97 M 60 B 40

246-080-013-003Z

N-H

**M 3.8 (250 kW | 3.8 Litre)**

09.94 - 01.97 S 38 B 38

246-080-013-003Z

N-H

**5 (E39)****520 d (100 kW | 2.0 Litre)**

02.00 - 06.03 M47 D20, M47 204 D1

246-082-008-025G

SWP-M-C

02.00 - 06.03 M47 D20, M47 204 D1

246-086-001-007C

HLWP

Plug Number (T2): 3b

**520 i (100 kW | 2.0 Litre)**

04.99 - 06.03 M52 B(20 6 S3) Vanos

246-082-008-025G

SWP-M-C

04.99 - 06.03 M52 B(20 6 S3) Vanos

246-086-001-007C

HLWP

Plug Number (T2): 3b

**520 i (110 kW | 2.0 Litre)**09.97 - 09.00 M52 B(20 6 S3) Vanos,  
M52 B(20 6 S4), M52 B20

246-082-008-025G

SWP-M-C

09.97 - 09.00 M52 B(20 6 S3) Vanos,  
M52 B(20 6 S4), M52 B20

246-086-001-007C

HLWP

Plug Number (T2): 3b

**520 i (125 kW | 2.2 Litre)**

09.00 - 06.03 M54 B22

246-082-008-025G

SWP-M-C

09.00 - 06.03 M54 B22

246-086-001-007C

HLWP

Plug Number (T2): 3b

**523 i (125 kW | 2.5 Litre)**

09.97 - 09.00 M52 B25 (Vanos), M52 B25 TU

246-082-008-025G

SWP-M-C

09.97 - 09.00 M52 B25 (Vanos), M52 B25 TU

246-086-001-007C

HLWP

Plug Number (T2): 3b

**525 d (120 kW | 2.5 Litre)**

02.00 - 06.03 M57 256 D1, M57 D25

246-082-008-025G

SWP-M-C

02.00 - 06.03 M57 256 D1, M57 D25

246-086-001-007C

HLWP

Plug Number (T2): 3b

**525 i (141 kW | 2.5 Litre)**

09.00 - 06.03 M54 256 S5, M54 B25

246-082-008-025G

SWP-M-C

09.00 - 06.03 M54 256 S5, M54 B25

246-086-001-007C

HLWP

Plug Number (T2): 3b

**525 td (85 kW | 2.5 Litre)**

09.97 - 06.03 M51 D25

246-082-008-025G

SWP-M-C

09.97 - 06.03 M51 D25

246-086-001-007C

HLWP

Plug Number (T2): 3b

**525 tds (105 kW | 2.5 Litre)**

09.97 - 06.03 M51 D25 (Inter.)

246-082-008-025G

SWP-M-C

09.97 - 06.03 M51 D25 (Inter.)

246-086-001-007C

HLWP

Plug Number (T2): 3b

**528 i (142 kW | 2.8 Litre)**

09.97 - 09.00 M52 B28, M52 B28 TU

246-082-008-025G

SWP-M-C

09.97 - 09.00 M52 B28, M52 B28 TU

246-086-001-007C

HLWP

Plug Number (T2): 3b

**530 d (135 kW | 3.0 Litre)**

08.98 - 09.00 M57 D30

246-082-008-025G

SWP-M-C

08.98 - 09.00 M57 D30

246-086-001-007C

HLWP

Plug Number (T2): 3b

**530 d (142 kW | 3.0 Litre)**

09.00 - 06.03 M57 D30

246-082-008-025G

SWP-M-C

09.00 - 06.03 M57 D30

246-086-001-007C

HLWP

Plug Number (T2): 3b

**530 i (170 kW | 3.0 Litre)**

09.00 - 06.03 M54 306 S3, M54 B30

246-082-008-025G

SWP-M-C

09.00 - 06.03 M54 306 S3, M54 B30

246-086-001-007C

HLWP

Plug Number (T2): 3b

**535 i (173 kW | 3.5 Litre)**

09.97 - 03.99 M62 B(35 8 S1), M62 B35

246-082-008-025G

SWP-M-C

09.97 - 03.99 M62 B(35 8 S1), M62 B35

246-086-001-007C

HLWP

Plug Number (T2): 3b

**535 i (180 kW | 3.5 Litre)**

04.99 - 06.03 M62 B(35 8 S2), M62 B35 TU

246-082-008-025G

SWP-M-C

04.99 - 06.03 M62 B(35 8 S2), M62 B35 TU

246-086-001-007C

HLWP

Plug Number (T2): 3b

**540 i (210 kW | 4.4 Litre)**09.97 - 06.03 M62 B44, M62 448 S2,  
M62 B44 TU

246-082-008-025G

SWP-M-C

09.97 - 06.03 M62 B44, M62 448 S2,  
M62 B44 TU

246-086-001-007C

HLWP

Plug Number (T2): 3b

**M 4.9 (294 kW | 4.9 Litre)**

10.98 - 06.03 S38 B49, S62 B50

246-082-008-025G

SWP-M-C

10.98 - 06.03 S38 B49, S62 B50

246-086-001-007C

HLWP

Plug Number (T2): 3b



			<b>VDO</b>		
Date	Engine Code	Chassis No.	Article No.	Product	Information

**BMW****5 Touring (E39)**

<b>520 d (100 kW   2.0 Litre)</b>					
02.00 - 09.03	M47 D20, M47 204 D1		246-082-008-025G	SWP-M-C	
02.00 - 09.03	M47 D20, M47 204 D1		246-086-001-007C	HLWP	Plug Number (T2): 3b
<b>520 i (100 kW   2.0 Litre)</b>					
04.99 - 05.04	M52 B(20 6 S3) Vanos		246-082-008-025G	SWP-M-C	
04.99 - 05.04	M52 B(20 6 S3) Vanos		246-086-001-007C	HLWP	Plug Number (T2): 3b
<b>520 i (110 kW   2.0 Litre)</b>					
09.97 - 09.00	M52 B(20 6 S3) Vanos, M52 B(20 6 S4), M52 B20		246-082-008-025G	SWP-M-C	
01.97 - 09.00	M52 B(20 6 S3) Vanos, M52 B(20 6 S4), M52 B20		246-086-001-007C	HLWP	Plug Number (T2): 3b
<b>520 i (125 kW   2.2 Litre)</b>					
09.00 - 05.04	M54 B22		246-082-008-025G	SWP-M-C	
09.00 - 05.04	M54 B22		246-086-001-007C	HLWP	Plug Number (T2): 3b
<b>523 i (125 kW   2.5 Litre)</b>					
09.97 - 09.00	M52 B25 (Vanos), M52 B25 TU		246-082-008-025G	SWP-M-C	
01.97 - 09.00	M52 B25 (Vanos), M52 B25 TU		246-086-001-007C	HLWP	Plug Number (T2): 3b
<b>525 d (120 kW   2.5 Litre)</b>					
02.00 - 05.04	M57 256 D1, M57 D25		246-082-008-025G	SWP-M-C	
02.00 - 05.04	M57 256 D1, M57 D25		246-086-001-007C	HLWP	Plug Number (T2): 3b
<b>525 i (141 kW   2.5 Litre)</b>					
09.00 - 05.04	M54 256 S5, M54 B25		246-082-008-025G	SWP-M-C	
09.00 - 05.04	M54 256 S5, M54 B25		246-086-001-007C	HLWP	Plug Number (T2): 3b
<b>525 tds (105 kW   2.5 Litre)</b>					
03.97 - 05.04	M51 D25 (Inter.)		246-082-008-025G	SWP-M-C	
03.97 - 05.04	M51 D25 (Inter.)		246-086-001-007C	HLWP	Plug Number (T2): 3b
<b>528 i (142 kW   2.8 Litre)</b>					
09.97 - 09.00	M52 B28, M52 B28 TU		246-082-008-025G	SWP-M-C	
01.97 - 09.00	M52 B28, M52 B28 TU		246-086-001-007C	HLWP	Plug Number (T2): 3b
<b>530 d (135 kW   3.0 Litre)</b>					
08.98 - 09.00	M57 D30		246-082-008-025G	SWP-M-C	
08.98 - 09.00	M57 D30		246-086-001-007C	HLWP	Plug Number (T2): 3b
<b>530 d (142 kW   3.0 Litre)</b>					
09.00 - 05.04	M57 D30		246-082-008-025G	SWP-M-C	
09.00 - 05.04	M57 D30		246-086-001-007C	HLWP	Plug Number (T2): 3b
<b>530 i (170 kW   3.0 Litre)</b>					
09.00 - 05.04	M54 306 S3, M54 B30		246-082-008-025G	SWP-M-C	
09.00 - 05.04	M54 306 S3, M54 B30		246-086-001-007C	HLWP	Plug Number (T2): 3b
<b>540 i (210 kW   4.4 Litre)</b>					
09.97 - 05.04	M62 B44, M62 448 S2, M62 B44 TU		246-082-008-025G	SWP-M-C	
01.97 - 05.04	M62 B44, M62 448 S2, M62 B44 TU		246-086-001-007C	HLWP	Plug Number (T2): 3b

**5 (E60)**

<b>520 d (110 kW   2.0 Litre)</b>					
09.05 - 03.10	M47N204D4		246-086-001-007C	HLWP	Plug Number (T2): 3b
09.05 - 03.10	M47N 204 D4		A2C53240479Z	SWP-M-C	
<b>520 d (120 kW   2.0 Litre)</b>					
07.05 - 03.10	M47N204D5, N47D20A		246-086-001-007C	HLWP	Plug Number (T2): 3b
07.05 - 03.10	M47N 204 D5, N47 D20 A		A2C53240479Z	SWP-M-C	
<b>520 d (130 kW   2.0 Litre)</b>					
09.07 - 03.10	M47N204D4, N47D20A		246-086-001-007C	HLWP	Plug Number (T2): 3b
09.07 - 03.10	M47N 204 D4, N47 D20 A, N47 D20 C		A2C53240479Z	SWP-M-C	
<b>520 i (125 kW   2.0 Litre)</b>					
09.07 - 03.10	N 43 B 20 A		246-086-001-007C	HLWP	Plug Number (T2): 3b
09.07 - 03.10	N43 B20 A		A2C53240479Z	SWP-M-C	
<b>520 i (125 kW   2.2 Litre)</b>					
07.03 - 09.03	M54 226 S1, M54 B22		246-082-008-025G	SWP-M-C	
07.03 - 03.10	M54 226 S1, M54 B22		246-086-001-007C	HLWP	Plug Number (T2): 3b
09.03 - 03.10	M54 226 S1, M54 B22		A2C53240479Z	SWP-M-C	





			<b>VDO</b>		
Date	Engine Code	Chassis No.	Article No.	Product	Information

**BMW****5 (E60)****523 i (130 kW | 2.5 Litre)**

07.05 - 03.10	N52 B25 A, N52 B25		246-086-001-007C	HLWP	Plug Number (T2): 3b
07.05 - 03.10	N52 B25, N52 B25 A		A2C53240479Z	SWP-M-C	

**523 i (140 kW | 2.5 Litre)**

01.07 - 03.10	N52B25A		246-086-001-007C	HLWP	Plug Number (T2): 3b
01.07 - 03.10	N52 B25 A		A2C53240479Z	SWP-M-C	

**525 d (120 kW | 2.5 Litre)**

12.04 - 03.10	M57256D1		246-086-001-007C	HLWP	Plug Number (T2): 3b
12.04 - 03.10	M57 256 D1		A2C53240479Z	SWP-M-C	

**525 d (130 kW | 2.5 Litre)**

06.04 - 03.10	M57N 256 D4, M57 D25 TU		246-086-001-007C	HLWP	Plug Number (T2): 3b
06.04 - 03.10	M57 D25 TU, M57N 256 D4		A2C53240479Z	SWP-M-C	

**525 d (145 kW | 3.0 Litre)**

01.07 - 03.10	M57306D3		246-086-001-007C	HLWP	Plug Number (T2): 3b
01.07 - 03.10	M57 306 D3		A2C53240479Z	SWP-M-C	

**525 d xDrive (145 kW | 3.0 Litre)**

09.08 - 03.10	N57 306 D3		A2C53240479Z	SWP-M-C	
---------------	------------	--	--------------	---------	--

**525 i (137 kW | 2.5 Litre)**

09.07 - 12.09			A2C53240479Z	SWP-M-C	
---------------	--	--	--------------	---------	--

**525 i (141 kW | 2.5 Litre)**

09.03 - 09.03	M54 256 S5, M54 B25		246-082-008-025G	SWP-M-C	
09.03 - 03.10	M54 256 S5, M54 B25		246-086-001-007C	HLWP	Plug Number (T2): 3b
09.03 - 03.10	M54 256 S5, M54 B25		A2C53240479Z	SWP-M-C	

**525 i (160 kW | 2.5 Litre)**

07.05 - 03.10	N52 B25 A, N52 B25		246-086-001-007C	HLWP	Plug Number (T2): 3b
07.05 - 03.10	N52 B25, N52 B25 A		A2C53240479Z	SWP-M-C	

**525 i (160 kW | 3.0 Litre)**

01.07 - 03.10	N 53 B 30, N53B30A		246-086-001-007C	HLWP	Plug Number (T2): 3b
01.07 - 03.10	N53 B30, N53 B30 A		A2C53240479Z	SWP-M-C	

**525 i xDrive (160 kW | 3.0 Litre)**

09.08 - 03.10	N53 B30 A		A2C53240479Z	SWP-M-C	
---------------	-----------	--	--------------	---------	--

**525 xd (145 kW | 3.0 Litre)**

01.07 - 03.10	M57306D3		246-086-001-007C	HLWP	Plug Number (T2): 3b
01.07 - 03.10	M57 306 D3		A2C53240479Z	SWP-M-C	

**525 xi (160 kW | 2.5 Litre)**

07.05 - 03.10	N52B25A		246-086-001-007C	HLWP	Plug Number (T2): 3b
07.05 - 03.10	N52 B25 A		A2C53240479Z	SWP-M-C	

**525 xi (160 kW | 3.0 Litre)**

01.07 - 03.10	N53B30A		246-086-001-007C	HLWP	Plug Number (T2): 3b
01.07 - 03.10	N53 B30 A		A2C53240479Z	SWP-M-C	

**530 d (155 kW | 3.0 Litre)**

09.03 - 03.10	M57 D30 (306D2), M57 D30 (306D3)		A2C53240479Z	SWP-M-C	
---------------	-------------------------------------	--	--------------	---------	--

**530 d (160 kW | 3.0 Litre)**

07.03 - 09.03	N57 306 D2		246-082-008-025G	SWP-M-C	
07.03 - 03.10	N57 306 D2		246-086-001-007C	HLWP	Plug Number (T2): 3b
09.03 - 03.10	N57 306 D2		A2C53240479Z	SWP-M-C	

**530 d (170 kW | 3.0 Litre)**

07.03 - 09.03	M57 306 D3		246-082-008-025G	SWP-M-C	
07.03 - 03.10	M57 306 D3		246-086-001-007C	HLWP	Plug Number (T2): 3b
09.03 - 03.10	M57 306 D3		A2C53240479Z	SWP-M-C	

**530 d (173 kW | 3.0 Litre)**

01.07 - 03.10	M57306D3		246-086-001-007C	HLWP	Plug Number (T2): 3b
01.07 - 03.10	M57 306 D3		A2C53240479Z	SWP-M-C	

**530 d xDrive (173 kW | 3.0 Litre)**

09.08 - 03.10	M57N2 306 D3		A2C53240479Z	SWP-M-C	
---------------	--------------	--	--------------	---------	--

**530 i (168 kW | 3.0 Litre)**

09.07 - 12.08			A2C53240479Z	SWP-M-C	
---------------	--	--	--------------	---------	--

**530 i (170 kW | 3.0 Litre)**

07.03 - 09.03	M54 306 S3, M54 B30		246-082-008-025G	SWP-M-C	
07.03 - 03.10	M54 306 S3, M54 B30		246-086-001-007C	HLWP	Plug Number (T2): 3b
09.03 - 03.10	M54 306 S3, M54 B30		A2C53240479Z	SWP-M-C	



			<b>VDO</b>		
Date	Engine Code	Chassis No.	Article No.	Product	Information

**BMW****5 (E60)****530 i (187 kW | 3.0 Litre)**

03.05 - 03.10 N52 B30 A

A2C53240479Z

SWP-M-C

**530 i (190 kW | 3.0 Litre)**

07.05 - 03.10 N52 B30 A, N52 B30

246-086-001-007C

HLWP

Plug Number (T2): 3b

07.05 - 03.10 N52 B30, N52 B30 A

A2C53240479Z

SWP-M-C

**530 i (200 kW | 3.0 Litre)**

01.07 - 03.10 N52B30A, N 53 B 30, N53B30A

246-086-001-007C

HLWP

Plug Number (T2): 3b

01.07 - 03.10 N53 B30, N53 B30 A

A2C53240479Z

SWP-M-C

**530 i (224 kW | 3.0 Litre)**

09.08 - 12.09

A2C53240479Z

SWP-M-C

**530 i xDrive (200 kW | 3.0 Litre)**

09.08 - 03.10 N53 B30 A

A2C53240479Z

SWP-M-C

**530 xd (170 kW | 3.0 Litre)**

07.05 - 03.10 M57306D3

246-086-001-007C

HLWP

Plug Number (T2): 3b

07.05 - 03.10 M57 306 D3

A2C53240479Z

SWP-M-C

**530 xd (173 kW | 3.0 Litre)**

01.07 - 03.10 M57306D3

246-086-001-007C

HLWP

Plug Number (T2): 3b

01.07 - 03.10 M57 306 D3

A2C53240479Z

SWP-M-C

**530 xi (190 kW | 3.0 Litre)**

07.05 - 03.10 N52B30A

246-086-001-007C

HLWP

Plug Number (T2): 3b

07.05 - 03.10 N52 B30 A

A2C53240479Z

SWP-M-C

**530 xi (200 kW | 3.0 Litre)**

01.07 - 03.10 N52B30A, N53B30A

246-086-001-007C

HLWP

Plug Number (T2): 3b

01.07 - 03.10 N53 B30 A

A2C53240479Z

SWP-M-C

**535 d (200 kW | 3.0 Litre)**

09.04 - 03.10 M57306D4

246-086-001-007C

HLWP

Plug Number (T2): 3b

09.04 - 03.10 M57 306 D4

A2C53240479Z

SWP-M-C

**535 d (210 kW | 3.0 Litre)**

01.07 - 03.10 M57N306D5

246-086-001-007C

HLWP

Plug Number (T2): 3b

01.07 - 03.10 M57N 306 D5

A2C53240479Z

SWP-M-C

**540 i (225 kW | 3.0 Litre)**

08.05 - 03.10

A2C53240479Z

SWP-M-C

**540 i (225 kW | 4.0 Litre)**

07.05 - 03.10 N62B40A

246-086-001-007C

HLWP

Plug Number (T2): 3b

07.05 - 03.10 N62 B40 A

A2C53240479Z

SWP-M-C

**545 i (245 kW | 4.4 Litre)**

09.03 - 09.03 N62 B44

246-082-008-025G

SWP-M-C

09.03 - 03.10 N62 B44

246-086-001-007C

HLWP

Plug Number (T2): 3b

09.03 - 03.10 N62 B44

A2C53240479Z

SWP-M-C

**550 i (270 kW | 4.8 Litre)**

07.05 - 03.10 N62B48B

246-086-001-007C

HLWP

Plug Number (T2): 3b

07.05 - 03.10 N62 B48 B

A2C53240479Z

SWP-M-C

**M (373 kW | 5.0 Litre)**

09.04 - 03.10 S85 B50 A

246-086-001-007C

HLWP

Plug Number (T2): 3b

09.04 - 03.10 S85 B50 A

A2C53240479Z

SWP-M-C

**5 Touring (E61)****520 d (110 kW | 2.0 Litre)**

09.05 - M47N204D4

246-086-001-007C

HLWP

Plug Number (T2): 3b

09.05 - M47N 204 D4

A2C53240479Z

SWP-M-C

**520 d (120 kW | 2.0 Litre)**

07.05 - M47N204D5, N47D20A

246-086-001-007C

HLWP

Plug Number (T2): 3b

07.05 - M47N 204 D5, N47 D20 A

A2C53240479Z

SWP-M-C

**520 d (130 kW | 2.0 Litre)**

09.07 - N47D20A

246-086-001-007C

HLWP

Plug Number (T2): 3b

09.07 - N47 D20 A, N47 D20 C

A2C53240479Z

SWP-M-C

**520 i (125 kW | 2.0 Litre)**

09.07 - N 43 B 20 A

246-086-001-007C

HLWP

Plug Number (T2): 3b

09.07 - N43 B20 A

A2C53240479Z

SWP-M-C

**520 i (125 kW | 2.2 Litre)**

06.04 - M54 226 S1

A2C53240479Z

SWP-M-C

**523 i (130 kW | 2.5 Litre)**

07.05 - N52 B25 A, N52 B25

246-082-008-025G

SWP-M-C



			<b>VDO</b>		
Date	Engine Code	Chassis No.	Article No.	Product	Information

**BMW****5 Touring (E61)**

<b>523 i (130 kW   2.5 Litre)</b>					
07.05 →	N52 B25 A, N52 B25		246-086-001-007C	HLWP	Plug Number (T2): 3b
07.05 →	N52 B25, N52 B25 A		A2C53240479Z	SWP-M-C	
<b>523 i (140 kW   2.5 Litre)</b>					
01.07 →	N52B25A		246-086-001-007C	HLWP	Plug Number (T2): 3b
01.07 →	N52 B25 A		A2C53240479Z	SWP-M-C	
<b>525 d (120 kW   2.5 Litre)</b>					
12.04 →	M57N256D4		246-086-001-007C	HLWP	Plug Number (T2): 3b
12.04 →	M57N 256 D4		A2C53240479Z	SWP-M-C	
<b>525 d (130 kW   2.5 Litre)</b>					
06.04 →	M57N 256 D4, M57 D25 TU		246-082-008-025G	SWP-M-C	
06.04 →	M57N 256 D4, M57 D25 TU		246-086-001-007C	HLWP	Plug Number (T2): 3b
06.04 →	M57 D25 TU, M57N 256 D4		A2C53240479Z	SWP-M-C	
<b>525 d (145 kW   3.0 Litre)</b>					
01.07 →	M57306D3		246-086-001-007C	HLWP	Plug Number (T2): 3b
01.07 →	M57 306 D3		A2C53240479Z	SWP-M-C	
<b>525 d xDrive (145 kW   3.0 Litre)</b>					
09.08 →	N57 306 D3		A2C53240479Z	SWP-M-C	
<b>525 i (141 kW   2.5 Litre)</b>					
06.04 →	M54 256 S5, M54 B25		246-082-008-025G	SWP-M-C	
06.04 →	M54 256 S5, M54 B25		246-086-001-007C	HLWP	Plug Number (T2): 3b
06.04 →	M54 256 S5, M54 B25		A2C53240479Z	SWP-M-C	
<b>525 i (160 kW   2.5 Litre)</b>					
07.05 →	N52 B25 A, N52 B25		246-082-008-025G	SWP-M-C	
07.05 →	N52 B25 A, N52 B25		246-086-001-007C	HLWP	Plug Number (T2): 3b
07.05 →	N52 B25, N52 B25 A		A2C53240479Z	SWP-M-C	
<b>525 i (160 kW   3.0 Litre)</b>					
01.07 →	N 53 B 30, N53B30A		246-086-001-007C	HLWP	Plug Number (T2): 3b
01.07 →	N53 B30, N53 B30 A		A2C53240479Z	SWP-M-C	
<b>525 i xDrive (160 kW   3.0 Litre)</b>					
09.08 →	N53 B30 A		A2C53240479Z	SWP-M-C	
<b>525 xd (145 kW   3.0 Litre)</b>					
01.07 →	M57306D3		246-086-001-007C	HLWP	Plug Number (T2): 3b
01.07 →	M57 306 D3		A2C53240479Z	SWP-M-C	
<b>525 xi (160 kW   2.5 Litre)</b>					
07.05 →	N52B25A		246-086-001-007C	HLWP	Plug Number (T2): 3b
07.05 →	N52 B25 A		A2C53240479Z	SWP-M-C	
<b>525 xi (160 kW   3.0 Litre)</b>					
01.07 →	N53B30A		246-086-001-007C	HLWP	Plug Number (T2): 3b
01.07 →	N53 B30 A		A2C53240479Z	SWP-M-C	
<b>530 d (160 kW   3.0 Litre)</b>					
06.04 →	N57 306 D2		246-082-008-025G	SWP-M-C	
06.04 →	N57 306 D2		246-086-001-007C	HLWP	Plug Number (T2): 3b
06.04 →	N57 306 D2		A2C53240479Z	SWP-M-C	
<b>530 d (170 kW   3.0 Litre)</b>					
07.05 →	M57 306 D3		246-082-008-025G	SWP-M-C	
07.05 →	M57 306 D3		246-086-001-007C	HLWP	Plug Number (T2): 3b
07.05 →	M57 306 D3		A2C53240479Z	SWP-M-C	
<b>530 d (173 kW   3.0 Litre)</b>					
01.07 →	M57306D3		246-086-001-007C	HLWP	Plug Number (T2): 3b
01.07 →	M57 306 D3		A2C53240479Z	SWP-M-C	
<b>530 d xDrive (173 kW   3.0 Litre)</b>					
09.08 →	M57N2 306 D3		A2C53240479Z	SWP-M-C	
<b>530 i (170 kW   3.0 Litre)</b>					
06.04 →	M54 306 S3, M54 B30		246-082-008-025G	SWP-M-C	
06.04 →	M54 306 S3, M54 B30		246-086-001-007C	HLWP	Plug Number (T2): 3b
06.04 →	M54 306 S3, M54 B30		A2C53240479Z	SWP-M-C	
<b>530 i (190 kW   3.0 Litre)</b>					
07.05 →	N52 B30 A, N52 B30		246-082-008-025G	SWP-M-C	
07.05 →	N52 B30 A, N52 B30		246-086-001-007C	HLWP	Plug Number (T2): 3b
07.05 →	N52 B30, N52 B30 A		A2C53240479Z	SWP-M-C	
<b>530 i (200 kW   3.0 Litre)</b>					
01.07 →	N52B30A, N 53 B 30, N53B30A		246-086-001-007C	HLWP	Plug Number (T2): 3b



			<b>VDO</b>		
Date	Engine Code	Chassis No.	Article No.	Product	Information

**BMW****5 Touring (E61)****530 i (200 kW | 3.0 Litre)**

01.07 → N53 B30, N53 B30 A A2C53240479Z SWP-M-C

**530 i xDrive (200 kW | 3.0 Litre)**

09.08 → N53 B30 A A2C53240479Z SWP-M-C

**530 xd (170 kW | 3.0 Litre)**

07.05 → M57306D3 246-086-001-007C HLWP Plug Number (T2): 3b

07.05 → M57 306 D3 A2C53240479Z SWP-M-C

**530 xd (173 kW | 3.0 Litre)**

01.07 → M57306D3 246-086-001-007C HLWP Plug Number (T2): 3b

01.07 → M57 306 D3 A2C53240479Z SWP-M-C

**530 xi (190 kW | 3.0 Litre)**

07.05 → N52B30A 246-086-001-007C HLWP Plug Number (T2): 3b

07.05 → N52 B30 A A2C53240479Z SWP-M-C

**530 xi (200 kW | 3.0 Litre)**

01.07 → N53B30A 246-086-001-007C HLWP Plug Number (T2): 3b

01.07 → N53 B30 A A2C53240479Z SWP-M-C

**535 d (200 kW | 3.0 Litre)**

09.04 → M57 306 D4 246-082-008-025G SWP-M-C

09.04 → M57 306 D4 246-086-001-007C HLWP Plug Number (T2): 3b

09.04 → M57 306 D4 A2C53240479Z SWP-M-C

**535 d (210 kW | 3.0 Litre)**

01.07 → M57N306D5 246-086-001-007C HLWP Plug Number (T2): 3b

01.07 → M57N 306 D5 A2C53240479Z SWP-M-C

**545 i (245 kW | 4.4 Litre)**

06.04 → N62 B44 246-082-008-025G SWP-M-C

06.04 → N62 B44 246-086-001-007C HLWP Plug Number (T2): 3b

06.04 → N62 B44 A2C53240479Z SWP-M-C

**550 i (270 kW | 4.8 Litre)**

07.05 → N62B48A, N62B48B 246-086-001-007C HLWP Plug Number (T2): 3b

07.05 → N62 B48 A, N62 B48 B A2C53240479Z SWP-M-C

**M (373 kW | 5.0 Litre)**

02.07 → S85B50A 246-086-001-007C HLWP Plug Number (T2): 3b

02.07 → S85 B50 A A2C53240479Z SWP-M-C

**5 GRAN TURISMO (F07)****530 d (155 kW | 3.0 Litre)**

07.10 → N57 D30 A A2C53240479Z SWP-M-C

07.10 → N57 D30 A A2C53304876 HLWP

**530 d (180 kW | 3.0 Litre)**

10.09 → N57 D30 A A2C53240479Z SWP-M-C

10.09 → N57 D30 A A2C53304876 HLWP

**530 d xDrive (180 kW | 3.0 Litre)**

09.10 → N57 D30 A A2C53240479Z SWP-M-C

09.10 → N57 D30 A A2C53304876 HLWP

**535 d (220 kW | 3.0 Litre)**

09.10 → N57S D30 B A2C53240479Z SWP-M-C

09.10 → N57S D30 B A2C53304876 HLWP

**535 d xDrive (220 kW | 3.0 Litre)**

09.10 → N57S D30 B A2C53240479Z SWP-M-C

09.10 → N57S D30 B A2C53304876 HLWP

**535 i (225 kW | 3.0 Litre)**

10.09 → N55 B30 A A2C53240479Z SWP-M-C

10.09 → N55 B30 A A2C53304876 HLWP

**535 i xDrive (225 kW | 3.0 Litre)**

09.10 → N55 B30 A A2C53240479Z SWP-M-C

09.10 → N55 B30 A A2C53304876 HLWP

**550 i (300 kW | 4.4 Litre)**

10.09 → N63 B44 A A2C53240479Z SWP-M-C

10.09 → N63 B44 A A2C53304876 HLWP

**550 i xDrive (300 kW | 4.4 Litre)**

09.10 → N63 B44 A A2C53240479Z SWP-M-C

09.10 → N63 B44 A A2C53304876 HLWP



			<b>VDO</b>		
Date	Engine Code	Chassis No.	Article No.	Product	Information

**BMW****5 (F10)****520 d (135 kW | 2.0 Litre)**

03.10 →	N47 D20 C		A2C53240479Z	SWP-M-C	
03.10 →	N47 D20 C		A2C53304876	HLWP	

**520 i (120 kW | 2.0 Litre)**

09.11 →	N20 B20 A		A2C53240479Z	SWP-M-C	
09.11 →	N20 B20 A		A2C53304876	HLWP	

**520 i (135 kW | 2.0 Litre)**

09.11 →	N20 B20 A		A2C53240479Z	SWP-M-C	
09.11 →	N20 B20 A		A2C53304876	HLWP	

**523 i (150 kW | 3.0 Litre)**

03.10 →	N53 B30 A		A2C53240479Z	SWP-M-C	
03.10 →	N53 B30 A		A2C53304876	HLWP	

**525 d (150 kW | 3.0 Litre)**

03.10 →	N57 D30 A		A2C53240479Z	SWP-M-C	
03.10 →	N57 D30 A		A2C53304876	HLWP	

**525 d (155 kW | 2.0 Litre)**

09.11 →	N47 D20 D		A2C53240479Z	SWP-M-C	
09.11 →	N47 D20 D		A2C53304876	HLWP	

**525 d (160 kW | 2.0 Litre)**

09.11 →	N47 D20 D		A2C53240479Z	SWP-M-C	
09.11 →	N47 D20 D		A2C53304876	HLWP	

**525 d xDrive (155 kW | 2.0 Litre)**

09.11 →	N47 D20 D		A2C53240479Z	SWP-M-C	
09.11 →	N47 D20 D		A2C53304876	HLWP	

**525 d xDrive (160 kW | 2.0 Litre)**

09.11 →	N47 D20 D		A2C53240479Z	SWP-M-C	
09.11 →	N47 D20 D		A2C53304876	HLWP	

**528 i (180 kW | 2.0 Litre)**

09.11 →	N20 B20 A		A2C53240479Z	SWP-M-C	
09.11 →	N20 B20 A		A2C53304876	HLWP	

**528 i (190 kW | 3.0 Litre)**

03.10 →	N53 B30 A		A2C53240479Z	SWP-M-C	
03.10 →	N53 B30 A		A2C53304876	HLWP	

**528 i xDrive (180 kW | 2.0 Litre)**

09.11 →	N20 B20 A		A2C53240479Z	SWP-M-C	
09.11 →	N20 B20 A		A2C53304876	HLWP	

**530 d (180 kW | 3.0 Litre)**

03.10 →	N57 D30 A		A2C53240479Z	SWP-M-C	
03.10 →	N57 D30 A		A2C53304876	HLWP	

**530 d (190 kW | 3.0 Litre)**

09.11 →	N57 D30 A		A2C53240479Z	SWP-M-C	
09.11 →	N57 D30 A		A2C53304876	HLWP	

**530 d xDrive (190 kW | 3.0 Litre)**

09.11 →	N57 D30 A		A2C53240479Z	SWP-M-C	
09.11 →	N57 D30 A		A2C53304876	HLWP	

**530 i (200 kW | 3.0 Litre)**

09.11 →	N53 B30 A		A2C53240479Z	SWP-M-C	
09.11 →	N53 B30 A		A2C53304876	HLWP	

**535 d (220 kW | 3.0 Litre)**

09.10 →	N57S D30 B		A2C53240479Z	SWP-M-C	
09.10 →	N57S D30 B		A2C53304876	HLWP	

**535 d (230 kW | 3.0 Litre)**

09.11 →	N57 D30 B		A2C53240479Z	SWP-M-C	
09.11 →	N57 D30 B		A2C53304876	HLWP	

**535 d xDrive (230 kW | 3.0 Litre)**

09.11 →	N57 D30 B		A2C53240479Z	SWP-M-C	
09.11 →	N57 D30 B		A2C53304876	HLWP	

**535 i (225 kW | 3.0 Litre)**

03.10 →	N55 B30 A		A2C53240479Z	SWP-M-C	
03.10 →	N55 B30 A		A2C53304876	HLWP	

**535 i xDrive (225 kW | 3.0 Litre)**

03.10 →	N55 B30 A		A2C53240479Z	SWP-M-C	
03.10 →	N55 B30 A		A2C53304876	HLWP	



			<b>VDO</b>		
Date	Engine Code	Chassis No.	Article No.	Product	Information

**BMW****5 (F10)****550 i (300 kW | 4.4 Litre)**

03.10 →	N63 B44 A		A2C53240479Z	SWP-M-C	
03.10 →	N63 B44 A		A2C53304876	HLWP	

**550 i xDrive (300 kW | 4.4 Litre)**

09.10 →	N63 B44 A		A2C53240479Z	SWP-M-C	
09.10 →	N63 B44 A		A2C53304876	HLWP	

**ActiveHybrid (250 kW | 3.0 Litre)**

09.11 →	N55 B30 A		A2C53240479Z	SWP-M-C	
09.11 →	N55 B30 A		A2C53304876	HLWP	

**M (412 kW | 4.4 Litre)**

06.11 →	S63 B44 A		A2C53240479Z	SWP-M-C	
06.11 →	S63 B44 A		A2C53304876	HLWP	

**M 550 d xDrive (280 kW | 3.0 Litre)**

01.12 →	N57 D30 C		A2C53240479Z	SWP-M-C	
01.12 →	N57 D30 C		A2C53304876	HLWP	

**5 Touring (F11)****520 d (135 kW | 2.0 Litre)**

09.10 →	N47 D20 C		246-082-008-025G	SWP-M-C	
09.10 →	N47 D20 C		A2C53240479Z	SWP-M-C	
09.10 →	N47 D20 C		A2C53304876	HLWP	

**520 i (135 kW | 2.0 Litre)**

09.11 →	N20 B20 A		A2C53240479Z	SWP-M-C	
09.11 →	N20 B20 A		A2C53304876	HLWP	

**523 i (150 kW | 3.0 Litre)**

09.10 →	N53 B30 A		246-082-008-025G	SWP-M-C	
09.10 →	N53 B30 A		A2C53240479Z	SWP-M-C	
09.10 →	N53 B30 A		A2C53304876	HLWP	

**525 d (150 kW | 3.0 Litre)**

09.10 →	N57 D30 A		246-082-008-025G	SWP-M-C	
09.10 →	N57 D30 A		A2C53240479Z	SWP-M-C	
09.10 →	N57 D30 A		A2C53304876	HLWP	

**525 d (160 kW | 2.0 Litre)**

09.11 →	N47 D20 D		A2C53240479Z	SWP-M-C	
09.11 →	N47 D20 D		A2C53304876	HLWP	

**525 d xDrive (160 kW | 2.0 Litre)**

09.11 →	N47 D20 D		A2C53240479Z	SWP-M-C	
09.11 →	N47 D20 D		A2C53304876	HLWP	

**528 i (180 kW | 2.0 Litre)**

09.11 →	N20 B20 A		A2C53240479Z	SWP-M-C	
09.11 →	N20 B20 A		A2C53304876	HLWP	

**528 i (190 kW | 3.0 Litre)**

09.10 →	N52 B30 A, N53 B30 A		246-082-008-025G	SWP-M-C	
09.10 →	N53 B30 A		A2C53240479Z	SWP-M-C	
09.10 →	N53 B30 A		A2C53304876	HLWP	

**528 i xDrive (180 kW | 2.0 Litre)**

09.11 →	N20 B20 A		A2C53240479Z	SWP-M-C	
09.11 →	N20 B20 A		A2C53304876	HLWP	

**530 d (180 kW | 3.0 Litre)**

09.10 →	N57 D30 A		246-082-008-025G	SWP-M-C	
09.10 →	N57 D30 A		A2C53240479Z	SWP-M-C	
09.10 →	N57 D30 A		A2C53304876	HLWP	

**530 d (190 kW | 3.0 Litre)**

09.11 →	N57 D30 A		A2C53240479Z	SWP-M-C	
09.11 →	N57 D30 A		A2C53304876	HLWP	

**530 d xDrive (190 kW | 3.0 Litre)**

09.11 →	N57 D30 A		A2C53240479Z	SWP-M-C	
09.11 →	N57 D30 A		A2C53304876	HLWP	

**530 i (200 kW | 3.0 Litre)**

09.11 →	N53 B30 A		A2C53240479Z	SWP-M-C	
09.11 →	N53 B30 A		A2C53304876	HLWP	

**535 d (220 kW | 3.0 Litre)**

09.10 →	N57S D30 B		246-082-008-025G	SWP-M-C	
---------	------------	--	------------------	---------	--



			<b>VDO</b>		
Date	Engine Code	Chassis No.	Article No.	Product	Information

**BMW****5 Touring (F11)****535 d (220 kW | 3.0 Litre)**

09.10 →	N57S D30 B		A2C53240479Z	SWP-M-C	
09.10 →	N57S D30 B		A2C53304876	HLWP	

**535 d (230 kW | 3.0 Litre)**

09.11 →	N57 D30 B		A2C53240479Z	SWP-M-C	
09.11 →	N57 D30 B		A2C53304876	HLWP	

**535 d xDrive (230 kW | 3.0 Litre)**

09.11 →	N57 D30 B		A2C53240479Z	SWP-M-C	
09.11 →	N57 D30 B		A2C53304876	HLWP	

**535 i (225 kW | 3.0 Litre)**

09.10 →	N55 B30 A		246-082-008-025G	SWP-M-C	
09.10 →	N55 B30 A		A2C53240479Z	SWP-M-C	
09.10 →	N55 B30 A		A2C53304876	HLWP	

**535 i xDrive (225 kW | 3.0 Litre)**

09.11 →	N55 B30 A		A2C53240479Z	SWP-M-C	
09.11 →	N55 B30 A		A2C53304876	HLWP	

**550 i (300 kW | 4.4 Litre)**

09.10 →	N63 B44 A		A2C53240479Z	SWP-M-C	
09.10 →	N63 B44 A		A2C53304876	HLWP	

**M 550 d xDrive (280 kW | 3.0 Litre)**

01.12 →	N57 D30 C		A2C53240479Z	SWP-M-C	
01.12 →	N57 D30 C		A2C53304876	HLWP	

**6 (E24)****628 CSi (135 kW | 2.8 Litre)**

09.79 → 08.87	M 30 B 28		246-075-042-001C	SWP-M-G	Plug Number (T2): 1
09.79 → 08.87	M30 B28		246-080-013-001Z	N-H	

**633 CSi (145 kW | 3.2 Litre)**

09.78 → 08.84	M 30 B 32		246-075-042-001C	SWP-M-G	Plug Number (T2): 1
---------------	-----------	--	------------------	---------	---------------------

**633 CSi (147 kW | 3.2 Litre)**

04.76 → 09.78			246-075-042-001C	SWP-M-G	Plug Number (T2): 1
---------------	--	--	------------------	---------	---------------------

**635 CSi (136 kW | 3.4 Litre)**

01.85 → 05.89	M 30 B 35 (Motronic,		246-075-042-001C	SWP-M-G	Plug Number (T2): 1
---------------	----------------------	--	------------------	---------	---------------------

**635 CSi (141 kW | 3.4 Litre)**

04.85 → 09.90	M 30 B 35		246-075-042-001C	SWP-M-G	Plug Number (T2): 1
---------------	-----------	--	------------------	---------	---------------------

**635 CSi (155 kW | 3.4 Litre)**

08.87 → 05.89	M 30 B 35		246-075-042-001C	SWP-M-G	Plug Number (T2): 1
---------------	-----------	--	------------------	---------	---------------------

**635 CSi (160 kW | 3.4 Litre)**

06.78 → 08.88	M 30 B 35 (L-Jetroni, M 30 B 35 (Motronic,		246-075-042-001C	SWP-M-G	Plug Number (T2): 1
---------------	-----------------------------------------------	--	------------------	---------	---------------------

**M 635 CSi (191 kW | 3.5 Litre)**

10.86 → 10.88	S 38 B 35 (Kat)		246-075-042-001C	SWP-M-G	Plug Number (T2): 1
10.86 → 10.88	S38 B35 (Kat)		246-080-013-001Z	N-H	

**M 635 CSi (211 kW | 3.4 Litre)**

03.84 → 05.89	S 38 B 35		246-075-042-001C	SWP-M-G	Plug Number (T2): 1
03.84 → 05.89	S38 B35		246-080-013-001Z	N-H	

**6 (E63)****630 i (190 kW | 3.0 Litre)**

09.04 →	N52 B30 A, N52 B30		246-086-001-007C	HLWP	Plug Number (T2): 3b
09.04 →	N52 B30, N52 B30 A		A2C53240479Z	SWP-M-C	

**630 i (200 kW | 3.0 Litre)**

07.07 →	N52B30A, N 53 B 30		246-086-001-007C	HLWP	Plug Number (T2): 3b
07.07 →	N53 B30		A2C53240479Z	SWP-M-C	

**635 d (210 kW | 3.0 Litre)**

07.07 →	N57N306D5		246-086-001-007C	HLWP	Plug Number (T2): 3b
07.07 →	N57N 306 D5		A2C53240479Z	SWP-M-C	

**645 Ci (245 kW | 4.4 Litre)**

01.04 →	N62 B44, N62 B44 A		246-086-001-007C	HLWP	Plug Number (T2): 3b
01.04 →	N62 B44, N62 B44 A		A2C53240479Z	SWP-M-C	

**650 Ci (261 kW | 4.8 Litre)**

09.05 → 12.10			A2C53240479Z	SWP-M-C	
---------------	--	--	--------------	---------	--



					
Date	Engine Code	Chassis No.	Article No.	Product	Information

**BMW****6 (E63)****650 i (270 kW | 4.8 Litre)**

07.05 →	N62 B48 B		246-086-001-007C	HLWP	Plug Number (T2): 3b
07.05 →	N62 B48 B		A2C53240479Z	SWP-M-C	

**M (373 kW | 5.0 Litre)**

09.05 →	S85B50A		246-086-001-007C	HLWP	Plug Number (T2): 3b
09.05 →	S85 B50 A		A2C53240479Z	SWP-M-C	

**6 Convertible (E64)****630 i (190 kW | 3.0 Litre)**

09.04 →	N 52 B 30, N52B30A		246-086-001-007C	HLWP	Plug Number (T2): 3b
09.04 →	N52 B30, N52 B30 A		A2C53240479Z	SWP-M-C	

**630 i (200 kW | 3.0 Litre)**

07.07 →	N52B30A, N 53 B 30		246-086-001-007C	HLWP	Plug Number (T2): 3b
07.07 →	N53 B30		A2C53240479Z	SWP-M-C	

**635 d (210 kW | 3.0 Litre)**

07.07 →	M57N306D5		246-086-001-007C	HLWP	Plug Number (T2): 3b
07.07 →	M57N 306 D5		A2C53240479Z	SWP-M-C	

**645 Ci (245 kW | 4.4 Litre)**

04.04 →	N 62 B 44, N62B44A		246-086-001-007C	HLWP	Plug Number (T2): 3b
04.04 →	N62 B44, N62 B44 A		A2C53240479Z	SWP-M-C	

**650 i (270 kW | 4.8 Litre)**

07.05 →	N62B48B		246-086-001-007C	HLWP	Plug Number (T2): 3b
07.05 →	N62 B48 B		A2C53240479Z	SWP-M-C	

**M (373 kW | 5.0 Litre)**

07.06 →	S85B50A		246-086-001-007C	HLWP	Plug Number (T2): 3b
07.06 →	S85 B50 A		A2C53240479Z	SWP-M-C	

**6 Convertible (F12)****640 d (230 kW | 3.0 Litre)**

09.11 →	N57 D30 B		A2C53240479Z	SWP-M-C	
09.11 →	N57 D30 B		A2C53304876	HLWP	

**640 d xDrive (230 kW | 3.0 Litre)**

09.11 →	N57 D30 B		A2C53240479Z	SWP-M-C	
09.11 →	N57 D30 B		A2C53304876	HLWP	

**640 i (235 kW | 3.0 Litre)**

03.11 →	N55 B30 A		A2C53240479Z	SWP-M-C	
03.11 →	N55 B30 A		A2C53304876	HLWP	

**650 i (300 kW | 4.4 Litre)**

03.11 →	N63 B44 A		A2C53240479Z	SWP-M-C	
03.11 →	N63 B44 A		A2C53304876	HLWP	

**650 i xDrive (300 kW | 4.4 Litre)**

06.11 →	N63 B44 A		A2C53240479Z	SWP-M-C	
06.11 →	N63 B44 A		A2C53304876	HLWP	

**M (412 kW | 4.4 Litre)**

01.12 →	S63 B44 B		A2C53240479Z	SWP-M-C	
01.12 →	S63 B44 B		A2C53304876	HLWP	

**6 Coupe / Gran Coupe (F13, F06)****640 d (230 kW | 3.0 Litre)**

11.10 →	N57 D30 B		A2C53240479Z	SWP-M-C	
11.10 →	N57 D30 B		A2C53304876	HLWP	

**640 d xDrive (230 kW | 3.0 Litre)**

09.11 →	N57 D30 B		A2C53240479Z	SWP-M-C	
09.11 →	N57 D30 B		A2C53304876	HLWP	

**640 i (235 kW | 3.0 Litre)**

11.10 →	N55 B30 A		A2C53240479Z	SWP-M-C	
11.10 →	N55 B30 A		A2C53304876	HLWP	

**650 i (300 kW | 4.4 Litre)**

11.10 →	N63 B44 A		A2C53240479Z	SWP-M-C	
11.10 →	N63 B44 A		A2C53304876	HLWP	

**650 i (330 kW | 4.4 Litre)**

10.11 →	N63 B44 B		A2C53240479Z	SWP-M-C	
10.11 →	N63 B44 B		A2C53304876	HLWP	





			<b>VDO</b>		
Date	Engine Code	Chassis No.	Article No.	Product	Information

**BMW****6 Coupe / Gran Coupe (F13, F06)****650 i xDrive (300 kW | 4.4 Litre)**

06.11 -	N63 B44 A		A2C53240479Z	SWP-M-C	
06.11 -	N63 B44 A		A2C53304876	HLWP	

**650 i xDrive (330 kW | 4.4 Litre)**

11.11 -	N63 B44 B		A2C53240479Z	SWP-M-C	
11.11 -	N63 B44 B		A2C53304876	HLWP	

**M (412 kW | 4.4 Litre)**

01.12 -	S63 B44 B		A2C53240479Z	SWP-M-C	
01.12 -	S63 B44 B		A2C53304876	HLWP	

**7 (E23)****728 i (135 kW | 2.8 Litre)**

07.78 - 08.86	M30 B28		246-075-042-001C	SWP-M-G	Plug Number (T2): 1
---------------	---------	--	------------------	---------	---------------------

**733 i (145 kW | 3.2 Litre)**

05.77 - 09.79	M30 B32		246-075-042-001C	SWP-M-G	Plug Number (T2): 1
---------------	---------	--	------------------	---------	---------------------

**735 i (136 kW | 3.4 Litre)**

01.85 - 08.86	M30 B35 (Motronic,8:1,Kat.)		246-075-042-001C	SWP-M-G	Plug Number (T2): 1
---------------	-----------------------------	--	------------------	---------	---------------------

**735 i (141 kW | 3.4 Litre)**

04.85 - 08.86	M30 B35 (Motronic)		246-075-042-001C	SWP-M-G	Plug Number (T2): 1
---------------	--------------------	--	------------------	---------	---------------------

**735 i (160 kW | 3.4 Litre)**

09.79 - 08.86	M30 B35 (Motronic,9.3:1), M30 B35 (Motronic,10:1)		246-075-042-001C	SWP-M-G	Plug Number (T2): 1
---------------	------------------------------------------------------	--	------------------	---------	---------------------

**745 i (185 kW | 3.2 Litre)**

04.80 - 04.83	M30 B32 (Turbo)		246-075-042-001C	SWP-M-G	Plug Number (T2): 1
---------------	-----------------	--	------------------	---------	---------------------

**745 i (185 kW | 3.4 Litre)**

05.83 - 08.86	M30 B35		246-075-042-001C	SWP-M-G	Plug Number (T2): 1
---------------	---------	--	------------------	---------	---------------------

**7 (E32)****730 i,iL (138 kW | 3.0 Litre)**

12.86 - 09.94	M30 B30		246-069-059-001Z	N	
09.90 - 09.94	M30 B30		246-080-013-003Z	N-H	

**730 i,iL (145 kW | 3.0 Litre)**

12.86 - 09.94	M30 B30		246-069-059-001Z	N	
09.90 - 09.94	M30 B30		246-080-013-003Z	N-H	

**730 i,iL V8 (160 kW | 3.0 Litre)**

04.92 - 09.94	M60 B30		246-069-059-001Z	N	
04.92 - 09.94	M60 B30		246-080-013-003Z	N-H	

**735 i,iL (155 kW | 3.4 Litre)**

09.86 - 09.92	M30 B35		246-080-013-001Z	N-H	
09.90 - 09.92	M30 B35		246-080-013-003Z	N-H	

**735 i,iL (162 kW | 3.4 Litre)**

09.86 - 12.87	M30 B35 (Motronic,9.2:1)		246-080-013-001Z	N-H	
---------------	--------------------------	--	------------------	-----	--

**740 i,iL V8 (210 kW | 4.0 Litre)**

04.92 - 09.94	M60 B40		246-069-059-001Z	N	
04.92 - 09.94	M60 B40		246-080-013-003Z	N-H	

**750 i,iL V12 (220 kW | 5.0 Litre)**

09.87 - 09.94	M70 B50		246-080-013-001Z	N-H	
09.90 - 09.94	M70 B50		246-080-013-003Z	N-H	

**7 (E38)****725 tds (105 kW | 2.5 Litre)**

09.97 - 11.01	M51 D25 (Inter.)		246-082-008-025G	SWP-M-C	
---------------	------------------	--	------------------	---------	--

**728 i,iL (142 kW | 2.8 Litre)**

09.97 - 11.01	M52 B28, M52 B28 TU		246-082-008-025G	SWP-M-C	
---------------	---------------------	--	------------------	---------	--

**730 d (135 kW | 3.0 Litre)**

08.98 - 04.00	M57 D30		246-086-001-007C	HLWP	Plug Number (T2): 3b
---------------	---------	--	------------------	------	----------------------

**730 d (142 kW | 3.0 Litre)**

04.00 - 11.01	M57 306 D1		246-086-001-007C	HLWP	Plug Number (T2): 3b
---------------	------------	--	------------------	------	----------------------

**730 i,iL (155 kW | 3.0 Litre)**

09.97 - 11.01	M60 B30		246-082-008-025G	SWP-M-C	
09.97 - 11.01	M60 B30		246-086-001-007C	HLWP	Plug Number (T2): 3b

**730 i,iL (160 kW | 3.0 Litre)**

09.97 - 11.01	M60 B30		246-082-008-025G	SWP-M-C	
---------------	---------	--	------------------	---------	--



			<b>VDO</b>		
Date	Engine Code	Chassis No.	Article No.	Product	Information

**BMW****7 (E38)****730 i,iL (160 kW | 3.0 Litre)**

09.97 → 11.01 M60 B30 246-086-001-007C HLWP Plug Number (T2): 3b

**735 i,iL (173 kW | 3.5 Litre)**09.97 → 11.01 M62 B(35 8 S1), M62 B35 246-082-008-025G SWP-M-C  
09.97 → 11.01 M62 B(35 8 S1), M62 B35 246-086-001-007C HLWP Plug Number (T2): 3b**740 d (180 kW | 3.9 Litre)**

05.99 → 11.01 M67 D39 246-086-001-007C HLWP Plug Number (T2): 3b

**740 i,iL (210 kW | 4.0 Litre)**09.97 → 11.01 M60 B40 246-082-008-025G SWP-M-C  
09.97 → 11.01 M60 B40 246-086-001-007C HLWP Plug Number (T2): 3b**740 i,iL (210 kW | 4.4 Litre)**09.97 → 11.01 M62 B44, M62 448 S2, M62 B44 TU 246-082-008-025G SWP-M-C  
09.97 → 11.01 M62 B44, M62 448 S2, M62 B44 TU 246-086-001-007C HLWP Plug Number (T2): 3b**750 i,iL (240 kW | 5.4 Litre)**09.97 → 11.01 M73 B54 246-082-008-025G SWP-M-C  
09.97 → 11.01 M73 B54 246-086-001-007C HLWP Plug Number (T2): 3b**7 (E65, E66)****730 d (155 kW | 3.0 Litre)**

09.03 → M57N 306 D2 A2C53240479Z SWP-M-C

**730 d (160 kW | 3.0 Litre)**10.02 → M57N2 306 D2 246-086-001-007C HLWP Plug Number (T2): 3b  
09.03 → M57N2 306 D2 A2C53240479Z SWP-M-C**730 i,Li (170 kW | 3.0 Litre)**03.03 → 09.03 M54 306 S3, M54 B30 246-082-008-025G SWP-M-C  
03.03 → M54 306 S3, M54 B30 246-086-001-007C HLWP Plug Number (T2): 3b  
09.03 → M54 306 S3, M54 B30 A2C53240479Z SWP-M-C**730 i,Li (190 kW | 3.0 Litre)**03.05 → N 52 B 30, N52B30A 246-086-001-007C HLWP Plug Number (T2): 3b  
03.05 → N52 B30, N52 B30 A A2C53240479Z SWP-M-C**730 Ld (170 kW | 3.0 Litre)**07.05 → M57306D3, N57N306D2 246-086-001-007C HLWP Plug Number (T2): 3b  
07.05 → M57 306 D3, N57N 306 D2 A2C53240479Z SWP-M-C**735 i (225 kW | 4.0 Litre)**

03.05 → N62 B40 A A2C53240479Z SWP-M-C

**735 i,Li (200 kW | 3.6 Litre)**11.01 → N62 B36 246-082-008-025G SWP-M-C  
11.01 → N62 B36 246-086-001-007C HLWP Plug Number (T2): 3b  
09.03 → N62 B36 A2C53240479Z SWP-M-C**740 d (190 kW | 3.9 Litre)**10.02 → N67 398 D1 246-086-001-007C HLWP Plug Number (T2): 3b  
09.03 → N67 398 D1 A2C53240479Z SWP-M-C**740 i,Li (225 kW | 4.0 Litre)**07.05 → N62B40A 246-086-001-007C HLWP Plug Number (T2): 3b  
07.05 → N62 B40 A A2C53240479Z SWP-M-C**745 d (220 kW | 4.4 Litre)**03.05 → 08.05 N67N448D1 246-086-001-007C HLWP Plug Number (T2): 3b  
03.05 → 08.05 N67N 448 D1 A2C53240479Z SWP-M-C**745 d (242 kW | 4.4 Litre)**07.05 → N67N 448 D2 246-086-001-007C HLWP Plug Number (T2): 3b  
07.05 → N67N 448 D2 A2C53240479Z SWP-M-C**745 i,Li (245 kW | 4.4 Litre)**11.01 → N62 B44, N62 B44 A 246-082-008-025G SWP-M-C  
11.01 → N62 B44, N62 B44 A 246-086-001-007C HLWP Plug Number (T2): 3b  
09.03 → N62 B44, N62 B44 A A2C53240479Z SWP-M-C**750 i,Li (270 kW | 4.8 Litre)**07.05 → N62 B48 B 246-086-001-007C HLWP Plug Number (T2): 3b  
07.05 → N62 B48 B A2C53240479Z SWP-M-C**760 (320 kW | 6.0 Litre)**

09.03 → 08.05 N73 B60 A A2C53240479Z SWP-M-C



			<b>VDO</b>		
Date	Engine Code	Chassis No.	Article No.	Product	Information

**BMW****7 (E65, E66)****760 i, Li (327 kW | 6.0 Litre)**

01.03 -	N73 B60		246-086-001-007C	HLWP	Plug Number (T2): 3b
09.03 -	N73 B60		A2C53240479Z	SWP-M-C	

**7 (F01, F02, F03, F04)****730 d xDrive (190 kW | 3.0 Litre)**

07.12 -	N47 D30 A		A2C53240479Z	SWP-M-C	
07.12 -	N47 D30 A		A2C53304876	HLWP	

**730 d (180 kW | 3.0 Litre)**

10.08 -	N57 D30 A		A2C53240479Z	SWP-M-C	
10.08 -	N57 D30 A		A2C53304876	HLWP	

**730 d (190 kW | 3.0 Litre)**

07.12 -	N47 D30 A		A2C53240479Z	SWP-M-C	
07.12 -	N47 D30 A		A2C53304876	HLWP	

**730 i (190 kW | 3.0 Litre)**

06.08 -	N52 B30 A, N52 B30 BF		A2C53240479Z	SWP-M-C	
06.08 -	N52 B30 A, N52 B30 BF		A2C53304876	HLWP	

**740 d (225 kW | 3.0 Litre)**

09.09 -	N57S D30 B		A2C53240479Z	SWP-M-C	
09.09 -	N57S D30 B		A2C53304876	HLWP	

**740 d (230 kW | 3.0 Litre)**

07.12 -	N57 D30 B		A2C53240479Z	SWP-M-C	
07.12 -	N57 D30 B		A2C53304876	HLWP	

**740 d xDrive (225 kW | 3.0 Litre)**

09.09 -	N57S D30 B		A2C53240479Z	SWP-M-C	
09.09 -	N57S D30 B		A2C53304876	HLWP	

**740 d xDrive (230 kW | 3.0 Litre)**

07.12 -	N57 D30 B		A2C53240479Z	SWP-M-C	
07.12 -	N57 D30 B		A2C53304876	HLWP	

**740 i (235 kW | 3.0 Litre)**

07.12 -	N55 B30 A		A2C53240479Z	SWP-M-C	
07.12 -	N55 B30 A		A2C53304876	HLWP	

**740 i (240 kW | 3.0 Litre)**

10.08 -	N54 B30 A		A2C53240479Z	SWP-M-C	
10.08 -	N54 B30 A		A2C53304876	HLWP	

**750 d xDrive (280 kW | 3.0 Litre)**

07.12 -	N57 D30 C		A2C53240479Z	SWP-M-C	
07.12 -	N57 D30 C		A2C53304876	HLWP	

**750 i (300 kW | 4.4 Litre)**

10.08 -	N63 B44 A		A2C53240479Z	SWP-M-C	
10.08 -	N63 B44 A		A2C53304876	HLWP	

**750 i xDrive (300 kW | 4.4 Litre)**

09.09 -	N63 B44 A		A2C53240479Z	SWP-M-C	
09.09 -	N63 B44 A		A2C53304876	HLWP	

**760 i (400 kW | 6.0 Litre)**

09.09 -	N74 B60 A		A2C53240479Z	SWP-M-C	
09.09 -	N74 B60 A		A2C53304876	HLWP	

**ActiveHybrid (260 kW | 3.0 Litre)**

07.12 -	N55 B30 A		A2C53240479Z	SWP-M-C	
07.12 -	N55 B30 A		A2C53304876	HLWP	

**ActiveHybrid (330 kW | 4.4 Litre)**

10.10 -	N63 B44 A		A2C53240479Z	SWP-M-C	
10.10 -	N63 B44 A		A2C53304876	HLWP	

**ActiveHybrid (342 kW | 4.4 Litre)**

10.10 -	N63 B44 A		A2C53240479Z	SWP-M-C	
10.10 -	N63 B44 A		A2C53304876	HLWP	

**X1 (E84)****sDrive 18 d (100 kW | 2.0 Litre)**

03.09 -	N47 D20 C		246-082-008-025G	SWP-M-C	
03.09 -	N47D20C		246-086-001-007C	HLWP	Plug Number (T2): 3b
03.09 -	N47 D20 C		A2C53240479Z	SWP-M-C	Equipment (T11): for windscreen cleaning (T13)



			<b>VDO</b>		
Date	Engine Code	Chassis No.	Article No.	Product	Information

**BMW****X1 (E84)****sDrive 18 d (105 kW | 2.0 Litre)**

10.09 -	N47 D20 C		246-082-008-025G	SWP-M-C	
10.09 -			246-086-001-007C	HLWP	Plug Number (T2): 3b
10.09 -	N47 D20 C		A2C53240479Z	SWP-M-C	Equipment (T11): for windscreen cleaning (T13)

**sDrive 18 i (110 kW | 2.0 Litre)**

01.10 -	N46 B20 B		246-082-008-025G	SWP-M-C	
01.10 -	N46B20B		246-086-001-007C	HLWP	Plug Number (T2): 3b
01.10 -	N46 B20 B		A2C53240479Z	SWP-M-C	Equipment (T11): for windscreen cleaning (T13)

**sDrive 20 d (120 kW | 2.0 Litre)**

03.10 -	N47 D20 C		246-082-008-025G	SWP-M-C	
03.10 -	N47D20C		246-086-001-007C	HLWP	Plug Number (T2): 3b
03.10 -	N47 D20 C		A2C53240479Z	SWP-M-C	Equipment (T11): for windscreen cleaning (T13)

**sDrive 20 d (130 kW | 2.0 Litre)**

10.09 -	N47 D20 C		246-082-008-025G	SWP-M-C	
10.09 -			246-086-001-007C	HLWP	Plug Number (T2): 3b
10.09 -	N47 D20 C		A2C53240479Z	SWP-M-C	Equipment (T11): for windscreen cleaning (T13)

**sDrive 20 i (135 kW | 2.0 Litre)**

09.11 -	N20 B20 A		A2C53240479Z	SWP-M-C	Equipment (T11): for windscreen cleaning (T13)
---------	-----------	--	--------------	---------	------------------------------------------------

**xDrive 18 d (100 kW | 2.0 Litre)**

03.09 -	N47 D20 C		246-082-008-025G	SWP-M-C	
03.09 -	N47D20C		246-086-001-007C	HLWP	Plug Number (T2): 3b
03.09 -	N47 D20 C		A2C53240479Z	SWP-M-C	Equipment (T11): for windscreen cleaning (T13)

**xDrive 18 d (105 kW | 2.0 Litre)**

10.09 -	N47 D20 C		246-082-008-025G	SWP-M-C	
10.09 -			246-086-001-007C	HLWP	Plug Number (T2): 3b
10.09 -	N47 D20 C		A2C53240479Z	SWP-M-C	Equipment (T11): for windscreen cleaning (T13)

**xDrive 20 d (120 kW | 2.0 Litre)**

03.10 -	N47 D20 C		246-082-008-025G	SWP-M-C	
03.10 -	N47D20C		246-086-001-007C	HLWP	Plug Number (T2): 3b
03.10 -	N47 D20 C		A2C53240479Z	SWP-M-C	Equipment (T11): for windscreen cleaning (T13)

**xDrive 20 d (130 kW | 2.0 Litre)**

10.09 -	N47 D20 C		246-082-008-025G	SWP-M-C	
10.09 -			246-086-001-007C	HLWP	Plug Number (T2): 3b
10.09 -	N47 D20 C		A2C53240479Z	SWP-M-C	Equipment (T11): for windscreen cleaning (T13)

**xDrive 20 i (135 kW | 2.0 Litre)**

09.11 -	N20 B20 A		A2C53240479Z	SWP-M-C	Equipment (T11): for windscreen cleaning (T13)
---------	-----------	--	--------------	---------	------------------------------------------------

**xDrive 23 d (150 kW | 2.0 Litre)**

10.09 -	N47S D20 D		246-082-008-025G	SWP-M-C	
10.09 -			246-086-001-007C	HLWP	Plug Number (T2): 3b
10.09 -	N47S D20 D		A2C53240479Z	SWP-M-C	Equipment (T11): for windscreen cleaning (T13)

**xDrive 25 i (160 kW | 3.0 Litre)**

01.10 -	N52 B30 A		246-082-008-025G	SWP-M-C	
01.10 -	N52B30A		246-086-001-007C	HLWP	Plug Number (T2): 3b
01.10 -	N52 B30 A		A2C53240479Z	SWP-M-C	Equipment (T11): for windscreen cleaning (T13)

**xDrive 28 i (180 kW | 2.0 Litre)**

04.11 -	N20 B20 A		246-082-008-025G	SWP-M-C	
04.11 -	N20 B20 A		A2C53240479Z	SWP-M-C	Equipment (T11): for windscreen cleaning (T13)

**xDrive 28 i (190 kW | 3.0 Litre)**

10.09 -	N52 B30 A		246-082-008-025G	SWP-M-C	
10.09 -			246-086-001-007C	HLWP	Plug Number (T2): 3b
10.09 -	N52 B30 A		A2C53240479Z	SWP-M-C	Equipment (T11): for windscreen cleaning (T13)

**X3 (E83)****2.0 d (110 kW | 2.0 Litre)**

10.04 -	M47N 204 D4		246-082-008-025G	SWP-M-C	
10.04 -	M47N 204 D4		246-086-001-007C	HLWP	Plug Number (T2): 3b

**2.0 d (130 kW | 2.0 Litre)**

09.07 -	N47 D20 A		246-082-008-025G	SWP-M-C	
09.07 -	N47D20A		246-086-001-007C	HLWP	Plug Number (T2): 3b

**2.0 i (110 kW | 2.0 Litre)**

07.05 -	N46 B20 A, N46 B20		246-082-008-025G	SWP-M-C	
07.05 -	N 46 B 20, N46B20A		246-086-001-007C	HLWP	Plug Number (T2): 3b



			<b>VDO</b>		
Date	Engine Code	Chassis No.	Article No.	Product	Information

**BMW****X3 (E83)****2.5 i (141 kW | 2.5 Litre)**

01.04 →	M54 256 S5, M54 B25		246-082-008-025G	SWP-M-C	
01.04 →	M54 256 S5, M54 B25		246-086-001-007C	HLWP	Plug Number (T2): 3b

**2.5 si (160 kW | 2.5 Litre)**

09.06 →	N52B25A		246-086-001-007C	HLWP	Plug Number (T2): 3b
---------	---------	--	------------------	------	----------------------

**3.0 d (150 kW | 3.0 Litre)**

01.04 →	M57N2 306 D2		246-082-008-025G	SWP-M-C	
01.04 →	M57N2 306 D2		246-086-001-007C	HLWP	Plug Number (T2): 3b

**3.0 d (160 kW | 3.0 Litre)**

01.04 →	M57N2 306 D2		246-082-008-025G	SWP-M-C	
01.04 →	M57N2 306 D2		246-086-001-007C	HLWP	Plug Number (T2): 3b

**3.0 i (170 kW | 3.0 Litre)**

01.04 →	M54 306 S3, M54 B30		246-082-008-025G	SWP-M-C	
01.04 →	M54 306 S3, M54 B30		246-086-001-007C	HLWP	Plug Number (T2): 3b

**3.0 sd (210 kW | 3.0 Litre)**

09.06 →	M57306D5		246-086-001-007C	HLWP	Plug Number (T2): 3b
---------	----------	--	------------------	------	----------------------

**3.0 si (200 kW | 3.0 Litre)**

09.06 →	N52B30A		246-086-001-007C	HLWP	Plug Number (T2): 3b
---------	---------	--	------------------	------	----------------------

**X3 (F25)****xDrive 20 d (135 kW | 2.0 Litre)**

09.10 →	N47 D20 C		246-082-008-025G	SWP-M-C	
09.10 →	N47 D20 C		A2C53240479Z	SWP-M-C	
09.10 →	N47 D20 C		A2C53304876	HLWP	

**xDrive 20 i (135 kW | 2.0 Litre)**

09.11 →	N20 B20 A		A2C53240479Z	SWP-M-C	
09.11 →	N20 B20 A		A2C53304876	HLWP	

**xDrive 28 i (180 kW | 2.0 Litre)**

08.11 →	N20 B20 A		A2C53240479Z	SWP-M-C	
08.11 →	N20 B20 A		A2C53304876	HLWP	

**xDrive 28 i (190 kW | 3.0 Litre)**

04.11 →	N52 B30 A		A2C53240479Z	SWP-M-C	
04.11 →	N52 B30 A		A2C53304876	HLWP	

**xDrive 30 d (190 kW | 3.0 Litre)**

05.11 →	N57 D30 A		A2C53240479Z	SWP-M-C	
05.11 →	N57 D30 A		A2C53304876	HLWP	

**xDrive 35 d (230 kW | 3.0 Litre)**

09.11 →	N57 D30 B		A2C53240479Z	SWP-M-C	
09.11 →	N57 D30 B		A2C53304876	HLWP	

**xDrive 35 i (225 kW | 3.0 Litre)**

09.10 →	N55 B30 A		246-082-008-025G	SWP-M-C	
09.10 →	N55 B30 A		A2C53240479Z	SWP-M-C	
09.10 →	N55 B30 A		A2C53304876	HLWP	

**X5 (E53)****3.0 d (135 kW | 3.0 Litre)**

05.01 →	M57 306 D1		246-082-008-025G	SWP-M-C	
05.01 →	M57 306 D1		246-086-001-007C	HLWP	Plug Number (T2): 3b

**3.0 d (160 kW | 3.0 Litre)**

12.03 →	M57N 306 D4		246-082-008-025G	SWP-M-C	
12.03 →	M57N306D4		246-086-001-007C	HLWP	Plug Number (T2): 3b

**3.0 i (163 kW | 3.0 Litre)**

05.00 →	M54 306 S3		246-082-008-025G	SWP-M-C	
05.00 →	M54 306 S3		246-086-001-007C	HLWP	Plug Number (T2): 3b

**3.0 i (170 kW | 3.0 Litre)**

05.00 →	M54 306 S3, M54 B30		246-082-008-025G	SWP-M-C	
05.00 →	M 54 B 30, M54306S3		246-086-001-007C	HLWP	Plug Number (T2): 3b

**4.4 i (210 kW | 4.4 Litre)**

05.00 →	M62 B44, M62 B44 TU		246-082-008-025G	SWP-M-C	
05.00 →	M62 B44, M62 B44 TU		246-086-001-007C	HLWP	Plug Number (T2): 3b

**4.4 i (235 kW | 4.4 Litre)**

12.03 →	N62 B44 A, N62 B44		246-082-008-025G	SWP-M-C	
12.03 →	N 62 B 44, N62B44A		246-086-001-007C	HLWP	Plug Number (T2): 3b



			<b>VDO</b>		
Date	Engine Code	Chassis No.	Article No.	Product	Information

**BMW****X5 (E53)****4.6 is (255 kW | 4.6 Litre)**

02.02 -	M62 B46, M67 468 S1		246-082-008-025G	SWP-M-C	
02.02 -	M67 468 S1, M62 B46		246-086-001-007C	HLWP	Plug Number (T2): 3b

**4.8 is (265 kW | 4.8 Litre)**

04.04 -	N62 B48 A		246-082-008-025G	SWP-M-C	
04.04 -	N62B48A		246-086-001-007C	HLWP	Plug Number (T2): 3b

**X5 (E70)****3.0 d (155 kW | 3.0 Litre)**

02.07 - 09.08	M57N2 306 D3		A2C53240479Z	SWP-M-C	
02.07 - 09.08	M57N2 306 D3		A2C53304876	HLWP	

**3.0 d (173 kW | 3.0 Litre)**

02.07 - 09.08	M57306D3		246-086-001-007C	HLWP	Plug Number (T2): 3b
02.07 - 09.08	M57 306 D3		A2C53240479Z	SWP-M-C	
02.07 - 09.08	M57 306 D3		A2C53304876	HLWP	

**3.0 sd (210 kW | 3.0 Litre)**

09.07 - 09.08	M57N306D5		246-086-001-007C	HLWP	Plug Number (T2): 3b
09.07 - 09.08	M57N 306 D5		A2C53240479Z	SWP-M-C	
09.07 - 09.08	M57N 306 D5		A2C53304876	HLWP	

**3.0 si (171 kW | 3.0 Litre)**

02.07 - 09.08	N52 B30 A		A2C53240479Z	SWP-M-C	
02.07 - 09.08	N52 B30 A		A2C53304876	HLWP	

**3.0 si (200 kW | 3.0 Litre)**

02.07 - 09.08	N 52 B 30, N52B30A		246-086-001-007C	HLWP	Plug Number (T2): 3b
02.07 - 09.08	N52 B30, N52 B30 A		A2C53240479Z	SWP-M-C	
02.07 - 09.08	N52 B30 A, N52 B30		A2C53304876	HLWP	

**4.8 i (261 kW | 4.8 Litre)**

02.07 - 09.08	N62B48B		246-086-001-007C	HLWP	Plug Number (T2): 3b
02.07 - 09.08	N62 B48 B		A2C53240479Z	SWP-M-C	
02.07 - 09.08	N62 B48 B		A2C53304876	HLWP	

**M (408 kW | 4.4 Litre)**

09.09 -			246-086-001-007C	HLWP	Plug Number (T2): 3b
09.09 -	S63 B44 A		A2C53240479Z	SWP-M-C	
09.09 -	S63 B44 A		A2C53304876	HLWP	

**M 50 d (280 kW | 3.0 Litre)**

08.11 -	N57 D30 C		A2C53240479Z	SWP-M-C	
08.11 -	N57 D30 C		A2C53304876	HLWP	

**xDrive 30 d (173 kW | 3.0 Litre)**

09.08 -			246-086-001-007C	HLWP	Plug Number (T2): 3b
09.08 -	N57 D30 A		A2C53240479Z	SWP-M-C	
09.08 -	N57 D30 A		A2C53304876	HLWP	

**xDrive 30 d (180 kW | 3.0 Litre)**

09.10 -			246-086-001-007C	HLWP	Plug Number (T2): 3b
09.10 -	N57 D30 A		A2C53240479Z	SWP-M-C	
09.10 -	N57 D30 A		A2C53304876	HLWP	

**xDrive 30 i (171 kW | 3.0 Litre)**

09.08 - 12.10			A2C53240479Z	SWP-M-C	
09.08 - 12.10			A2C53304876	HLWP	

**xDrive 30 i (200 kW | 3.0 Litre)**

09.08 - 03.10	N52 B30 A		A2C53240479Z	SWP-M-C	
09.08 - 03.10	N52 B30 A		A2C53304876	HLWP	

**xDrive 35 d (210 kW | 3.0 Litre)**

09.08 -	M57N 306 D5		A2C53240479Z	SWP-M-C	
09.08 -	M57N 306 D5		A2C53304876	HLWP	

**xDrive 35 i (225 kW | 3.0 Litre)**

09.10 -			246-086-001-007C	HLWP	Plug Number (T2): 3b
09.10 -	N55 B30 A		A2C53240479Z	SWP-M-C	
09.10 -	N55 B30 A		A2C53304876	HLWP	

**xDrive 40 d (225 kW | 3.0 Litre)**

09.10 -			246-086-001-007C	HLWP	Plug Number (T2): 3b
09.10 -	N57S D30 B		A2C53240479Z	SWP-M-C	
09.10 -	N57S D30 B		A2C53304876	HLWP	



			<b>VDO</b>		
Date	Engine Code	Chassis No.	Article No.	Product	Information

**BMW****X5 (E70)****xDrive 48 i (261 kW | 4.8 Litre)**

09.08 --	N62B48B		246-086-001-007C	HLWP	Plug Number (T2): 3b
09.08 --	N62 B48 B		A2C53240479Z	SWP-M-C	
09.08 --	N62 B48 B		A2C53304876	HLWP	

**xDrive 50 i (300 kW | 4.4 Litre)**

06.10 --	N63 B44 A		A2C53240479Z	SWP-M-C	
06.10 --	N63 B44 A		A2C53304876	HLWP	

**X6 (E71, E72)****30 d (173 kW | 3.0 Litre)**

05.08 --	M57N2 306 D3		A2C53240479Z	SWP-M-C	
05.08 --	M57N2 306 D3		A2C53304876	HLWP	

**35 d (210 kW | 3.0 Litre)**

05.08 --	N57N 306 D5		A2C53240479Z	SWP-M-C	
05.08 --	N57N 306 D5		A2C53304876	HLWP	

**35 i (225 kW | 3.0 Litre)**

05.08 --	N54 B30 A		A2C53240479Z	SWP-M-C	
05.08 --	N54 B30 A		A2C53304876	HLWP	

**50 i (300 kW | 4.4 Litre)**

05.08 --	N63 B44 A		A2C53240479Z	SWP-M-C	
05.08 --	N63 B44 A		A2C53304876	HLWP	

**ActiveHybrid (357 kW | 4.4 Litre)**

10.10 --	N63 B44 A		A2C53240479Z	SWP-M-C	
10.10 --	N63 B44 A		A2C53304876	HLWP	

**M (408 kW | 4.4 Litre)**

09.09 --			246-086-001-007C	HLWP	Plug Number (T2): 3b
09.09 --	S63 B44 A		A2C53240479Z	SWP-M-C	
09.09 --	S63 B44 A		A2C53304876	HLWP	

**M 50 d (280 kW | 3.0 Litre)**

08.11 --	N57 D30 C		A2C53240479Z	SWP-M-C	
08.11 --	N57 D30 C		A2C53304876	HLWP	

**xDrive 30 d (155 kW | 3.0 Litre)**

09.10 --	N57 D30 A		A2C53240479Z	SWP-M-C	
09.10 --	N57 D30 A		A2C53304876	HLWP	

**xDrive 30 d (173 kW | 3.0 Litre)**

09.08 --			246-086-001-007C	HLWP	Plug Number (T2): 3b
09.08 --	N57 D30 A		A2C53240479Z	SWP-M-C	
09.08 --	N57 D30 A		A2C53304876	HLWP	

**xDrive 30 d (180 kW | 3.0 Litre)**

09.10 --			246-086-001-007C	HLWP	Plug Number (T2): 3b
09.10 --	M57N2 306 D3, N57 D30 A		A2C53240479Z	SWP-M-C	
09.10 --	N57 D30 A, M57N2 306 D3		A2C53304876	HLWP	

**xDrive 35 d (210 kW | 3.0 Litre)**

09.08 --	N57N306D5		246-086-001-007C	HLWP	Plug Number (T2): 3b
09.08 --	N57N 306 D5		A2C53240479Z	SWP-M-C	
09.08 --	N57N 306 D5		A2C53304876	HLWP	

**xDrive 35 i (225 kW | 3.0 Litre)**

09.08 --	N54B30A		246-086-001-007C	HLWP	Plug Number (T2): 3b
09.08 --	N54 B30 A, N55 B30 A		A2C53240479Z	SWP-M-C	
09.08 --	N54 B30 A, N55 B30 A		A2C53304876	HLWP	

**xDrive 35 i (235 kW | 3.0 Litre)**

01.12 --	N55 B30 A		A2C53240479Z	SWP-M-C	
01.12 --	N55 B30 A		A2C53304876	HLWP	

**xDrive 40 d (225 kW | 3.0 Litre)**

10.10 --			246-086-001-007C	HLWP	Plug Number (T2): 3b
10.10 --	N57S D30 B		A2C53240479Z	SWP-M-C	
10.10 --	N57S D30 B		A2C53304876	HLWP	

**xDrive 50 i (300 kW | 4.4 Litre)**

09.08 --			246-086-001-007C	HLWP	Plug Number (T2): 3b
09.08 --	N63 B44 A		A2C53240479Z	SWP-M-C	
09.08 --	N63 B44 A		A2C53304876	HLWP	



			<b>VDO</b>		
Date	Engine Code	Chassis No.	Article No.	Product	Information

**BMW****Z1****2.5 (125 kW | 2.5 Litre)**

09.90 - 06.91 M 20 B 25

246-080-013-003Z

N-H

**Z3 (E36)****1.8 (85 kW | 1.8 Litre)**

10.95 - 10.98 M43 B18

246-080-013-003Z

N-H

10.95 - 10.98 M43 B18

246-082-008-025G

SWP-M-C

**1.9 (103 kW | 1.9 Litre)**

10.95 - 03.99 M44 B19

246-080-013-003Z

N-H

10.95 - 03.99 M44 B19

246-082-008-025G

SWP-M-C

**1.9 (85 kW | 1.9 Litre)**

01.99 - 01.03 M43 194 E1

246-080-013-003Z

N-H

01.99 - 01.03 M43 194 E1

246-082-008-025G

SWP-M-C

**1.9 (87 kW | 1.9 Litre)**07.98 - 01.03 M43 B19, M43 194 E1,  
M43 B19 TU

246-080-013-003Z

N-H

07.98 - 01.03 M43 B19, M43 194 E1,  
M43 B19 TU

246-082-008-025G

SWP-M-C

**2.0 (110 kW | 2.0 Litre)**

04.99 - 01.03 M52 B(20 6 S4), M52 B20

246-082-008-025G

SWP-M-C

**2.2 (125 kW | 2.2 Litre)**

08.00 - 01.03 M54 B22, M54 226 S1

246-082-008-025G

SWP-M-C

**2.8 (141 kW | 2.8 Litre)**

04.97 - 06.00 M52 B28, M52 B28 TU

246-080-013-003Z

N-H

04.97 - 06.00 M52 B28, M52 B28 TU

246-082-008-025G

SWP-M-C

**3.0 (170 kW | 3.0 Litre)**

06.00 - 01.03 M54 306 S3, M54 B30

246-082-008-025G

SWP-M-C

**M 3.2 (236 kW | 3.2 Litre)**

03.97 - 06.01 S50 B32

246-080-013-003Z

N-H

03.97 - 06.01 S50 B32

246-082-008-025G

SWP-M-C

**M 3.2 (239 kW | 3.2 Litre)**

06.01 - 01.03 S54 B32 (32 6 S4), S54 B32

246-080-013-003Z

N-H

06.01 - 01.03 S54 B32 (32 6 S4), S54 B32

246-082-008-025G

SWP-M-C

**Z3 Coupe (E36)****2.8 (141 kW | 2.8 Litre)**

07.97 - 06.00 M 52 B 28

246-080-013-003Z

N-H

11.97 - 06.00 M52 B28

246-082-008-025G

SWP-M-C

07.98 - 06.00 M52 B28

246-083-002-022G

SWP-D-C

**3.0 (170 kW | 3.0 Litre)**

06.00 - 06.03 M54 306 S3

246-083-002-022G

SWP-D-C

**M 3.2 (236 kW | 3.2 Litre)**

02.98 - 06.01 S50 B32

246-082-008-025G

SWP-M-C

09.98 - 06.01 S50 B32

246-083-002-022G

SWP-D-C

**M 3.2 (239 kW | 3.2 Litre)**

06.01 - 06.03 S54 326 S4, S54 B32

246-083-002-022G

SWP-D-C

**Z4 (E85)****2.0 i (110 kW | 2.0 Litre)**

04.05 - N46 B20 A, N46 B20

246-082-008-025G

SWP-M-C

04.05 - N 46 B 20, N46B20A

246-086-001-007C

HLWP

Plug Number (T2): 3b

**2.2 i (125 kW | 2.2 Litre)**

10.03 - M54 226 S1, M54 B22

246-082-008-025G

SWP-M-C

10.03 - M54 226 S1, M54 B22

246-086-001-007C

HLWP

Plug Number (T2): 3b

**2.5 i (130 kW | 2.5 Litre)**

01.06 - N52 B25 A

246-082-008-025G

SWP-M-C

01.06 - N52B25A

246-086-001-007C

HLWP

Plug Number (T2): 3b

**2.5 i (141 kW | 2.5 Litre)**

02.03 - M54 256 S5, M54 B25

246-082-008-025G

SWP-M-C

02.03 - M54 256 S5, M54 B25

246-086-001-007C

HLWP

Plug Number (T2): 3b

**2.5 si (160 kW | 2.5 Litre)**

01.06 - N52 B25 A

246-082-008-025G

SWP-M-C

01.06 - N52B25A

246-086-001-007C

HLWP

Plug Number (T2): 3b





			<b>VDO</b>		
Date	Engine Code	Chassis No.	Article No.	Product	Information

**BMW****Z4 (E85)****3.0 i (170 kW | 3.0 Litre)**

02.03 -	M54 306 S3, M54 B30		246-082-008-025G	SWP-M-C	
02.03 -	M54 306 S3, M54 B30		246-086-001-007C	HLWP	Plug Number (T2): 3b

**3.0 si (195 kW | 3.0 Litre)**

01.06 -	N52 B30, N52 B30 A		246-082-008-025G	SWP-M-C	
01.06 -	N 52 B 30, N52B30A		246-086-001-007C	HLWP	Plug Number (T2): 3b

**M 3.2 (252 kW | 3.2 Litre)**

03.06 -	S54 326 S4, S54 B32		246-082-008-025G	SWP-M-C	
03.06 -	S 54 B 32, S54326S4		246-086-001-007C	HLWP	Plug Number (T2): 3b

**Z4 Coupe (E86)****3.0 si (195 kW | 3.0 Litre)**

03.06 -	N52 B30, N52 B30 A		246-082-008-025G	SWP-M-C	
03.06 -	N 52 B 30, N52B30A		246-086-001-007C	HLWP	Plug Number (T2): 3b

**M 3.2 (252 kW | 3.2 Litre)**

03.06 -	S54 326 S4, S54 B32		246-082-008-025G	SWP-M-C	
03.06 -	S 54 B 32, S54326S4		246-086-001-007C	HLWP	Plug Number (T2): 3b

**Z4 (E89)****sDrive20i (135 kW | 2.0 Litre)**

09.11 -	N20 B20 A		A2C53240479Z	SWP-M-C	
09.11 -	N20 B20 A		A2C53304876	HLWP	

**sDrive23i (150 kW | 2.5 Litre)**

05.09 -	N52 B25 A		A2C53240479Z	SWP-M-C	
05.09 -	N52 B25 A		A2C53304876	HLWP	

**sDrive28i (180 kW | 2.0 Litre)**

09.11 -	N20 B20 A		A2C53240479Z	SWP-M-C	
09.11 -	N20 B20 A		A2C53304876	HLWP	

**sDrive30i (190 kW | 3.0 Litre)**

05.09 -	N52 B30 A		A2C53240479Z	SWP-M-C	
05.09 -	N52 B30 A		A2C53304876	HLWP	

**sDrive35i (225 kW | 3.0 Litre)**

05.09 -	N54 B30 A		A2C53240479Z	SWP-M-C	
05.09 -	N54 B30 A		A2C53304876	HLWP	

**sDrive35is (250 kW | 3.0 Litre)**

09.10 -	N54 B30 A		A2C53240479Z	SWP-M-C	
09.10 -	N54 B30 A		A2C53304876	HLWP	

**Z8 (E52)****4.9 (294 kW | 4.9 Litre)**

06.00 - 06.03	S38 B49, S62 B50		246-082-008-025G	SWP-M-C	
---------------	------------------	--	------------------	---------	--

**2000-3.2 Coupe (E9)****2.5 CS (110 kW | 2.5 Litre)**

09.74 - 03.76	M 30 B 25		246-075-023-004C	SWP-M-G	Plug Number (T2): 1
---------------	-----------	--	------------------	---------	---------------------

**2800 CS (125 kW | 2.8 Litre)**

01.69 - 04.71	M 30 B 28		246-075-023-004C	SWP-M-G	Plug Number (T2): 1
---------------	-----------	--	------------------	---------	---------------------

**3.0 CS (132 kW | 3.0 Litre)**

05.71 - 03.76			246-075-023-004C	SWP-M-G	Plug Number (T2): 1
---------------	--	--	------------------	---------	---------------------

**3.0 Csi (147 kW | 3.0 Litre)**

07.71 - 03.76			246-075-023-004C	SWP-M-G	Plug Number (T2): 1
---------------	--	--	------------------	---------	---------------------

**2500-3.3 (E3)****2.8 L (125 kW | 2.8 Litre)**

02.75 - 04.77	M 30 B 28		246-075-023-004C	SWP-M-G	Plug Number (T2): 1
---------------	-----------	--	------------------	---------	---------------------

**2500 (110 kW | 2.5 Litre)**

10.68 - 04.77	M 30 B 25		246-075-023-004C	SWP-M-G	Plug Number (T2): 1
---------------	-----------	--	------------------	---------	---------------------

**2800 (125 kW | 2.8 Litre)**

10.68 - 07.75	M 30 B 28		246-075-023-004C	SWP-M-G	Plug Number (T2): 1
---------------	-----------	--	------------------	---------	---------------------

**3.0 L (132 kW | 3.0 Litre)**

02.75 - 04.77			246-075-023-004C	SWP-M-G	Plug Number (T2): 1
---------------	--	--	------------------	---------	---------------------

**3.0 S (132 kW | 3.0 Litre)**

05.71 - 04.77			246-075-023-004C	SWP-M-G	Plug Number (T2): 1
---------------	--	--	------------------	---------	---------------------



			<b>VDO</b>		
Date	Engine Code	Chassis No.	Article No.	Product	Information

**BMW****2500-3.3 (E3)****3.0 Si (143 kW | 3.0 Litre)**

10.75 → 04.77

246-075-023-004C

SWP-M-G

Plug Number (T2): 1

**3.0 Si (147 kW | 3.0 Litre)**

07.71 → 09.75

246-075-023-004C

SWP-M-G

Plug Number (T2): 1

**3.3 L (140 kW | 3.3 Litre)**

01.74 → 09.76

M 30 B 33 (35/40 INA)

246-075-023-004C

SWP-M-G

Plug Number (T2): 1

**CHEVROLET****AVEO Saloon (T300)****1.2 (51 kW | 1.2 Litre)**

03.11 →

A 12 XEL

A2C53240114

SWP-M-C

**1.2 (63 kW | 1.2 Litre)**

03.11 →

A 12 XER

A2C53240114

SWP-M-C

**1.3 D (55 kW | 1.3 Litre)**

07.11 →

LDV

A2C53240114

SWP-M-C

**1.3 D (70 kW | 1.3 Litre)**

07.11 →

LSF

A2C53240114

SWP-M-C

**1.4 (74 kW | 1.4 Litre)**

07.11 →

A 14 XER

A2C53240114

SWP-M-C

**1.6 (85 kW | 1.6 Litre)**

03.11 →

F16D4

A2C53240114

SWP-M-C

**CRUZE (J300)****1.6 (80 kW | 1.6 Litre)**

05.09 →

F16D3, LXT, LXV

A2C53240114

SWP-M-C

**1.6 (83 kW | 1.6 Litre)**

05.09 →

F16D4

A2C53240114

SWP-M-C

**1.6 (91 kW | 1.6 Litre)**

05.09 →

F16D4

A2C53240114

SWP-M-C

**1.7 D (96 kW | 1.7 Litre)**

01.12 →

LUD

A2C53240114

SWP-M-C

**1.8 (103 kW | 1.8 Litre)**

11.09 →

A2C53240114

SWP-M-C

**1.8 (104 kW | 1.8 Litre)**

05.09 →

2H0, F18D4

A2C53240114

SWP-M-C

**1.8 LPG (104 kW | 1.8 Litre)**

06.11 →

2H0

A2C53240114

SWP-M-C

**2.0 CDI (110 kW | 2.0 Litre)**

05.09 →

Z 20 S1

A2C53240114

SWP-M-C

**2.0 CDI (120 kW | 2.0 Litre)**

08.10 →

Z 20 D1

A2C53240114

SWP-M-C

**2.0 CDI (90 kW | 2.0 Litre)**

05.09 →

Z 20 S1

A2C53240114

SWP-M-C

**2.0 CDI (92 kW | 2.0 Litre)**

05.09 →

Z 20 S1

A2C53240114

SWP-M-C

**CRUZE Hatchback (J305)****1.6 (80 kW | 1.6 Litre)**

01.12 →

LXT

A2C53240114

SWP-M-C

**1.6 (91 kW | 1.6 Litre)**

06.11 →

F16D4

A2C53240114

SWP-M-C

**1.7 D (96 kW | 1.7 Litre)**

01.12 →

LUD

A2C53240114

SWP-M-C

**1.8 (104 kW | 1.8 Litre)**

06.11 →

F18D4

A2C53240114

SWP-M-C

**2.0 CDI (110 kW | 2.0 Litre)**

01.12 →

LLW

A2C53240114

SWP-M-C

**2.0 CDI (120 kW | 2.0 Litre)**

06.11 →

Z 20 D1

A2C53240114

SWP-M-C



			<b>VDO</b>		
Date	Engine Code	Chassis No.	Article No.	Product	Information

**CHEVROLET****MALIBU (V300)****2.0 D (118 kW | 2.0 Litre)**

04.12 → LBS A2C53240114 SWP-M-C

**2.4 (123 kW | 2.4 Litre)**

01.12 → LE9 A2C53240114 SWP-M-C

**ORLANDO (J309)****1.8 (104 kW | 1.8 Litre)**

02.11 → F18D4, 2H0 A2C53240114 SWP-M-C

**1.8 LPG (104 kW | 1.8 Litre)**

06.11 → 2H0 A2C53240114 SWP-M-C

**2.0 D (120 kW | 2.0 Litre)**

02.11 → Z 20 D1 A2C53240114 SWP-M-C

**2.0 D (96 kW | 2.0 Litre)**

02.11 → Z 20 D1 A2C53240114 SWP-M-C

**VOLT****EV 150 (111 kW | 0.0 Litre)**

11.11 → LUU A2C53240114 SWP-M-C

**CITROËN****AX (ZA-\_)****1.3 Sport (70 kW | 1.3 Litre)**

04.87 → 12.88 M4A X10-729-002-007 SWP-M-C Plug Number (T2): 11

**1.4 GTi (66 kW | 1.4 Litre)**

08.91 → 12.96 KFY (TU3FJ2) X10-729-002-007 SWP-M-C Plug Number (T2): 11

**1.4 GTi (69 kW | 1.4 Litre)**

06.91 → 12.96 KFZ (TU3FJ2) X10-729-002-007 SWP-M-C Plug Number (T2): 11

**1.4 GTi (74 kW | 1.4 Litre)**

06.91 → 12.92 KFZ (TU3FJ2) X10-729-002-007 SWP-M-C Plug Number (T2): 11

**10 (33 kW | 1.0 Litre)**

07.86 → 12.98 CDY (TU9M) X10-729-002-007 SWP-M-C Plug Number (T2): 11

**10 (37 kW | 1.0 Litre)**

02.87 → 12.98 CDZ (TU9M) X10-729-002-007 SWP-M-C Plug Number (T2): 11

**10 E (30 kW | 1.0 Litre)**

12.86 → 12.88 C3A X10-729-002-007 SWP-M-C Plug Number (T2): 11

**11 (40 kW | 1.1 Litre)**

12.86 → 04.94 H1B, H1A X10-729-002-007 SWP-M-C Plug Number (T2): 11

**11 (44 kW | 1.1 Litre)**

09.86 → 12.97 HDZ (TU1M), H1B X10-729-002-007 SWP-M-C Plug Number (T2): 11

**11 CAT (40 kW | 1.1 Litre)**

09.88 → 12.89 HAZ (TU1CP) X10-729-002-007 SWP-M-C Plug Number (T2): 11

**14 (44 kW | 1.4 Litre)**

12.86 → 12.88 KAY (TU3CP) X10-729-002-007 SWP-M-C Plug Number (T2): 11

**14 (49 kW | 1.4 Litre)**

06.88 → 12.89 K1F X10-729-002-007 SWP-M-C Plug Number (T2): 11

**14 (55 kW | 1.4 Litre)**04.87 → 04.97 KDX (TU3M/Z), KDY (TU3M),  
KDY (TU3FM), KDZ (TU3M/Z) X10-729-002-007 SWP-M-C Plug Number (T2): 11**14 (62 kW | 1.4 Litre)**

01.88 → 12.92 K2A, K2B X10-729-002-007 SWP-M-C Plug Number (T2): 11

**14 4x4 (55 kW | 1.4 Litre)**08.91 → 12.96 KDX (TU3M/Z), KDY (TU3M),  
KDY (TU3FM), KDZ (TU3M/Z) X10-729-002-007 SWP-M-C Plug Number (T2): 11**14 D (37 kW | 1.4 Litre)**

08.91 → 12.97 K9Y (TUD3Y) X10-729-002-007 SWP-M-C Plug Number (T2): 11

**14 D (38 kW | 1.4 Litre)**

09.88 → 06.92 K9A (TUD3) X10-729-002-007 SWP-M-C Plug Number (T2): 11

**15 D (40 kW | 1.5 Litre)**

08.94 → 12.97 VJY (TUD5) X10-729-002-007 SWP-M-C Plug Number (T2): 11



			<b>VDO</b>		
Date	Engine Code	Chassis No.	Article No.	Product	Information

**CITROËN****AX (ZA-\_)****15 D (43 kW | 1.5 Litre)**

08.94 - 12.97	VJZ (TUD5)		X10-729-002-007	SWP-M-C	Plug Number (T2): 11
---------------	------------	--	-----------------	---------	----------------------

**BERLINGO Box (M\_)****1.1 i (MAHDZ, MBHDZ, MBHFX) (44 kW | 1.1 Litre)**

07.96 -	HDZ (TU1M), HFX (TU1JP)		X10-729-002-007	SWP-M-C	Plug Number (T2): 11
---------	-------------------------	--	-----------------	---------	----------------------

**1.4 i (MBKFX, MBKFW) (55 kW | 1.4 Litre)**

07.96 -	KFX (TU3JP), KFW (TU3JP)		X10-729-002-007	SWP-M-C	Plug Number (T2): 11
---------	--------------------------	--	-----------------	---------	----------------------

**1.8 D (MBA9A, MCA9A) (43 kW | 1.8 Litre)**

07.96 -	A9A (XUD7)		X10-729-002-007	SWP-M-C	Plug Number (T2): 11
---------	------------	--	-----------------	---------	----------------------

**1.9 D (MBDJY) (51 kW | 1.9 Litre)**

07.96 -	DJY (XUD9A)		X10-729-002-007	SWP-M-C	Plug Number (T2): 11
---------	-------------	--	-----------------	---------	----------------------

**1.9 D 70 (MBWJZ, MCWJZ) (51 kW | 1.9 Litre)**

04.99 -	WJZ (DW8), WJY (DW8B)		X10-729-002-007	SWP-M-C	Plug Number (T2): 11
---------	-----------------------	--	-----------------	---------	----------------------

**1.9 D 70 4WD (MBWJZ, MCWJZ) (51 kW | 1.9 Litre)**

07.98 -	WJZ (DW8), WJY (DW8B)		X10-729-002-007	SWP-M-C	Plug Number (T2): 11
---------	-----------------------	--	-----------------	---------	----------------------

**2.0 HDI 90 (MBRHY, MCRHY) (66 kW | 2.0 Litre)**

12.99 -	RHY (DW10TD)		X10-729-002-007	SWP-M-C	Plug Number (T2): 11
---------	--------------	--	-----------------	---------	----------------------

**C3 (FC\_)****1.1 i (44 kW | 1.1 Litre)**

02.02 -	HFX (TU1JP)		A2C53030301	SWP-D-C	
---------	-------------	--	-------------	---------	--

**1.4 16V (65 kW | 1.4 Litre)**

12.03 -	KFU (ET3J4)		A2C53030301	SWP-D-C	
---------	-------------	--	-------------	---------	--

**1.4 16V HDi (66 kW | 1.4 Litre)**

02.02 -	8HY (DV4TED4)		A2C53030301	SWP-D-C	
---------	---------------	--	-------------	---------	--

**1.4 HDi (50 kW | 1.4 Litre)**

02.02 -	8HX (DV4TD)		A2C53030301	SWP-D-C	
---------	-------------	--	-------------	---------	--

**1.4 i (54 kW | 1.4 Litre)**

02.02 -	KFV (TU3JP)		A2C53030301	SWP-D-C	
---------	-------------	--	-------------	---------	--

**1.4 i Bivalent (54 kW | 1.4 Litre)**

02.02 -	KFV (TU3JP)		A2C53030301	SWP-D-C	
---------	-------------	--	-------------	---------	--

**1.6 16V (80 kW | 1.6 Litre)**

02.02 -	NFU (TU5JP4)		A2C53030301	SWP-D-C	
---------	--------------	--	-------------	---------	--

**1.6 16V HDi (66 kW | 1.6 Litre)**

10.05 -	9HX (DV6ATED4)		A2C53030301	SWP-D-C	
---------	----------------	--	-------------	---------	--

**1.6 16V HDi (80 kW | 1.6 Litre)**

09.05 -	DV6TED4		A2C53030301	SWP-D-C	
---------	---------	--	-------------	---------	--

**C3 II****1.1 (44 kW | 1.1 Litre)**

11.09 -	HFX (TU1JP)		A2C53030301	SWP-D-C	
---------	-------------	--	-------------	---------	--

**1.4 (54 kW | 1.4 Litre)**

11.09 -	KFT (TU3A)		A2C53030301	SWP-D-C	
---------	------------	--	-------------	---------	--

**1.4 HDi 70 (50 kW | 1.4 Litre)**

11.09 -	8HZ (DV4TD)		A2C53030301	SWP-D-C	
---------	-------------	--	-------------	---------	--

**1.4 VTi 95 (70 kW | 1.4 Litre)**

11.09 -	8FP (EP3)		A2C53030301	SWP-D-C	
---------	-----------	--	-------------	---------	--

**1.6 HDi (68 kW | 1.6 Litre)**

11.09 -	9HP (DV6DTE)		A2C53030301	SWP-D-C	
---------	--------------	--	-------------	---------	--

**1.6 HDi 110 (82 kW | 1.6 Litre)**

11.09 -	9HR (DV6C)		A2C53030301	SWP-D-C	
---------	------------	--	-------------	---------	--

**1.6 HDi 90 (66 kW | 1.6 Litre)**

11.09 -	DV6ATED4		A2C53030301	SWP-D-C	
---------	----------	--	-------------	---------	--

**1.6 VTi 120 (88 kW | 1.6 Litre)**

11.09 -	5FS (EP6C)		A2C53030301	SWP-D-C	
---------	------------	--	-------------	---------	--

**C4 (LC\_)****1.4 16V (65 kW | 1.4 Litre)**

11.04 -	KFU (ET3J4)		A2C53030301	SWP-D-C	
---------	-------------	--	-------------	---------	--

**1.6 16V (80 kW | 1.6 Litre)**

11.04 -	NFU (TU5JP4)		A2C53030301	SWP-D-C	
---------	--------------	--	-------------	---------	--



			<b>VDO</b>		
Date	Engine Code	Chassis No.	Article No.	Product	Information

**CITROËN****C4 (LC\_)****1.6 16V Bio-Flex (80 kW | 1.6 Litre)**

09.07 -- NFU (TU5JP4) A2C53030301 SWP-D-C

**1.6 HDi (66 kW | 1.6 Litre)**

11.04 -- 9HX (DV6ATED4) A2C53030301 SWP-D-C

**1.6 HDi (80 kW | 1.6 Litre)**

11.04 -- 9HY (DV6TED4), 9HZ-DV6TED4, DV6TED4 A2C53030301 SWP-D-C

**1.6 THP 140 (103 kW | 1.6 Litre)**

07.08 -- 5FT (EP6DT) A2C53030301 SWP-D-C

**1.6 THP 150 (110 kW | 1.6 Litre)**

07.08 -- 5FX (EP6DT) A2C53030301 SWP-D-C

**1.6 VTi 120 (88 kW | 1.6 Litre)**

07.08 -- 5FW (EP6) A2C53030301 SWP-D-C

**2.0 16V (100 kW | 2.0 Litre)**

11.04 -- RFN (EW10J4) A2C53030301 SWP-D-C

**2.0 16V (103 kW | 2.0 Litre)**

11.04 -- EW10A, RFJ-EW10A A2C53030301 SWP-D-C

**2.0 16V (130 kW | 2.0 Litre)**

11.04 -- EW10J4S, RFK (EW10J4S) A2C53030301 SWP-D-C

**2.0 HDi (100 kW | 2.0 Litre)**

11.04 -- DW10BTED4, RHR (DW10BTED4) A2C53030301 SWP-D-C

**2.0 HDi (103 kW | 2.0 Litre)**

07.08 -- RHF (DW10BTED4) A2C53030301 SWP-D-C

**C4 Picasso (UD\_)****1.6 16V (110 kW | 1.6 Litre)**

07.08 -- 5FX (EP6DT) A2C53030301 SWP-D-C

**1.6 HDi (80 kW | 1.6 Litre)**

02.07 -- 9HY (DV6TED4), 9HZ-DV6TED4 A2C53030301 SWP-D-C

**1.6 THP 140 (103 kW | 1.6 Litre)**

07.08 -- 5FT (EP6DT) A2C53030301 SWP-D-C

**1.6 VTi 120 (88 kW | 1.6 Litre)**

07.08 -- 5FW (EP6) A2C53030301 SWP-D-C

**1.8 i 16V (92 kW | 1.8 Litre)**

02.07 -- 6FY-EW7A A2C53030301 SWP-D-C

**2.0 HDi 138 (100 kW | 2.0 Litre)**

02.07 -- RHJ-DW10BTED4, RHR (DW10BTED4) A2C53030301 SWP-D-C

**2.0 HDi 150 (110 kW | 2.0 Litre)**

07.09 -- A2C53030301 SWP-D-C

**2.0 i 16V (103 kW | 2.0 Litre)**

02.07 -- RFJ-EW10A A2C53030301 SWP-D-C

**C4 Grand Picasso (UA\_)****1.6 16V (103 kW | 1.6 Litre)**

07.08 -- 5FT (EP6DT) A2C53030301 SWP-D-C

**1.6 16V (110 kW | 1.6 Litre)**

10.08 -- 5FX (EP6DT) A2C53030301 SWP-D-C

**1.6 HDi (80 kW | 1.6 Litre)**

10.06 -- 9HY (DV6TED4), 9HZ-DV6TED4 A2C53030301 SWP-D-C

**1.6 VTi 120 (88 kW | 1.6 Litre)**

07.08 -- 5FW (EP6) A2C53030301 SWP-D-C

**1.8 i 16V (92 kW | 1.8 Litre)**

10.06 -- 6FY-EW7A A2C53030301 SWP-D-C

**2.0 HDi 138 (100 kW | 2.0 Litre)**

10.06 -- RHJ-DW10BTED4, RHR (DW10BTED4) A2C53030301 SWP-D-C

**2.0 HDi 150 (110 kW | 2.0 Litre)**

07.09 -- A2C53030301 SWP-D-C

**2.0 i 16V (103 kW | 2.0 Litre)**

10.06 -- RFJ-EW10A A2C53030301 SWP-D-C



			<b>VDO</b>		
Date	Engine Code	Chassis No.	Article No.	Product	Information

**CITROËN****C5 (DC\_)****1.8 16V (DC6FZB, DC6FZE) (85 kW | 1.8 Litre)**

03.01 - 08.04 6FZ (EW7J4) A2C53030301 SWP-D-C

**2.0 16V (DCRFNC, DCRFNF) (100 kW | 2.0 Litre)**

03.01 - 08.04 RFN (EW10J4) A2C53030301 SWP-D-C

**2.0 16V HPi (DCRLZB) (103 kW | 2.0 Litre)**

03.01 - 08.04 RLZ (EW10D) A2C53030301 SWP-D-C

**2.0 HDi (79 kW | 2.0 Litre)**03.01 - 08.04 RHS (DW10ATED),  
RHZ (DW10ATED) A2C53030301 SWP-D-C**2.0 HDi (DCRHYP) (66 kW | 2.0 Litre)**

03.01 - 08.04 RHY (DW10TD) A2C53030301 SWP-D-C

**2.0 HDi (DCRHZB, DCRHZE) (80 kW | 2.0 Litre)**

03.01 - 08.04 RHZ (DW10ATED) A2C53030301 SWP-D-C

**2.2 HDi (DC4HXB, DC4HXE) (98 kW | 2.2 Litre)**

03.01 - 08.04 4HX (DW12TED4/FAP) A2C53030301 SWP-D-C

**3.0 V6 (DCXFXC, DCXFXF) (152 kW | 3.0 Litre)**

03.01 - 08.04 XFX (ES9J4S) A2C53030301 SWP-D-C

**C5 (RC\_)****1.6 HDi (RC8HZB) (80 kW | 1.6 Litre)**

09.04 - DV6TED4 A2C53030301 SWP-D-C

**1.8 16V (92 kW | 1.8 Litre)**

09.05 - 6FY-EW7A A2C53030301 SWP-D-C

**1.8 16V (RC6FZB) (85 kW | 1.8 Litre)**

09.04 - 6FZ (EW7J4) A2C53030301 SWP-D-C

**2.0 16V (RCRFJB, RCRFJC) (103 kW | 2.0 Litre)**

09.04 - EW10A, RFJ-EW10A A2C53030301 SWP-D-C

**2.0 HDi (RCRHRH) (100 kW | 2.0 Litre)**

09.04 - DW10BTED4 A2C53030301 SWP-D-C

**2.2 HDi (125 kW | 2.2 Litre)**

04.06 - 4HT (DW12BTED4) A2C53030301 SWP-D-C

**2.2 HDi (RC4HXE) (98 kW | 2.2 Litre)**

09.04 - 4HX (DW12TED4/FAP) A2C53030301 SWP-D-C

**3.0 V6 (RCXFUF) (152 kW | 3.0 Litre)**

09.04 - XFV (ES9A), XFX (ES9J4S) A2C53030301 SWP-D-C

**C5 (RD\_)****1.6 HDi (80 kW | 1.6 Litre)**

02.08 - DV6TED4 A2C53030219 SWP-M-C

**1.6 HDi 110 (82 kW | 1.6 Litre)**

07.10 - 9HR (DV6C) A2C53030219 SWP-M-C

**1.6 THP 155 (115 kW | 1.6 Litre)**

04.09 - 5FV (EP6DT) A2C53030219 SWP-M-C

**1.6 VTi 120 (88 kW | 1.6 Litre)**

07.10 - 5FS (EP6C) A2C53030219 SWP-M-C

**1.8 16V (92 kW | 1.8 Litre)**

02.08 - 6FY-EW7A A2C53030219 SWP-M-C

**2.0 16V (103 kW | 2.0 Litre)**

02.08 - EW10A, RFJ-EW10A A2C53030219 SWP-M-C

**2.0 16V BioFlex (103 kW | 2.0 Litre)**

02.08 - RFJ-EW10A A2C53030219 SWP-M-C

**2.0 HDi (100 kW | 2.0 Litre)**

02.08 - DW10BTED4 A2C53030219 SWP-M-C

**2.0 HDi 140 (103 kW | 2.0 Litre)**

04.09 - RHF (DW10BTED4) A2C53030219 SWP-M-C

**2.0 HDi 165 (120 kW | 2.0 Litre)**

04.09 - RHH (DW10CTED4) A2C53030219 SWP-M-C

**2.2 HDi (125 kW | 2.2 Litre)**

02.08 - 4HT (DW12BTED4) A2C53030219 SWP-M-C

**2.2 HDi 200 (150 kW | 2.2 Litre)**

07.10 - 4HL (DW12C) A2C53030219 SWP-M-C

**2.7 HDi (150 kW | 2.7 Litre)**

02.08 - DT17ED4 A2C53030219 SWP-M-C



			<b>VDO</b>		
Date	Engine Code	Chassis No.	Article No.	Product	Information

**CITROËN****C5 (RD\_)****3.0 HDi 240 (177 kW | 3.0 Litre)**

04.09 - DT20C A2C53030219 SWP-M-C

**3.0 V6 (155 kW | 3.0 Litre)**

02.08 - XFU (ES9A) A2C53030219 SWP-M-C

**C5 Break (TD\_)****1.6 HDi (80 kW | 1.6 Litre)**

02.08 - 9HZ-DV6TED4, DV6TED4 A2C53030219 SWP-M-C

**1.6 HDi 110 (82 kW | 1.6 Litre)**

07.10 - 9HR (DV6C) A2C53030219 SWP-M-C

**1.6 THP 155 (115 kW | 1.6 Litre)**

04.09 - 5FV (EP6DT) A2C53030219 SWP-M-C

**1.6 VTI 120 (88 kW | 1.6 Litre)**

07.10 - 5FS (EP6C) A2C53030219 SWP-M-C

**1.8 16V (92 kW | 1.8 Litre)**

02.08 - 6FY-EW7A A2C53030219 SWP-M-C

**2.0 16V (103 kW | 2.0 Litre)**

02.08 - EW10A, RFJ-EW10A A2C53030219 SWP-M-C

**2.0 16V BioFlex (103 kW | 2.0 Litre)**

02.08 - RFJ (EW10A) A2C53030219 SWP-M-C

**2.0 HDi (100 kW | 2.0 Litre)**

02.08 - DW10BTED4, RHR (DW10BTED4) A2C53030219 SWP-M-C

**2.0 HDi 140 (103 kW | 2.0 Litre)**

04.09 - RHF (DW10BTED4) A2C53030219 SWP-M-C

**2.0 HDi 165 (120 kW | 2.0 Litre)**

04.09 - RHH (DW10CTED4) A2C53030219 SWP-M-C

**2.2 HDi (125 kW | 2.2 Litre)**

02.08 - 4HT (DW12BTED4) A2C53030219 SWP-M-C

**2.2 HDi 200 (150 kW | 2.2 Litre)**

07.10 - 4HL (DW12C) A2C53030219 SWP-M-C

**2.7 HDi (150 kW | 2.7 Litre)**

02.08 - DT17ED4, UHZ (DT17BTED4) A2C53030219 SWP-M-C

**3.0 HDi 240 (177 kW | 3.0 Litre)**

04.09 - DT20C A2C53030219 SWP-M-C

**3.0 V6 (155 kW | 3.0 Litre)**

02.08 - XFU (ES9A) A2C53030219 SWP-M-C

**C6 (TD\_)****2.2 HDi (125 kW | 2.2 Litre)**

06.06 - 4HT (DW12BTED4) A2C53030219 SWP-M-C

**2.7 HDi (150 kW | 2.7 Litre)**

09.05 - DT17ED4, UHZ (DT17BTED4) A2C53030219 SWP-M-C

**3.0 HDi (177 kW | 3.0 Litre)**

04.09 - DT20C A2C53030219 SWP-M-C

**3.0 V6 (155 kW | 3.0 Litre)**

09.05 - ES9J4S, XFU (ES9A) A2C53030219 SWP-M-C

**C8 (EA\_, EB\_)****2.0 (100 kW | 2.0 Litre)**

07.02 - RFN (EW10J4) A2C53030301 SWP-D-C

**2.0 16V (103 kW | 2.0 Litre)**

09.05 - RFJ-EW10A A2C53030301 SWP-D-C

**2.0 16V (104 kW | 2.0 Litre)**

09.05 - RFJ-EW10A A2C53030301 SWP-D-C

**2.0 HDi (79 kW | 2.0 Litre)**07.02 - RHM (DW10ATED4),  
RHT (DW10ATED4),  
RHW (DW10ATED4) A2C53030301 SWP-D-C**2.0 HDi (88 kW | 2.0 Litre)**

02.07 - RHK (DW10UTED4) A2C53030301 SWP-D-C

**2.0 HDi 135 (100 kW | 2.0 Litre)**

03.06 - RHR (DW10BTED4) A2C53030301 SWP-D-C



			<b>VDO</b>		
Date	Engine Code	Chassis No.	Article No.	Product	Information

**CITROËN****C8 (EA\_, EB\_)****2.0 HDi 165 (120 kW | 2.0 Litre)**

03.06 -	RHE (DW10CTED4), RHH (DW10CTED4)		A2C53030301	SWP-D-C	
---------	-------------------------------------	--	-------------	---------	--

**2.2 (116 kW | 2.2 Litre)**

07.02 -	3FZ (EW12J4)		A2C53030301	SWP-D-C	
---------	--------------	--	-------------	---------	--

**2.2 HDi (125 kW | 2.2 Litre)**

06.06 -	4HT (DW12BTED4)		A2C53030301	SWP-D-C	
---------	-----------------	--	-------------	---------	--

**2.2 HDi (94 kW | 2.2 Litre)**

07.02 -	4HW (DW12TED4)		A2C53030301	SWP-D-C	
---------	----------------	--	-------------	---------	--

**3.0 V6 (150 kW | 3.0 Litre)**

07.02 -	XFX (ES9J4S)		A2C53030301	SWP-D-C	
---------	--------------	--	-------------	---------	--

**JUMPY (U6U)****1.6 (58 kW | 1.6 Litre)**

10.95 -	220 A2.000, 1580 SPI		X10-729-002-007	SWP-M-C	Plug Number (T2): 11
---------	----------------------	--	-----------------	---------	----------------------

**1.9 D (51 kW | 1.9 Litre)**

10.95 - 04.98	D9B (XUD9A/U)		X10-729-002-007	SWP-M-C	Plug Number (T2): 11
---------------	---------------	--	-----------------	---------	----------------------

**1.9 D 70 (51 kW | 1.9 Litre)**

04.98 -	WJZ (DW8)		X10-729-002-007	SWP-M-C	Plug Number (T2): 11
---------	-----------	--	-----------------	---------	----------------------

**1.9 TD (66 kW | 1.9 Litre)**

10.95 -	DHX (XUD9TF/BTF)		X10-729-002-007	SWP-M-C	Plug Number (T2): 11
---------	------------------	--	-----------------	---------	----------------------

**1.9 TD (68 kW | 1.9 Litre)**

04.96 -	D8B (XUD9TF)		X10-729-002-007	SWP-M-C	Plug Number (T2): 11
---------	--------------	--	-----------------	---------	----------------------

**2.0 (100 kW | 2.0 Litre)**

04.00 - 12.06	RFN (EW10J4)		X10-729-002-007	SWP-M-C	Plug Number (T2): 11
---------------	--------------	--	-----------------	---------	----------------------

**2.0 HDi 110 (80 kW | 2.0 Litre)**

03.00 -	RHZ (DW10ATED)		X10-729-002-007	SWP-M-C	Plug Number (T2): 11
---------	----------------	--	-----------------	---------	----------------------

**2.0 HDi 95 (69 kW | 2.0 Litre)**

10.99 -	RHX (DW10BTED)		X10-729-002-007	SWP-M-C	Plug Number (T2): 11
---------	----------------	--	-----------------	---------	----------------------

**2.0 i 16V (102 kW | 2.0 Litre)**

03.00 -			X10-729-002-007	SWP-M-C	Plug Number (T2): 11
---------	--	--	-----------------	---------	----------------------

**JUMPY Box (BS\_, BT\_, BY\_, BZ\_)****1.6 i (58 kW | 1.6 Litre)**

10.95 -	220 A2.000, 1580 SPI		X10-729-002-007	SWP-M-C	Plug Number (T2): 11
---------	----------------------	--	-----------------	---------	----------------------

**1.9 D 70 (51 kW | 1.9 Litre)**

04.98 -	WJZ (DW8)		X10-729-002-007	SWP-M-C	Plug Number (T2): 11
---------	-----------	--	-----------------	---------	----------------------

**1.9 TD (66 kW | 1.9 Litre)**

10.95 -	DHX (XUD9TF/BTF)		X10-729-002-007	SWP-M-C	Plug Number (T2): 11
---------	------------------	--	-----------------	---------	----------------------

**2.0 HDi 95 (69 kW | 2.0 Litre)**

10.99 -	RHX (DW10BTED)		X10-729-002-007	SWP-M-C	Plug Number (T2): 11
---------	----------------	--	-----------------	---------	----------------------

**2.0 i 16V (102 kW | 2.0 Litre)**

03.00 -			X10-729-002-007	SWP-M-C	Plug Number (T2): 11
---------	--	--	-----------------	---------	----------------------

**JUMPY Platform/Chassis (BU\_, BV\_, BW\_, BX\_)****1.9 TD (68 kW | 1.9 Litre)**

10.99 -	D8B (XUD9TF)		X10-729-002-007	SWP-M-C	Plug Number (T2): 11
---------	--------------	--	-----------------	---------	----------------------

**2.0 HDi 95 (69 kW | 2.0 Litre)**

10.99 -	RHX (DW10BTED)		X10-729-002-007	SWP-M-C	Plug Number (T2): 11
---------	----------------	--	-----------------	---------	----------------------

**JUMPY****1.6 HDi 90 (66 kW | 1.6 Litre)**

01.07 -	9HU (DV6UTED4)		A2C53030301	SWP-D-C	
---------	----------------	--	-------------	---------	--

**2.0 HDi 120 (88 kW | 2.0 Litre)**

01.07 -	RHK (DW10UTED4)		A2C53030301	SWP-D-C	
---------	-----------------	--	-------------	---------	--

**2.0 HDi 140 (100 kW | 2.0 Litre)**

01.07 -	RHR (DW10BTED4)		A2C53030301	SWP-D-C	
---------	-----------------	--	-------------	---------	--

**2.0 HDi 165 (120 kW | 2.0 Litre)**

07.10 -	RHH (DW10CTED4)		A2C53030301	SWP-D-C	
---------	-----------------	--	-------------	---------	--

**2.0 i (103 kW | 2.0 Litre)**

01.07 -	RFH (EW10A)		A2C53030301	SWP-D-C	
---------	-------------	--	-------------	---------	--





			<b>VDO</b>		
Date	Engine Code	Chassis No.	Article No.	Product	Information

**CITROËN****XANTIA (X1)**

<b>1.6 i (65 kW   1.6 Litre)</b>					
03.93 - 01.98	BFZ (XU5JP)		X10-729-002-007	SWP-M-C	Plug Number (T2): 11
<b>1.8 i (66 kW   1.8 Litre)</b>					
04.97 - 01.98	LFX (XU7JB)		X10-729-002-007	SWP-M-C	Plug Number (T2): 11
<b>1.8 i (74 kW   1.8 Litre)</b>					
03.93 - 01.98	LFZ (XU7JP)		X10-729-002-007	SWP-M-C	Plug Number (T2): 11
<b>1.8 i 16V (81 kW   1.8 Litre)</b>					
06.95 - 01.98	LFY (XU7JP4)		X10-729-002-007	SWP-M-C	Plug Number (T2): 11
<b>1.9 D (50 kW   1.9 Litre)</b>					
06.94 - 01.98	DJZ (XUD9Y)		X10-729-002-007	SWP-M-C	Plug Number (T2): 11
<b>1.9 D (51 kW   1.9 Litre)</b>					
06.94 - 01.98	D9B (XUD9A/L)		X10-729-002-007	SWP-M-C	Plug Number (T2): 11
<b>1.9 SD (55 kW   1.9 Litre)</b>					
02.96 - 01.98	DHW (XUD9SD)		X10-729-002-007	SWP-M-C	Plug Number (T2): 11
<b>1.9 Turbo D (66 kW   1.9 Litre)</b>					
10.94 - 01.98	DHY (XUD9TE/Y), DHX (XUD9TF/BTF)		X10-729-002-007	SWP-M-C	Plug Number (T2): 11
<b>2.0 i (89 kW   2.0 Litre)</b>					
03.93 - 01.98	RFX (XU10J2C)		X10-729-002-007	SWP-M-C	Plug Number (T2): 11
<b>2.0 i 16V (110 kW   2.0 Litre)</b>					
06.94 - 01.98	RFT (XU10J4/Z)		X10-729-002-007	SWP-M-C	Plug Number (T2): 11
<b>2.0 i 16V (112 kW   2.0 Litre)</b>					
03.93 - 01.98	RFY (XU10J4/Z)		X10-729-002-007	SWP-M-C	Plug Number (T2): 11
<b>2.0 i 16V (97 kW   2.0 Litre)</b>					
06.95 - 01.98	RFV (XU10J4R)		X10-729-002-007	SWP-M-C	Plug Number (T2): 11
<b>2.0 Turbo (108 kW   2.0 Litre)</b>					
06.95 - 01.98	RGX (XU10J2TE)		X10-729-002-007	SWP-M-C	Plug Number (T2): 11
<b>2.1 Turbo D 12V (80 kW   2.1 Litre)</b>					
06.95 - 01.98	P8C (XUD11BTE)		X10-729-002-007	SWP-M-C	Plug Number (T2): 11
<b>3.0 i 24V (140 kW   3.0 Litre)</b>					
01.97 - 01.98	XFZ (ES9J4)		X10-729-002-007	SWP-M-C	Plug Number (T2): 11

**XANTIA Break (X1)**

<b>1.8 i (66 kW   1.8 Litre)</b>					
04.97 - 01.98	LFX (XU7JB)		X10-729-002-007	SWP-M-C	Plug Number (T2): 11
<b>1.8 i (74 kW   1.8 Litre)</b>					
06.95 - 01.98	LFZ (XU7JP)		X10-729-002-007	SWP-M-C	Plug Number (T2): 11
<b>1.8 i 16V (81 kW   1.8 Litre)</b>					
06.95 - 01.98	LFY (XU7JP4)		X10-729-002-007	SWP-M-C	Plug Number (T2): 11
<b>1.9 SD (55 kW   1.9 Litre)</b>					
04.97 - 01.98	DHW (XUD9SD)		X10-729-002-007	SWP-M-C	Plug Number (T2): 11
<b>1.9 Turbo D (66 kW   1.9 Litre)</b>					
06.95 - 01.98	DHX (XUD9TF/BTF), D8B (XUD9TF), DHY (XUD9TE/Y)		X10-729-002-007	SWP-M-C	Plug Number (T2): 11
<b>2.0 i (89 kW   2.0 Litre)</b>					
06.95 - 01.98	RFX (XU10J2C)		X10-729-002-007	SWP-M-C	Plug Number (T2): 11
<b>2.0 i 16V (97 kW   2.0 Litre)</b>					
06.95 - 01.98	RFV (XU10J4R)		X10-729-002-007	SWP-M-C	Plug Number (T2): 11
<b>2.0 Turbo (108 kW   2.0 Litre)</b>					
06.95 - 01.98	RGX (XU10J2TE)		X10-729-002-007	SWP-M-C	Plug Number (T2): 11
<b>2.1 Turbo D 12V (80 kW   2.1 Litre)</b>					
06.96 - 01.98	P8C (XUD11BTE)		X10-729-002-007	SWP-M-C	Plug Number (T2): 11

**XANTIA (X2)**

<b>1.8 i (66 kW   1.8 Litre)</b>					
01.98 - 04.03	LFX (XU7JB)		X10-729-002-007	SWP-M-C	Plug Number (T2): 11
<b>1.8 i 16V (81 kW   1.8 Litre)</b>					
01.98 - 04.03	LFY (XU7JP4)		X10-729-002-007	SWP-M-C	Plug Number (T2): 11
<b>1.9 SD (55 kW   1.9 Litre)</b>					
01.98 - 04.03	DHW (XUD9SD)		X10-729-002-007	SWP-M-C	Plug Number (T2): 11
<b>1.9 Turbo D (66 kW   1.9 Litre)</b>					
01.98 - 04.03	DHY (XUD9TE/Y), DHX (XUD9TF/BTF)		X10-729-002-007	SWP-M-C	Plug Number (T2): 11



			<b>VDO</b>		
Date	Engine Code	Chassis No.	Article No.	Product	Information

**CITROËN****XANTIA (X2)****2.0 HDI 109 (80 kW | 2.0 Litre)**

02.99 - 04.03 RHZ (DW10ATED) X10-729-002-007 SWP-M-C Plug Number (T2): 11

**2.0 HDI 90 (66 kW | 2.0 Litre)**

03.99 - 04.03 RHY (DW10TD) X10-729-002-007 SWP-M-C Plug Number (T2): 11

**2.0 i (89 kW | 2.0 Litre)**

01.98 - 04.03 RFX (XU10J2C) X10-729-002-007 SWP-M-C Plug Number (T2): 11

**2.0 i 16V (97 kW | 2.0 Litre)**

01.98 - 04.03 RFV (XU10J4R) X10-729-002-007 SWP-M-C Plug Number (T2): 11

**2.0 Turbo (108 kW | 2.0 Litre)**

01.98 - 04.03 RGX (XU10J2TE) X10-729-002-007 SWP-M-C Plug Number (T2): 11

**2.1 Turbo D 12V (80 kW | 2.1 Litre)**

01.98 - 02.99 P8C (XUD11BTE) X10-729-002-007 SWP-M-C Plug Number (T2): 11

**3.0 V6 (140 kW | 3.0 Litre)**

01.98 - 04.03 XFZ (ES9J4) X10-729-002-007 SWP-M-C Plug Number (T2): 11

**XANTIA Break (X2)****1.8 i (66 kW | 1.8 Litre)**

01.98 - 04.03 LFX (XU7JB) X10-729-002-007 SWP-M-C Plug Number (T2): 11

**1.8 i 16V (81 kW | 1.8 Litre)**

01.98 - 04.03 LFY (XU7JP4) X10-729-002-007 SWP-M-C Plug Number (T2): 11

**1.9 SD (55 kW | 1.9 Litre)**

01.98 - 04.03 DHW (XUD9SD) X10-729-002-007 SWP-M-C Plug Number (T2): 11

**1.9 Turbo D (66 kW | 1.9 Litre)**

01.98 - 04.03 DHX (XUD9TF/BTF), D8B (XUD9TF) X10-729-002-007 SWP-M-C Plug Number (T2): 11

**2.0 HDI 109 (80 kW | 2.0 Litre)**

02.99 - 04.03 RHZ (DW10ATED) X10-729-002-007 SWP-M-C Plug Number (T2): 11

**2.0 HDI 90 (66 kW | 2.0 Litre)**

03.99 - 04.03 RHY (DW10TD) X10-729-002-007 SWP-M-C Plug Number (T2): 11

**2.0 i (89 kW | 2.0 Litre)**

01.98 - 04.03 RFX (XU10J2C) X10-729-002-007 SWP-M-C Plug Number (T2): 11

**2.0 i 16V (97 kW | 2.0 Litre)**

01.98 - 04.03 RFV (XU10J4R) X10-729-002-007 SWP-M-C Plug Number (T2): 11

**2.0 Turbo (108 kW | 2.0 Litre)**

01.98 - 04.03 RGX (XU10J2TE) X10-729-002-007 SWP-M-C Plug Number (T2): 11

**2.1 Turbo D 12V (80 kW | 2.1 Litre)**

01.98 - 02.99 P8C (XUD11BTE) X10-729-002-007 SWP-M-C Plug Number (T2): 11

**3.0 V6 (140 kW | 3.0 Litre)**

01.98 - 04.03 XFZ (ES9J4) X10-729-002-007 SWP-M-C Plug Number (T2): 11

**XM (Y3)****2.0 (84 kW | 2.0 Litre)**

05.89 - 04.94 X10-729-002-007 SWP-M-C Plug Number (T2): 11

**2.0 i (79 kW | 2.0 Litre)**

05.89 - 04.94 RDZ (XU10MZ) X10-729-002-007 SWP-M-C Plug Number (T2): 11

**2.0 i (89 kW | 2.0 Litre)**

05.89 - 06.94 RFZ (XU10J2) X10-729-002-007 SWP-M-C Plug Number (T2): 11

**2.0 i Turbo (104 kW | 2.0 Litre)**

09.92 - 06.94 RGY (XU10J2TE/Z) X10-729-002-007 SWP-M-C Plug Number (T2): 11

**2.1 D 12V (60 kW | 2.1 Litre)**

05.89 - 06.94 P9A (XUD11A) X10-729-002-007 SWP-M-C Plug Number (T2): 11

**2.1 TD 12V (80 kW | 2.1 Litre)**

05.89 - 06.94 P8A (XUD11ATE), PHZ (XUD11ATE), PJZ (XUD11ATE) X10-729-002-007 SWP-M-C Plug Number (T2): 11

**3.0 V6 (123 kW | 3.0 Litre)**

05.89 - 06.94 UFZ (ZPJ/Z), SFZ (ZPJ/Z) X10-729-002-007 SWP-M-C Plug Number (T2): 11

**3.0 V6 24V (147 kW | 3.0 Litre)**

07.90 - 06.94 SKZ (ZPJ4/Z), UKZ (ZPJ4/Z) X10-729-002-007 SWP-M-C Plug Number (T2): 11

**XM Break (Y3)****2.0 i (89 kW | 2.0 Litre)**

11.91 - 04.94 RFZ (XU10J2) X10-729-002-007 SWP-M-C Plug Number (T2): 11

**2.0 i (Y3A) (79 kW | 2.0 Litre)**

11.91 - 04.94 RDZ (XU10MZ), XU102C X10-729-002-007 SWP-M-C Plug Number (T2): 11



			<b>VDO</b>		
Date	Engine Code	Chassis No.	Article No.	Product	Information

**CITROËN****XM Break (Y3)****2.0 Turbo (104 kW | 2.0 Litre)**

09.92 - 04.94 RGY (XU10J2TE/Z) X10-729-002-007 SWP-M-C Plug Number (T2): 11

**2.1 D 12V (60 kW | 2.1 Litre)**

11.91 - 04.94 P9A (XUD11A) X10-729-002-007 SWP-M-C Plug Number (T2): 11

**2.1 TD 12V (80 kW | 2.1 Litre)**11.91 - 04.94 P8A (XUD11ATE),  
PHZ (XUD11ATE),  
PJZ (XUD11ATE), P8C (XUD11BTE) X10-729-002-007 SWP-M-C Plug Number (T2): 11**3.0 V6 (123 kW | 3.0 Litre)**

11.91 - 04.94 SFZ (ZPJ/Z), UFZ (ZPJ/Z) X10-729-002-007 SWP-M-C Plug Number (T2): 11

**XM (Y4)****2.0 i 16V (97 kW | 2.0 Litre)**

05.94 - 10.00 RFV (XU10J4R) X10-729-002-007 SWP-M-C Plug Number (T2): 11

**2.0 Turbo (108 kW | 2.0 Litre)**

05.94 - 10.00 RGX (XU10J2TE) X10-729-002-007 SWP-M-C Plug Number (T2): 11

**2.1 TD 12V (80 kW | 2.1 Litre)**05.94 - 10.00 P8A (XUD11ATE),  
PHZ (XUD11ATE),  
PJZ (XUD11ATE), P8C (XUD11BTE) X10-729-002-007 SWP-M-C Plug Number (T2): 11**2.5 TD (95 kW | 2.5 Litre)**

05.94 - 10.00 THY (DK5ATE) X10-729-002-007 SWP-M-C Plug Number (T2): 11

**3.0 V6 (123 kW | 3.0 Litre)**

05.94 - 10.00 UFZ (ZPJ/Z), SFZ (ZPJ/Z) X10-729-002-007 SWP-M-C Plug Number (T2): 11

**3.0 V6 (140 kW | 3.0 Litre)**

04.97 - 10.00 XFZ (ES9J4) X10-729-002-007 SWP-M-C Plug Number (T2): 11

**3.0 V6 24V (147 kW | 3.0 Litre)**

05.94 - 10.00 SKZ (ZPJ4/Z), UKZ (ZPJ4/Z) X10-729-002-007 SWP-M-C Plug Number (T2): 11

**XM Break (Y4)****2.0 i 16V (97 kW | 2.0 Litre)**

05.94 - 10.00 RFV (XU10J4R) X10-729-002-007 SWP-M-C Plug Number (T2): 11

**2.0 Turbo (108 kW | 2.0 Litre)**05.94 - 10.00 RGY (XU10J2TE/Z),  
RGX (XU10J2TE) X10-729-002-007 SWP-M-C Plug Number (T2): 11**2.1 D12 (60 kW | 2.1 Litre)**

07.94 - 06.96 P9A (XUD11A) X10-729-002-007 SWP-M-C Plug Number (T2): 11

**2.1 TD 12V (80 kW | 2.1 Litre)**05.94 - 10.00 PHZ (XUD11ATE),  
PJZ (XUD11ATE), P8C (XUD11BTE) X10-729-002-007 SWP-M-C Plug Number (T2): 11**2.5 TD (95 kW | 2.5 Litre)**

05.94 - 10.00 THY (DK5ATE) X10-729-002-007 SWP-M-C Plug Number (T2): 11

**3.0 V6 (123 kW | 3.0 Litre)**

05.94 - 10.00 SFZ (ZPJ/Z), UFZ (ZPJ/Z) X10-729-002-007 SWP-M-C Plug Number (T2): 11

**3.0 V6 (140 kW | 3.0 Litre)**

04.97 - 10.00 XFZ (ES9J4) X10-729-002-007 SWP-M-C Plug Number (T2): 11

**XSARA PICASSO (N68)****1.6 (65 kW | 1.6 Litre)**

12.99 - NFZ (TU5JP) A2C53030301 SWP-D-C

**1.6 (67 kW | 1.6 Litre)**

06.02 - A2C53030301 SWP-D-C

**1.6 (70 kW | 1.6 Litre)**

12.99 - NFV (TU5JP) A2C53030301 SWP-D-C

**1.6 16V (80 kW | 1.6 Litre)**

09.05 - NFU (TU5JP4) A2C53030301 SWP-D-C

**1.6 HDi (66 kW | 1.6 Litre)**

09.05 - A2C53030301 SWP-D-C

**1.6 HDi (80 kW | 1.6 Litre)**

05.04 - DV6TED4 A2C53030301 SWP-D-C

**1.8 16V (85 kW | 1.8 Litre)**

02.00 - 6FZ (EW7J4), LFY (XU7JP4) A2C53030301 SWP-D-C



			<b>VDO</b>		
Date	Engine Code	Chassis No.	Article No.	Product	Information

**CITROËN****XSARA PICASSO (N68)****2.0 16V (100 kW | 2.0 Litre)**

01.03 - RFN (EW10J4)

A2C53030301

SWP-D-C

**2.0 HDi (66 kW | 2.0 Litre)**

12.99 - RHY (DW10TD)

A2C53030301

SWP-D-C

**ZX (N2)****1.1 (44 kW | 1.1 Litre)**

03.91 - 06.97 HDZ (TU1M)

X10-729-002-007

SWP-M-C

Plug Number (T2): 11

**1.4 (55 kW | 1.4 Litre)**

03.91 - 06.97 KDZ (TU3M/Z)

X10-729-002-007

SWP-M-C

Plug Number (T2): 11

**1.4 i (55 kW | 1.4 Litre)**03.91 - 06.97 KDX (TU3M/Z), KDZ (TU3M/Z),  
KFX (TU3JP)

X10-729-002-007

SWP-M-C

Plug Number (T2): 11

**1.6 i (65 kW | 1.6 Litre)**

03.91 - 06.97 BDY (XU5M), BFZ (XU5JP)

X10-729-002-007

SWP-M-C

Plug Number (T2): 11

**1.8 D (44 kW | 1.8 Litre)**

06.93 - 06.97 161A (XUD7)

X10-729-002-007

SWP-M-C

Plug Number (T2): 11

**1.8 i (74 kW | 1.8 Litre)**

07.92 - 06.97 LFX (XU7JP)

X10-729-002-007

SWP-M-C

Plug Number (T2): 11

**1.8 i 16V (81 kW | 1.8 Litre)**

01.96 - 06.97 LFX (XU7JP4)

X10-729-002-007

SWP-M-C

Plug Number (T2): 11

**1.9 D (47 kW | 1.9 Litre)**

03.91 - 06.97 DJZ (XUD9Y)

X10-729-002-007

SWP-M-C

Plug Number (T2): 11

**1.9 D (50 kW | 1.9 Litre)**

07.93 - 06.97 D9B (XUD9A/U), DJY (XUD9A)

X10-729-002-007

SWP-M-C

Plug Number (T2): 11

**1.9 i (88 kW | 1.9 Litre)**

03.91 - 06.97 DKZ (XU9JA)

X10-729-002-007

SWP-M-C

Plug Number (T2): 11

**1.9 TD (66 kW | 1.9 Litre)**

07.92 - 06.97 DHY (XUD9TE/Y)

X10-729-002-007

SWP-M-C

Plug Number (T2): 11

**2.0 i (89 kW | 2.0 Litre)**

07.92 - 06.97 RFX (XU10J2C)

X10-729-002-007

SWP-M-C

Plug Number (T2): 11

**2.0 i 16V (110 kW | 2.0 Litre)**

06.94 - 06.97 RFT (XU10J4/Z)

X10-729-002-007

SWP-M-C

Plug Number (T2): 11

**2.0 i 16V (112 kW | 2.0 Litre)**

07.92 - 10.94 RFX (XU10J4/Z), RFT (XU10J4/Z)

X10-729-002-007

SWP-M-C

Plug Number (T2): 11

**2.0 i 16V (120 kW | 2.0 Litre)**

05.96 - 06.97 RFS (XU10J4RS)

X10-729-002-007

SWP-M-C

Plug Number (T2): 11

**FIAT****BRAVA (182)****1.2 16V 80 (59 kW | 1.2 Litre)**

10.00 - 10.01 188 A5.000

246-083-001-004C

SWP-D-C

Plug Number (T2): 1

**1.2 16V 80 (60 kW | 1.2 Litre)**

12.98 - 10.00 182 B2.000

246-083-001-004C

SWP-D-C

Plug Number (T2): 1

**1.4 (182.BG) (55 kW | 1.4 Litre)**

10.95 - 10.01 182 A5.000

246-083-001-004C

SWP-D-C

Plug Number (T2): 1

**1.4 12 V (182.BA) (59 kW | 1.4 Litre)**

10.95 - 08.98 182 A3.000

246-083-001-004C

SWP-D-C

Plug Number (T2): 1

**1.6 16V (182.BB) (76 kW | 1.6 Litre)**

02.96 - 10.01 182 A4.000

246-083-001-004C

SWP-D-C

Plug Number (T2): 1

**1.6 16V (182.BH) (66 kW | 1.6 Litre)**

10.95 - 10.01 182 A6.000

246-083-001-004C

SWP-D-C

Plug Number (T2): 1

**1.8 GT 16V (182.BC) (83 kW | 1.8 Litre)**

10.95 - 10.01 182 A2.000

246-083-001-004C

SWP-D-C

Plug Number (T2): 1

**1.9 D (48 kW | 1.9 Litre)**

10.95 - 10.01 160 A7.000

246-083-001-004C

SWP-D-C

Plug Number (T2): 1

**1.9 JTD 105 (77 kW | 1.9 Litre)**

12.98 - 10.01 182 B4.000

246-083-001-004C

SWP-D-C

Plug Number (T2): 1

**1.9 TD 100 S (182.BF) (74 kW | 1.9 Litre)**

03.96 - 10.01 182 A7.000

246-083-001-004C

SWP-D-C

Plug Number (T2): 1



			<b>VDO</b>		
Date	Engine Code	Chassis No.	Article No.	Product	Information

**FIAT****BRAVA (182)****1.9 TD 75 S (182.BF) (55 kW | 1.9 Litre)**

03.96 → 10.01 | 182 A8.000 | 246-083-001-004C | SWP-D-C | Plug Number (T2): 1

**BRAVO I (182)****1.2 16V 80 (59 kW | 1.2 Litre)**

10.00 → 10.01 | 188 A5.000 | 246-083-001-004C | SWP-D-C | Plug Number (T2): 1

**1.2 16V 80 (60 kW | 1.2 Litre)**

12.98 → 10.00 | 182 B2.000 | 246-083-001-004C | SWP-D-C | Plug Number (T2): 1

**1.4 (182.AA) (59 kW | 1.4 Litre)**

10.95 → 10.01 | 182 A3.000 | 246-083-001-004C | SWP-D-C | Plug Number (T2): 1

**1.4 (182.AG) (55 kW | 1.4 Litre)**

10.95 → 10.01 | 182 A5.000 | 246-083-001-004C | SWP-D-C | Plug Number (T2): 1

**1.6 16V (182.AB) (76 kW | 1.6 Litre)**

03.96 → 10.01 | 182 A4.000 | 246-083-001-004C | SWP-D-C | Plug Number (T2): 1

**1.6 16V (182.AH) (66 kW | 1.6 Litre)**

10.95 → 10.01 | 182 A6.000 | 246-083-001-004C | SWP-D-C | Plug Number (T2): 1

**1.8 GT (182.AC) (83 kW | 1.8 Litre)**

10.95 → 10.01 | 182 A2.000 | 246-083-001-004C | SWP-D-C | Plug Number (T2): 1

**1.9 D (48 kW | 1.9 Litre)**

10.95 → 10.01 | 160 A7.000 | 246-083-001-004C | SWP-D-C | Plug Number (T2): 1

**1.9 JTD 105 (77 kW | 1.9 Litre)**

12.98 → 10.01 | 182 B4.000 | 246-083-001-004C | SWP-D-C | Plug Number (T2): 1

**1.9 TD 100 S (182.AF) (74 kW | 1.9 Litre)**

03.96 → 10.01 | 182 A7.000 | 246-083-001-004C | SWP-D-C | Plug Number (T2): 1

**1.9 TD 75 S (182.AF) (55 kW | 1.9 Litre)**

03.96 → 10.01 | 182 A8.000 | 246-083-001-004C | SWP-D-C | Plug Number (T2): 1

**2.0 HGT 20V (182.AD) (108 kW | 2.0 Litre)**

10.95 → 07.98 | 182 A1.000 | 246-083-001-004C | SWP-D-C | Plug Number (T2): 1

**2.0 HGT 20V (182AQ) (113 kW | 2.0 Litre)**

07.98 → 10.01 | 182 B7.000 | 246-083-001-004C | SWP-D-C | Plug Number (T2): 1

**COUPE (FA/175)****1.8 16V (96 kW | 1.8 Litre)**

03.96 → 08.00 | 183 A1.000 | 246-083-001-004C | SWP-D-C | Plug Number (T2): 1

**2.0 16V (102 kW | 2.0 Litre)**

11.93 → 08.96 | 836 A3.000 | 246-083-001-004C | SWP-D-C | Plug Number (T2): 1

**2.0 16V Turbo (140 kW | 2.0 Litre)**

11.93 → 08.96 | 175 A1.000 | 246-083-001-004C | SWP-D-C | Plug Number (T2): 1

**2.0 20V (108 kW | 2.0 Litre)**

08.96 → 04.98 | 182 A1.000 | 246-083-001-004C | SWP-D-C | Plug Number (T2): 1

**2.0 20V (113 kW | 2.0 Litre)**

04.98 → 08.00 | 182 B3.000 | 246-083-001-004C | SWP-D-C | Plug Number (T2): 1

**2.0 20V Turbo (162 kW | 2.0 Litre)**

08.96 → 08.00 | 175 A3.000 | 246-083-001-004C | SWP-D-C | Plug Number (T2): 1

**DOBLO (119)****1.2 (223AXA1A) (48 kW | 1.2 Litre)**

03.01 → | 223 A5.000 | 246-082-008-014C | SWP-M-C | Plug Number (T2): 1

03.01 → | 223 A5.000 | 246-083-001-004C | SWP-D-C | Plug Number (T2): 1

**1.3 D Multijet (62 kW | 1.3 Litre)**

10.05 → | 8140.43S | 246-082-008-014C | SWP-M-C | Plug Number (T2): 1

**1.4 (57 kW | 1.4 Litre)**

10.05 → | 8140.43S | 246-082-008-014C | SWP-M-C | Plug Number (T2): 1

**1.6 (68 kW | 1.6 Litre)**

09.02 → | 8140.43S | 246-082-008-014C | SWP-M-C | Plug Number (T2): 1

**1.6 16V (223AXD1A) (76 kW | 1.6 Litre)**

10.01 → | 8140.43S | 246-082-008-014C | SWP-M-C | Plug Number (T2): 1

10.01 → | 182 B6.000 | 246-083-001-004C | SWP-D-C | Plug Number (T2): 1

**1.6 Natural Power (76 kW | 1.6 Litre)**

09.02 → | 8140.43S | 246-082-008-014C | SWP-M-C | Plug Number (T2): 1

**1.9 D (223AXB1A) (46 kW | 1.9 Litre)**

03.01 → | 223 A6.000 | 246-082-008-014C | SWP-M-C | Plug Number (T2): 1

03.01 → | 223 A6.000 | 246-083-001-004C | SWP-D-C | Plug Number (T2): 1



			<b>VDO</b>		
Date	Engine Code	Chassis No.	Article No.	Product	Information

**FIAT****DOBLO (119)****1.9 D Multijet (88 kW | 1.9 Litre)**

10.05 →	8140.43S		246-082-008-014C	SWP-M-C	Plug Number (T2): 1
---------	----------	--	------------------	---------	---------------------

**1.9 JTD (223AXE1A) (74 kW | 1.9 Litre)**

10.01 →	8140.43S		246-082-008-014C	SWP-M-C	Plug Number (T2): 1
---------	----------	--	------------------	---------	---------------------

10.01 →	182 B9.000, 223 B2.000		246-083-001-004C	SWP-D-C	Plug Number (T2): 1
---------	------------------------	--	------------------	---------	---------------------

**1.9 JTD (77 kW | 1.9 Litre)**

07.03 →	8140.43S		246-082-008-014C	SWP-M-C	Plug Number (T2): 1
---------	----------	--	------------------	---------	---------------------

07.03 →	223 A7.000, 223 B1.000		246-083-001-004C	SWP-D-C	Plug Number (T2): 1
---------	------------------------	--	------------------	---------	---------------------

**DOBLO Cargo (223)****1.2 (223ZX1A) (48 kW | 1.2 Litre)**

03.01 →	223 A5.000		246-082-008-014C	SWP-M-C	Plug Number (T2): 1
---------	------------	--	------------------	---------	---------------------

03.01 →	223 A5.000		246-083-001-004C	SWP-D-C	Plug Number (T2): 1; Vehicle Equipment (T31): with rear-window wiper (T34)
---------	------------	--	------------------	---------	----------------------------------------------------------------------------

**1.3 D Multijet (55 kW | 1.3 Litre)**

10.05 →	8140.43S		246-082-008-014C	SWP-M-C	Plug Number (T2): 1
---------	----------	--	------------------	---------	---------------------

**1.3 JTD 16V (51 kW | 1.3 Litre)**

05.04 →	8140.43S		246-082-008-014C	SWP-M-C	Plug Number (T2): 1
---------	----------	--	------------------	---------	---------------------

05.04 →	188 A9.000		246-083-001-004C	SWP-D-C	Plug Number (T2): 1
---------	------------	--	------------------	---------	---------------------

**1.4 (57 kW | 1.4 Litre)**

10.05 →	8140.43S		246-082-008-014C	SWP-M-C	Plug Number (T2): 1
---------	----------	--	------------------	---------	---------------------

**1.6 16V (223ZXD1A) (76 kW | 1.6 Litre)**

10.01 →	8140.43S		246-082-008-014C	SWP-M-C	Plug Number (T2): 1
---------	----------	--	------------------	---------	---------------------

10.01 →	182 B6.000		246-083-001-004C	SWP-D-C	Plug Number (T2): 1; Vehicle Equipment (T31): with rear-window wiper (T34)
---------	------------	--	------------------	---------	----------------------------------------------------------------------------

**1.6 Natural Power (76 kW | 1.6 Litre)**

09.02 →	8140.43S		246-082-008-014C	SWP-M-C	Plug Number (T2): 1
---------	----------	--	------------------	---------	---------------------

**1.9 D (223ZXB1A) (46 kW | 1.9 Litre)**

03.01 →	223 A6.000		246-082-008-014C	SWP-M-C	Plug Number (T2): 1
---------	------------	--	------------------	---------	---------------------

03.01 →	223 A6.000		246-083-001-004C	SWP-D-C	Plug Number (T2): 1; Vehicle Equipment (T31): with rear-window wiper (T34)
---------	------------	--	------------------	---------	----------------------------------------------------------------------------

**1.9 JTD (223ZXE1A) (74 kW | 1.9 Litre)**

10.01 →	8140.43S		246-082-008-014C	SWP-M-C	Plug Number (T2): 1
---------	----------	--	------------------	---------	---------------------

10.01 →	182 B9.000		246-083-001-004C	SWP-D-C	Plug Number (T2): 1; Vehicle Equipment (T31): with rear-window wiper (T34)
---------	------------	--	------------------	---------	----------------------------------------------------------------------------

**1.9 JTD (77 kW | 1.9 Litre)**

07.03 →	8140.43S		246-082-008-014C	SWP-M-C	Plug Number (T2): 1
---------	----------	--	------------------	---------	---------------------

07.03 →	223 A7.000, 223 B1.000		246-083-001-004C	SWP-D-C	Plug Number (T2): 1
---------	------------------------	--	------------------	---------	---------------------

**IDEA****1.2 16V (59 kW | 1.2 Litre)**

01.04 →	188 A5.000		246-083-001-004C	SWP-D-C	Plug Number (T2): 1
---------	------------	--	------------------	---------	---------------------

**1.3 JTD (51 kW | 1.3 Litre)**

01.04 →	188 A9.000		246-083-001-004C	SWP-D-C	Plug Number (T2): 1
---------	------------	--	------------------	---------	---------------------

**1.4 16V (70 kW | 1.4 Litre)**

01.04 →	843 A1.000		246-083-001-004C	SWP-D-C	Plug Number (T2): 1
---------	------------	--	------------------	---------	---------------------

**1.9 JTD (74 kW | 1.9 Litre)**

01.04 →	188 B2.000		246-083-001-004C	SWP-D-C	Plug Number (T2): 1
---------	------------	--	------------------	---------	---------------------

**MAREA (185)****1.2 16V (60 kW | 1.2 Litre)**

10.98 → 05.02	182 B2.000		246-083-001-004C	SWP-D-C	Plug Number (T2): 1
---------------	------------	--	------------------	---------	---------------------

**1.4 80 12V (59 kW | 1.4 Litre)**

09.96 → 05.02	8140.43S		246-082-008-014C	SWP-M-C	Plug Number (T2): 1
---------------	----------	--	------------------	---------	---------------------

09.96 → 05.02	182 A3.000		246-083-001-004C	SWP-D-C	Plug Number (T2): 1
---------------	------------	--	------------------	---------	---------------------

**1.6 100 16V (76 kW | 1.6 Litre)**

09.96 → 05.02	8140.43S		246-082-008-014C	SWP-M-C	Plug Number (T2): 1
---------------	----------	--	------------------	---------	---------------------

09.96 → 05.02	182 A4.000		246-083-001-004C	SWP-D-C	Plug Number (T2): 1
---------------	------------	--	------------------	---------	---------------------

**1.6 100 16V Bipower (76 kW | 1.6 Litre)**

04.99 → 05.02	185 A3.000, 186 A4.000		246-082-008-014C	SWP-M-C	Plug Number (T2): 1
---------------	------------------------	--	------------------	---------	---------------------

04.99 → 05.02	186 A4.000, 185 A3.000		246-083-001-004C	SWP-D-C	Plug Number (T2): 1
---------------	------------------------	--	------------------	---------	---------------------

**1.8 115 16V (83 kW | 1.8 Litre)**

09.96 → 05.02	8140.43S		246-082-008-014C	SWP-M-C	Plug Number (T2): 1
---------------	----------	--	------------------	---------	---------------------



			<b>VDO</b>		
Date	Engine Code	Chassis No.	Article No.	Product	Information

**FIAT****MAREA (185)****1.8 115 16V (83 kW | 1.8 Litre)**

09.96 → 05.02 | 182 A2.000 | 246-083-001-004C | SWP-D-C | Plug Number (T2): 1

**1.9 JTD 105 (77 kW | 1.9 Litre)**

04.99 → 01.01 | 182 B4.000 | 246-082-008-014C | SWP-M-C | Plug Number (T2): 1

04.99 → 01.01 | 182 B4.000 | 246-083-001-004C | SWP-D-C | Plug Number (T2): 1

**1.9 JTD 110 (81 kW | 1.9 Litre)**

01.01 → 05.02 | 186 A6.000 | 246-083-001-004C | SWP-D-C | Plug Number (T2): 1

**1.9 TD 100 (74 kW | 1.9 Litre)**

09.96 → 05.02 | 8140.43S | 246-082-008-014C | SWP-M-C | Plug Number (T2): 1

09.96 → 05.02 | 182 A7.000 | 246-083-001-004C | SWP-D-C | Plug Number (T2): 1

**1.9 TD 75 (55 kW | 1.9 Litre)**

09.96 → 05.02 | 8140.43S | 246-082-008-014C | SWP-M-C | Plug Number (T2): 1

09.96 → 05.02 | 182 A8.000 | 246-083-001-004C | SWP-D-C | Plug Number (T2): 1

**2.0 150 20V (108 kW | 2.0 Litre)**

09.96 → 04.99 | 8140.43S | 246-082-008-014C | SWP-M-C | Plug Number (T2): 1

09.96 → 04.99 | 182 A1.000 | 246-083-001-004C | SWP-D-C | Plug Number (T2): 1

**2.0 150 20V (110 kW | 2.0 Litre)**

01.01 → 05.02 | 185 A8.000 | 246-083-001-004C | SWP-D-C | Plug Number (T2): 1

**2.0 155 20V (113 kW | 2.0 Litre)**

04.99 → 01.01 | 182 B7.000 | 246-082-008-014C | SWP-M-C | Plug Number (T2): 1

04.99 → 01.01 | 182 B7.000 | 246-083-001-004C | SWP-D-C | Plug Number (T2): 1

**2.4 JTD 130 (96 kW | 2.4 Litre)**

04.99 → 05.02 | 185 A6.000, 839 A5.000 | 246-082-008-014C | SWP-M-C | Plug Number (T2): 1

04.99 → 05.02 | 839 A5.000, 185 A6.000 | 246-083-001-004C | SWP-D-C | Plug Number (T2): 1

**2.4 TD 125 (91 kW | 2.4 Litre)**

09.96 → 04.99 | 8140.43S | 246-082-008-014C | SWP-M-C | Plug Number (T2): 1

09.96 → 04.99 | 185 A2.000 | 246-083-001-004C | SWP-D-C | Plug Number (T2): 1

**MAREA Weekend (185)****1.2 16V (60 kW | 1.2 Litre)**

10.98 → 05.02 | 182 B2.000 | 246-083-001-004C | SWP-D-C | Plug Number (T2): 1

**1.4 80 12V (59 kW | 1.4 Litre)**

09.96 → 05.02 | 182 A3.000 | 246-083-001-004C | SWP-D-C | Plug Number (T2): 1

**1.6 100 16V (76 kW | 1.6 Litre)**

09.96 → 05.02 | 182 A4.000 | 246-083-001-004C | SWP-D-C | Plug Number (T2): 1

**1.8 115 16V (83 kW | 1.8 Litre)**

09.96 → 05.02 | 182 A2.000 | 246-083-001-004C | SWP-D-C | Plug Number (T2): 1

**1.9 JTD 105 (77 kW | 1.9 Litre)**

04.99 → 05.02 | 182 B4.000 | 246-083-001-004C | SWP-D-C | Plug Number (T2): 1

**1.9 JTD 110 (81 kW | 1.9 Litre)**

01.01 → 05.02 | 186 A6.000 | 246-083-001-004C | SWP-D-C | Plug Number (T2): 1

**1.9 TD 100 (74 kW | 1.9 Litre)**

09.96 → 05.02 | 182 A7.000, 182 B9.000 | 246-083-001-004C | SWP-D-C | Plug Number (T2): 1

**1.9 TD 75 (55 kW | 1.9 Litre)**

09.96 → 05.02 | 182 A8.000 | 246-083-001-004C | SWP-D-C | Plug Number (T2): 1

**2.0 150 20V (108 kW | 2.0 Litre)**

09.96 → 04.99 | 182 A1.000 | 246-083-001-004C | SWP-D-C | Plug Number (T2): 1

**2.0 150 20V (110 kW | 2.0 Litre)**

01.01 → 05.02 | 185 A8.000 | 246-083-001-004C | SWP-D-C | Plug Number (T2): 1

**2.0 155 20V (113 kW | 2.0 Litre)**

04.99 → 01.01 | 182 B7.000 | 246-083-001-004C | SWP-D-C | Plug Number (T2): 1

**2.4 JTD 130 (96 kW | 2.4 Litre)**

04.99 → 05.02 | 839 A5.000, 185 A6.000 | 246-083-001-004C | SWP-D-C | Plug Number (T2): 1

**2.4 TD 125 (91 kW | 2.4 Litre)**

09.96 → 04.99 | 185 A2.000 | 246-083-001-004C | SWP-D-C | Plug Number (T2): 1

**MULTIPLA (186)****1.6 100 16V (186AXA1A) (76 kW | 1.6 Litre)**

04.99 → | 182 A4.000 | 246-083-001-004C | SWP-D-C | Plug Number (T2): 1; T24: SX →

**1.6 16V Bipower (186AMB1A) (76 kW | 1.6 Litre)**

04.99 → | 186 A4.000 | 246-083-001-004C | SWP-D-C | Plug Number (T2): 1; T24: SX →

**1.6 16V Bipower (186AXC1A) (76 kW | 1.6 Litre)**

10.01 → | 182 B6.000 | 246-083-001-004C | SWP-D-C | Plug Number (T2): 1; T24: SX →



			<b>VDO</b>		
Date	Engine Code	Chassis No.	Article No.	Product	Information

**FIAT****MULTIPLA (186)****1.6 16V Blupower (186AMA1A) (70 kW | 1.6 Litre)**

04.99 -	186 A3.000		246-083-001-004C	SWP-D-C	Plug Number (T2): 1; T24: SX →
---------	------------	--	------------------	---------	--------------------------------

**1.9 JTD 105 (186AXB1A) (77 kW | 1.9 Litre)**

04.99 -	182 B4.000		246-083-001-004C	SWP-D-C	Plug Number (T2): 1; T24: SX →
---------	------------	--	------------------	---------	--------------------------------

**1.9 JTD 110 (81 kW | 1.9 Litre)**

03.01 - 07.02	186 A6.000		246-083-001-004C	SWP-D-C	Plug Number (T2): 1; T24: SX →
---------------	------------	--	------------------	---------	--------------------------------

**1.9 JTD 115 (85 kW | 1.9 Litre)**

07.02 -	186 A8.000		246-083-001-004C	SWP-D-C	Plug Number (T2): 1; T24: SX →
---------	------------	--	------------------	---------	--------------------------------

**PALIO (178BX)****1.0 (45 kW | 1.0 Litre)**

04.96 -			246-082-008-014C	SWP-M-C	Plug Number (T2): 1
---------	--	--	------------------	---------	---------------------

04.96 -			246-083-001-004C	SWP-D-C	Plug Number (T2): 1
---------	--	--	------------------	---------	---------------------

**1.0 (56 kW | 1.0 Litre)**

04.96 -			246-082-008-014C	SWP-M-C	Plug Number (T2): 1
---------	--	--	------------------	---------	---------------------

04.96 -			246-083-001-004C	SWP-D-C	Plug Number (T2): 1
---------	--	--	------------------	---------	---------------------

**1.2 (54 kW | 1.2 Litre)**

06.98 -	8140.43S		246-082-008-014C	SWP-M-C	Plug Number (T2): 1
---------	----------	--	------------------	---------	---------------------

06.98 -	178 E2.000, 178 B5.000, 176 A8.000		246-083-001-004C	SWP-D-C	Plug Number (T2): 1
---------	---------------------------------------	--	------------------	---------	---------------------

**1.4 (51 kW | 1.4 Litre)**

04.96 -	178 B2.000		246-082-008-014C	SWP-M-C	Plug Number (T2): 1
---------	------------	--	------------------	---------	---------------------

04.96 -	178 B2.000		246-083-001-004C	SWP-D-C	Plug Number (T2): 1
---------	------------	--	------------------	---------	---------------------

**1.4 CAT (51 kW | 1.4 Litre)**

04.96 -	178 B2.016		246-082-008-014C	SWP-M-C	Plug Number (T2): 1
---------	------------	--	------------------	---------	---------------------

04.96 -	178 B2.016		246-083-001-004C	SWP-D-C	Plug Number (T2): 1
---------	------------	--	------------------	---------	---------------------

**1.5 (57 kW | 1.5 Litre)**

04.96 - 09.02			246-082-008-014C	SWP-M-C	Plug Number (T2): 1
---------------	--	--	------------------	---------	---------------------

04.96 - 09.02			246-083-001-004C	SWP-D-C	Plug Number (T2): 1
---------------	--	--	------------------	---------	---------------------

**1.6 16V (74 kW | 1.6 Litre)**

04.96 -	8140.43S		246-082-008-014C	SWP-M-C	Plug Number (T2): 1
---------	----------	--	------------------	---------	---------------------

04.96 -	178 B3.000		246-083-001-004C	SWP-D-C	Plug Number (T2): 1
---------	------------	--	------------------	---------	---------------------

**1.8 (81 kW | 1.8 Litre)**

10.05 -			246-083-001-004C	SWP-D-C	Plug Number (T2): 1
---------	--	--	------------------	---------	---------------------

**PALIO Weekend (178DX)****1.0 (45 kW | 1.0 Litre)**

07.98 - 10.03	8140.43S		246-082-008-014C	SWP-M-C	Plug Number (T2): 1
---------------	----------	--	------------------	---------	---------------------

**1.2 (178DX.G1A) (54 kW | 1.2 Litre)**

04.96 - 02.01	8140.43S		246-082-008-014C	SWP-M-C	Plug Number (T2): 1
---------------	----------	--	------------------	---------	---------------------

04.96 - 02.01	178 B5.000		246-083-001-004C	SWP-D-C	Plug Number (T2): 1
---------------	------------	--	------------------	---------	---------------------

**1.2 (178DYA1A) (44 kW | 1.2 Litre)**

02.01 -	188 A4.000		246-082-008-014C	SWP-M-C	Plug Number (T2): 1
---------	------------	--	------------------	---------	---------------------

02.01 -	188 A4.000, 178 C4.066		246-083-001-004C	SWP-D-C	Plug Number (T2): 1
---------	------------------------	--	------------------	---------	---------------------

**1.6 16V (178DX.D1A) (74 kW | 1.6 Litre)**

04.96 - 02.01	8140.43S		246-082-008-014C	SWP-M-C	Plug Number (T2): 1
---------------	----------	--	------------------	---------	---------------------

04.96 - 02.01	178 B3.000		246-083-001-004C	SWP-D-C	Plug Number (T2): 1
---------------	------------	--	------------------	---------	---------------------

**1.6 16V (178DYC1A06) (76 kW | 1.6 Litre)**

02.01 -	182 B6.000		246-082-008-014C	SWP-M-C	Plug Number (T2): 1
---------	------------	--	------------------	---------	---------------------

02.01 -	182 B6.000		246-083-001-004C	SWP-D-C	Plug Number (T2): 1
---------	------------	--	------------------	---------	---------------------

**1.7 TD (178DX.H1A) (51 kW | 1.7 Litre)**

04.96 - 03.01	8140.43S		246-082-008-014C	SWP-M-C	Plug Number (T2): 1
---------------	----------	--	------------------	---------	---------------------

04.96 - 03.01	176 A3.000		246-083-001-004C	SWP-D-C	Plug Number (T2): 1
---------------	------------	--	------------------	---------	---------------------

**1.9 D (178DYD1A07) (46 kW | 1.9 Litre)**

03.01 -	223 A6.000		246-082-008-014C	SWP-M-C	Plug Number (T2): 1
---------	------------	--	------------------	---------	---------------------

03.01 -	223 A6.000		246-083-001-004C	SWP-D-C	Plug Number (T2): 1
---------	------------	--	------------------	---------	---------------------

**PANDA (169)****1.2 (51 kW | 1.2 Litre)**

03.10 -	169 A4.000		246-083-001-004C	SWP-D-C	Plug Number (T2): 1
---------	------------	--	------------------	---------	---------------------





			<b>VDO</b>		
Date	Engine Code	Chassis No.	Article No.	Product	Information

**FIAT****PUNTO (176)****1.4 GT Turbo (96 kW | 1.4 Litre)**

09.96 - 09.99 | 176 B6.000 | 246-083-001-004C | SWP-D-C | Plug Number (T2): 1

**1.4 GT Turbo (98 kW | 1.4 Litre)**

01.94 - 09.96 | 176 A4.000 | 246-083-001-004C | SWP-D-C | Plug Number (T2): 1

**1.7 D (42 kW | 1.7 Litre)**

04.94 - 09.97 | 176 B3.000 | 246-083-001-004C | SWP-D-C | Plug Number (T2): 1

**1.7 TD (51 kW | 1.7 Litre)**

01.94 - 09.99 | 176 A3.000 | 246-083-001-004C | SWP-D-C | Plug Number (T2): 1

**1.7 TD (52 kW | 1.7 Litre)**

01.94 - 09.99 | 176 A5.000 | 246-083-001-004C | SWP-D-C | Plug Number (T2): 1

**55 1.1 (40 kW | 1.1 Litre)**

09.93 - 09.99 | 176 A6.000, 176 B2.000 | 246-083-001-004C | SWP-D-C | Plug Number (T2): 1

**60 1.2 (43 kW | 1.2 Litre)**

01.94 - 09.99 | 176 A7.000 | 246-083-001-004C | SWP-D-C | Plug Number (T2): 1

**60 1.2 (44 kW | 1.2 Litre)**

03.94 - 09.99 | 176 B1.000, 176 B4.000 | 246-083-001-004C | SWP-D-C | Plug Number (T2): 1

**60 TD 1.7 (46 kW | 1.7 Litre)**

09.96 - 09.99 | 176 B7.000 | 246-083-001-004C | SWP-D-C | Plug Number (T2): 1

**75 1.2 (54 kW | 1.2 Litre)**

10.93 - 09.99 | 176 A8.000 | 246-083-001-004C | SWP-D-C | Plug Number (T2): 1

**85 16V 1.2 (63 kW | 1.2 Litre)**

04.97 - 09.99 | 176 B9.000 | 246-083-001-004C | SWP-D-C | Plug Number (T2): 1

**90 1.6 (65 kW | 1.6 Litre)**

01.94 - 04.97 | 176 A9.000 | 246-083-001-004C | SWP-D-C | Plug Number (T2): 1

**PUNTO Convertible (176C)****60 1.2 (43 kW | 1.2 Litre)**

04.94 - 06.00 | 8140.43S | 246-082-008-014C | SWP-M-C | Plug Number (T2): 1

04.94 - 06.00 | 176 A7.000 | 246-083-001-004C | SWP-D-C | Plug Number (T2): 1

**60 1.2 (44 kW | 1.2 Litre)**

05.95 - 06.00 | 8140.43S | 246-082-008-014C | SWP-M-C | Plug Number (T2): 1

05.95 - 06.00 | 176 B1.000, 176 B4.000 | 246-083-001-004C | SWP-D-C | Plug Number (T2): 1

**85 16V 1.2 (63 kW | 1.2 Litre)**

04.97 - 06.00 | 8140.43S | 246-082-008-014C | SWP-M-C | Plug Number (T2): 1

04.97 - 06.00 | 176 B9.000 | 246-083-001-004C | SWP-D-C | Plug Number (T2): 1

**90 1.6 (65 kW | 1.6 Litre)**

04.94 - 04.97 | 8140.43S | 246-082-008-014C | SWP-M-C | Plug Number (T2): 1

04.94 - 04.97 | 176 A9.000 | 246-083-001-004C | SWP-D-C | Plug Number (T2): 1

**PUNTO Van (176L)****1.1 (40 kW | 1.1 Litre)**

04.96 - 02.00 | 176 B2.000 | 246-083-001-004C | SWP-D-C | Plug Number (T2): 1

**1.7 D (42 kW | 1.7 Litre)**

04.96 - 02.00 | 176 B3.000 | 246-083-001-004C | SWP-D-C | Plug Number (T2): 1

**1.7 TD (52 kW | 1.7 Litre)**

04.96 - 02.00 | 176 A5.000 | 246-083-001-004C | SWP-D-C | Plug Number (T2): 1

**PUNTO (188)****1.2 16V 80 (188.233, .235, .253, .255, .333, .353, .639...) (59 kW | 1.2 Litre)**

09.99 - | 188 A5.000 | 246-083-001-004C | SWP-D-C | Plug Number (T2): 1

**1.2 60 (188.030, .050, .130, .150, .230, .250) (44 kW | 1.2 Litre)**

09.99 - | 188 A4.000 | 246-083-001-004C | SWP-D-C | Plug Number (T2): 1

**1.2 Natural Power (44 kW | 1.2 Litre)**

09.03 - | 188 A4.000 | 246-083-001-004C | SWP-D-C | Plug Number (T2): 1

**1.3 JTD 16V (51 kW | 1.3 Litre)**

06.03 - | 188 A9.000 | 246-083-001-004C | SWP-D-C | Plug Number (T2): 1

**1.4 (70 kW | 1.4 Litre)**

09.03 - | 843 A1.000 | 246-083-001-004C | SWP-D-C | Plug Number (T2): 1

**1.8 130 HGT (188.738, .718) (96 kW | 1.8 Litre)**

09.99 - | 183 A1.000, 188 A6.000 | 246-083-001-004C | SWP-D-C | Plug Number (T2): 1

**1.9 DS 60 (188.031, .051, .231, .251) (44 kW | 1.9 Litre)**

09.99 - | 188 A3.000 | 246-083-001-004C | SWP-D-C | Plug Number (T2): 1



			<b>VDO</b>		
Date	Engine Code	Chassis No.	Article No.	Product	Information

**FIAT****PUNTO (188)****1.9 JTD (63 kW | 1.9 Litre)**

10.01 -	188 A7.000		246-083-001-004C	SWP-D-C	Plug Number (T2): 1
---------	------------	--	------------------	---------	---------------------

**1.9 JTD (74 kW | 1.9 Litre)**

06.03 -	188 B2.000		246-083-001-004C	SWP-D-C	Plug Number (T2): 1
---------	------------	--	------------------	---------	---------------------

**1.9 JTD 80 (188.237, .257, .337, .357) (59 kW | 1.9 Litre)**

09.99 -	188 A2.000		246-083-001-004C	SWP-D-C	Plug Number (T2): 1
---------	------------	--	------------------	---------	---------------------

**PUNTO Van (188AX)****1.2 60 (44 kW | 1.2 Litre)**

02.00 - 10.09	188 A4.000		246-083-001-004C	SWP-D-C	Plug Number (T2): 1
---------------	------------	--	------------------	---------	---------------------

**1.9 D 60 (44 kW | 1.9 Litre)**

02.00 - 10.09	188 A3.000		246-083-001-004C	SWP-D-C	Plug Number (T2): 1
---------------	------------	--	------------------	---------	---------------------

**1.9 JTD (63 kW | 1.9 Litre)**

02.00 - 10.09	188 A7.000		246-083-001-004C	SWP-D-C	Plug Number (T2): 1
---------------	------------	--	------------------	---------	---------------------

**SCUDO (270\_)****1.6 D Multijet (66 kW | 1.6 Litre)**

01.07 -	9HU		A2C53030301	SWP-D-C	
---------	-----	--	-------------	---------	--

**2.0 D Multijet (100 kW | 2.0 Litre)**

01.07 -	RHR		A2C53030301	SWP-D-C	
---------	-----	--	-------------	---------	--

**2.0 D Multijet (120 kW | 2.0 Litre)**

07.10 -	RHH		A2C53030301	SWP-D-C	
---------	-----	--	-------------	---------	--

**2.0 D Multijet (88 kW | 2.0 Litre)**

01.07 -	RHK		A2C53030301	SWP-D-C	
---------	-----	--	-------------	---------	--

**SCUDO Box (270\_)****1.6 D Multijet (66 kW | 1.6 Litre)**

01.07 -	9HU		A2C53030301	SWP-D-C	
---------	-----	--	-------------	---------	--

**2.0 D Multijet (100 kW | 2.0 Litre)**

01.07 -	RHR		A2C53030301	SWP-D-C	
---------	-----	--	-------------	---------	--

**2.0 D Multijet (120 kW | 2.0 Litre)**

07.10 -	RHH		A2C53030301	SWP-D-C	
---------	-----	--	-------------	---------	--

**2.0 D Multijet (88 kW | 2.0 Litre)**

01.07 -	RHK		A2C53030301	SWP-D-C	
---------	-----	--	-------------	---------	--

**SCUDO Platform/Chassis (270\_)****1.6 D Multijet (66 kW | 1.6 Litre)**

01.07 -	9HU		A2C53030301	SWP-D-C	
---------	-----	--	-------------	---------	--

**2.0 D Multijet (100 kW | 2.0 Litre)**

01.07 -	RHR		A2C53030301	SWP-D-C	
---------	-----	--	-------------	---------	--

**2.0 D Multijet (88 kW | 2.0 Litre)**

01.07 -	RHK		A2C53030301	SWP-D-C	
---------	-----	--	-------------	---------	--

**SIENA (178\_)****1.0 (45 kW | 1.0 Litre)**

09.98 -			246-082-008-014C	SWP-M-C	Plug Number (T2): 1
---------	--	--	------------------	---------	---------------------

**1.2 (54 kW | 1.2 Litre)**

09.98 -	178 B5.000		246-082-008-014C	SWP-M-C	Plug Number (T2): 1
---------	------------	--	------------------	---------	---------------------

**1.2 (59 kW | 1.2 Litre)**

09.01 -	8140.43S		246-082-008-014C	SWP-M-C	Plug Number (T2): 1
---------	----------	--	------------------	---------	---------------------

**1.4 (51 kW | 1.4 Litre)**

04.96 -	178 B2.000		246-082-008-014C	SWP-M-C	Plug Number (T2): 1
---------	------------	--	------------------	---------	---------------------

**1.4 CAT (51 kW | 1.4 Litre)**

04.96 -	178 B2.016		246-082-008-014C	SWP-M-C	Plug Number (T2): 1
---------	------------	--	------------------	---------	---------------------

**1.6 16V (78 kW | 1.6 Litre)**

09.98 -	178 B3.000		246-082-008-014C	SWP-M-C	Plug Number (T2): 1
---------	------------	--	------------------	---------	---------------------

**STILO (192)****1.2 16V (192\_XA1B) (59 kW | 1.2 Litre)**

02.02 - 11.06	188 A5.000		246-083-001-004C	SWP-D-C	Plug Number (T2): 1
---------------	------------	--	------------------	---------	---------------------

**1.4 16V (66 kW | 1.4 Litre)**

03.05 - 11.06	192 B2.000		246-083-001-004C	SWP-D-C	Plug Number (T2): 1
---------------	------------	--	------------------	---------	---------------------



			<b>VDO</b>		
Date	Engine Code	Chassis No.	Article No.	Product	Information

**FIAT****STILO (192)****1.4 16V (70 kW | 1.4 Litre)**

01.04 → 11.06 | 843 A1.000 | 246-083-001-004C | SWP-D-C | Plug Number (T2): 1

**1.6 16V (192\_XB1A) (76 kW | 1.6 Litre)**

10.01 → 11.06 | 182 B6.000 | 246-083-001-004C | SWP-D-C | Plug Number (T2): 1

**1.8 16V (192\_XC1A) (98 kW | 1.8 Litre)**

10.01 → 11.06 | 192 A4.000 | 246-083-001-004C | SWP-D-C | Plug Number (T2): 1

**1.9 D Multijet (110 kW | 1.9 Litre)**

09.05 → 11.06 | 937 A5.000 | 246-083-001-004C | SWP-D-C | Plug Number (T2): 1

**1.9 D Multijet (74 kW | 1.9 Litre)**

09.05 → 11.06 | 192 A9.000 | 246-083-001-004C | SWP-D-C | Plug Number (T2): 1

**1.9 D Multijet (88 kW | 1.9 Litre)**

09.05 → 11.06 | 192 A8.000 | 246-083-001-004C | SWP-D-C | Plug Number (T2): 1

**1.9 JTD (103 kW | 1.9 Litre)**

01.04 → 11.06 | 192 A5.000 | 246-083-001-004C | SWP-D-C | Plug Number (T2): 1

**1.9 JTD (192\_XE1A) (85 kW | 1.9 Litre)**

10.01 → 11.06 | 192 A1.000, 937 A7.000 | 246-083-001-004C | SWP-D-C | Plug Number (T2): 1

**1.9 JTD (192\_XF1A) (59 kW | 1.9 Litre)**

02.02 → 11.06 | 192 A3.000 | 246-083-001-004C | SWP-D-C | Plug Number (T2): 1

**2.4 20V (192\_XD1A) (125 kW | 2.4 Litre)**

10.01 → 11.06 | 192 A2.000 | 246-083-001-004C | SWP-D-C | Plug Number (T2): 1

**STILO Multi Wagon (192)****1.4 16V (66 kW | 1.4 Litre)**

03.05 → 08.08 | 192 B2.000 | 246-083-001-004C | SWP-D-C | Plug Number (T2): 1

**1.4 16V (70 kW | 1.4 Litre)**

01.04 → 08.08 | 843 A1.000 | 246-083-001-004C | SWP-D-C | Plug Number (T2): 1

**1.6 16V (76 kW | 1.6 Litre)**

01.03 → 08.08 | 182 B6.000 | 246-083-001-004C | SWP-D-C | Plug Number (T2): 1

**1.8 16V (98 kW | 1.8 Litre)**

01.03 → 08.08 | 192 A4.000 | 246-083-001-004C | SWP-D-C | Plug Number (T2): 1

**1.9 D Multijet (110 kW | 1.9 Litre)**

09.05 → 08.08 | 937 A5.000 | 246-083-001-004C | SWP-D-C | Plug Number (T2): 1

**1.9 D Multijet (74 kW | 1.9 Litre)**

09.05 → 08.08 | 192 A9.000 | 246-083-001-004C | SWP-D-C | Plug Number (T2): 1

**1.9 D Multijet (88 kW | 1.9 Litre)**

09.05 → 08.08 | 192 A8.000 | 246-083-001-004C | SWP-D-C | Plug Number (T2): 1

**1.9 JTD (103 kW | 1.9 Litre)**

01.04 → 08.08 | 192 A5.000 | 246-083-001-004C | SWP-D-C | Plug Number (T2): 1

**1.9 JTD (59 kW | 1.9 Litre)**

01.03 → 08.08 | 192 A3.000 | 246-083-001-004C | SWP-D-C | Plug Number (T2): 1

**1.9 JTD (85 kW | 1.9 Litre)**

01.03 → 08.08 | 192 A1.000, 937 A7.000 | 246-083-001-004C | SWP-D-C | Plug Number (T2): 1

**STRADA (178E)****1.2 (54 kW | 1.2 Litre)**

06.99 → | 178 B5.000 | 246-082-008-014C | SWP-M-C | Plug Number (T2): 1

**1.3 D Multijet (62 kW | 1.3 Litre)**

05.06 → | 8140.43S | 246-082-008-014C | SWP-M-C | Plug Number (T2): 1

**1.7 TD (51 kW | 1.7 Litre)**

06.99 → | 176 A3.000 | 246-082-008-014C | SWP-M-C | Plug Number (T2): 1

**1.9 D (46 kW | 1.9 Litre)**

12.00 → | 8140.43S | 246-082-008-014C | SWP-M-C | Plug Number (T2): 1

**1.9 JTD (59 kW | 1.9 Litre)**

04.03 → | 8140.43S | 246-082-008-014C | SWP-M-C | Plug Number (T2): 1

**TEMPRA (159)****1.4 i.e. (159.AC) (57 kW | 1.4 Litre)**

03.91 → 08.96 | 159 A2.000 | 246-083-001-004C | SWP-D-C | Plug Number (T2): 1

**1.4 i.e. (159.AC, 159.AX) (51 kW | 1.4 Litre)**

03.92 → 08.96 | 160 A1.046, 836 A4.000 | 246-083-001-004C | SWP-D-C | Plug Number (T2): 1

**1.6 (63 kW | 1.6 Litre)**

03.90 → 04.93 | 159 A3.000 | 246-083-001-004C | SWP-D-C | Plug Number (T2): 1



			<b>VDO</b>		
Date	Engine Code	Chassis No.	Article No.	Product	Information

**FIAT****TEMPRA (159)**

<b>1.6 i.e. (159.AE) (57 kW   1.6 Litre)</b>					
06.90 → 07.92	159 A3.046		246-083-001-004C	SWP-D-C	Plug Number (T2): 1
<b>1.6 i.e. (159.AJ) (63 kW   1.6 Litre)</b>					
06.94 → 08.96	159 B9.000		246-083-001-004C	SWP-D-C	Plug Number (T2): 1
<b>1.6 i.e. (159.AJ) (66 kW   1.6 Litre)</b>					
06.94 → 08.96	159 B9.000		246-083-001-004C	SWP-D-C	Plug Number (T2): 1
<b>1.6 i.e. (159.AS, 159.AT) (55 kW   1.6 Litre)</b>					
06.92 → 08.96	159 A3.048, 835 C1.000		246-083-001-004C	SWP-D-C	Plug Number (T2): 1
<b>1.8 i.e. (159.AN) (77 kW   1.8 Litre)</b>					
03.92 → 08.96	159 A4.046		246-083-001-004C	SWP-D-C	Plug Number (T2): 1
<b>1.8 i.e. (159.AN) (81 kW   1.8 Litre)</b>					
03.90 → 08.96	159 A4.000		246-083-001-004C	SWP-D-C	Plug Number (T2): 1
<b>1.8 i.e. (159.AV) (76 kW   1.8 Litre)</b>					
09.93 → 08.96	8140.43S		246-082-008-014C	SWP-M-C	Plug Number (T2): 1
09.93 → 08.96	835 C2.000		246-083-001-004C	SWP-D-C	Plug Number (T2): 1
<b>1.8 i.e. (159.AZ) (66 kW   1.8 Litre)</b>					
09.93 → 08.96	8140.43S		246-082-008-014C	SWP-M-C	Plug Number (T2): 1
09.93 → 08.96	835 C4.000		246-083-001-004C	SWP-D-C	Plug Number (T2): 1
<b>1.8 i.e. (159.BY) (74 kW   1.8 Litre)</b>					
10.94 → 08.96	836 A5.000		246-083-001-004C	SWP-D-C	Plug Number (T2): 1
<b>1.9 D (159.AG) (48 kW   1.9 Litre)</b>					
07.91 → 08.96	160 A7.000, 149 A1.000		246-083-001-004C	SWP-D-C	Plug Number (T2): 1
<b>1.9 TD (159.AQ) (59 kW   1.9 Litre)</b>					
07.92 → 08.96	160 B6.046		246-083-001-004C	SWP-D-C	Plug Number (T2): 1
<b>1.9 TD (159.CU, 159.AU, 159.AI, 159.BI) (66 kW   1.9 Litre)</b>					
05.90 → 08.96	160 A6.000, 160 D1.000		246-083-001-004C	SWP-D-C	Plug Number (T2): 1
<b>2.0 i.e. (159.AP) (83 kW   2.0 Litre)</b>					
10.90 → 08.96	159 A6.046		246-083-001-004C	SWP-D-C	Plug Number (T2): 1

**TEMPRA S.W. (159)**

<b>1.4 i.e. (159.AC) (57 kW   1.4 Litre)</b>					
03.91 → 08.96	159 A2.000		246-083-001-004C	SWP-D-C	Plug Number (T2): 1
<b>1.4 i.e. (159.AC, 159.AX) (51 kW   1.4 Litre)</b>					
10.92 → 08.96	160 A1.046, 836 A4.000		246-083-001-004C	SWP-D-C	Plug Number (T2): 1
<b>1.6 (63 kW   1.6 Litre)</b>					
12.90 → 04.93	159 A3.000		246-083-001-004C	SWP-D-C	Plug Number (T2): 1
<b>1.6 i.e. (159.AE) (57 kW   1.6 Litre)</b>					
10.90 → 08.96	159 A3.046, 835 C1.000		246-083-001-004C	SWP-D-C	Plug Number (T2): 1
<b>1.6 i.e. (159.AJ) (66 kW   1.6 Litre)</b>					
06.94 → 08.96	159 B9.000		246-083-001-004C	SWP-D-C	Plug Number (T2): 1
<b>1.6 i.e. (159.AS, 159.AT) (55 kW   1.6 Litre)</b>					
10.92 → 08.96	159 A3.048, 835 C1.000		246-083-001-004C	SWP-D-C	Plug Number (T2): 1
<b>1.8 i.e. (159.AN) (77 kW   1.8 Litre)</b>					
03.92 → 12.93	159 A4.046		246-083-001-004C	SWP-D-C	Plug Number (T2): 1
<b>1.8 i.e. (159.AN) (81 kW   1.8 Litre)</b>					
03.90 → 08.96	159 A4.000		246-083-001-004C	SWP-D-C	Plug Number (T2): 1
<b>1.8 i.e. (159.AV) (76 kW   1.8 Litre)</b>					
09.93 → 08.96	835 C2.000		246-083-001-004C	SWP-D-C	Plug Number (T2): 1
<b>1.8 i.e. (159.AZ) (66 kW   1.8 Litre)</b>					
09.93 → 08.96	835 C4.000		246-083-001-004C	SWP-D-C	Plug Number (T2): 1
<b>1.8 i.e. (159.BY) (74 kW   1.8 Litre)</b>					
10.94 → 08.96	836 A5.000		246-083-001-004C	SWP-D-C	Plug Number (T2): 1
<b>1.9 D (159.AG) (48 kW   1.9 Litre)</b>					
07.91 → 08.96	160 A7.000, 149 A1.000		246-083-001-004C	SWP-D-C	Plug Number (T2): 1
<b>1.9 TD (159.AI, 159.BI, 159.CU, 159.AU) (66 kW   1.9 Litre)</b>					
07.91 → 02.95	160 A6.000, 160 D1.000		246-083-001-004C	SWP-D-C	Plug Number (T2): 1
<b>1.9 TD (159.AQ) (59 kW   1.9 Litre)</b>					
03.92 → 06.93	160 B6.046		246-083-001-004C	SWP-D-C	Plug Number (T2): 1
<b>2.0 i.e. (159.AP) (83 kW   2.0 Litre)</b>					
01.91 → 03.95	159 A6.046		246-083-001-004C	SWP-D-C	Plug Number (T2): 1
<b>2.0 i.e. 4x4 (159.AP) (83 kW   2.0 Litre)</b>					
03.92 → 03.95	159 A6.046		246-083-001-004C	SWP-D-C	Plug Number (T2): 1



			<b>VDO</b>		
Date	Engine Code	Chassis No.	Article No.	Product	Information

**FIAT****TIPO (160)**

<b>1.1 (160.AA) (41 kW   1.1 Litre)</b>					
01.88 - 10.91	160 A3.000		246-083-001-004C	SWP-D-C	Plug Number (T2): 1
<b>1.4 (160.AC) (52 kW   1.4 Litre)</b>					
07.87 - 12.89	160 A1.000, 160 A1.048		246-083-001-004C	SWP-D-C	Plug Number (T2): 1
<b>1.4 i.e. (160.AP, 160.AD, 160.EA) (51 kW   1.4 Litre)</b>					
03.93 - 04.95	160 A1.046, 836 A4.000		246-083-001-004C	SWP-D-C	Plug Number (T2): 1
<b>1.4 i.e. (57 kW   1.4 Litre)</b>					
03.93 - 04.95	159 A2.000		246-083-001-004C	SWP-D-C	Plug Number (T2): 1
<b>1.6 (160.AE) (61 kW   1.6 Litre)</b>					
01.88 - 10.91	160 A2.000		246-083-001-004C	SWP-D-C	Plug Number (T2): 1
<b>1.6 i.e. (160.A1, 160.EC, 160.EB) (55 kW   1.6 Litre)</b>					
03.93 - 04.95	159 A3.048, 835 C1.000		246-083-001-004C	SWP-D-C	Plug Number (T2): 1
<b>1.6 i.e. (160.AF) (57 kW   1.6 Litre)</b>					
07.90 - 01.93	159 A3.046		246-083-001-004C	SWP-D-C	Plug Number (T2): 1
<b>1.6 i.e. (66 kW   1.6 Litre)</b>					
02.88 - 05.91	149 C2.046		246-083-001-004C	SWP-D-C	Plug Number (T2): 1
<b>1.7 D (160.AG) (43 kW   1.7 Litre)</b>					
03.93 - 10.94	149 B4.000		246-083-001-004C	SWP-D-C	Plug Number (T2): 1
<b>1.7 D (160.AG) (45 kW   1.7 Litre)</b>					
03.93 - 10.95	149 B4.000		246-083-001-004C	SWP-D-C	Plug Number (T2): 1
<b>1.8 i.e (71 kW   1.8 Litre)</b>					
03.93 - 04.95	836 A5.000		246-083-001-004C	SWP-D-C	Plug Number (T2): 1
<b>1.8 i.e. (160.AM) (74 kW   1.8 Litre)</b>					
10.94 - 04.95	159 A4.000		246-083-001-004C	SWP-D-C	Plug Number (T2): 1
<b>1.8 i.e. (160.AY) (77 kW   1.8 Litre)</b>					
10.90 - 06.93	159 A4.046		246-083-001-004C	SWP-D-C	Plug Number (T2): 1
<b>1.8 i.e. (160.ED) (76 kW   1.8 Litre)</b>					
04.93 - 04.95	835 C2.000		246-083-001-004C	SWP-D-C	Plug Number (T2): 1
<b>1.8 i.e. (66 kW   1.8 Litre)</b>					
09.93 - 04.95	835 C4.000		246-083-001-004C	SWP-D-C	Plug Number (T2): 1
<b>1.8 i.e. (81 kW   1.8 Litre)</b>					
10.90 - 06.93	159 A4.000		246-083-001-004C	SWP-D-C	Plug Number (T2): 1
<b>1.8 i.e.16V Sport (100 kW   1.8 Litre)</b>					
11.89 - 06.92	160 A5.000		246-083-001-004C	SWP-D-C	Plug Number (T2): 1
<b>1.9 D (48 kW   1.9 Litre)</b>					
03.93 - 08.96	160 A7.000, 149 A1.000		246-083-001-004C	SWP-D-C	Plug Number (T2): 1
<b>1.9 TD (160.AW) (59 kW   1.9 Litre)</b>					
03.92 - 06.93	160 B6.046		246-083-001-004C	SWP-D-C	Plug Number (T2): 1
<b>1.9 TD (160.EL, 160.GL, 160.AQ, 160.EI, 160.AR) (66 kW   1.9 Litre)</b>					
03.93 - 04.95	160 D1.000, 160 A6.000, 160 A6.046		246-083-001-004C	SWP-D-C	Plug Number (T2): 1
<b>2.0 16V (160.AV) (107 kW   2.0 Litre)</b>					
03.93 - 04.95	160 A8.046		246-083-001-004C	SWP-D-C	Plug Number (T2): 1
<b>2.0 i.e. (160.AJ) (80 kW   2.0 Litre)</b>					
06.90 - 03.92	159 A5.046		246-083-001-004C	SWP-D-C	Plug Number (T2): 1
<b>2.0 i.e. (160.AT, 160.AJ) (83 kW   2.0 Litre)</b>					
03.93 - 04.95	159 A6.046		246-083-001-004C	SWP-D-C	Plug Number (T2): 1
<b>2.0 i.e. 16V Sport (160.EF) (102 kW   2.0 Litre)</b>					
03.93 - 04.95	836 A3.000		246-083-001-004C	SWP-D-C	Plug Number (T2): 1

**ULYSSE (179AX)**

<b>2.0 (100 kW   2.0 Litre)</b>					
08.02 - 06.11	RFN(EW10J4)		A2C53030301	SWP-D-C	
<b>2.0 D Multijet (100 kW   2.0 Litre)</b>					
05.06 - 06.11	RHR		A2C53030301	SWP-D-C	
<b>2.0 D Multijet (88 kW   2.0 Litre)</b>					
05.06 - 06.11	RHK		A2C53030301	SWP-D-C	
<b>2.0 JTD (79 kW   2.0 Litre)</b>					
05.03 - 08.06	RHM(DW10ATED4)		A2C53030301	SWP-D-C	
<b>2.0 JTD (80 kW   2.0 Litre)</b>					
08.02 - 08.06	RHW(DW10ATED4)		A2C53030301	SWP-D-C	
<b>2.2 D Multijet (125 kW   2.2 Litre)</b>					
03.08 - 06.11	4HT (DW12BTED4), 4HS		A2C53030301	SWP-D-C	



			<b>VDO</b>		
Date	Engine Code	Chassis No.	Article No.	Product	Information

**FIAT****ULYSSE (179AX)****2.2 JTD (94 kW | 2.2 Litre)**

08.02 - 08.06 | 4HW(DW12ATED4)

A2C53030301

SWP-D-C

**3.0 V6 (150 kW | 3.0 Litre)**

08.02 - 06.11 | XFW

A2C53030301

SWP-D-C

**DUCATO Bus (230)****1.9 D (50 kW | 1.9 Litre)**

04.98 - 04.02 | D9B, DJY

246-082-008-014C

SWP-M-C

Plug Number (T2): 1

**1.9 D (59 kW | 1.9 Litre)**

05.98 - 11.01 | 8140.43S

246-082-008-014C

SWP-M-C

Plug Number (T2): 1

**1.9 D Combinato (51 kW | 1.9 Litre)**

06.95 - 04.02 | 8140.43S

246-082-008-014C

SWP-M-C

Plug Number (T2): 1

**1.9 TD (66 kW | 1.9 Litre)**

04.98 - 04.02 | DHX (XUD9TF/L)

246-082-008-014C

SWP-M-C

Plug Number (T2): 1

**1.9 TD Combinato (59 kW | 1.9 Litre)**

08.94 - 04.02 | 8140.43S

246-082-008-014C

SWP-M-C

Plug Number (T2): 1

**1.9 TD Panorama/Combinato (60 kW | 1.9 Litre)**

03.94 - 04.02 | 8140.43S

246-082-008-014C

SWP-M-C

Plug Number (T2): 1

**2.0 JTD (62 kW | 2.0 Litre)**

10.01 - 04.02 | 8140.43S

246-082-008-014C

SWP-M-C

Plug Number (T2): 1

**2.0 Panorama/Combinato (80 kW | 2.0 Litre)**

03.94 - 04.02 | 8140.43S

246-082-008-014C

SWP-M-C

Plug Number (T2): 1

**2.5 D Combinato (62 kW | 2.5 Litre)**

08.94 - 04.02 | 8140.43S

246-082-008-014C

SWP-M-C

Plug Number (T2): 1

**2.5 TD 4x4 (85 kW | 2.5 Litre)**

11.94 - 04.98 | 8140.43S

246-082-008-014C

SWP-M-C

Plug Number (T2): 1

**2.5 TDI 4x4 (85 kW | 2.5 Litre)**

04.97 - 04.02 | 8140.47

246-082-008-014C

SWP-M-C

Plug Number (T2): 1

**2.5 TDI Combinato (80 kW | 2.5 Litre)**

08.94 - 04.02 | 8140.43S

246-082-008-014C

SWP-M-C

Plug Number (T2): 1

**2.5 TDI Panorama/Combinato (80 kW | 2.5 Litre)**

07.94 - 04.02 | 8140.43S

246-082-008-014C

SWP-M-C

Plug Number (T2): 1

**2.5 TDI Panorama/Combinato (85 kW | 2.5 Litre)**

03.94 - 04.02 | 8140.43S

246-082-008-014C

SWP-M-C

Plug Number (T2): 1

**2.8 D (64 kW | 2.8 Litre)**

02.98 - 04.02 | 8140.63

246-082-008-014C

SWP-M-C

Plug Number (T2): 1

**2.8 JTD (94 kW | 2.8 Litre)**

11.00 - 04.02 | 8140.43S

246-082-008-014C

SWP-M-C

Plug Number (T2): 1

**2.8 JTD 4x4 (94 kW | 2.8 Litre)**

11.00 - 04.02 | 8140.43S

246-082-008-014C

SWP-M-C

Plug Number (T2): 1

**2.8 TDI (90 kW | 2.8 Litre)**

10.97 - 04.02 | 8140.43S

246-082-008-014C

SWP-M-C

Plug Number (T2): 1

**2.8 TDI 4x4 (90 kW | 2.8 Litre)**

07.99 - 04.02 | 8140.43

246-082-008-014C

SWP-M-C

Plug Number (T2): 1

**DUCATO Box (230L)****1.9 D (50 kW | 1.9 Litre)**

04.98 - 04.02 | DJY

246-082-008-014C

SWP-M-C

Plug Number (T2): 1

**1.9 D (51 kW | 1.9 Litre)**

03.94 - 04.02 | 8140.43S

246-082-008-014C

SWP-M-C

Plug Number (T2): 1

**1.9 TD (60 kW | 1.9 Litre)**

03.94 - 04.02 | 230 A3.000

246-082-008-014C

SWP-M-C

Plug Number (T2): 1

**1.9 TD (66 kW | 1.9 Litre)**

04.98 - 04.02 | DHX (XUD9TF/L)

246-082-008-014C

SWP-M-C

Plug Number (T2): 1

**1.9 TD CAT (59 kW | 1.9 Litre)**

08.94 - 04.02 | 230 A4.000

246-082-008-014C

SWP-M-C

Plug Number (T2): 1

**2.0 (80 kW | 2.0 Litre)**

03.94 - 04.02 | 8140.43S

246-082-008-014C

SWP-M-C

Plug Number (T2): 1

**2.0 JTD (62 kW | 2.0 Litre)**

10.01 - 04.02 | 8140.43S

246-082-008-014C

SWP-M-C

Plug Number (T2): 1

**2.5 D (62 kW | 2.5 Litre)**

03.94 - 04.02 | 8140.43S

246-082-008-014C

SWP-M-C

Plug Number (T2): 1



			<b>VDO</b>		
Date	Engine Code	Chassis No.	Article No.	Product	Information

**FIAT****DUCATO Box (230L)**

<b>2.5 TD 4x4 (85 kW   2.5 Litre)</b>					
11.94 - 04.98	8140.43S		246-082-008-014C	SWP-M-C	Plug Number (T2): 1
<b>2.5 TDI (80 kW   2.5 Litre)</b>					
03.94 - 04.02	8140.43S		246-082-008-014C	SWP-M-C	Plug Number (T2): 1
<b>2.5 TDI 4x4 (85 kW   2.5 Litre)</b>					
05.98 - 04.02	8140.47		246-082-008-014C	SWP-M-C	Plug Number (T2): 1
<b>2.5 TDI Maxi (85 kW   2.5 Litre)</b>					
03.94 - 04.02	8140.43S		246-082-008-014C	SWP-M-C	Plug Number (T2): 1
<b>2.8 D (64 kW   2.8 Litre)</b>					
05.98 - 04.02	8140.63		246-082-008-014C	SWP-M-C	Plug Number (T2): 1
<b>2.8 D 4x4 (64 kW   2.8 Litre)</b>					
08.98 - 04.02	8140.63		246-082-008-014C	SWP-M-C	Plug Number (T2): 1
<b>2.8 JTD (94 kW   2.8 Litre)</b>					
11.00 - 04.02	8140.43S		246-082-008-014C	SWP-M-C	Plug Number (T2): 1
11.00 - 04.02	8140.43S		246-082-008-014C	SWP-M-C	Plug Number (T2): 1
<b>2.8 JTD 4x4 (94 kW   2.8 Litre)</b>					
11.00 - 04.02	8140.43S		246-082-008-014C	SWP-M-C	Plug Number (T2): 1
<b>2.8 TDI (90 kW   2.8 Litre)</b>					
10.97 - 04.02	8140.43		246-082-008-014C	SWP-M-C	Plug Number (T2): 1
<b>2.8 TDI 4x4 (90 kW   2.8 Litre)</b>					
06.99 - 04.02	8140.43		246-082-008-014C	SWP-M-C	Plug Number (T2): 1

**DUCATO Platform/Chassis (230)**

<b>1.9 D (50 kW   1.9 Litre)</b>					
04.98 - 04.02	DJY		246-082-008-014C	SWP-M-C	Plug Number (T2): 1
<b>1.9 D (51 kW   1.9 Litre)</b>					
03.94 - 04.02	230 A2.000		246-082-008-014C	SWP-M-C	Plug Number (T2): 1
<b>1.9 TD (59 kW   1.9 Litre)</b>					
05.98 - 11.01	8140.43S		246-082-008-014C	SWP-M-C	Plug Number (T2): 1
<b>1.9 TD (60 kW   1.9 Litre)</b>					
03.94 - 04.02	230 A3.000		246-082-008-014C	SWP-M-C	Plug Number (T2): 1
<b>1.9 TD (66 kW   1.9 Litre)</b>					
04.98 - 04.02	DHX (XUD9TF/L)		246-082-008-014C	SWP-M-C	Plug Number (T2): 1
<b>1.9 TD CAT (59 kW   1.9 Litre)</b>					
08.94 - 04.02	230 A4.000		246-082-008-014C	SWP-M-C	Plug Number (T2): 1
<b>2.0 (80 kW   2.0 Litre)</b>					
06.98 - 04.02	RFW		246-082-008-014C	SWP-M-C	Plug Number (T2): 1
<b>2.5 D (62 kW   2.5 Litre)</b>					
03.94 - 04.02	8140.67		246-082-008-014C	SWP-M-C	Plug Number (T2): 1
<b>2.5 D 4x4 (62 kW   2.5 Litre)</b>					
03.94 - 04.02	8140.67		246-082-008-014C	SWP-M-C	Plug Number (T2): 1
<b>2.5 TD 4x4 (85 kW   2.5 Litre)</b>					
11.94 - 04.98	8140.43S		246-082-008-014C	SWP-M-C	Plug Number (T2): 1
<b>2.5 TDI (80 kW   2.5 Litre)</b>					
03.94 - 04.02	8140.47R		246-082-008-014C	SWP-M-C	Plug Number (T2): 1
<b>2.5 TDI (85 kW   2.5 Litre)</b>					
03.94 - 04.02	8140.47		246-082-008-014C	SWP-M-C	Plug Number (T2): 1
<b>2.5 TDI 4x4 (85 kW   2.5 Litre)</b>					
06.98 - 04.02	8140.47		246-082-008-014C	SWP-M-C	Plug Number (T2): 1
<b>2.8 D (64 kW   2.8 Litre)</b>					
02.98 - 04.02	8140.63		246-082-008-014C	SWP-M-C	Plug Number (T2): 1
<b>2.8 JTD (94 kW   2.8 Litre)</b>					
11.00 - 04.02	8140.43S		246-082-008-014C	SWP-M-C	Plug Number (T2): 1
<b>2.8 TDI (90 kW   2.8 Litre)</b>					
12.98 - 04.02	8140.43		246-082-008-014C	SWP-M-C	Plug Number (T2): 1

**DUCATO Bus (244, Z\_)**

<b>2.0 (81 kW   2.0 Litre)</b>					
04.02 -	8140.43S		246-082-008-014C	SWP-M-C	Plug Number (T2): 1
<b>2.0 Bipower (81 kW   2.0 Litre)</b>					
11.02 -	8140.43S		246-082-008-014C	SWP-M-C	Plug Number (T2): 1
<b>2.0 JTD (62 kW   2.0 Litre)</b>					
04.02 -	8140.43S		246-082-008-014C	SWP-M-C	Plug Number (T2): 1



			<b>VDO</b>		
Date	Engine Code	Chassis No.	Article No.	Product	Information

**FIAT****DUCATO Bus (244, Z\_)****2.3 JTD (81 kW | 2.3 Litre)**

04.02 -	8140.43S		246-082-008-014C	SWP-M-C	Plug Number (T2): 1
---------	----------	--	------------------	---------	---------------------

**2.8 JTD (94 kW | 2.8 Litre)**

04.02 -	8140.43S		246-082-008-014C	SWP-M-C	Plug Number (T2): 1
---------	----------	--	------------------	---------	---------------------

**2.8 JTD 4x4 (94 kW | 2.8 Litre)**

07.02 -	8140.43S		246-082-008-014C	SWP-M-C	Plug Number (T2): 1
---------	----------	--	------------------	---------	---------------------

**DUCATO Box (244)****2.0 (81 kW | 2.0 Litre)**

04.02 -	8140.43S		246-082-008-014C	SWP-M-C	Plug Number (T2): 1
---------	----------	--	------------------	---------	---------------------

**2.0 Bipower (81 kW | 2.0 Litre)**

11.02 -	8140.43S		246-082-008-014C	SWP-M-C	Plug Number (T2): 1
---------	----------	--	------------------	---------	---------------------

**2.0 JTD (62 kW | 2.0 Litre)**

04.02 -	8140.43S		246-082-008-014C	SWP-M-C	Plug Number (T2): 1
---------	----------	--	------------------	---------	---------------------

**2.3 JTD (81 kW | 2.3 Litre)**

04.02 -	8140.43S		246-082-008-014C	SWP-M-C	Plug Number (T2): 1
---------	----------	--	------------------	---------	---------------------

**2.8 JTD (94 kW | 2.8 Litre)**

04.02 -	8140.43S		246-082-008-014C	SWP-M-C	Plug Number (T2): 1
---------	----------	--	------------------	---------	---------------------

**2.8 JTD 4x4 (94 kW | 2.8 Litre)**

07.02 -	8140.43S		246-082-008-014C	SWP-M-C	Plug Number (T2): 1
---------	----------	--	------------------	---------	---------------------

**2.8 JTD Power (107 kW | 2.8 Litre)**

05.04 -	8140.43S		246-082-008-014C	SWP-M-C	Plug Number (T2): 1
---------	----------	--	------------------	---------	---------------------

**DUCATO Platform/Chassis (244)****2.0 JTD (62 kW | 2.0 Litre)**

04.02 - 07.06	8140.43S		246-082-008-014C	SWP-M-C	Plug Number (T2): 1
---------------	----------	--	------------------	---------	---------------------

**2.3 JTD (81 kW | 2.3 Litre)**

04.02 - 07.06	8140.43S		246-082-008-014C	SWP-M-C	Plug Number (T2): 1
---------------	----------	--	------------------	---------	---------------------

**2.8 JTD (94 kW | 2.8 Litre)**

04.02 - 07.06	8140.43S		246-082-008-014C	SWP-M-C	Plug Number (T2): 1
---------------	----------	--	------------------	---------	---------------------

**2.8 JTD 4x4 (94 kW | 2.8 Litre)**

10.02 - 07.06	8140.43S		246-082-008-014C	SWP-M-C	Plug Number (T2): 1
---------------	----------	--	------------------	---------	---------------------

**2.8 JTD Power (107 kW | 2.8 Litre)**

05.04 - 07.06	8140.43S		246-082-008-014C	SWP-M-C	Plug Number (T2): 1
---------------	----------	--	------------------	---------	---------------------

**FORD****COUGAR (EC\_)****2.0 16V (96 kW | 2.0 Litre)**

08.98 - 12.01	EDBA, EDBB, EDBC, EDBD		X10-729-002-004	SWP-M-C	Plug Number (T2): 9
---------------	------------------------	--	-----------------	---------	---------------------

**2.5 ST 200 (151 kW | 2.5 Litre)**

01.00 - 12.01	SGA		X10-729-002-004	SWP-M-C	Plug Number (T2): 9
---------------	-----	--	-----------------	---------	---------------------

**2.5 V6 24V (125 kW | 2.5 Litre)**

06.00 - 12.01	LCBC, LCBE, LCBB		X10-729-002-004	SWP-M-C	Plug Number (T2): 9
---------------	------------------	--	-----------------	---------	---------------------

08.98 - 12.01	LCBA		X10-729-002-004	SWP-M-C	Plug Number (T2): 9
---------------	------	--	-----------------	---------	---------------------

**ESCORT III (GAA)****1.1 (37 kW | 1.1 Litre)**

08.83 - 12.85	GSE		X10-729-002-008	SWP-M-C	Plug Number (T2): 12
---------------	-----	--	-----------------	---------	----------------------

**1.1 (40 kW | 1.1 Litre)**

09.80 - 08.83	GMA, GLB		X10-729-002-008	SWP-M-C	Plug Number (T2): 12
---------------	----------	--	-----------------	---------	----------------------

**1.1 (43 kW | 1.1 Litre)**

09.80 - 08.83	GPA		X10-729-002-008	SWP-M-C	Plug Number (T2): 12
---------------	-----	--	-----------------	---------	----------------------

**1.3 (51 kW | 1.3 Litre)**

09.80 - 12.85	JPA		X10-729-002-008	SWP-M-C	Plug Number (T2): 12
---------------	-----	--	-----------------	---------	----------------------

**1.6 (48 kW | 1.6 Litre)**

05.83 - 07.86	CHT 1600		X10-729-002-008	SWP-M-C	Plug Number (T2): 12
---------------	----------	--	-----------------	---------	----------------------

**1.6 (58 kW | 1.6 Litre)**

09.80 - 12.85	LPA, LP1		X10-729-002-008	SWP-M-C	Plug Number (T2): 12
---------------	----------	--	-----------------	---------	----------------------

**1.6 (71 kW | 1.6 Litre)**

09.80 - 10.82	LUA		X10-729-002-008	SWP-M-C	Plug Number (T2): 12
---------------	-----	--	-----------------	---------	----------------------





Date	Engine Code	Chassis No.	Article No.	Product	Information

**FORD****ESCORT III (GAA)****1.6 D (40 kW | 1.6 Litre)**

02.84 - 12.85 LTA X10-729-002-008 SWP-M-C Plug Number (T2): 12

**1.6 i (GAA) (66 kW | 1.6 Litre)**

07.85 - 12.85 L4B X10-729-002-008 SWP-M-C Plug Number (T2): 12

**1.6 RS Turbo (97 kW | 1.6 Litre)**

11.84 - 12.85 LNA X10-729-002-008 SWP-M-C Plug Number (T2): 12

**1.6 XR3i (77 kW | 1.6 Litre)**

10.82 - 12.85 LRA, LR1 X10-729-002-008 SWP-M-C Plug Number (T2): 12

**RS 1600i (85 kW | 1.6 Litre)**

05.82 - 12.85 LUAE X10-729-002-008 SWP-M-C Plug Number (T2): 12

**ESCORT III Convertible (ALD)****1.3 (51 kW | 1.3 Litre)**

09.83 - 12.85 JPA X10-729-002-008 SWP-M-C Plug Number (T2): 12

**1.6 (58 kW | 1.6 Litre)**

09.83 - 12.85 LPA, LP1 X10-729-002-008 SWP-M-C Plug Number (T2): 12

**1.6 i (77 kW | 1.6 Litre)**

09.83 - 12.85 LRA, LR1 X10-729-002-008 SWP-M-C Plug Number (T2): 12

**ESCORT IV (GAF, AWF, ABFT)****1.1 (37 kW | 1.1 Litre)**

09.88 - 07.90 GSG X10-729-002-004 SWP-M-C Plug Number (T2): 9; T24: C →

09.88 - 07.90 GSG X10-729-002-005 SWP-M-C Plug Number (T2): 9; T24: C →; Vehicle Equipment (T31): with rear-window wiper (T34)

**1.3 (44 kW | 1.3 Litre)**

09.88 - 07.90 JLA, JLB, JBB X10-729-002-004 SWP-M-C Plug Number (T2): 9; T24: C →

09.88 - 07.90 JLA, JLB, JBB X10-729-002-005 SWP-M-C Plug Number (T2): 9; T24: C →; Vehicle Equipment (T31): with rear-window wiper (T34)

**1.3 (51 kW | 1.3 Litre)**

11.86 - 07.88 X10-729-002-005 SWP-M-C Plug Number (T2): 9

**1.3 (GAF) (46 kW | 1.3 Litre)**

09.88 - 10.90 JBA X10-729-002-004 SWP-M-C Plug Number (T2): 9; T24: C →

09.88 - 10.90 JBA X10-729-002-005 SWP-M-C Plug Number (T2): 9; T24: C →; Vehicle Equipment (T31): with rear-window wiper (T34)

**1.4 (51 kW | 1.4 Litre)**

09.88 - 10.90 FUAA X10-729-002-004 SWP-M-C Plug Number (T2): 9; T24: C →

09.88 - 10.90 FUAA X10-729-002-005 SWP-M-C Plug Number (T2): 9; T24: C →; Vehicle Equipment (T31): with rear-window wiper (T34)

**1.4 (54 kW | 1.4 Litre)**

09.88 - 07.90 F6B, F6D, FUC X10-729-002-004 SWP-M-C Plug Number (T2): 9; T24: C →

09.88 - 07.90 F6B, F6D, FUC X10-729-002-005 SWP-M-C Plug Number (T2): 9; T24: C →; Vehicle Equipment (T31): with rear-window wiper (T34)

**1.4 (55 kW | 1.4 Litre)**

09.88 - 07.90 FUA X10-729-002-004 SWP-M-C Plug Number (T2): 9; T24: C →

09.88 - 07.90 FUA X10-729-002-005 SWP-M-C Plug Number (T2): 9; T24: C →; Vehicle Equipment (T31): with rear-window wiper (T34)

**1.6 (58 kW | 1.6 Litre)**

09.88 - 12.88 LP2 X10-729-002-004 SWP-M-C Plug Number (T2): 9; T24: C →

09.88 - 12.88 LP2 X10-729-002-005 SWP-M-C Plug Number (T2): 9; T24: C →; Vehicle Equipment (T31): with rear-window wiper (T34)

**1.6 (65 kW | 1.6 Litre)**

04.89 - 07.90 LUG X10-729-002-004 SWP-M-C Plug Number (T2): 9; T24: C →

04.89 - 07.90 LUG X10-729-002-005 SWP-M-C Plug Number (T2): 9; T24: C →; Vehicle Equipment (T31): with rear-window wiper (T34)

**1.6 D (40 kW | 1.6 Litre)**

09.88 - 01.89 LTC X10-729-002-004 SWP-M-C Plug Number (T2): 9; T24: C →

09.88 - 01.89 LTC X10-729-002-005 SWP-M-C Plug Number (T2): 9; T24: C →; Vehicle Equipment (T31): with rear-window wiper (T34)

**1.6 i (66 kW | 1.6 Litre)**

09.88 - 05.90 L4B X10-729-002-004 SWP-M-C Plug Number (T2): 9; T24: C →

09.88 - 05.90 L4B X10-729-002-005 SWP-M-C Plug Number (T2): 9; T24: C →; Vehicle Equipment (T31): with rear-window wiper (T34)



			<b>VDO</b>		
Date	Engine Code	Chassis No.	Article No.	Product	Information

**FORD****ESCORT IV (GAF, AWF, ABFT)****1.6 i (75 kW | 1.6 Litre)**

08.89 - 07.90	LJB		X10-729-002-004	SWP-M-C	Plug Number (T2): 9; T24: C →
08.89 - 07.90	LJB		X10-729-002-005	SWP-M-C	Plug Number (T2): 9; T24: C →; Vehicle Equipment (T31): with rear-window wiper (T34)

**1.6 Turbo RS (97 kW | 1.6 Litre)**

09.88 - 07.90	LNB		X10-729-002-004	SWP-M-C	Plug Number (T2): 9; T24: C →
09.88 - 07.90	LNB		X10-729-002-005	SWP-M-C	Plug Number (T2): 9; T24: C →; Vehicle Equipment (T31): with rear-window wiper (T34)

**1.6 XR3i (77 kW | 1.6 Litre)**

09.88 - 08.89	LR2, LRB		X10-729-002-004	SWP-M-C	Plug Number (T2): 9; T24: C →
09.88 - 08.89	LR2, LRB		X10-729-002-005	SWP-M-C	Plug Number (T2): 9; T24: C →; Vehicle Equipment (T31): with rear-window wiper (T34)

**1.8 D (44 kW | 1.8 Litre)**

01.89 - 07.90	RTA, RTB		X10-729-002-004	SWP-M-C	Plug Number (T2): 9; T24: C →
01.89 - 07.90	RTA, RTB		X10-729-002-005	SWP-M-C	Plug Number (T2): 9; T24: C →; Vehicle Equipment (T31): with rear-window wiper (T34)

**ESCORT IV Estate (AWF, AVF)****1.1 (37 kW | 1.1 Litre)**

08.88 - 09.90	GSG		X10-729-002-005	SWP-M-C	Plug Number (T2): 9; T24: CL →; Vehicle Equipment (T31): with rear-window wiper (T34)
---------------	-----	--	-----------------	---------	---------------------------------------------------------------------------------------

**1.3 (44 kW | 1.3 Litre)**

08.88 - 07.90	JLA, JLB, JBB		X10-729-002-005	SWP-M-C	Plug Number (T2): 9; T24: CL →; Vehicle Equipment (T31): with rear-window wiper (T34)
---------------	---------------	--	-----------------	---------	---------------------------------------------------------------------------------------

**1.3 (51 kW | 1.3 Litre)**

11.86 - 07.88			X10-729-002-005	SWP-M-C	Plug Number (T2): 9
---------------	--	--	-----------------	---------	---------------------

**1.4 (51 kW | 1.4 Litre)**

08.88 - 10.90	FUAA		X10-729-002-005	SWP-M-C	Plug Number (T2): 9; T24: CL →; Vehicle Equipment (T31): with rear-window wiper (T34)
---------------	------	--	-----------------	---------	---------------------------------------------------------------------------------------

**1.4 (54 kW | 1.4 Litre)**

08.88 - 07.90	F6B, F6D, FUC		X10-729-002-005	SWP-M-C	Plug Number (T2): 9; T24: CL →; Vehicle Equipment (T31): with rear-window wiper (T34)
---------------	---------------	--	-----------------	---------	---------------------------------------------------------------------------------------

**1.4 (55 kW | 1.4 Litre)**

08.88 - 07.90	FUA		X10-729-002-005	SWP-M-C	Plug Number (T2): 9; T24: CL →; Vehicle Equipment (T31): with rear-window wiper (T34)
---------------	-----	--	-----------------	---------	---------------------------------------------------------------------------------------

**1.6 (58 kW | 1.6 Litre)**

08.88 - 07.90	LP2		X10-729-002-005	SWP-M-C	Plug Number (T2): 9; T24: CL →; Vehicle Equipment (T31): with rear-window wiper (T34)
---------------	-----	--	-----------------	---------	---------------------------------------------------------------------------------------

**1.6 D (40 kW | 1.6 Litre)**

08.88 - 01.89	LTC		X10-729-002-005	SWP-M-C	Plug Number (T2): 9; T24: CL →; Vehicle Equipment (T31): with rear-window wiper (T34)
---------------	-----	--	-----------------	---------	---------------------------------------------------------------------------------------

**1.6 i (66 kW | 1.6 Litre)**

08.88 - 07.90	L4B		X10-729-002-005	SWP-M-C	Plug Number (T2): 9; T24: CL →; Vehicle Equipment (T31): with rear-window wiper (T34)
---------------	-----	--	-----------------	---------	---------------------------------------------------------------------------------------

**1.8 D (44 kW | 1.8 Litre)**

01.89 - 07.90	RTA, RTB		X10-729-002-005	SWP-M-C	Plug Number (T2): 9; T24: CL →; Vehicle Equipment (T31): with rear-window wiper (T34)
---------------	----------	--	-----------------	---------	---------------------------------------------------------------------------------------

**ESCORT IV Convertible (ALF)****1.4 (54 kW | 1.4 Litre)**

02.87 - 07.90	F6B, F6D, FUC		X10-729-002-005	SWP-M-C	Plug Number (T2): 9
---------------	---------------	--	-----------------	---------	---------------------

**1.4 (55 kW | 1.4 Litre)**

01.86 - 07.90	FUA		X10-729-002-005	SWP-M-C	Plug Number (T2): 9
---------------	-----	--	-----------------	---------	---------------------

**1.6 (58 kW | 1.6 Litre)**

01.86 - 12.87	LPA, LP2		X10-729-002-005	SWP-M-C	Plug Number (T2): 9
---------------	----------	--	-----------------	---------	---------------------

**1.6 i (66 kW | 1.6 Litre)**

01.86 - 07.90	L4B		X10-729-002-005	SWP-M-C	Plug Number (T2): 9
---------------	-----	--	-----------------	---------	---------------------

**1.6 i (75 kW | 1.6 Litre)**

08.89 - 07.90	LJB		X10-729-002-005	SWP-M-C	Plug Number (T2): 9
---------------	-----	--	-----------------	---------	---------------------

**1.6 XR3i (77 kW | 1.6 Litre)**

01.86 - 07.90	LR2, LRB		X10-729-002-005	SWP-M-C	Plug Number (T2): 9
---------------	----------	--	-----------------	---------	---------------------



					
Date	Engine Code	Chassis No.	Article No.	Product	Information

**FORD****ESCORT V (GAL)****1.3 (44 kW | 1.3 Litre)**

07.90 - 09.92	J6A, J4B		X10-729-002-004	SWP-M-C	Plug Number (T2): 9; T24: CL →; Ghia →; Vehicle Equipment (T31): with rear-window wiper (T34)
---------------	----------	--	-----------------	---------	-----------------------------------------------------------------------------------------------

07.90 - 09.92	J6A, J4B		X10-729-002-005	SWP-M-C	Plug Number (T2): 9
---------------	----------	--	-----------------	---------	---------------------

**1.4 (52 kW | 1.4 Litre)**

07.90 - 09.92	F6F, F6G		X10-729-002-004	SWP-M-C	Plug Number (T2): 9; T24: CL →; Ghia →; Vehicle Equipment (T31): with rear-window wiper (T34)
---------------	----------	--	-----------------	---------	-----------------------------------------------------------------------------------------------

07.90 - 09.92	F6F, F6G		X10-729-002-005	SWP-M-C	Plug Number (T2): 9
---------------	----------	--	-----------------	---------	---------------------

**1.6 (66 kW | 1.6 Litre)**

07.90 - 08.92	LUK, LUJ		X10-729-002-004	SWP-M-C	Plug Number (T2): 9; T24: CL →; Ghia →; Vehicle Equipment (T31): with rear-window wiper (T34)
---------------	----------	--	-----------------	---------	-----------------------------------------------------------------------------------------------

07.90 - 08.92	LUK, LUJ		X10-729-002-005	SWP-M-C	Plug Number (T2): 9
---------------	----------	--	-----------------	---------	---------------------

**1.6 (77 kW | 1.6 Litre)**

07.90 - 12.92	LJF		X10-729-002-004	SWP-M-C	Plug Number (T2): 9; T24: CL →; Ghia →; Vehicle Equipment (T31): with rear-window wiper (T34)
---------------	-----	--	-----------------	---------	-----------------------------------------------------------------------------------------------

07.90 - 12.92	LJF		X10-729-002-005	SWP-M-C	Plug Number (T2): 9
---------------	-----	--	-----------------	---------	---------------------

**1.8 16V XR3i (77 kW | 1.8 Litre)**

02.92 - 12.92	RDA		X10-729-002-004	SWP-M-C	Plug Number (T2): 9; T24: CL →; Ghia →; Vehicle Equipment (T31): with rear-window wiper (T34)
---------------	-----	--	-----------------	---------	-----------------------------------------------------------------------------------------------

02.92 - 12.92	RDA		X10-729-002-005	SWP-M-C	Plug Number (T2): 9
---------------	-----	--	-----------------	---------	---------------------

**1.8 16V XR3i (96 kW | 1.8 Litre)**

02.92 - 12.92	RQB		X10-729-002-004	SWP-M-C	Plug Number (T2): 9; T24: CL →; Ghia →; Vehicle Equipment (T31): with rear-window wiper (T34)
---------------	-----	--	-----------------	---------	-----------------------------------------------------------------------------------------------

02.92 - 12.92	RQB		X10-729-002-005	SWP-M-C	Plug Number (T2): 9
---------------	-----	--	-----------------	---------	---------------------

**1.8 D (44 kW | 1.8 Litre)**

07.90 - 12.92	RTE, RTF, RTH		X10-729-002-004	SWP-M-C	Plug Number (T2): 9; T24: CL →; Ghia →; Vehicle Equipment (T31): with rear-window wiper (T34)
---------------	---------------	--	-----------------	---------	-----------------------------------------------------------------------------------------------

07.90 - 12.92	RTE, RTF, RTH		X10-729-002-005	SWP-M-C	Plug Number (T2): 9
---------------	---------------	--	-----------------	---------	---------------------

**RS 2000 (110 kW | 2.0 Litre)**

05.91 - 12.92	N7A		X10-729-002-004	SWP-M-C	Plug Number (T2): 9; T24: CL →; Ghia →; Vehicle Equipment (T31): with rear-window wiper (T34)
---------------	-----	--	-----------------	---------	-----------------------------------------------------------------------------------------------

05.91 - 12.92	N7A		X10-729-002-005	SWP-M-C	Plug Number (T2): 9
---------------	-----	--	-----------------	---------	---------------------

**ESCORT V Estate (GAL, AVL)****1.3 (44 kW | 1.3 Litre)**

09.91 - 09.92	J6A, J4B		X10-729-002-004	SWP-M-C	Plug Number (T2): 9; T24: CL →
---------------	----------	--	-----------------	---------	--------------------------------

**1.4 (52 kW | 1.4 Litre)**

07.90 - 09.92	F6F, F6G		X10-729-002-004	SWP-M-C	Plug Number (T2): 9; T24: CL →
---------------	----------	--	-----------------	---------	--------------------------------

**1.6 (66 kW | 1.6 Litre)**

07.90 - 08.92	LUK, LUJ		X10-729-002-004	SWP-M-C	Plug Number (T2): 9; T24: CL →
---------------	----------	--	-----------------	---------	--------------------------------

**1.6 (77 kW | 1.6 Litre)**

07.90 - 09.92	LJF		X10-729-002-004	SWP-M-C	Plug Number (T2): 9; T24: CL →
---------------	-----	--	-----------------	---------	--------------------------------

**1.8 16V (77 kW | 1.8 Litre)**

02.92 - 12.92	RDA		X10-729-002-004	SWP-M-C	Plug Number (T2): 9; T24: CL →
---------------	-----	--	-----------------	---------	--------------------------------

**1.8 D (44 kW | 1.8 Litre)**

07.90 - 12.92	RTE, RTF, RTH		X10-729-002-004	SWP-M-C	Plug Number (T2): 9; T24: CL →
---------------	---------------	--	-----------------	---------	--------------------------------

**ESCORT V Convertible (ALL)****1.4 (52 kW | 1.4 Litre)**

07.90 - 12.92	F6F, F6G		X10-729-002-004	SWP-M-C	Plug Number (T2): 9
---------------	----------	--	-----------------	---------	---------------------

**1.6 (77 kW | 1.6 Litre)**

07.90 - 12.92	LJF		X10-729-002-004	SWP-M-C	Plug Number (T2): 9
---------------	-----	--	-----------------	---------	---------------------

**1.8 16V XR3i (77 kW | 1.8 Litre)**

02.92 - 12.92	RDA		X10-729-002-004	SWP-M-C	Plug Number (T2): 9
---------------	-----	--	-----------------	---------	---------------------



					
Date	Engine Code	Chassis No.	Article No.	Product	Information

**FORD****ESCORT V Convertible (ALL)****1.8 16V XR3i (96 kW | 1.8 Litre)**

02.92 - 12.92	RQB		X10-729-002-004	SWP-M-C	Plug Number (T2): 9
---------------	-----	--	-----------------	---------	---------------------

**ESCORT VI (GAL)****1.3 (44 kW | 1.3 Litre)**

09.92 - 01.95	J6A, J4B		X10-729-002-004	SWP-M-C	Plug Number (T2): 9; T24: CL →; Ghia →; Vehicle Equipment (T31): with rear-window wiper (T34)
---------------	----------	--	-----------------	---------	-----------------------------------------------------------------------------------------------

**1.4 (52 kW | 1.4 Litre)**

09.92 - 01.95	F6F, F6G		X10-729-002-004	SWP-M-C	Plug Number (T2): 9; T24: CL →; Ghia →; Vehicle Equipment (T31): with rear-window wiper (T34)
---------------	----------	--	-----------------	---------	-----------------------------------------------------------------------------------------------

**1.4 (55 kW | 1.4 Litre)**

01.94 - 01.95	FUH, F4B		X10-729-002-004	SWP-M-C	Plug Number (T2): 9; T24: CL →; Ghia →; Vehicle Equipment (T31): with rear-window wiper (T34)
---------------	----------	--	-----------------	---------	-----------------------------------------------------------------------------------------------

**1.6 i 16V (65 kW | 1.6 Litre)**

01.94 - 01.95	L1H		X10-729-002-004	SWP-M-C	Plug Number (T2): 9; T24: CL →; Ghia →; Vehicle Equipment (T31): with rear-window wiper (T34)
---------------	-----	--	-----------------	---------	-----------------------------------------------------------------------------------------------

**1.6 i 16V (66 kW | 1.6 Litre)**

09.92 - 01.95	L1E		X10-729-002-004	SWP-M-C	Plug Number (T2): 9; T24: CL →; Ghia →; Vehicle Equipment (T31): with rear-window wiper (T34)
---------------	-----	--	-----------------	---------	-----------------------------------------------------------------------------------------------

**1.8 D (44 kW | 1.8 Litre)**

09.92 - 01.95	RTE, RTF, RTH		X10-729-002-004	SWP-M-C	Plug Number (T2): 9; T24: CL →; Ghia →; Vehicle Equipment (T31): with rear-window wiper (T34)
---------------	---------------	--	-----------------	---------	-----------------------------------------------------------------------------------------------

**1.8 i 16V (77 kW | 1.8 Litre)**

09.92 - 01.95	RDA		X10-729-002-004	SWP-M-C	Plug Number (T2): 9; T24: CL →; Ghia →; Vehicle Equipment (T31): with rear-window wiper (T34)
---------------	-----	--	-----------------	---------	-----------------------------------------------------------------------------------------------

**1.8 TD (66 kW | 1.8 Litre)**

02.93 - 01.95	RFD, RFK, RFS		X10-729-002-004	SWP-M-C	Plug Number (T2): 9; T24: CL →; Ghia →; Vehicle Equipment (T31): with rear-window wiper (T34)
---------------	---------------	--	-----------------	---------	-----------------------------------------------------------------------------------------------

**1.8 XR3i 16V 4x4 (77 kW | 1.8 Litre)**

08.93 - 01.95	RDA		X10-729-002-004	SWP-M-C	Plug Number (T2): 9; T24: CL →; Ghia →; Vehicle Equipment (T31): with rear-window wiper (T34)
---------------	-----	--	-----------------	---------	-----------------------------------------------------------------------------------------------

**1.8 XR3i 16V 4x4 (96 kW | 1.8 Litre)**

08.93 - 01.95	RQB		X10-729-002-004	SWP-M-C	Plug Number (T2): 9; T24: CL →; Ghia →; Vehicle Equipment (T31): with rear-window wiper (T34)
---------------	-----	--	-----------------	---------	-----------------------------------------------------------------------------------------------

**RS 2000 (110 kW | 2.0 Litre)**

09.92 - 01.95	N7A		X10-729-002-004	SWP-M-C	Plug Number (T2): 9; T24: CL →; Ghia →; Vehicle Equipment (T31): with rear-window wiper (T34)
---------------	-----	--	-----------------	---------	-----------------------------------------------------------------------------------------------

**RS 2000 4x4 (110 kW | 2.0 Litre)**

08.93 - 01.95	N7A		X10-729-002-004	SWP-M-C	Plug Number (T2): 9; T24: CL →; Ghia →; Vehicle Equipment (T31): with rear-window wiper (T34)
---------------	-----	--	-----------------	---------	-----------------------------------------------------------------------------------------------

**RS Cosworth 4x4 (162 kW | 2.0 Litre)**

09.92 - 01.95	N5F		X10-729-002-004	SWP-M-C	Plug Number (T2): 9; T24: CL →; Ghia →; Vehicle Equipment (T31): with rear-window wiper (T34)
---------------	-----	--	-----------------	---------	-----------------------------------------------------------------------------------------------

**ESCORT VI Estate (GAL)****1.3 (44 kW | 1.3 Litre)**

09.92 - 01.95	J6A, J4B		X10-729-002-004	SWP-M-C	Plug Number (T2): 9; T24: CL →
---------------	----------	--	-----------------	---------	--------------------------------

**1.4 (52 kW | 1.4 Litre)**

09.92 - 01.94	F6F, F6G		X10-729-002-004	SWP-M-C	Plug Number (T2): 9; T24: CL →
---------------	----------	--	-----------------	---------	--------------------------------



			<b>VDO</b>		
Date	Engine Code	Chassis No.	Article No.	Product	Information

**FORD****ESCORT VI Estate (GAL)****1.4 (55 kW | 1.4 Litre)**

01.94 → 01.95 F4B, FUH X10-729-002-004 SWP-M-C Plug Number (T2): 9; T24: CL →

**1.6 i 16V (65 kW | 1.6 Litre)**

01.94 → 01.95 L1H X10-729-002-004 SWP-M-C Plug Number (T2): 9; T24: CL →

**1.6 i 16V (66 kW | 1.6 Litre)**

09.92 → 01.95 L1E X10-729-002-004 SWP-M-C Plug Number (T2): 9; T24: CL →

**1.8 D (44 kW | 1.8 Litre)**

09.92 → 01.95 RTH X10-729-002-004 SWP-M-C Plug Number (T2): 9; T24: CL →

**1.8 i 16V (77 kW | 1.8 Litre)**

01.93 → 01.95 RDA X10-729-002-004 SWP-M-C Plug Number (T2): 9; T24: CL →

**1.8 i 16V (96 kW | 1.8 Litre)**

02.93 → 01.95 RQB X10-729-002-004 SWP-M-C Plug Number (T2): 9; T24: CL →

**1.8 TD (66 kW | 1.8 Litre)**

02.93 → 01.95 RFD, RFK X10-729-002-004 SWP-M-C Plug Number (T2): 9; T24: CL →

**ESCORT VII (GAL, AAL, ABL)****1.3 (44 kW | 1.3 Litre)**

01.95 → 10.98 J6A, J4B X10-729-002-004 SWP-M-C Plug Number (T2): 9; T24: CL →; Ghia →; Vehicle Equipment (T31): with rear-window wiper (T34)

**1.4 (55 kW | 1.4 Litre)**

01.95 → 10.98 F4B X10-729-002-004 SWP-M-C Plug Number (T2): 9; T24: CL →; Ghia →; Vehicle Equipment (T31): with rear-window wiper (T34)

**1.6 16V (66 kW | 1.6 Litre)**

01.95 → 10.98 L1E X10-729-002-004 SWP-M-C Plug Number (T2): 9; T24: CL →; Ghia →; Vehicle Equipment (T31): with rear-window wiper (T34)

**1.6 16V 4x4 (66 kW | 1.6 Litre)**

01.95 → 10.98 L1E X10-729-002-004 SWP-M-C Plug Number (T2): 9; T24: CL →; Ghia →; Vehicle Equipment (T31): with rear-window wiper (T34)

**1.6 i 16V (65 kW | 1.6 Litre)**

01.95 → 08.95 L1H X10-729-002-004 SWP-M-C Plug Number (T2): 9; T24: CL →; Ghia →; Vehicle Equipment (T31): with rear-window wiper (T34)

**1.8 16V (77 kW | 1.8 Litre)**

01.95 → 08.95 RDA X10-729-002-004 SWP-M-C Plug Number (T2): 9; T24: CL →; Ghia →; Vehicle Equipment (T31): with rear-window wiper (T34)

**1.8 16V (85 kW | 1.8 Litre)**

01.95 → 10.98 RKC X10-729-002-004 SWP-M-C Plug Number (T2): 9; T24: CL →; Ghia →; Vehicle Equipment (T31): with rear-window wiper (T34)

**1.8 D (44 kW | 1.8 Litre)**

01.95 → 12.96 RTE, RTF, RTH X10-729-002-004 SWP-M-C Plug Number (T2): 9; T24: CL →; Ghia →; Vehicle Equipment (T31): with rear-window wiper (T34)

**1.8 TD (66 kW | 1.8 Litre)**

01.95 → 10.98 RFD, RFK X10-729-002-004 SWP-M-C Plug Number (T2): 9; T24: CL →; Ghia →; Vehicle Equipment (T31): with rear-window wiper (T34)

**1.8 Turbo D (51 kW | 1.8 Litre)**

12.95 → 10.98 RVA X10-729-002-004 SWP-M-C Plug Number (T2): 9; T24: CL →; Ghia →; Vehicle Equipment (T31): with rear-window wiper (T34)

**RS 2000 (110 kW | 2.0 Litre)**

02.95 → 02.98 N7A X10-729-002-004 SWP-M-C Plug Number (T2): 9; T24: CL →; Ghia →; Vehicle Equipment (T31): with rear-window wiper (T34)



			<b>VDO</b>		
Date	Engine Code	Chassis No.	Article No.	Product	Information

**FORD****ESCORT VII (GAL, AAL, ABL)****RS 2000 4x4 (110 kW | 2.0 Litre)**

02.95 - 10.98	N7A		X10-729-002-004	SWP-M-C	Plug Number (T2): 9; T24: CL →; Ghia →; Vehicle Equipment (T31): with rear-window wiper (T34)
---------------	-----	--	-----------------	---------	-----------------------------------------------------------------------------------------------

**RS Cosworth 4x4 (162 kW | 2.0 Litre)**

02.95 - 10.98	N5F		X10-729-002-004	SWP-M-C	Plug Number (T2): 9; T24: CL →; Ghia →; Vehicle Equipment (T31): with rear-window wiper (T34)
---------------	-----	--	-----------------	---------	-----------------------------------------------------------------------------------------------

**ESCORT VII Estate (GAL, ANL)****1.3 (44 kW | 1.3 Litre)**

01.95 - 10.98	J6A, J4B		X10-729-002-004	SWP-M-C	Plug Number (T2): 9; T24: CL →
---------------	----------	--	-----------------	---------	--------------------------------

**1.4 (55 kW | 1.4 Litre)**

01.95 - 02.99	FUH, F4B		X10-729-002-004	SWP-M-C	Plug Number (T2): 9; T24: CL →
---------------	----------	--	-----------------	---------	--------------------------------

**1.6 16V (66 kW | 1.6 Litre)**

01.95 - 02.99	L1E		X10-729-002-004	SWP-M-C	Plug Number (T2): 9; T24: CL →
---------------	-----	--	-----------------	---------	--------------------------------

**1.6 i 16V (65 kW | 1.6 Litre)**

01.95 - 08.95	L1H		X10-729-002-004	SWP-M-C	Plug Number (T2): 9; T24: CL →
---------------	-----	--	-----------------	---------	--------------------------------

**1.8 16V (77 kW | 1.8 Litre)**

01.95 - 08.95	RDA		X10-729-002-004	SWP-M-C	Plug Number (T2): 9; T24: CL →
---------------	-----	--	-----------------	---------	--------------------------------

**1.8 16V (85 kW | 1.8 Litre)**

01.95 - 02.99	RKC		X10-729-002-004	SWP-M-C	Plug Number (T2): 9; T24: CL →
---------------	-----	--	-----------------	---------	--------------------------------

**1.8 D (44 kW | 1.8 Litre)**

01.95 - 02.99	RTH, RTF, RTE		X10-729-002-004	SWP-M-C	Plug Number (T2): 9; T24: CL →
---------------	---------------	--	-----------------	---------	--------------------------------

**1.8 TD (66 kW | 1.8 Litre)**

01.95 - 02.99	RFD, RFK		X10-729-002-004	SWP-M-C	Plug Number (T2): 9; T24: CL →
---------------	----------	--	-----------------	---------	--------------------------------

**1.8 Turbo D (51 kW | 1.8 Litre)**

12.95 - 02.99	RVA		X10-729-002-004	SWP-M-C	Plug Number (T2): 9; T24: CL →
---------------	-----	--	-----------------	---------	--------------------------------

**ESCORT VII Convertible (ALL)****1.4 (55 kW | 1.4 Litre)**

02.95 - 09.97	F4B		X10-729-002-004	SWP-M-C	Plug Number (T2): 9
---------------	-----	--	-----------------	---------	---------------------

**1.6 16V XR3i (65 kW | 1.6 Litre)**

02.95 - 12.96	L1H		X10-729-002-004	SWP-M-C	Plug Number (T2): 9
---------------	-----	--	-----------------	---------	---------------------

**1.6 16V XR3i (66 kW | 1.6 Litre)**

02.95 - 09.97	L1E		X10-729-002-004	SWP-M-C	Plug Number (T2): 9
---------------	-----	--	-----------------	---------	---------------------

**1.8 16V XR3i (77 kW | 1.8 Litre)**

02.95 - 09.97	RDA		X10-729-002-004	SWP-M-C	Plug Number (T2): 9
---------------	-----	--	-----------------	---------	---------------------

**1.8 16V XR3i (85 kW | 1.8 Litre)**

10.95 - 09.97	RKC		X10-729-002-004	SWP-M-C	Plug Number (T2): 9
---------------	-----	--	-----------------	---------	---------------------

**1.8 16V XR3i (96 kW | 1.8 Litre)**

02.95 - 09.97	RQB		X10-729-002-004	SWP-M-C	Plug Number (T2): 9
---------------	-----	--	-----------------	---------	---------------------

**1.8 TD (66 kW | 1.8 Litre)**

09.95 - 09.97	RFD, RFK		X10-729-002-004	SWP-M-C	Plug Number (T2): 9
---------------	----------	--	-----------------	---------	---------------------

**1.8 Turbo D (51 kW | 1.8 Litre)**

10.96 - 09.97	RVA		X10-729-002-004	SWP-M-C	Plug Number (T2): 9
---------------	-----	--	-----------------	---------	---------------------

**FIESTA I (GFBT)****0.9 (29 kW | 0.9 Litre)**

05.76 - 08.83	TKA, TKW		X10-729-002-005	SWP-M-C	Plug Number (T2): 9
---------------	----------	--	-----------------	---------	---------------------

05.76 - 08.83	TKA, TKW		X10-729-002-008	SWP-M-C	Plug Number (T2): 12
---------------	----------	--	-----------------	---------	----------------------

**0.9 (33 kW | 0.9 Litre)**

05.76 - 08.83	TLA		X10-729-002-005	SWP-M-C	Plug Number (T2): 9
---------------	-----	--	-----------------	---------	---------------------

05.76 - 08.83	TLA		X10-729-002-008	SWP-M-C	Plug Number (T2): 12
---------------	-----	--	-----------------	---------	----------------------

**1.1 (39 kW | 1.1 Litre)**

05.76 - 08.83	GLA		X10-729-002-005	SWP-M-C	Plug Number (T2): 9
---------------	-----	--	-----------------	---------	---------------------

05.76 - 08.83	GLA		X10-729-002-008	SWP-M-C	Plug Number (T2): 12
---------------	-----	--	-----------------	---------	----------------------

**1.1 (WFBT) (40 kW | 1.1 Litre)**

02.81 - 08.83	GLW		X10-729-002-005	SWP-M-C	Plug Number (T2): 9
---------------	-----	--	-----------------	---------	---------------------

02.81 - 08.83	GLW		X10-729-002-008	SWP-M-C	Plug Number (T2): 12
---------------	-----	--	-----------------	---------	----------------------

**1.3 (49 kW | 1.3 Litre)**

08.77 - 08.83	J3E		X10-729-002-005	SWP-M-C	Plug Number (T2): 9
---------------	-----	--	-----------------	---------	---------------------

08.77 - 08.83	J3E		X10-729-002-008	SWP-M-C	Plug Number (T2): 12
---------------	-----	--	-----------------	---------	----------------------



			<b>VDO</b>		
Date	Engine Code	Chassis No.	Article No.	Product	Information

**FORD****FIESTA I (GFBT)****1.6 XR2 (62 kW | 1.6 Litre)**

08.81 - 08.83	L3E		X10-729-002-005	SWP-M-C	Plug Number (T2): 9
08.81 - 08.83	L3E		X10-729-002-008	SWP-M-C	Plug Number (T2): 12

**FIESTA II (FBD)****1.0 (33 kW | 1.0 Litre)**

09.83 - 11.89	TLB		X10-729-002-005	SWP-M-C	Plug Number (T2): 9
09.83 - 11.89	TLB		X10-729-002-008	SWP-M-C	Plug Number (T2): 12

**1.0 (FBD) (33 kW | 1.0 Litre)**

09.83 - 02.89	TKB		X10-729-002-005	SWP-M-C	Plug Number (T2): 9
09.83 - 02.89	TKB		X10-729-002-008	SWP-M-C	Plug Number (T2): 12

**1.1 (FBD) (36 kW | 1.1 Litre)**

05.86 - 02.89	GSH		X10-729-002-005	SWP-M-C	Plug Number (T2): 9
05.86 - 02.89	GSH		X10-729-002-008	SWP-M-C	Plug Number (T2): 12

**1.1 (FBD) (37 kW | 1.1 Litre)**

09.83 - 02.89	GLC, GSF		X10-729-002-005	SWP-M-C	Plug Number (T2): 9
09.83 - 02.89	GLC, GSF		X10-729-002-008	SWP-M-C	Plug Number (T2): 12

**1.3 (FBD) (51 kW | 1.3 Litre)**

09.83 - 01.87	JPC		X10-729-002-005	SWP-M-C	Plug Number (T2): 9
09.83 - 01.87	JPC		X10-729-002-008	SWP-M-C	Plug Number (T2): 12

**1.4 (51 kW | 1.4 Litre)**

09.83 - 01.87	FUBA		X10-729-002-005	SWP-M-C	Plug Number (T2): 9
09.83 - 01.87	FUBA		X10-729-002-008	SWP-M-C	Plug Number (T2): 12

**1.4 (FBD) (52 kW | 1.4 Litre)**

10.86 - 02.89	F6A, F6C		X10-729-002-005	SWP-M-C	Plug Number (T2): 9
10.86 - 02.89	F6A, F6C		X10-729-002-008	SWP-M-C	Plug Number (T2): 12

**1.4 (FBD) (54 kW | 1.4 Litre)**

02.87 - 02.89	FUD		X10-729-002-005	SWP-M-C	Plug Number (T2): 9
02.87 - 02.89	FUD		X10-729-002-008	SWP-M-C	Plug Number (T2): 12

**1.4 (FBD) (55 kW | 1.4 Litre)**

10.85 - 11.89	FUB		X10-729-002-005	SWP-M-C	Plug Number (T2): 9
10.85 - 11.89	FUB		X10-729-002-008	SWP-M-C	Plug Number (T2): 12

**1.6 D (FBD) (40 kW | 1.6 Litre)**

04.84 - 02.89	LTB		X10-729-002-005	SWP-M-C	Plug Number (T2): 9
04.84 - 02.89	LTB		X10-729-002-008	SWP-M-C	Plug Number (T2): 12

**1.6 XR2 (FBD) (70 kW | 1.6 Litre)**

03.84 - 02.89	LUD		X10-729-002-005	SWP-M-C	Plug Number (T2): 9
03.84 - 02.89	LUD		X10-729-002-008	SWP-M-C	Plug Number (T2): 12

**1.6 XR2 (FBD) (71 kW | 1.6 Litre)**

04.84 - 02.89	LUB		X10-729-002-005	SWP-M-C	Plug Number (T2): 9
04.84 - 02.89	LUB		X10-729-002-008	SWP-M-C	Plug Number (T2): 12

**FIESTA III (GFJ)****1.0 (33 kW | 1.0 Litre)**

03.89 - 12.95	TLB		X10-729-002-004	SWP-M-C	Plug Number (T2): 9; T24: C →; Vehicle Equipment (T31): with rear-window wiper (T34)
03.89 - 12.95	TLB		X10-729-002-005	SWP-M-C	Plug Number (T2): 9

**1.1 (37 kW | 1.1 Litre)**

03.89 - 12.95	G6A		X10-729-002-004	SWP-M-C	Plug Number (T2): 9; T24: C →; Vehicle Equipment (T31): with rear-window wiper (T34)
03.89 - 12.95	G6A		X10-729-002-005	SWP-M-C	Plug Number (T2): 9

**1.1 (40 kW | 1.1 Litre)**

03.89 - 12.95	GUD, GUE		X10-729-002-004	SWP-M-C	Plug Number (T2): 9; T24: C →; Vehicle Equipment (T31): with rear-window wiper (T34)
03.89 - 12.95	GUD, GUE		X10-729-002-005	SWP-M-C	Plug Number (T2): 9

**1.3 (44 kW | 1.3 Litre)**

03.89 - 12.92	JBC		X10-729-002-004	SWP-M-C	Plug Number (T2): 9; T24: C →; Vehicle Equipment (T31): with rear-window wiper (T34)
03.89 - 12.92	JBC		X10-729-002-005	SWP-M-C	Plug Number (T2): 9

**1.3 CAT (44 kW | 1.3 Litre)**

05.91 - 01.97	J6B		X10-729-002-004	SWP-M-C	Plug Number (T2): 9; T24: C →; Vehicle Equipment (T31): with rear-window wiper (T34)
05.91 - 01.97	J6B		X10-729-002-005	SWP-M-C	Plug Number (T2): 9



					
Date	Engine Code	Chassis No.	Article No.	Product	Information

**FORD****FIESTA III (GFJ)****1.4 (52 kW | 1.4 Litre)**

03.89 - 12.95	F6E		X10-729-002-004	SWP-M-C	Plug Number (T2): 9; T24: C →; Vehicle Equipment (T31): with rear-window wiper (T34)
---------------	-----	--	-----------------	---------	--------------------------------------------------------------------------------------

03.89 - 12.95	F6E		X10-729-002-005	SWP-M-C	Plug Number (T2): 9
---------------	-----	--	-----------------	---------	---------------------

**1.4 (54 kW | 1.4 Litre)**

03.89 - 12.95	FUG, FUJ		X10-729-002-004	SWP-M-C	Plug Number (T2): 9; T24: C →; Vehicle Equipment (T31): with rear-window wiper (T34)
---------------	----------	--	-----------------	---------	--------------------------------------------------------------------------------------

03.89 - 12.95	FUG, FUJ		X10-729-002-005	SWP-M-C	Plug Number (T2): 9
---------------	----------	--	-----------------	---------	---------------------

**1.4 CAT (54 kW | 1.4 Litre)**

03.89 - 12.95	F4A		X10-729-002-004	SWP-M-C	Plug Number (T2): 9; T24: C →; Vehicle Equipment (T31): with rear-window wiper (T34)
---------------	-----	--	-----------------	---------	--------------------------------------------------------------------------------------

03.89 - 12.95	F4A		X10-729-002-005	SWP-M-C	Plug Number (T2): 9
---------------	-----	--	-----------------	---------	---------------------

**1.6 (65 kW | 1.6 Litre)**

01.89 - 01.94	LUH		X10-729-002-004	SWP-M-C	Plug Number (T2): 9; T24: C →; Vehicle Equipment (T31): with rear-window wiper (T34)
---------------	-----	--	-----------------	---------	--------------------------------------------------------------------------------------

01.89 - 01.94	LUH		X10-729-002-005	SWP-M-C	Plug Number (T2): 9
---------------	-----	--	-----------------	---------	---------------------

**1.6 i 16V (65 kW | 1.6 Litre)**

01.94 - 12.95	L1G		X10-729-002-004	SWP-M-C	Plug Number (T2): 9; T24: C →; Vehicle Equipment (T31): with rear-window wiper (T34)
---------------	-----	--	-----------------	---------	--------------------------------------------------------------------------------------

01.94 - 12.95	L1G		X10-729-002-005	SWP-M-C	Plug Number (T2): 9
---------------	-----	--	-----------------	---------	---------------------

**1.6 Turbo (FBJT) (96 kW | 1.6 Litre)**

03.90 - 10.92	LHA		X10-729-002-004	SWP-M-C	Plug Number (T2): 9; T24: C →; Vehicle Equipment (T31): with rear-window wiper (T34)
---------------	-----	--	-----------------	---------	--------------------------------------------------------------------------------------

03.90 - 10.92	LHA		X10-729-002-005	SWP-M-C	Plug Number (T2): 9
---------------	-----	--	-----------------	---------	---------------------

**1.6 XR2i (76 kW | 1.6 Litre)**

03.89 - 03.93	LJD		X10-729-002-004	SWP-M-C	Plug Number (T2): 9; T24: C →; Vehicle Equipment (T31): with rear-window wiper (T34)
---------------	-----	--	-----------------	---------	--------------------------------------------------------------------------------------

03.89 - 03.93	LJD		X10-729-002-005	SWP-M-C	Plug Number (T2): 9
---------------	-----	--	-----------------	---------	---------------------

**1.6 XR2i (81 kW | 1.6 Litre)**

03.89 - 01.94	LJC		X10-729-002-004	SWP-M-C	Plug Number (T2): 9; T24: C →; Vehicle Equipment (T31): with rear-window wiper (T34)
---------------	-----	--	-----------------	---------	--------------------------------------------------------------------------------------

03.89 - 01.94	LJC		X10-729-002-005	SWP-M-C	Plug Number (T2): 9
---------------	-----	--	-----------------	---------	---------------------

**1.8 16V (77 kW | 1.8 Litre)**

02.92 - 12.95	RDB		X10-729-002-004	SWP-M-C	Plug Number (T2): 9; T24: C →; Vehicle Equipment (T31): with rear-window wiper (T34)
---------------	-----	--	-----------------	---------	--------------------------------------------------------------------------------------

02.92 - 12.95	RDB		X10-729-002-005	SWP-M-C	Plug Number (T2): 9
---------------	-----	--	-----------------	---------	---------------------

**1.8 D (44 kW | 1.8 Litre)**

03.89 - 12.95	RTD, RTG, RTC		X10-729-002-004	SWP-M-C	Plug Number (T2): 9; T24: C →; Vehicle Equipment (T31): with rear-window wiper (T34)
---------------	---------------	--	-----------------	---------	--------------------------------------------------------------------------------------

03.89 - 12.95	RTD, RTG, RTC		X10-729-002-005	SWP-M-C	Plug Number (T2): 9
---------------	---------------	--	-----------------	---------	---------------------

**1.8 TD (57 kW | 1.8 Litre)**

03.93 - 12.95	RFL		X10-729-002-004	SWP-M-C	Plug Number (T2): 9; T24: C →; Vehicle Equipment (T31): with rear-window wiper (T34)
---------------	-----	--	-----------------	---------	--------------------------------------------------------------------------------------

03.93 - 12.95	RFL		X10-729-002-005	SWP-M-C	Plug Number (T2): 9
---------------	-----	--	-----------------	---------	---------------------

**1.8 XR2i 16V (96 kW | 1.8 Litre)**

02.92 - 12.95	RQC		X10-729-002-004	SWP-M-C	Plug Number (T2): 9; T24: C →; Vehicle Equipment (T31): with rear-window wiper (T34)
---------------	-----	--	-----------------	---------	--------------------------------------------------------------------------------------

02.92 - 12.95	RQC		X10-729-002-005	SWP-M-C	Plug Number (T2): 9
---------------	-----	--	-----------------	---------	---------------------

**FIESTA IV (JA\_, JB\_)****1.0 i (38 kW | 1.0 Litre)**

02.97 - 09.99	ZH10JRB		X10-729-002-004	SWP-M-C	Plug Number (T2): 9; T24: Focus →
---------------	---------	--	-----------------	---------	-----------------------------------

09.99 - 01.02			X10-729-002-004	SWP-M-C	Plug Number (T2): 9; T24: Focus →
---------------	--	--	-----------------	---------	-----------------------------------

**1.25 i 16V (55 kW | 1.2 Litre)**

08.95 - 01.02	DHA, DHB, DHC, DHD, DHE, DHF, DHG		X10-729-002-004	SWP-M-C	Plug Number (T2): 9; T24: Focus →
---------------	-----------------------------------	--	-----------------	---------	-----------------------------------

08.95 - 01.02	JJA, JJC, JJE, JJJ, JJK, JJM		X10-729-002-004	SWP-M-C	Plug Number (T2): 9; T24: Focus →
---------------	------------------------------	--	-----------------	---------	-----------------------------------

08.95 - 01.02	J4C, J4J, J4L, J4Q, J4R, J4T		X10-729-002-004	SWP-M-C	Plug Number (T2): 9; T24: Focus →
---------------	------------------------------	--	-----------------	---------	-----------------------------------

04.96 - 01.02	FHA, FHE		X10-729-002-004	SWP-M-C	Plug Number (T2): 9; T24: Focus →
---------------	----------	--	-----------------	---------	-----------------------------------





			<b>VDO</b>		
Date	Engine Code	Chassis No.	Article No.	Product	Information

**FORD****FIESTA IV (JA\_, JB\_)****1.6 16V Sport (76 kW | 1.6 Litre)**

02.00 - 01.02 | L1T, L1V | X10-729-002-004 | SWP-M-C | Plug Number (T2): 9; T24: Focus →

**1.8 D (44 kW | 1.8 Litre)**

08.95 - 04.00 | RTK, RTJ | X10-729-002-004 | SWP-M-C | Plug Number (T2): 9; T24: Focus →

**1.8 DI (55 kW | 1.8 Litre)**

04.00 - 01.02 | RTN, RTP, RTQ | X10-729-002-004 | SWP-M-C | Plug Number (T2): 9; T24: Focus →

**FIESTA Box (F3L, F5L)****1.3 (44 kW | 1.3 Litre)**

09.91 - 02.96 | J6B | X10-729-002-005 | SWP-M-C | Plug Number (T2): 9

**1.8 D (44 kW | 1.8 Litre)**

09.91 - 02.96 | RTD, RTG, RTC | X10-729-002-005 | SWP-M-C | Plug Number (T2): 9

**FOCUS (DAW, DBW)****1.4 16V (55 kW | 1.4 Litre)**

10.98 - 11.04 | FXDA, FXDC, FXDB, FXDD | X10-729-002-004 | SWP-M-C | Plug Number (T2): 9

**1.6 16V (74 kW | 1.6 Litre)**

10.98 - 11.04 | FYDA, FYDC, FYDB, FYDD, FYDH | X10-729-002-004 | SWP-M-C | Plug Number (T2): 9

**1.8 16V (85 kW | 1.8 Litre)**

10.98 - 11.04 | EYDC, EYDB, EYDD, EYDE, EYDF, EYDG, EYDI, EYDJ, EYDL | X10-729-002-004 | SWP-M-C | Plug Number (T2): 9

**1.8 DI / TDDi (55 kW | 1.8 Litre)**

08.99 - 11.04 | BHDA, BHDB | X10-729-002-004 | SWP-M-C | Plug Number (T2): 9

**1.8 TDCi (74 kW | 1.8 Litre)**

08.02 - 11.04 | FFDA | X10-729-002-004 | SWP-M-C | Plug Number (T2): 9

**1.8 TDCi (85 kW | 1.8 Litre)**

03.01 - 11.04 | F9DA, F9DB | X10-729-002-004 | SWP-M-C | Plug Number (T2): 9

**1.8 Turbo DI / TDDi (66 kW | 1.8 Litre)**

10.98 - 11.04 | C9DC, C9DA, C9DB | X10-729-002-004 | SWP-M-C | Plug Number (T2): 9

**2.0 16V (96 kW | 2.0 Litre)**

10.98 - 11.04 | EDDC, EDDB, EDDD, EDDF | X10-729-002-004 | SWP-M-C | Plug Number (T2): 9

**RS (158 kW | 2.0 Litre)**

10.02 - 11.04 | HMDA | X10-729-002-004 | SWP-M-C | Plug Number (T2): 9

**ST170 (127 kW | 2.0 Litre)**

03.02 - 11.04 | ALDA | X10-729-002-004 | SWP-M-C | Plug Number (T2): 9

**FOCUS Saloon (DFW)****1.4 16V (55 kW | 1.4 Litre)**

02.99 - 11.04 | FXDA, FXDC, FXDB, FXDD | X10-729-002-004 | SWP-M-C | Plug Number (T2): 9; T24: Ambiente →

**1.6 16V (74 kW | 1.6 Litre)**

02.99 - 11.04 | FYDA, FYDC, FYDB, FYDD, FYDH | X10-729-002-004 | SWP-M-C | Plug Number (T2): 9; T24: Ambiente →

**1.8 16V (85 kW | 1.8 Litre)**

02.99 - 11.04 | EYDC, EYDB, EYDD, EYDE, EYDF, EYDG, EYDI, EYDJ, EYDL | X10-729-002-004 | SWP-M-C | Plug Number (T2): 9; T24: Ambiente →

**1.8 TDCi (74 kW | 1.8 Litre)**

08.02 - 11.04 | FFDA | X10-729-002-004 | SWP-M-C | Plug Number (T2): 9; T24: Ambiente →

**1.8 TDCi (85 kW | 1.8 Litre)**

03.01 - 11.04 | F9DA, F9DB | X10-729-002-004 | SWP-M-C | Plug Number (T2): 9; T24: Ambiente →

**1.8 Turbo DI / TDDi (66 kW | 1.8 Litre)**

02.99 - 11.04 | C9DC, C9DA, C9DB | X10-729-002-004 | SWP-M-C | Plug Number (T2): 9; T24: Ambiente →

**2.0 16V (96 kW | 2.0 Litre)**

02.99 - 11.04 | EDDC, EDDB, EDDD, EDDF | X10-729-002-004 | SWP-M-C | Plug Number (T2): 9; T24: Ambiente →

**FOCUS Estate (DNW)****1.4 16V (55 kW | 1.4 Litre)**

02.99 - 11.04 | FXDA, FXDC, FXDB, FXDD | X10-729-002-004 | SWP-M-C | Plug Number (T2): 9; T24: Ghia →

**1.6 16V (74 kW | 1.6 Litre)**

02.99 - 11.04 | FYDA, FYDC, FYDB, FYDD, FYDH | X10-729-002-004 | SWP-M-C | Plug Number (T2): 9; T24: Ghia →

**1.8 16V (85 kW | 1.8 Litre)**

02.99 - 11.04 | EYDC, EYDB, EYDD, EYDE, EYDF, EYDG, EYDI, EYDJ, EYDL | X10-729-002-004 | SWP-M-C | Plug Number (T2): 9; T24: Ghia →

**1.8 DI / TDDi (55 kW | 1.8 Litre)**

08.99 - 11.04 | BHDA, BHDB | X10-729-002-004 | SWP-M-C | Plug Number (T2): 9; T24: Ghia →



			<b>VDO</b>	
Date	Engine Code	Chassis No.	Article No.	Product

**FORD****FOCUS Estate (DNW)****1.8 TDCi (74 kW | 1.8 Litre)**

08.02 → 11.04 FFDA X10-729-002-004 SWP-M-C Plug Number (T2): 9; T24: Ghia →

**1.8 TDCi (85 kW | 1.8 Litre)**

03.01 → 11.04 F9DA, F9DB X10-729-002-004 SWP-M-C Plug Number (T2): 9; T24: Ghia →

**1.8 Turbo DI / TDDi (66 kW | 1.8 Litre)**

02.99 → 11.04 C9DC, C9DA, C9DB X10-729-002-004 SWP-M-C Plug Number (T2): 9; T24: Ghia →

**2.0 16V (96 kW | 2.0 Litre)**

02.99 → 11.04 EDDC, EDDB, EDDD, EDDF X10-729-002-004 SWP-M-C Plug Number (T2): 9; T24: Ghia →

**ST170 (127 kW | 2.0 Litre)**

08.02 → 11.04 ALDA X10-729-002-004 SWP-M-C Plug Number (T2): 9; T24: Ghia →

**GALAXY (WGR)****1.9 TDI (66 kW | 1.9 Litre)**

03.95 → 05.06 AHU, 1Z, ANU 246-083-002-014G SWP-D-C Plug Number (T2): 6

**1.9 TDI (81 kW | 1.9 Litre)**

08.97 → 04.00 AFN, AVG 246-083-002-014G SWP-D-C Plug Number (T2): 6

**1.9 TDI (85 kW | 1.9 Litre)**

04.00 → 05.06 AUJ 246-083-002-014G SWP-D-C Plug Number (T2): 6

**2.0 i (85 kW | 2.0 Litre)**

11.95 → 05.06 NSE, ZVSA 246-083-002-014G SWP-D-C Plug Number (T2): 6

**2.3 16V (107 kW | 2.3 Litre)**

01.97 → 05.06 Y5B, E5SA 246-083-002-014G SWP-D-C Plug Number (T2): 6

**2.8 i V6 (128 kW | 2.8 Litre)**

11.95 → 04.00 AAA, AMY 246-083-002-014G SWP-D-C Plug Number (T2): 6

**2.8 i V6 4x4 (128 kW | 2.8 Litre)**

04.96 → 04.00 AAA, AMY 246-083-002-014G SWP-D-C Plug Number (T2): 6

**2.8 V6 (150 kW | 2.8 Litre)**

04.00 → 05.06 AYL 246-083-002-014G SWP-D-C Plug Number (T2): 6

**KA (RB\_)****1.0 i (38 kW | 1.0 Litre)**

07.97 → 09.99 ZH10JRB X10-729-002-004 SWP-M-C Plug Number (T2): 9

**1.0 i (48 kW | 1.0 Litre)**

09.99 → 11.08 X10-729-002-004 SWP-M-C Plug Number (T2): 9

**1.3 i (36 kW | 1.3 Litre)**

06.98 → 11.08 JJD, JJF, JJG, JJH, JJJ X10-729-002-004 SWP-M-C Plug Number (T2): 9

**1.3 i (37 kW | 1.3 Litre)**

09.96 → 10.02 JJB X10-729-002-004 SWP-M-C Plug Number (T2): 9

**1.3 i (44 kW | 1.3 Litre)**

09.96 → 11.08 J4D, J4K, J4M, J4N, J4P, J4S, BAA X10-729-002-004 SWP-M-C Plug Number (T2): 9

**MONDEO I (GBP)****1.6 i 16V (65 kW | 1.6 Litre)**

07.94 → 08.96 L1J X10-729-002-004 SWP-M-C Plug Number (T2): 9; T24: CLX →

**1.6 i 16V (66 kW | 1.6 Litre)**

02.93 → 08.96 L1F X10-729-002-004 SWP-M-C Plug Number (T2): 9; T24: CLX →

**1.8 i 16V (82 kW | 1.8 Litre)**

07.94 → 08.96 RKB X10-729-002-004 SWP-M-C Plug Number (T2): 9; T24: CLX →

**1.8 i 16V (85 kW | 1.8 Litre)**

02.93 → 08.96 RKA X10-729-002-004 SWP-M-C Plug Number (T2): 9; T24: CLX →

**1.8 i 16V 4x4 (85 kW | 1.8 Litre)**

02.93 → 08.96 RKA X10-729-002-004 SWP-M-C Plug Number (T2): 9; T24: CLX →

**1.8 TD (65 kW | 1.8 Litre)**

06.93 → 08.96 RFM, RFN X10-729-002-004 SWP-M-C Plug Number (T2): 9; T24: CLX →

**1.8 TD (66 kW | 1.8 Litre)**

10.95 → 08.96 RFN, RFM X10-729-002-004 SWP-M-C Plug Number (T2): 9; T24: CLX →

**2.0 i 16V (100 kW | 2.0 Litre)**

02.93 → 08.96 NGA X10-729-002-004 SWP-M-C Plug Number (T2): 9; T24: CLX →

**2.0 i 16V (97 kW | 2.0 Litre)**

12.94 → 08.96 NGA X10-729-002-004 SWP-M-C Plug Number (T2): 9; T24: CLX →

**2.0 i 16V 4x4 (97 kW | 2.0 Litre)**

12.94 → 08.96 NGA X10-729-002-004 SWP-M-C Plug Number (T2): 9; T24: CLX →



Date	Engine Code	Chassis No.	Article No.	Product	Information

**FORD****MONDEO I (GBP)****2.5 i 24V (125 kW | 2.5 Litre)**

07.94 - 08.96	SEA		X10-729-002-004	SWP-M-C	Plug Number (T2): 9; T24: CLX →
---------------	-----	--	-----------------	---------	---------------------------------

**MONDEO I Estate (BNP)****1.6 i 16V (65 kW | 1.6 Litre)**

07.94 - 08.96	L1J		X10-729-002-004	SWP-M-C	Plug Number (T2): 9; T24: CLX →
---------------	-----	--	-----------------	---------	---------------------------------

**1.6 i 16V (66 kW | 1.6 Litre)**

04.93 - 08.96	L1F		X10-729-002-004	SWP-M-C	Plug Number (T2): 9; T24: CLX →
---------------	-----	--	-----------------	---------	---------------------------------

**1.8 i 16V (82 kW | 1.8 Litre)**

07.94 - 08.96	RKB		X10-729-002-004	SWP-M-C	Plug Number (T2): 9; T24: CLX →
---------------	-----	--	-----------------	---------	---------------------------------

**1.8 i 16V (85 kW | 1.8 Litre)**

04.93 - 08.96	RKA		X10-729-002-004	SWP-M-C	Plug Number (T2): 9; T24: CLX →
---------------	-----	--	-----------------	---------	---------------------------------

**1.8 i 16V 4x4 (85 kW | 1.8 Litre)**

04.93 - 08.96	RKA		X10-729-002-004	SWP-M-C	Plug Number (T2): 9; T24: CLX →
---------------	-----	--	-----------------	---------	---------------------------------

**1.8 TD (65 kW | 1.8 Litre)**

06.93 - 08.96	RFM, RFN		X10-729-002-004	SWP-M-C	Plug Number (T2): 9; T24: CLX →
---------------	----------	--	-----------------	---------	---------------------------------

**1.8 TD (66 kW | 1.8 Litre)**

11.95 - 08.96	RFN, RFM		X10-729-002-004	SWP-M-C	Plug Number (T2): 9; T24: CLX →
---------------	----------	--	-----------------	---------	---------------------------------

**2.0 i 16V (100 kW | 2.0 Litre)**

04.93 - 08.96	NGA		X10-729-002-004	SWP-M-C	Plug Number (T2): 9; T24: CLX →
---------------	-----	--	-----------------	---------	---------------------------------

**2.0 i 16V (97 kW | 2.0 Litre)**

01.93 - 08.96	NGA		X10-729-002-004	SWP-M-C	Plug Number (T2): 9; T24: CLX →
---------------	-----	--	-----------------	---------	---------------------------------

**2.0 i 16V 4x4 (100 kW | 2.0 Litre)**

04.93 - 08.96	NGA		X10-729-002-004	SWP-M-C	Plug Number (T2): 9; T24: CLX →
---------------	-----	--	-----------------	---------	---------------------------------

**2.0 i 16V 4x4 (97 kW | 2.0 Litre)**

12.94 - 08.96	NGA		X10-729-002-004	SWP-M-C	Plug Number (T2): 9; T24: CLX →
---------------	-----	--	-----------------	---------	---------------------------------

**2.5 i 24V (125 kW | 2.5 Litre)**

07.94 - 08.96	SEA		X10-729-002-004	SWP-M-C	Plug Number (T2): 9; T24: CLX →
---------------	-----	--	-----------------	---------	---------------------------------

**MONDEO II (BAP)****1.6 i (66 kW | 1.6 Litre)**

09.96 - 11.00	L1J		X10-729-002-004	SWP-M-C	Plug Number (T2): 9; T24: CLX →; Vehicle Equipment (T31): with rear-window wiper (T34)
---------------	-----	--	-----------------	---------	----------------------------------------------------------------------------------------

09.96 - 11.00	L1J		X10-729-002-005	SWP-M-C	Plug Number (T2): 9; T24: CLX →
---------------	-----	--	-----------------	---------	---------------------------------

**1.6 i 16V (70 kW | 1.6 Litre)**

05.98 - 11.00	L1L, L1N, L1Q		X10-729-002-004	SWP-M-C	Plug Number (T2): 9; T24: CLX →; Vehicle Equipment (T31): with rear-window wiper (T34)
---------------	---------------	--	-----------------	---------	----------------------------------------------------------------------------------------

05.98 - 11.00	L1L, L1N, L1Q		X10-729-002-005	SWP-M-C	Plug Number (T2): 9; T24: CLX →
---------------	---------------	--	-----------------	---------	---------------------------------

**1.8 i (85 kW | 1.8 Litre)**

09.96 - 11.00	RKB, RKF, RKJ, RKH, RKK		X10-729-002-004	SWP-M-C	Plug Number (T2): 9; T24: CLX →; Vehicle Equipment (T31): with rear-window wiper (T34)
---------------	-------------------------	--	-----------------	---------	----------------------------------------------------------------------------------------

09.96 - 11.00	RKB, RKF, RKJ, RKH, RKK		X10-729-002-005	SWP-M-C	Plug Number (T2): 9; T24: CLX →
---------------	-------------------------	--	-----------------	---------	---------------------------------

**1.8 TD (66 kW | 1.8 Litre)**

09.96 - 11.00	RFN		X10-729-002-004	SWP-M-C	Plug Number (T2): 9; T24: CLX →; Vehicle Equipment (T31): with rear-window wiper (T34)
---------------	-----	--	-----------------	---------	----------------------------------------------------------------------------------------

09.96 - 11.00	RFN		X10-729-002-005	SWP-M-C	Plug Number (T2): 9; T24: CLX →
---------------	-----	--	-----------------	---------	---------------------------------

**2.0 i (96 kW | 2.0 Litre)**

09.96 - 11.00	NGA, NGB, NGC, NGD		X10-729-002-004	SWP-M-C	Plug Number (T2): 9; T24: CLX →; Vehicle Equipment (T31): with rear-window wiper (T34)
---------------	--------------------	--	-----------------	---------	----------------------------------------------------------------------------------------

09.96 - 11.00	NGA, NGB, NGC, NGD		X10-729-002-005	SWP-M-C	Plug Number (T2): 9; T24: CLX →
---------------	--------------------	--	-----------------	---------	---------------------------------

**2.5 24V (125 kW | 2.5 Litre)**

06.00 - 11.00	SEB, SEC		X10-729-002-004	SWP-M-C	Plug Number (T2): 9; T24: CLX →; Vehicle Equipment (T31): with rear-window wiper (T34)
---------------	----------	--	-----------------	---------	----------------------------------------------------------------------------------------

09.96 - 11.00	SEA		X10-729-002-004	SWP-M-C	Plug Number (T2): 9; T24: CLX →; Vehicle Equipment (T31): with rear-window wiper (T34)
---------------	-----	--	-----------------	---------	----------------------------------------------------------------------------------------

06.00 - 11.00	SEB, SEC		X10-729-002-005	SWP-M-C	Plug Number (T2): 9; T24: CLX →
---------------	----------	--	-----------------	---------	---------------------------------

09.96 - 11.00	SEA		X10-729-002-005	SWP-M-C	Plug Number (T2): 9; T24: CLX →
---------------	-----	--	-----------------	---------	---------------------------------

**2.5 ST 200 (151 kW | 2.5 Litre)**

05.99 - 11.00	SGA		X10-729-002-004	SWP-M-C	Plug Number (T2): 9; T24: CLX →; Vehicle Equipment (T31): with rear-window wiper (T34)
---------------	-----	--	-----------------	---------	----------------------------------------------------------------------------------------

05.99 - 11.00	SGA		X10-729-002-005	SWP-M-C	Plug Number (T2): 9; T24: CLX →
---------------	-----	--	-----------------	---------	---------------------------------



			<b>VDO</b>		
Date	Engine Code	Chassis No.	Article No.	Product	Information

**FORD****MONDEO II Saloon (BFP)****1.6 i (66 kW | 1.6 Litre)**

09.96 - 11.00 L1J X10-729-002-005 SWP-M-C Plug Number (T2): 9

**1.6 i 16V (70 kW | 1.6 Litre)**

05.98 - 11.00 L1L, L1N, L1Q X10-729-002-005 SWP-M-C Plug Number (T2): 9

**1.8 i (85 kW | 1.8 Litre)**

09.96 - 11.00 RKB, RKF, RKH, RKJ, RKK X10-729-002-005 SWP-M-C Plug Number (T2): 9

**1.8 TD (66 kW | 1.8 Litre)**

09.96 - 11.00 RFN X10-729-002-005 SWP-M-C Plug Number (T2): 9

**2.0 i (96 kW | 2.0 Litre)**

09.96 - 11.00 NGA, NGB, NGC, NGD X10-729-002-005 SWP-M-C Plug Number (T2): 9

**2.5 24V (125 kW | 2.5 Litre)**

06.00 - 11.00 SEB, SEC X10-729-002-005 SWP-M-C Plug Number (T2): 9

09.96 - 11.00 SEA X10-729-002-005 SWP-M-C Plug Number (T2): 9

**2.5 ST 200 (151 kW | 2.5 Litre)**

05.99 - 11.00 SGA X10-729-002-005 SWP-M-C Plug Number (T2): 9

**MONDEO II Estate (BNP)****1.6 i (66 kW | 1.6 Litre)**

09.96 - 11.00 L1J X10-729-002-004 SWP-M-C Plug Number (T2): 9; T24: CLX ↔; Vehicle Equipment (T31): with headlamp cleaning system (T35)

09.96 - 11.00 L1J X10-729-002-005 SWP-M-C Plug Number (T2): 9; T24: CLX ↔

**1.6 i 16V (70 kW | 1.6 Litre)**

05.98 - 11.00 L1L, L1N, L1Q X10-729-002-004 SWP-M-C Plug Number (T2): 9; T24: CLX ↔; Vehicle Equipment (T31): with headlamp cleaning system (T35)

05.98 - 11.00 L1L, L1N, L1Q X10-729-002-005 SWP-M-C Plug Number (T2): 9; T24: CLX ↔

**1.8 i (85 kW | 1.8 Litre)**

09.96 - 11.00 RKB, RKF, RKH, RKJ, RKK X10-729-002-004 SWP-M-C Plug Number (T2): 9; T24: CLX ↔; Vehicle Equipment (T31): with headlamp cleaning system (T35)

09.96 - 11.00 RKB, RKF, RKH, RKJ, RKK X10-729-002-005 SWP-M-C Plug Number (T2): 9; T24: CLX ↔

**1.8 TD (66 kW | 1.8 Litre)**

09.96 - 11.00 RFN X10-729-002-004 SWP-M-C Plug Number (T2): 9; T24: CLX ↔; Vehicle Equipment (T31): with headlamp cleaning system (T35)

09.96 - 11.00 RFN X10-729-002-005 SWP-M-C Plug Number (T2): 9; T24: CLX ↔

**2.0 i (96 kW | 2.0 Litre)**

09.96 - 11.00 NGA, NGB, NGC, NGD X10-729-002-004 SWP-M-C Plug Number (T2): 9; T24: CLX ↔; Vehicle Equipment (T31): with headlamp cleaning system (T35)

09.96 - 11.00 NGA, NGB, NGC, NGD X10-729-002-005 SWP-M-C Plug Number (T2): 9; T24: CLX ↔

**2.5 24V (125 kW | 2.5 Litre)**

10.99 - 11.00 SEB, SEC X10-729-002-004 SWP-M-C Plug Number (T2): 9; T24: CLX ↔; Vehicle Equipment (T31): with headlamp cleaning system (T35)

09.96 - 11.00 SEA X10-729-002-004 SWP-M-C Plug Number (T2): 9; T24: CLX ↔; Vehicle Equipment (T31): with headlamp cleaning system (T35)

10.99 - 11.00 SEB, SEC X10-729-002-005 SWP-M-C Plug Number (T2): 9; T24: CLX ↔

09.96 - 11.00 SEA X10-729-002-005 SWP-M-C Plug Number (T2): 9; T24: CLX ↔

**2.5 ST 200 (151 kW | 2.5 Litre)**

05.99 - 11.00 SGA X10-729-002-004 SWP-M-C Plug Number (T2): 9; T24: CLX ↔; Vehicle Equipment (T31): with headlamp cleaning system (T35)

05.99 - 11.00 SGA X10-729-002-005 SWP-M-C Plug Number (T2): 9; T24: CLX ↔

**MONDEO III Saloon (B4Y)****2.2 TDCi (110 kW | 2.2 Litre)**

09.04 - 08.07 QJBC, QJBD 246-082-008-025G SWP-M-C



			<b>VDO</b>		
Date	Engine Code	Chassis No.	Article No.	Product	Information

**FORD****ORION II (AFF)****1.3 (44 kW | 1.3 Litre)**

09.88 - 07.90 JBB, JLA, JLB

X10-729-002-005

SWP-M-C

Plug Number (T2): 9

**1.4 (52 kW | 1.4 Litre)**

09.88 - 07.90 FUAA

X10-729-002-005

SWP-M-C

Plug Number (T2): 9

**1.4 (54 kW | 1.4 Litre)**

09.88 - 07.90 FUC

X10-729-002-005

SWP-M-C

Plug Number (T2): 9

**1.4 (55 kW | 1.4 Litre)**

09.88 - 07.90 FUA

X10-729-002-005

SWP-M-C

Plug Number (T2): 9

**1.4 CAT (54 kW | 1.4 Litre)**

09.88 - 07.90 F6B, F6D

X10-729-002-005

SWP-M-C

Plug Number (T2): 9

**1.6 (66 kW | 1.6 Litre)**

09.88 - 07.90 LUC

X10-729-002-005

SWP-M-C

Plug Number (T2): 9

**1.6 D (40 kW | 1.6 Litre)**

09.88 - 01.89 LTC

X10-729-002-005

SWP-M-C

Plug Number (T2): 9

**1.6 i (75 kW | 1.6 Litre)**

08.89 - 07.90 LJB

X10-729-002-005

SWP-M-C

Plug Number (T2): 9

**1.6 i (77 kW | 1.6 Litre)**

09.88 - 07.90 LRB

X10-729-002-005

SWP-M-C

Plug Number (T2): 9

**1.6 i CAT (66 kW | 1.6 Litre)**

09.88 - 07.90 L4B

X10-729-002-005

SWP-M-C

Plug Number (T2): 9

**1.8 D (44 kW | 1.8 Litre)**

01.89 - 07.90 RTA, RTB

X10-729-002-005

SWP-M-C

Plug Number (T2): 9

**ORION III (GAL)****1.3 (44 kW | 1.3 Litre)**

07.90 - 12.93 J6A, J4B

X10-729-002-005

SWP-M-C

Plug Number (T2): 9

**1.4 (52 kW | 1.4 Litre)**

07.90 - 12.93 F6F, F6G

X10-729-002-005

SWP-M-C

Plug Number (T2): 9

**1.4 (54 kW | 1.4 Litre)**

07.90 - 12.93 FUH

X10-729-002-005

SWP-M-C

Plug Number (T2): 9

**1.6 (66 kW | 1.6 Litre)**

07.90 - 12.92 LUJ, LUK

X10-729-002-005

SWP-M-C

Plug Number (T2): 9

**1.6 i (77 kW | 1.6 Litre)**

07.90 - 09.92 LJF

X10-729-002-005

SWP-M-C

Plug Number (T2): 9

**1.6 i 16V (66 kW | 1.6 Litre)**

07.92 - 12.93 L1E, L1K

X10-729-002-005

SWP-M-C

Plug Number (T2): 9

**1.8 D (44 kW | 1.8 Litre)**

11.90 - 12.93 RTE, RTF, RTH

X10-729-002-005

SWP-M-C

Plug Number (T2): 9

**1.8 i 16V (77 kW | 1.8 Litre)**

02.92 - 12.93 RDA

X10-729-002-005

SWP-M-C

Plug Number (T2): 9

**1.8 i 16V (96 kW | 1.8 Litre)**

01.92 - 12.93 RQB

X10-729-002-005

SWP-M-C

Plug Number (T2): 9

**1.8 TD (66 kW | 1.8 Litre)**

03.92 - 12.93 RFD, RFK

X10-729-002-005

SWP-M-C

Plug Number (T2): 9

**PUMA (EC\_)****1.4 16V (66 kW | 1.4 Litre)**

11.97 - 10.00 FHD, FHF

X10-729-002-004

SWP-M-C

Plug Number (T2): 9

**1.6 16V (76 kW | 1.6 Litre)**

08.00 - L1W

X10-729-002-004

SWP-M-C

Plug Number (T2): 9

**1.7 16V (92 kW | 1.7 Litre)**

03.97 - MHA, MHB

X10-729-002-004

SWP-M-C

Plug Number (T2): 9

**ST 160 (118 kW | 1.7 Litre)**

06.99 -

X10-729-002-004

SWP-M-C

Plug Number (T2): 9

**SCORPIO I (GAE, GGE)****1.8 (66 kW | 1.8 Litre)**

04.85 - 02.92 REC

X10-729-002-008

SWP-M-C

Plug Number (T2): 12

**2.0 (77 kW | 2.0 Litre)**

04.85 - 08.89 N8D, NEL

X10-729-002-008

SWP-M-C

Plug Number (T2): 12

**2.0 (80 kW | 2.0 Litre)**

01.92 - 10.92 N8A

X10-729-002-005

SWP-M-C

Plug Number (T2): 9



			<b>VDO</b>		
Date	Engine Code	Chassis No.	Article No.	Product	Information

**FORD****SCORPIO I (GAE, GGE)**

<b>2.0 i (74 kW   2.0 Litre)</b>					
10.85 - 12.90	NRC		X10-729-002-008	SWP-M-C	Plug Number (T2): 12
<b>2.0 i (85 kW   2.0 Litre)</b>					
04.85 - 02.92	NRA, NRI		X10-729-002-008	SWP-M-C	Plug Number (T2): 12
02.92 - 09.94	NRA, NRI		X10-729-002-008	SWP-M-C	Plug Number (T2): 12
<b>2.0 i (88 kW   2.0 Litre)</b>					
05.89 - 09.94	N9D		X10-729-002-008	SWP-M-C	Plug Number (T2): 12
<b>2.4 i (92 kW   2.4 Litre)</b>					
10.88 - 02.92	ARD		X10-729-002-008	SWP-M-C	Plug Number (T2): 12
<b>2.4 i (96 kW   2.4 Litre)</b>					
09.86 - 09.88	ARC		X10-729-002-008	SWP-M-C	Plug Number (T2): 12
<b>2.4 i CAT (92 kW   2.4 Litre)</b>					
10.88 - 09.94	ARD		X10-729-002-008	SWP-M-C	Plug Number (T2): 12
<b>2.5 D (51 kW   2.5 Litre)</b>					
12.85 - 02.92	STR		X10-729-002-008	SWP-M-C	Plug Number (T2): 12
<b>2.5 TD (68 kW   2.5 Litre)</b>					
06.88 - 07.93	SFA, SFB		X10-729-002-008	SWP-M-C	Plug Number (T2): 12
<b>2.5 TD (85 kW   2.5 Litre)</b>					
08.93 - 09.94	SCB		X10-729-002-008	SWP-M-C	Plug Number (T2): 12
<b>2.8 i (110 kW   2.8 Litre)</b>					
04.85 - 11.86	PRE		X10-729-002-008	SWP-M-C	Plug Number (T2): 12
<b>2.8 i 4x4 (110 kW   2.8 Litre)</b>					
10.85 - 11.86	PRE		X10-729-002-008	SWP-M-C	Plug Number (T2): 12
<b>2.9 i (107 kW   2.9 Litre)</b>					
09.86 - 09.94	BRE, BRF, BRD		X10-729-002-008	SWP-M-C	Plug Number (T2): 12
<b>2.9 i (110 kW   2.9 Litre)</b>					
09.86 - 09.94	BRC		X10-729-002-008	SWP-M-C	Plug Number (T2): 12
<b>2.9 i 24V (143 kW   2.9 Litre)</b>					
04.91 - 09.94	BOA		X10-729-002-008	SWP-M-C	Plug Number (T2): 12
<b>2.9 i 4x4 (107 kW   2.9 Litre)</b>					
05.88 - 02.93	BRF, BRE, BRD		X10-729-002-008	SWP-M-C	Plug Number (T2): 12
<b>2.9 i 4x4 (110 kW   2.9 Litre)</b>					
09.86 - 09.94	BRC		X10-729-002-008	SWP-M-C	Plug Number (T2): 12
<b>2.9 i CAT (107 kW   2.9 Litre)</b>					
10.87 - 09.94	BRE		X10-729-002-008	SWP-M-C	Plug Number (T2): 12

**SCORPIO I Saloon (GGE)**

<b>2.0 i (85 kW   2.0 Litre)</b>					
02.92 - 09.94	N9F		X10-729-002-005	SWP-M-C	Plug Number (T2): 9
<b>2.0 i (88 kW   2.0 Litre)</b>					
01.92 - 09.94	N9D		X10-729-002-005	SWP-M-C	Plug Number (T2): 9
<b>2.0 i (92 kW   2.0 Litre)</b>					
01.92 - 02.92	N9B		X10-729-002-005	SWP-M-C	Plug Number (T2): 9
<b>2.4 i (92 kW   2.4 Litre)</b>					
01.92 - 10.94	ARD		X10-729-002-005	SWP-M-C	Plug Number (T2): 9
<b>2.5 D (51 kW   2.5 Litre)</b>					
01.92 - 12.94	STR		X10-729-002-005	SWP-M-C	Plug Number (T2): 9
<b>2.5 TD (68 kW   2.5 Litre)</b>					
01.92 - 07.93	SFA, SFB		X10-729-002-005	SWP-M-C	Plug Number (T2): 9
<b>2.5 TD (85 kW   2.5 Litre)</b>					
08.93 - 09.94	SCB		X10-729-002-005	SWP-M-C	Plug Number (T2): 9
<b>2.9 i (107 kW   2.9 Litre)</b>					
01.92 - 12.94	BRE, BRF, BRD		X10-729-002-005	SWP-M-C	Plug Number (T2): 9
<b>2.9 i 24V (143 kW   2.9 Litre)</b>					
01.92 - 09.94	BOA		X10-729-002-005	SWP-M-C	Plug Number (T2): 9
<b>2.9 i 4x4 (107 kW   2.9 Litre)</b>					
01.92 - 10.94	BRE, BRF, BRD		X10-729-002-005	SWP-M-C	Plug Number (T2): 9

**SCORPIO I Estate (GGE)**

<b>2.0 i (85 kW   2.0 Litre)</b>					
02.92 - 04.94	N9F		X10-729-002-004	SWP-M-C	Plug Number (T2): 9; T24: CLX →
<b>2.0 i (88 kW   2.0 Litre)</b>					
02.92 - 04.94	N9D		X10-729-002-004	SWP-M-C	Plug Number (T2): 9; T24: CLX →



			<b>VDO</b>		
Date	Engine Code	Chassis No.	Article No.	Product	Information

**FORD****SCORPIO I Estate (GGE)**

<b>2.4 i (92 kW   2.4 Litre)</b>					
02.92 - 04.94	ARD		X10-729-002-004	SWP-M-C	Plug Number (T2): 9; T24: CLX →
<b>2.5 TD (68 kW   2.5 Litre)</b>					
02.92 - 07.93	SFA, SFB		X10-729-002-004	SWP-M-C	Plug Number (T2): 9; T24: CLX →
<b>2.5 TD (85 kW   2.5 Litre)</b>					
08.93 - 04.94	SCB		X10-729-002-004	SWP-M-C	Plug Number (T2): 9; T24: CLX →
<b>2.9 24V (143 kW   2.9 Litre)</b>					
08.93 - 04.94	BOA		X10-729-002-004	SWP-M-C	Plug Number (T2): 9; T24: CLX →
<b>2.9 i (107 kW   2.9 Litre)</b>					
02.92 - 04.94	BRE, BRF, BRD		X10-729-002-004	SWP-M-C	Plug Number (T2): 9; T24: CLX →
<b>2.9 i 4x4 (107 kW   2.9 Litre)</b>					
02.92 - 02.93	BRF, BRE, BRD		X10-729-002-004	SWP-M-C	Plug Number (T2): 9; T24: CLX →

**SCORPIO II (GFR, GGR)**

<b>2.0 i (85 kW   2.0 Litre)</b>					
10.94 - 08.98	NSD		X10-729-002-005	SWP-M-C	Plug Number (T2): 9
<b>2.0 i 16V (100 kW   2.0 Litre)</b>					
10.94 - 08.98	N3A		X10-729-002-005	SWP-M-C	Plug Number (T2): 9
<b>2.3 i 16V (108 kW   2.3 Litre)</b>					
06.96 - 08.98	Y5A		X10-729-002-005	SWP-M-C	Plug Number (T2): 9
<b>2.5 TD (85 kW   2.5 Litre)</b>					
10.94 - 08.98	SCC		X10-729-002-005	SWP-M-C	Plug Number (T2): 9
<b>2.5 TD (92 kW   2.5 Litre)</b>					
09.96 - 08.98	VM		X10-729-002-005	SWP-M-C	Plug Number (T2): 9
<b>2.9 i (110 kW   2.9 Litre)</b>					
02.95 - 08.98	BRG		X10-729-002-005	SWP-M-C	Plug Number (T2): 9
<b>2.9 i 24V (152 kW   2.9 Litre)</b>					
10.94 - 08.98	BOB		X10-729-002-005	SWP-M-C	Plug Number (T2): 9

**SCORPIO II Estate (GNR, GGR)**

<b>2.0 i (85 kW   2.0 Litre)</b>					
10.94 - 08.98	NSD		X10-729-002-005	SWP-M-C	Plug Number (T2): 9
<b>2.0 i 16V (100 kW   2.0 Litre)</b>					
10.94 - 08.98	N3A		X10-729-002-005	SWP-M-C	Plug Number (T2): 9
<b>2.3 i 16V (108 kW   2.3 Litre)</b>					
06.96 - 08.98	Y5A		X10-729-002-005	SWP-M-C	Plug Number (T2): 9
<b>2.5 TD (85 kW   2.5 Litre)</b>					
10.94 - 08.98	SCC		X10-729-002-005	SWP-M-C	Plug Number (T2): 9
<b>2.5 TD (92 kW   2.5 Litre)</b>					
09.96 - 08.98	VM		X10-729-002-005	SWP-M-C	Plug Number (T2): 9
<b>2.9 i (110 kW   2.9 Litre)</b>					
02.95 - 08.98	BRG		X10-729-002-005	SWP-M-C	Plug Number (T2): 9
<b>2.9 i 24V (152 kW   2.9 Litre)</b>					
10.94 - 08.98	BOB		X10-729-002-005	SWP-M-C	Plug Number (T2): 9

**SIERRA Hatchback (GBC)**

<b>1.3 (44 kW   1.3 Litre)</b>					
08.82 - 12.86	JCT		X10-729-002-008	SWP-M-C	Plug Number (T2): 12
<b>1.6 (55 kW   1.6 Litre)</b>					
08.82 - 12.86	LCS, LCT, LSD		X10-729-002-008	SWP-M-C	Plug Number (T2): 12
<b>1.6 (58 kW   1.6 Litre)</b>					
08.84 - 12.86	LSD		X10-729-002-008	SWP-M-C	Plug Number (T2): 12
<b>1.8 (66 kW   1.8 Litre)</b>					
10.84 - 12.86	REB		X10-729-002-008	SWP-M-C	Plug Number (T2): 12
<b>2.0 (66 kW   2.0 Litre)</b>					
08.82 - 10.84	NYT		X10-729-002-008	SWP-M-C	Plug Number (T2): 12
<b>2.0 (74 kW   2.0 Litre)</b>					
10.85 - 12.86	NRD		X10-729-002-008	SWP-M-C	Plug Number (T2): 12
<b>2.0 (77 kW   2.0 Litre)</b>					
08.82 - 12.86	NET		X10-729-002-008	SWP-M-C	Plug Number (T2): 12
<b>2.0 i (85 kW   2.0 Litre)</b>					
03.85 - 12.86	NR2, NRB		X10-729-002-008	SWP-M-C	Plug Number (T2): 12



			<b>VDO</b>		
Date	Engine Code	Chassis No.	Article No.	Product	Information

**FORD****SIERRA Hatchback (GBC)****2.3 (84 kW | 2.3 Litre)**

08.82 - 12.86 | YTT | | | X10-729-002-008 | SWP-M-C | Plug Number (T2): 12

**2.3 D (49 kW | 2.3 Litre)**

08.82 - 12.86 | YTT | | | X10-729-002-008 | SWP-M-C | Plug Number (T2): 12

**2.8 i XR 4x4 (107 kW | 2.8 Litre)**

09.83 - 12.86 | PR5, PR6 | | | X10-729-002-008 | SWP-M-C | Plug Number (T2): 12

**2.8 XR 4x4 (110 kW | 2.8 Litre)**

02.85 - 12.86 | PRT | | | X10-729-002-008 | SWP-M-C | Plug Number (T2): 12

**2.8 XR4i (105 kW | 2.8 Litre)**

08.82 - 12.86 | PR6 | | | X10-729-002-008 | SWP-M-C | Plug Number (T2): 12

**2.8 XR4i (107 kW | 2.8 Litre)**

08.82 - 12.86 | PR5 | | | X10-729-002-008 | SWP-M-C | Plug Number (T2): 12

**2.8 XR4i (110 kW | 2.8 Litre)**

08.82 - 12.86 | PRT | | | X10-729-002-008 | SWP-M-C | Plug Number (T2): 12

**SIERRA Hatchback (GBC, GBG)****1.6 (53 kW | 1.6 Litre)**

01.88 - 02.93 | LSF | | | X10-729-002-008 | SWP-M-C | Plug Number (T2): 12; Vehicle Equipment (T31): with rear-window wiper (T34)

**1.6 (55 kW | 1.6 Litre)**

01.87 - 02.93 | LSE | | | X10-729-002-008 | SWP-M-C | Plug Number (T2): 12; Vehicle Equipment (T31): with rear-window wiper (T34)

**1.6 i (59 kW | 1.6 Litre)**

10.89 - 02.93 | L6B | | | X10-729-002-008 | SWP-M-C | Plug Number (T2): 12; Vehicle Equipment (T31): with rear-window wiper (T34)

**1.8 (59 kW | 1.8 Litre)**

10.87 - 05.88 | RED, REF | | | X10-729-002-008 | SWP-M-C | Plug Number (T2): 12; Vehicle Equipment (T31): with rear-window wiper (T34)

**1.8 (64 kW | 1.8 Litre)**

05.88 - 02.93 | R2C, R6A | | | X10-729-002-008 | SWP-M-C | Plug Number (T2): 12; Vehicle Equipment (T31): with rear-window wiper (T34)

**1.8 (66 kW | 1.8 Litre)**

01.87 - 05.88 | RED, R2A | | | X10-729-002-008 | SWP-M-C | Plug Number (T2): 12; Vehicle Equipment (T31): with rear-window wiper (T34)

**1.8 TD (55 kW | 1.8 Litre)**

08.88 - 02.93 | RFA, RFB, RFL | | | X10-729-002-008 | SWP-M-C | Plug Number (T2): 12; Vehicle Equipment (T31): with rear-window wiper (T34)

**2.0 (77 kW | 2.0 Litre)**

01.87 - 02.93 | N8C, NES | | | X10-729-002-008 | SWP-M-C | Plug Number (T2): 12; Vehicle Equipment (T31): with rear-window wiper (T34)

**2.0 16V Cosworth 4x4 (162 kW | 2.0 Litre)**

01.90 - 02.93 | N5D | | | X10-729-002-008 | SWP-M-C | Plug Number (T2): 12; Vehicle Equipment (T31): with rear-window wiper (T34)

**2.0 16V Cosworth 4x4 CAT (162 kW | 2.0 Litre)**

01.90 - 02.93 | N5C | | | X10-729-002-008 | SWP-M-C | Plug Number (T2): 12; Vehicle Equipment (T31): with rear-window wiper (T34)

**2.0 i (74 kW | 2.0 Litre)**

01.87 - 02.93 | NEJ, NE5 | | | X10-729-002-008 | SWP-M-C | Plug Number (T2): 12; Vehicle Equipment (T31): with rear-window wiper (T34)

**2.0 i (80 kW | 2.0 Litre)**

06.89 - 02.93 | N8A | | | X10-729-002-008 | SWP-M-C | Plug Number (T2): 12; Vehicle Equipment (T31): with rear-window wiper (T34)

**2.0 i (85 kW | 2.0 Litre)**

01.87 - 02.93 | N4A, N4I | | | X10-729-002-008 | SWP-M-C | Plug Number (T2): 12; Vehicle Equipment (T31): with rear-window wiper (T34)

**2.0 i (88 kW | 2.0 Litre)**

06.89 - 02.93 | N9C | | | X10-729-002-008 | SWP-M-C | Plug Number (T2): 12; Vehicle Equipment (T31): with rear-window wiper (T34)

**2.0 i (92 kW | 2.0 Litre)**

06.89 - 02.93 | N9B | | | X10-729-002-008 | SWP-M-C | Plug Number (T2): 12; Vehicle Equipment (T31): with rear-window wiper (T34)





			<b>VDO</b>		
Date	Engine Code	Chassis No.	Article No.	Product	Information

**FORD****SIERRA Hatchback (GBC, GBG)**

<b>2.0 i CAT (74 kW   2.0 Litre)</b>					
01.87 - 02.93	N4B		X10-729-002-008	SWP-M-C	Plug Number (T2): 12; Vehicle Equipment (T31): with rear-window wiper (T34)
<b>2.0 RS Cosworth (150 kW   2.0 Litre)</b>					
11.87 - 01.90	N5B		X10-729-002-008	SWP-M-C	Plug Number (T2): 12; Vehicle Equipment (T31): with rear-window wiper (T34)
<b>2.3 D (49 kW   2.3 Litre)</b>					
01.87 - 09.89	YTR		X10-729-002-008	SWP-M-C	Plug Number (T2): 12; Vehicle Equipment (T31): with rear-window wiper (T34)
<b>2.8 i (105 kW   2.8 Litre)</b>					
01.87 - 02.93	PR8		X10-729-002-008	SWP-M-C	Plug Number (T2): 12; Vehicle Equipment (T31): with rear-window wiper (T34)
<b>2.8 i XR 4x4 (107 kW   2.8 Litre)</b>					
01.87 - 02.93	PR7		X10-729-002-008	SWP-M-C	Plug Number (T2): 12; Vehicle Equipment (T31): with rear-window wiper (T34)
<b>2.8 i XR 4x4 (110 kW   2.8 Litre)</b>					
01.87 - 08.88	PRG		X10-729-002-008	SWP-M-C	Plug Number (T2): 12; Vehicle Equipment (T31): with rear-window wiper (T34)
<b>2.9 i (107 kW   2.9 Litre)</b>					
08.88 - 02.93	B4B, B4C		X10-729-002-008	SWP-M-C	Plug Number (T2): 12; Vehicle Equipment (T31): with rear-window wiper (T34)
<b>2.9 i XR 4x4 (107 kW   2.9 Litre)</b>					
08.88 - 02.93	B4B, B4C		X10-729-002-008	SWP-M-C	Plug Number (T2): 12; Vehicle Equipment (T31): with rear-window wiper (T34)
<b>2.9 i XR 4x4 (110 kW   2.9 Litre)</b>					
08.88 - 02.93	B4A		X10-729-002-008	SWP-M-C	Plug Number (T2): 12; Vehicle Equipment (T31): with rear-window wiper (T34)

**SIERRA (GBG, GB4)**

<b>1.6 (53 kW   1.6 Litre)</b>					
01.88 - 02.93	LSF	...HD; ...HE; ...HL	X10-729-002-005	SWP-M-C	Plug Number (T2): 9
<b>1.6 (55 kW   1.6 Litre)</b>					
03.87 - 02.93	LSE	...HD; ...HE; ...HL	X10-729-002-005	SWP-M-C	Plug Number (T2): 9
<b>1.6 i (59 kW   1.6 Litre)</b>					
10.89 - 02.93	L6B	...HD; ...HE; ...HL	X10-729-002-005	SWP-M-C	Plug Number (T2): 9
<b>1.8 (59 kW   1.8 Litre)</b>					
10.87 - 09.89	RED, REF	...HD; ...HE; ...HL	X10-729-002-005	SWP-M-C	Plug Number (T2): 9
<b>1.8 (64 kW   1.8 Litre)</b>					
05.88 - 02.93	R2C, R6A	...HD; ...HE; ...HL	X10-729-002-005	SWP-M-C	Plug Number (T2): 9
<b>1.8 (66 kW   1.8 Litre)</b>					
03.87 - 05.88	RED, R2A	...HD; ...HE; ...HL	X10-729-002-005	SWP-M-C	Plug Number (T2): 9
<b>1.8 TD (55 kW   1.8 Litre)</b>					
08.88 - 02.93	RFA, RFB, RFL	...HD; ...HE; ...HL	X10-729-002-005	SWP-M-C	Plug Number (T2): 9
<b>2.0 (77 kW   2.0 Litre)</b>					
03.87 - 02.93	N8C, NES	...HD; ...HE; ...HL	X10-729-002-005	SWP-M-C	Plug Number (T2): 9
<b>2.0 4x4 (88 kW   2.0 Litre)</b>					
01.90 - 02.93	N9C	...HD; ...HE; ...HL	X10-729-002-005	SWP-M-C	Plug Number (T2): 9
<b>2.0 4x4 (92 kW   2.0 Litre)</b>					
01.90 - 02.93	N9C	...HD; ...HE; ...HL	X10-729-002-005	SWP-M-C	Plug Number (T2): 9
<b>2.0 i (74 kW   2.0 Litre)</b>					
03.87 - 12.89	NE5, NEJ	...HD; ...HE; ...HL	X10-729-002-005	SWP-M-C	Plug Number (T2): 9
<b>2.0 i (85 kW   2.0 Litre)</b>					
03.87 - 02.93	N4A, N4I	...HD; ...HE; ...HL	X10-729-002-005	SWP-M-C	Plug Number (T2): 9
<b>2.0 i (88 kW   2.0 Litre)</b>					
01.90 - 02.93	N9C	...HD; ...HE; ...HL	X10-729-002-005	SWP-M-C	Plug Number (T2): 9
<b>2.0 i (92 kW   2.0 Litre)</b>					
01.90 - 02.93	N9C	...HD; ...HE; ...HL	X10-729-002-005	SWP-M-C	Plug Number (T2): 9
<b>2.0 i CAT (74 kW   2.0 Litre)</b>					
03.87 - 02.93	N4B	...HD; ...HE; ...HL	X10-729-002-005	SWP-M-C	Plug Number (T2): 9
<b>2.3 D (49 kW   2.3 Litre)</b>					
03.87 - 09.89	YTR, YTT	...HD; ...HE; ...HL	X10-729-002-005	SWP-M-C	Plug Number (T2): 9
<b>2.8 i (105 kW   2.8 Litre)</b>					
08.87 - 02.93	PR8	...HD; ...HE; ...HL	X10-729-002-005	SWP-M-C	Plug Number (T2): 9



			<b>VDO</b>		
Date	Engine Code	Chassis No.	Article No.	Product	Information

**FORD****SIERRA (GBG, GB4)****2.9 4x4 (107 kW | 2.9 Litre)**

08.88 - 02.93 | B4B, B4C | ...HD; ...HE; ...HL | X10-729-002-005 | SWP-M-C | Plug Number (T2): 9

**2.9 4x4 (110 kW | 2.9 Litre)**

08.88 - 02.93 | B4B, B4C | ...HD; ...HE; ...HL | X10-729-002-005 | SWP-M-C | Plug Number (T2): 9

**2.9 i (107 kW | 2.9 Litre)**

08.88 - 02.93 | B4B, B4C | ...HD; ...HE; ...HL | X10-729-002-005 | SWP-M-C | Plug Number (T2): 9

**2.9 i (110 kW | 2.9 Litre)**

08.88 - 02.93 | B4B, B4C | ...HD; ...HE; ...HL | X10-729-002-005 | SWP-M-C | Plug Number (T2): 9

**SIERRA Estate (BNG)****1.6 (53 kW | 1.6 Litre)**

01.88 - 02.93 | LSF | ...HD; ...HE; ...HL | X10-729-002-005 | SWP-M-C | Plug Number (T2): 9

**1.6 (55 kW | 1.6 Litre)**

03.87 - 02.93 | LSE | ...HD; ...HE; ...HL | X10-729-002-005 | SWP-M-C | Plug Number (T2): 9

**1.6 i (59 kW | 1.6 Litre)**

10.89 - 02.93 | L6B | ...HD; ...HE; ...HL | X10-729-002-005 | SWP-M-C | Plug Number (T2): 9

**1.8 (59 kW | 1.8 Litre)**

10.87 - 05.88 | RED, REF | ...HD; ...HE; ...HL | X10-729-002-005 | SWP-M-C | Plug Number (T2): 9

**1.8 (64 kW | 1.8 Litre)**

05.88 - 02.93 | R2C, R6A | ...HD; ...HE; ...HL | X10-729-002-005 | SWP-M-C | Plug Number (T2): 9

**1.8 (66 kW | 1.8 Litre)**

03.87 - 05.88 | RED, R2A | ...HD; ...HE; ...HL | X10-729-002-005 | SWP-M-C | Plug Number (T2): 9

**1.8 TD (55 kW | 1.8 Litre)**

08.88 - 02.93 | RFA, RFB, RFL | ...HD; ...HE; ...HL | X10-729-002-005 | SWP-M-C | Plug Number (T2): 9

**2.0 (77 kW | 2.0 Litre)**

03.87 - 02.93 | N8C, NES | ...HD; ...HE; ...HL | X10-729-002-005 | SWP-M-C | Plug Number (T2): 9

**2.0 4x4 (88 kW | 2.0 Litre)**

02.90 - 02.93 | N9C | ...HD; ...HE; ...HL | X10-729-002-005 | SWP-M-C | Plug Number (T2): 9

**2.0 4x4 (92 kW | 2.0 Litre)**

05.89 - 02.93 | N9C | ...HD; ...HE; ...HL | X10-729-002-005 | SWP-M-C | Plug Number (T2): 9

**2.0 i (74 kW | 2.0 Litre)**

03.87 - 02.93 | NE5, NEJ | ...HD; ...HE; ...HL | X10-729-002-005 | SWP-M-C | Plug Number (T2): 9

**2.0 i (85 kW | 2.0 Litre)**

03.87 - 02.93 | N4A, N4I | ...HD; ...HE; ...HL | X10-729-002-005 | SWP-M-C | Plug Number (T2): 9

**2.0 i (88 kW | 2.0 Litre)**

05.89 - 02.93 | N9C | ...HD; ...HE; ...HL | X10-729-002-005 | SWP-M-C | Plug Number (T2): 9

**2.0 i (92 kW | 2.0 Litre)**

05.89 - 02.93 | N9C | ...HD; ...HE; ...HL | X10-729-002-005 | SWP-M-C | Plug Number (T2): 9

**2.0 i CAT (74 kW | 2.0 Litre)**

03.87 - 02.93 | N4B | ...HD; ...HE; ...HL | X10-729-002-005 | SWP-M-C | Plug Number (T2): 9

**2.3 D (49 kW | 2.3 Litre)**

03.87 - 02.93 | YTR | ...HD; ...HE; ...HL | X10-729-002-005 | SWP-M-C | Plug Number (T2): 9

**2.8 4x4 (110 kW | 2.8 Litre)**

03.87 - 08.88 | PRG | ...HD; ...HE; ...HL | X10-729-002-005 | SWP-M-C | Plug Number (T2): 9

**2.8 i (105 kW | 2.8 Litre)**

03.87 - 02.93 | PR8 | ...HD; ...HE; ...HL | X10-729-002-005 | SWP-M-C | Plug Number (T2): 9

**2.8 i (107 kW | 2.8 Litre)**

03.87 - 02.93 | PR7 | ...HD; ...HE; ...HL | X10-729-002-005 | SWP-M-C | Plug Number (T2): 9

**2.8 i 4x4 (107 kW | 2.8 Litre)**

03.87 - 02.93 | PR7 | ...HD; ...HE; ...HL | X10-729-002-005 | SWP-M-C | Plug Number (T2): 9

**2.9 (107 kW | 2.9 Litre)**

08.88 - 02.93 | B4B, B4C | ...HD; ...HE; ...HL | X10-729-002-005 | SWP-M-C | Plug Number (T2): 9

**2.9 4x4 (107 kW | 2.9 Litre)**

08.88 - 02.93 | B4B, B4C | ...HD; ...HE; ...HL | X10-729-002-005 | SWP-M-C | Plug Number (T2): 9

**2.9 4x4 (110 kW | 2.9 Litre)**

08.88 - 02.93 | B4B, B4C | ...HD; ...HE; ...HL | X10-729-002-005 | SWP-M-C | Plug Number (T2): 9

**2.9 i (110 kW | 2.9 Litre)**

08.88 - 02.93 | B4B, B4C | ...HD; ...HE; ...HL | X10-729-002-005 | SWP-M-C | Plug Number (T2): 9

**STREET KA****1.6 (70 kW | 1.6 Litre)**

05.03 - 07.05 | CDRA, CDRB | | X10-729-002-005 | SWP-M-C | Plug Number (T2): 9



			<b>VDO</b>		
Date	Engine Code	Chassis No.	Article No.	Product	Information

**FORD****TRANSIT Platform/Chassis (V\_ \_)****1.6 (VCS, VDS) (48 kW | 1.6 Litre)**

11.85 - 10.86	B		X10-729-002-008	SWP-M-C	Plug Number (T2): 12
---------------	---	--	-----------------	---------	----------------------

**2.0 (VGL, VSL, VTL, VCS, VDS) (57 kW | 2.0 Litre)**

11.85 - 10.86	4RC		X10-729-002-008	SWP-M-C	Plug Number (T2): 12
---------------	-----	--	-----------------	---------	----------------------

**2.5 D (VGL, VSL, VTL, VCS, VDS) (50 kW | 2.5 Litre)**

11.85 - 10.86	4AB		X10-729-002-008	SWP-M-C	Plug Number (T2): 12
---------------	-----	--	-----------------	---------	----------------------

**TRANSIT Bus (V\_ \_)****1.6 (VAS, VLS, VZS) (48 kW | 1.6 Litre)**

11.85 - 10.86	4RB		X10-729-002-008	SWP-M-C	Plug Number (T2): 12
---------------	-----	--	-----------------	---------	----------------------

**2.0 (VAS, VIL, VLS, VUL, VZS) (57 kW | 2.0 Litre)**

11.85 - 10.86	4RC		X10-729-002-008	SWP-M-C	Plug Number (T2): 12
---------------	-----	--	-----------------	---------	----------------------

**2.0 (VAS, VLS, VZS) (55 kW | 2.0 Litre)**

11.85 - 10.86	4RC		X10-729-002-008	SWP-M-C	Plug Number (T2): 12
---------------	-----	--	-----------------	---------	----------------------

**2.4 D (VAS, VBL, VIL, VUL, VZS) (46 kW | 2.4 Litre)**

11.85 - 10.86	4AA		X10-729-002-008	SWP-M-C	Plug Number (T2): 12
---------------	-----	--	-----------------	---------	----------------------

**2.5 D (VAS, VBL, VIL, VUL, VZS) (50 kW | 2.5 Litre)**

11.85 - 10.86	4AB		X10-729-002-008	SWP-M-C	Plug Number (T2): 12
---------------	-----	--	-----------------	---------	----------------------

**TRANSIT Box (V\_ \_)****1.6 (WS) (48 kW | 1.6 Litre)**

11.85 - 10.86	4RB		X10-729-002-008	SWP-M-C	Plug Number (T2): 12
---------------	-----	--	-----------------	---------	----------------------

**2.0 (VHL, VVS) (57 kW | 2.0 Litre)**

11.85 - 10.86	4RC		X10-729-002-008	SWP-M-C	Plug Number (T2): 12
---------------	-----	--	-----------------	---------	----------------------

**2.0 (VVL) (55 kW | 2.0 Litre)**

11.85 - 10.86	4RC		X10-729-002-008	SWP-M-C	Plug Number (T2): 12
---------------	-----	--	-----------------	---------	----------------------

**2.4 D (VVS) (46 kW | 2.4 Litre)**

11.85 - 10.86	4AA		X10-729-002-008	SWP-M-C	Plug Number (T2): 12
---------------	-----	--	-----------------	---------	----------------------

**2.5 D (VVL) (50 kW | 2.5 Litre)**

11.85 - 10.86	4AB		X10-729-002-008	SWP-M-C	Plug Number (T2): 12
---------------	-----	--	-----------------	---------	----------------------

**TRANSIT Bus (T\_ \_)****1.6 (TBL, TES) (46 kW | 1.6 Litre)**

12.85 - 01.89	LAT		246-082-008-014C	SWP-M-C	Plug Number (T2): 1; T28: Rear (T29)
---------------	-----	--	------------------	---------	--------------------------------------

12.85 - 01.89	LAT		X10-729-002-008	SWP-M-C	Plug Number (T2): 12
---------------	-----	--	-----------------	---------	----------------------

**2.0 (TBS, TCL, TCS) CAT (57 kW | 2.0 Litre)**

12.85 - 09.92	N6T		246-082-008-014C	SWP-M-C	Plug Number (T2): 1; T28: Rear (T29)
---------------	-----	--	------------------	---------	--------------------------------------

12.85 - 09.92	N6T		X10-729-002-008	SWP-M-C	Plug Number (T2): 12
---------------	-----	--	-----------------	---------	----------------------

**2.0 (TBS, TCL, TCS, TEL, TES) (57 kW | 2.0 Litre)**

11.85 - 09.92	NAT, NAV		246-082-008-014C	SWP-M-C	Plug Number (T2): 1; T28: Rear (T29)
---------------	----------	--	------------------	---------	--------------------------------------

11.85 - 09.92	NAT, NAV		X10-729-002-008	SWP-M-C	Plug Number (T2): 12
---------------	----------	--	-----------------	---------	----------------------

**2.5 D (TBS, TCL, TCS, TEL, TES) (50 kW | 2.5 Litre)**

12.85 - 01.89	4AB		246-082-008-014C	SWP-M-C	Plug Number (T2): 1; T28: Rear (T29)
---------------	-----	--	------------------	---------	--------------------------------------

12.85 - 01.89	4AB		X10-729-002-008	SWP-M-C	Plug Number (T2): 12
---------------	-----	--	-----------------	---------	----------------------

**2.5 D (TBS, TEL, TES) (52 kW | 2.5 Litre)**

09.88 - 09.92	4BA, 4CA, 4AB		246-082-008-014C	SWP-M-C	Plug Number (T2): 1; T28: Rear (T29)
---------------	---------------	--	------------------	---------	--------------------------------------

09.88 - 09.92	4BA, 4CA, 4AB		X10-729-002-008	SWP-M-C	Plug Number (T2): 12
---------------	---------------	--	-----------------	---------	----------------------

**TRANSIT Box (T\_ \_)****1.6 (TAS) (46 kW | 1.6 Litre)**

09.85 - 09.92	LAT		246-082-008-014C	SWP-M-C	Plug Number (T2): 1; T28: Rear (T29)
---------------	-----	--	------------------	---------	--------------------------------------

09.85 - 09.92	LAT		X10-729-002-008	SWP-M-C	Plug Number (T2): 12
---------------	-----	--	-----------------	---------	----------------------

**2.0 (TAL, TAS, TGL, TWS) (57 kW | 2.0 Litre)**

09.85 - 09.92	NAT, NAV		246-082-008-014C	SWP-M-C	Plug Number (T2): 1; T28: Rear (T29)
---------------	----------	--	------------------	---------	--------------------------------------

09.85 - 09.92	NAT, NAV		X10-729-002-008	SWP-M-C	Plug Number (T2): 12
---------------	----------	--	-----------------	---------	----------------------

**2.5 D (TAL, TAS, TGL, TWS) (50 kW | 2.5 Litre)**

01.86 - 09.91	4AB		246-082-008-014C	SWP-M-C	Plug Number (T2): 1; T28: Rear (T29)
---------------	-----	--	------------------	---------	--------------------------------------

01.86 - 09.91	4AB		X10-729-002-008	SWP-M-C	Plug Number (T2): 12
---------------	-----	--	-----------------	---------	----------------------

**2.5 D (TAL, TAS, TGL, TWS) (52 kW | 2.5 Litre)**

10.88 - 09.91	4BA, 4CA		246-082-008-014C	SWP-M-C	Plug Number (T2): 1; T28: Rear (T29)
---------------	----------	--	------------------	---------	--------------------------------------

10.88 - 09.91	4BA, 4CA		X10-729-002-008	SWP-M-C	Plug Number (T2): 12
---------------	----------	--	-----------------	---------	----------------------



Date	Engine Code	Chassis No.	Article No.	Product	Information

**FORD****TRANSIT Platform/Chassis (T\_ \_)****2.0 (TTE, TTL, TTS) (57 kW | 2.0 Litre)**

01.86 - 09.92 | NAT, NAV

X10-729-002-008

SWP-M-C

Plug Number (T2): 12

**2.0 (TUL) CAT (57 kW | 2.0 Litre)**

11.85 - 09.92 | N6T

X10-729-002-008

SWP-M-C

Plug Number (T2): 12

**2.5 D (TTL, TTS, TUL, TUS, TTE) CAT (50 kW | 2.5 Litre)**

01.86 - 01.89 | 4AB

X10-729-002-008

SWP-M-C

Plug Number (T2): 12

**2.5 DI (TTE, TTL, TTS, TUL) (52 kW | 2.5 Litre)**

09.88 - 09.92 | 4BA, 4CA

X10-729-002-008

SWP-M-C

Plug Number (T2): 12

**TRANSIT Bus (E\_ \_)****2.0 (66 kW | 2.0 Litre)**

09.91 - 09.94 | NBA

X10-729-002-008

SWP-M-C

Plug Number (T2): 12

**2.0 i (EBL, EDL, EGL, ESS, EUS) (72 kW | 2.0 Litre)**

09.91 - 07.94 | NCA

X10-729-002-008

SWP-M-C

Plug Number (T2): 12

**2.5 DI (EBS, EDS, EDL, ESS, EUS) (51 kW | 2.5 Litre)**

08.91 - 07.94 | 4BC, 4FA, 4CC

X10-729-002-008

SWP-M-C

Plug Number (T2): 12

**2.5 DI (EBS, EDS, EGL, ESS, EUS) (59 kW | 2.5 Litre)**

09.91 - 07.94 | 4DA

X10-729-002-008

SWP-M-C

Plug Number (T2): 12

**2.5 TD (EBS, EBL, ECL, EDS, EDL, ESS, EUS) (63 kW | 2.5 Litre)**

10.92 - 07.94 | 4GA, 4GC, 4GB

X10-729-002-008

SWP-M-C

Plug Number (T2): 12

**2.5 TD (ECL, EDS, EDL, EGL, ESS, EUS) (74 kW | 2.5 Litre)**

09.91 - 07.94 | 4EA

X10-729-002-008

SWP-M-C

Plug Number (T2): 12

**2.9 i (107 kW | 2.9 Litre)**

01.91 - 09.94 | BRT

X10-729-002-008

SWP-M-C

Plug Number (T2): 12

**TRANSIT Box (E\_ \_)****2.0 (66 kW | 2.0 Litre)**

09.91 - 06.94 | NBA

246-082-008-014C

SWP-M-C

Plug Number (T2): 1; T28: Rear (T29)

09.91 - 06.94 | NBA

X10-729-002-008

SWP-M-C

Plug Number (T2): 12

**2.0 i (EAL, EAS) (72 kW | 2.0 Litre)**

09.91 - 06.94 | NCA

246-082-008-014C

SWP-M-C

Plug Number (T2): 1; T28: Rear (T29)

09.91 - 06.94 | NCA

X10-729-002-008

SWP-M-C

Plug Number (T2): 12

**2.5 DI (EAL, EAS) (51 kW | 2.5 Litre)**

05.91 - 06.94 | 4BC, 4CC, 4FA

246-082-008-014C

SWP-M-C

Plug Number (T2): 1; T28: Rear (T29)

05.91 - 06.94 | 4BC, 4CC, 4FA

X10-729-002-008

SWP-M-C

Plug Number (T2): 12

**2.5 DI (EAL, EAS) (63 kW | 2.5 Litre)**

10.92 - 06.94 | 4GA

246-082-008-014C

SWP-M-C

Plug Number (T2): 1; T28: Rear (T29)

10.92 - 06.94 | 4GA

X10-729-002-008

SWP-M-C

Plug Number (T2): 12

**2.5 DI (EAS, EAL) (59 kW | 2.5 Litre)**

05.91 - 06.94 | 4DA

246-082-008-014C

SWP-M-C

Plug Number (T2): 1; T28: Rear (T29)

05.91 - 06.94 | 4DA

X10-729-002-008

SWP-M-C

Plug Number (T2): 12

**2.5 TD (EAS, EAL) (74 kW | 2.5 Litre)**

05.91 - 06.94 | 4EA

246-082-008-014C

SWP-M-C

Plug Number (T2): 1; T28: Rear (T29)

05.91 - 06.94 | 4EA

X10-729-002-008

SWP-M-C

Plug Number (T2): 12

**TRANSIT Platform/Chassis (E\_ \_)****2.0 (EME/L/S, ENE/L/S) (72 kW | 2.0 Litre)**

09.91 - 08.94 | NCA

X10-729-002-008

SWP-M-C

Plug Number (T2): 12

**2.5 DI (EME/L/S, ENE/L/S) (59 kW | 2.5 Litre)**

09.91 - 08.94 | 4DA

X10-729-002-008

SWP-M-C

Plug Number (T2): 12

**2.5 DI (EML/S, ENL/S) (51 kW | 2.5 Litre)**

09.91 - 08.94 | 4FA, 4BC, 4CC

X10-729-002-008

SWP-M-C

Plug Number (T2): 12

**2.5 TD (EME/L/S, ENE/L) (74 kW | 2.5 Litre)**

09.91 - 08.94 | 4EA

X10-729-002-008

SWP-M-C

Plug Number (T2): 12

**2.5 TD (EME/L/S, ENE/L/S) (63 kW | 2.5 Litre)**

11.92 - 08.94 | 4GA

X10-729-002-008

SWP-M-C

Plug Number (T2): 12

**TRANSIT Bus (E\_ \_)****2.0 (EBL, EBS, ECL, EDS, EDL, EGL, ESS, ESL, EUS) (84 kW | 2.0 Litre)**

09.95 - 03.00 | NSF, NSG

X10-729-002-008

SWP-M-C

Plug Number (T2): 12

**2.0 CNG (84 kW | 2.0 Litre)**

06.94 - 03.00 | NSH

X10-729-002-008

SWP-M-C

Plug Number (T2): 12



			<b>VDO</b>		
Date	Engine Code	Chassis No.	Article No.	Product	Information

**FORD****TRANSIT Bus (E\_ \_)****2.5 DI (EBL, ECL, EDS, EDL) (56 kW | 2.5 Litre)**

07.94 - 03.00 4HB, 4HC X10-729-002-008 SWP-M-C Plug Number (T2): 12

**2.5 DI (EBL, EDL, EDS, ESL, ESS) (85 kW | 2.5 Litre)**

08.97 - 03.00 4ED X10-729-002-008 SWP-M-C Plug Number (T2): 12

**2.5 DI (EBL, EDS, ESL, ESS, EUS) (51 kW | 2.5 Litre)**

08.94 - 03.00 4FA, 4FB, 4FC, 4FD X10-729-002-008 SWP-M-C Plug Number (T2): 12

**2.5 TD (EBL, EDL, EDS, EGL, ESL, ESS, EUS) (63 kW | 2.5 Litre)**

01.95 - 03.00 4GA, 4GB, 4GC, 4GD, 4GE, 4GF X10-729-002-008 SWP-M-C Plug Number (T2): 12

**2.5 TD (EB\_ , ED\_ , ES\_ ) (55 kW | 2.5 Litre)**

08.94 - 06.00 4HA, 4HD X10-729-002-008 SWP-M-C Plug Number (T2): 12

**2.5 TD (ECL, EDL, EDS, ESL, ESS, EUS) (74 kW | 2.5 Litre)**

07.94 - 03.00 4EB, 4EC X10-729-002-008 SWP-M-C Plug Number (T2): 12

**TRANSIT Box (E\_ \_)****2.0 (EAL, EAS) (84 kW | 2.0 Litre)**

06.94 - 03.00 NSF, NSG X10-729-002-008 SWP-M-C Plug Number (T2): 1; T28: Rear (T29)

06.94 - 03.00 NSF, NSG X10-729-002-008 SWP-M-C Plug Number (T2): 12

**2.5 DI (EAL, EAS) (51 kW | 2.5 Litre)**

06.94 - 03.00 4FA, 4FB, 4FC, 4FD X10-729-002-008 SWP-M-C Plug Number (T2): 1; T28: Rear (T29)

06.94 - 03.00 4FA, 4FB, 4FC, 4FD X10-729-002-008 SWP-M-C Plug Number (T2): 12

**2.5 DI (EAL, EAS) (56 kW | 2.5 Litre)**

06.94 - 03.00 4HB, 4HC X10-729-002-008 SWP-M-C Plug Number (T2): 1; T28: Rear (T29)

06.94 - 03.00 4HB, 4HC X10-729-002-008 SWP-M-C Plug Number (T2): 12

**2.5 DI (EAL, EAS) (85 kW | 2.5 Litre)**

05.99 - 03.00 4ED X10-729-002-008 SWP-M-C Plug Number (T2): 1; T28: Rear (T29)

05.99 - 03.00 4ED X10-729-002-008 SWP-M-C Plug Number (T2): 12

**2.5 TD (EAL, EAS) (63 kW | 2.5 Litre)**

06.94 - 03.00 4GA, 4GB, 4GC, 4GD, 4GE, 4GF X10-729-002-008 SWP-M-C Plug Number (T2): 1; T28: Rear (T29)

06.94 - 03.00 4GA, 4GB, 4GC, 4GD, 4GE, 4GF X10-729-002-008 SWP-M-C Plug Number (T2): 12

**2.5 TD (EAS) (55 kW | 2.5 Litre)**

10.98 - 03.00 4HA, 4HD X10-729-002-008 SWP-M-C Plug Number (T2): 1; T28: Rear (T29)

10.98 - 03.00 4HA, 4HD X10-729-002-008 SWP-M-C Plug Number (T2): 12

**2.5 TDI (EAL, EAS) (74 kW | 2.5 Litre)**

06.94 - 03.00 4EB, 4EC X10-729-002-008 SWP-M-C Plug Number (T2): 1; T28: Rear (T29)

06.94 - 03.00 4EB, 4EC X10-729-002-008 SWP-M-C Plug Number (T2): 12

**TRANSIT Platform/Chassis (E\_ \_)****2.0 (EME/L/S, ENE/L/S) (84 kW | 2.0 Litre)**

08.94 - 03.00 NSF, NSG X10-729-002-008 SWP-M-C Plug Number (T2): 12

**2.5 DI (EME/L/S, ENE/L/S) (56 kW | 2.5 Litre)**

08.94 - 03.00 4HB, 4HC X10-729-002-008 SWP-M-C Plug Number (T2): 12

**2.5 DI (EML, ENE/L) (85 kW | 2.5 Litre)**

05.99 - 03.00 4ED X10-729-002-008 SWP-M-C Plug Number (T2): 12

**2.5 DI (EML/S, ENL/S) (51 kW | 2.5 Litre)**

08.94 - 03.00 4FA, 4FB, 4FC, 4FD X10-729-002-008 SWP-M-C Plug Number (T2): 12

**2.5 TD (EME/L/S, ENE/L/S) (55 kW | 2.5 Litre)**

10.98 - 4HA, 4HD X10-729-002-008 SWP-M-C Plug Number (T2): 12

**2.5 TD (EME/L/S, ENE/L/S) (63 kW | 2.5 Litre)**

08.94 - 03.00 4GA, 4GB, 4GC, 4GD, 4GE, 4GF X10-729-002-008 SWP-M-C Plug Number (T2): 12

**2.5 TD (EME/L/S, ENE/L/S) (74 kW | 2.5 Litre)**

08.94 - 03.00 4EB, 4EC X10-729-002-008 SWP-M-C Plug Number (T2): 12

**TRANSIT Bus (FD\_ , FB\_ , FS\_ , FZ\_ , FC\_ )****2.0 DI (F\_E\_ , F\_F\_ , F\_G\_ ) (55 kW | 2.0 Litre)**

08.00 - 05.06 D3FA X10-729-002-005 SWP-M-C Plug Number (T2): 9

**2.0 DI (F\_E\_ , F\_F\_ , F\_G\_ ) (63 kW | 2.0 Litre)**

08.00 - 05.06 F3FA X10-729-002-005 SWP-M-C Plug Number (T2): 9

**2.0 DI (F\_E\_ , F\_F\_ , F\_G\_ ) (74 kW | 2.0 Litre)**

08.00 - 05.06 ABFA X10-729-002-005 SWP-M-C Plug Number (T2): 9

**2.0 TDCi (F\_F\_ , F\_E\_ , F\_G\_ ) (92 kW | 2.0 Litre)**

08.02 - 05.06 F1FA X10-729-002-005 SWP-M-C Plug Number (T2): 9

**2.3 16V [RWD] (F\_B\_ , F\_C\_ , F\_A\_ ) (107 kW | 2.3 Litre)**

08.00 - 05.06 E5FA, E5FC X10-729-002-005 SWP-M-C Plug Number (T2): 9



			<b>VDO</b>		
Date	Engine Code	Chassis No.	Article No.	Product	Information

**FORD****TRANSIT Bus (FD\_ , FB\_ , FS\_ , FZ\_ , FC\_ )****2.4 DI (F\_B\_ , F\_C\_ , F\_A\_ ) (66 kW | 2.4 Litre)**

01.00 - 05.06 | D2FB, D2FA, D2FE | X10-729-002-005 | SWP-M-C | Plug Number (T2): 9

**2.4 DI [RWD] (F\_B\_ , F\_C\_ ) (55 kW | 2.4 Litre)**

01.00 - 05.06 | F4FA | X10-729-002-005 | SWP-M-C | Plug Number (T2): 9

**2.4 DI [RWD] (F\_B\_ , F\_C\_ , F\_A\_ ) (88 kW | 2.4 Litre)**

01.00 - 05.06 | D4FA | X10-729-002-005 | SWP-M-C | Plug Number (T2): 9

**2.4 TDCi (101 kW | 2.4 Litre)**

03.04 - 05.06 | H9FA | X10-729-002-005 | SWP-M-C | Plug Number (T2): 9

**2.4 TDE (85 kW | 2.4 Litre)**

03.04 - 05.06 | FXFA | X10-729-002-005 | SWP-M-C | Plug Number (T2): 9

**2.4 TDE (F\_C\_ , F\_B\_ , F\_A\_ ) (92 kW | 2.4 Litre)**

07.01 - 05.06 | DOFA | X10-729-002-005 | SWP-M-C | Plug Number (T2): 9

**TRANSIT Box (FA\_ )****2.0 DI (FAE\_ , FAF\_ , FAG\_ ) (55 kW | 2.0 Litre)**

08.00 - 05.06 | D3FA | X10-729-002-004 | SWP-M-C | Plug Number (T2): 9

**2.0 DI (FAE\_ , FAF\_ , FAG\_ ) (63 kW | 2.0 Litre)**

08.00 - 05.06 | F3FA | X10-729-002-004 | SWP-M-C | Plug Number (T2): 9

**2.0 DI (FAE\_ , FAF\_ , FAG\_ ) (74 kW | 2.0 Litre)**

08.00 - 05.06 | ABFA | X10-729-002-004 | SWP-M-C | Plug Number (T2): 9

**2.0 TDCi (92 kW | 2.0 Litre)**

08.02 - 05.06 | F1FA | X10-729-002-004 | SWP-M-C | Plug Number (T2): 9

**2.3 16V [RWD] (FAA\_ , FAB\_ , FAC\_ ) (107 kW | 2.3 Litre)**

04.01 - 05.06 | E5FA, E5FC | X10-729-002-004 | SWP-M-C | Plug Number (T2): 9

**2.4 DI (FAA\_ , FAB\_ , FAC\_ , FAD\_ ) (66 kW | 2.4 Litre)**

01.00 - 05.06 | D2FA, D2FE, D2FB | X10-729-002-004 | SWP-M-C | Plug Number (T2): 9

**2.4 DI [RWD] (FAA\_ , FAB\_ , FAC\_ , FAD\_ ) (55 kW | 2.4 Litre)**

01.00 - 05.06 | F4FA | X10-729-002-004 | SWP-M-C | Plug Number (T2): 9

**2.4 DI [RWD] (FAA\_ , FAB\_ , FAC\_ , FAD\_ ) (88 kW | 2.4 Litre)**

01.00 - 05.06 | D4FA | X10-729-002-004 | SWP-M-C | Plug Number (T2): 9

**2.4 TDCi (101 kW | 2.4 Litre)**

03.04 - 05.06 | H9FA | X10-729-002-005 | SWP-M-C | Plug Number (T2): 9

**2.4 TDE (85 kW | 2.4 Litre)**

03.04 - 05.06 | FXFA | X10-729-002-005 | SWP-M-C | Plug Number (T2): 9

**2.4 TDE (92 kW | 2.4 Litre)**

07.01 - 05.06 | DOFA | X10-729-002-005 | SWP-M-C | Plug Number (T2): 9

**TRANSIT Platform/Chassis (FM\_ , FN\_ )****2.0 DI (F\_E\_ , F\_F\_ ) (55 kW | 2.0 Litre)**

08.00 - 05.06 | D3FA | X10-729-002-004 | SWP-M-C | Plug Number (T2): 9

08.00 - 05.06 | D3FA | X10-729-002-005 | SWP-M-C | Plug Number (T2): 9; T30: FT 300 K

**2.0 DI (F\_E\_ , F\_F\_ ) (63 kW | 2.0 Litre)**

08.00 - 05.06 | F3FA | X10-729-002-005 | SWP-M-C | Plug Number (T2): 9; T30: FT 300 K

**2.0 DI (F\_E\_ , F\_F\_ ) (74 kW | 2.0 Litre)**

08.00 - 05.06 | ABFA | X10-729-002-004 | SWP-M-C | Plug Number (T2): 9

08.00 - 05.06 | ABFA | X10-729-002-005 | SWP-M-C | Plug Number (T2): 9; T30: FT 300 K

**2.0 TDCi (F\_E\_ , F\_F\_ ) (92 kW | 2.0 Litre)**

08.02 - 05.06 | F1FA | X10-729-002-004 | SWP-M-C | Plug Number (T2): 9

08.02 - 05.06 | F1FA | X10-729-002-005 | SWP-M-C | Plug Number (T2): 9; T30: FT 300 K

**2.3 16V (F\_A\_ , F\_B\_ , F\_C\_ , F\_D\_ ) (107 kW | 2.3 Litre)**

04.01 - 05.06 | E5FA, E5FC | X10-729-002-004 | SWP-M-C | Plug Number (T2): 9

04.01 - 05.06 | E5FA, E5FC | X10-729-002-005 | SWP-M-C | Plug Number (T2): 9; T30: FT 300 K

**2.4 DI (F\_A\_ , F\_B\_ , F\_C\_ , F\_D\_ ) (55 kW | 2.4 Litre)**

01.00 - 05.06 | F4FA | X10-729-002-004 | SWP-M-C | Plug Number (T2): 9

01.00 - 05.06 | F4FA | X10-729-002-005 | SWP-M-C | Plug Number (T2): 9; T30: FT 300 K

**2.4 DI (F\_A\_ , F\_B\_ , F\_C\_ , F\_D\_ ) (66 kW | 2.4 Litre)**

01.00 - 05.06 | D2FA, D2FE, D2FB | X10-729-002-004 | SWP-M-C | Plug Number (T2): 9

01.00 - 05.06 | D2FA, D2FE, D2FB | X10-729-002-005 | SWP-M-C | Plug Number (T2): 9; T30: FT 300 K

**2.4 DI (F\_A\_ , F\_B\_ , F\_C\_ , F\_D\_ ) (88 kW | 2.4 Litre)**

01.00 - 05.06 | D4FA | X10-729-002-004 | SWP-M-C | Plug Number (T2): 9

01.00 - 05.06 | D4FA | X10-729-002-005 | SWP-M-C | Plug Number (T2): 9; T30: FT 300 K

**2.4 TDCi (101 kW | 2.4 Litre)**

03.04 - 05.06 | H9FA | X10-729-002-005 | SWP-M-C | Plug Number (T2): 9



			<b>VDO</b>		
Date	Engine Code	Chassis No.	Article No.	Product	Information

**FORD****TRANSIT Platform/Chassis (FM\_ \_, FN\_ \_)****2.4 TDE (85 kW | 2.4 Litre)**

03.04 - 05.06 FXFA X10-729-002-005 SWP-M-C Plug Number (T2): 9

**2.4 TDE (92 kW | 2.4 Litre)**

07.01 - 05.06 DOFA X10-729-002-005 SWP-M-C Plug Number (T2): 9

**HONDA****CIVIC VIII Hatchback (FN, FK)****1.4 (61 kW | 1.4 Litre)**

01.06 - L13A7 246-082-008-025G SWP-M-C

**1.4 (73 kW | 1.4 Litre)**

10.08 - L13Z1 246-082-008-025G SWP-M-C

**1.8 (103 kW | 1.8 Litre)**

01.06 - R18A2 246-082-008-025G SWP-M-C

**2.0 (110 kW | 2.0 Litre)**

12.06 - K20Z4 246-082-008-025G SWP-M-C

**2.2 CTDi (103 kW | 2.2 Litre)**

01.06 - N22A2 246-082-008-025G SWP-M-C

**Type R (148 kW | 2.0 Litre)**

09.06 - K20Z4 246-082-008-025G SWP-M-C

**CIVIC VIII Saloon (FD, FA)****1.3 Hybrid (70 kW | 1.3 Litre)**

01.06 - LDA2 246-082-008-025G SWP-M-C

**LADA****NIVA (2121)****1700 i (59 kW | 1.7 Litre)**

06.96 - BA3 21214 246-082-008-014C SWP-M-C Plug Number (T2): 1; T26: 89-602-050

**1900 Diesel (47 kW | 1.9 Litre)**

02.95 - XUD9A 246-082-008-014C SWP-M-C Plug Number (T2): 1; T26: 89-602-050

**SAMARA (2108, 2109)****1100 (39 kW | 1.1 Litre)**

02.88 - 12.94 BA3 21081 246-082-008-014C SWP-M-C Plug Number (T2): 1; T26: 89-602-050

**1100 (43 kW | 1.1 Litre)**

02.96 - BA3 21081 (KAT) 246-082-008-014C SWP-M-C Plug Number (T2): 1; T26: 89-602-050

**1300 (46 kW | 1.3 Litre)**

01.88 - BA3 2108 246-082-008-014C SWP-M-C Plug Number (T2): 1; T26: 89-602-050

**1300 (48 kW | 1.3 Litre)**

01.86 - 12.94 BA3 2108 246-082-008-014C SWP-M-C Plug Number (T2): 1; T26: 89-602-050

**1300 (50 kW | 1.3 Litre)**

02.96 - BA3 21115 246-082-008-014C SWP-M-C Plug Number (T2): 1; T26: 89-602-050

**1500 (52 kW | 1.5 Litre)**

02.95 - BA3 2111 246-082-008-014C SWP-M-C Plug Number (T2): 1; T26: 89-602-050

**SAMARA FORMA (21099)****1100 (39 kW | 1.1 Litre)**

07.91 - BA3 21081 (KAT) 246-082-008-014C SWP-M-C Plug Number (T2): 1; T26: 89-602-050

**1300 (45 kW | 1.3 Litre)**

07.91 - BA3 2108 246-082-008-014C SWP-M-C Plug Number (T2): 1; T26: 89-602-050

**1300 (46 kW | 1.3 Litre)**

05.90 - BA3 2108 246-082-008-014C SWP-M-C Plug Number (T2): 1; T26: 89-602-050

**1300 (48 kW | 1.3 Litre)**

05.89 - 07.97 BA3 2108 246-082-008-014C SWP-M-C Plug Number (T2): 1; T26: 89-602-050

**1300 (50 kW | 1.3 Litre)**

02.96 - BA3 21115 246-082-008-014C SWP-M-C Plug Number (T2): 1; T26: 89-602-050



			<b>VDO</b>		
Date	Engine Code	Chassis No.	Article No.	Product	Information

**LADA****SAMARA FORMA (21099)****1500 (50 kW | 1.5 Litre)**

07.91 -	BA3 21083 (KAT)		246-082-008-014C	SWP-M-C	Plug Number (T2): 1; T26: 89-602-050
---------	-----------------	--	------------------	---------	--------------------------------------

**1500 (52 kW | 1.5 Litre)**

11.94 -	BA3 2111		246-082-008-014C	SWP-M-C	Plug Number (T2): 1; T26: 89-602-050
---------	----------	--	------------------	---------	--------------------------------------

**1500 (53 kW | 1.5 Litre)**

09.91 -	BA3 21083		246-082-008-014C	SWP-M-C	Plug Number (T2): 1; T26: 89-602-050
---------	-----------	--	------------------	---------	--------------------------------------

**LANCIA****DEDRA (835)****1.6 16V (835EI) (76 kW | 1.6 Litre)**

01.96 - 07.99	182 A4.000		246-082-008-014C	SWP-M-C	Plug Number (T2): 1
---------------	------------	--	------------------	---------	---------------------

01.96 - 07.99	182 A4.000		246-083-001-004C	SWP-D-C	Plug Number (T2): 1
---------------	------------	--	------------------	---------	---------------------

**1.6 i.e. (835AA) (66 kW | 1.6 Litre)**

08.89 - 06.94	835 A1.000		246-082-008-014C	SWP-M-C	Plug Number (T2): 1
---------------	------------	--	------------------	---------	---------------------

02.92 - 06.94	835 A1.000		246-083-001-004C	SWP-D-C	Plug Number (T2): 1
---------------	------------	--	------------------	---------	---------------------

**1.6 i.e. (835AB) (57 kW | 1.6 Litre)**

08.89 - 03.93	8140.43S		246-082-008-014C	SWP-M-C	Plug Number (T2): 1
---------------	----------	--	------------------	---------	---------------------

08.89 - 03.93	835 A1.046		246-083-001-004C	SWP-D-C	Plug Number (T2): 1
---------------	------------	--	------------------	---------	---------------------

**1.6 i.e. (835AN) (55 kW | 1.6 Litre)**

04.93 - 07.99	8140.43S		246-082-008-014C	SWP-M-C	Plug Number (T2): 1
---------------	----------	--	------------------	---------	---------------------

04.93 - 06.94	835 C1.000		246-083-001-004C	SWP-D-C	Plug Number (T2): 1
---------------	------------	--	------------------	---------	---------------------

**1.6 LE (835EB) CAT (66 kW | 1.6 Litre)**

07.94 - 07.99	8140.43S		246-082-008-014C	SWP-M-C	Plug Number (T2): 1
---------------	----------	--	------------------	---------	---------------------

07.94 - 07.99	159 B9.000		246-083-001-004C	SWP-D-C	Plug Number (T2): 1
---------------	------------	--	------------------	---------	---------------------

**1.8 16V LE (835FG) (83 kW | 1.8 Litre)**

03.96 - 07.99	8140.43S		246-082-008-014C	SWP-M-C	Plug Number (T2): 1
---------------	----------	--	------------------	---------	---------------------

03.96 - 07.99	182 A2.000		246-083-001-004C	SWP-D-C	Plug Number (T2): 1
---------------	------------	--	------------------	---------	---------------------

**1.8 GT 16V (835EH) (96 kW | 1.8 Litre)**

03.96 - 07.99	8140.43S		246-082-008-014C	SWP-M-C	Plug Number (T2): 1
---------------	----------	--	------------------	---------	---------------------

03.96 - 07.99	183 A1.000		246-083-001-004C	SWP-D-C	Plug Number (T2): 1
---------------	------------	--	------------------	---------	---------------------

**1.8 i.e. (835AC, 835BC) (80 kW | 1.8 Litre)**

09.89 - 06.94	835 A2.000		246-082-008-014C	SWP-M-C	Plug Number (T2): 1
---------------	------------	--	------------------	---------	---------------------

09.89 - 06.94	835 A2.000		246-083-001-004C	SWP-D-C	Plug Number (T2): 1
---------------	------------	--	------------------	---------	---------------------

**1.8 i.e. (835AT) (66 kW | 1.8 Litre)**

08.93 - 07.99	8140.43S		246-082-008-014C	SWP-M-C	Plug Number (T2): 1
---------------	----------	--	------------------	---------	---------------------

08.93 - 07.99	835 C5.000		246-083-001-004C	SWP-D-C	Plug Number (T2): 1
---------------	------------	--	------------------	---------	---------------------

**1.8 i.e. (835BD, 835AD) (77 kW | 1.8 Litre)**

09.89 - 07.99	8140.43S		246-082-008-014C	SWP-M-C	Plug Number (T2): 1
---------------	----------	--	------------------	---------	---------------------

09.89 - 07.99	835 A2.046		246-083-001-004C	SWP-D-C	Plug Number (T2): 1
---------------	------------	--	------------------	---------	---------------------

**1.8 i.e. (835FA) (74 kW | 1.8 Litre)**

07.94 - 07.99	8140.43S		246-082-008-014C	SWP-M-C	Plug Number (T2): 1
---------------	----------	--	------------------	---------	---------------------

07.94 - 07.99	836 A5.000		246-083-001-004C	SWP-D-C	Plug Number (T2): 1
---------------	------------	--	------------------	---------	---------------------

**1.9 TDS (835EE, 835EF) (66 kW | 1.9 Litre)**

04.89 - 07.99	8140.43S		246-082-008-014C	SWP-M-C	Plug Number (T2): 1
---------------	----------	--	------------------	---------	---------------------

02.92 - 06.94	835 A4.000, 160 D1.000, 835 A4.046		246-083-001-004C	SWP-D-C	Plug Number (T2): 1
---------------	---------------------------------------	--	------------------	---------	---------------------

**2.0 16V (835ED) (102 kW | 2.0 Litre)**

07.94 - 07.99	8140.43S		246-082-008-014C	SWP-M-C	Plug Number (T2): 1
---------------	----------	--	------------------	---------	---------------------

07.94 - 07.99	836 A3.000		246-083-001-004C	SWP-D-C	Plug Number (T2): 1
---------------	------------	--	------------------	---------	---------------------

**2.0 HF Integrale (835AP) (124 kW | 2.0 Litre)**

11.90 - 07.94	8140.43S		246-082-008-014C	SWP-M-C	Plug Number (T2): 1
---------------	----------	--	------------------	---------	---------------------

02.92 - 06.94	835 A7.046		246-083-001-004C	SWP-D-C	Plug Number (T2): 1
---------------	------------	--	------------------	---------	---------------------

**2.0 i.e. (835AI) (86 kW | 2.0 Litre)**

09.89 - 07.92	835 A5.000		246-082-008-014C	SWP-M-C	Plug Number (T2): 1
---------------	------------	--	------------------	---------	---------------------

09.89 - 07.92	835 A5.000		246-083-001-004C	SWP-D-C	Plug Number (T2): 1
---------------	------------	--	------------------	---------	---------------------

**2.0 i.e. (835AL) (83 kW | 2.0 Litre)**

09.89 - 07.99	8140.43S		246-082-008-014C	SWP-M-C	Plug Number (T2): 1
---------------	----------	--	------------------	---------	---------------------

09.89 - 07.99	835 A5.046		246-083-001-004C	SWP-D-C	Plug Number (T2): 1
---------------	------------	--	------------------	---------	---------------------

**2.0 i.e. Turbo (835AR) (119 kW | 2.0 Litre)**

04.91 - 07.99	8140.43S		246-082-008-014C	SWP-M-C	Plug Number (T2): 1
---------------	----------	--	------------------	---------	---------------------





			<b>VDO</b>		
Date	Engine Code	Chassis No.	Article No.	Product	Information

**LANCIA****DEDRA (835)****2.0 i.e. Turbo (835AR) (119 kW | 2.0 Litre)**

02.92 → 06.94 | 835 A8.046 | 246-083-001-004C | SWP-D-C | Plug Number (T2): 1

**2.0 i.e. Turbo Integrale (835AO) (121 kW | 2.0 Litre)**

05.90 → 07.94 | 835 A7.000 | 246-082-008-014C | SWP-M-C | Plug Number (T2): 1

02.92 → 06.94 | 835 A7.000 | 246-083-001-004C | SWP-D-C | Plug Number (T2): 1

**2.0 Turbo (835AQ) (130 kW | 2.0 Litre)**

11.90 → 06.94 | 835 A8.000 | 246-082-008-014C | SWP-M-C | Plug Number (T2): 1

02.92 → 06.94 | 835 A8.000 | 246-083-001-004C | SWP-D-C | Plug Number (T2): 1

**DEDRA SW (835)****1.6 (835EB) (66 kW | 1.6 Litre)**

10.94 → 07.99 | 8140.43S | 246-082-008-014C | SWP-M-C | Plug Number (T2): 1

10.94 → 07.99 | 159 B9.000 | 246-083-001-004C | SWP-D-C | Plug Number (T2): 1

**1.6 16V (835EI) (76 kW | 1.6 Litre)**

01.96 → 07.99 | 182 A4.000 | 246-082-008-014C | SWP-M-C | Plug Number (T2): 1

01.96 → 07.99 | 182 A4.000 | 246-083-001-004C | SWP-D-C | Plug Number (T2): 1

**1.8 16V LE (835FG) (83 kW | 1.8 Litre)**

03.96 → 07.99 | 8140.43S | 246-082-008-014C | SWP-M-C | Plug Number (T2): 1

03.96 → 07.99 | 182 A2.000 | 246-083-001-004C | SWP-D-C | Plug Number (T2): 1

**1.8 GT 16V (835EH) (96 kW | 1.8 Litre)**

03.96 → 07.99 | 8140.43S | 246-082-008-014C | SWP-M-C | Plug Number (T2): 1

03.96 → 07.99 | 183 A1.000 | 246-083-001-004C | SWP-D-C | Plug Number (T2): 1

**1.8 i.e. (835FA) (74 kW | 1.8 Litre)**

07.94 → 07.99 | 8140.43S | 246-082-008-014C | SWP-M-C | Plug Number (T2): 1

07.94 → 07.99 | 836 A5.000 | 246-083-001-004C | SWP-D-C | Plug Number (T2): 1

**1.9 TDS (835EE, 835EF) (66 kW | 1.9 Litre)**

07.94 → 07.99 | 8140.43S | 246-082-008-014C | SWP-M-C | Plug Number (T2): 1

07.94 → 07.99 | 835 A4.000, 160 D1.000 | 246-083-001-004C | SWP-D-C | Plug Number (T2): 1

**2.0 16V (835ED) (102 kW | 2.0 Litre)**

07.94 → 07.99 | 8140.43S | 246-082-008-014C | SWP-M-C | Plug Number (T2): 1

07.94 → 07.99 | 836 A3.000 | 246-083-001-004C | SWP-D-C | Plug Number (T2): 1

**2.0 Integrale (835ED) (102 kW | 2.0 Litre)**

07.94 → 07.99 | 8140.43S | 246-082-008-014C | SWP-M-C | Plug Number (T2): 1

07.94 → 07.99 | 836 A3.000 | 246-083-001-004C | SWP-D-C | Plug Number (T2): 1

**DELTA II (836)****1.4 i.e. (836AF, 836AH) (51 kW | 1.4 Litre)**

10.94 → 08.99 | 160 A1.046, 836 A4.000 | 246-083-001-004C | SWP-D-C | Plug Number (T2): 1

**1.6 i.e. (836AD) (55 kW | 1.6 Litre)**

06.93 → 08.99 | 835 C1.000 | 246-083-001-004C | SWP-D-C | Plug Number (T2): 1

**1.6 i.e. (836AP) (66 kW | 1.6 Litre)**

03.96 → 08.99 | 182 A6.000 | 246-083-001-004C | SWP-D-C | Plug Number (T2): 1

**1.6 i.e. 16V (836AO) (76 kW | 1.6 Litre)**

01.96 → 08.99 | 182 A4.000 | 246-083-001-004C | SWP-D-C | Plug Number (T2): 1

**1.8 i.e. (836AE) (76 kW | 1.8 Litre)**

06.93 → 08.99 | 835 C2.000 | 246-083-001-004C | SWP-D-C | Plug Number (T2): 1

**1.8 i.e. (836AG, 836AL) (66 kW | 1.8 Litre)**

07.94 → 08.99 | 835 C4.000, 836 C4.000, 836 A6.000 | 246-083-001-004C | SWP-D-C | Plug Number (T2): 1

**1.8 i.e. 16V (836AQ) (83 kW | 1.8 Litre)**

03.96 → 08.99 | 182 A2.000 | 246-083-001-004C | SWP-D-C | Plug Number (T2): 1

**1.8 i.e. 16V GT (836AR) (96 kW | 1.8 Litre)**

03.96 → 08.99 | 183 A1.000 | 246-083-001-004C | SWP-D-C | Plug Number (T2): 1

**1.9 TD (836AM, 836AN) (66 kW | 1.9 Litre)**

10.94 → 08.99 | 160 D1.000, 835 A4.000 | 246-083-001-004C | SWP-D-C | Plug Number (T2): 1

**2.0 16V (836AA, 836CA) (102 kW | 2.0 Litre)**

06.93 → 08.99 | 836 A3.000 | 246-083-001-004C | SWP-D-C | Plug Number (T2): 1

**2.0 16V Turbo (836AB) (137 kW | 2.0 Litre)**

06.93 → 08.99 | 836 A2.000 | 246-083-001-004C | SWP-D-C | Plug Number (T2): 1

**2.0 16V Turbo (836AS) (142 kW | 2.0 Litre)**

07.96 → 08.99 | 175 A4.000 | 246-083-001-004C | SWP-D-C | Plug Number (T2): 1



Date	Engine Code	Chassis No.	Article No.	Product	Information

**LANCIA****KAPPA (838A)****3.0 24V (838AD1AA, 838AD11A, 838XD1AA, 838ZD1AA) (150 kW | 3.0 Litre)**

08.94 - 10.01	8140.43S		246-082-008-014C	SWP-M-C	Plug Number (T2): 1
---------------	----------	--	------------------	---------	---------------------

**KAPPA Coupe (838)****2.0 16V Turbo (838CB) (151 kW | 2.0 Litre)**

11.96 - 03.01	8140.43S		246-082-008-014C	SWP-M-C	Plug Number (T2): 1
---------------	----------	--	------------------	---------	---------------------

**2.0 20V (114 kW | 2.0 Litre)**

07.96 - 03.01	8140.43S		246-082-008-014C	SWP-M-C	Plug Number (T2): 1
---------------	----------	--	------------------	---------	---------------------

**2.0 20V Turbo (838CM) (162 kW | 2.0 Litre)**

06.98 - 03.01	8140.43S		246-082-008-014C	SWP-M-C	Plug Number (T2): 1
---------------	----------	--	------------------	---------	---------------------

**2.4 20V (838CC) (129 kW | 2.4 Litre)**

11.96 - 03.01	8140.43S		246-082-008-014C	SWP-M-C	Plug Number (T2): 1
---------------	----------	--	------------------	---------	---------------------

**3.0 24V (838CD, 838CD11A) (150 kW | 3.0 Litre)**

11.96 - 03.01	8140.43S		246-082-008-014C	SWP-M-C	Plug Number (T2): 1
---------------	----------	--	------------------	---------	---------------------

**KAPPA SW (838B)****3.0 24V (838BD11A) (150 kW | 3.0 Litre)**

07.96 - 10.01	8140.43S		246-082-008-014C	SWP-M-C	Plug Number (T2): 1
---------------	----------	--	------------------	---------	---------------------

**LYBRA (839AX)****1.6 (76 kW | 1.6 Litre)**

10.00 - 10.05	8140.43S		246-082-008-014C	SWP-M-C	Plug Number (T2): 1
---------------	----------	--	------------------	---------	---------------------

**1.6 16V (839AXA1A) (76 kW | 1.6 Litre)**

07.99 - 10.05	182 A4.000		246-082-008-014C	SWP-M-C	Plug Number (T2): 1
---------------	------------	--	------------------	---------	---------------------

07.99 - 10.05	182 A4.000		246-083-001-004C	SWP-D-C	Plug Number (T2): 1
---------------	------------	--	------------------	---------	---------------------

**1.8 16V (839AXB1A, 839AXG1A) (96 kW | 1.8 Litre)**

07.99 - 10.05	839 A4.000, 839 A7.000, 839 A9.000		246-082-008-014C	SWP-M-C	Plug Number (T2): 1
---------------	---------------------------------------	--	------------------	---------	---------------------

07.99 - 10.05	839 A4.000, 839 A7.000, 839 A9.000		246-083-001-004C	SWP-D-C	Plug Number (T2): 1
---------------	---------------------------------------	--	------------------	---------	---------------------

**1.9 JTD (839AXD1A) (77 kW | 1.9 Litre)**

07.99 - 09.00	AR 32302		246-082-008-014C	SWP-M-C	Plug Number (T2): 1
---------------	----------	--	------------------	---------	---------------------

07.99 - 09.00	AR 32302		246-083-001-004C	SWP-D-C	Plug Number (T2): 1
---------------	----------	--	------------------	---------	---------------------

**1.9 JTD (839AXI1A) (81 kW | 1.9 Litre)**

09.00 - 05.01	AR 37101		246-082-008-014C	SWP-M-C	Plug Number (T2): 1
---------------	----------	--	------------------	---------	---------------------

09.00 - 05.01	AR 37101		246-083-001-004C	SWP-D-C	Plug Number (T2): 1
---------------	----------	--	------------------	---------	---------------------

**1.9 JTD (85 kW | 1.9 Litre)**

05.01 - 10.05	8140.43S		246-082-008-014C	SWP-M-C	Plug Number (T2): 1
---------------	----------	--	------------------	---------	---------------------

05.01 - 10.05	937 A2.000		246-083-001-004C	SWP-D-C	Plug Number (T2): 1
---------------	------------	--	------------------	---------	---------------------

**2.0 20V (839AXC11, 839AXC1A) (113 kW | 2.0 Litre)**

07.99 - 09.00	182 B7.000		246-082-008-014C	SWP-M-C	Plug Number (T2): 1
---------------	------------	--	------------------	---------	---------------------

07.99 - 09.00	182 B7.000		246-083-001-004C	SWP-D-C	Plug Number (T2): 1
---------------	------------	--	------------------	---------	---------------------

**2.0 20V (839AXH1A) (110 kW | 2.0 Litre)**

09.00 - 10.05	185 A8.000		246-082-008-014C	SWP-M-C	Plug Number (T2): 1
---------------	------------	--	------------------	---------	---------------------

09.00 - 10.05	185 A8.000		246-083-001-004C	SWP-D-C	Plug Number (T2): 1
---------------	------------	--	------------------	---------	---------------------

**2.4 JTD (110 kW | 2.4 Litre)**

05.02 - 10.05	8140.43S		246-082-008-014C	SWP-M-C	Plug Number (T2): 1
---------------	----------	--	------------------	---------	---------------------

05.02 - 10.05	841 C.000		246-083-001-004C	SWP-D-C	Plug Number (T2): 1
---------------	-----------	--	------------------	---------	---------------------

**2.4 JTD (839AXE1A) (99 kW | 2.4 Litre)**

07.99 - 02.01	839 A5.000, AR 32501		246-082-008-014C	SWP-M-C	Plug Number (T2): 1
---------------	----------------------	--	------------------	---------	---------------------

07.99 - 02.01	839 A5.000, AR 32501		246-083-001-004C	SWP-D-C	Plug Number (T2): 1
---------------	----------------------	--	------------------	---------	---------------------

**2.4 JTD (839AXL1A) (103 kW | 2.4 Litre)**

09.00 - 05.02	839 A6.000		246-082-008-014C	SWP-M-C	Plug Number (T2): 1
---------------	------------	--	------------------	---------	---------------------

09.00 - 05.02	839 A6.000		246-083-001-004C	SWP-D-C	Plug Number (T2): 1
---------------	------------	--	------------------	---------	---------------------

**LYBRA SW (839BX)****1.6 (76 kW | 1.6 Litre)**

10.00 - 10.05	8140.43S		246-082-008-014C	SWP-M-C	Plug Number (T2): 1
---------------	----------	--	------------------	---------	---------------------

**1.6 16V (839BXA1A) (76 kW | 1.6 Litre)**

07.99 - 10.05	182 A4.000		246-082-008-014C	SWP-M-C	Plug Number (T2): 1
---------------	------------	--	------------------	---------	---------------------

07.99 - 10.05	182 A4.000		246-083-001-004C	SWP-D-C	Plug Number (T2): 1
---------------	------------	--	------------------	---------	---------------------

**1.8 16V (839BXB1A, 839BXG1A) (96 kW | 1.8 Litre)**

07.99 - 10.05	839 A4.000, 839 A7.000		246-082-008-014C	SWP-M-C	Plug Number (T2): 1
---------------	------------------------	--	------------------	---------	---------------------



			<b>VDO</b>		
Date	Engine Code	Chassis No.	Article No.	Product	Information

**LANCIA****LYBRA SW (839BX)****1.8 16V (839BxB1A, 839BXG1A) (96 kW | 1.8 Litre)**

07.99 → 10.05 839 A4.000, 839 A7.000 246-083-001-004C SWP-D-C Plug Number (T2): 1

**1.9 JTD (839BXD1A) (77 kW | 1.9 Litre)**

07.99 → 09.00 AR 32302 246-082-008-014C SWP-M-C Plug Number (T2): 1

07.99 → 09.00 AR 32302 246-083-001-004C SWP-D-C Plug Number (T2): 1

**1.9 JTD (839BXI1A) (81 kW | 1.9 Litre)**

09.00 → 05.01 AR 37101 246-082-008-014C SWP-M-C Plug Number (T2): 1

09.00 → 05.01 AR 37101 246-083-001-004C SWP-D-C Plug Number (T2): 1

**1.9 JTD (85 kW | 1.9 Litre)**

05.01 → 10.05 8140.43S 246-082-008-014C SWP-M-C Plug Number (T2): 1

05.01 → 10.05 937 A2.000 246-083-001-004C SWP-D-C Plug Number (T2): 1

**2.0 20V (839BXC11, 839BXC1A) (113 kW | 2.0 Litre)**

07.99 → 09.00 182 B7.000 246-082-008-014C SWP-M-C Plug Number (T2): 1

07.99 → 09.00 182 B7.000 246-083-001-004C SWP-D-C Plug Number (T2): 1

**2.0 20V (839BXH1A) (110 kW | 2.0 Litre)**

09.00 → 10.05 185 A8.000 246-082-008-014C SWP-M-C Plug Number (T2): 1

09.00 → 10.05 185 A8.000 246-083-001-004C SWP-D-C Plug Number (T2): 1

**2.4 JTD (110 kW | 2.4 Litre)**

05.02 → 10.05 8140.43S 246-082-008-014C SWP-M-C Plug Number (T2): 1

05.02 → 10.05 841 C.000 246-083-001-004C SWP-D-C Plug Number (T2): 1

**2.4 JTD (839BXE1A) (99 kW | 2.4 Litre)**

10.99 → 09.00 839 A5.000, AR 32501 246-082-008-014C SWP-M-C Plug Number (T2): 1

10.99 → 09.00 AR 32501, 839 A5.000 246-083-001-004C SWP-D-C Plug Number (T2): 1

**2.4 JTD (839BXL1A) (103 kW | 2.4 Litre)**

09.00 → 10.05 839 A6.000 246-082-008-014C SWP-M-C Plug Number (T2): 1

09.00 → 10.05 839 A6.000 246-083-001-004C SWP-D-C Plug Number (T2): 1

**MUSA (350)****1.3 D Multijet (51 kW | 1.3 Litre)**

10.04 → 188 A9.000 246-083-001-004C SWP-D-C Plug Number (T2): 1

**1.4 (57 kW | 1.4 Litre)**

09.05 → 350 A1.000 246-083-001-004C SWP-D-C Plug Number (T2): 1

**1.4 (70 kW | 1.4 Litre)**

10.04 → 843 A 1.000 246-083-001-004C SWP-D-C Plug Number (T2): 1

**1.9 D Multijet (74 kW | 1.9 Litre)**

10.04 → 188 B2.000 246-083-001-004C SWP-D-C Plug Number (T2): 1

**PHEDRA (179)****2.0 (179AXA11) (100 kW | 2.0 Litre)**

09.02 → 11.10 RFN(EW10J4) A2C53030301 SWP-D-C

**2.0 D Multijet (100 kW | 2.0 Litre)**

07.06 → 11.10 RHR A2C53030301 SWP-D-C

**2.0 JTD (179AXB1A) (80 kW | 2.0 Litre)**

09.02 → 11.10 RHW(DW10ATED4) A2C53030301 SWP-D-C

**2.0 JTD (79 kW | 2.0 Litre)**

07.03 → 11.10 RHM A2C53030301 SWP-D-C

**2.0 JTD (88 kW | 2.0 Litre)**

06.06 → 11.10 RHK A2C53030301 SWP-D-C

**2.2 D Multijet (125 kW | 2.2 Litre)**

03.08 → 11.10 4HS, 4HT A2C53030301 SWP-D-C

**2.2 JTD (179AXC1A) (94 kW | 2.2 Litre)**

09.02 → 11.10 4HW(DW12ATED4) A2C53030301 SWP-D-C

**3.0 V6 (150 kW | 3.0 Litre)**

09.02 → 11.10 ES9 J4S A2C53030301 SWP-D-C

**THEISIS (841AX)****2.0 Turbo (841AXA1B03) (136 kW | 2.0 Litre)**

07.02 → 07.09 8140.43S 246-082-008-014C SWP-M-C Plug Number (T2): 1

**2.4 (841AXB1B00) (125 kW | 2.4 Litre)**

07.02 → 07.09 8140.43S 246-082-008-014C SWP-M-C Plug Number (T2): 1

**2.4 D Multijet (136 kW | 2.4 Litre)**

04.06 → 07.09 8140.43S 246-082-008-014C SWP-M-C Plug Number (T2): 1



					
Date	Engine Code	Chassis No.	Article No.	Product	Information

**LANCIA****THEISIS (841AX)****2.4 JTD (129 kW | 2.4 Litre)**

05.03 - 07.09 | 8140.43S

246-082-008-014C

SWP-M-C

Plug Number (T2): 1

**2.4 JTD (841AXD1B02) (110 kW | 2.4 Litre)**

07.02 - 07.09 | 8140.43S

246-082-008-014C

SWP-M-C

Plug Number (T2): 1

**3.0 V6 (841AXC1101) (158 kW | 3.0 Litre)**

07.02 - 07.09 | 8140.43S

246-082-008-014C

SWP-M-C

Plug Number (T2): 1

**3.2 V6 (169 kW | 3.2 Litre)**

05.03 - 07.09 | 8140.43S

246-082-008-014C

SWP-M-C

Plug Number (T2): 1

**Y (840A)****1.1 (840AE) (40 kW | 1.1 Litre)**

11.95 - 09.03 | 176 B2.000

246-083-001-004C

SWP-D-C

Plug Number (T2): 1

**1.2 (840AA, 840AF1A) (44 kW | 1.2 Litre)**

03.96 - 09.03 | 840 A3.000, 188 A4.000

246-083-001-004C

SWP-D-C

Plug Number (T2): 1

**1.2 16V (840AD) (63 kW | 1.2 Litre)**

04.97 - 09.03 | 176 B9.000

246-083-001-004C

SWP-D-C

Plug Number (T2): 1

**1.2 16V (840AG1A) (59 kW | 1.2 Litre)**

10.00 - 09.03 | 188 A5.000

246-083-001-004C

SWP-D-C

Plug Number (T2): 1

**1.4 12V (840AB) (59 kW | 1.4 Litre)**

10.96 - 09.03 | 840 A2.000

246-083-001-004C

SWP-D-C

Plug Number (T2): 1

**1.4 12V (840AC) (55 kW | 1.4 Litre)**

03.96 - 09.03 | 840 A4.000

246-083-001-004C

SWP-D-C

Plug Number (T2): 1

**YPSILON (843)****1.2 (44 kW | 1.2 Litre)**

10.03 - 12.11 | 188 A4.000

246-083-001-004C

SWP-D-C

Plug Number (T2): 1

**1.2 (59 kW | 1.2 Litre)**

10.03 - 12.11 | 188 A5.000

246-083-001-004C

SWP-D-C

Plug Number (T2): 1

**1.3 JTD (51 kW | 1.3 Litre)**

10.03 - 12.11 | 188 A9.000

246-083-001-004C

SWP-D-C

Plug Number (T2): 1

**1.4 16V (70 kW | 1.4 Litre)**

10.03 - 12.11 | 843 A 1.000

246-083-001-004C

SWP-D-C

Plug Number (T2): 1

**MAZDA****121 III (JASM, JBSM)****1.25 (55 kW | 1.2 Litre)**

03.96 - 04.03 | DHF, DHG

X10-729-002-004

SWP-M-C

Plug Number (T2): 9

**1.3 (37 kW | 1.3 Litre)**

03.96 - 04.03 | JJK, JJM

X10-729-002-004

SWP-M-C

Plug Number (T2): 9

**1.3 (44 kW | 1.3 Litre)**

03.96 - 04.03 | J4R, J4T

X10-729-002-004

SWP-M-C

Plug Number (T2): 9

**1.8 D (44 kW | 1.8 Litre)**

03.96 - 04.03 | RTJ, RTK

X10-729-002-004

SWP-M-C

Plug Number (T2): 9

**MERCEDES-BENZ****B-CLASS (W245)****B 150 (245.231) (70 kW | 1.5 Litre)**

03.05 - 11.11 | M 266.920

246-083-002-022G

SWP-D-C

**B 170 (245.232) (85 kW | 1.7 Litre)**

03.05 - 11.11 | M 266.940

246-083-002-022G

SWP-D-C

**B 180 CDI (245.207) (80 kW | 2.0 Litre)**

03.05 - 11.11 | OM 640.940

246-083-002-022G

SWP-D-C

**B 200 (245.233) (100 kW | 2.0 Litre)**

03.05 - 11.11 | M 266.960

246-083-002-022G

SWP-D-C

**B 200 CDI (245.208) (103 kW | 2.0 Litre)**

03.05 - 11.11 | OM 640.941

246-083-002-022G

SWP-D-C



			<b>VDO</b>		
Date	Engine Code	Chassis No.	Article No.	Product	Information

**MERCEDES-BENZ****B-CLASS (W245)****B 200 TURBO (245.234) (142 kW | 2.0 Litre)**

03.05 - 11.11 | M 266.980

246-083-002-022G

SWP-D-C

**190 (W201)****2.0 (201.022) (66 kW | 2.0 Litre)**

10.82 - 10.84 | M 102.921

246-082-005-002C

SWP-M-C

Plug Number (T2): 4; T25: 124 869 03 21, etc.

12.82 - 10.84 | M 102.921

246-082-008-013P

SWP-M-C

Plug Number (T2): 4; T25: 140 869 02 21, etc.

**2.0 (201.023) (75 kW | 2.0 Litre)**

01.86 - 05.90 | M 102.924

246-082-005-002C

SWP-M-C

Plug Number (T2): 4; T25: 124 869 03 21, etc.

07.89 - 05.90 | M 102.924

246-082-008-013P

SWP-M-C

Plug Number (T2): 4; T25: 140 869 02 21, etc.

**2.0 (201.023) (77 kW | 2.0 Litre)**

09.84 - 05.90 | M 102.924

246-082-005-002C

SWP-M-C

Plug Number (T2): 4; T25: 124 869 03 21, etc.

**D 2.0 (201.122) (53 kW | 2.0 Litre)**

08.83 - 08.89 | OM 601.911

246-082-005-002C

SWP-M-C

Plug Number (T2): 4; T25: 124 869 03 21, etc.

12.83 - 08.89 | OM 601.911

246-082-008-013P

SWP-M-C

Plug Number (T2): 4; T25: 140 869 02 21, etc.

**D 2.0 (201.122) (55 kW | 2.0 Litre)**

08.89 - 08.93 | OM 601.911

246-082-005-002C

SWP-M-C

Plug Number (T2): 4; T25: 124 869 03 21, etc.

**D 2.5 (201.126) (66 kW | 2.5 Litre)**

04.85 - 08.93 | OM 602.911

246-082-005-002C

SWP-M-C

Plug Number (T2): 4; T25: 124 869 03 21, etc.

04.85 - 08.93 | OM 602.911

246-082-008-013P

SWP-M-C

Plug Number (T2): 4; T25: 140 869 02 21, etc.

**D 2.5 (201.126) (69 kW | 2.5 Litre)**

08.89 - 08.93 | OM 602.911

246-082-005-002C

SWP-M-C

Plug Number (T2): 4; T25: 124 869 03 21, etc.

**E 1.8 (201.018) (80 kW | 1.8 Litre)**

04.90 - 08.93 | M 102.910

246-082-005-002C

SWP-M-C

Plug Number (T2): 4; T25: 124 869 03 21, etc.

04.90 - 08.93 | M 102.910

246-082-008-013P

SWP-M-C

Plug Number (T2): 4; T25: 140 869 02 21, etc.

**E 2.0 (201.024) (83 kW | 2.0 Litre)**

02.85 - 12.86 | M 102.961, M 102.962

246-082-005-002C

SWP-M-C

Plug Number (T2): 4; T25: 124 869 03 21, etc.

02.85 - 12.86 | M 102.961, M 102.962

246-082-008-013P

SWP-M-C

Plug Number (T2): 4; T25: 140 869 02 21, etc.

**E 2.0 (201.024) (85 kW | 2.0 Litre)**

02.85 - 12.86 | M 102.962

246-082-005-002C

SWP-M-C

Plug Number (T2): 4; T25: 124 869 03 21, etc.

02.85 - 12.86 | M 102.962

246-082-008-013P

SWP-M-C

Plug Number (T2): 4; T25: 140 869 02 21, etc.

**E 2.0 (201.024) (90 kW | 2.0 Litre)**

10.82 - 06.93 | M 102.962, M 102.961

246-082-005-002C

SWP-M-C

Plug Number (T2): 4; T25: 124 869 03 21, etc.

12.82 - 08.85 | M 102.962, M 102.961

246-082-008-013P

SWP-M-C

Plug Number (T2): 4; T25: 140 869 02 21, etc.

**E 2.0 (87 kW | 2.0 Litre)**

01.85 - 08.93 | M 102.962

246-082-005-002C

SWP-M-C

Plug Number (T2): 4; T25: 124 869 03 21, etc.

07.89 - 08.93 | M 102.962

246-082-008-013P

SWP-M-C

Plug Number (T2): 4; T25: 140 869 02 21, etc.

**E 2.0 (93 kW | 2.0 Litre)**

10.82 - 06.93 | M 102.961

246-082-005-002C

SWP-M-C

Plug Number (T2): 4; T25: 124 869 03 21, etc.

**E 2.3 (201.028) (100 kW | 2.3 Litre)**

10.86 - 08.93 | M 102.985

246-082-005-002C

SWP-M-C

Plug Number (T2): 4; T25: 124 869 03 21, etc.

**E 2.3 (97 kW | 2.3 Litre)**

09.86 - 08.91 | M 102.985

246-082-005-002C

SWP-M-C

Plug Number (T2): 4; T25: 124 869 03 21, etc.

09.86 - 08.91 | M 102.985

246-082-008-013P

SWP-M-C

Plug Number (T2): 4; T25: 140 869 02 21, etc.

**E 2.3-16 (125 kW | 2.3 Litre)**

09.85 - 12.87 | M 102.983

246-082-005-002C

SWP-M-C

Plug Number (T2): 4; T25: 124 869 03 21, etc.

09.85 - 12.87 | M 102.983

246-082-008-013P

SWP-M-C

Plug Number (T2): 4; T25: 140 869 02 21, etc.

**E 2.3-16 (130 kW | 2.3 Litre)**

09.85 - 08.88 | M 102.983

246-082-005-002C

SWP-M-C

Plug Number (T2): 4; T25: 124 869 03 21, etc.

**E 2.3-16 (201.034) (136 kW | 2.3 Litre)**

04.84 - 01.87 | M 102.983

246-082-005-002C

SWP-M-C

Plug Number (T2): 4; T25: 124 869 03 21, etc.

**E 2.5-16 (143 kW | 2.5 Litre)**

03.89 - 08.93 | M 102.991

246-082-005-002C

SWP-M-C

Plug Number (T2): 4; T25: 124 869 03 21, etc.

03.89 - 08.93 | M 102.991

246-082-008-013P

SWP-M-C

Plug Number (T2): 4; T25: 140 869 02 21, etc.

**E 2.5-16 (150 kW | 2.5 Litre)**

09.88 - 08.93 | M 102.990

246-082-005-002C

SWP-M-C

Plug Number (T2): 4; T25: 124 869 03 21, etc.

**E 2.6 (122 kW | 2.6 Litre)**

09.86 - 12.89 | M 103.942

246-082-005-002C

SWP-M-C

Plug Number (T2): 4; T25: 124 869 03 21, etc.

01.87 - 12.89 | M 103.942

246-082-008-013P

SWP-M-C

Plug Number (T2): 4; T25: 140 869 02 21, etc.

**E 2.6 (201.029) (118 kW | 2.6 Litre)**

09.86 - 08.93 | M 103.942

246-082-005-002C

SWP-M-C

Plug Number (T2): 4; T25: 124 869 03 21, etc.

07.89 - 08.93 | M 103.942

246-082-008-013P

SWP-M-C

Plug Number (T2): 4; T25: 140 869 02 21, etc.



			<b>VDO</b>		
Date	Engine Code	Chassis No.	Article No.	Product	Information

**MERCEDES-BENZ****190 (W201)****E Evolution II 2.5 (173 kW | 2.5 Litre)**

05.90 → 08.93 | M 102.992 | | 246-082-005-002C | SWP-M-C | Plug Number (T2): 4; T25: 124 869 03 21, etc.

**Turbo-D 2.5 (201.128) (90 kW | 2.5 Litre)**

02.88 → 08.93 | OM 602.961 | | 246-082-005-002C | SWP-M-C | Plug Number (T2): 4; T25: 124 869 03 21, etc.

02.88 → 08.93 | OM 602.961 | | 246-082-008-013P | SWP-M-C | Plug Number (T2): 4; T25: 140 869 02 21, etc.

**Turbo-D 2.5 (201.128) (93 kW | 2.5 Litre)**

02.88 → 08.93 | OM 602.961 | | 246-082-005-002C | SWP-M-C | Plug Number (T2): 4; T25: 124 869 03 21, etc.

**C-CLASS (W202)****C 180 (202.018) (89 kW | 1.8 Litre)**

11.94 → 05.00 | M 111.921 | →F483847 | 246-082-008-013P | SWP-M-C | Plug Number (T2): 4; T25: 140 869 02 21, etc.

11.94 → 05.00 | M 111.921 | | 246-082-008-025G | SWP-M-C |

**C 180 (202.018) (90 kW | 1.8 Litre)**

03.93 → 05.00 | M 111.920, M 111.921 | →A436535 | 246-082-008-013P | SWP-M-C | Plug Number (T2): 4; T25: 140 869 02 21, etc.

03.93 → 05.00 | M 111.920, M 111.921 | | 246-082-008-025G | SWP-M-C |

**C 200 (202.020) (100 kW | 2.0 Litre)**

01.94 → 05.00 | M 111.941, M 111.945 | →A436535 | 246-082-008-013P | SWP-M-C | Plug Number (T2): 4; T25: 140 869 02 21, etc.

01.94 → 05.00 | M 111.941, M 111.945 | | 246-082-008-025G | SWP-M-C |

**C 200 CDI (202.134) (75 kW | 2.2 Litre)**

07.98 → 05.00 | OM 611.960 | | 246-082-008-013P | SWP-M-C | Plug Number (T2): 4; T25: 140 869 02 21, etc.

03.98 → 05.00 | OM 611.960 | | 246-082-008-025G | SWP-M-C |

**C 200 D (202.120) (55 kW | 2.0 Litre)**

03.93 → 05.00 | OM 601.913 | | 246-082-008-013P | SWP-M-C | Plug Number (T2): 4; T25: 140 869 02 21, etc.

**C 200 D (202.122) (65 kW | 2.0 Litre)**

10.96 → 05.00 | OM 604.915 | | 246-082-008-013P | SWP-M-C | Plug Number (T2): 4; T25: 140 869 02 21, etc.

10.96 → 05.00 | OM 604.915 | | 246-082-008-025G | SWP-M-C |

**C 200 Kompressor (202.025) (132 kW | 2.0 Litre)**

10.95 → 05.00 | M 111.944 | →A436535 | 246-082-008-013P | SWP-M-C | Plug Number (T2): 4; T25: 140 869 02 21, etc.

10.95 → 05.00 | M 111.944 | | 246-082-008-025G | SWP-M-C |

**C 200 Kompressor (202.025) (141 kW | 2.0 Litre)**

11.96 → 05.00 | M 111.944 | | 246-082-008-013P | SWP-M-C | Plug Number (T2): 4; T25: 140 869 02 21, etc.

**C 220 (202.022) (110 kW | 2.2 Litre)**

03.93 → 05.00 | M 111.961 | →F483847 | 246-082-008-013P | SWP-M-C | Plug Number (T2): 4; T25: 140 869 02 21, etc.

03.93 → 05.00 | M 111.961 | | 246-082-008-025G | SWP-M-C |

**C 220 CDI (202.133) (92 kW | 2.2 Litre)**

03.98 → 05.00 | OM 611.960 | | 246-082-008-013P | SWP-M-C | Plug Number (T2): 4; T25: 140 869 02 21, etc.

09.97 → 05.00 | OM 611.960 | | 246-082-008-025G | SWP-M-C |

**C 220 D (202.121) (70 kW | 2.2 Litre)**

08.93 → 05.00 | OM 604.910 | | 246-082-008-013P | SWP-M-C | Plug Number (T2): 4; T25: 140 869 02 21, etc.

**C 220 D (55 kW | 2.2 Litre)**

07.96 → 05.00 | OM 604.910 | →F483847 | 246-082-008-013P | SWP-M-C | Plug Number (T2): 4; T25: 140 869 02 21, etc.

07.96 → 05.00 | OM 604.910 | | 246-082-008-025G | SWP-M-C |

**C 230 (202.023) (110 kW | 2.3 Litre)**

06.96 → 06.97 | M 111.974 | | 246-082-008-013P | SWP-M-C | Plug Number (T2): 4; T25: 140 869 02 21, etc.

**C 230 Kompressor (202.024) (142 kW | 2.3 Litre)**

10.95 → 05.00 | M 111.975 | →F483847 | 246-082-008-013P | SWP-M-C | Plug Number (T2): 4; T25: 140 869 02 21, etc.

10.95 → 05.00 | M 111.975 | | 246-082-008-025G | SWP-M-C |

**C 240 (202.026) (125 kW | 2.4 Litre)**

06.97 → 05.00 | M 112.910 | | 246-082-008-013P | SWP-M-C | Plug Number (T2): 4; T25: 140 869 02 21, etc.

06.97 → 05.00 | M 112.910 | | 246-082-008-025G | SWP-M-C |

**C 250 D (202.125) (83 kW | 2.5 Litre)**

05.93 → 05.00 | OM 605.910 | | 246-082-008-013P | SWP-M-C | Plug Number (T2): 4; T25: 140 869 02 21, etc.

**C 250 Turbo-D (202.128) (110 kW | 2.5 Litre)**

10.95 → 05.00 | OM 605.960 | →F483847 | 246-082-008-013P | SWP-M-C | Plug Number (T2): 4; T25: 140 869 02 21, etc.

10.95 → 05.00 | OM 605.960 | | 246-082-008-025G | SWP-M-C |

**C 280 (202.028) (142 kW | 2.8 Litre)**

05.93 → 05.00 | M 104.941 | →A436535 | 246-082-008-013P | SWP-M-C | Plug Number (T2): 4; T25: 140 869 02 21, etc.

05.93 → 05.00 | M 104.941 | | 246-082-008-025G | SWP-M-C |

**C 280 (202.029) (145 kW | 2.8 Litre)**

06.97 → 05.00 | M 112.920 | →F483847 | 246-082-008-013P | SWP-M-C | Plug Number (T2): 4; T25: 140 869 02 21, etc.

06.97 → 05.00 | M 112.920 | | 246-082-008-025G | SWP-M-C |

**C 36 AMG (202.028) (206 kW | 3.6 Litre)**

09.94 → 05.00 | M 104.941 (AMG 3.6) | →F483847 | 246-082-008-013P | SWP-M-C | Plug Number (T2): 4; T25: 140 869 02 21, etc.



Date	Engine Code	Chassis No.	Article No.	Product	Information

**MERCEDES-BENZ****C-CLASS (W202)****C 36 AMG (202.028) (206 kW | 3.6 Litre)**

05.94 → 05.00 | M 104.941 (AMG 3.6)

246-082-008-025G

SWP-M-C

**C 43 AMG (202.033) (225 kW | 4.3 Litre)**

10.97 → 05.00 | M 113.944

246-082-008-013P

SWP-M-C

Plug Number (T2): 4; T25: 140 869 02 21, etc.

08.97 → 05.00 | M 113.944

246-082-008-025G

SWP-M-C

**C-CLASS Estate (S202)****C 180 T (202.078) (90 kW | 1.8 Litre)**

06.96 → 09.00 | M 111.920, M 111.921

246-082-008-013P

SWP-M-C

Plug Number (T2): 4; T25: 140 869 02 21, etc.

06.96 → 09.00 | M 111.920, M 111.921

246-082-008-025G

SWP-M-C

**C 180 T (202.081) (95 kW | 2.0 Litre)**

09.00 → 03.01 | M 111.952

246-082-008-013P

SWP-M-C

Plug Number (T2): 4; T25: 140 869 02 21, etc.

09.00 → 03.01 | M 111.952

246-082-008-025G

SWP-M-C

**C 200 T (202.080) (100 kW | 2.0 Litre)**

06.96 → 03.01 | M 111.941, M 111.945

246-082-008-013P

SWP-M-C

Plug Number (T2): 4; T25: 140 869 02 21, etc.

06.96 → 03.01 | M 111.941, M 111.945

246-082-008-025G

SWP-M-C

**C 200 T CDI (202.194) (75 kW | 2.2 Litre)**

03.98 → 03.01 | OM 611.960

246-082-008-013P

SWP-M-C

Plug Number (T2): 4; T25: 140 869 02 21, etc.

03.98 → 03.01 | OM 611.960

246-082-008-025G

SWP-M-C

**C 200 T D (202.180) (65 kW | 2.0 Litre)**

10.96 → 03.01 | OM 604.915

246-082-008-013P

SWP-M-C

Plug Number (T2): 4; T25: 140 869 02 21, etc.

10.96 → 03.01 | OM 604.915

246-082-008-025G

SWP-M-C

**C 200 T Kompressor (202.087) (120 kW | 2.0 Litre)**

09.00 → 03.01 | M 111.956

246-082-008-013P

SWP-M-C

Plug Number (T2): 4; T25: 140 869 02 21, etc.

09.00 → 03.01 | M 111.956

246-082-008-025G

SWP-M-C

**C 200 T Kompressor (202.082) (141 kW | 2.0 Litre)**

11.96 → 03.01 | M 111.944

246-082-008-013P

SWP-M-C

Plug Number (T2): 4; T25: 140 869 02 21, etc.

11.96 → 03.01 | M 111.944

246-082-008-025G

SWP-M-C

**C 220 T CDI (202.193) (92 kW | 2.2 Litre)**

09.97 → 03.01 | OM 611.960

246-082-008-013P

SWP-M-C

Plug Number (T2): 4; T25: 140 869 02 21, etc.

09.97 → 03.01 | OM 611.960

246-082-008-025G

SWP-M-C

**C 220 T D (202.182) (70 kW | 2.2 Litre)**

06.96 → 09.98 | OM 604.910

246-082-008-013P

SWP-M-C

Plug Number (T2): 4; T25: 140 869 02 21, etc.

06.96 → 09.98 | OM 604.910

246-082-008-025G

SWP-M-C

**C 220 T D (55 kW | 2.2 Litre)**

06.96 → 03.01 | OM 604.910

246-082-008-013P

SWP-M-C

Plug Number (T2): 4; T25: 140 869 02 21, etc.

06.96 → 03.01 | OM 604.910

246-082-008-025G

SWP-M-C

**C 230 T (202.083) (110 kW | 2.3 Litre)**

06.96 → 06.98 | M 111.974

246-082-008-013P

SWP-M-C

Plug Number (T2): 4; T25: 140 869 02 21, etc.

06.96 → 06.98 | M 111.974

246-082-008-025G

SWP-M-C

**C 230 T Kompressor (202.085) (142 kW | 2.3 Litre)**

06.97 → 09.00 | M 111.975

246-082-008-013P

SWP-M-C

Plug Number (T2): 4; T25: 140 869 02 21, etc.

06.97 → 09.00 | M 111.975

246-082-008-025G

SWP-M-C

**C 240 T (202.086) (125 kW | 2.4 Litre)**

06.97 → 09.00 | M 112.910

246-082-008-013P

SWP-M-C

Plug Number (T2): 4; T25: 140 869 02 21, etc.

06.97 → 09.00 | M 112.910

246-082-008-025G

SWP-M-C

**C 240 T (202.088) (125 kW | 2.6 Litre)**

09.00 → 03.01 | M 112.915

246-082-008-013P

SWP-M-C

Plug Number (T2): 4; T25: 140 869 02 21, etc.

09.00 → 03.01 | M 112.915

246-082-008-025G

SWP-M-C

**C 250 T Turbo-D (202.188) (110 kW | 2.5 Litre)**

06.96 → 03.01 | OM 605.960

246-082-008-013P

SWP-M-C

Plug Number (T2): 4; T25: 140 869 02 21, etc.

06.96 → 03.01 | OM 605.960

246-082-008-025G

SWP-M-C

**C 280 T (202.089) (145 kW | 2.8 Litre)**

06.97 → 03.01 | M 112.920

246-082-008-013P

SWP-M-C

Plug Number (T2): 4; T25: 140 869 02 21, etc.

06.97 → 03.01 | M 112.920

246-082-008-025G

SWP-M-C

**C 43 AMG (202.093) (225 kW | 4.3 Litre)**

08.97 → 03.01 | M 113.944

246-082-008-013P

SWP-M-C

Plug Number (T2): 4; T25: 140 869 02 21, etc.

08.97 → 03.01 | M 113.944

246-082-008-025G

SWP-M-C

**C-CLASS (W203)****3.5 (170 kW | 3.5 Litre)**

01.05 → 02.07

246-082-008-025G

SWP-M-C



			<b>VDO</b>		
Date	Engine Code	Chassis No.	Article No.	Product	Information

**MERCEDES-BENZ****C-CLASS (W203)**

<b>C 180 (203.035) (95 kW   2.0 Litre)</b>					
10.00 - 05.02	M 111.951		246-082-008-025G	SWP-M-C	
<b>C 180 Kompressor (203.046) (105 kW   1.8 Litre)</b>					
05.02 - 02.07	M 271.946		246-082-008-025G	SWP-M-C	
<b>C 200 CDI (203.004) (85 kW   2.2 Litre)</b>					
09.00 - 02.07	OM 611.962		246-082-008-025G	SWP-M-C	
<b>C 200 CDI (203.007) (90 kW   2.2 Litre)</b>					
04.03 - 02.07	OM 646.962		246-082-008-025G	SWP-M-C	
<b>C 200 CDI (75 kW   2.2 Litre)</b>					
02.01 - 02.07	OM 646.962		246-082-008-025G	SWP-M-C	
<b>C 200 CGI Kompressor (203.043) (125 kW   1.8 Litre)</b>					
07.03 - 02.07	M 271.942		246-082-008-025G	SWP-M-C	
<b>C 200 Kompressor (203.042) (120 kW   1.8 Litre)</b>					
05.02 - 02.07	M 271.940		246-082-008-025G	SWP-M-C	
<b>C 200 Kompressor (203.045) (120 kW   2.0 Litre)</b>					
05.00 - 05.02	M 111.955		246-082-008-025G	SWP-M-C	
<b>C 220 CDI (203.006) (105 kW   2.2 Litre)</b>					
05.00 - 02.07	OM 611.962		246-082-008-025G	SWP-M-C	
<b>C 220 CDI (203.008) (110 kW   2.2 Litre)</b>					
02.04 - 02.07	OM 646.963		246-082-008-025G	SWP-M-C	
<b>C 230 (203.052) (150 kW   2.5 Litre)</b>					
01.05 - 02.07	M 272.920		246-082-008-025G	SWP-M-C	
<b>C 230 Kompressor (203.040) (141 kW   1.8 Litre)</b>					
02.04 - 02.07	M 271.948		246-082-008-025G	SWP-M-C	
<b>C 240 (203.061) (125 kW   2.6 Litre)</b>					
05.00 - 02.07	M 112.912		246-082-008-025G	SWP-M-C	
<b>C 240 4-matic (203.081) (125 kW   2.6 Litre)</b>					
07.02 - 02.07	M 112.916		246-082-008-025G	SWP-M-C	
<b>C 270 CDI (203.016) (125 kW   2.7 Litre)</b>					
12.00 - 02.07	OM 612.962		246-082-008-025G	SWP-M-C	
<b>C 280 (203.054) (170 kW   3.0 Litre)</b>					
01.05 - 02.07	M 272.940		246-082-008-025G	SWP-M-C	
<b>C 280 4-matic (203.092) (170 kW   3.0 Litre)</b>					
01.05 - 02.07	M 272.941		246-082-008-025G	SWP-M-C	
<b>C 30 CDI AMG (203.018) (170 kW   3.0 Litre)</b>					
01.03 - 02.07	OM 612.990		246-082-008-025G	SWP-M-C	
<b>C 32 AMG Kompressor (203.065) (260 kW   3.2 Litre)</b>					
02.01 - 02.07	M 112.961		246-082-008-025G	SWP-M-C	
<b>C 320 (203.064) (160 kW   3.2 Litre)</b>					
05.00 - 02.07	M 112.946		246-082-008-025G	SWP-M-C	
<b>C 320 4-matic (203.084) (160 kW   3.2 Litre)</b>					
07.02 - 02.07	M 112.953		246-082-008-025G	SWP-M-C	
<b>C 320 CDI (203.020) (165 kW   3.0 Litre)</b>					
01.05 - 02.07	OM 642.910		246-082-008-025G	SWP-M-C	
<b>C 350 (203.056) (200 kW   3.5 Litre)</b>					
01.05 - 02.07	M 272.960		246-082-008-025G	SWP-M-C	
<b>C 350 4-matic (203.087) (200 kW   3.5 Litre)</b>					
01.05 - 02.07	M 272.970		246-082-008-025G	SWP-M-C	
<b>C 55 AMG (203.076) (270 kW   5.4 Litre)</b>					
02.04 - 02.07	M 113.988		246-082-008-025G	SWP-M-C	

**C-CLASS T-Model (S203)**

<b>C 180 (203.235) (95 kW   2.0 Litre)</b>					
03.01 - 05.02	M 111.951		246-082-008-025G	SWP-M-C	
<b>C 180 Kompressor (203.246) (105 kW   1.8 Litre)</b>					
05.02 - 08.07	M 271.946		246-082-008-025G	SWP-M-C	
<b>C 200 CDI (203.204) (85 kW   2.2 Litre)</b>					
03.01 - 08.07	OM 611.962		246-082-008-025G	SWP-M-C	
<b>C 200 CDI (203.207) (90 kW   2.2 Litre)</b>					
04.03 - 08.07	OM 646.962		246-082-008-025G	SWP-M-C	
<b>C 200 CDI (75 kW   2.2 Litre)</b>					
03.01 - 08.07	OM 646.962		246-082-008-025G	SWP-M-C	





			<b>VDO</b>		
Date	Engine Code	Chassis No.	Article No.	Product	Information

**MERCEDES-BENZ****C-CLASS T-Model (S203)****C 200 CGI Kompressor (203.243) (125 kW | 1.8 Litre)**

07.03 - 08.07 | M 271.942 | 246-082-008-025G | SWP-M-C

**C 200 Kompressor (203.242) (120 kW | 1.8 Litre)**

05.02 - 08.07 | M 271.940 | 246-082-008-025G | SWP-M-C

**C 200 Kompressor (203.245) (120 kW | 2.0 Litre)**

03.01 - 05.02 | M 111.955 | 246-082-008-025G | SWP-M-C

**C 220 CDI (100 kW | 2.2 Litre)**

08.06 - 08.07 | 246-082-008-025G | SWP-M-C

**C 220 CDI (203.206) (105 kW | 2.2 Litre)**

03.01 - 08.07 | OM 611.962 | 246-082-008-025G | SWP-M-C

**C 220 CDI (203.208) (110 kW | 2.2 Litre)**

02.04 - 08.07 | OM 646.963 | 246-082-008-025G | SWP-M-C

**C 230 (203.252) (150 kW | 2.5 Litre)**

01.05 - 08.07 | M 272.920 | 246-082-008-025G | SWP-M-C

**C 230 Kompressor (203.240) (141 kW | 1.8 Litre)**

02.04 - 08.07 | M 271.948 | 246-082-008-025G | SWP-M-C

**C 240 (203.261) (125 kW | 2.6 Litre)**

03.01 - 08.07 | M 112.912 | 246-082-008-025G | SWP-M-C

**C 240 4-matic (203.281) (125 kW | 2.6 Litre)**

07.02 - 08.07 | M 112.916 | 246-082-008-025G | SWP-M-C

**C 270 CDI (203.216) (125 kW | 2.7 Litre)**

03.01 - 08.07 | OM 612.962 | 246-082-008-025G | SWP-M-C

**C 280 (203.254) (170 kW | 3.0 Litre)**

01.05 - 08.07 | M 272.940 | 246-082-008-025G | SWP-M-C

**C 280 4-matic (203.292) (170 kW | 3.0 Litre)**

01.05 - 08.07 | M 272.941 | 246-082-008-025G | SWP-M-C

**C 30 CDI AMG (203.218) (170 kW | 3.0 Litre)**

01.03 - 08.07 | OM 612.990 | 246-082-008-025G | SWP-M-C

**C 32 AMG Kompressor (203.265) (260 kW | 3.2 Litre)**

03.01 - 08.07 | M 112.961 | 246-082-008-025G | SWP-M-C

**C 320 (203.264) (160 kW | 3.2 Litre)**

03.01 - 08.07 | M 112.946 | 246-082-008-025G | SWP-M-C

**C 320 4-matic (203.284) (160 kW | 3.2 Litre)**

07.02 - 08.07 | M 112.953 | 246-082-008-025G | SWP-M-C

**C 320 CDI (203.220) (165 kW | 3.0 Litre)**

06.05 - 08.07 | OM 642.910 | 246-082-008-025G | SWP-M-C

**C 350 (203.256) (200 kW | 3.5 Litre)**

01.05 - 08.07 | M 272.960 | 246-082-008-025G | SWP-M-C

**C 350 4-matic (203.287) (200 kW | 3.5 Litre)**

01.05 - 08.07 | M 272.970 | 246-082-008-025G | SWP-M-C

**C 55 AMG (203.276) (270 kW | 5.4 Litre)**

02.04 - 08.07 | M 113.988 | 246-082-008-025G | SWP-M-C

**C-CLASS Coupe (CL203)****C 160 Kompressor (203.730) (90 kW | 1.8 Litre)**

05.02 - 06.11 | M 271.921 | 246-082-008-025G | SWP-M-C

**C 180 (203.735) (95 kW | 2.0 Litre)**

03.01 - 05.02 | M 111.951 | 246-082-008-025G | SWP-M-C

**C 180 Kompressor (203.746) (105 kW | 1.8 Litre)**

05.02 - 06.11 | M 271.946 | 246-082-008-025G | SWP-M-C

**C 200 CDI (203.707) (90 kW | 2.2 Litre)**

03.03 - 06.11 | OM 646.962 | 246-082-008-025G | SWP-M-C

**C 200 CGI Kompressor (203.743) (125 kW | 1.8 Litre)**

03.03 - 06.11 | M 271.942 | 246-082-008-025G | SWP-M-C

**C 200 Kompressor (203.742) (120 kW | 1.8 Litre)**

05.02 - 06.11 | M 271.940 | 246-082-008-025G | SWP-M-C

**C 200 Kompressor (203.745) (120 kW | 2.0 Litre)**

03.01 - 05.02 | M 111.955 | 246-082-008-025G | SWP-M-C

**C 220 CDI (203.706) (105 kW | 2.2 Litre)**

03.01 - 06.11 | OM 611.962 | 246-082-008-025G | SWP-M-C

**C 220 CDI (203.708) (110 kW | 2.2 Litre)**

02.04 - 06.11 | OM 646.963 | 246-082-008-025G | SWP-M-C



			<b>VDO</b>		
Date	Engine Code	Chassis No.	Article No.	Product	Information

**MERCEDES-BENZ****C-CLASS Coupe (CL203)**

<b>C 230 (203.752) (150 kW   2.5 Litre)</b>					
01.05 - 06.11	M 272.920		246-082-008-025G	SWP-M-C	
<b>C 230 Kompressor (203.740) (141 kW   1.8 Litre)</b>					
05.02 - 06.11	M 271.948		246-082-008-025G	SWP-M-C	
<b>C 230 Kompressor (203.747) (145 kW   2.3 Litre)</b>					
03.01 - 05.02	M 111.981		246-082-008-025G	SWP-M-C	
<b>C 30 CDI AMG (203.718) (170 kW   3.0 Litre)</b>					
09.02 - 06.11	OM 612.990		246-082-008-025G	SWP-M-C	
<b>C 32 AMG Kompressor (203.765) (260 kW   3.2 Litre)</b>					
05.02 - 06.11	M 112.961		246-082-008-025G	SWP-M-C	
<b>C 320 (203.764) (160 kW   3.2 Litre)</b>					
09.02 - 06.11	M 112.946		246-082-008-025G	SWP-M-C	
<b>C 350 (203.756) (200 kW   3.5 Litre)</b>					
01.05 - 06.11	M 272.960		246-082-008-025G	SWP-M-C	

**C CLASS (W204)**

<b>C 180 CDI (204.000) (88 kW   2.1 Litre)</b>					
01.11 -	OM 651.913		246-082-008-025G	SWP-M-C	
<b>C 180 CGI (204.049) (115 kW   1.8 Litre)</b>					
01.07 -	M 271.820		246-082-008-025G	SWP-M-C	
<b>C 180 Kompressor (204.044, 204.045) (115 kW   1.6 Litre)</b>					
01.08 -	M 271.910		246-082-008-025G	SWP-M-C	
<b>C 180 Kompressor (204.046) (115 kW   1.8 Litre)</b>					
01.07 -	M 271.952		246-082-008-025G	SWP-M-C	
<b>C 200 CDI (204.001) (100 kW   2.1 Litre)</b>					
01.11 -	OM 651.913		246-082-008-025G	SWP-M-C	
<b>C 200 CDI (204.007) (100 kW   2.1 Litre)</b>					
01.07 -	OM 646.812, OM 646.811		246-082-008-025G	SWP-M-C	
<b>C 200 CGI (204.048) (135 kW   1.8 Litre)</b>					
01.07 -	M 271.820		246-082-008-025G	SWP-M-C	
<b>C 200 Kompressor (204.041) (135 kW   1.8 Litre)</b>					
01.07 -	M 271.950		246-082-008-025G	SWP-M-C	
<b>C 220 CDI (204.002) (125 kW   2.1 Litre)</b>					
12.08 -	OM 651.911		246-082-008-025G	SWP-M-C	
<b>C 220 CDI (204.008) (125 kW   2.1 Litre)</b>					
01.07 -	OM 646.811		246-082-008-025G	SWP-M-C	
<b>C 230 (204.052) (150 kW   2.5 Litre)</b>					
01.07 -	M 272.921		246-082-008-025G	SWP-M-C	
<b>C 230 4-matic (204.085) (150 kW   2.5 Litre)</b>					
07.07 -	M 272.911		246-082-008-025G	SWP-M-C	
<b>C 250 CDI (204.003) (150 kW   2.1 Litre)</b>					
08.08 -	OM 651.911		246-082-008-025G	SWP-M-C	
<b>C 250 CDI 4-matic (204.082) (150 kW   2.1 Litre)</b>					
01.11 -	OM 651.912		246-082-008-025G	SWP-M-C	
<b>C 250 CGI (204.047) (150 kW   1.8 Litre)</b>					
07.09 -	M 271.860		246-082-008-025G	SWP-M-C	
<b>C 280 (204.054) (170 kW   3.0 Litre)</b>					
01.07 -	M 272.947		246-082-008-025G	SWP-M-C	
<b>C 280 4-matic (204.081) (170 kW   3.0 Litre)</b>					
07.07 -	M 272.948		246-082-008-025G	SWP-M-C	
<b>C 300 (204.054) (170 kW   3.0 Litre)</b>					
07.09 -	M 272.947		246-082-008-025G	SWP-M-C	
<b>C 300 4-matic (204.081) (170 kW   3.0 Litre)</b>					
07.07 -	M 272.948		246-082-008-025G	SWP-M-C	
<b>C 300 CDI 4-matic (170 kW   3.0 Litre)</b>					
01.11 -	OM 642.832		246-082-008-025G	SWP-M-C	
<b>C 320 CDI (204.022) (165 kW   3.0 Litre)</b>					
01.07 -	OM 642.960		246-082-008-025G	SWP-M-C	
<b>C 320 CDI 4-matic (204.089) (165 kW   3.0 Litre)</b>					
07.07 -	OM 642.961		246-082-008-025G	SWP-M-C	
<b>C 350 (204.056) (200 kW   3.5 Litre)</b>					
01.07 -	M 272.961		246-082-008-025G	SWP-M-C	



			<b>VDO</b>		
Date	Engine Code	Chassis No.	Article No.	Product	Information

**MERCEDES-BENZ****C CLASS (W204)****C 350 (204.057) (225 kW | 3.5 Litre)**

01.11 → M 276.957 246-082-008-025G SWP-M-C

**C 350 4-matic (204.087) (200 kW | 3.5 Litre)**

07.07 → M 272.971 246-082-008-025G SWP-M-C

**C 350 4-matic (204.088) (225 kW | 3.5 Litre)**

01.11 → M 276.957 246-082-008-025G SWP-M-C

**C 350 CDI (204.022) (165 kW | 3.0 Litre)**

07.09 → OM 642.960 246-082-008-025G SWP-M-C

**C 350 CDI (204.023) (195 kW | 3.0 Litre)**

06.11 → OM 642.834 246-082-008-025G SWP-M-C

**C 350 CDI (204.025) (170 kW | 3.0 Litre)**

10.09 → OM 642.830 246-082-008-025G SWP-M-C

**C 350 CDI 4-matic (204.089) (165 kW | 3.0 Litre)**

07.09 → OM 642.961 246-082-008-025G SWP-M-C

**C 350 CDI 4-matic (204.092) (170 kW | 3.0 Litre)**

10.09 → OM 642.832 246-082-008-025G SWP-M-C

**C 350 CGI (204.065) (215 kW | 3.5 Litre)**

09.08 → M 272.982 246-082-008-025G SWP-M-C

09.08 → M 272.982 246-083-002-022G SWP-D-C

**C 63 AMG (204.077) (336 kW | 6.2 Litre)**

02.08 → M 156.985 246-082-008-025G SWP-M-C

**C CLASS T-Model (S204)****C 220 CDI (204.202) (125 kW | 2.1 Litre)**

12.08 → OM 651.911 246-083-002-022G SWP-D-C

**C 350 CDI (204.225) (170 kW | 3.0 Litre)**

10.09 → OM 642.830 246-083-002-022G SWP-D-C

**C 350 CDI 4-matic (204.292) (170 kW | 3.0 Litre)**

10.09 → OM 642.832 246-083-002-022G SWP-D-C

**C-CLASS Coupe (C204)****C 180 (204.349) (115 kW | 1.8 Litre)**

06.11 → M 271.820 246-082-008-025G SWP-M-C

**C 220 CDI (204.302) (125 kW | 2.1 Litre)**

06.11 → OM 651.911 246-082-008-025G SWP-M-C

**C 250 (204.347) (150 kW | 1.8 Litre)**

06.11 → M 271.860 246-082-008-025G SWP-M-C

**C 250 CDI (204.303) (150 kW | 2.1 Litre)**

06.11 → OM 651.911 246-082-008-025G SWP-M-C

**C 350 (204.357) (225 kW | 3.5 Litre)**

06.11 → M 276.957 246-082-008-025G SWP-M-C

**C 63 AMG (204.377) (336 kW | 6.2 Litre)**

06.11 → M 156.985 246-082-008-025G SWP-M-C

**CLK (C208)****200 (208.335) (100 kW | 2.0 Litre)**

06.97 → 06.02 M 111.941, M 111.945 246-082-008-025G SWP-M-C

**200 Kompressor (208.344) (120 kW | 2.0 Litre)**

06.00 → 06.02 M 111.956 246-082-008-025G SWP-M-C

**200 Kompressor (208.345) (141 kW | 2.0 Litre)**

06.97 → 06.00 M 111.944 246-082-008-025G SWP-M-C

**230 Kompressor (208.347) (142 kW | 2.3 Litre)**

06.97 → 06.00 M 111.973, M 111.975 246-082-008-025G SWP-M-C

**230 Kompressor (208.348) (145 kW | 2.3 Litre)**

06.00 → 06.02 M 111.982 246-082-008-025G SWP-M-C

**320 (208.365) (160 kW | 3.2 Litre)**

06.97 → 06.02 M 112.940 246-082-008-025G SWP-M-C

**430 (208.370) (205 kW | 4.3 Litre)**

07.98 → 06.02 M 113.943 246-082-008-025G SWP-M-C

**55 AMG (208.374) (255 kW | 5.4 Litre)**

08.99 → 06.02 M 113.981, M 113.984 246-082-008-025G SWP-M-C



			<b>VDO</b>	
Date	Engine Code	Chassis No.	Article No.	Product

**MERCEDES-BENZ****CLK Convertible (A208)****200 Kompressor (208.444) (120 kW | 2.0 Litre)**

06.00 - 03.02 | M 111.956 | 246-082-008-025G | SWP-M-C

**230 Kompressor (208.448) (145 kW | 2.3 Litre)**

06.00 - 03.02 | M 111.982 | 246-082-008-025G | SWP-M-C

**320 (208.465) (160 kW | 3.2 Litre)**

03.98 - 03.02 | M 112.940 | 246-082-008-025G | SWP-M-C

**CLK (C209)****200 CGI (209.343) (125 kW | 1.8 Litre)**

07.03 - 05.09 | M 271.942 | 246-082-008-025G | SWP-M-C

**200 Kompressor (209.341) (135 kW | 1.8 Litre)**

10.06 - 05.09 | M 271.955 | 246-082-008-025G | SWP-M-C

**200 Kompressor (209.342) (120 kW | 1.8 Litre)**

09.02 - 05.09 | M 271.940 | 246-082-008-025G | SWP-M-C

**220 CDI (209.308) (110 kW | 2.2 Litre)**

01.05 - 05.09 | OM 646.966 | 246-082-008-025G | SWP-M-C

**240 (209.361) (125 kW | 2.6 Litre)**

06.02 - 05.09 | M 112.912 | 246-082-008-025G | SWP-M-C

**270 CDI (209.316) (125 kW | 2.7 Litre)**

10.02 - 05.09 | OM 612.962, OM 612.967 | 246-082-008-025G | SWP-M-C

**280 (209.354) (170 kW | 3.0 Litre)**

01.05 - 05.09 | M 272.940 | 246-082-008-025G | SWP-M-C

**320 (209.365) (160 kW | 3.2 Litre)**

06.02 - 05.09 | M 112.955 | 246-082-008-025G | SWP-M-C

**320 CDI (209.320) (165 kW | 3.0 Litre)**

01.05 - 05.09 | OM 642.910 | 246-082-008-025G | SWP-M-C

**350 (209.356) (200 kW | 3.5 Litre)**

01.05 - 05.09 | M 272.960 | 246-082-008-025G | SWP-M-C

**500 (209.372) (285 kW | 5.5 Litre)**

06.06 - 05.09 | M 273.965 | 246-082-008-025G | SWP-M-C

**500 (209.375) (225 kW | 5.0 Litre)**

06.02 - 05.09 | M 113.968 | 246-082-008-025G | SWP-M-C

**55 AMG (209.376) (270 kW | 5.4 Litre)**

09.02 - 05.09 | M 113.987 | 246-082-008-025G | SWP-M-C

**63 AMG (209.377) (354 kW | 6.2 Litre)**

04.06 - 05.09 | M 156.982 | 246-082-008-025G | SWP-M-C

**63 AMG (209.377) (373 kW | 6.2 Litre)**

05.07 - 05.09 | M 156.982 | 246-082-008-025G | SWP-M-C

**CLK DTM AMG (428 kW | 5.4 Litre)**

06.04 - 05.09 | M 113.994 | 246-082-008-025G | SWP-M-C

**CLK Convertible (A209)****200 Kompressor (209.441) (135 kW | 1.8 Litre)**

10.06 - 03.10 | M 271.955 | 246-082-008-025G | SWP-M-C

**200 Kompressor (209.442) (120 kW | 1.8 Litre)**

02.03 - 03.10 | M 271.940 | 246-082-008-025G | SWP-M-C

**240 (209.461) (125 kW | 2.6 Litre)**

02.03 - 03.10 | M 112.912 | 246-082-008-025G | SWP-M-C

**280 (209.454) (170 kW | 3.0 Litre)**

01.05 - 03.10 | M 272.940 | 246-082-008-025G | SWP-M-C

**320 (209.465) (160 kW | 3.2 Litre)**

02.03 - 03.10 | M 112.955 | 246-082-008-025G | SWP-M-C

**320 CDI (209.420) (165 kW | 3.0 Litre)**

03.05 - 03.10 | OM 642.910 | 246-082-008-025G | SWP-M-C

**350 (209.456) (200 kW | 3.5 Litre)**

01.05 - 03.10 | M 272.960 | 246-082-008-025G | SWP-M-C

**500 (209.472) (285 kW | 5.5 Litre)**

06.06 - 03.10 | M 273.967 | 246-082-008-025G | SWP-M-C

**500 (209.475) (225 kW | 5.0 Litre)**

02.03 - 03.10 | M 113.968 | 246-082-008-025G | SWP-M-C

**55 AMG (209.476) (270 kW | 5.5 Litre)**

02.03 - 03.10 | M 113.987 | 246-082-008-025G | SWP-M-C



			<b>VDO</b>		
Date	Engine Code	Chassis No.	Article No.	Product	Information

**MERCEDES-BENZ****CLK Convertible (A209)****63 AMG (209.477) (354 kW | 6.2 Litre)**

04.06 → 03.10 | M 156.982

246-082-008-025G

SWP-M-C

**AMG DTM (428 kW | 5.4 Litre)**

06.04 → 03.10 | M 113.994

246-082-008-025G

SWP-M-C

**CLS (C219)****280 (219.354) (170 kW | 3.0 Litre)**

07.08 → 12.10 | M 272.943

246-082-008-025G

SWP-M-C

**300 (219.354) (170 kW | 3.0 Litre)**

04.09 → 12.10 | M 272.943

246-082-008-025G

SWP-M-C

**320 CDI (219.322) (165 kW | 3.0 Litre)**

01.05 → 12.10 | OM 642.920

246-082-008-025G

SWP-M-C

**350 (219.356) (200 kW | 3.5 Litre)**

10.04 → 12.10 | M 272.964

246-082-008-025G

SWP-M-C

**350 (219.357) (215 kW | 3.5 Litre)**

04.06 → 12.10 | M 272.985

246-082-008-025G

SWP-M-C

**350 CDI (219.322) (165 kW | 3.0 Litre)**

04.09 → 12.10 | OM 642.920

246-082-008-025G

SWP-M-C

**350 CGI (219.357) (215 kW | 3.5 Litre)**

04.09 → 12.10 | M 272.985

246-082-008-025G

SWP-M-C

**500 (219.372) (285 kW | 5.5 Litre)**

04.06 → 12.10 | M 273.960

246-082-008-025G

SWP-M-C

**500 (219.375) (225 kW | 5.0 Litre)**

10.04 → 12.10 | M 113.967

246-082-008-025G

SWP-M-C

**CLS 55 AMG (219.376) (350 kW | 5.4 Litre)**

01.05 → 12.10 | M 113.990

246-082-008-025G

SWP-M-C

**CLS 63 AMG (219.377) (378 kW | 6.2 Litre)**

04.06 → 12.10 | M 156.983

246-082-008-025G

SWP-M-C

**Saloon (W124)****200 (124.020) (75 kW | 2.0 Litre)**

01.86 → 05.90 | M 102.922

246-082-005-002C

SWP-M-C

Plug Number (T2): 4; T25: 124 869 03 21, etc.

01.86 → 02.90 | M 102.922

246-082-008-013P

SWP-M-C

Plug Number (T2): 4; T25: 140 869 02 21, etc.

**200 (124.020) (80 kW | 2.0 Litre)**

12.85 → 05.90 | M 102.922

246-082-005-002C

SWP-M-C

Plug Number (T2): 4; T25: 124 869 03 21, etc.

**200 (77 kW | 2.0 Litre)**

01.86 → 05.90 | M 102.922

246-082-005-002C

SWP-M-C

Plug Number (T2): 4; T25: 124 869 03 21, etc.

**200 D (124.120) (53 kW | 2.0 Litre)**

12.84 → 08.89 | OM 601.912

246-082-005-002C

SWP-M-C

Plug Number (T2): 4; T25: 124 869 03 21, etc.

12.84 → 08.89 | OM 601.912

246-082-008-013P

SWP-M-C

Plug Number (T2): 4; T25: 140 869 02 21, etc.

**200 D (124.120) (55 kW | 2.0 Litre)**

08.89 → 06.93 | OM 601.912

246-082-005-002C

SWP-M-C

Plug Number (T2): 4; T25: 124 869 03 21, etc.

**200 E (124.019) (100 kW | 2.0 Litre)**

10.92 → 06.93 | M 111.940

246-082-005-002C

SWP-M-C

Plug Number (T2): 4; T25: 124 869 03 21, etc.

10.92 → 06.93 | M 111.940

246-082-008-013P

SWP-M-C

Plug Number (T2): 4; T25: 140 869 02 21, etc.

**200 E (124.021) (87 kW | 2.0 Litre)**

09.88 → 08.92 | M 102.963

246-082-005-002C

SWP-M-C

Plug Number (T2): 4; T25: 124 869 03 21, etc.

09.88 → 08.92 | M 102.963

246-082-008-013P

SWP-M-C

Plug Number (T2): 4; T25: 140 869 02 21, etc.

**200 E (124.021) (90 kW | 2.0 Litre)**

09.88 → 12.89 | M 102.963

246-082-005-002C

SWP-M-C

Plug Number (T2): 4; T25: 124 869 03 21, etc.

**220 E (124.022) (110 kW | 2.2 Litre)**

10.92 → 06.93 | M 111.960

246-082-005-002C

SWP-M-C

Plug Number (T2): 4; T25: 124 869 03 21, etc.

10.92 → 06.93 | M 111.960

246-082-008-013P

SWP-M-C

Plug Number (T2): 4; T25: 140 869 02 21, etc.

**230 E (124.023) (100 kW | 2.3 Litre)**

01.85 → 06.93 | M 102.982

246-082-005-002C

SWP-M-C

Plug Number (T2): 4; T25: 124 869 03 21, etc.

**230 E (124.023) (97 kW | 2.3 Litre)**

12.84 → 03.92 | M 102.982

246-082-005-002C

SWP-M-C

Plug Number (T2): 4; T25: 124 869 03 21, etc.

**230 E (124.023) CAT (97 kW | 2.3 Litre)**

06.89 → 06.93 | M 102.982

246-082-005-002C

SWP-M-C

Plug Number (T2): 4; T25: 124 869 03 21, etc.

06.89 → 09.92 | M 102.982

246-082-008-013P

SWP-M-C

Plug Number (T2): 4; T25: 140 869 02 21, etc.

**250 D (124.125) (66 kW | 2.5 Litre)**

04.85 → 06.93 | OM 602.912

246-082-005-002C

SWP-M-C

Plug Number (T2): 4; T25: 124 869 03 21, etc.

04.85 → 06.93 | OM 602.912

246-082-008-013P

SWP-M-C

Plug Number (T2): 4; T25: 140 869 02 21, etc.



			<b>VDO</b>		
Date	Engine Code	Chassis No.	Article No.	Product	Information

**MERCEDES-BENZ****Saloon (W124)**

<b>250 D (124.125) (69 kW   2.5 Litre)</b>					
01.89 - 06.93	OM 602.912		246-082-005-002C	SWP-M-C	Plug Number (T2): 4; T25: 124 869 03 21, etc.
<b>250 Turbo-D (124.128) (93 kW   2.5 Litre)</b>					
09.88 - 06.93	OM 602.962		246-082-005-002C	SWP-M-C	Plug Number (T2): 4; T25: 124 869 03 21, etc.
09.88 - 06.93	OM 602.962		246-082-008-013P	SWP-M-C	Plug Number (T2): 4; T25: 140 869 02 21, etc.
<b>260 E (124.026) (118 kW   2.6 Litre)</b>					
09.85 - 08.92	M 103.940		246-082-005-002C	SWP-M-C	Plug Number (T2): 4; T25: 124 869 03 21, etc.
09.85 - 08.92	M 103.940		246-082-008-013P	SWP-M-C	Plug Number (T2): 4; T25: 140 869 02 21, etc.
<b>260 E (124.026) (122 kW   2.6 Litre)</b>					
09.85 - 12.89	M 103.940		246-082-005-002C	SWP-M-C	Plug Number (T2): 4; T25: 124 869 03 21, etc.
<b>260 E 4-matic (124.226) (118 kW   2.6 Litre)</b>					
09.86 - 08.92	M 103.943		246-082-005-002C	SWP-M-C	Plug Number (T2): 4; T25: 124 869 03 21, etc.
09.86 - 08.92	M 103.943		246-082-008-013P	SWP-M-C	Plug Number (T2): 4; T25: 140 869 02 21, etc.
<b>260 E 4-matic (124.226) (122 kW   2.6 Litre)</b>					
12.86 - 12.89	M 103.940		246-082-005-002C	SWP-M-C	Plug Number (T2): 4; T25: 124 869 03 21, etc.
12.86 - 12.89	M 103.940		246-082-008-013P	SWP-M-C	Plug Number (T2): 4; T25: 140 869 02 21, etc.
<b>280 E (124.028) (145 kW   2.8 Litre)</b>					
10.92 - 06.93	M 104.942		246-082-005-002C	SWP-M-C	Plug Number (T2): 4; T25: 124 869 03 21, etc.
10.92 - 06.93	M 104.942		246-082-008-013P	SWP-M-C	Plug Number (T2): 4; T25: 140 869 02 21, etc.
<b>300 D (124.130) (80 kW   3.0 Litre)</b>					
12.84 - 08.89	OM 603.912		246-082-005-002C	SWP-M-C	Plug Number (T2): 4; T25: 124 869 03 21, etc.
12.84 - 08.89	OM 603.912		246-082-008-013P	SWP-M-C	Plug Number (T2): 4; T25: 140 869 02 21, etc.
<b>300 D (124.130) (81 kW   3.0 Litre)</b>					
06.90 - 06.93	OM 603.912		246-082-005-002C	SWP-M-C	Plug Number (T2): 4; T25: 124 869 03 21, etc.
<b>300 D (124.130) (83 kW   3.0 Litre)</b>					
08.89 - 06.93	OM 603.912		246-082-005-002C	SWP-M-C	Plug Number (T2): 4; T25: 124 869 03 21, etc.
<b>300 D 4-matic (124.330) (80 kW   3.0 Litre)</b>					
09.86 - 08.92	OM 603.913		246-082-005-002C	SWP-M-C	Plug Number (T2): 4; T25: 124 869 03 21, etc.
09.86 - 08.92	OM 603.913		246-082-008-013P	SWP-M-C	Plug Number (T2): 4; T25: 140 869 02 21, etc.
<b>300 D 4-matic (124.330) (83 kW   3.0 Litre)</b>					
08.89 - 06.93	OM 603.913		246-082-005-002C	SWP-M-C	Plug Number (T2): 4; T25: 124 869 03 21, etc.
<b>300 E (124.030) (132 kW   3.0 Litre)</b>					
08.85 - 08.92	M 103.983		246-082-005-002C	SWP-M-C	Plug Number (T2): 4; T25: 124 869 03 21, etc.
08.85 - 08.92	M 103.983		246-082-008-013P	SWP-M-C	Plug Number (T2): 4; T25: 140 869 02 21, etc.
<b>300 E (138 kW   3.0 Litre)</b>					
01.85 - 12.85	M 103.980		246-082-005-002C	SWP-M-C	Plug Number (T2): 4; T25: 124 869 03 21, etc.
06.85 - 08.92	M 103.983		246-082-005-002C	SWP-M-C	Plug Number (T2): 4; T25: 124 869 03 21, etc.
03.85 - 08.85	M 103.980		246-082-008-013P	SWP-M-C	Plug Number (T2): 4; T25: 140 869 02 21, etc.
<b>300 E 4-matic (124.230) (132 kW   3.0 Litre)</b>					
09.86 - 06.93	M 103.985		246-082-005-002C	SWP-M-C	Plug Number (T2): 4; T25: 124 869 03 21, etc.
11.86 - 09.92	M 103.985		246-082-008-013P	SWP-M-C	Plug Number (T2): 4; T25: 140 869 02 21, etc.
<b>300 E 4-matic (138 kW   3.0 Litre)</b>					
09.86 - 02.92	M 103.983		246-082-005-002C	SWP-M-C	Plug Number (T2): 4; T25: 124 869 03 21, etc.
<b>300 E-24 (124.031) (162 kW   3.0 Litre)</b>					
09.88 - 08.92	M 104.980		246-082-005-002C	SWP-M-C	Plug Number (T2): 4; T25: 124 869 03 21, etc.
07.89 - 08.92	M 104.980		246-082-008-013P	SWP-M-C	Plug Number (T2): 4; T25: 140 869 02 21, etc.
<b>300 Turbo-D (124.133) (105 kW   3.0 Litre)</b>					
09.86 - 09.88	OM 603.963, OM 603.960		246-082-005-002C	SWP-M-C	Plug Number (T2): 4; T25: 124 869 03 21, etc.
09.87 - 09.88	OM 603.963, OM 603.960		246-082-008-013P	SWP-M-C	Plug Number (T2): 4; T25: 140 869 02 21, etc.
<b>300 Turbo-D (124.133) (108 kW   3.0 Litre)</b>					
09.88 - 06.93	OM 603.960		246-082-005-002C	SWP-M-C	Plug Number (T2): 4; T25: 124 869 03 21, etc.
<b>300 Turbo-D 4-matic (124.333) (105 kW   3.0 Litre)</b>					
09.86 - 09.88	OM 603.963, OM 603.960		246-082-005-002C	SWP-M-C	Plug Number (T2): 4; T25: 124 869 03 21, etc.
<b>300 Turbo-D 4-matic (124.333) (108 kW   3.0 Litre)</b>					
01.88 - 06.93	OM 603.963		246-082-005-002C	SWP-M-C	Plug Number (T2): 4; T25: 124 869 03 21, etc.
<b>320 E (124.032) (162 kW   3.2 Litre)</b>					
10.92 - 06.93	M 104.992		246-082-005-002C	SWP-M-C	Plug Number (T2): 4; T25: 124 869 03 21, etc.
10.92 - 06.93	M 104.992		246-082-008-013P	SWP-M-C	Plug Number (T2): 4; T25: 140 869 02 21, etc.
<b>400 E 4.2 (124.034) (205 kW   4.2 Litre)</b>					
10.92 - 06.93	M 119.975		246-082-005-002C	SWP-M-C	Plug Number (T2): 4; T25: 124 869 03 21, etc.
10.92 - 06.93	M 119.975		246-082-008-013P	SWP-M-C	Plug Number (T2): 4; T25: 140 869 02 21, etc.
<b>500 E (124.036) (240 kW   5.0 Litre)</b>					
01.91 - 06.93	M 119.974		246-082-005-002C	SWP-M-C	Plug Number (T2): 4; T25: 124 869 03 21, etc.



			<b>VDO</b>		
Date	Engine Code	Chassis No.	Article No.	Product	Information

**MERCEDES-BENZ****Saloon (W124)****500 E (124.036) (240 kW | 5.0 Litre)**

01.91 - 06.93	M 119.974		246-082-008-013P	SWP-M-C	Plug Number (T2): 4; T25: 140 869 02 21, etc.
---------------	-----------	--	------------------	---------	-----------------------------------------------

**KOMBI Estate (S124)****200 T (124.080) (77 kW | 2.0 Litre)**

01.86 - 05.90	M 102.922		246-082-005-002C	SWP-M-C	Plug Number (T2): 4; T25: 124 869 03 21, etc.
03.86 - 02.90	M 102.922		246-082-008-013P	SWP-M-C	Plug Number (T2): 4; T25: 140 869 02 21, etc.

**200 T (124.080) (80 kW | 2.0 Litre)**

09.85 - 08.89	M 102.922		246-082-005-002C	SWP-M-C	Plug Number (T2): 4; T25: 124 869 03 21, etc.
---------------	-----------	--	------------------	---------	-----------------------------------------------

**200 T D (124.180) (53 kW | 2.0 Litre)**

09.85 - 08.91	OM 601.912		246-082-005-002C	SWP-M-C	Plug Number (T2): 4; T25: 124 869 03 21, etc.
03.86 - 08.91	OM 601.912		246-082-008-013P	SWP-M-C	Plug Number (T2): 4; T25: 140 869 02 21, etc.

**200 T D (124.180) (55 kW | 2.0 Litre)**

09.88 - 08.91	OM 601.912		246-082-005-002C	SWP-M-C	Plug Number (T2): 4; T25: 124 869 03 21, etc.
---------------	------------	--	------------------	---------	-----------------------------------------------

**200 TE (124.079) (100 kW | 2.0 Litre)**

10.92 - 06.93	M 111.940		246-082-005-002C	SWP-M-C	Plug Number (T2): 4; T25: 124 869 03 21, etc.
10.92 - 06.93	M 111.940		246-082-008-013P	SWP-M-C	Plug Number (T2): 4; T25: 140 869 02 21, etc.

**200 TE (124.081) (87 kW | 2.0 Litre)**

09.88 - 08.92	M 102.963		246-082-005-002C	SWP-M-C	Plug Number (T2): 4; T25: 124 869 03 21, etc.
10.88 - 08.92	M 102.963		246-082-008-013P	SWP-M-C	Plug Number (T2): 4; T25: 140 869 02 21, etc.

**200 TE (90 kW | 2.0 Litre)**

09.88 - 12.89	M 102.962		246-082-005-002C	SWP-M-C	Plug Number (T2): 4; T25: 124 869 03 21, etc.
---------------	-----------	--	------------------	---------	-----------------------------------------------

**220 TE (124.082) (110 kW | 2.2 Litre)**

10.92 - 05.93	M 111.960		246-082-005-002C	SWP-M-C	Plug Number (T2): 4; T25: 124 869 03 21, etc.
10.92 - 05.93	M 111.960		246-082-008-013P	SWP-M-C	Plug Number (T2): 4; T25: 140 869 02 21, etc.

**230 TE (124.083) (100 kW | 2.3 Litre)**

09.85 - 08.92	M 102.982		246-082-005-002C	SWP-M-C	Plug Number (T2): 4; T25: 124 869 03 21, etc.
---------------	-----------	--	------------------	---------	-----------------------------------------------

**230 TE (124.083) (97 kW | 2.3 Litre)**

09.85 - 08.92	M 102.982		246-082-005-002C	SWP-M-C	Plug Number (T2): 4; T25: 124 869 03 21, etc.
03.86 - 08.92	M 102.982		246-082-008-013P	SWP-M-C	Plug Number (T2): 4; T25: 140 869 02 21, etc.

**230 TE (124.083) CAT (97 kW | 2.3 Litre)**

06.89 - 08.92	M 102.982		246-082-005-002C	SWP-M-C	Plug Number (T2): 4; T25: 124 869 03 21, etc.
---------------	-----------	--	------------------	---------	-----------------------------------------------

**250 T D (124.185) (66 kW | 2.5 Litre)**

09.85 - 06.93	OM 602.912		246-082-005-002C	SWP-M-C	Plug Number (T2): 4; T25: 124 869 03 21, etc.
03.86 - 06.93	OM 602.912		246-082-008-013P	SWP-M-C	Plug Number (T2): 4; T25: 140 869 02 21, etc.

**250 T D (124.185) (69 kW | 2.5 Litre)**

01.89 - 06.93	OM 602.912		246-082-005-002C	SWP-M-C	Plug Number (T2): 4; T25: 124 869 03 21, etc.
09.89 - 06.93	OM 602.912		246-082-008-013P	SWP-M-C	Plug Number (T2): 4; T25: 140 869 02 21, etc.

**260 TE FGST. (118 kW | 2.6 Litre)**

09.89 - 08.92	M 103.940		246-082-005-002C	SWP-M-C	Plug Number (T2): 4; T25: 124 869 03 21, etc.
---------------	-----------	--	------------------	---------	-----------------------------------------------

**260 TE FGST. (122 kW | 2.6 Litre)**

09.85 - 12.89	M 103.940		246-082-005-002C	SWP-M-C	Plug Number (T2): 4; T25: 124 869 03 21, etc.
---------------	-----------	--	------------------	---------	-----------------------------------------------

**280 TE (124.088) (145 kW | 2.8 Litre)**

10.92 - 06.93	M 104.942		246-082-005-002C	SWP-M-C	Plug Number (T2): 4; T25: 124 869 03 21, etc.
10.92 - 06.93	M 104.942		246-082-008-013P	SWP-M-C	Plug Number (T2): 4; T25: 140 869 02 21, etc.

**300 T D (124.190) (80 kW | 3.0 Litre)**

09.86 - 06.93	OM 603.912		246-082-005-002C	SWP-M-C	Plug Number (T2): 4; T25: 124 869 03 21, etc.
09.86 - 06.93	OM 603.912		246-082-008-013P	SWP-M-C	Plug Number (T2): 4; T25: 140 869 02 21, etc.

**300 T D (124.190) (81 kW | 3.0 Litre)**

01.89 - 06.93	OM 603.912		246-082-005-002C	SWP-M-C	Plug Number (T2): 4; T25: 124 869 03 21, etc.
---------------	------------	--	------------------	---------	-----------------------------------------------

**300 T D (124.190) (83 kW | 3.0 Litre)**

01.89 - 06.93	OM 603.912		246-082-005-002C	SWP-M-C	Plug Number (T2): 4; T25: 124 869 03 21, etc.
---------------	------------	--	------------------	---------	-----------------------------------------------

**300 T Turbo-D (105 kW | 3.0 Litre)**

09.86 - 01.89	OM 603.963, OM 603.960		246-082-005-002C	SWP-M-C	Plug Number (T2): 4; T25: 124 869 03 21, etc.
09.86 - 01.89	OM 603.963, OM 603.960		246-082-008-013P	SWP-M-C	Plug Number (T2): 4; T25: 140 869 02 21, etc.

**300 T Turbo-D (124.193) (108 kW | 3.0 Litre)**

01.89 - 06.93	OM 603.960		246-082-005-002C	SWP-M-C	Plug Number (T2): 4; T25: 124 869 03 21, etc.
01.89 - 06.93	OM 603.960		246-082-008-013P	SWP-M-C	Plug Number (T2): 4; T25: 140 869 02 21, etc.

**300 T Turbo-D 4-matic (124.393) (105 kW | 3.0 Litre)**

09.86 - 01.89	OM 603.963		246-082-005-002C	SWP-M-C	Plug Number (T2): 4; T25: 124 869 03 21, etc.
---------------	------------	--	------------------	---------	-----------------------------------------------

**300 T Turbo-D 4-matic (124.393) (108 kW | 3.0 Litre)**

01.89 - 06.93	OM 603.960		246-082-005-002C	SWP-M-C	Plug Number (T2): 4; T25: 124 869 03 21, etc.
---------------	------------	--	------------------	---------	-----------------------------------------------



			<b>VDO</b>		
Date	Engine Code	Chassis No.	Article No.	Product	Information

**MERCEDES-BENZ****KOMBI Estate (S124)****300 TE (124.090) (132 kW | 3.0 Litre)**

01.86 - 08.92	M 103.983		246-082-005-002C	SWP-M-C	Plug Number (T2): 4; T25: 124 869 03 21, etc.
03.86 - 08.92	M 103.983		246-082-008-013P	SWP-M-C	Plug Number (T2): 4; T25: 140 869 02 21, etc.

**300 TE (124.090) (138 kW | 3.0 Litre)**

01.86 - 12.89	M 103.983		246-082-005-002C	SWP-M-C	Plug Number (T2): 4; T25: 124 869 03 21, etc.
---------------	-----------	--	------------------	---------	-----------------------------------------------

**300 TE 4-matic (124.290) (132 kW | 3.0 Litre)**

09.86 - 06.93	M 103.985		246-082-005-002C	SWP-M-C	Plug Number (T2): 4; T25: 124 869 03 21, etc.
11.86 - 06.93	M 103.985		246-082-008-013P	SWP-M-C	Plug Number (T2): 4; T25: 140 869 02 21, etc.

**300 TE 4-matic (124.290) (138 kW | 3.0 Litre)**

09.86 - 12.89	M 103.983		246-082-005-002C	SWP-M-C	Plug Number (T2): 4; T25: 124 869 03 21, etc.
---------------	-----------	--	------------------	---------	-----------------------------------------------

**300 TE-24 (124.091) (162 kW | 3.0 Litre)**

09.89 - 08.92	M 104.980		246-082-005-002C	SWP-M-C	Plug Number (T2): 4; T25: 124 869 03 21, etc.
09.89 - 08.92	M 104.980		246-082-008-013P	SWP-M-C	Plug Number (T2): 4; T25: 140 869 02 21, etc.

**320 TE (124.092) (162 kW | 3.2 Litre)**

10.92 - 06.93	M 104.992		246-082-005-002C	SWP-M-C	Plug Number (T2): 4; T25: 124 869 03 21, etc.
10.92 - 06.93	M 104.992		246-082-008-013P	SWP-M-C	Plug Number (T2): 4; T25: 140 869 02 21, etc.

**CABRIOLET (A124)****300 CE-24 (124.061) (162 kW | 3.0 Litre)**

04.92 - 06.93	M 104.980		246-082-005-002C	SWP-M-C	Plug Number (T2): 4; T25: 124 869 03 21, etc.
04.92 - 06.93	M 104.980		246-082-008-013P	SWP-M-C	Plug Number (T2): 4; T25: 140 869 02 21, etc.

**170 (W170)****D (29 kW | 1.7 Litre)**

06.49 - 10.56	OM 636.915		246-082-008-025G	SWP-M-C	
---------------	------------	--	------------------	---------	--

**S (38 kW | 1.8 Litre)**

05.49 - 10.56	M 136.922		246-082-008-025G	SWP-M-C	
---------------	-----------	--	------------------	---------	--

**S-D (29 kW | 1.8 Litre)**

07.53 - 02.58	OM 636.931		246-082-008-025G	SWP-M-C	
---------------	------------	--	------------------	---------	--

**V (33 kW | 1.7 Litre)**

06.46 - 05.50	M 136.920		246-082-008-025G	SWP-M-C	
---------------	-----------	--	------------------	---------	--

**/8 (W114)****230.6 (114.015) (88 kW | 2.3 Litre)**

01.68 - 11.76	M 180.954		246-069-026-001G	N	
---------------	-----------	--	------------------	---	--

**250 (96 kW | 2.5 Litre)**

07.68 - 08.72	M 114.920		246-075-017-002C	SWP-M-G	Plug Number (T2): 4
07.68 - 08.72	M 114.920		246-075-021-007C	SWP-M-G	Plug Number (T2): 1; T25: A000 869 30 21

**250 2.8 (114.023) (96 kW | 2.7 Litre)**

06.72 - 11.76	M 130.923		246-075-017-002C	SWP-M-G	Plug Number (T2): 4
06.72 - 11.76	M 130.923		246-075-021-007C	SWP-M-G	Plug Number (T2): 1; T25: A000 869 30 21

**280 E (114.062) (136 kW | 2.7 Litre)**

07.74 - 11.76	M 110.981		246-082-008-013P	SWP-M-C	Plug Number (T2): 4; T25: 140 869 02 21, etc.
---------------	-----------	--	------------------	---------	-----------------------------------------------

**/8 Coupe (W114)****250 C (114.021) (96 kW | 2.5 Litre)**

04.69 - 06.72	M 114.920		246-075-017-002C	SWP-M-G	Plug Number (T2): 4
04.69 - 06.72	M 114.920		246-075-021-007C	SWP-M-G	Plug Number (T2): 1; T25: A000 869 30 21

**250 C 2.8 (114.023) (96 kW | 2.7 Litre)**

06.72 - 11.76	M 130.923		246-075-017-002C	SWP-M-G	Plug Number (T2): 4
06.72 - 11.76	M 130.923		246-075-021-007C	SWP-M-G	Plug Number (T2): 1; T25: A000 869 30 21

**250 CE (114.022) (110 kW | 2.5 Litre)**

04.69 - 04.72	M 114.980		246-075-017-002C	SWP-M-G	Plug Number (T2): 4
04.69 - 04.72	M 114.980		246-075-021-007C	SWP-M-G	Plug Number (T2): 1; T25: A000 869 30 21

**280 C (114.073) (118 kW | 2.7 Litre)**

06.72 - 02.77	M 110.921		246-075-017-002C	SWP-M-G	Plug Number (T2): 4
06.72 - 02.77	M 110.921		246-075-021-007C	SWP-M-G	Plug Number (T2): 1; T25: A000 869 30 21

**280 CE (114.072) (136 kW | 2.7 Litre)**

06.72 - 01.77	M 110.981		246-075-017-002C	SWP-M-G	Plug Number (T2): 4
06.72 - 01.77	M 110.981		246-075-021-007C	SWP-M-G	Plug Number (T2): 1; T25: A000 869 30 21





			<b>VDO</b>		
Date	Engine Code	Chassis No.	Article No.	Product	Information

**MERCEDES-BENZ****/8 (W115)****200 (115.015) (63 kW | 2.0 Litre)**

01.68 - 01.77	M 115.923, M 115.926		246-069-026-001G	N	
01.76 - 01.77	M 115.923, M 115.926		246-082-008-013P	SWP-M-C	Plug Number (T2): 4; T25: 140 869 02 21, etc.

**200 (70 kW | 2.0 Litre)**

01.68 - 01.77	M 115.923, M 115.926		246-075-017-002C	SWP-M-G	Plug Number (T2): 4
01.68 - 01.77	M 115.923, M 115.926		246-075-021-007C	SWP-M-G	Plug Number (T2): 1; T25: A000 869 30 21

**200 D (115.115) (40 kW | 2.0 Litre)**

01.68 - 01.77	OM 615.913		246-069-026-001G	N	
01.76 - 01.77	OM 615.913		246-082-008-013P	SWP-M-C	Plug Number (T2): 4; T25: 140 869 02 21, etc.

**220 (115.010) (66 kW | 2.2 Litre)**

01.68 - 07.73	M 115.924		246-069-026-001G	N	
---------------	-----------	--	------------------	---	--

**220 (115.010) (77 kW | 2.2 Litre)**

01.68 - 07.73	M 115.920		246-069-026-001G	N	
---------------	-----------	--	------------------	---	--

**220 D (115.110) (44 kW | 2.2 Litre)**

01.68 - 01.77	OM 615.912		246-069-026-001G	N	
01.76 - 01.77	OM 615.912		246-082-008-013P	SWP-M-C	Plug Number (T2): 4; T25: 140 869 02 21, etc.

**240 D (115.117) (48 kW | 2.4 Litre)**

01.76 - 01.77	OM 616.916		246-082-008-013P	SWP-M-C	Plug Number (T2): 4; T25: 140 869 02 21, etc.
---------------	------------	--	------------------	---------	-----------------------------------------------

**Saloon (W123)****200 (123.020) (69 kW | 2.0 Litre)**

02.76 - 08.80	M 115.938, M 115.939		246-069-026-001G	N	
02.76 - 08.80	M 115.938, M 115.939		246-082-005-002C	SWP-M-C	Plug Number (T2): 4; T25: 124 869 03 21, etc.

**200 (123.220) (80 kW | 2.0 Litre)**

06.80 - 11.85	M 102.920		246-069-026-001G	N	
06.80 - 11.85	M 102.920		246-082-005-002C	SWP-M-C	Plug Number (T2): 4; T25: 124 869 03 21, etc.

**200 (62 kW | 2.0 Litre)**

02.76 - 08.80	M 115.938, M 115.939		246-082-005-002C	SWP-M-C	Plug Number (T2): 4; T25: 124 869 03 21, etc.
---------------	----------------------	--	------------------	---------	-----------------------------------------------

**200 (74 kW | 2.0 Litre)**

06.80 - 11.85	M 102.939		246-082-005-002C	SWP-M-C	Plug Number (T2): 4; T25: 124 869 03 21, etc.
06.80 - 11.85	M 102.939		246-082-008-013P	SWP-M-C	Plug Number (T2): 4; T25: 140 869 02 21, etc.

**200 D (123.120) (40 kW | 2.0 Litre)**

07.76 - 02.79	OM 615.940		246-069-026-001G	N	
07.76 - 02.79	OM 615.940		246-082-005-002C	SWP-M-C	Plug Number (T2): 4; T25: 124 869 03 21, etc.

**200 D (44 kW | 2.0 Litre)**

03.79 - 11.85	OM 615.940		246-082-005-002C	SWP-M-C	Plug Number (T2): 4; T25: 124 869 03 21, etc.
---------------	------------	--	------------------	---------	-----------------------------------------------

**220 D (123.126) (44 kW | 2.2 Litre)**

01.76 - 02.79	OM 615.941		246-069-026-001G	N	
01.76 - 02.79	OM 615.941		246-082-005-002C	SWP-M-C	Plug Number (T2): 4; T25: 124 869 03 21, etc.

**220 D (49 kW | 2.2 Litre)**

01.77 - 03.79	OM 615.941		246-082-005-002C	SWP-M-C	Plug Number (T2): 4; T25: 124 869 03 21, etc.
---------------	------------	--	------------------	---------	-----------------------------------------------

**230 (123.023) (80 kW | 2.3 Litre)**

02.76 - 03.81	M 115.954		246-069-026-001G	N	
02.76 - 03.81	M 115.954		246-082-005-002C	SWP-M-C	Plug Number (T2): 4; T25: 124 869 03 21, etc.
02.76 - 02.81	M 115.954		246-082-008-013P	SWP-M-C	Plug Number (T2): 4; T25: 140 869 02 21, etc.

**230 E (123.223) (100 kW | 2.3 Litre)**

04.80 - 12.85	M 102.980		246-069-026-001G	N	
04.80 - 12.85	M 102.980		246-082-005-002C	SWP-M-C	Plug Number (T2): 4; T25: 124 869 03 21, etc.
04.80 - 12.85	M 102.980		246-082-008-013P	SWP-M-C	Plug Number (T2): 4; T25: 140 869 02 21, etc.

**240 D (123.123) (48 kW | 2.4 Litre)**

02.76 - 02.79	OM 616.912		246-069-026-001G	N	
02.76 - 02.79	OM 616.912		246-082-005-002C	SWP-M-C	Plug Number (T2): 4; T25: 124 869 03 21, etc.

**240 D (123.123) (53 kW | 2.4 Litre)**

03.79 - 11.85	OM 616.912		246-069-026-001G	N	
03.79 - 11.85	OM 616.912		246-082-005-002C	SWP-M-C	Plug Number (T2): 4; T25: 124 869 03 21, etc.

**250 (123.026) (103 kW | 2.5 Litre)**

10.79 - 07.85	M 123.921		246-069-026-001G	N	
10.79 - 07.85	M 123.921		246-082-005-002C	SWP-M-C	Plug Number (T2): 4; T25: 124 869 03 21, etc.
10.79 - 07.85	M 123.921		246-082-008-013P	SWP-M-C	Plug Number (T2): 4; T25: 140 869 02 21, etc.

**250 (123.026) (95 kW | 2.5 Litre)**

02.76 - 10.79	M 123.921		246-069-026-001G	N	
02.76 - 10.79	M 123.921		246-082-005-002C	SWP-M-C	Plug Number (T2): 4; T25: 124 869 03 21, etc.
02.76 - 09.79	M 123.921		246-082-008-013P	SWP-M-C	Plug Number (T2): 4; T25: 140 869 02 21, etc.



			<b>VDO</b>		
Date	Engine Code	Chassis No.	Article No.	Product	Information

**MERCEDES-BENZ****Saloon (W123)****280 (123.030) (115 kW | 2.7 Litre)**

02.76 - 08.81	M 110.923		246-069-026-001G	N	
02.76 - 08.81	M 110.923		246-082-005-002C	SWP-M-C	Plug Number (T2): 4; T25: 124 869 03 21, etc.
02.76 - 07.81	M 110.923		246-082-008-013P	SWP-M-C	Plug Number (T2): 4; T25: 140 869 02 21, etc.

**280 E (123.033) (136 kW | 2.7 Litre)**

02.76 - 11.85	M 110.984, M 110.988		246-069-026-001G	N	
02.76 - 11.85	M 110.984, M 110.988		246-082-005-002C	SWP-M-C	Plug Number (T2): 4; T25: 124 869 03 21, etc.

**280 E (130 kW | 2.7 Litre)**

08.76 - 08.81	M 110.988		246-082-005-002C	SWP-M-C	Plug Number (T2): 4; T25: 124 869 03 21, etc.
08.76 - 08.81	M 110.988		246-082-008-013P	SWP-M-C	Plug Number (T2): 4; T25: 140 869 02 21, etc.

**300 D (123.130) (59 kW | 2.9 Litre)**

02.76 - 07.80	OM 617.912		246-069-026-001G	N	
02.76 - 07.80	OM 617.912		246-082-005-002C	SWP-M-C	Plug Number (T2): 4; T25: 124 869 03 21, etc.
02.76 - 07.80	OM 617.912		246-082-008-013P	SWP-M-C	Plug Number (T2): 4; T25: 140 869 02 21, etc.

**300 D (123.130) (65 kW | 2.9 Litre)**

03.79 - 11.85	OM 617.912		246-069-026-001G	N	
03.79 - 11.85	OM 617.912		246-082-005-002C	SWP-M-C	Plug Number (T2): 4; T25: 124 869 03 21, etc.

**300 Turbo-D (123.133) (92 kW | 2.9 Litre)**

08.81 - 07.85	OM 617.952		246-082-005-002C	SWP-M-C	Plug Number (T2): 4; T25: 124 869 03 21, etc.
---------------	------------	--	------------------	---------	-----------------------------------------------

**KOMBI Estate (S123)****200 T (123.280) (74 kW | 2.0 Litre)**

11.80 - 11.85	M 102.939		246-069-026-001G	N	
11.80 - 11.85	M 102.939		246-082-005-002C	SWP-M-C	Plug Number (T2): 4; T25: 124 869 03 21, etc.
11.80 - 11.85	M 102.939		246-082-008-013P	SWP-M-C	Plug Number (T2): 4; T25: 140 869 02 21, etc.

**200 T (80 kW | 2.0 Litre)**

11.80 - 11.85	M 102.920		246-082-005-002C	SWP-M-C	Plug Number (T2): 4; T25: 124 869 03 21, etc.
---------------	-----------	--	------------------	---------	-----------------------------------------------

**230 T (123.083) (80 kW | 2.3 Litre)**

09.77 - 03.80	M 115.954		246-069-026-001G	N	
09.77 - 03.80	M 115.954		246-082-005-002C	SWP-M-C	Plug Number (T2): 4; T25: 124 869 03 21, etc.
04.78 - 03.80	M 115.954		246-082-008-013P	SWP-M-C	Plug Number (T2): 4; T25: 140 869 02 21, etc.

**230 TE (123.283) (100 kW | 2.3 Litre)**

04.80 - 11.85	M 102.980		246-069-026-001G	N	
04.80 - 11.85	M 102.980		246-082-005-002C	SWP-M-C	Plug Number (T2): 4; T25: 124 869 03 21, etc.
06.80 - 11.85	M 102.980		246-082-008-013P	SWP-M-C	Plug Number (T2): 4; T25: 140 869 02 21, etc.

**240 T D (123.183) (53 kW | 2.4 Litre)**

03.79 - 12.85	OM 616.912		246-069-026-001G	N	
03.79 - 12.85	OM 616.912		246-082-005-002C	SWP-M-C	Plug Number (T2): 4; T25: 124 869 03 21, etc.
03.79 - 12.85	OM 616.912		246-082-008-013P	SWP-M-C	Plug Number (T2): 4; T25: 140 869 02 21, etc.

**240 T D (48 kW | 2.4 Litre)**

09.77 - 02.79	OM 616.912		246-082-005-002C	SWP-M-C	Plug Number (T2): 4; T25: 124 869 03 21, etc.
---------------	------------	--	------------------	---------	-----------------------------------------------

**250 T (123.086) (103 kW | 2.5 Litre)**

05.78 - 08.82	M 123.921		246-069-026-001G	N	
05.78 - 08.82	M 123.921		246-082-005-002C	SWP-M-C	Plug Number (T2): 4; T25: 124 869 03 21, etc.

**250 T (123.086) (95 kW | 2.5 Litre)**

05.78 - 10.79	M 123.921		246-069-026-001G	N	
05.78 - 10.79	M 123.921		246-082-005-002C	SWP-M-C	Plug Number (T2): 4; T25: 124 869 03 21, etc.

**280 TE (123.093) (136 kW | 2.7 Litre)**

09.77 - 11.85	M 110.988		246-069-026-001G	N	
09.77 - 11.85	M 110.988		246-082-005-002C	SWP-M-C	Plug Number (T2): 4; T25: 124 869 03 21, etc.
04.78 - 11.85	M 110.988		246-082-008-013P	SWP-M-C	Plug Number (T2): 4; T25: 140 869 02 21, etc.

**300 T D (123.190) (59 kW | 2.9 Litre)**

09.77 - 10.85	OM 617.912		246-069-026-001G	N	
09.77 - 10.85	OM 617.912		246-082-005-002C	SWP-M-C	Plug Number (T2): 4; T25: 124 869 03 21, etc.
04.78 - 10.85	OM 617.912		246-082-008-013P	SWP-M-C	Plug Number (T2): 4; T25: 140 869 02 21, etc.

**300 T D (123.190) (65 kW | 2.9 Litre)**

03.79 - 11.85	OM 617.912		246-069-026-001G	N	
03.79 - 11.85	OM 617.912		246-082-005-002C	SWP-M-C	Plug Number (T2): 4; T25: 124 869 03 21, etc.

**300 T Turbo-D (123.193) (92 kW | 2.9 Litre)**

10.80 - 11.85	OM 617.952		246-069-026-001G	N	
10.80 - 11.85	OM 617.952		246-082-005-002C	SWP-M-C	Plug Number (T2): 4; T25: 124 869 03 21, etc.
10.80 - 11.85	OM 617.952		246-082-008-013P	SWP-M-C	Plug Number (T2): 4; T25: 140 869 02 21, etc.



			<b>VDO</b>		
Date	Engine Code	Chassis No.	Article No.	Product	Information

**MERCEDES-BENZ****COUPE (C123)**

<b>230 C (123.043) (80 kW   2.3 Litre)</b>					
05.77 → 04.80	M 115.954		246-069-026-001G	N	
05.77 → 04.80	M 115.954		246-082-008-013P	SWP-M-C	Plug Number (T2): 4; T25: 140 869 02 21, etc.
<b>230 CE (123.243) (100 kW   2.3 Litre)</b>					
04.80 → 12.85	M 102.980		246-069-026-001G	N	
06.80 → 07.85	M 102.980		246-082-008-013P	SWP-M-C	Plug Number (T2): 4; T25: 140 869 02 21, etc.
<b>280 C (123.050) (115 kW   2.7 Litre)</b>					
03.77 → 03.80	M 110.923		246-069-026-001G	N	
03.77 → 03.80	M 110.923		246-082-008-013P	SWP-M-C	Plug Number (T2): 4; T25: 140 869 02 21, etc.
<b>280 CE (130 kW   2.7 Litre)</b>					
09.77 → 08.79	M 110.988		246-082-008-013P	SWP-M-C	Plug Number (T2): 4; T25: 140 869 02 21, etc.
<b>280 CE (136 kW   2.7 Litre)</b>					
03.77 → 07.85	M 110.988		246-082-008-013P	SWP-M-C	Plug Number (T2): 4; T25: 140 869 02 21, etc.
<b>300 C Turbo-D (123.153) (92 kW   2.9 Litre)</b>					
09.81 → 07.85	OM 617.952		246-069-026-001G	N	

**COUPE (C124)**

<b>220 CE (124.042) (110 kW   2.2 Litre)</b>					
10.92 → 05.93	M 111.960		246-082-005-002C	SWP-M-C	Plug Number (T2): 4; T25: 124 869 03 21, etc.
10.92 → 05.93	M 111.960		246-082-008-013P	SWP-M-C	Plug Number (T2): 4; T25: 140 869 02 21, etc.
<b>230 CE (124.043) (100 kW   2.3 Litre)</b>					
03.87 → 12.92	M 102.982		246-082-005-002C	SWP-M-C	Plug Number (T2): 4; T25: 124 869 03 21, etc.
<b>230 CE (124.043) (97 kW   2.3 Litre)</b>					
03.87 → 12.92	M 102.982		246-082-005-002C	SWP-M-C	Plug Number (T2): 4; T25: 124 869 03 21, etc.
03.87 → 12.92	M 102.982		246-082-008-013P	SWP-M-C	Plug Number (T2): 4; T25: 140 869 02 21, etc.
<b>230 CE (124.043) CAT (97 kW   2.3 Litre)</b>					
06.89 → 12.92	M 102.982		246-082-005-002C	SWP-M-C	Plug Number (T2): 4; T25: 124 869 03 21, etc.
<b>300 CE (124.050) (132 kW   3.0 Litre)</b>					
03.87 → 05.93	M 103.983		246-082-005-002C	SWP-M-C	Plug Number (T2): 4; T25: 124 869 03 21, etc.
<b>300 CE (138 kW   3.0 Litre)</b>					
03.87 → 12.89	M 103.983		246-082-005-002C	SWP-M-C	Plug Number (T2): 4; T25: 124 869 03 21, etc.
05.87 → 12.89	M 103.983		246-082-008-013P	SWP-M-C	Plug Number (T2): 4; T25: 140 869 02 21, etc.
<b>300 CE-24 (124.051) (162 kW   3.0 Litre)</b>					
09.89 → 12.92	M 104.980		246-082-005-002C	SWP-M-C	Plug Number (T2): 4; T25: 124 869 03 21, etc.
09.89 → 12.92	M 104.980		246-082-008-013P	SWP-M-C	Plug Number (T2): 4; T25: 140 869 02 21, etc.
<b>320 CE (124.052) (162 kW   3.2 Litre)</b>					
10.92 → 05.93	M 104.992		246-082-005-002C	SWP-M-C	Plug Number (T2): 4; T25: 124 869 03 21, etc.
10.92 → 05.93	M 104.992		246-082-008-013P	SWP-M-C	Plug Number (T2): 4; T25: 140 869 02 21, etc.

**E-CLASS (W124)**

<b>E 200 (124.019) (100 kW   2.0 Litre)</b>					
06.93 → 06.95	M 111.940		246-082-005-002C	SWP-M-C	Plug Number (T2): 4; T25: 124 869 03 21, etc.
07.93 → 06.95	M 111.940		246-082-008-013P	SWP-M-C	Plug Number (T2): 4; T25: 140 869 02 21, etc.
<b>E 200 D (124.120) (55 kW   2.0 Litre)</b>					
06.93 → 06.95	OM 601.912		246-082-005-002C	SWP-M-C	Plug Number (T2): 4; T25: 124 869 03 21, etc.
07.93 → 06.95	OM 601.912		246-082-008-013P	SWP-M-C	Plug Number (T2): 4; T25: 140 869 02 21, etc.
<b>E 220 (124.022) (110 kW   2.2 Litre)</b>					
06.93 → 06.95	M 111.960		246-082-005-002C	SWP-M-C	Plug Number (T2): 4; T25: 124 869 03 21, etc.
07.93 → 06.95	M 111.960		246-082-008-013P	SWP-M-C	Plug Number (T2): 4; T25: 140 869 02 21, etc.
<b>E 250 D (124.126, 124.129) (83 kW   2.5 Litre)</b>					
07.93 → 06.95	OM 605.911		246-082-005-002C	SWP-M-C	Plug Number (T2): 4; T25: 124 869 03 21, etc.
07.93 → 06.95	OM 605.911		246-082-008-013P	SWP-M-C	Plug Number (T2): 4; T25: 140 869 02 21, etc.
<b>E 250 Turbo-D (124.128) (93 kW   2.5 Litre)</b>					
06.93 → 06.95	OM 602.962		246-082-005-002C	SWP-M-C	Plug Number (T2): 4; T25: 124 869 03 21, etc.
07.93 → 06.95	OM 602.962		246-082-008-013P	SWP-M-C	Plug Number (T2): 4; T25: 140 869 02 21, etc.
<b>E 280 (124.028) (145 kW   2.8 Litre)</b>					
06.93 → 06.95	M 104.942		246-082-005-002C	SWP-M-C	Plug Number (T2): 4; T25: 124 869 03 21, etc.
<b>E 280 long (124.029) (142 kW   2.8 Litre)</b>					
06.93 → 06.95	M 104.942		246-082-005-002C	SWP-M-C	Plug Number (T2): 4; T25: 124 869 03 21, etc.
07.93 → 06.95	M 104.942		246-082-008-013P	SWP-M-C	Plug Number (T2): 4; T25: 140 869 02 21, etc.
<b>E 300 4-matic (124.230) (132 kW   3.0 Litre)</b>					
06.93 → 06.95	M 103.985		246-082-005-002C	SWP-M-C	Plug Number (T2): 4; T25: 124 869 03 21, etc.
07.93 → 06.95	M 103.985		246-082-008-013P	SWP-M-C	Plug Number (T2): 4; T25: 140 869 02 21, etc.



			<b>VDO</b>		
Date	Engine Code	Chassis No.	Article No.	Product	Information

**MERCEDES-BENZ****E-CLASS (W124)****E 300 D (124.131) (100 kW | 3.0 Litre)**

07.93 - 06.95	OM 606.910		246-082-005-002C	SWP-M-C	Plug Number (T2): 4; T25: 124 869 03 21, etc.
07.93 - 06.95	OM 606.910		246-082-008-013P	SWP-M-C	Plug Number (T2): 4; T25: 140 869 02 21, etc.

**E 300 Turbo-D (124.133) (108 kW | 3.0 Litre)**

06.93 - 06.95	OM 603.960		246-082-005-002C	SWP-M-C	Plug Number (T2): 4; T25: 124 869 03 21, etc.
---------------	------------	--	------------------	---------	-----------------------------------------------

**E 300 Turbo-D 4-matic (124.333) (108 kW | 3.0 Litre)**

06.93 - 06.95	OM 603.963		246-082-005-002C	SWP-M-C	Plug Number (T2): 4; T25: 124 869 03 21, etc.
07.93 - 06.95	OM 603.963		246-082-008-013P	SWP-M-C	Plug Number (T2): 4; T25: 140 869 02 21, etc.

**E 320 (124.032) (162 kW | 3.2 Litre)**

06.93 - 06.95	M 104.992		246-082-005-002C	SWP-M-C	Plug Number (T2): 4; T25: 124 869 03 21, etc.
---------------	-----------	--	------------------	---------	-----------------------------------------------

**E 420 (124.034) (205 kW | 4.2 Litre)**

06.93 - 06.95	M 119.975		246-082-005-002C	SWP-M-C	Plug Number (T2): 4; T25: 124 869 03 21, etc.
07.93 - 06.95	M 119.975		246-082-008-013P	SWP-M-C	Plug Number (T2): 4; T25: 140 869 02 21, etc.

**E 500 (124.036) (235 kW | 5.0 Litre)**

06.93 - 06.95	M 119.974		246-082-005-002C	SWP-M-C	Plug Number (T2): 4; T25: 124 869 03 21, etc.
07.93 - 06.95	M 119.974		246-082-008-013P	SWP-M-C	Plug Number (T2): 4; T25: 140 869 02 21, etc.

**E 60 AMG (124.036) (280 kW | 6.0 Litre)**

05.94 - 06.95	M 119.974 AMG		246-082-005-002C	SWP-M-C	Plug Number (T2): 4; T25: 124 869 03 21, etc.
---------------	---------------	--	------------------	---------	-----------------------------------------------

**E-CLASS Estate (S124)****E 200 T (124.079) (100 kW | 2.0 Litre)**

07.93 - 02.96	M 111.940		246-082-008-013P	SWP-M-C	Plug Number (T2): 4; T25: 140 869 02 21, etc.
---------------	-----------	--	------------------	---------	-----------------------------------------------

**E 220 T (124.082) (110 kW | 2.2 Litre)**

07.93 - 02.96	M 111.960		246-082-008-013P	SWP-M-C	Plug Number (T2): 4; T25: 140 869 02 21, etc.
---------------	-----------	--	------------------	---------	-----------------------------------------------

**E 250 T D (124.186) (83 kW | 2.5 Litre)**

07.93 - 02.96	OM 605.911		246-082-008-013P	SWP-M-C	Plug Number (T2): 4; T25: 140 869 02 21, etc.
---------------	------------	--	------------------	---------	-----------------------------------------------

**E 250 Turbo D (93 kW | 2.5 Litre)**

06.93 - 06.96	OM 602.962		246-082-005-002C	SWP-M-C	Plug Number (T2): 4; T25: A124 869 00 21, 124 869 03 21, etc.
06.93 - 06.96	OM 602.962		246-082-008-013P	SWP-M-C	Plug Number (T2): 4; T25: A202 869 00 21, 140 869 02 21, etc.

**E 280 T (124.088) (142 kW | 2.8 Litre)**

06.93 - 06.96	M 104.942		246-082-005-002C	SWP-M-C	Plug Number (T2): 4; T25: A124 869 00 21, 124 869 03 21, etc.
06.93 - 06.96	M 104.942		246-082-008-013P	SWP-M-C	Plug Number (T2): 4; T25: A202 869 00 21, 140 869 02 21, etc.

**E 280 T (124.088) (145 kW | 2.8 Litre)**

07.93 - 02.96	M 104.942		246-082-008-013P	SWP-M-C	Plug Number (T2): 4; T25: 140 869 02 21, etc.
---------------	-----------	--	------------------	---------	-----------------------------------------------

**E 300 T 4-matic (124.290) (132 kW | 3.0 Litre)**

07.93 - 02.96	M 103.985		246-082-008-013P	SWP-M-C	Plug Number (T2): 4; T25: 140 869 02 21, etc.
---------------	-----------	--	------------------	---------	-----------------------------------------------

**E 300 T D (124.191) (100 kW | 3.0 Litre)**

07.93 - 02.96	OM 606.910		246-082-008-013P	SWP-M-C	Plug Number (T2): 4; T25: 140 869 02 21, etc.
---------------	------------	--	------------------	---------	-----------------------------------------------

**E 300 T Turbo-D (124.193) (108 kW | 3.0 Litre)**

07.93 - 02.96	OM 603.960		246-082-008-013P	SWP-M-C	Plug Number (T2): 4; T25: 140 869 02 21, etc.
---------------	------------	--	------------------	---------	-----------------------------------------------

**E 300 T Turbo-D 4-matic (124.393) (108 kW | 3.0 Litre)**

07.93 - 02.96	OM 603.963		246-082-008-013P	SWP-M-C	Plug Number (T2): 4; T25: 140 869 02 21, etc.
---------------	------------	--	------------------	---------	-----------------------------------------------

**E 300 TE-24 AMG (124.091) (162 kW | 3.0 Litre)**

06.93 - 06.96	M 104.980		246-082-005-002C	SWP-M-C	Plug Number (T2): 4; T25: A124 869 00 21, 124 869 03 21, etc.
06.93 - 06.96	M 104.980		246-082-008-013P	SWP-M-C	Plug Number (T2): 4; T25: A202 869 00 21, 140 869 02 21, etc.

**E 320 T (124.092) (162 kW | 3.2 Litre)**

07.93 - 02.96	M 104.992		246-082-008-013P	SWP-M-C	Plug Number (T2): 4; T25: 140 869 02 21, etc.
---------------	-----------	--	------------------	---------	-----------------------------------------------

**E 36 T AMG (124.092) (200 kW | 3.6 Litre)**

05.94 - 06.96	M 104.992 (AMG 3.6)		246-082-005-002C	SWP-M-C	Plug Number (T2): 4; T25: A124 869 00 21, 124 869 03 21, etc.
05.94 - 06.96	M 104.992 (AMG 3.6)		246-082-008-013P	SWP-M-C	Plug Number (T2): 4; T25: A202 869 00 21, 140 869 02 21, etc.

**E-CLASS Coupe (C124)****E 200 (124.040) (100 kW | 2.0 Litre)**

06.93 - 06.97	M 111.940		246-082-005-002C	SWP-M-C	Plug Number (T2): 4; T25: 124 869 03 21, etc.
07.93 - 06.97	M 111.940		246-082-008-013P	SWP-M-C	Plug Number (T2): 4; T25: 140 869 02 21, etc.



Date	Engine Code	Chassis No.	Article No.	Product	Information

**MERCEDES-BENZ****E-CLASS Coupe (C124)****E 220 (124.042) (110 kW | 2.2 Litre)**

06.93 - 06.97	M 111.960		246-082-005-002C	SWP-M-C	Plug Number (T2): 4; T25: 124 869 03 21, etc.
07.93 - 06.97	M 111.960		246-082-008-013P	SWP-M-C	Plug Number (T2): 4; T25: 140 869 02 21, etc.

**E 320 (124.052) (162 kW | 3.2 Litre)**

06.93 - 06.97	M 104.992		246-082-005-002C	SWP-M-C	Plug Number (T2): 4; T25: 124 869 03 21, etc.
07.93 - 06.97	M 104.992		246-082-008-013P	SWP-M-C	Plug Number (T2): 4; T25: 140 869 02 21, etc.

**E 36 AMG (124.052) (195 kW | 3.6 Litre)**

06.93 - 04.95	M 104.992 (AMG 3.6)		246-082-005-002C	SWP-M-C	Plug Number (T2): 4; T25: 124 869 03 21, etc.
---------------	---------------------	--	------------------	---------	-----------------------------------------------

**E 36 AMG (124.052) (200 kW | 3.6 Litre)**

05.94 - 06.97	M 104.992 (AMG 3.6)		246-082-005-002C	SWP-M-C	Plug Number (T2): 4; T25: 124 869 03 21, etc.
05.94 - 06.97	M 104.992 (AMG 3.6)		246-082-008-013P	SWP-M-C	Plug Number (T2): 4; T25: 140 869 02 21, etc.

**E-CLASS Convertible (A124)****E 200 (124.060) (100 kW | 2.0 Litre)**

06.93 - 03.98	M 111.940		246-082-005-002C	SWP-M-C	Plug Number (T2): 4; T25: 124 869 03 21, etc.
07.93 - 03.98	M 111.940		246-082-008-013P	SWP-M-C	Plug Number (T2): 4; T25: 140 869 02 21, etc.

**E 220 (124.062) (110 kW | 2.2 Litre)**

06.93 - 03.98	M 111.960		246-082-005-002C	SWP-M-C	Plug Number (T2): 4; T25: 124 869 03 21, etc.
07.93 - 03.98	M 111.960		246-082-008-013P	SWP-M-C	Plug Number (T2): 4; T25: 140 869 02 21, etc.

**E 320 (124.066) (162 kW | 3.2 Litre)**

06.93 - 03.98	M 104.992, M 104.995		246-082-005-002C	SWP-M-C	Plug Number (T2): 4; T25: 124 869 03 21, etc.
07.93 - 03.98	M 104.992, M 104.995		246-082-008-013P	SWP-M-C	Plug Number (T2): 4; T25: 140 869 02 21, etc.

**E 36 AMG (124.066) (200 kW | 3.6 Litre)**

05.94 - 03.98	M 104.992 (AMG 3.6)		246-082-005-002C	SWP-M-C	Plug Number (T2): 4; T25: 124 869 03 21, etc.
05.94 - 03.98	M 104.992 (AMG 3.6)		246-082-008-013P	SWP-M-C	Plug Number (T2): 4; T25: 140 869 02 21, etc.

**E-CLASS (W210)****E 200 (210.035) (100 kW | 2.0 Litre)**

06.95 - 08.00	M 111.942	-A394035	246-082-008-013P	SWP-M-C	Plug Number (T2): 4; T25: 140 869 02 21, etc.
06.95 - 08.00	M 111.942		246-082-008-025G	SWP-M-C	

**E 200 CDI (210.007) (75 kW | 2.2 Litre)**

06.98 - 03.02	OM 611.961		246-082-008-013P	SWP-M-C	Plug Number (T2): 4; T25: 140 869 02 21, etc.
06.98 - 03.02	OM 611.961		246-082-008-025G	SWP-M-C	

**E 200 CDI (210.007) (85 kW | 2.2 Litre)**

07.99 - 03.02	OM 611.961		246-082-008-013P	SWP-M-C	Plug Number (T2): 4; T25: 140 869 02 21, etc.
07.99 - 03.02	OM 611.961		246-082-008-025G	SWP-M-C	

**E 200 D (210.003) (65 kW | 2.0 Litre)**

01.96 - 03.02	OM 604.917	-A394035	246-082-008-013P	SWP-M-C	Plug Number (T2): 4; T25: 140 869 02 21, etc.
01.96 - 03.02	OM 604.917		246-082-008-025G	SWP-M-C	

**E 200 Kompressor (210.045) (137 kW | 2.0 Litre)**

06.97 - 03.02	M 111.947		246-082-008-013P	SWP-M-C	Plug Number (T2): 4; T25: 140 869 02 21, etc.
06.97 - 03.02	M 111.947		246-082-008-025G	SWP-M-C	

**E 200 Kompressor (210.048) (120 kW | 2.0 Litre)**

08.00 - 03.02	M 111.957		246-082-008-013P	SWP-M-C	Plug Number (T2): 4; T25: 140 869 02 21, etc.
08.00 - 03.02	M 111.957		246-082-008-025G	SWP-M-C	

**E 220 CDI (210.006) (105 kW | 2.2 Litre)**

07.99 - 03.02	OM 611.961		246-082-008-013P	SWP-M-C	Plug Number (T2): 4; T25: 140 869 02 21, etc.
07.99 - 03.02	OM 611.961		246-082-008-025G	SWP-M-C	

**E 220 CDI (210.006) (92 kW | 2.2 Litre)**

06.98 - 07.99	OM 611.961		246-082-008-013P	SWP-M-C	Plug Number (T2): 4; T25: 140 869 02 21, etc.
06.98 - 07.99	OM 611.961		246-082-008-025G	SWP-M-C	

**E 220 D (210.004) (70 kW | 2.2 Litre)**

06.95 - 07.99	OM 604.912		246-082-008-013P	SWP-M-C	Plug Number (T2): 4; T25: 140 869 02 21, etc.
06.95 - 07.99	OM 604.912		246-082-008-025G	SWP-M-C	

**E 220 D (55 kW | 2.2 Litre)**

05.96 - 03.02	OM 604.912	-A394035	246-082-008-013P	SWP-M-C	Plug Number (T2): 4; T25: 140 869 02 21, etc.
05.96 - 03.02	OM 604.912	-A394035	246-082-008-025G	SWP-M-C	

**E 230 (210.037) (110 kW | 2.3 Litre)**

06.95 - 06.97	M 111.970	-A394035	246-082-008-013P	SWP-M-C	Plug Number (T2): 4; T25: 140 869 02 21, etc.
06.95 - 06.97	M 111.970	-A394035	246-082-008-025G	SWP-M-C	

**E 240 (210.061) (125 kW | 2.4 Litre)**

06.97 - 08.00	M 112.911		246-082-008-025G	SWP-M-C	
---------------	-----------	--	------------------	---------	--



			<b>VDO</b>		
Date	Engine Code	Chassis No.	Article No.	Product	Information

**MERCEDES-BENZ****E-CLASS (W210)****E 240 (210.062) (125 kW | 2.6 Litre)**

08.00 - 03.02	M 112.914		246-082-008-013P	SWP-M-C	Plug Number (T2): 4; T25: 140 869 02 21, etc.
08.00 - 03.02	M 112.914		246-082-008-025G	SWP-M-C	

**E 250 D (210.010) (83 kW | 2.5 Litre)**

06.95 - 07.99	OM 605.912	-A394035	246-082-008-013P	SWP-M-C	Plug Number (T2): 4; T25: 140 869 02 21, etc.
06.95 - 07.99	OM 605.912	-A394035	246-082-008-025G	SWP-M-C	

**E 250 Turbo-D (210.015) (110 kW | 2.5 Litre)**

06.97 - 07.99	OM 605.962		246-082-008-013P	SWP-M-C	Plug Number (T2): 4; T25: 140 869 02 21, etc.
06.97 - 07.99	OM 605.962		246-082-008-025G	SWP-M-C	

**E 270 CDI (210.016) (125 kW | 2.7 Litre)**

07.99 - 03.02	OM 612.961		246-082-008-025G	SWP-M-C	
---------------	------------	--	------------------	---------	--

**E 280 (210.053) (142 kW | 2.8 Litre)**

01.96 - 06.97	M 104.945		246-082-008-025G	SWP-M-C	
---------------	-----------	--	------------------	---------	--

**E 280 (210.063) (150 kW | 2.8 Litre)**

12.96 - 03.02	M 112.921		246-082-008-013P	SWP-M-C	Plug Number (T2): 4; T25: 140 869 02 21, etc.
12.96 - 03.02	M 112.921		246-082-008-025G	SWP-M-C	

**E 280 4-matic (210.081) (150 kW | 2.8 Litre)**

12.96 - 03.02	M 112.921		246-082-008-013P	SWP-M-C	Plug Number (T2): 4; T25: 140 869 02 21, etc.
12.96 - 03.02	M 112.921		246-082-008-025G	SWP-M-C	

**E 290 Turbo-D (210.017) (95 kW | 2.9 Litre)**

03.96 - 07.99	OM 602.982	-A394035	246-082-008-013P	SWP-M-C	Plug Number (T2): 4; T25: 140 869 02 21, etc.
03.96 - 07.99	OM 602.982	-A394035	246-082-008-025G	SWP-M-C	

**E 300 D (210.020) (100 kW | 3.0 Litre)**

06.95 - 06.97	OM 606.912		246-082-008-013P	SWP-M-C	Plug Number (T2): 4; T25: 140 869 02 21, etc.
06.95 - 06.97	OM 606.912		246-082-008-025G	SWP-M-C	

**E 300 Turbo-D (210.025) (130 kW | 3.0 Litre)**

12.96 - 07.99	OM 606.962		246-082-008-025G	SWP-M-C	
---------------	------------	--	------------------	---------	--

**E 320 (210.055) (162 kW | 3.2 Litre)**

06.95 - 09.95	M 104.995		246-082-008-013P	SWP-M-C	Plug Number (T2): 4; T25: 140 869 02 21, etc.
06.95 - 09.95	M 104.995		246-082-008-025G	SWP-M-C	

**E 320 (210.065) (165 kW | 3.2 Litre)**

06.97 - 03.02	M 112.941		246-082-008-013P	SWP-M-C	Plug Number (T2): 4; T25: 140 869 02 21, etc.
06.97 - 03.02	M 112.941		246-082-008-025G	SWP-M-C	

**E 320 4-matic (210.082) (165 kW | 3.2 Litre)**

06.97 - 03.02	M 112.941		246-082-008-013P	SWP-M-C	Plug Number (T2): 4; T25: 140 869 02 21, etc.
06.97 - 03.02	M 112.941		246-082-008-025G	SWP-M-C	

**E 320 CDI (210.026) (145 kW | 3.2 Litre)**

07.99 - 03.02	OM 613.961		246-082-008-025G	SWP-M-C	
---------------	------------	--	------------------	---------	--

**E 420 (210.072) (205 kW | 4.2 Litre)**

01.96 - 06.97	M 119.985		246-082-008-013P	SWP-M-C	Plug Number (T2): 4; T25: 140 869 02 21, etc.
01.96 - 06.97	M 119.985		246-082-008-025G	SWP-M-C	

**E 430 (210.070) (205 kW | 4.3 Litre)**

06.97 - 03.02	M 113.940		246-082-008-025G	SWP-M-C	
---------------	-----------	--	------------------	---------	--

**E 430 4-matic (210.083) (205 kW | 4.3 Litre)**

05.99 - 03.02	M 113.940		246-082-008-013P	SWP-M-C	Plug Number (T2): 4; T25: 140 869 02 21, etc.
05.99 - 03.02	M 113.940		246-082-008-025G	SWP-M-C	

**E 50 AMG (210.072) (255 kW | 5.0 Litre)**

03.96 - 08.97	M 119.985 (AMG 5.0)		246-082-008-013P	SWP-M-C	Plug Number (T2): 4; T25: 140 869 02 21, etc.
03.96 - 08.97	M 119.985 (AMG 5.0)		246-082-008-025G	SWP-M-C	

**E 55 AMG (210.074) (260 kW | 5.4 Litre)**

08.97 - 03.02	M 113.980		246-082-008-025G	SWP-M-C	
---------------	-----------	--	------------------	---------	--

**E 55 AMG 4-matic (210.083) (260 kW | 5.4 Litre)**

03.01 - 03.02	M 113.980		246-082-008-013P	SWP-M-C	Plug Number (T2): 4; T25: 140 869 02 21, etc.
03.01 - 03.02	M 113.980		246-082-008-025G	SWP-M-C	

**E-CLASS Estate (S210)****E 250 T D (210.210) (83 kW | 2.5 Litre)**

06.96 - 07.99	OM 605.912		246-082-008-025G	SWP-M-C	
---------------	------------	--	------------------	---------	--

**E-CLASS (W211)****3.5 4-matic (205 kW | 3.5 Litre)**

08.04 - 08.06	M 272.972		246-082-008-025G	SWP-M-C	
---------------	-----------	--	------------------	---------	--

**E 200 CDI (211.004) (75 kW | 2.2 Litre)**

07.02 - 12.08	OM 646.951		246-082-008-025G	SWP-M-C	
---------------	------------	--	------------------	---------	--

**E 200 CDI (211.004) (90 kW | 2.2 Litre)**

07.02 - 12.08	OM 646.951		246-082-008-025G	SWP-M-C	
---------------	------------	--	------------------	---------	--



			<b>VDO</b>		
Date	Engine Code	Chassis No.	Article No.	Product	Information

**MERCEDES-BENZ****E-CLASS (W211)**

<b>E 200 CDI (211.007) (100 kW   2.1 Litre)</b>					
04.06 - 12.08	OM 646.820		246-082-008-025G	SWP-M-C	
<b>E 200 CGI (125 kW   1.8 Litre)</b>					
11.02 - 12.08	M 271.946		246-082-008-025G	SWP-M-C	
<b>E 200 Kompressor (211.041) (135 kW   1.8 Litre)</b>					
04.06 - 12.08	M 271.956		246-082-008-025G	SWP-M-C	
<b>E 200 Kompressor (211.042) (120 kW   1.8 Litre)</b>					
11.02 - 12.08	M 271.941		246-082-008-025G	SWP-M-C	
<b>E 220 CDI (120 kW   2.1 Litre)</b>					
03.03 - 12.08	OM 646.821		246-082-008-025G	SWP-M-C	
<b>E 220 CDI (211.006) (100 kW   2.1 Litre)</b>					
03.02 - 12.08	OM 646.961		246-082-008-025G	SWP-M-C	
<b>E 220 CDI (211.006) (110 kW   2.1 Litre)</b>					
03.02 - 12.08	OM 646.961		246-082-008-025G	SWP-M-C	
<b>E 220 CDI (211.008) (125 kW   2.1 Litre)</b>					
04.06 - 12.08	OM 646.821		246-082-008-025G	SWP-M-C	
<b>E 230 (211.052) (150 kW   2.5 Litre)</b>					
09.07 - 12.08	M 272.922		246-082-008-025G	SWP-M-C	
<b>E 240 (211.061) (130 kW   2.6 Litre)</b>					
03.02 - 12.08	M 112.917, M 112.913		246-082-008-025G	SWP-M-C	
<b>E 240 4-matic (211.080) (130 kW   2.6 Litre)</b>					
03.03 - 12.08	M 112.917		246-082-008-025G	SWP-M-C	
<b>E 250 CDI (150 kW   2.1 Litre)</b>					
08.08 - 12.08	OM 651.924		246-082-008-025G	SWP-M-C	
<b>E 270 CDI (211.016) (130 kW   2.7 Litre)</b>					
03.02 - 12.08	OM 647.961		246-082-008-025G	SWP-M-C	
<b>E 280 (211.054) (170 kW   3.0 Litre)</b>					
03.05 - 12.08	M 272.943		246-082-008-025G	SWP-M-C	
<b>E 280 4-matic (211.092) (170 kW   3.0 Litre)</b>					
01.06 - 12.08	M 272.943		246-082-008-025G	SWP-M-C	
<b>E 280 CDI (211.020) (140 kW   3.0 Litre)</b>					
03.05 - 12.08	OM 642.920		246-082-008-025G	SWP-M-C	
<b>E 280 CDI (211.023) (130 kW   3.2 Litre)</b>					
05.04 - 12.08	OM 648.961		246-082-008-025G	SWP-M-C	
<b>E 280 CDI 4-matic (140 kW   3.0 Litre)</b>					
03.05 - 12.08	OM 642.921		246-082-008-025G	SWP-M-C	
<b>E 300 BlueTEC (155 kW   3.0 Litre)</b>					
09.07 - 12.08	OM 642.920		246-082-008-025G	SWP-M-C	
<b>E 320 (211.065) (165 kW   3.2 Litre)</b>					
03.02 - 12.08	M 112.949		246-082-008-025G	SWP-M-C	
<b>E 320 4-matic (211.082) (165 kW   3.2 Litre)</b>					
03.03 - 12.08	M 112.954		246-082-008-025G	SWP-M-C	
<b>E 320 CDI (211.022) (165 kW   3.0 Litre)</b>					
03.05 - 12.08	OM 642.920		246-082-008-025G	SWP-M-C	
<b>E 320 CDI (211.026) (150 kW   3.2 Litre)</b>					
11.02 - 12.08	OM 648.961		246-082-008-025G	SWP-M-C	
<b>E 320 CDI 4-matic (165 kW   3.0 Litre)</b>					
03.05 - 12.08	OM 642.910		246-082-008-025G	SWP-M-C	
<b>E 350 (211.056) (200 kW   3.5 Litre)</b>					
03.05 - 12.08	M 272.964		246-082-008-025G	SWP-M-C	
<b>E 350 4-matic (211.087) (200 kW   3.5 Litre)</b>					
03.05 - 12.08	M 272.964, M 272.972		246-082-008-025G	SWP-M-C	
<b>E 350 CGI (211.057) (215 kW   3.5 Litre)</b>					
09.07 - 12.08	M 272.985		246-082-008-025G	SWP-M-C	
<b>E 400 CDI (211.028) (191 kW   4.0 Litre)</b>					
02.03 - 12.08	OM 628.961		246-082-008-025G	SWP-M-C	
<b>E 420 CDI (211.029) (231 kW   4.0 Litre)</b>					
01.06 - 12.08	OM 629.910		246-082-008-025G	SWP-M-C	
<b>E 500 (211.070) (225 kW   5.0 Litre)</b>					
03.02 - 12.08	M 113.967		246-082-008-025G	SWP-M-C	
<b>E 500 (211.072) (285 kW   5.5 Litre)</b>					
04.06 - 12.08	M 273.960		246-082-008-025G	SWP-M-C	



			<b>VDO</b>		
Date	Engine Code	Chassis No.	Article No.	Product	Information

**MERCEDES-BENZ****E-CLASS (W211)****E 500 4-matic (211.083) (225 kW | 5.0 Litre)**

10.03 - 12.08 | M 113.969 | 246-082-008-025G | SWP-M-C

**E 55 AMG Kompressor (211.076) (350 kW | 5.5 Litre)**

10.02 - 12.08 | M 113.990 | 246-082-008-025G | SWP-M-C

**E 63 AMG (211.077) (378 kW | 6.2 Litre)**

03.06 - 12.08 | M 156.983 | 246-082-008-025G | SWP-M-C

**E200 NGT (211.041) (120 kW | 1.8 Litre)**

03.04 - 12.08 | M 271.941 | 246-082-008-025G | SWP-M-C

**E-CLASS T-Model (S211)****E 200 T Kompressor (211.242) (120 kW | 1.8 Litre)**

03.03 - 07.09 | M 271.941 | 246-082-008-025G | SWP-M-C

**E 220 T CDI (211.206) (110 kW | 2.1 Litre)**

03.03 - 07.09 | OM 646.961 | 246-082-008-025G | SWP-M-C

**E 240 T (211.261) (130 kW | 2.6 Litre)**

03.03 - 07.09 | M 112.913 | 246-082-008-025G | SWP-M-C

**E 240 T 4-matic (211.280) (130 kW | 2.6 Litre)**

07.03 - 07.09 | M 112.917 | 246-082-008-025G | SWP-M-C

**E 270 T CDI (211.216) (130 kW | 2.7 Litre)**

03.03 - 07.09 | OM 647.961 | 246-082-008-025G | SWP-M-C

**E 280 T (211.254) (170 kW | 3.0 Litre)**

03.05 - 07.09 | M 272.943 | 246-082-008-025G | SWP-M-C

**E 280 T 4-matic (211.292) (170 kW | 3.0 Litre)**

03.05 - 07.09 | M 272.943 | 246-082-008-025G | SWP-M-C

**E 280 T CDI (211.220) (140 kW | 3.0 Litre)**

03.05 - 07.09 | OM 642.920 | 246-082-008-025G | SWP-M-C

**E 280 T CDI (211.223) (130 kW | 3.2 Litre)**

05.04 - 07.09 | OM 648.961 | 246-082-008-025G | SWP-M-C

**E 280 T CDI 4-matic (211.284) (140 kW | 3.0 Litre)**

03.05 - 07.09 | OM 642.921 | 246-082-008-025G | SWP-M-C

**E 320 T (211.265) (165 kW | 3.2 Litre)**

03.03 - 07.09 | M 112.949 | 246-082-008-025G | SWP-M-C

**E 320 T 4-matic (211.282) (165 kW | 3.2 Litre)**

07.03 - 07.09 | M 112.954 | 246-082-008-025G | SWP-M-C

**E 320 T CDI (211.222) (165 kW | 3.0 Litre)**

03.05 - 07.09 | OM 642.920 | 246-082-008-025G | SWP-M-C

**E 320 T CDI (211.226) (150 kW | 3.2 Litre)**

03.03 - 07.09 | OM 648.961 | 246-082-008-025G | SWP-M-C

**E 350 T (211.256) (200 kW | 3.5 Litre)**

03.05 - 07.09 | M 272.964 | 246-082-008-025G | SWP-M-C

**E 500 T (211.270) (225 kW | 5.0 Litre)**

10.03 - 07.09 | M 113.967 | 246-082-008-025G | SWP-M-C

**E 500 T 4-matic (211.283) (225 kW | 5.0 Litre)**

10.03 - 07.09 | M 113.969 | 246-082-008-025G | SWP-M-C

**E 55 T AMG Kompressor (211.276) (350 kW | 5.4 Litre)**

07.03 - 07.09 | M 113.990 | 246-082-008-025G | SWP-M-C

**E-CLASS (W212)****E 200 CDI (212.005) (100 kW | 2.1 Litre)**

01.09 - | OM 651.925 | 246-082-008-025G | SWP-M-C

**E 200 CGI (212.048, 212.148) (135 kW | 1.8 Litre)**

08.09 - | M 271.860, M 271.820 | 246-082-008-025G | SWP-M-C

**E 200 NGT (212.041) (120 kW | 1.8 Litre)**

03.11 - | M 271.958 | 246-082-008-025G | SWP-M-C

**E 220 CDI (212.002) (125 kW | 2.1 Litre)**

01.09 - | OM 651.924 | 246-082-008-025G | SWP-M-C

**E 250 CDI (212.003) (150 kW | 2.1 Litre)**

01.09 - | OM 651.924 | 246-082-008-025G | SWP-M-C

**E 250 CDI 4-matic (212.082) (150 kW | 2.1 Litre)**

01.09 - | OM 651.924 | 246-082-008-025G | SWP-M-C

**E 250 CGI (212.047, 212.147) (150 kW | 1.8 Litre)**

01.09 - | M 271.860 | 246-082-008-025G | SWP-M-C





			<b>VDO</b>		
Date	Engine Code	Chassis No.	Article No.	Product	Information

**MERCEDES-BENZ****E-CLASS (W212)**

<b>E 300 (212.054) (170 kW   3.0 Litre)</b>					
01.09 →	M 272.952		246-082-008-025G	SWP-M-C	
<b>E 300 CDI (212.020, 212.021) (170 kW   3.0 Litre)</b>					
03.11 →	OM 642.850, OM 642.852		246-082-008-025G	SWP-M-C	
<b>E 350 (212.059) (225 kW   3.5 Litre)</b>					
09.11 →	M 276.952		246-082-008-025G	SWP-M-C	
<b>E 350 4-matic (212.087) (200 kW   3.5 Litre)</b>					
01.09 → 08.11	M 272.977		246-082-008-025G	SWP-M-C	
<b>E 350 4-matic (212.088) (225 kW   3.5 Litre)</b>					
09.11 →	M 276.952		246-082-008-025G	SWP-M-C	
<b>E 350 BlueTEC (212.024) (155 kW   3.0 Litre)</b>					
01.09 →	OM 642.850		246-082-008-025G	SWP-M-C	
<b>E 350 CDI (212.023) (195 kW   3.0 Litre)</b>					
03.11 →	OM 642.852		246-082-008-025G	SWP-M-C	
<b>E 350 CDI (212.025) (170 kW   3.0 Litre)</b>					
01.09 →	OM 642.850		246-082-008-025G	SWP-M-C	
<b>E 350 CDI 4-matic (212.089) (170 kW   3.0 Litre)</b>					
09.09 →	OM 642.856		246-082-008-025G	SWP-M-C	
<b>E 350 CDI 4-matic (212.093) (195 kW   3.0 Litre)</b>					
03.11 →	OM 642.858		246-082-008-025G	SWP-M-C	
<b>E 350 CGI (212.057) (215 kW   3.5 Litre)</b>					
01.09 → 08.11	M 272.983		246-082-008-025G	SWP-M-C	
<b>E 500 (212.072) (285 kW   5.5 Litre)</b>					
01.09 →	M 273.971		246-082-008-025G	SWP-M-C	
<b>E 500 (212.073) (300 kW   4.7 Litre)</b>					
09.11 →	M 278.922		246-082-008-025G	SWP-M-C	
<b>E 500 4-matic (212.090) (285 kW   5.5 Litre)</b>					
01.09 →	M 273.970		246-082-008-025G	SWP-M-C	
<b>E 500 4-matic (212.091) (300 kW   4.7 Litre)</b>					
09.11 →	M 278.922		246-082-008-025G	SWP-M-C	
<b>E 63 AMG (212.074) (386 kW   5.5 Litre)</b>					
02.11 →	M 157.980, M 157.981		246-082-008-025G	SWP-M-C	
<b>E 63 AMG (212.077) (386 kW   6.2 Litre)</b>					
12.09 →	M 156.985		246-082-008-025G	SWP-M-C	

**E-CLASS T-Model (S212)**

<b>E 200 CDI (212.205) (100 kW   2.1 Litre)</b>					
11.09 →	OM 651.925		246-083-002-022G	SWP-D-C	
<b>E 200 CGI (212.248) (135 kW   1.8 Litre)</b>					
11.09 →	M 271.820, M 271.860		246-083-002-022G	SWP-D-C	
<b>E 220 CDI (212.202) (125 kW   2.1 Litre)</b>					
11.09 →	OM 651.924		246-083-002-022G	SWP-D-C	
<b>E 250 CDI (212.203) (150 kW   2.1 Litre)</b>					
11.09 →	OM 651.924		246-083-002-022G	SWP-D-C	
<b>E 250 CGI (212.247) (150 kW   1.8 Litre)</b>					
11.09 →	M 271.860		246-083-002-022G	SWP-D-C	
<b>E 350 4-matic (212.287) (200 kW   3.5 Litre)</b>					
11.09 →	M 272.977		246-083-002-022G	SWP-D-C	
<b>E 350 BlueTEC (212.224) (155 kW   3.0 Litre)</b>					
11.09 →	OM 642.850		246-083-002-022G	SWP-D-C	
<b>E 350 CDI (212.225) (170 kW   3.0 Litre)</b>					
11.09 →	OM 642.850		246-083-002-022G	SWP-D-C	
<b>E 350 CDI 4-matic (212.289) (170 kW   3.0 Litre)</b>					
11.09 →	OM 642.856		246-083-002-022G	SWP-D-C	
<b>E 350 CGI (212.257) (215 kW   3.5 Litre)</b>					
11.09 →	M 272.983		246-083-002-022G	SWP-D-C	
<b>E 500 (212.272) (285 kW   5.5 Litre)</b>					
11.09 →	M 273.971		246-083-002-022G	SWP-D-C	
<b>E 63 AMG (212.277) (386 kW   6.2 Litre)</b>					
08.09 →	M 156.985		246-083-002-022G	SWP-D-C	



			<b>VDO</b>		
Date	Engine Code	Chassis No.	Article No.	Product	Information

**MERCEDES-BENZ****E-CLASS Coupe (C207)****E 200 CGI (207.348) (135 kW | 1.8 Litre)**

01.10 → M 271.860, M 271.820

246-082-008-025G

SWP-M-C

**E 220 CDI (207.302) (125 kW | 2.2 Litre)**

01.10 → OM 651.911

246-082-008-025G

SWP-M-C

**E 250 CDI (207.303) (150 kW | 2.2 Litre)**

01.09 → OM 651.911

246-082-008-025G

SWP-M-C

**E 250 CGI (207.347) (150 kW | 1.8 Litre)**

01.09 → M 271.860

246-082-008-025G

SWP-M-C

**E 300 (185 kW | 3.5 Litre)**

04.11 → M 276.957

246-082-008-025G

SWP-M-C

**E 350 (225 kW | 3.5 Litre)**

04.11 → M 276.957

246-082-008-025G

SWP-M-C

**E 350 CDI (195 kW | 3.0 Litre)**

04.11 → OM 642.838

246-082-008-025G

SWP-M-C

**E 350 CDI (207.322) (170 kW | 3.0 Litre)**

01.09 → OM 642.836

246-082-008-025G

SWP-M-C

**E 350 CGI (207.357) (215 kW | 3.5 Litre)**

01.09 → M 272.984, M 272.982

246-082-008-025G

SWP-M-C

**E 500 (207.372) (285 kW | 5.5 Litre)**

01.09 → M 273.966

246-082-008-025G

SWP-M-C

**E 550 CGI (207.373) (300 kW | 4.7 Litre)**

09.11 → M 278.922

246-082-008-025G

SWP-M-C

**E-CLASS Convertible (A207)****E 200 CGI (207.448) (135 kW | 1.8 Litre)**

01.10 → M 271.860, M 271.820

246-082-008-025G

SWP-M-C

**E 220 CDI (207.402) (125 kW | 2.2 Litre)**

01.10 → OM 651.911

246-082-008-025G

SWP-M-C

**E 250 CDI (207.403) (150 kW | 2.2 Litre)**

01.10 → OM 651.911

246-082-008-025G

SWP-M-C

**E 250 CGI (207.447) (150 kW | 1.8 Litre)**

01.10 → M 271.860

246-082-008-025G

SWP-M-C

**E 300 (185 kW | 3.5 Litre)**

04.11 → M 276.957

246-082-008-025G

SWP-M-C

**E 350 (225 kW | 3.5 Litre)**

04.11 → M 276.957

246-082-008-025G

SWP-M-C

**E 350 CDI (195 kW | 3.0 Litre)**

04.11 → OM 642.838

246-082-008-025G

SWP-M-C

**E 350 CDI (207.422) (170 kW | 3.0 Litre)**

01.10 → OM 642.836

246-082-008-025G

SWP-M-C

**E 350 CGI (207.457) (215 kW | 3.5 Litre)**

01.10 → M 272.984, M 272.982

246-082-008-025G

SWP-M-C

**E 500 (207.472) (285 kW | 5.5 Litre)**

01.10 → M 273.966

246-082-008-025G

SWP-M-C

**E 550 CGI (300 kW | 4.7 Litre)**

09.11 → M 278.922

246-082-008-025G

SWP-M-C

**HECKFLOSSE (W111, W112)****220 SEB (111.014) (88 kW | 2.2 Litre)**

08.59 → 08.65 M 127.982

246-075-017-002C

SWP-M-G

Plug Number (T2): 4

**COUPE (W111)****220 SEB (111.021) (88 kW | 2.2 Litre)**

01.61 → 12.65 M 127.984

246-075-017-002C

SWP-M-G

Plug Number (T2): 4

**250 SE (111.021) (110 kW | 2.5 Litre)**

01.65 → 12.67 M 129.980, M 129.981

246-075-017-002C

SWP-M-G

Plug Number (T2): 4

**280 SE (111.024) (118 kW | 2.7 Litre)**

01.67 → 12.71 M 130.980, M 130.984

246-075-017-002C

SWP-M-G

Plug Number (T2): 4

**280 SE 3.5 (111.026) (147 kW | 3.5 Litre)**

01.69 → 12.71 M 116.980

246-075-017-002C

SWP-M-G

Plug Number (T2): 4



Date	Engine Code	Chassis No.	Article No.	Product	Information

**MERCEDES-BENZ****S-CLASS (W108, W109)**

<b>250 S (108.012) (96 kW   2.5 Litre)</b>					
01.66 - 12.69	M 108.920		246-069-026-001G	N	
<b>250 SE (108.014) (110 kW   2.5 Litre)</b>					
01.66 - 12.67	M 129.980		246-075-017-002C	SWP-M-G	Plug Number (T2): 4
<b>280 S (108.016) (103 kW   2.7 Litre)</b>					
10.67 - 07.72	M 130.920		246-069-026-001G	N	
<b>280 SE,SEL (108.018, 108.019) (118 kW   2.7 Litre)</b>					
01.68 - 08.72	M 130.980		246-069-026-001G	N	
<b>280 SE,SEL 3.5 (108.057, 108.058) (147 kW   3.5 Litre)</b>					
03.71 - 08.72	M 116.980		246-069-026-001G	N	
<b>300 SEL (109.016) (118 kW   2.7 Litre)</b>					
01.68 - 08.72	M 130.981		246-069-026-001G	N	
<b>300 SEL 3.5 (109.056) (147 kW   3.5 Litre)</b>					
01.70 - 07.72	M 116.981		246-069-026-001G	N	
<b>300 SEL 6.3 (109.018) (184 kW   6.3 Litre)</b>					
03.68 - 08.72	M 100.981		246-069-026-001G	N	

**S-CLASS (W116)**

<b>280 S (116.020) (115 kW   2.7 Litre)</b>					
08.72 - 07.80	M 110.922		246-075-017-002C	SWP-M-G	Plug Number (T2): 4
<b>280 S (116.020) (118 kW   2.7 Litre)</b>					
08.72 - 07.80	M 110.922		246-075-017-002C	SWP-M-G	Plug Number (T2): 4
<b>280 SE,SEL (116.024) (130 kW   2.7 Litre)</b>					
08.72 - 07.80	M 110.985		246-075-017-002C	SWP-M-G	Plug Number (T2): 4
<b>280 SE,SEL (116.024) (136 kW   2.7 Litre)</b>					
08.72 - 07.80	M 110.983, M 110.985		246-075-017-002C	SWP-M-G	Plug Number (T2): 4
<b>350 SE,SEL (116.028, 116.029) (143 kW   3.5 Litre)</b>					
03.76 - 03.80	M 116.985		246-075-017-002C	SWP-M-G	Plug Number (T2): 4
<b>350 SE,SEL (116.028, 116.029) (147 kW   3.5 Litre)</b>					
08.72 - 02.76	M 116.983		246-075-017-002C	SWP-M-G	Plug Number (T2): 4
<b>350 SE,SEL (116.028, 116.029) (151 kW   3.5 Litre)</b>					
03.76 - 03.80	M 116.985		246-075-017-002C	SWP-M-G	Plug Number (T2): 4
<b>450 SE,SEL (116.032) (165 kW   4.5 Litre)</b>					
01.73 - 04.80	M 117.983, M 117.986		246-075-017-002C	SWP-M-G	Plug Number (T2): 4
01.73 - 04.80	M 117.983, M 117.986		246-075-021-007C	SWP-M-G	Plug Number (T2): 1; T25: A000 869 30 21
<b>450 SE,SEL (116.033) (160 kW   4.5 Litre)</b>					
12.75 - 04.80	M 117.985, M 117.986		246-075-017-002C	SWP-M-G	Plug Number (T2): 4
12.75 - 04.80	M 117.986, M 117.985		246-075-021-007C	SWP-M-G	Plug Number (T2): 1; T25: A000 869 30 21
<b>450 SEL 6.9 (116.036) (210 kW   6.8 Litre)</b>					
07.75 - 03.80	M 100.985		246-075-017-002C	SWP-M-G	Plug Number (T2): 4
07.75 - 03.80	M 100.985		246-075-021-007C	SWP-M-G	Plug Number (T2): 1; T25: A000 869 30 21

**SL Coupe (C107)**

<b>280 SLC (107.022) (130 kW   2.7 Litre)</b>					
06.76 - 08.81	M 110.982, M 110.986, M 110.990		246-082-008-013P	SWP-M-C	Plug Number (T2): 4; T25: 140 869 02 21, etc.
<b>350 SLC (107.023) (147 kW   3.5 Litre)</b>					
01.72 - 01.76	M 116.982, M 116.984		246-082-008-013P	SWP-M-C	Plug Number (T2): 4; T25: 140 869 02 21, etc.
<b>450 SLC 5.0 (107.026) (177 kW   4.9 Litre)</b>					
06.78 - 02.80	M 117.960		246-082-008-013P	SWP-M-C	Plug Number (T2): 4; T25: 140 869 02 21, etc.

**S-CLASS (W126)**

<b>260 SE (126.020) (118 kW   2.5 Litre)</b>					
09.85 - 06.91	M 103.941		246-080-003-006D	N-H	
09.85 - 06.91	M 103.941		246-082-008-013P	SWP-M-C	Plug Number (T2): 4; T25: 140 869 02 21, etc.
<b>260 SE (126.020) (122 kW   2.5 Litre)</b>					
09.85 - 06.91	M 103.941		246-080-003-006D	N-H	
09.85 - 06.91	M 103.941		246-082-008-013P	SWP-M-C	Plug Number (T2): 4; T25: 140 869 02 21, etc.
<b>280 S (126.021) (115 kW   2.7 Litre)</b>					
12.79 - 07.85	M 110.924, M 110.926		246-080-003-006D	N-H	
12.79 - 07.85	M 110.924, M 110.926		246-082-005-002C	SWP-M-C	Plug Number (T2): 4; T25: 124 869 03 21, etc.
12.79 - 07.85	M 110.924, M 110.926		246-082-008-013P	SWP-M-C	Plug Number (T2): 4; T25: 140 869 02 21, etc.
<b>280 SE,SEL (126.022, 126.023) (136 kW   2.7 Litre)</b>					
10.79 - 07.85	M 110.987, M 110.989		246-080-003-006D	N-H	



			<b>VDO</b>		
Date	Engine Code	Chassis No.	Article No.	Product	Information

**MERCEDES-BENZ****S-CLASS (W126)**

<b>280 SE,SEL (126.022, 126.023) (136 kW   2.7 Litre)</b>					
10.79 - 07.85	M 110.987, M 110.989		246-082-008-013P	SWP-M-C	Plug Number (T2): 4; T25: 140 869 02 21, etc.
<b>3.8 (160 kW   3.8 Litre)</b>					
08.80 - 08.84	M 116.960		246-080-003-006D	N-H	
<b>300 SE,SEL (126.024, 126.025) (132 kW   3.0 Litre)</b>					
01.86 - 06.91	M 103.981		246-080-003-006D	N-H	
01.86 - 06.91	M 103.981		246-082-008-013P	SWP-M-C	Plug Number (T2): 4; T25: 140 869 02 21, etc.
<b>300 SE,SEL (126.024, 126.025) (138 kW   3.0 Litre)</b>					
09.85 - 12.89	M 103.981		246-080-003-006D	N-H	
09.85 - 12.89	M 103.981		246-082-008-013P	SWP-M-C	Plug Number (T2): 4; T25: 140 869 02 21, etc.
<b>380 SE,SEL (126.032) (150 kW   3.8 Litre)</b>					
12.79 - 08.85	M 116.963		246-080-003-006D	N-H	
01.80 - 08.85	M 116.963		246-082-008-013P	SWP-M-C	Plug Number (T2): 4; T25: 140 869 02 21, etc.
<b>380 SE,SEL (126.032) (160 kW   3.8 Litre)</b>					
12.85 - 12.86	M 116.961		246-080-003-006D	N-H	
12.85 - 12.86	M 116.961		246-082-008-013P	SWP-M-C	Plug Number (T2): 4; T25: 140 869 02 21, etc.
<b>420 SE,SEL (126.034) (150 kW   4.1 Litre)</b>					
10.85 - 06.91	M 116.965		246-080-003-006D	N-H	
10.85 - 06.91	M 116.965		246-082-008-013P	SWP-M-C	Plug Number (T2): 4; T25: 140 869 02 21, etc.
<b>420 SE,SEL (126.034) (160 kW   4.1 Litre)</b>					
10.85 - 12.87	M 116.965		246-080-003-006D	N-H	
10.85 - 12.87	M 116.965		246-082-008-013P	SWP-M-C	Plug Number (T2): 4; T25: 140 869 02 21, etc.
<b>420 SE,SEL (165 kW   4.1 Litre)</b>					
10.85 - 06.91	M 116.965		246-080-003-006D	N-H	
10.85 - 06.91	M 116.965		246-082-008-013P	SWP-M-C	Plug Number (T2): 4; T25: 140 869 02 21, etc.
<b>420 SE,SEL (170 kW   4.1 Litre)</b>					
10.85 - 12.87	M 116.965		246-080-003-006D	N-H	
10.85 - 12.87	M 116.965		246-082-008-013P	SWP-M-C	Plug Number (T2): 4; T25: 140 869 02 21, etc.
<b>500 SE,SEL (126.036) (164 kW   4.9 Litre)</b>					
09.85 - 06.91	M 117.965		246-080-003-006D	N-H	
09.85 - 06.91	M 117.965		246-082-008-013P	SWP-M-C	Plug Number (T2): 4; T25: 140 869 02 21, etc.
<b>500 SE,SEL (126.036) (170 kW   4.9 Litre)</b>					
12.79 - 08.85	M 117.961, M 117.963		246-080-003-006D	N-H	
12.79 - 08.85	M 117.961, M 117.963		246-082-008-013P	SWP-M-C	Plug Number (T2): 4; T25: 140 869 02 21, etc.
<b>500 SE,SEL (126.036) (177 kW   4.9 Litre)</b>					
12.79 - 08.85	M 117.961, M 117.963		246-080-003-006D	N-H	
12.79 - 08.85	M 117.961, M 117.963		246-082-008-013P	SWP-M-C	Plug Number (T2): 4; T25: 140 869 02 21, etc.
<b>500 SE,SEL (126.036) (180 kW   4.9 Litre)</b>					
09.85 - 06.91	M 117.965		246-080-003-006D	N-H	
09.85 - 06.91	M 117.965		246-082-008-013P	SWP-M-C	Plug Number (T2): 4; T25: 140 869 02 21, etc.
<b>500 SE,SEL (185 kW   4.9 Litre)</b>					
09.87 - 06.91	M 117.965		246-080-003-006D	N-H	
09.87 - 06.91	M 117.965		246-082-008-013P	SWP-M-C	Plug Number (T2): 4; T25: 140 869 02 21, etc.
<b>500 SE,SEL (195 kW   4.9 Litre)</b>					
09.87 - 06.91	M 117.965		246-080-003-006D	N-H	
09.87 - 06.91	M 117.965		246-082-008-013P	SWP-M-C	Plug Number (T2): 4; T25: 140 869 02 21, etc.
<b>500 SE,SEL CAT (185 kW   5.0 Litre)</b>					
06.89 - 06.91	M 117.965		246-080-003-006D	N-H	
06.89 - 06.91	M 117.965		246-082-008-013P	SWP-M-C	Plug Number (T2): 4; T25: 140 869 02 21, etc.
<b>560 SE,SEL (126.038) (178 kW   5.5 Litre)</b>					
10.85 - 06.91	M 117.968		246-080-003-006D	N-H	
10.85 - 06.91	M 117.968		246-082-005-002C	SWP-M-C	Plug Number (T2): 4; T25: 124 869 03 21, etc.
10.85 - 06.91	M 117.968		246-082-008-013P	SWP-M-C	Plug Number (T2): 4; T25: 140 869 02 21, etc.
<b>560 SE,SEL (126.038) (200 kW   5.5 Litre)</b>					
10.85 - 12.87	M 117.968		246-080-003-006D	N-H	
10.85 - 12.87	M 117.968		246-082-005-002C	SWP-M-C	Plug Number (T2): 4; T25: 124 869 03 21, etc.
<b>560 SE,SEL (205 kW   5.5 Litre)</b>					
08.87 - 06.91	M 117.968		246-080-003-006D	N-H	
08.87 - 06.91	M 117.968		246-082-005-002C	SWP-M-C	Plug Number (T2): 4; T25: 124 869 03 21, etc.
<b>560 SE,SEL (220 kW   5.5 Litre)</b>					
10.85 - 06.91	M 117.968		246-080-003-006D	N-H	
10.85 - 06.91	M 117.968		246-082-005-002C	SWP-M-C	Plug Number (T2): 4; T25: 124 869 03 21, etc.



			<b>VDO</b>		
<b>Date</b>	<b>Engine Code</b>	<b>Chassis No.</b>	<b>Article No.</b>	<b>Product</b>	<b>Information</b>

**MERCEDES-BENZ****S-CLASS Coupe (C126)****380 SEC (126.043) (150 kW | 3.8 Litre)**

10.81 → 07.85 | M 116.963 | | 246-082-008-013P | SWP-M-C | Plug Number (T2): 4; T25: 140 869 02 21, etc.

**420 SEC (126.046) (150 kW | 4.1 Litre)**

10.85 → 06.91 | M 116.965 | | 246-082-008-013P | SWP-M-C | Plug Number (T2): 4; T25: 140 869 02 21, etc.

**500 SEC (126.044) (170 kW | 4.9 Litre)**

10.81 → 08.85 | M 117.963 | | 246-082-008-013P | SWP-M-C | Plug Number (T2): 4; T25: 140 869 02 21, etc.

**500 SEC (126.044) (195 kW | 5.0 Litre)**

09.85 → 07.89 | M 117.965 | | 246-082-008-013P | SWP-M-C | Plug Number (T2): 4; T25: 140 869 02 21, etc.

**560 SEC (126.045) (178 kW | 5.5 Litre)**

10.85 → 06.91 | M 117.968 | | 246-082-008-013P | SWP-M-C | Plug Number (T2): 4; T25: 140 869 02 21, etc.

**560 SEC (126.045) (205 kW | 5.5 Litre)**

10.85 → 06.91 | M 117.968 | | 246-082-005-002C | SWP-M-C | Plug Number (T2): 4; T25: 124 869 03 21, etc.

**560 SEC (126.045) (220 kW | 5.5 Litre)**

10.85 → 12.89 | M 117.968 | | 246-082-005-002C | SWP-M-C | Plug Number (T2): 4; T25: 124 869 03 21, etc.

**S-CLASS (W140)****300 SE 2.8 (140.028) (145 kW | 2.8 Litre)**

01.93 → 10.98 | M 104.944 | | 246-082-008-013P | SWP-M-C | Plug Number (T2): 4; T25: 140 869 02 21, etc.

01.93 → 10.98 | M 104.944 | | 246-082-008-025G | SWP-M-C |

**300 SE,SEL/S320 (140.032, 140.033) (170 kW | 3.2 Litre)**

03.91 → 10.98 | M 104.990, M 104.994 | | 246-082-005-002C | SWP-M-C | Plug Number (T2): 4; T25: 124 869 03 21, etc.

03.91 → 06.93 | M 104.990, M 104.994 | →A328810 | 246-082-008-013P | SWP-M-C | Plug Number (T2): 4; T25: 140 869 02 21, etc.

03.91 → 10.98 | M 104.990, M 104.994 | | 246-082-008-025G | SWP-M-C |

**400 SE,SEL/S420 (140.042, 140.043) (210 kW | 4.2 Litre)**

03.91 → 06.93 | M 119.971 | →A328810 | 246-082-008-013P | SWP-M-C | Plug Number (T2): 4; T25: 140 869 02 21, etc.

02.91 → 10.98 | M 119.971 | →A328810 | 246-082-008-025G | SWP-M-C |

**500 SE,SEL (140.050, 140.051) (240 kW | 5.0 Litre)**

03.91 → 06.93 | M 119.970 | →A328810 | 246-082-008-013P | SWP-M-C | Plug Number (T2): 4; T25: 140 869 02 21, etc.

02.91 → 10.98 | M 119.970 | | 246-082-008-025G | SWP-M-C |

**600 SE,SEL (140.056, 140.057) (300 kW | 6.0 Litre)**

04.91 → 12.92 | M 120.980, M 120.982 | →A328810 | 246-082-008-013P | SWP-M-C | Plug Number (T2): 4; T25: 140 869 02 21, etc.

04.91 → 12.92 | M 120.980, M 120.982 | →A328810 | 246-082-008-025G | SWP-M-C |

**S 280 (140.028) (142 kW | 2.8 Litre)**

02.93 → 10.98 | M 104.944 | | 246-082-008-013P | SWP-M-C | Plug Number (T2): 4; T25: 140 869 02 21, etc.

02.93 → 10.98 | M 104.944 | | 246-082-008-025G | SWP-M-C |

**S 300 Turbo-D (140.135) (130 kW | 3.0 Litre)**

08.96 → 08.98 | OM 606.961 | →A328810 | 246-082-008-013P | SWP-M-C | Plug Number (T2): 4; T25: 140 869 02 21, etc.

05.96 → 10.98 | OM 606.961 | →A328810 | 246-082-008-025G | SWP-M-C |

**S 350 Turbo-D (140.134) (110 kW | 3.4 Litre)**

07.93 → 08.98 | OM 603.971 | →A328810 | 246-082-008-013P | SWP-M-C | Plug Number (T2): 4; T25: 140 869 02 21, etc.

01.93 → 10.98 | OM 603.971 | | 246-082-008-025G | SWP-M-C |

**S 420 (140.042) (205 kW | 4.2 Litre)**

07.93 → 08.98 | M 119.971 | →A328810 | 246-082-008-013P | SWP-M-C | Plug Number (T2): 4; T25: 140 869 02 21, etc.

01.93 → 10.98 | M 119.971 | | 246-082-008-025G | SWP-M-C |

**S 500 (140.050, 140.051) (235 kW | 5.0 Litre)**

07.93 → 08.98 | M 119.970, M 119.980 | →A328810 | 246-082-008-013P | SWP-M-C | Plug Number (T2): 4; T25: 140 869 02 21, etc.

01.93 → 10.98 | M 119.970, M 119.980 | | 246-082-008-025G | SWP-M-C |

**S 600 (140.056, 140.057) (290 kW | 6.0 Litre)**

07.93 → 08.98 | M 120.980, M 120.982 | →A328810 | 246-082-008-013P | SWP-M-C | Plug Number (T2): 4; T25: 140 869 02 21, etc.

01.93 → 10.98 | M 120.980, M 120.982 | →A328810 | 246-082-008-025G | SWP-M-C |

**S-CLASS Coupe (C140)****SEC/CL 420 (140.063) (205 kW | 4.2 Litre)**

10.94 → 07.96 | M 119.971, M 119.981 | →A328810 | 246-082-008-013P | SWP-M-C | Plug Number (T2): 4; T25: 140 869 02 21, etc.

10.94 → 02.99 | M 119.971, M 119.981 | →A328810 | 246-082-008-025G | SWP-M-C |

**SEC/CL 500 (140.070) (235 kW | 5.0 Litre)**

10.92 → 07.96 | M 119.970 | →A328810 | 246-082-008-013P | SWP-M-C | Plug Number (T2): 4; T25: 140 869 02 21, etc.

10.92 → 06.93 | M 119.970 | | 246-082-008-025G | SWP-M-C |

**SEC/CL 600 (140.076) (290 kW | 6.0 Litre)**

09.92 → 07.96 | M 120.980, M 120.982 | →A328810 | 246-082-008-013P | SWP-M-C | Plug Number (T2): 4; T25: 140 869 02 21, etc.

09.92 → 02.99 | M 120.980, M 120.982 | | 246-082-008-025G | SWP-M-C |



			<b>VDO</b>		
Date	Engine Code	Chassis No.	Article No.	Product	Information

**MERCEDES-BENZ****S-CLASS (W220)****S 280 (220.063, 220.163) (150 kW | 2.8 Litre)**

10.98 - 08.05 | M 112.922 | --A316070 | 246-082-008-025G | SWP-M-C

**S 320 (220.065, 220.165) (165 kW | 3.2 Litre)**

10.98 - 08.05 | M 112.944 | --A316070 | 246-082-008-025G | SWP-M-C

**S 320 CDI (220.025, 220.125) (150 kW | 3.2 Litre)**

09.02 - 08.05 | OM 648.960 | | 246-082-008-025G | SWP-M-C

**S 320 CDI (220.026, 220.126) (145 kW | 3.2 Litre)**

08.99 - 09.02 | OM 613.960 | --A316070 | 246-082-008-025G | SWP-M-C

**S 350 (220.067, 220.167) (180 kW | 3.7 Litre)**

09.02 - 08.05 | M 112.972 | | 246-082-008-025G | SWP-M-C

**S 350 4-matic (220.087, 220.187) (180 kW | 3.7 Litre)**

06.03 - 08.05 | M 112.975 | | 246-082-008-025G | SWP-M-C

**S 400 CDI (220.028, 220.128) (184 kW | 4.0 Litre)**

06.00 - 08.05 | OM 628.960 | --A316070 | 246-082-008-025G | SWP-M-C

**S 400 CDI (220.028, 220.128) (191 kW | 4.0 Litre)**

06.03 - 08.05 | OM 628.960 | | 246-082-008-025G | SWP-M-C

**S 430 (220.070, 220.170) (205 kW | 4.3 Litre)**

10.98 - 08.05 | M 113.941 | --A316070 | 246-082-008-025G | SWP-M-C

**S 430 4-matic (220.083, 220.183) (205 kW | 4.3 Litre)**

09.02 - 08.05 | M 113.948 | | 246-082-008-025G | SWP-M-C

**S 500 (220.075, 220.175, 220.875) (225 kW | 5.0 Litre)**

10.98 - 08.05 | M 113.960 | | 246-082-008-025G | SWP-M-C

**S 500 4-matic (220.084, 220.184) (225 kW | 5.0 Litre)**

09.02 - 08.05 | M 113.966 | | 246-082-008-025G | SWP-M-C

**S 55 AMG (220.073, 220.173) (265 kW | 5.5 Litre)**

04.99 - 08.05 | M 113.986 | --A316070 | 246-082-008-025G | SWP-M-C

**S 55 AMG Kompressor (220.074, 220.174) (368 kW | 5.5 Litre)**

06.02 - 08.05 | M 113.991 | --A316070 | 246-082-008-025G | SWP-M-C

**S 600 (220.176) (368 kW | 5.5 Litre)**

09.02 - 08.05 | M 275.950 | | 246-082-008-025G | SWP-M-C

**S 600 (220.878, 220.178) (270 kW | 5.8 Litre)**

01.00 - 08.05 | M 137.970 | --A316070 | 246-082-008-025G | SWP-M-C

**S 63 AMG (326 kW | 6.3 Litre)**

09.01 - 08.05 | M 137.980 | | 246-082-008-025G | SWP-M-C

**S 65 AMG (220.179) (450 kW | 6.0 Litre)**

03.04 - 08.05 | M 275.980 | | 246-082-008-025G | SWP-M-C

**S-CLASS Coupe (C215)****CL 500 (215.375) (225 kW | 5.0 Litre)**

03.99 - 07.99 | M 113.960 | --A328810 | 246-082-008-013P | SWP-M-C | Plug Number (T2): 4; T25: 140 869 02 21, etc.

03.99 - 03.06 | M 113.960 | --A316070 | 246-082-008-025G | SWP-M-C

**CL 600 (215.378) (270 kW | 5.8 Litre)**

03.99 - 07.99 | M 137.970 | --A328810 | 246-082-008-013P | SWP-M-C | Plug Number (T2): 4; T25: 140 869 02 21, etc.

03.99 - 03.06 | M 137.970 | --A316070 | 246-082-008-025G | SWP-M-C

**S-CLASS (W221)****S 250 CDI (221.003, 221.103) (150 kW | 2.1 Litre)**

01.11 - | OM 651.961 | | 246-082-008-025G | SWP-M-C

**S 320 CDI / S 350 CDI (221.022, 221.122) (173 kW | 3.0 Litre)**

12.05 - | OM 642.930 | | 246-082-008-025G | SWP-M-C

**S 320 CDI 4-matic (221.080, 221.180) (173 kW | 3.0 Litre)**

10.06 - | OM 642.932 | | 246-082-008-025G | SWP-M-C

**S 350 (221.056, 221.156) (200 kW | 3.5 Litre)**

10.05 - | M 272.965 | | 246-082-008-025G | SWP-M-C

**S 350 4-matic (221.087, 221.187) (200 kW | 3.5 Litre)**

02.08 - | M 272.975 | | 246-082-008-025G | SWP-M-C

**S 350 BlueTec (221.026, 221.126) (190 kW | 3.0 Litre)**

04.11 - | OM 642.862 | | 246-082-008-025G | SWP-M-C

**S 350 BlueTEC 4-matic (221.083, 221.183) (190 kW | 3.0 Litre)**

04.11 - | OM 642.868 | | 246-082-008-025G | SWP-M-C

**S 350 CGI (221.057, 221.157) (225 kW | 3.5 Litre)**

04.11 - | M 276.950 | | 246-082-008-025G | SWP-M-C



			<b>VDO</b>		
Date	Engine Code	Chassis No.	Article No.	Product	Information

**MERCEDES-BENZ****S-CLASS (W221)****S 350 CGI 4-matic (221.082, 221.182) (225 kW | 3.5 Litre)**

04.11 → M 276.950 246-082-008-025G SWP-M-C

**S 400 Hybrid (221.095, 221.195) (205 kW | 3.5 Litre)**

01.09 → M 272.974 246-082-008-025G SWP-M-C

**S 420 CDI / S 450 CDI (221.028, 221.128) (235 kW | 4.0 Litre)**

10.06 → OM 629.911 246-082-008-025G SWP-M-C

**S 450 (221.070, 221.170) (250 kW | 4.7 Litre)**

12.05 → M 273.922 246-082-008-025G SWP-M-C

**S 450 4-matic (221.084, 221.184) (250 kW | 4.7 Litre)**

12.05 → M 273.924 246-082-008-025G SWP-M-C

**S 500 (221.071, 221.171) (285 kW | 5.5 Litre)**

10.05 → M 273.961 246-082-008-025G SWP-M-C

**S 500 4-matic (221.086, 221.186) (285 kW | 5.5 Litre)**

10.05 → M 273.961, M 273.968 246-082-008-025G SWP-M-C

**S 500 CGI 4-matic (221.094, 221.194) (320 kW | 4.7 Litre)**

03.11 → M 278.932 246-082-008-025G SWP-M-C

**S 500 CGI (221.073, 221.173) (320 kW | 4.7 Litre)**

04.11 → M 278.932 246-082-008-025G SWP-M-C

**S 600 (221.176) (380 kW | 5.5 Litre)**

12.05 → M 275.953 246-082-008-025G SWP-M-C

**S 63 AMG (221.074, 221.174) (400 kW | 5.5 Litre)**

03.11 → M 157.980 246-082-008-025G SWP-M-C

**S 63 AMG (221.077, 221.177) (386 kW | 6.2 Litre)**

10.06 → M 156.984 246-082-008-025G SWP-M-C

**S 65 AMG (221.179) (450 kW | 6.0 Litre)**

12.05 → M 275.982 246-082-008-025G SWP-M-C

**S 65 AMG (221.179) (463 kW | 6.0 Litre)**

04.11 → M 275.982 246-082-008-025G SWP-M-C

**S-CLASS Coupe (C216)****CL 500 (216.371) (285 kW | 5.5 Litre)**

06.06 → M 273.961 246-082-008-025G SWP-M-C

**CL 500 (216.373) (320 kW | 4.7 Litre)**

02.11 → M 278.920 246-082-008-025G SWP-M-C

**CL 500 4-matic (216.386) (285 kW | 5.5 Litre)**

02.08 → M 273.968 246-082-008-025G SWP-M-C

**CL 500 4-matic (216.394) (320 kW | 4.7 Litre)**

02.11 → M 278.920 246-082-008-025G SWP-M-C

**CL 600 (216.376) (380 kW | 5.5 Litre)**

05.06 → M 275.953 246-082-008-025G SWP-M-C

**CL 63 AMG (216.374) (400 kW | 5.5 Litre)**

02.11 → M 157.980 246-082-008-025G SWP-M-C

**CL 63 AMG (216.377) (386 kW | 6.2 Litre)**

10.06 → M 156.984 246-082-008-025G SWP-M-C

**CL 65 AMG (216.379) (450 kW | 6.0 Litre)**

10.06 → M 275.982 246-082-008-025G SWP-M-C

**CL 65 AMG (216.379) (463 kW | 6.0 Litre)**

02.11 → M 275.982 246-082-008-025G SWP-M-C

**PAGODE (W113)****230 SL (113.042) (110 kW | 2.3 Litre)**

01.63 → 01.67 M 127.981 246-075-017-002C SWP-M-G Plug Number (T2): 4

**250 SL (113.043) (110 kW | 2.5 Litre)**

01.66 → 01.68 M 129.982 246-075-017-002C SWP-M-G Plug Number (T2): 4

**280 SL (113.044) (125 kW | 2.7 Litre)**

01.68 → 03.71 M 130.983 246-075-017-002C SWP-M-G Plug Number (T2): 4

**CABRIOLET (W111)****280 SE 3.5 (111.025) (147 kW | 3.5 Litre)**

01.69 → 12.71 M 116.980 246-075-017-002C SWP-M-G Plug Number (T2): 4



			<b>VDO</b>		
Date	Engine Code	Chassis No.	Article No.	Product	Information

**MERCEDES-BENZ****SL (R107)****280 SL (107.042) (130 kW | 2.7 Litre)**

06.76 - 09.81	M 110.982, M 110.986, M 110.990		246-075-017-002C	SWP-M-G	Plug Number (T2): 4
06.76 - 09.81	M 110.982, M 110.986, M 110.990		246-082-005-002C	SWP-M-C	Plug Number (T2): 4; T25: 124 869 03 21, etc.

**280 SL (107.042) (136 kW | 2.7 Litre)**

08.74 - 07.85	M 110.982, M 110.986, M 110.990		246-075-017-002C	SWP-M-G	Plug Number (T2): 4
08.74 - 07.85	M 110.982, M 110.986, M 110.990		246-082-005-002C	SWP-M-C	Plug Number (T2): 4; T25: 124 869 03 21, etc.
08.74 - 08.81	M 110.982, M 110.986, M 110.990		246-082-008-013P	SWP-M-C	Plug Number (T2): 4; T25: 140 869 02 21, etc.

**300 SL (107.041) (132 kW | 2.9 Litre)**

09.85 - 08.89	M 103.982		246-082-008-013P	SWP-M-C	Plug Number (T2): 4; T25: 140 869 02 21, etc.
---------------	-----------	--	------------------	---------	-----------------------------------------------

**350 SL (107.043) (143 kW | 3.5 Litre)**

05.71 - 02.80	M 116.982, M 116.984		246-075-017-002C	SWP-M-G	Plug Number (T2): 4
05.71 - 02.80	M 116.982, M 116.984		246-082-008-013P	SWP-M-C	Plug Number (T2): 4; T25: 140 869 02 21, etc.

**380 SL (107.045) (150 kW | 3.8 Litre)**

09.81 - 08.85	M 116.962		246-082-008-013P	SWP-M-C	Plug Number (T2): 4; T25: 140 869 02 21, etc.
---------------	-----------	--	------------------	---------	-----------------------------------------------

**380 SL (107.045) (160 kW | 3.8 Litre)**

09.80 - 08.81	M 116.960		246-082-008-013P	SWP-M-C	Plug Number (T2): 4; T25: 140 869 02 21, etc.
---------------	-----------	--	------------------	---------	-----------------------------------------------

**420 SL (107.047) (150 kW | 4.1 Litre)**

01.86 - 08.89	M 116.964		246-082-008-013P	SWP-M-C	Plug Number (T2): 4; T25: 140 869 02 21, etc.
---------------	-----------	--	------------------	---------	-----------------------------------------------

**450 SL (107.044) (160 kW | 4.5 Litre)**

09.75 - 10.80	M 117.982, M 117.985		246-075-017-002C	SWP-M-G	Plug Number (T2): 4
---------------	----------------------	--	------------------	---------	---------------------

**450 SL (107.044) (165 kW | 4.5 Litre)**

10.72 - 10.80	M 117.982, M 117.985		246-075-017-002C	SWP-M-G	Plug Number (T2): 4
---------------	----------------------	--	------------------	---------	---------------------

**500 SL (107.046) (164 kW | 4.9 Litre)**

01.86 - 08.89	M 117.964		246-082-008-013P	SWP-M-C	Plug Number (T2): 4; T25: 140 869 02 21, etc.
---------------	-----------	--	------------------	---------	-----------------------------------------------

**500 SL (107.046) (170 kW | 4.9 Litre)**

05.80 - 08.85	M 117.960		246-082-008-013P	SWP-M-C	Plug Number (T2): 4; T25: 140 869 02 21, etc.
---------------	-----------	--	------------------	---------	-----------------------------------------------

**SL (R129)****280 (129.058) (142 kW | 2.8 Litre)**

08.93 - 10.01	M 104.943	-F140421	246-082-008-013P	SWP-M-C	Plug Number (T2): 4; T25: 140 869 02 21, etc.
08.93 - 10.01	M 104.943		246-082-008-025G	SWP-M-C	

**280 (129.059) (150 kW | 2.8 Litre)**

05.98 - 10.01	M 112.923, M 112.925		246-082-008-013P	SWP-M-C	Plug Number (T2): 4; T25: 140 869 02 21, etc.
05.98 - 10.01	M 112.923, M 112.925		246-082-008-025G	SWP-M-C	

**300 SL (129.060) (140 kW | 3.0 Litre)**

03.89 - 07.93	M 103.984	-F140421	246-082-008-013P	SWP-M-C	Plug Number (T2): 4; T25: 140 869 02 21, etc.
03.89 - 08.93	M 103.984	-F 146278	246-082-008-025G	SWP-M-C	

**300 SL-24 (129.061) (170 kW | 3.0 Litre)**

03.89 - 07.93	M 104.981	-F140421	246-082-008-013P	SWP-M-C	Plug Number (T2): 4; T25: 140 869 02 21, etc.
03.89 - 07.93	M 104.981		246-082-008-025G	SWP-M-C	

**320 (129.063) (170 kW | 3.2 Litre)**

09.93 - 10.01	M 104.991	-F140421	246-082-008-013P	SWP-M-C	Plug Number (T2): 4; T25: 140 869 02 21, etc.
09.93 - 10.01	M 104.991	-F 146278	246-082-008-025G	SWP-M-C	

**320 (129.064) (165 kW | 3.2 Litre)**

05.98 - 10.01	M 112.943		246-082-008-013P	SWP-M-C	Plug Number (T2): 4; T25: 140 869 02 21, etc.
05.98 - 10.01	M 112.943		246-082-008-025G	SWP-M-C	

**500 (129.067) (235 kW | 5.0 Litre)**

09.92 - 07.93	M 119.972, M 119.982	-F140421	246-082-008-013P	SWP-M-C	Plug Number (T2): 4; T25: 140 869 02 21, etc.
09.92 - 10.01	M 119.982		246-082-008-025G	SWP-M-C	

**500 (129.068) (225 kW | 5.0 Litre)**

05.98 - 10.01	M 113.961		246-082-008-013P	SWP-M-C	Plug Number (T2): 4; T25: 140 869 02 21, etc.
05.98 - 10.01	M 113.961		246-082-008-025G	SWP-M-C	

**500 SL (129.066) (240 kW | 5.0 Litre)**

09.89 - 08.92	M 119.960, M 119.972	-F140421	246-082-008-013P	SWP-M-C	Plug Number (T2): 4; T25: 140 869 02 21, etc.
---------------	----------------------	----------	------------------	---------	-----------------------------------------------

**55 AMG (129.068) (260 kW | 5.5 Litre)**

03.00 - 10.01	M 113.985		246-082-008-013P	SWP-M-C	Plug Number (T2): 4; T25: 140 869 02 21, etc.
03.00 - 10.01	M 113.985		246-082-008-025G	SWP-M-C	

**60 AMG (129.067) (280 kW | 6.0 Litre)**

05.97 - 10.01	M 122.981		246-082-008-013P	SWP-M-C	Plug Number (T2): 4; T25: 140 869 02 21, etc.
05.97 - 10.01	M 120.981		246-082-008-025G	SWP-M-C	

**600 (129.076) (290 kW | 6.0 Litre)**

07.92 - 07.93	M 120.981, M 120.983		246-082-008-013P	SWP-M-C	Plug Number (T2): 4; T25: 140 869 02 21, etc.
07.92 - 10.01	M 120.981, M 120.983	-F 146278	246-082-008-025G	SWP-M-C	





			<b>VDO</b>		
Date	Engine Code	Chassis No.	Article No.	Product	Information

**MERCEDES-BENZ****SL (R230)****350 (230.467) (180 kW | 3.7 Litre)**

03.03 - 01.12 | M 112.973

246-082-008-025G

SWP-M-C

**500 (230.475) (225 kW | 5.0 Litre)**

10.01 - 01.12 | M 113.963

246-082-008-025G

SWP-M-C

**55 AMG (230.474) (350 kW | 5.4 Litre)**

10.01 - 06.02 | M 113.992

246-082-008-025G

SWP-M-C

**55 AMG Kompressor (230.474) (368 kW | 5.5 Litre)**

06.02 - 01.12 | M 113.992

246-082-008-025G

SWP-M-C

**600 (230.476) (368 kW | 5.5 Litre)**

04.03 - 01.12 | M 275.951

246-082-008-025G

SWP-M-C

**65 AMG (230.479) (450 kW | 6.0 Litre)**

03.04 - 01.12 | M 275.981

246-082-008-025G

SWP-M-C

**SLK (R170)****200 (170.435) (100 kW | 2.0 Litre)**

09.96 - 03.00 | M 111.946

246-082-008-025G

SWP-M-C

**200 Kompressor (170.444) (120 kW | 2.0 Litre)**

04.00 - 04.04 | M 111.958

246-082-008-025G

SWP-M-C

**230 Kompressor (170.447) (142 kW | 2.3 Litre)**

09.96 - 03.00 | M 111.973

246-082-008-025G

SWP-M-C

**320 (170.465) (160 kW | 3.2 Litre)**

03.00 - 04.04 | M 112.947

246-082-008-025G

SWP-M-C

**SLK (R171)****200 Kompressor (171.442) (120 kW | 1.8 Litre)**

03.04 - 02.11 | M 271.944

246-082-008-025G

SWP-M-C

**280 (171.454) (170 kW | 3.0 Litre)**

01.05 - 02.11 | M 272.942

246-082-008-025G

SWP-M-C

**350 (171.456) (200 kW | 3.5 Litre)**

06.04 - 02.11 | M 272.963

246-082-008-025G

SWP-M-C

**55 AMG (171.473) (265 kW | 5.5 Litre)**

06.04 - 02.11 | M 113.989

246-082-008-025G

SWP-M-C

**M-CLASS (W163)****ML 230 (163.136) (110 kW | 2.3 Litre)**

02.98 - 06.05 | M 111.977

246-082-008-025G

SWP-M-C

**ML 270 CDI (163.113) (120 kW | 2.7 Litre)**

12.99 - 06.05 | OM 612.963

246-082-008-025G

SWP-M-C

**ML 320 (163.154) (160 kW | 3.2 Litre)**

02.98 - 08.02 | M 112.942

246-082-008-025G

SWP-M-C

**ML 350 (163.157) (180 kW | 3.7 Litre)**

08.02 - 06.05 | M 112.970

246-082-008-025G

SWP-M-C

**ML 350 (173 kW | 3.7 Litre)**

02.03 - 06.05 | M 112.970

246-082-008-025G

SWP-M-C

**ML 400 CDI (163.128) (184 kW | 4.0 Litre)**

09.01 - 06.05 | OM 628.963

246-082-008-025G

SWP-M-C

**ML 430 (163.172) (200 kW | 4.3 Litre)**

03.98 - 06.05 | M 113.942

246-082-008-025G

SWP-M-C

**ML 500 (163.175) (215 kW | 5.0 Litre)**

09.01 - 06.05 | M 113.964, M 113.965

246-082-008-025G

SWP-M-C

**ML 55 AMG (163.174) (255 kW | 5.4 Litre)**

02.00 - 06.05 | M 113.981

246-082-008-025G

SWP-M-C

**G-CLASS (W460)****230 G (460,2) (66 kW | 2.3 Litre)**

03.79 - 07.93 | M 115.973

246-075-021-007C

SWP-M-G

Plug Number (T2): 1

03.79 - 07.93 | M 115.973

900302--

246-082-008-014C

SWP-M-C

Plug Number (T2): 1

**230 G (460,2) (75 kW | 2.3 Litre)**

02.80 - 07.87 | M 115.973

246-075-021-007C

SWP-M-G

Plug Number (T2): 1

02.80 - 07.87 | M 115.973

024324--

246-082-008-014C

SWP-M-C

Plug Number (T2): 1

**230 GE (460,2) (90 kW | 2.3 Litre)**

05.87 - 08.92 | M 102.979, M 102.987

246-075-021-007C

SWP-M-G

Plug Number (T2): 1

05.87 - 08.92 | M 102.979, M 102.987

900302--

246-082-008-014C

SWP-M-C

Plug Number (T2): 1



			<b>VDO</b>		
Date	Engine Code	Chassis No.	Article No.	Product	Information

**MERCEDES-BENZ****G-CLASS (W460)****230 GE (460,2) (92 kW | 2.3 Litre)**

04.82 → 08.92 | M 102.989, M 102.981, M 102.987

246-075-021-007C

SWP-M-G

Plug Number (T2): 1

**240 GD (460,3) (53 kW | 2.4 Litre)**

03.79 → 08.87 | OM 616.936

246-075-021-007C

SWP-M-G

Plug Number (T2): 1

03.79 → 08.87 | OM 616.936

900302→

246-082-008-014C

SWP-M-C

Plug Number (T2): 1

**250 GD (460,3) (62 kW | 2.5 Litre)**

10.87 → 12.92 | OM 602.930

246-075-021-007C

SWP-M-G

Plug Number (T2): 1

10.87 → 12.92 | OM 602.930

024324→

246-082-008-014C

SWP-M-C

Plug Number (T2): 1

**250 GD (460,3) (68 kW | 2.5 Litre)**

12.88 → 08.92 | OM 602.930

246-075-021-007C

SWP-M-G

Plug Number (T2): 1

12.88 → 08.92 | OM 602.930

024324→

246-082-008-014C

SWP-M-C

Plug Number (T2): 1

**280 GE (460,2) (110 kW | 2.7 Litre)**

08.84 → 08.89 | M 110.994

246-075-017-002C

SWP-M-G

Plug Number (T2): 4

08.84 → 08.89 | M 110.994

246-075-021-007C

SWP-M-G

Plug Number (T2): 1

08.84 → 08.89 | M 110.994

900302→

246-082-008-014C

SWP-M-C

Plug Number (T2): 1

**280 GE (460,2) (115 kW | 2.7 Litre)**

11.79 → 08.89 | M 110.994

246-075-017-002C

SWP-M-G

Plug Number (T2): 4

11.79 → 08.89 | M 110.994

246-075-021-007C

SWP-M-G

Plug Number (T2): 1

**300 GD (460,3) (65 kW | 3.0 Litre)**

12.79 → 12.91 | OM 617.931

246-075-021-007C

SWP-M-G

Plug Number (T2): 1

12.79 → 12.91 | OM 617.931

024324→

246-082-008-014C

SWP-M-C

Plug Number (T2): 1

**300 GD (460,3) (83 kW | 3.0 Litre)**

03.79 → 07.93 | OM 603.912

246-075-021-007C

SWP-M-G

Plug Number (T2): 1

**G-CLASS (W461)****230 GE (461) (92 kW | 2.3 Litre)**

06.93 → | M 102.996, M 102.997

246-082-008-025G

SWP-M-C

T25: A210 869 08 21

**230 GE (461.238, 461.239) (90 kW | 2.3 Litre)**

02.93 → | M 102.979

246-082-008-025G

SWP-M-C

T25: A210 869 08 21

**250 GD (461) (68 kW | 2.5 Litre)**

02.90 → | OM 602.939

246-082-008-025G

SWP-M-C

T25: A210 869 08 21

**290 GD/G 290 D (461.337, 461.338) (70 kW | 2.9 Litre)**

04.92 → | OM 602.942

246-082-008-025G

SWP-M-C

T25: A210 869 08 21

**G 290 TD (461.335, 461.336) (88 kW | 2.9 Litre)**

07.97 → | OM 602.983

246-082-008-025G

SWP-M-C

T25: A210 869 08 21

**G-CLASS (W463)****230 GE (463.224, 463.225) (93 kW | 2.3 Litre)**

06.90 → 06.93 | M 102.989

246-082-008-025G

SWP-M-C

**250 GD (463.324, 463.325) (69 kW | 2.5 Litre)**

06.90 → | OM 602.931

246-082-008-025G

SWP-M-C

**300 GD (463.327, 463.328) (83 kW | 3.0 Litre)**

09.89 → | OM 603.931

246-082-008-025G

SWP-M-C

**300 GE (463.227, 463.228) (125 kW | 3.0 Litre)**

06.90 → | M 103.987

246-082-008-025G

SWP-M-C

**300 GE (463.227, 463.228) (128 kW | 3.0 Litre)**

06.90 → | M 103.987

246-082-008-025G

SWP-M-C

**350 G Turbo D (463.320, 463.321) (100 kW | 3.4 Litre)**

09.91 → | OM 603.972

246-082-008-025G

SWP-M-C

**G 270 CDI (463.322, 463.323) (115 kW | 2.7 Litre)**

10.01 → | OM 612.965

246-082-008-025G

SWP-M-C

**G 300 TD (463.330, 463.331) (130 kW | 3.0 Litre)**

08.96 → | OM 606.964

246-082-008-025G

SWP-M-C

**G 320 (463.230, 463.231) (155 kW | 3.2 Litre)**

09.94 → 12.97 | M 104.996

246-082-008-025G

SWP-M-C

**G 320 (463.232, 463.233, 463.244, 463.245) (158 kW | 3.2 Litre)**

07.97 → | M 112.945

246-082-008-025G

SWP-M-C

**G 36 AMG (200 kW | 3.6 Litre)**

01.95 →

246-082-008-025G

SWP-M-C

**G 400 CDI (463.332, 463.333) (184 kW | 4.0 Litre)**

12.00 → | OM 628.962

246-082-008-025G

SWP-M-C

**G 500 (463.247, 463.248, 463.249, 463.240, 463.421) (218 kW | 5.0 Litre)**

04.98 → | M 113.962

246-082-008-025G

SWP-M-C



			<b>VDO</b>		
Date	Engine Code	Chassis No.	Article No.	Product	Information

**MERCEDES-BENZ****G-CLASS (W463)****G 500 E (463.228) (177 kW | 4.9 Litre)**

09.93 - M 117.965 246-082-008-025G SWP-M-C

**G 55 AMG (463.243, 463.246) (260 kW | 5.5 Litre)**

04.99 - M 113.982 246-082-008-025G SWP-M-C

**G 55 AMG (463.270, 463.271) (350 kW | 5.4 Litre)**

06.04 - M 113.993 246-082-008-025G SWP-M-C

**G-CLASS Cabrio (W463)****230 GE (463.204) (93 kW | 2.3 Litre)**

06.90 - 02.93 M 102.989 246-082-008-025G SWP-M-C

**300 GD (463.307) (83 kW | 3.0 Litre)**

12.90 - 09.97 OM 603.931 246-082-008-025G SWP-M-C

**300 GE (463.207) (125 kW | 3.0 Litre)**

09.89 - 09.97 M 103.987 246-082-008-025G SWP-M-C

**320 GE (463.208) (155 kW | 3.2 Litre)**

09.94 - 11.97 M 104.996 246-082-008-025G SWP-M-C

**350 G Turbo-D (463.300) (100 kW | 3.4 Litre)**

09.91 - 09.97 OM 603.972 246-082-008-025G SWP-M-C

**G 300 TD (463.308) (130 kW | 3.0 Litre)**

09.96 - OM 606.964 246-082-008-025G SWP-M-C

**G 320 (463.209) (158 kW | 3.2 Litre)**

11.97 - M 112.945 246-082-008-025G SWP-M-C

**G 400 CDI (463.309) (184 kW | 4.0 Litre)**

12.00 - OM 628.962 246-075-017-002C SWP-M-G Plug Number (T2): 4

12.00 - OM 628.962 246-075-021-007C SWP-M-G Plug Number (T2): 1; T25: A000 869 30 21

12.00 - OM 628.962 246-082-008-025G SWP-M-C

**G 500 (463) (218 kW | 5.0 Litre)**

04.98 - M 113.962 246-082-008-025G SWP-M-C

**V-CLASS (638/2)****V 200 (638.214, 638.294) (95 kW | 2.0 Litre)**

02.97 - 07.03 M 111.948, M 111.950 246-082-008-014C SWP-M-C Plug Number (T2): 1

**V 200 CDI (638.294) (75 kW | 2.2 Litre)**

03.99 - 07.03 OM 611.980 246-082-008-014C SWP-M-C Plug Number (T2): 1

**V 220 CDI (638.294) (90 kW | 2.2 Litre)**

03.99 - 07.03 OM 611.980 246-082-008-014C SWP-M-C Plug Number (T2): 1

**V 230 (638.234, 638.294) (105 kW | 2.3 Litre)**

10.96 - 07.03 M 111.978 246-082-008-014C SWP-M-C Plug Number (T2): 1

**V 230 TD (638.274) (72 kW | 2.3 Litre)**

10.96 - 07.03 OM 601.970 246-082-008-014C SWP-M-C Plug Number (T2): 1

**V 280 (638.244, 638.294) (128 kW | 2.8 Litre)**

08.97 - 07.03 M 104.900 246-082-008-014C SWP-M-C Plug Number (T2): 1

**VIANO (W639)****3,0 (140 kW | 3.2 Litre)**

09.03 - M 112.951 246-082-008-025G SWP-M-C

**3.2 (160 kW | 3.2 Litre)**

09.03 - M 112.951 246-082-008-025G SWP-M-C

**3.5 (190 kW | 3.5 Litre)**

09.07 - M 272.979 246-082-008-025G SWP-M-C

**3.7 (170 kW | 3.7 Litre)**

06.04 - M 112.976 246-082-008-025G SWP-M-C

**CDI 2.0 (100 kW | 2.0 Litre)**

07.10 - OM 651.940 246-082-008-025G SWP-M-C

**CDI 2.0 (80 kW | 2.0 Litre)**

09.03 - OM 646.982 246-082-008-025G SWP-M-C

**CDI 2.0 (85 kW | 2.0 Litre)**

08.05 - OM 646.982 246-082-008-025G SWP-M-C

**CDI 2.0 4-matic (100 kW | 2.0 Litre)**

07.10 - OM 651.940 246-082-008-025G SWP-M-C

**CDI 2.0 4-matic (80 kW | 2.0 Litre)**

07.05 - OM 646.982 246-082-008-025G SWP-M-C



			<b>VDO</b>		
Date	Engine Code	Chassis No.	Article No.	Product	Information

**MERCEDES-BENZ****VIANO (W639)****CDI 2.2 (110 kW | 2.2 Litre)**

09.03 → OM 646.982

246-082-008-025G

SWP-M-C

**CDI 2.2 (120 kW | 2.2 Litre)**

07.10 → OM 651.940

246-082-008-025G

SWP-M-C

**CDI 2.2 4-matic (110 kW | 2.2 Litre)**

07.05 → OM 646.982

246-082-008-025G

SWP-M-C

**CDI 2.2 4-matic (120 kW | 2.2 Litre)**

07.10 → OM 651.940

246-082-008-025G

SWP-M-C

**CDI 3.0 (150 kW | 3.0 Litre)**

03.06 → OM 642.990

246-082-008-025G

SWP-M-C

**CDI 3.0 (165 kW | 3.0 Litre)**

07.10 → OM 642.990

246-082-008-025G

SWP-M-C

**VITO Bus (638)****108 CDI 2.2 (638.194) (60 kW | 2.2 Litre)**

03.99 → 07.03 OM 611A (60 KW CDI)

246-075-017-002C

SWP-M-G

Plug Number (T2): 4

03.99 → 07.03 OM 611A (60 KW CDI)

246-075-021-007C

SWP-M-G

Plug Number (T2): 1; T25: A000 869 30 21

03.99 → 07.03 OM 611A (60 KW CDI)

246-075-024-002C

SWP-M-G

Plug Number (T2): 1; T25: A000 869 31 21

03.99 → 07.03 OM 611A (60 KW CDI)

246-082-008-014C

SWP-M-C

Plug Number (T2): 1

**108 D 2.3 (638.164) (58 kW | 2.3 Litre)**

02.96 → 07.03 OM 601.942

246-082-008-014C

SWP-M-C

Plug Number (T2): 1

**110 CDI 2.2 (638.194) (75 kW | 2.2 Litre)**

03.99 → 07.03 OM 611LA (75 KW CDI)

246-075-017-002C

SWP-M-G

Plug Number (T2): 4

03.99 → 07.03 OM 611LA (75 KW CDI)

246-075-021-007C

SWP-M-G

Plug Number (T2): 1; T25: A000 869 30 21

03.99 → 07.03 OM 611LA (75 KW CDI)

246-075-024-002C

SWP-M-G

Plug Number (T2): 1; T25: A000 869 31 21

03.99 → 07.03 OM 611LA (75 KW CDI)

246-082-008-014C

SWP-M-C

Plug Number (T2): 1

**110 TD 2.3 (638.174) (72 kW | 2.3 Litre)**

02.96 → 07.03 OM 601.970

246-082-008-014C

SWP-M-C

Plug Number (T2): 1

**112 CDI 2.2 (638.194) (90 kW | 2.2 Litre)**

03.99 → 07.03 OM 611.980

246-075-017-002C

SWP-M-G

Plug Number (T2): 4

03.99 → 07.03 OM 611.980

246-075-021-007C

SWP-M-G

Plug Number (T2): 1; T25: A000 869 30 21

03.99 → 07.03 OM 611.980

246-075-024-002C

SWP-M-G

Plug Number (T2): 1; T25: A000 869 31 21

03.99 → 07.03 OM 611.980

246-082-008-014C

SWP-M-C

Plug Number (T2): 1

**113 2.0 (638.114, 638.194) (95 kW | 2.0 Litre)**

02.96 → 07.03 M 111.948, M 111.950

246-075-017-002C

SWP-M-G

Plug Number (T2): 4

02.96 → 07.03 M 111.948, M 111.950

246-075-021-007C

SWP-M-G

Plug Number (T2): 1; T25: A000 869 30 21

02.96 → 07.03 M 111.948, M 111.950

246-075-024-002C

SWP-M-G

Plug Number (T2): 1; T25: A000 869 31 21

02.96 → 07.03 M 111.948, M 111.950

246-082-008-014C

SWP-M-C

Plug Number (T2): 1

**114 2.3 (638.134, 638.194) (105 kW | 2.3 Litre)**

12.96 → 07.03 M 111.978

246-075-017-002C

SWP-M-G

Plug Number (T2): 4

12.96 → 07.03 M 111.978

246-075-021-007C

SWP-M-G

Plug Number (T2): 1; T25: A000 869 30 21

12.96 → 07.03 M 111.978

246-075-024-002C

SWP-M-G

Plug Number (T2): 1; T25: A000 869 31 21

12.96 → 07.03 M 111.978

246-082-008-014C

SWP-M-C

Plug Number (T2): 1

**VITO Box (638)****108 CDI 2.2 (638.094) (60 kW | 2.2 Litre)**

03.99 → 07.03 OM 611A (60 KW CDI)

246-075-017-002C

SWP-M-G

Plug Number (T2): 4

03.99 → 07.03 OM 611A (60 KW CDI)

246-075-021-007C

SWP-M-G

Plug Number (T2): 1; T25: A000 869 30 21

03.99 → 07.03 OM 611A (60 KW CDI)

246-075-024-002C

SWP-M-G

Plug Number (T2): 1; T25: A000 869 31 21

03.99 → 07.03 OM 611A (60 KW CDI)

246-082-008-014C

SWP-M-C

Plug Number (T2): 1

**108 D 2.3 (638.064) (58 kW | 2.3 Litre)**

03.97 → 07.03 OM 601.942

246-082-008-014C

SWP-M-C

Plug Number (T2): 1

**110 CDI 2.2 (638.094) (75 kW | 2.2 Litre)**

03.99 → 07.03 OM 611LA (75 KW CDI)

246-075-017-002C

SWP-M-G

Plug Number (T2): 4

03.99 → 07.03 OM 611LA (75 KW CDI)

246-075-021-007C

SWP-M-G

Plug Number (T2): 1; T25: A000 869 30 21

03.99 → 07.03 OM 611LA (75 KW CDI)

246-075-024-002C

SWP-M-G

Plug Number (T2): 1; T25: A000 869 31 21

03.99 → 07.03 OM 611LA (75 KW CDI)

246-082-008-014C

SWP-M-C

Plug Number (T2): 1

**110 D 2.3 (638.074) (72 kW | 2.3 Litre)**

03.97 → 07.03 OM 601.970

246-082-008-014C

SWP-M-C

Plug Number (T2): 1

**112 CDI 2.2 (638.094) (90 kW | 2.2 Litre)**

03.99 → 07.03 OM 611.980

246-075-017-002C

SWP-M-G

Plug Number (T2): 4

03.99 → 07.03 OM 611.980

246-075-021-007C

SWP-M-G

Plug Number (T2): 1; T25: A000 869 30 21

03.99 → 07.03 OM 611.980

246-075-024-002C

SWP-M-G

Plug Number (T2): 1; T25: A000 869 31 21



			<b>VDO</b>		
Date	Engine Code	Chassis No.	Article No.	Product	Information

**MERCEDES-BENZ****VITO Box (638)****112 CDI 2.2 (638.094) (90 kW | 2.2 Litre)**

03.99 → 07.03 OM 611.980

246-082-008-014C

SWP-M-C

Plug Number (T2): 1

**113 2.0 (638.014, 638.094) (95 kW | 2.0 Litre)**

03.97 → 07.03 M 111.948, M 111.950

246-082-008-014C

SWP-M-C

Plug Number (T2): 1

**114 2.3 (638.034, 638.094) (105 kW | 2.3 Litre)**

03.97 → 07.03 M 111.978

246-075-017-002C

SWP-M-G

Plug Number (T2): 4

03.97 → 07.03 M 111.978

246-075-021-007C

SWP-M-G

Plug Number (T2): 1; T25: A000 869 30 21

03.97 → 07.03 M 111.978

246-075-024-002C

SWP-M-G

Plug Number (T2): 1; T25: A000 869 31 21

03.97 → 07.03 M 111.978

246-082-008-014C

SWP-M-C

Plug Number (T2): 1

**VITO Bus (W639)****109 CDI (65 kW | 2.2 Litre)**

09.03 → OM 646.983

246-075-017-002C

SWP-M-G

Plug Number (T2): 4

09.03 → OM 646.983

246-082-008-025G

SWP-M-C

**109 CDI (70 kW | 2.2 Litre)**

09.06 → OM 646.980

246-082-008-025G

SWP-M-C

**109 CDI 4x4 (70 kW | 2.2 Litre)**

09.07 → OM 646.981

246-082-008-025G

SWP-M-C

**110 CDI (70 kW | 2.2 Litre)**

09.10 → OM 651.940

246-082-008-025G

SWP-M-C

**111 CDI (80 kW | 2.2 Litre)**

09.03 → OM 646.982

246-075-017-002C

SWP-M-G

Plug Number (T2): 4

09.03 → OM 646.982

246-082-008-025G

SWP-M-C

**111 CDI (85 kW | 2.2 Litre)**

09.07 → OM 646.982

246-082-008-025G

SWP-M-C

**111 CDI 4x4 (80 kW | 2.2 Litre)**

09.07 → OM 646.982

246-082-008-025G

SWP-M-C

**113 CDI (100 kW | 2.2 Litre)**

09.10 → OM 651.940

246-082-008-025G

SWP-M-C

**113 CDI 4x4 (100 kW | 2.2 Litre)**

09.10 → OM 651.940

246-082-008-025G

SWP-M-C

**115 CDI (110 kW | 2.2 Litre)**

09.03 → OM 646.982

246-075-017-002C

SWP-M-G

Plug Number (T2): 4

09.03 → OM 646.982

246-075-021-007C

SWP-M-G

Plug Number (T2): 1; T25: A000 869 30 21

09.03 → OM 646.982

246-082-008-025G

SWP-M-C

**115 CDI 4x4 (110 kW | 2.2 Litre)**

09.07 → OM 646.982

246-082-008-025G

SWP-M-C

**116 CDI (120 kW | 2.2 Litre)**

09.10 → OM 651.940

246-082-008-025G

SWP-M-C

**116 CDI 4x4 (120 kW | 2.2 Litre)**

09.10 → OM 651.940

246-082-008-025G

SWP-M-C

**119 (140 kW | 3.0 Litre)**

09.03 → M 112.951

246-082-008-025G

SWP-M-C

**120 CDI (150 kW | 3.0 Litre)**

09.07 → OM 642.990

246-082-008-025G

SWP-M-C

**122 (160 kW | 3.2 Litre)**

09.03 → M 112.951

246-082-008-025G

SWP-M-C

**122 CDI (165 kW | 3.0 Litre)**

09.10 → OM 642.890

246-082-008-025G

SWP-M-C

**123 (170 kW | 3.7 Litre)**

06.04 → M 112.976

246-082-008-025G

SWP-M-C

**126 (190 kW | 3.5 Litre)**

09.07 → M 272.978

246-082-008-025G

SWP-M-C

**VITO / MIXTO Box (W639)****109 CDI (65 kW | 2.2 Litre)**

09.03 → OM 646.983

246-075-017-002C

SWP-M-G

Plug Number (T2): 4

09.03 → OM 646.983

246-082-008-025G

SWP-M-C

**109 CDI (70 kW | 2.2 Litre)**

08.06 → OM 646.981

246-082-008-025G

SWP-M-C

**110 CDI (70 kW | 2.2 Litre)**

09.10 → OM 651.940

246-082-008-025G

SWP-M-C



			<b>VDO</b>		
Date	Engine Code	Chassis No.	Article No.	Product	Information

**MERCEDES-BENZ****VITO / MIXTO Box (W639)**

<b>111 CDI (80 kW   2.2 Litre)</b>					
09.03 -	OM 646.982		246-075-017-002C	SWP-M-G	Plug Number (T2): 4
09.03 -	OM 646.982		246-082-008-025G	SWP-M-C	
<b>111 CDI (85 kW   2.2 Litre)</b>					
09.07 -	OM 646.982		246-082-008-025G	SWP-M-C	
<b>111 CDI 4x4 (80 kW   2.2 Litre)</b>					
09.07 -	OM 646.982		246-082-008-025G	SWP-M-C	
<b>113 CDI (100 kW   2.2 Litre)</b>					
09.10 -	OM 651.940		246-082-008-025G	SWP-M-C	
<b>115 CDI (110 kW   2.2 Litre)</b>					
09.03 -	OM 646.982		246-075-017-002C	SWP-M-G	Plug Number (T2): 4
09.03 -	OM 646.982		246-075-021-007C	SWP-M-G	Plug Number (T2): 1; T25: A000 869 30 21
09.03 -	OM 646.982		246-082-008-025G	SWP-M-C	
<b>115 CDI 4x4 (110 kW   2.2 Litre)</b>					
09.07 -	OM 646.982		246-082-008-025G	SWP-M-C	
<b>116 CDI (120 kW   2.2 Litre)</b>					
09.10 -	OM 651.940		246-082-008-025G	SWP-M-C	
<b>119 (140 kW   3.2 Litre)</b>					
09.03 -	M 112.951		246-082-008-025G	SWP-M-C	
<b>120 CDI (150 kW   3.0 Litre)</b>					
09.07 -	OM 642.990		246-082-008-025G	SWP-M-C	
<b>122 (160 kW   3.2 Litre)</b>					
09.03 -	M 112.951		246-082-008-025G	SWP-M-C	
<b>122 CDI (165 kW   3.0 Litre)</b>					
09.10 -	OM 642.890		246-082-008-025G	SWP-M-C	
<b>123 (639.603) (170 kW   3.7 Litre)</b>					
06.04 - 07.08	M 112.976		246-082-008-025G	SWP-M-C	
<b>126 (190 kW   3.5 Litre)</b>					
09.07 -	M 272.978		246-082-008-025G	SWP-M-C	

**SPRINTER 2-t Bus (901, 902)**

<b>208 CDI (60 kW   2.1 Litre)</b>					
04.00 - 05.06	OM 611.987		246-082-008-014C	SWP-M-C	Plug Number (T2): 1
<b>208 D (58 kW   2.3 Litre)</b>					
02.95 - 04.00	OM 601.943		246-082-008-014C	SWP-M-C	Plug Number (T2): 1
<b>210 D (75 kW   2.9 Litre)</b>					
03.97 - 04.00	OM 602.980		246-082-008-014C	SWP-M-C	Plug Number (T2): 1
<b>211 CDI (80 kW   2.1 Litre)</b>					
04.00 - 05.06	OM 611.981		246-082-008-014C	SWP-M-C	Plug Number (T2): 1
<b>212 D (90 kW   2.9 Litre)</b>					
02.95 - 04.00	OM 602.980		246-082-008-014C	SWP-M-C	Plug Number (T2): 1
<b>213 CDI (95 kW   2.1 Litre)</b>					
04.00 - 05.06	OM 611.981		246-082-008-014C	SWP-M-C	Plug Number (T2): 1
<b>214 (105 kW   2.3 Litre)</b>					
02.95 - 05.06	M 111.979		246-082-008-014C	SWP-M-C	Plug Number (T2): 1
<b>214 NGT (92 kW   2.3 Litre)</b>					
04.00 - 05.06	M 111.984		246-082-008-014C	SWP-M-C	Plug Number (T2): 1
<b>216 CDI (115 kW   2.7 Litre)</b>					
04.00 - 05.06	OM 612.981		246-082-008-014C	SWP-M-C	Plug Number (T2): 1

**SPRINTER 2-t Box (901, 902)**

<b>208 CDI (60 kW   2.1 Litre)</b>					
04.00 - 05.06	OM 611.987		246-082-008-014C	SWP-M-C	Plug Number (T2): 1
<b>208 D (58 kW   2.3 Litre)</b>					
02.95 - 04.00	OM 601.943		246-082-008-014C	SWP-M-C	Plug Number (T2): 1
<b>208 D (60 kW   2.3 Litre)</b>					
10.96 - 04.00	OM 601.943		246-082-008-014C	SWP-M-C	Plug Number (T2): 1
<b>210 D (75 kW   2.9 Litre)</b>					
01.97 - 04.00	OM 602.980		246-082-008-014C	SWP-M-C	Plug Number (T2): 1
<b>211 CDI (80 kW   2.1 Litre)</b>					
04.00 - 05.06	OM 611.981		246-082-008-014C	SWP-M-C	Plug Number (T2): 1
<b>212 D (90 kW   2.9 Litre)</b>					
02.95 - 04.00	OM 602.980		246-082-008-014C	SWP-M-C	Plug Number (T2): 1



			<b>VDO</b>		
Date	Engine Code	Chassis No.	Article No.	Product	Information

**MERCEDES-BENZ****SPRINTER 2-t Box (901, 902)**

<b>213 CDI (95 kW   2.1 Litre)</b>					
04.00 - 05.06	OM 611.981		246-082-008-014C	SWP-M-C	Plug Number (T2): 1
<b>214 (105 kW   2.3 Litre)</b>					
02.95 - 05.06	M 111.979, M 111.984		246-082-008-014C	SWP-M-C	Plug Number (T2): 1
<b>214 NGT (92 kW   2.3 Litre)</b>					
04.00 - 05.06	M 111.984		246-082-008-014C	SWP-M-C	Plug Number (T2): 1
<b>216 CDI (115 kW   2.7 Litre)</b>					
04.00 - 05.06	OM 612.981		246-082-008-014C	SWP-M-C	Plug Number (T2): 1

**SPRINTER 2-t Platform/Chassis (901, 902)**

<b>208 CDI (60 kW   2.1 Litre)</b>					
04.00 - 05.06	OM 611.987		246-082-008-014C	SWP-M-C	Plug Number (T2): 1
<b>208 D (58 kW   2.3 Litre)</b>					
01.95 - 04.00	OM 601.943		246-082-008-014C	SWP-M-C	Plug Number (T2): 1
<b>208 D (60 kW   2.3 Litre)</b>					
09.96 - 04.00	OM 601.943		246-082-008-014C	SWP-M-C	Plug Number (T2): 1
<b>210 D (75 kW   2.9 Litre)</b>					
01.97 - 04.00	OM 602.980		246-082-008-014C	SWP-M-C	Plug Number (T2): 1
<b>211 CDI (80 kW   2.1 Litre)</b>					
04.00 - 05.06	OM 611.981		246-082-008-014C	SWP-M-C	Plug Number (T2): 1
<b>212 D (90 kW   2.9 Litre)</b>					
02.95 - 04.00	OM 602.980		246-082-008-014C	SWP-M-C	Plug Number (T2): 1
<b>213 CDI (95 kW   2.1 Litre)</b>					
04.00 - 05.06	OM 611.981		246-082-008-014C	SWP-M-C	Plug Number (T2): 1
<b>214 (105 kW   2.3 Litre)</b>					
02.00 - 05.06	M 111.979		246-082-008-014C	SWP-M-C	Plug Number (T2): 1
<b>214 NGT (92 kW   2.3 Litre)</b>					
04.00 - 05.06			246-082-008-014C	SWP-M-C	Plug Number (T2): 1
<b>216 CDI (115 kW   2.7 Litre)</b>					
04.00 - 05.06	OM 612.981		246-082-008-014C	SWP-M-C	Plug Number (T2): 1

**SPRINTER 3-t Bus (903)**

<b>308 CDI (60 kW   2.1 Litre)</b>					
04.00 - 05.06	OM 611.987		246-082-008-014C	SWP-M-C	Plug Number (T2): 1
<b>308 D (58 kW   2.3 Litre)</b>					
02.95 - 04.00	OM 601.943		246-082-008-014C	SWP-M-C	Plug Number (T2): 1
<b>308 E (40 kW   0.0 Litre)</b>					
04.00 - 05.06			246-082-008-014C	SWP-M-C	Plug Number (T2): 1
<b>310 D 4x4 (75 kW   2.9 Litre)</b>					
05.97 - 08.02	OM 602.980		246-075-017-002C	SWP-M-G	Plug Number (T2): 4
05.97 - 08.02	OM 602.980		246-075-021-007C	SWP-M-G	Plug Number (T2): 1; T25: A000 869 30 21
05.97 - 08.02	OM 602.980		246-082-008-014C	SWP-M-C	Plug Number (T2): 1
<b>311 CDI (80 kW   2.1 Litre)</b>					
04.00 - 05.06	OM 611.981		246-082-008-014C	SWP-M-C	Plug Number (T2): 1
<b>311 CDI 4x4 (80 kW   2.1 Litre)</b>					
08.02 - 05.06	OM 611.981		246-082-008-014C	SWP-M-C	Plug Number (T2): 1
<b>312 D 2.9 (90 kW   2.9 Litre)</b>					
02.95 - 04.00	OM 602.980		246-082-008-014C	SWP-M-C	Plug Number (T2): 1
<b>312 D 2.9 4x4 (90 kW   2.9 Litre)</b>					
05.97 - 08.02	OM 602.980		246-082-008-014C	SWP-M-C	Plug Number (T2): 1
<b>313 CDI (95 kW   2.1 Litre)</b>					
04.00 - 05.06	OM 611.981		246-082-008-014C	SWP-M-C	Plug Number (T2): 1
<b>313 CDI 4x4 (95 kW   2.1 Litre)</b>					
08.02 - 05.06	OM 611.981		246-082-008-014C	SWP-M-C	Plug Number (T2): 1
<b>314 (105 kW   2.3 Litre)</b>					
02.95 - 05.06	M 111.984		246-082-008-014C	SWP-M-C	Plug Number (T2): 1
<b>314 4x4 (105 kW   2.3 Litre)</b>					
08.02 - 05.06	M 111.984		246-082-008-014C	SWP-M-C	Plug Number (T2): 1
<b>314 NGT (92 kW   2.3 Litre)</b>					
04.00 - 05.06	M 111.984		246-082-008-014C	SWP-M-C	Plug Number (T2): 1
<b>316 CDI (115 kW   2.7 Litre)</b>					
04.00 - 05.06	OM 612.981		246-082-008-014C	SWP-M-C	Plug Number (T2): 1



			<b>VDO</b>		
Date	Engine Code	Chassis No.	Article No.	Product	Information

**MERCEDES-BENZ****SPRINTER 3-t Bus (903)****316 CDI 4x4 (115 kW | 2.7 Litre)**

08.02 - 05.06	OM 612.981		246-082-008-014C	SWP-M-C	Plug Number (T2): 1
---------------	------------	--	------------------	---------	---------------------

**SPRINTER 3-t Box (903)****308 CDI (60 kW | 2.1 Litre)**

04.00 - 05.06	OM 611.987		246-082-008-014C	SWP-M-C	Plug Number (T2): 1
---------------	------------	--	------------------	---------	---------------------

**308 D 2.3 (58 kW | 2.3 Litre)**

02.95 - 04.00	OM 601.943		246-082-008-014C	SWP-M-C	Plug Number (T2): 1
---------------	------------	--	------------------	---------	---------------------

**308 D 2.3 (60 kW | 2.3 Litre)**

02.95 - 04.00	OM 601.943		246-082-008-014C	SWP-M-C	Plug Number (T2): 1
---------------	------------	--	------------------	---------	---------------------

**310 D 2.9 (75 kW | 2.9 Litre)**

02.95 - 04.00	OM 602.980		246-075-017-002C	SWP-M-G	Plug Number (T2): 4
---------------	------------	--	------------------	---------	---------------------

02.95 - 04.00	OM 602.980		246-075-021-007C	SWP-M-G	Plug Number (T2): 1; T25: A000 869 30 21
---------------	------------	--	------------------	---------	------------------------------------------

02.95 - 04.00	OM 602.980		246-082-008-014C	SWP-M-C	Plug Number (T2): 1
---------------	------------	--	------------------	---------	---------------------

**311 CDI (80 kW | 2.1 Litre)**

04.00 - 05.06	OM 611.981		246-082-008-014C	SWP-M-C	Plug Number (T2): 1
---------------	------------	--	------------------	---------	---------------------

**311 CDI 4x4 (80 kW | 2.1 Litre)**

08.02 - 05.06	OM 611.981		246-082-008-014C	SWP-M-C	Plug Number (T2): 1
---------------	------------	--	------------------	---------	---------------------

**312 D 2.9 (90 kW | 2.9 Litre)**

02.95 - 04.00	OM 602.980		246-082-008-014C	SWP-M-C	Plug Number (T2): 1
---------------	------------	--	------------------	---------	---------------------

**312 D 2.9 4x4 (90 kW | 2.9 Litre)**

05.97 - 08.02	OM 602.980		246-082-008-014C	SWP-M-C	Plug Number (T2): 1
---------------	------------	--	------------------	---------	---------------------

**313 CDI (95 kW | 2.1 Litre)**

04.00 - 05.06	OM 611.981		246-082-008-014C	SWP-M-C	Plug Number (T2): 1
---------------	------------	--	------------------	---------	---------------------

**313 CDI 4x4 (95 kW | 2.1 Litre)**

08.02 - 05.06	OM 611.981		246-082-008-014C	SWP-M-C	Plug Number (T2): 1
---------------	------------	--	------------------	---------	---------------------

**314 (105 kW | 2.3 Litre)**

02.95 - 05.06	M 111.979, M 111.984		246-082-008-014C	SWP-M-C	Plug Number (T2): 1
---------------	----------------------	--	------------------	---------	---------------------

**314 4x4 (105 kW | 2.3 Litre)**

08.02 - 05.06	M 111.984		246-082-008-014C	SWP-M-C	Plug Number (T2): 1
---------------	-----------	--	------------------	---------	---------------------

**314 NGT (92 kW | 2.3 Litre)**

04.00 - 05.06			246-082-008-014C	SWP-M-C	Plug Number (T2): 1
---------------	--	--	------------------	---------	---------------------

**316 CDI (115 kW | 2.7 Litre)**

04.00 - 05.06	OM 612.981		246-082-008-014C	SWP-M-C	Plug Number (T2): 1
---------------	------------	--	------------------	---------	---------------------

**316 CDI 4x4 (115 kW | 2.7 Litre)**

08.02 - 05.06	OM 612.981		246-082-008-014C	SWP-M-C	Plug Number (T2): 1
---------------	------------	--	------------------	---------	---------------------

**SPRINTER 3-t Platform/Chassis (903)****308 CDI (60 kW | 2.1 Litre)**

04.00 - 05.06	OM 611.987		246-082-008-014C	SWP-M-C	Plug Number (T2): 1
---------------	------------	--	------------------	---------	---------------------

**308 D 2.3 (58 kW | 2.3 Litre)**

02.95 - 04.00	OM 601.943		246-082-008-014C	SWP-M-C	Plug Number (T2): 1
---------------	------------	--	------------------	---------	---------------------

**308 D 2.3 (60 kW | 2.3 Litre)**

11.96 - 04.00	OM 601.943		246-082-008-014C	SWP-M-C	Plug Number (T2): 1
---------------	------------	--	------------------	---------	---------------------

**310 D 2.9 (75 kW | 2.9 Litre)**

01.97 - 04.00	OM 602.980		246-075-017-002C	SWP-M-G	Plug Number (T2): 4
---------------	------------	--	------------------	---------	---------------------

01.97 - 04.00	OM 602.980		246-075-021-007C	SWP-M-G	Plug Number (T2): 1; T25: A000 869 30 21
---------------	------------	--	------------------	---------	------------------------------------------

01.97 - 04.00	OM 602.980		246-082-008-014C	SWP-M-C	Plug Number (T2): 1
---------------	------------	--	------------------	---------	---------------------

**311 CDI (80 kW | 2.1 Litre)**

04.00 - 05.06	OM 611.981		246-082-008-014C	SWP-M-C	Plug Number (T2): 1
---------------	------------	--	------------------	---------	---------------------

**311 CDI 4x4 (80 kW | 2.1 Litre)**

08.02 - 05.06	OM 611.981		246-082-008-014C	SWP-M-C	Plug Number (T2): 1
---------------	------------	--	------------------	---------	---------------------

**312 D 2.9 (90 kW | 2.9 Litre)**

02.95 - 04.00	OM 602.980		246-082-008-014C	SWP-M-C	Plug Number (T2): 1
---------------	------------	--	------------------	---------	---------------------

**313 CDI (95 kW | 2.1 Litre)**

04.00 - 05.06	OM 611.981		246-082-008-014C	SWP-M-C	Plug Number (T2): 1
---------------	------------	--	------------------	---------	---------------------

**313 CDI 4x4 (95 kW | 2.1 Litre)**

08.02 - 05.06	OM 611.981		246-082-008-014C	SWP-M-C	Plug Number (T2): 1
---------------	------------	--	------------------	---------	---------------------

**314 (105 kW | 2.3 Litre)**

02.00 - 05.06	M 111.984		246-082-008-014C	SWP-M-C	Plug Number (T2): 1
---------------	-----------	--	------------------	---------	---------------------

**314 4x4 (105 kW | 2.3 Litre)**

08.02 - 05.06	M 111.984		246-082-008-014C	SWP-M-C	Plug Number (T2): 1
---------------	-----------	--	------------------	---------	---------------------





			<b>VDO</b>		
Date	Engine Code	Chassis No.	Article No.	Product	Information

**MERCEDES-BENZ****SPRINTER 3-t Platform/Chassis (903)****314 NGT (92 kW | 2.3 Litre)**

04.00 - 05.06 | 246-082-008-014C | SWP-M-C | Plug Number (T2): 1

**316 CDI (115 kW | 2.7 Litre)**

04.00 - 05.06 | OM 612.981 | 246-082-008-014C | SWP-M-C | Plug Number (T2): 1

**316 CDI 4x4 (115 kW | 2.7 Litre)**

08.02 - 05.06 | OM 612.981 | 246-082-008-014C | SWP-M-C | Plug Number (T2): 1

**SPRINTER 4-t Bus (904)****408 CDI (60 kW | 2.1 Litre)**

04.00 - 05.06 | OM 611.987 | 246-082-008-014C | SWP-M-C | Plug Number (T2): 1

**411 CDI (80 kW | 2.1 Litre)**

04.00 - 05.06 | OM 611.981 | 246-082-008-014C | SWP-M-C | Plug Number (T2): 1

**413 CDI (95 kW | 2.1 Litre)**

04.00 - 05.06 | OM 611.981 | 246-082-008-014C | SWP-M-C | Plug Number (T2): 1

**414 (105 kW | 2.3 Litre)**

02.96 - 05.06 | M 111.979 | 246-082-008-014C | SWP-M-C | Plug Number (T2): 1

**416 CDI (115 kW | 2.7 Litre)**

04.00 - 05.06 | OM 612.981 | 246-082-008-014C | SWP-M-C | Plug Number (T2): 1

**SPRINTER 4-t Box (904)****408 CDI (60 kW | 2.1 Litre)**

04.00 - 05.06 | OM 611.987 | 246-082-008-014C | SWP-M-C | Plug Number (T2): 1

**408 D (58 kW | 2.3 Litre)**

02.96 - 05.06 | OM 601.943 | 246-082-008-014C | SWP-M-C | Plug Number (T2): 1

**410 D (75 kW | 2.9 Litre)**

02.96 - 05.06 | OM 602.980 | 246-082-008-014C | SWP-M-C | Plug Number (T2): 1

**410 D 4x4 (75 kW | 2.9 Litre)**

05.97 - 05.06 | OM 602.980 | 246-082-008-014C | SWP-M-C | Plug Number (T2): 1

**411 CDI 4x4 (80 kW | 2.1 Litre)**

04.00 - 05.06 | OM 611.981 | 246-082-008-014C | SWP-M-C | Plug Number (T2): 1

**411 CDI (80 kW | 2.1 Litre)**

04.00 - 05.06 | OM 611.981 | 246-082-008-014C | SWP-M-C | Plug Number (T2): 1

**412 D (85 kW | 2.9 Litre)**

02.96 - 05.06 | OM 602.980 | 246-082-008-014C | SWP-M-C | Plug Number (T2): 1

**412 D (90 kW | 2.9 Litre)**

02.96 - 05.06 | OM 602.980 | 246-082-008-014C | SWP-M-C | Plug Number (T2): 1

**412 D 4x4 (85 kW | 2.9 Litre)**

05.97 - 05.06 | OM 602.980 | 246-082-008-014C | SWP-M-C | Plug Number (T2): 1

**412 D 4x4 (90 kW | 2.9 Litre)**

05.97 - 05.06 | OM 602.980 | 246-082-008-014C | SWP-M-C | Plug Number (T2): 1

**413 CDI (95 kW | 2.1 Litre)**

04.00 - 05.06 | OM 611.981 | 246-082-008-014C | SWP-M-C | Plug Number (T2): 1

**413 CDI 4x4 (95 kW | 2.1 Litre)**

04.00 - 05.06 | OM 611.981 | 246-082-008-014C | SWP-M-C | Plug Number (T2): 1

**414 4x4 (105 kW | 2.3 Litre)**

05.97 - 05.06 | M 111.979 | 246-082-008-014C | SWP-M-C | Plug Number (T2): 1

**414 (105 kW | 2.3 Litre)**

02.96 - 05.06 | M 111.979 | 246-082-008-014C | SWP-M-C | Plug Number (T2): 1

**416 CDI (115 kW | 2.7 Litre)**

04.00 - 05.06 | OM 612.981 | 246-082-008-014C | SWP-M-C | Plug Number (T2): 1

**416 CDI 4x4 (115 kW | 2.7 Litre)**

04.00 - 05.06 | OM 612.981 | 246-082-008-014C | SWP-M-C | Plug Number (T2): 1

**SPRINTER 4-t Platform/Chassis (904)****408 CDI (60 kW | 2.1 Litre)**

04.00 - 05.06 | OM 611.987 | 246-082-008-014C | SWP-M-C | Plug Number (T2): 1

**408 D (58 kW | 2.3 Litre)**

02.00 - 05.06 | OM 601.943 | 246-082-008-014C | SWP-M-C | Plug Number (T2): 1

**410 D (75 kW | 2.9 Litre)**

02.00 - 05.06 | OM 602.980 | 246-082-008-014C | SWP-M-C | Plug Number (T2): 1

**410 D 4x4 (75 kW | 2.9 Litre)**

02.00 - 05.06 | OM 602.980 | 246-082-008-014C | SWP-M-C | Plug Number (T2): 1



			<b>VDO</b>		
Date	Engine Code	Chassis No.	Article No.	Product	Information

**MERCEDES-BENZ****SPRINTER 4-t Platform/Chassis (904)****411 CDI 4x4 (80 kW | 2.1 Litre)**

04.00 → 05.06 | OM 611.981 | 246-082-008-014C | SWP-M-C | Plug Number (T2): 1

**411 CDI (80 kW | 2.1 Litre)**

04.00 → 05.06 | OM 611.981 | 246-082-008-014C | SWP-M-C | Plug Number (T2): 1

**412 D (85 kW | 2.9 Litre)**

02.00 → 05.06 | OM 602.980 | 246-082-008-014C | SWP-M-C | Plug Number (T2): 1

**412 D (90 kW | 2.9 Litre)**

02.00 → 05.06 | OM 602.980 | 246-082-008-014C | SWP-M-C | Plug Number (T2): 1

**412 D 4x4 (85 kW | 2.9 Litre)**

02.00 → 05.06 | OM 602.980 | 246-082-008-014C | SWP-M-C | Plug Number (T2): 1

**412 D 4x4 (90 kW | 2.9 Litre)**

02.00 → 05.06 | OM 602.980 | 246-082-008-014C | SWP-M-C | Plug Number (T2): 1

**413 CDI (95 kW | 2.1 Litre)**

04.00 → 05.06 | OM 611.981 | 246-082-008-014C | SWP-M-C | Plug Number (T2): 1

**413 CDI 4x4 (95 kW | 2.1 Litre)**

04.00 → 05.06 | OM 611.981 | 246-082-008-014C | SWP-M-C | Plug Number (T2): 1

**414 4x4 (105 kW | 2.3 Litre)**

02.00 → 05.06 | M 111.979 | 246-082-008-014C | SWP-M-C | Plug Number (T2): 1

**414 (105 kW | 2.3 Litre)**

02.00 → 05.06 | M 111.979 | 246-082-008-014C | SWP-M-C | Plug Number (T2): 1

**416 CDI (115 kW | 2.7 Litre)**

04.00 → 05.06 | OM 612.981 | 246-082-008-014C | SWP-M-C | Plug Number (T2): 1

**416 CDI 4x4 (115 kW | 2.7 Litre)**

04.00 → 05.06 | OM 612.981 | 246-082-008-014C | SWP-M-C | Plug Number (T2): 1

**T1 Bus (601)****207 D 2.4 (48 kW | 2.4 Litre)**05.77 → 12.82 | OM 616.917, OM 616.934 | 214383→  
-499999 | 246-082-008-014C | SWP-M-C | Plug Number (T2): 1**207 D 2.4 (53 kW | 2.4 Litre)**07.82 → 01.90 | 214383→  
-499999 | 246-082-008-014C | SWP-M-C | Plug Number (T2): 1**208 2.3 (63 kW | 2.3 Litre)**

05.77 → 12.82 | M 115.955, M 115.972 | 246-075-021-007C | SWP-M-G | Plug Number (T2): 1; T25: A000 869 29 21

05.77 → 12.82 | M 115.955, M 115.972 | 246-082-008-014C | SWP-M-C | Plug Number (T2): 1

**208 D 2.3 (58 kW | 2.3 Litre)**

10.88 → 02.96 | OM 601.940 | 246-075-021-007C | SWP-M-G | Plug Number (T2): 1; T25: A000 869 29 21

10.88 → 02.96 | OM 601.940 | 246-082-008-014C | SWP-M-C | Plug Number (T2): 1

**208 D 2.3 (60 kW | 2.3 Litre)**

10.88 → 02.96 | OM 601.940 | 246-075-021-007C | SWP-M-G | Plug Number (T2): 1; T25: A000 869 29 21

10.88 → 02.96 | OM 601.940 | 246-082-008-014C | SWP-M-C | Plug Number (T2): 1

**209 D 2.9 (65 kW | 2.9 Litre)**

12.82 → 01.90 | OM 617.913 | 246-075-021-007C | SWP-M-G | Plug Number (T2): 1; T25: A000 869 29 21

12.82 → 01.90 | OM 617.913 | 246-082-008-014C | SWP-M-C | Plug Number (T2): 1

**210 2.3 (70 kW | 2.3 Litre)**

07.82 → 01.90 | M 102.942 | 246-075-021-007C | SWP-M-G | Plug Number (T2): 1; T25: A000 869 29 21

07.82 → 01.90 | M 102.942 | 246-082-008-014C | SWP-M-C | Plug Number (T2): 1

**210 2.3 (77 kW | 2.3 Litre)**

05.89 → 02.96 | M 102.945 | 246-075-021-007C | SWP-M-G | Plug Number (T2): 1; T25: A000 869 29 21

05.89 → 02.96 | M 102.945 | 246-082-008-014C | SWP-M-C | Plug Number (T2): 1

**210 D 2.8 (70 kW | 2.8 Litre)**

11.88 → 02.96 | OM 602.940 | 246-075-021-007C | SWP-M-G | Plug Number (T2): 1; T25: A000 869 29 21

11.88 → 02.96 | B202XI (KAT) | 246-082-008-014C | SWP-M-C | Plug Number (T2): 1

**210 D 2.8 (72 kW | 2.8 Litre)**

11.88 → 02.96 | OM 602.940 | 246-075-021-007C | SWP-M-G | Plug Number (T2): 1; T25: A000 869 29 21

11.88 → 02.96 | B202XL | 246-082-008-014C | SWP-M-C | Plug Number (T2): 1

**T1 Box (601)****207 D 2.4 (53 kW | 2.4 Litre)**06.82 → 01.90 | OM 616.937, OM 616.939 | 214383→  
-499999 | 246-082-008-014C | SWP-M-C | Plug Number (T2): 1



					
Date	Engine Code	Chassis No.	Article No.	Product	Information

**MERCEDES-BENZ****T1 Box (601)**

<b>208 D 2.3 (58 kW   2.3 Litre)</b>					
11.88 - 02.96	OM 601.940	214383→ -499999	246-082-008-014C	SWP-M-C	Plug Number (T2): 1
<b>208 D 2.3 (60 kW   2.3 Litre)</b>					
10.88 - 02.96	OM 601.940		246-075-021-007C	SWP-M-G	Plug Number (T2): 1; T25: A000 869 29 21
10.88 - 02.96	OM 601.940		246-082-008-014C	SWP-M-C	Plug Number (T2): 1
<b>209 D 2.9 (65 kW   2.9 Litre)</b>					
12.82 - 01.90	OM 617.913	214383→ -499999	246-082-008-014C	SWP-M-C	Plug Number (T2): 1
<b>210 2.3 (70 kW   2.3 Litre)</b>					
07.82 - 02.96	M 102.942, M 102.946	533802→ -499999	246-082-008-014C	SWP-M-C	Plug Number (T2): 1
<b>210 2.3 (77 kW   2.3 Litre)</b>					
05.89 - 02.96	M 102.945		246-075-021-007C	SWP-M-G	Plug Number (T2): 1; T25: A000 869 29 21
05.89 - 02.96	M 102.945		246-082-008-014C	SWP-M-C	Plug Number (T2): 1
<b>210 D 2.8 (70 kW   2.8 Litre)</b>					
10.88 - 02.96	OM 602.940	214383→ -499999	246-082-008-014C	SWP-M-C	Plug Number (T2): 1
<b>210 D 2.8 (72 kW   2.8 Litre)</b>					
10.88 - 02.96	OM 602.940		246-082-008-014C	SWP-M-C	Plug Number (T2): 1

**T1 Platform/Chassis (601)**

<b>210 2.3 (63 kW   2.3 Litre)</b>					
04.77 - 10.89	M 115.955	214383→ -499999	246-082-008-014C	SWP-M-C	Plug Number (T2): 1

**T1 Bus (602)**

<b>310 D 2.9 (70 kW   2.9 Litre)</b>					
06.89 - 02.96	OM 602.940		246-075-017-002C	SWP-M-G	Plug Number (T2): 4
06.89 - 02.96	OM 602.940		246-075-021-007C	SWP-M-G	Plug Number (T2): 1; T25: A000 869 30 21
<b>310 D 2.9 (72 kW   2.9 Litre)</b>					
06.90 - 02.96	OM 602.940		246-075-021-007C	SWP-M-G	Plug Number (T2): 1; T25: A000 869 30 21

**T1 Box (602)**

<b>309 D 3.0 (65 kW   3.0 Litre)</b>					
10.82 - 01.90	OM 617.913		246-075-017-002C	SWP-M-G	Plug Number (T2): 4
10.82 - 01.90	OM 617.913		246-075-021-007C	SWP-M-G	Plug Number (T2): 1; T25: A000 869 30 21
10.82 - 01.90	OM 617.913		246-075-024-002C	SWP-M-G	Plug Number (T2): 1; T25: A000 869 31 21
<b>310 D 2.9 (70 kW   2.9 Litre)</b>					
06.89 - 02.96	OM 602.940		246-075-017-002C	SWP-M-G	Plug Number (T2): 4
06.89 - 02.96	OM 602.940		246-075-021-007C	SWP-M-G	Plug Number (T2): 1; T25: A000 869 30 21
<b>310 D 2.9 (72 kW   2.9 Litre)</b>					
06.89 - 02.96	OM 602.940		246-075-017-002C	SWP-M-G	Plug Number (T2): 4
06.89 - 02.96	OM 602.940		246-075-021-007C	SWP-M-G	Plug Number (T2): 1; T25: A000 869 30 21

**T1 Platform/Chassis (602)**

<b>309 D 3.0 (65 kW   3.0 Litre)</b>					
10.82 - 01.90	OM 617.913		246-075-017-002C	SWP-M-G	Plug Number (T2): 4
10.82 - 01.90	OM 617.913		246-075-021-007C	SWP-M-G	Plug Number (T2): 1; T25: A000 869 30 21
<b>310 D 2.9 (70 kW   2.9 Litre)</b>					
06.89 - 02.96	OM 602.940		246-075-017-002C	SWP-M-G	Plug Number (T2): 4
06.89 - 02.96	OM 602.940		246-075-021-007C	SWP-M-G	Plug Number (T2): 1; T25: A000 869 30 21
<b>310 D 2.9 (72 kW   2.9 Litre)</b>					
06.89 - 02.96	OM 602.940		246-075-017-002C	SWP-M-G	Plug Number (T2): 4
06.89 - 02.96	OM 602.940		246-075-021-007C	SWP-M-G	Plug Number (T2): 1; T25: A000 869 30 21

**T2/LN1 Box Body / Estate**

<b>609 D (668.061, 668.062, 668.063) (63 kW   4.0 Litre)</b>					
04.86 - 12.94	OM 364.919		246-082-008-012C	SWP-M-C	Plug Number (T2): 1
<b>609 D (668.061, 668.062, 668.063) (66 kW   4.0 Litre)</b>					
04.86 - 12.94	OM 364.906		246-082-008-012C	SWP-M-C	Plug Number (T2): 1
<b>609 D (668.061, 668.062, 668.063) (77 kW   4.0 Litre)</b>					
06.94 - 12.94	OM 354.902		246-082-008-012C	SWP-M-C	Plug Number (T2): 1



			<b>VDO</b>		
Date	Engine Code	Chassis No.	Article No.	Product	Information

**MERCEDES-BENZ****T2/LN1 Box Body / Estate**

<b>611 D (668.061, 668.062, 668.063) (77 kW   4.0 Litre)</b>					
06.94 - 12.94	OM 354.901		246-082-008-012C	SWP-M-C	Plug Number (T2): 1
<b>709 D (669.061, 669.062, 669.063) (63 kW   4.0 Litre)</b>					
04.86 - 12.94	OM 364.921		246-082-008-012C	SWP-M-C	Plug Number (T2): 1
04.86 - 12.94	OM 364.921		246-082-008-012C	SWP-M-C	Plug Number (T2): 1
<b>709 D (669.061, 669.062, 669.063) (66 kW   4.0 Litre)</b>					
04.86 - 12.94	OM 364.912, OM 364.906		246-082-008-012C	SWP-M-C	Plug Number (T2): 1
04.86 - 12.94	OM 364.906, OM 364.912		246-082-008-012C	SWP-M-C	Plug Number (T2): 1
<b>711 D (669.361, 669.362, 669.363) (77 kW   4.0 Litre)</b>					
04.86 - 12.94	OM 364.957, OM 354.902, OM 354.903		246-082-008-012C	SWP-M-C	Plug Number (T2): 1
<b>711 D (669.361, 669.362, 669.363) (85 kW   4.0 Litre)</b>					
04.86 - 12.94	OM 364.952, OM 364.950		246-082-008-012C	SWP-M-C	Plug Number (T2): 1
<b>714 D (669.361, 669.362, 669.363) (103 kW   4.0 Litre)</b>					
06.94 - 12.94	OM 354.923		246-082-008-012C	SWP-M-C	Plug Number (T2): 1
<b>809 D (670.061, 670.062, 670.063) (63 kW   4.0 Litre)</b>					
04.86 - 12.94	OM 364.921, OM 364.920		246-082-008-012C	SWP-M-C	Plug Number (T2): 1
<b>809 D (670.061, 670.062, 670.063) (66 kW   4.0 Litre)</b>					
04.86 - 12.94	OM 364.911, OM 364.906		246-082-008-012C	SWP-M-C	Plug Number (T2): 1
<b>811 D (670.362, 670.363) (77 kW   4.0 Litre)</b>					
04.86 - 12.94	OM 364.958, OM 354.903, OM 354.901		246-082-008-012C	SWP-M-C	Plug Number (T2): 1
<b>811 D (670.362, 670.363) (85 kW   4.0 Litre)</b>					
04.86 - 12.94	OM 364.952, OM 364.950		246-082-008-012C	SWP-M-C	Plug Number (T2): 1
<b>814 D (670.364, 670.365, 670.366) (100 kW   4.0 Litre)</b>					
11.87 - 12.94	OM 364.986, OM 364.981		246-082-008-012C	SWP-M-C	Plug Number (T2): 1
<b>814 D (670.364, 670.365, 670.366) (103 kW   4.0 Litre)</b>					
11.87 - 12.94	OM 354.924		246-082-008-012C	SWP-M-C	Plug Number (T2): 1
<b>814 DA 4x4 (670.464, 670.465) (100 kW   4.0 Litre)</b>					
11.87 - 12.94	OM 364.984, OM 364.987		246-082-008-012C	SWP-M-C	Plug Number (T2): 1
<b>814 DA 4x4 (670.464, 670.465) (103 kW   4.0 Litre)</b>					
11.87 - 12.94	OM 354.925		246-082-008-012C	SWP-M-C	Plug Number (T2): 1

**T2/LN1 Platform/Chassis**

<b>609 D (668.001, 668.002, 668.003) (63 kW   4.0 Litre)</b>					
04.86 - 12.94	OM 364.919		246-082-008-012C	SWP-M-C	Plug Number (T2): 1
<b>609 D (668.001, 668.002, 668.003) (66 kW   4.0 Litre)</b>					
04.86 - 12.94	OM 364.906		246-082-008-012C	SWP-M-C	Plug Number (T2): 1
<b>609 D (668.001, 668.002, 668.003) (77 kW   4.0 Litre)</b>					
06.94 - 12.94	OM 354.902		246-082-008-012C	SWP-M-C	Plug Number (T2): 1
<b>611 D (668.001, 668.002, 668.003) (77 kW   4.0 Litre)</b>					
06.94 - 12.94	OM 354.902		246-082-008-012C	SWP-M-C	Plug Number (T2): 1
<b>709 D (669.000, 669.001, 669.002, 669.003, 669.041) (63 kW   4.0 Litre)</b>					
04.86 - 12.94	OM 364.921		246-082-008-012C	SWP-M-C	Plug Number (T2): 1
04.86 - 12.94	OM 364.921		246-082-008-012C	SWP-M-C	Plug Number (T2): 1
<b>709 D (669.000, 669.001, 669.002, 669.003, 669.041) (66 kW   4.0 Litre)</b>					
04.86 - 12.94	OM 364.912, OM 364.906		246-082-008-012C	SWP-M-C	Plug Number (T2): 1
04.86 - 12.94	OM 364.912, OM 364.906		246-082-008-012C	SWP-M-C	Plug Number (T2): 1
<b>711 D (669.301, 669.302, 669.303) (77 kW   4.0 Litre)</b>					
04.86 - 12.94	OM 364.957, OM 354.903, OM 354.902		246-082-008-012C	SWP-M-C	Plug Number (T2): 1
<b>711 D (669.301, 669.302, 669.303) (85 kW   4.0 Litre)</b>					
04.86 - 12.94	OM 364.952, OM 364.950		246-082-008-012C	SWP-M-C	Plug Number (T2): 1
<b>714 D (669.301, 669.302, 669.303) (103 kW   4.0 Litre)</b>					
06.94 - 12.94	OM 354.923		246-082-008-012C	SWP-M-C	Plug Number (T2): 1
<b>809 D (670.001, 670.002, 670.003) (63 kW   4.0 Litre)</b>					
04.86 - 12.94	OM 364.921, OM 364.920		246-082-008-012C	SWP-M-C	Plug Number (T2): 1
<b>809 D (670.001, 670.002, 670.003) (66 kW   4.0 Litre)</b>					
04.86 - 12.94	OM 364.911, OM 364.906		246-082-008-012C	SWP-M-C	Plug Number (T2): 1
<b>811 D (670.302, 670.303) (77 kW   4.0 Litre)</b>					
04.86 - 12.94	OM 364.958, OM 354.901, OM 354.903		246-082-008-012C	SWP-M-C	Plug Number (T2): 1



			<b>VDO</b>		
Date	Engine Code	Chassis No.	Article No.	Product	Information

**MERCEDES-BENZ****T2/LN1 Platform/Chassis**

<b>811 D (670.302, 670.303) (85 kW   4.0 Litre)</b>					
04.86 → 12.94	OM 364.950, OM 364.952		246-082-008-012C	SWP-M-C	Plug Number (T2): 1
<b>814 D (670.312, 670.313) (100 kW   4.0 Litre)</b>					
11.87 → 12.94	OM 364.986, OM 364.981		246-082-008-012C	SWP-M-C	Plug Number (T2): 1
<b>814 D (670.312, 670.313) (103 kW   4.0 Litre)</b>					
11.87 → 12.94	OM 354.924		246-082-008-012C	SWP-M-C	Plug Number (T2): 1
<b>814 DA 4x4 (670.411, 670.412) (100 kW   4.0 Litre)</b>					
11.87 → 12.94	OM 364.984, OM 364.987		246-082-008-012C	SWP-M-C	Plug Number (T2): 1
<b>814 DA 4x4 (670.411, 670.412) (103 kW   4.0 Litre)</b>					
11.87 → 12.94	OM 354.925		246-082-008-012C	SWP-M-C	Plug Number (T2): 1

**T2/LN1 Cab with engine**

<b>809 DT (670.199) (63 kW   4.0 Litre)</b>					
04.86 → 12.94	OM 364.920, OM 364.921		246-082-008-012C	SWP-M-C	Plug Number (T2): 1
<b>809 DT (670.199) (66 kW   4.0 Litre)</b>					
04.86 → 12.94	OM 364.906, OM 364.911		246-082-008-012C	SWP-M-C	Plug Number (T2): 1

**T2/LN1 Dumptruck**

<b>609 DK (668.041, 668.042) (63 kW   4.0 Litre)</b>					
04.86 → 12.94	OM 364.919		246-082-008-012C	SWP-M-C	Plug Number (T2): 1
<b>609 DK (668.041, 668.042) (66 kW   4.0 Litre)</b>					
04.86 → 12.94	OM 364.906		246-082-008-012C	SWP-M-C	Plug Number (T2): 1
<b>611 DK (668.041, 668.042) (77 kW   4.0 Litre)</b>					
06.94 → 12.94	OM 354.901		246-082-008-012C	SWP-M-C	Plug Number (T2): 1
<b>709 DK (669.041, 669.042) (63 kW   4.0 Litre)</b>					
04.86 → 12.94	OM 364.921		246-082-008-012C	SWP-M-C	Plug Number (T2): 1
<b>709 DK (669.041, 669.042) (66 kW   4.0 Litre)</b>					
04.86 → 12.94	OM 364.906		246-082-008-012C	SWP-M-C	Plug Number (T2): 1
<b>809 DK (670.041, 670.042) (63 kW   4.0 Litre)</b>					
04.86 → 12.94	OM 364.921, OM 364.920		246-082-008-012C	SWP-M-C	Plug Number (T2): 1
<b>809 DK (670.041, 670.042) (66 kW   4.0 Litre)</b>					
04.86 → 12.94	OM 364.906, OM 364.911		246-082-008-012C	SWP-M-C	Plug Number (T2): 1
<b>811 DK (670.341, 670.342) (77 kW   4.0 Litre)</b>					
04.86 → 12.94	OM 364.958, OM 354.903, OM 354.901		246-082-008-012C	SWP-M-C	Plug Number (T2): 1
<b>811 DK (670.341, 670.342) (85 kW   4.0 Litre)</b>					
04.86 → 12.94	OM 364.952, OM 364.950		246-082-008-012C	SWP-M-C	Plug Number (T2): 1

**T2/L Platform/Chassis**

<b>L 406 DG (309.100, 309.101, 309.102, 309.103) (44 kW   2.2 Litre)</b>					
01.68 → 12.74	OM 615.910		246-075-024-002C	SWP-M-G	Plug Number (T2): 1

**T2/LN1 Bus**

<b>O 609 D (672.072, 672.073) (66 kW   4.0 Litre)</b>					
07.87 → 12.92	OM 364.913		246-082-008-012C	SWP-M-C	Plug Number (T2): 1
<b>O 611 D (672.372, 672.373) (85 kW   4.0 Litre)</b>					
07.87 → 12.92	OM 364.952, OM 364.954		246-082-008-012C	SWP-M-C	Plug Number (T2): 1

**T2/L Box Body / Estate**

<b>L 406 DG (309.111, 309.112, 309.113, 309.114, 309.115...) (44 kW   2.2 Litre)</b>					
01.68 → 12.74	OM 615.910		246-075-024-002C	SWP-M-G	Plug Number (T2): 1

**VARIO Bus**

<b>O 814 (670.373, 670.374) (100 kW   4.2 Litre)</b>					
09.96 →	OM 904.908		246-082-008-012C	SWP-M-C	Plug Number (T2): 1

**VARIO Platform/Chassis**

<b>613 D, 614 D (668.321, 668.322, 668.323) (100 kW   4.2 Litre)</b>					
09.96 →	OM 904.908		246-082-008-012C	SWP-M-C	Plug Number (T2): 1
<b>613 D, 614 D (668.321, 668.322, 668.323) (95 kW   4.2 Litre)</b>					
09.96 →	OM 904.908		246-082-008-012C	SWP-M-C	Plug Number (T2): 1
<b>615 D, 616 D (668.321, 668.322, 668.323) (112 kW   4.3 Litre)</b>					
09.98 →	OM 904.923		246-082-008-012C	SWP-M-C	Plug Number (T2): 1



			<b>VDO</b>		
Date	Engine Code	Chassis No.	Article No.	Product	Information

**MERCEDES-BENZ****VARIO Platform/Chassis**

<b>615 D, 616 D (668.321, 668.322, 668.323) (115 kW   4.3 Litre)</b>					
09.98 -	OM 904.923		246-082-008-012C	SWP-M-C	Plug Number (T2): 1
<b>813 D, 814 D (670.321, 670.322, 670.323, 670.324) (100 kW   4.2 Litre)</b>					
09.96 -	OM 904.908		246-082-008-012C	SWP-M-C	Plug Number (T2): 1
<b>813 D, 814 D (670.321, 670.322, 670.323, 670.324) (95 kW   4.2 Litre)</b>					
09.96 -	OM 904.908		246-082-008-012C	SWP-M-C	Plug Number (T2): 1
<b>813 DA, 814 DA 4x4 (670.421, 670.422, 670.423) (100 kW   4.2 Litre)</b>					
09.96 -	OM 904.908		246-082-008-012C	SWP-M-C	Plug Number (T2): 1
<b>813 DA, 814 DA 4x4 (670.421, 670.422, 670.423) (95 kW   4.2 Litre)</b>					
09.96 -	OM 904.908		246-082-008-012C	SWP-M-C	Plug Number (T2): 1
<b>815 D, 816 D (670.321, 670.322, 670.323, 670.324) (112 kW   4.3 Litre)</b>					
09.96 -	OM 904.923		246-082-008-012C	SWP-M-C	Plug Number (T2): 1
<b>815 D, 816 D (670.321, 670.322, 670.323, 670.324) (115 kW   4.3 Litre)</b>					
09.96 -	OM 904.923		246-082-008-012C	SWP-M-C	Plug Number (T2): 1
<b>815 DA, 816 DA 4x4 (670.421, 670.422, 670.423) (112 kW   4.3 Litre)</b>					
09.96 -	OM 904.923		246-082-008-012C	SWP-M-C	Plug Number (T2): 1
<b>815 DA, 816 DA 4x4 (670.421, 670.422, 670.423) (115 kW   4.3 Litre)</b>					
09.96 -	OM 904.923		246-082-008-012C	SWP-M-C	Plug Number (T2): 1

**VARIO Box Body / Estate**

<b>613 D, 614 D (668.351, 668.352, 668.353) (100 kW   4.2 Litre)</b>					
09.96 -	OM 904.908		246-082-008-012C	SWP-M-C	Plug Number (T2): 1
<b>613 D, 614 D (668.351, 668.352, 668.353) (95 kW   4.2 Litre)</b>					
09.96 -	OM 904.908		246-082-008-012C	SWP-M-C	Plug Number (T2): 1
<b>615 D, 616 D (668.351, 668.352, 668.353) (112 kW   4.3 Litre)</b>					
09.98 -	OM 904.923		246-082-008-012C	SWP-M-C	Plug Number (T2): 1
<b>615 D, 616 D (668.351, 668.352, 668.353) (115 kW   4.3 Litre)</b>					
09.98 -	OM 904.923		246-082-008-012C	SWP-M-C	Plug Number (T2): 1
<b>813 D, 814 D (670.351, 670.352, 670.353) (100 kW   4.2 Litre)</b>					
09.96 -	OM 904.908		246-082-008-012C	SWP-M-C	Plug Number (T2): 1
<b>813 D, 814 D (670.351, 670.352, 670.353) (95 kW   4.2 Litre)</b>					
09.96 -	OM 904.908		246-082-008-012C	SWP-M-C	Plug Number (T2): 1
<b>813 DA, 814 DA 4x4 (669.599, 670.451, 670.452, 670.453) (100 kW   4.2 Litre)</b>					
09.96 -	OM 904.908		246-082-008-012C	SWP-M-C	Plug Number (T2): 1
<b>813 DA, 814 DA 4x4 (669.599, 670.451, 670.452, 670.453) (95 kW   4.2 Litre)</b>					
09.96 -	OM 904.908		246-082-008-012C	SWP-M-C	Plug Number (T2): 1
<b>815 D, 816 D (670.351, 670.352, 670.353) (112 kW   4.3 Litre)</b>					
09.96 -	OM 904.923		246-082-008-012C	SWP-M-C	Plug Number (T2): 1
<b>815 D, 816 D (670.351, 670.352, 670.353) (115 kW   4.3 Litre)</b>					
09.96 -	OM 904.923		246-082-008-012C	SWP-M-C	Plug Number (T2): 1
<b>815 DA, 816 DA 4x4 (669.599, 670.451, 670.452, 670.453) (112 kW   4.3 Litre)</b>					
09.96 -	OM 904.923		246-082-008-012C	SWP-M-C	Plug Number (T2): 1
<b>815 DA, 816 DA 4x4 (669.599, 670.451, 670.452, 670.453) (115 kW   4.3 Litre)</b>					
09.96 -	OM 904.923		246-082-008-012C	SWP-M-C	Plug Number (T2): 1

**VARIO Dumptruck**

<b>613 D, 614 D (668.331, 668.332) (100 kW   4.2 Litre)</b>					
09.96 -	OM 904.908		246-082-008-012C	SWP-M-C	Plug Number (T2): 1
<b>613 D, 614 D (668.331, 668.332) (95 kW   4.2 Litre)</b>					
09.96 -	OM 904.908		246-082-008-012C	SWP-M-C	Plug Number (T2): 1
<b>615 D, 616 D (668.331, 668.332) (112 kW   4.3 Litre)</b>					
09.98 -	OM 904.923		246-082-008-012C	SWP-M-C	Plug Number (T2): 1
<b>615 D, 616 D (668.331, 668.332) (115 kW   4.3 Litre)</b>					
09.98 -	OM 904.923		246-082-008-012C	SWP-M-C	Plug Number (T2): 1
<b>813 D, 814 D (670.331, 670.332) (100 kW   4.2 Litre)</b>					
09.96 -	OM 904.908		246-082-008-012C	SWP-M-C	Plug Number (T2): 1
<b>813 D, 814 D (670.331, 670.332) (95 kW   4.2 Litre)</b>					
09.96 -	OM 904.908		246-082-008-012C	SWP-M-C	Plug Number (T2): 1
<b>813 DA, 814 DA 4x4 (670.431, 670.432) (100 kW   4.2 Litre)</b>					
09.96 -	OM 904.908		246-082-008-012C	SWP-M-C	Plug Number (T2): 1
<b>813 DA, 814 DA 4x4 (670.431, 670.432) (95 kW   4.2 Litre)</b>					
09.96 -	OM 904.908		246-082-008-012C	SWP-M-C	Plug Number (T2): 1



			<b>VDO</b>		
Date	Engine Code	Chassis No.	Article No.	Product	Information

**MERCEDES-BENZ****VARIO Dumptruck****815 D, 816 D (670.331, 670.332) (112 kW | 4.3 Litre)**

09.96 - OM 904.923 246-082-008-012C SWP-M-C Plug Number (T2): 1

**815 D, 816 D (670.331, 670.332) (115 kW | 4.3 Litre)**

09.96 - OM 904.923 246-082-008-012C SWP-M-C Plug Number (T2): 1

**815 DA, 816 DA 4x4 (670.431, 670.432) (112 kW | 4.3 Litre)**

09.96 - OM 904.923 246-082-008-012C SWP-M-C Plug Number (T2): 1

**815 DA, 816 DA 4x4 (670.431, 670.432) (115 kW | 4.3 Litre)**

09.96 - OM 904.923 246-082-008-012C SWP-M-C Plug Number (T2): 1

**MITSUBISHI****SPACE STAR (DG\_A)****1.3 16V (DG1A) (60 kW | 1.3 Litre)**

09.00 - 12.04 4G13 (16V) 246-086-001-002C HLWP Plug Number (T2): 3; T26: X11-246-003-013

**1.3 16V (DG1A) (61 kW | 1.3 Litre)**

11.99 - 12.04 4G13 (16V) 246-086-001-002C HLWP Plug Number (T2): 3; T26: X11-246-003-013

**1.3 16V (DG1A) (63 kW | 1.3 Litre)**

11.99 - 12.04 4G13 (16V) 246-086-001-002C HLWP Plug Number (T2): 3; T26: X11-246-003-013

**1.6 16V (DG3A) (72 kW | 1.6 Litre)**

01.01 - 12.04 4G18 246-086-001-002C HLWP Plug Number (T2): 3; T26: X11-246-003-013

**1.8 GDI (DG5A) (87 kW | 1.8 Litre)**

11.99 - 12.04 4G93 (GDI) 246-086-001-002C HLWP Plug Number (T2): 3; T26: X11-246-003-013

**1.8 GDI (DG5A) (90 kW | 1.8 Litre)**

11.99 - 12.04 4G93 (GDI) 246-086-001-002C HLWP Plug Number (T2): 3; T26: X11-246-003-013

**1.8 MPI (82 kW | 1.8 Litre)**

10.02 - 12.04 4G93 246-086-001-002C HLWP Plug Number (T2): 3; T26: X11-246-003-013

**1.9 DI-D (85 kW | 1.9 Litre)**

10.02 - 12.04 F9Q2 246-086-001-002C HLWP Plug Number (T2): 3; T26: X11-246-003-013

**1.9 DI-D (DG4A) (75 kW | 1.9 Litre)**

02.01 - 12.04 F9Q1 246-086-001-002C HLWP Plug Number (T2): 3; T26: X11-246-003-013

**OPEL****AGILA (A) (H00)****1.0 12V (43 kW | 1.0 Litre)**

09.00 - Z 10 XE 246-083-002-014G SWP-D-C Plug Number (T2): 6

**1.2 16V (55 kW | 1.2 Litre)**

09.00 - Z 12 XE 246-083-002-014G SWP-D-C Plug Number (T2): 6

**AMPERA****EV 150 (111 kW | 0.0 Litre)**

11.11 - A 14 XFL A2C53240114 SWP-M-C

**ASCONA C Hatchback (84\_, 89\_)****1.3 S (55 kW | 1.3 Litre)**

09.81 - 08.88 13 S 246-082-008-014C SWP-M-C Plug Number (T2): 1

**1.6 (55 kW | 1.6 Litre)**

09.81 - 08.88 16 N 246-082-008-014C SWP-M-C Plug Number (T2): 1

**1.6 i (55 kW | 1.6 Litre)**

09.87 - 08.88 E 16 NZ 246-082-008-014C SWP-M-C Plug Number (T2): 1

**1.6 S (66 kW | 1.6 Litre)**

09.81 - 08.86 16 SH 246-082-008-014C SWP-M-C Plug Number (T2): 1

**1.8 i (85 kW | 1.8 Litre)**

09.82 - 08.86 18 E 246-082-008-014C SWP-M-C Plug Number (T2): 1

**2.0 i (85 kW | 2.0 Litre)**

09.86 - 08.88 20 NE 246-082-008-014C SWP-M-C Plug Number (T2): 1

**2.0 i CAT (85 kW | 2.0 Litre)**

09.86 - 08.88 C 20 NE 246-082-008-014C SWP-M-C Plug Number (T2): 1



			<b>VDO</b>		
Date	Engine Code	Chassis No.	Article No.	Product	Information

**OPEL****ASCONA C (81\_, 86\_, 87\_, 88\_)****1.3 N (44 kW | 1.3 Litre)**

09.81 - 07.83 13 N 246-082-008-014C SWP-M-C Plug Number (T2): 1

**1.3 S (55 kW | 1.3 Litre)**

08.83 - 08.88 13 S 246-082-008-014C SWP-M-C Plug Number (T2): 1

**1.6 (55 kW | 1.6 Litre)**

09.81 - 08.86 16 N 246-082-008-014C SWP-M-C Plug Number (T2): 1

**1.6 (60 kW | 1.6 Litre)**

09.86 - 08.88 16 SV 246-082-008-014C SWP-M-C Plug Number (T2): 1

**1.6 D (40 kW | 1.6 Litre)**

03.82 - 08.88 16 D, 16 DA 246-082-008-014C SWP-M-C Plug Number (T2): 1

**1.6 i (55 kW | 1.6 Litre)**

09.87 - 08.88 E 16 NZ, E 16 LZ 246-082-008-014C SWP-M-C Plug Number (T2): 1

**1.6 i CAT (55 kW | 1.6 Litre)**

09.86 - 08.88 C 16 NZ, C 16 LZ 246-082-008-014C SWP-M-C Plug Number (T2): 1

**1.6 S (66 kW | 1.6 Litre)**

09.81 - 08.86 16 SH 246-082-008-014C SWP-M-C Plug Number (T2): 1

**1.8 (62 kW | 1.8 Litre)**

09.87 - 08.88 E 18 NV 246-082-008-014C SWP-M-C Plug Number (T2): 1

**1.8 E (74 kW | 1.8 Litre)**

01.85 - 08.86 C 18 NE, S 18 NV 246-082-008-014C SWP-M-C Plug Number (T2): 1

**1.8 i (85 kW | 1.8 Litre)**

09.82 - 08.86 18 E 246-082-008-014C SWP-M-C Plug Number (T2): 1

**2.0 i (74 kW | 2.0 Litre)**

08.87 - 08.88 C 20 NEF 246-082-008-014C SWP-M-C Plug Number (T2): 1

**2.0 i (85 kW | 2.0 Litre)**

09.86 - 08.88 20 NE 246-082-008-014C SWP-M-C Plug Number (T2): 1

**2.0 i CAT (85 kW | 2.0 Litre)**

09.86 - 08.88 C 20 NE 246-082-008-014C SWP-M-C Plug Number (T2): 1

**2.0 i GT (95 kW | 2.0 Litre)**

03.87 - 08.88 20 SEH 246-082-008-014C SWP-M-C Plug Number (T2): 1

**ASTRA F Hatchback (53\_, 54\_, 58\_, 59\_)****1.4 (55 kW | 1.4 Litre)**

09.91 - 09.93 14 NV 246-082-008-014C SWP-M-C Plug Number (T2): 1

09.91 - 09.93 14 NV 246-083-001-004C SWP-D-C Plug Number (T2): 1; T24: GL →

**1.4 (60 kW | 1.4 Litre)**

09.92 - 01.98 14 SE 246-082-008-014C SWP-M-C Plug Number (T2): 1

09.92 - 01.98 14 SE 246-083-001-004C SWP-D-C Plug Number (T2): 1; T24: GL →

**1.4 i (44 kW | 1.4 Litre)**

03.92 - 01.98 C 14 NZ 246-082-008-014C SWP-M-C Plug Number (T2): 1

03.92 - 01.98 C 14 NZ 246-083-001-004C SWP-D-C Plug Number (T2): 1; T24: GL →

**1.4 i 16V (66 kW | 1.4 Litre)**

01.96 - 01.88 X 14 XE 246-082-008-014C SWP-M-C Plug Number (T2): 1

01.96 - 01.98 X 14 XE 246-083-001-004C SWP-D-C Plug Number (T2): 1; T24: GL →

**1.4 Si (60 kW | 1.4 Litre)**

03.92 - 01.98 C 14 SE 246-082-008-014C SWP-M-C Plug Number (T2): 1

03.92 - 01.98 C 14 SE 246-083-001-004C SWP-D-C Plug Number (T2): 1; T24: GL →

**1.6 (55 kW | 1.6 Litre)**

09.95 - 01.98 16 LZ2, 16 NZR 246-082-008-014C SWP-M-C Plug Number (T2): 1

09.95 - 01.98 16 LZ2, 16 NZR 246-083-001-004C SWP-D-C Plug Number (T2): 1; T24: GL →

**1.6 i (52 kW | 1.6 Litre)**

05.93 - 07.96 X 16 SZ 246-082-008-014C SWP-M-C Plug Number (T2): 1

05.93 - 07.96 X 16 SZ 246-083-001-004C SWP-D-C Plug Number (T2): 1; T24: GL →

**1.6 i (55 kW | 1.6 Litre)**

09.91 - 01.98 C 16 NZ, X 16 SZR 246-082-008-014C SWP-M-C Plug Number (T2): 1

09.91 - 01.98 C 16 NZ, X 16 SZR 246-083-001-004C SWP-D-C Plug Number (T2): 1; T24: GL →

**1.6 i 16V (74 kW | 1.6 Litre)**

01.85 - 01.98 X 16 XEL 246-082-008-014C SWP-M-C Plug Number (T2): 1

08.94 - 01.98 X 16 XEL 246-083-001-004C SWP-D-C Plug Number (T2): 1; T24: GL →

**1.6 Si (74 kW | 1.6 Litre)**

03.92 - 12.94 C 16 SE 246-082-008-014C SWP-M-C Plug Number (T2): 1

03.92 - 12.94 C 16 SE 246-083-001-004C SWP-D-C Plug Number (T2): 1; T24: GL →





					
Date	Engine Code	Chassis No.	Article No.	Product	Information

**OPEL****ASTRA F Hatchback (53\_, 54\_, 58\_, 59\_)****1.7 D (42 kW | 1.7 Litre)**

12.91 → 09.92	17 D		246-082-008-014C	SWP-M-C	Plug Number (T2): 1
12.91 → 09.92	17 D		246-083-001-004C	SWP-D-C	Plug Number (T2): 1; T24: GL →

**1.7 D (44 kW | 1.7 Litre)**

07.92 → 01.98	17 DR		246-082-008-014C	SWP-M-C	Plug Number (T2): 1
07.92 → 01.98	17 DR		246-083-001-004C	SWP-D-C	Plug Number (T2): 1; T24: GL →

**1.7 TD (50 kW | 1.7 Litre)**

11.94 → 01.98	X 17 DTL		246-082-008-014C	SWP-M-C	Plug Number (T2): 1
11.94 → 01.98	X 17 DTL		246-083-001-004C	SWP-D-C	Plug Number (T2): 1; T24: GL →

**1.7 TDS (60 kW | 1.7 Litre)**

12.91 → 01.98	17 DT (TC4EE1), X 17 DT (TC4EE1)		246-082-008-014C	SWP-M-C	Plug Number (T2): 1
12.91 → 01.98	17 DT (TC4EE1), X 17 DT (TC4EE1)		246-083-001-004C	SWP-D-C	Plug Number (T2): 1; T24: GL →

**1.8 (85 kW | 1.8 Litre)**

11.91 → 07.93	18 SE		246-082-008-014C	SWP-M-C	Plug Number (T2): 1
---------------	-------	--	------------------	---------	---------------------

**1.8 i (66 kW | 1.8 Litre)**

09.91 → 01.98	C 18 NZ		246-082-008-014C	SWP-M-C	Plug Number (T2): 1
09.91 → 01.98	C 18 NZ		246-083-001-004C	SWP-D-C	Plug Number (T2): 1; T24: GL →

**1.8 i 16V (85 kW | 1.8 Litre)**

09.94 → 01.98	C 18 XEL, X 18 XE		246-082-008-014C	SWP-M-C	Plug Number (T2): 1
09.94 → 01.98	C 18 XEL, X 18 XE		246-083-001-004C	SWP-D-C	Plug Number (T2): 1; T24: GL →

**1.8 i 16V (92 kW | 1.8 Litre)**

06.93 → 08.94	C 18 XE		246-082-008-014C	SWP-M-C	Plug Number (T2): 1
06.93 → 08.94	C 18 XE		246-083-001-004C	SWP-D-C	Plug Number (T2): 1; T24: GL →

**2.0 GSI 16V (110 kW | 2.0 Litre)**

09.91 → 01.98	C 20 XE		246-082-008-014C	SWP-M-C	Plug Number (T2): 1
09.91 → 01.98	C 20 XE		246-083-001-004C	SWP-D-C	Plug Number (T2): 1; T24: GL →

**2.0 i (85 kW | 2.0 Litre)**

09.91 → 01.98	C 20 NE		246-082-008-014C	SWP-M-C	Plug Number (T2): 1
09.91 → 01.98	C 20 NE		246-083-001-004C	SWP-D-C	Plug Number (T2): 1; T24: GL →

**2.0 i 16V (100 kW | 2.0 Litre)**

02.95 → 01.98	X 20 XEV		246-082-008-014C	SWP-M-C	Plug Number (T2): 1
02.95 → 01.98	X 20 XEV		246-083-001-004C	SWP-D-C	Plug Number (T2): 1; T24: GL →

**ASTRA F (56\_, 57\_)****1.4 (55 kW | 1.4 Litre)**

09.91 → 09.93	14 NV		246-082-008-014C	SWP-M-C	Plug Number (T2): 1
09.91 → 09.93	14 NV		246-083-001-004C	SWP-D-C	Plug Number (T2): 1; T24: GL →

**1.4 (60 kW | 1.4 Litre)**

09.92 → 09.98	14 SE		246-082-008-014C	SWP-M-C	Plug Number (T2): 1
09.92 → 09.98	14 SE		246-083-001-004C	SWP-D-C	Plug Number (T2): 1; T24: GL →

**1.4 i (44 kW | 1.4 Litre)**

09.91 → 09.98	C 14 NZ		246-082-008-014C	SWP-M-C	Plug Number (T2): 1
09.91 → 01.98	C 14 NZ, X 14 NZ		246-082-008-014C	SWP-M-C	Plug Number (T2): 1
09.91 → 09.98	C 14 NZ, X 14 NZ		246-083-001-004C	SWP-D-C	Plug Number (T2): 1; T24: GL →

**1.4 i 16V (66 kW | 1.4 Litre)**

02.96 → 09.98	X 14 XE		246-082-008-014C	SWP-M-C	Plug Number (T2): 1
02.96 → 09.98	X 14 XE		246-083-001-004C	SWP-D-C	Plug Number (T2): 1; T24: GL →

**1.4 Si (60 kW | 1.4 Litre)**

03.92 → 09.98	C 14 SE		246-082-008-014C	SWP-M-C	Plug Number (T2): 1
03.92 → 03.96	C 14 SE		246-082-008-014C	SWP-M-C	Plug Number (T2): 1
03.92 → 09.98	C 14 SE		246-083-001-004C	SWP-D-C	Plug Number (T2): 1; T24: GL →

**1.6 (55 kW | 1.6 Litre)**

09.95 → 09.98	16 LZ2, 16 NZR		246-082-008-014C	SWP-M-C	Plug Number (T2): 1
09.95 → 09.98	16 LZ2, 16 NZR		246-083-001-004C	SWP-D-C	Plug Number (T2): 1; T24: GL →

**1.6 i (52 kW | 1.6 Litre)**

05.93 → 07.96	X 16 SZ		246-082-008-014C	SWP-M-C	Plug Number (T2): 1
07.95 → 07.96	X 16 SZ		246-082-008-014C	SWP-M-C	Plug Number (T2): 1
05.93 → 07.96	X 16 SZ		246-083-001-004C	SWP-D-C	Plug Number (T2): 1; T24: GL →

**1.6 i (55 kW | 1.6 Litre)**

03.92 → 09.98	C 16 NZ, X 16 SZR		246-082-008-014C	SWP-M-C	Plug Number (T2): 1
03.92 → 01.98	C 16 NZ, X 16 SZR		246-082-008-014C	SWP-M-C	Plug Number (T2): 1
08.81 → 07.83	X 16 SZR		246-082-008-014C	SWP-M-C	Plug Number (T2): 1
03.92 → 09.98	C 16 NZ, X 16 SZR		246-083-001-004C	SWP-D-C	Plug Number (T2): 1; T24: GL →



			<b>VDO</b>		
Date	Engine Code	Chassis No.	Article No.	Product	Information

**OPEL****ASTRA F (56\_, 57\_)**

<b>1.6 i (55 kW   1.6 Litre)</b>					
08.96 - 09.98	X 16 SZR		246-083-001-004C	SWP-D-C	Plug Number (T2): 1; T24: GL →
<b>1.6 i 16V (74 kW   1.6 Litre)</b>					
08.82 - 09.98	X 16 XEL		246-082-008-014C	SWP-M-C	Plug Number (T2): 1
08.94 - 01.98	X 16 XEL		246-082-008-014C	SWP-M-C	Plug Number (T2): 1
08.94 - 09.98	X 16 XEL		246-083-001-004C	SWP-D-C	Plug Number (T2): 1; T24: GL →
<b>1.6 Si (74 kW   1.6 Litre)</b>					
05.92 - 12.94	C 16 SE		246-082-008-014C	SWP-M-C	Plug Number (T2): 1
05.92 - 12.94	C 16 SE		246-082-008-014C	SWP-M-C	Plug Number (T2): 1
05.92 - 12.94	C 16 SE		246-083-001-004C	SWP-D-C	Plug Number (T2): 1; T24: GL →
<b>1.7 D (42 kW   1.7 Litre)</b>					
03.92 - 09.92	17 D		246-082-008-014C	SWP-M-C	Plug Number (T2): 1
03.92 - 09.92	17 D		246-082-008-014C	SWP-M-C	Plug Number (T2): 1
03.92 - 09.92	17 D		246-083-001-004C	SWP-D-C	Plug Number (T2): 1; T24: GL →
<b>1.7 D (44 kW   1.7 Litre)</b>					
07.92 - 09.98	17 DR		246-082-008-014C	SWP-M-C	Plug Number (T2): 1
09.92 - 01.98	17 DR		246-082-008-014C	SWP-M-C	Plug Number (T2): 1
07.92 - 09.98	17 DR		246-083-001-004C	SWP-D-C	Plug Number (T2): 1; T24: GL →
<b>1.7 TD (50 kW   1.7 Litre)</b>					
11.94 - 09.98	X 17 DTL		246-082-008-014C	SWP-M-C	Plug Number (T2): 1
11.94 - 09.98	X 17 DTL		246-083-001-004C	SWP-D-C	Plug Number (T2): 1; T24: GL →
<b>1.7 TDS (60 kW   1.7 Litre)</b>					
03.92 - 09.98	17 DT (TC4EE1), X 17 DT (TC4EE1)		246-082-008-014C	SWP-M-C	Plug Number (T2): 1
03.92 - 09.98	17 DT (TC4EE1), X 17 DT (TC4EE1)		246-083-001-004C	SWP-D-C	Plug Number (T2): 1; T24: GL →
<b>1.8 i (66 kW   1.8 Litre)</b>					
03.92 - 09.98	C 18 NZ		246-082-008-014C	SWP-M-C	Plug Number (T2): 1
03.92 - 01.98	C 18 NZ		246-082-008-014C	SWP-M-C	Plug Number (T2): 1
03.92 - 09.98	C 18 NZ		246-083-001-004C	SWP-D-C	Plug Number (T2): 1; T24: GL →
<b>1.8 i 16V (85 kW   1.8 Litre)</b>					
11.94 - 09.98	C 18 XEL, X 18 XE		246-082-008-014C	SWP-M-C	Plug Number (T2): 1
11.94 - 01.98	C 18 XEL, X 18 XE		246-082-008-014C	SWP-M-C	Plug Number (T2): 1
11.94 - 09.98	C 18 XEL, X 18 XE		246-083-001-004C	SWP-D-C	Plug Number (T2): 1; T24: GL →
<b>1.8 i 16V (92 kW   1.8 Litre)</b>					
06.93 - 10.94	C 18 XE		246-082-008-014C	SWP-M-C	Plug Number (T2): 1
07.93 - 10.94	C 18 XE		246-082-008-014C	SWP-M-C	Plug Number (T2): 1
06.93 - 10.94	C 18 XE		246-083-001-004C	SWP-D-C	Plug Number (T2): 1; T24: GL →
<b>2.0 i (85 kW   2.0 Litre)</b>					
03.92 - 09.98	C 20 NE		246-082-008-014C	SWP-M-C	Plug Number (T2): 1
03.92 - 01.98	C 20 NE		246-082-008-014C	SWP-M-C	Plug Number (T2): 1
03.92 - 09.98	C 20 NE		246-083-001-004C	SWP-D-C	Plug Number (T2): 1; T24: GL →
<b>2.0 i 16V (100 kW   2.0 Litre)</b>					
12.76 - 09.98	X 20 XEV	827 2084 530→	246-082-008-014C	SWP-M-C	Plug Number (T2): 1
02.95 - 01.98	X 20 XEV		246-082-008-014C	SWP-M-C	Plug Number (T2): 1
02.95 - 09.98	X 20 XEV		246-083-001-004C	SWP-D-C	Plug Number (T2): 1; T24: GL →

**ASTRA F Estate (51\_, 52\_)**

<b>1.4 (55 kW   1.4 Litre)</b>					
09.91 - 09.93	14 NV		246-082-008-014C	SWP-M-C	Plug Number (T2): 1
09.91 - 09.93	14 NV		246-083-001-004C	SWP-D-C	Plug Number (T2): 1; T24: GL →
<b>1.4 (60 kW   1.4 Litre)</b>					
09.92 - 01.98	14 SE		246-082-008-014C	SWP-M-C	Plug Number (T2): 1
09.92 - 01.98	14 SE		246-083-001-004C	SWP-D-C	Plug Number (T2): 1; T24: GL →
<b>1.4 i (44 kW   1.4 Litre)</b>					
09.91 - 01.98	C 14 NZ		246-082-008-014C	SWP-M-C	Plug Number (T2): 1
09.91 - 01.98	C 14 NZ		246-083-001-004C	SWP-D-C	Plug Number (T2): 1; T24: GL →
<b>1.4 i 16V (66 kW   1.4 Litre)</b>					
02.96 - 01.98	X 14 XE		246-082-008-014C	SWP-M-C	Plug Number (T2): 1
02.96 - 01.98	X 14 XE		246-083-001-004C	SWP-D-C	Plug Number (T2): 1; T24: GL →
<b>1.4 Si (60 kW   1.4 Litre)</b>					
03.92 - 01.98	C 14 SE		246-082-008-014C	SWP-M-C	Plug Number (T2): 1
03.92 - 01.98	C 14 SE		246-083-001-004C	SWP-D-C	Plug Number (T2): 1; T24: GL →
<b>1.6 (55 kW   1.6 Litre)</b>					
09.95 - 01.98	16 LZ2, 16 NZR		246-082-008-014C	SWP-M-C	Plug Number (T2): 1



Date	Engine Code	Chassis No.	Article No.	Product	Information

**OPEL****ASTRA F Estate (51\_, 52\_)****1.6 (55 kW | 1.6 Litre)**

09.95 → 01.98 16 LZ2, 16 NZR 246-083-001-004C SWP-D-C Plug Number (T2): 1; T24: GL →

**1.6 i (52 kW | 1.6 Litre)**

05.93 → 07.96 X 16 SZ 246-082-008-014C SWP-M-C Plug Number (T2): 1

05.93 → 07.96 X 16 SZ 246-083-001-004C SWP-D-C Plug Number (T2): 1; T24: GL →

**1.6 i (55 kW | 1.6 Litre)**

09.91 → 01.98 C 16 NZ, X 16 SZR 246-082-008-014C SWP-M-C Plug Number (T2): 1

09.91 → 01.98 C 16 NZ, X 16 SZR 246-083-001-004C SWP-D-C Plug Number (T2): 1; T24: GL →

**1.6 i 16V (74 kW | 1.6 Litre)**

08.94 → 01.98 X 16 XEL 246-082-008-014C SWP-M-C Plug Number (T2): 1

08.94 → 01.98 X 16 XEL 246-083-001-004C SWP-D-C Plug Number (T2): 1; T24: GL →

**1.6 Si (74 kW | 1.6 Litre)**

03.92 → 12.94 C 16 SE 246-082-008-014C SWP-M-C Plug Number (T2): 1

03.92 → 12.94 C 16 SE 246-083-001-004C SWP-D-C Plug Number (T2): 1; T24: GL →

**1.7 D (42 kW | 1.7 Litre)**

12.91 → 09.92 17 D 246-082-008-014C SWP-M-C Plug Number (T2): 1

12.91 → 09.92 17 D 246-083-001-004C SWP-D-C Plug Number (T2): 1; T24: GL →

**1.7 D (44 kW | 1.7 Litre)**

07.92 → 01.98 17 DR 246-082-008-014C SWP-M-C Plug Number (T2): 1

07.92 → 01.98 17 DR 246-083-001-004C SWP-D-C Plug Number (T2): 1; T24: GL →

**1.7 TD (50 kW | 1.7 Litre)**

11.94 → 01.98 X 17 DTL 246-082-008-014C SWP-M-C Plug Number (T2): 1

11.94 → 01.98 X 17 DTL 246-083-001-004C SWP-D-C Plug Number (T2): 1; T24: GL →

**1.7 TDS (60 kW | 1.7 Litre)**

12.91 → 01.98 17 DT (TC4EE1), X 17 DT (TC4EE1) 246-082-008-014C SWP-M-C Plug Number (T2): 1

12.91 → 01.98 17 DT (TC4EE1), X 17 DT (TC4EE1) 246-083-001-004C SWP-D-C Plug Number (T2): 1; T24: GL →

**1.8 (85 kW | 1.8 Litre)**

11.91 → 07.93 18 SE 246-082-008-014C SWP-M-C Plug Number (T2): 1

**1.8 i (66 kW | 1.8 Litre)**

09.91 → 01.98 C 18 NZ 246-082-008-014C SWP-M-C Plug Number (T2): 1

09.91 → 01.98 C 18 NZ 246-083-001-004C SWP-D-C Plug Number (T2): 1; T24: GL →

**1.8 i 16V (85 kW | 1.8 Litre)**

07.94 → 01.98 C 18 XEL, X 18 XE 246-082-008-014C SWP-M-C Plug Number (T2): 1

07.94 → 01.98 C 18 XEL, X 18 XE 246-083-001-004C SWP-D-C Plug Number (T2): 1; T24: GL →

**1.8 i 16V (92 kW | 1.8 Litre)**

06.93 → 01.98 C 18 XE 246-082-008-014C SWP-M-C Plug Number (T2): 1

06.93 → 01.98 C 18 XE 246-083-001-004C SWP-D-C Plug Number (T2): 1; T24: GL →

**2.0 i (85 kW | 2.0 Litre)**

09.91 → 07.94 C 20 NE 246-082-008-014C SWP-M-C Plug Number (T2): 1

09.91 → 07.94 C 20 NE 246-083-001-004C SWP-D-C Plug Number (T2): 1; T24: GL →

**2.0 i 16V (100 kW | 2.0 Litre)**

02.95 → 01.98 X 20 XEV 246-082-008-014C SWP-M-C Plug Number (T2): 1

02.95 → 01.98 X 20 XEV 246-083-001-004C SWP-D-C Plug Number (T2): 1; T24: GL →

**2.0 i 16V (110 kW | 2.0 Litre)**

03.93 → 01.98 C 20 XE 246-082-008-014C SWP-M-C Plug Number (T2): 1

03.93 → 01.98 C 20 XE 246-083-001-004C SWP-D-C Plug Number (T2): 1; T24: GL →

**ASTRA F Convertible (53\_B)****1.4 i 16V (66 kW | 1.4 Litre)**

01.96 → 03.01 X 14 XE 246-082-008-014C SWP-M-C Plug Number (T2): 1

01.96 → 03.01 X 14 XE 246-083-001-004C SWP-D-C Plug Number (T2): 1

**1.4 Si (60 kW | 1.4 Litre)**

05.93 → 03.01 C 14 SE 246-082-008-014C SWP-M-C Plug Number (T2): 1

05.93 → 03.01 C 14 SE 246-083-001-004C SWP-D-C Plug Number (T2): 1

**1.6 i (52 kW | 1.6 Litre)**

03.93 → 08.96 X 16 SZ 246-082-008-014C SWP-M-C Plug Number (T2): 1

03.93 → 08.96 X 16 SZ 246-083-001-004C SWP-D-C Plug Number (T2): 1

**1.6 i (55 kW | 1.6 Litre)**

01.96 → 03.01 X 16 SZR 246-082-008-014C SWP-M-C Plug Number (T2): 1

01.96 → 03.01 X 16 SZR 246-083-001-004C SWP-D-C Plug Number (T2): 1

**1.8 i 16V (85 kW | 1.8 Litre)**

11.94 → 03.01 C 18 XEL, X 18 XE 246-082-008-014C SWP-M-C Plug Number (T2): 1

11.94 → 03.01 C 18 XEL, X 18 XE 246-083-001-004C SWP-D-C Plug Number (T2): 1



			<b>VDO</b>		
Date	Engine Code	Chassis No.	Article No.	Product	Information

**OPEL****ASTRA F Convertible (53\_B)****2.0 i (85 kW | 2.0 Litre)**

03.93 - 10.94	C 20 NE		246-082-008-014C	SWP-M-C	Plug Number (T2): 1
03.93 - 10.94	C 20 NE		246-083-001-004C	SWP-D-C	Plug Number (T2): 1

**ASTRA F Van (55\_)****1.4 i (44 kW | 1.4 Litre)**

10.91 - 01.99	C 14 NZ		246-082-008-014C	SWP-M-C	Plug Number (T2): 1
---------------	---------	--	------------------	---------	---------------------

**1.6 i (52 kW | 1.6 Litre)**

02.93 - 07.91	X 16 SZ		246-082-008-014C	SWP-M-C	Plug Number (T2): 1
---------------	---------	--	------------------	---------	---------------------

**1.6 i (55 kW | 1.6 Litre)**

10.91 - 04.93	C 16 NZ		246-082-008-014C	SWP-M-C	Plug Number (T2): 1
---------------	---------	--	------------------	---------	---------------------

**1.7 D (42 kW | 1.7 Litre)**

12.91 - 09.92	17 D		246-082-008-014C	SWP-M-C	Plug Number (T2): 1
---------------	------	--	------------------	---------	---------------------

**1.7 D (44 kW | 1.7 Litre)**

07.92 - 01.99	17 DR		246-082-008-014C	SWP-M-C	Plug Number (T2): 1
---------------	-------	--	------------------	---------	---------------------

**1.7 TD (50 kW | 1.7 Litre)**

08.94 - 01.99	X 17 DTL		246-082-008-014C	SWP-M-C	Plug Number (T2): 1
---------------	----------	--	------------------	---------	---------------------

02.98 - 01.99	X 17 DTL		246-083-002-014G	SWP-D-C	Plug Number (T2): 6
---------------	----------	--	------------------	---------	---------------------

**ASTRA F CLASSIC Hatchback****1.2 i (48 kW | 1.2 Litre)**

03.98 - 08.00	X 12 XE		246-082-008-014C	SWP-M-C	Plug Number (T2): 1
---------------	---------	--	------------------	---------	---------------------

**1.4 i (44 kW | 1.4 Litre)**

01.98 - 08.02	X 14 NZ		246-082-008-014C	SWP-M-C	Plug Number (T2): 1
---------------	---------	--	------------------	---------	---------------------

**1.4 i (66 kW | 1.4 Litre)**

03.98 - 08.00	X 14 XE		246-082-008-014C	SWP-M-C	Plug Number (T2): 1
---------------	---------	--	------------------	---------	---------------------

**1.6 i (55 kW | 1.6 Litre)**

01.98 - 08.02	X 16 SZR		246-082-008-014C	SWP-M-C	Plug Number (T2): 1
---------------	----------	--	------------------	---------	---------------------

02.98 - 08.02	X 16 SZR		246-083-002-014G	SWP-D-C	Plug Number (T2): 6
---------------	----------	--	------------------	---------	---------------------

**1.6 i 16V (74 kW | 1.6 Litre)**

01.98 - 08.02	X 16 XEL		246-082-008-014C	SWP-M-C	Plug Number (T2): 1
---------------	----------	--	------------------	---------	---------------------

02.98 - 08.02	X 16 XEL		246-083-002-014G	SWP-D-C	Plug Number (T2): 6
---------------	----------	--	------------------	---------	---------------------

**1.7 TD (50 kW | 1.7 Litre)**

03.98 - 08.00	X 17 DTL		246-082-008-014C	SWP-M-C	Plug Number (T2): 1
---------------	----------	--	------------------	---------	---------------------

**1.8 i (85 kW | 1.8 Litre)**

03.98 - 07.91	X 18 XE1		246-082-008-014C	SWP-M-C	Plug Number (T2): 1
---------------	----------	--	------------------	---------	---------------------

**2.0 Di (60 kW | 2.0 Litre)**

03.98 - 08.00	X 20 DTL		246-082-008-014C	SWP-M-C	Plug Number (T2): 1
---------------	----------	--	------------------	---------	---------------------

**2.0 DTi (74 kW | 2.0 Litre)**

08.99 - 08.00	X 20 DTH		246-082-008-014C	SWP-M-C	Plug Number (T2): 1
---------------	----------	--	------------------	---------	---------------------

**2.0 i (100 kW | 2.0 Litre)**

03.98 - 08.00	X 20 XEV		246-082-008-014C	SWP-M-C	Plug Number (T2): 1
---------------	----------	--	------------------	---------	---------------------

**2.0 i (118 kW | 2.0 Litre)**

10.99 - 08.00	X 20 XER		246-082-008-014C	SWP-M-C	Plug Number (T2): 1
---------------	----------	--	------------------	---------	---------------------

**ASTRA F CLASSIC Saloon****1.4 i (44 kW | 1.4 Litre)**

01.98 - 08.02	X 14 NZ		246-082-008-014C	SWP-M-C	Plug Number (T2): 1
---------------	---------	--	------------------	---------	---------------------

**1.6 i (55 kW | 1.6 Litre)**

01.98 - 08.02	X 16 SZR		246-082-008-014C	SWP-M-C	Plug Number (T2): 1
---------------	----------	--	------------------	---------	---------------------

**1.6 i 16V (74 kW | 1.6 Litre)**

01.98 - 08.02	X 16 XEL		246-082-008-014C	SWP-M-C	Plug Number (T2): 1
---------------	----------	--	------------------	---------	---------------------

**ASTRA F CLASSIC Estate****1.4 i (44 kW | 1.4 Litre)**

01.98 - 01.05	X 14 NZ		246-082-008-014C	SWP-M-C	Plug Number (T2): 1
---------------	---------	--	------------------	---------	---------------------

**1.6 i (55 kW | 1.6 Litre)**

01.98 - 01.05	X 16 SZR		246-082-008-014C	SWP-M-C	Plug Number (T2): 1
---------------	----------	--	------------------	---------	---------------------

**1.6 i 16V (74 kW | 1.6 Litre)**

01.98 - 01.05	X 16 XEL		246-082-008-014C	SWP-M-C	Plug Number (T2): 1
---------------	----------	--	------------------	---------	---------------------

02.98 - 01.05	X 16 XEL		246-083-002-014G	SWP-D-C	Plug Number (T2): 6
---------------	----------	--	------------------	---------	---------------------

**1.8 (81 kW | 1.8 Litre)**

02.03 - 07.04	Z 18 XEL		246-082-008-014C	SWP-M-C	Plug Number (T2): 1
---------------	----------	--	------------------	---------	---------------------



Date	Engine Code	Chassis No.	Article No.	Product	Information

**OPEL****ASTRA G Hatchback (F48\_, F08\_)****1.4 16V (66 kW | 1.4 Litre)**

02.98 - 01.05 X 14 XE, Z 14 XE

246-083-002-014G

SWP-D-C

Plug Number (T2): 6

**2.0 16V OPC (118 kW | 2.0 Litre)**

11.99 - 12.99 X 20 XER

246-083-002-014G

SWP-D-C

Plug Number (T2): 6

**ASTRA G Saloon (F69\_)****1.2 16V (48 kW | 1.2 Litre)**

09.98 - 09.00 X 12 XE

246-083-002-014G

SWP-D-C

Plug Number (T2): 6

**2.0 DTI 16V (74 kW | 2.0 Litre)**

08.99 - 01.05 X 20 DTH, Y 20 DTH

246-083-002-014G

SWP-D-C

Plug Number (T2): 6

**ASTRA G Estate (F35\_)****1.2 16V (48 kW | 1.2 Litre)**

02.98 - 09.00 X 12 XE

246-083-002-014G

SWP-D-C

Plug Number (T2): 6

**1.4 16V (66 kW | 1.4 Litre)**

06.98 - 07.04 X 14 XE, Z 14 XE

246-083-002-014G

SWP-D-C

Plug Number (T2): 6

**1.6 (55 kW | 1.6 Litre)**

02.98 - 09.00 X 16 SZR

246-083-002-014G

SWP-D-C

Plug Number (T2): 6

**1.8 16V (85 kW | 1.8 Litre)**

02.98 - 09.00 X 18 XE1

246-083-002-014G

SWP-D-C

Plug Number (T2): 6

**2.0 DTI 16V (74 kW | 2.0 Litre)**

08.99 - 07.04 X 20 DTH, Y 20 DTH

246-083-002-014G

SWP-D-C

Plug Number (T2): 6

**ASTRA G Coupe (F07\_)****1.8 16V (85 kW | 1.8 Litre)**

03.00 - 10.00 X 18 XE1

246-082-008-021G

SWP-M-C

Plug Number (T2): 6

**ASTRA G Box (F70)****1.6 (55 kW | 1.6 Litre)**

01.99 - 09.00 X 16 SZR

246-083-002-014G

SWP-D-C

Plug Number (T2): 6

**ASTRA J Saloon****1.3 CDTI (70 kW | 1.3 Litre)**

06.12 - A 13 DTE

A2C53240114

SWP-M-C

**1.4 (74 kW | 1.4 Litre)**

06.12 - A 14 XER

A2C53240114

SWP-M-C

**1.4 Turbo (103 kW | 1.4 Litre)**

06.12 - A 14 NET

A2C53240114

SWP-M-C

**1.6 Turbo (132 kW | 1.6 Litre)**

06.12 - A 16 LET

A2C53240114

SWP-M-C

**1.6 Turbo (85 kW | 1.6 Litre)**

06.12 - A 16 XER

A2C53240114

SWP-M-C

**1.7 CDTI (81 kW | 1.7 Litre)**

06.12 - A 17 DTC, A 17 DTJ, A 17 DTE

A2C53240114

SWP-M-C

**1.7 CDTI (96 kW | 1.7 Litre)**

06.12 - A 17 DTS, A 17 DTF

A2C53240114

SWP-M-C

**CALIBRA A (85\_)****2.0 i (85 kW | 2.0 Litre)**

06.90 - 07.97 C 20 NE

246-083-001-004C

SWP-D-C

Plug Number (T2): 1

**2.0 i 16V (100 kW | 2.0 Litre)**

02.94 - 07.97 X 20 XEV

246-083-001-004C

SWP-D-C

Plug Number (T2): 1

**2.0 i 16V (110 kW | 2.0 Litre)**

06.90 - 02.94 C 20 XE

246-083-001-004C

SWP-D-C

Plug Number (T2): 1

**2.0 i 16V 4x4 (100 kW | 2.0 Litre)**

02.94 - 07.97 X 20 XEV

246-083-001-004C

SWP-D-C

Plug Number (T2): 1

**2.0 i 16V 4x4 (110 kW | 2.0 Litre)**

06.90 - 02.94 C 20 XE

246-083-001-004C

SWP-D-C

Plug Number (T2): 1

**2.0 i 4x4 (85 kW | 2.0 Litre)**

06.90 - 07.97 C 20 NE

246-083-001-004C

SWP-D-C

Plug Number (T2): 1

**2.0 i Turbo 4x4 (150 kW | 2.0 Litre)**

03.92 - 07.97 C 20 LET

246-083-001-004C

SWP-D-C

Plug Number (T2): 1



Date	Engine Code	Chassis No.	Article No.	Product	Information

**OPEL****CALIBRA A (85\_)****2.5 i V6 (125 kW | 2.5 Litre)**

04.93 - 07.97	C 25 XE, X 25 XE		246-083-001-004C	SWP-D-C	Plug Number (T2): 1
---------------	------------------	--	------------------	---------	---------------------

**COMMODORE C (14\_, 19\_)****2.5 E (96 kW | 2.5 Litre)**

05.81 - 07.82	25 E		246-082-008-014C	SWP-M-C	Plug Number (T2): 1
---------------	------	--	------------------	---------	---------------------

**2.5 S (85 kW | 2.5 Litre)**

08.78 - 07.82	25 S		246-082-008-014C	SWP-M-C	Plug Number (T2): 1
---------------	------	--	------------------	---------	---------------------

**COMMODORE C Estate (61)****2.5 E (96 kW | 2.5 Litre)**

05.81 - 07.82	25 E		246-082-008-014C	SWP-M-C	Plug Number (T2): 1
---------------	------	--	------------------	---------	---------------------

**2.5 S (85 kW | 2.5 Litre)**

05.81 - 07.82	25 S		246-082-008-014C	SWP-M-C	Plug Number (T2): 1
---------------	------	--	------------------	---------	---------------------

**COMBO (71\_)****1.2 (33 kW | 1.2 Litre)**

07.94 - 10.01	C 12 NZ, X 12 SZ		246-083-001-004C	SWP-D-C	Plug Number (T2): 1
07.95 - 10.01	C 12 NZ, X 12 SZ		246-083-002-014G	SWP-D-C	Plug Number (T2): 6; Vehicle Equipment (T31): for vehicles with air conditioning (T32)

**1.4 (44 kW | 1.4 Litre)**

07.94 - 10.01	C 14 NZ, X 14 SZ		246-083-001-004C	SWP-D-C	Plug Number (T2): 1
---------------	------------------	--	------------------	---------	---------------------

**1.4 (60 kW | 1.4 Litre)**

07.94 - 10.01	C 14 SE		246-083-001-004C	SWP-D-C	Plug Number (T2): 1
---------------	---------	--	------------------	---------	---------------------

**1.4 16V (66 kW | 1.4 Litre)**

08.99 - 10.01	X 14 XE		246-083-001-004C	SWP-D-C	Plug Number (T2): 1
---------------	---------	--	------------------	---------	---------------------

**1.7 D (44 kW | 1.7 Litre)**

07.94 - 10.01	17 D (4EE1), X 17 D (4EE1)		246-083-001-004C	SWP-D-C	Plug Number (T2): 1
---------------	----------------------------	--	------------------	---------	---------------------

07.95 - 10.01	17 D (4EE1), X 17 D (4EE1)		246-083-002-014G	SWP-D-C	Plug Number (T2): 6; Vehicle Equipment (T31): for vehicles with air conditioning (T32)
---------------	----------------------------	--	------------------	---------	----------------------------------------------------------------------------------------

**COMBO Tour****1.3 CDTI 16V (51 kW | 1.3 Litre)**

10.04 -	Z 13 DT, Y 13 DT		246-083-002-014G	SWP-D-C	Plug Number (T2): 6
---------	------------------	--	------------------	---------	---------------------

**CORSA A Hatchback (93\_, 94\_, 98\_, 99\_)****1.0 (33 kW | 1.0 Litre)**

05.85 - 12.88	10 S		246-082-008-014C	SWP-M-C	Plug Number (T2): 1
09.82 - 03.93	10 S	- J - 4 000 001→	246-083-001-004C	SWP-D-C	Plug Number (T2): 1

**1.2 (33 kW | 1.2 Litre)**

09.82 - 08.90	12 NC, E 12 GV	- J - 4 000 001→	246-083-001-004C	SWP-D-C	Plug Number (T2): 1
---------------	----------------	------------------	------------------	---------	---------------------

**1.2 i (33 kW | 1.2 Litre)**

09.89 - 03.93	C 12 NZ	- J - 4 000 001→	246-083-001-004C	SWP-D-C	Plug Number (T2): 1
---------------	---------	------------------	------------------	---------	---------------------

**1.2 N (38 kW | 1.2 Litre)**

01.90 - 03.93	12 NV	- J - 4 000 001→	246-083-001-004C	SWP-D-C	Plug Number (T2): 1
---------------	-------	------------------	------------------	---------	---------------------

**1.2 S (40 kW | 1.2 Litre)**

05.85 - 12.88	12 ST		246-082-008-014C	SWP-M-C	Plug Number (T2): 1
09.82 - 02.90	12 ST	- J - 4 000 001→	246-083-001-004C	SWP-D-C	Plug Number (T2): 1

**1.3 (44 kW | 1.3 Litre)**

09.85 - 10.89	13 NB	- J - 4 000 001→	246-083-001-004C	SWP-D-C	Plug Number (T2): 1
---------------	-------	------------------	------------------	---------	---------------------

**1.3 i (44 kW | 1.3 Litre)**

09.86 - 09.90	C 13 N	- J - 4 000 001→	246-083-001-004C	SWP-D-C	Plug Number (T2): 1
---------------	--------	------------------	------------------	---------	---------------------

**1.3 S (51 kW | 1.3 Litre)**

05.85 - 12.88	13 SB		246-082-008-014C	SWP-M-C	Plug Number (T2): 1
09.82 - 10.89	13 SB	- J - 4 000 001→	246-083-001-004C	SWP-D-C	Plug Number (T2): 1

**1.4 i (40 kW | 1.4 Litre)**

01.85 - 03.93	C 14 NZ	- J - 4 000 001→	246-083-001-004C	SWP-D-C	Plug Number (T2): 1
---------------	---------	------------------	------------------	---------	---------------------

**1.4 i (44 kW | 1.4 Litre)**

01.90 - 03.93	C 14 NZ	- J - 4 000 001→	246-083-001-004C	SWP-D-C	Plug Number (T2): 1
---------------	---------	------------------	------------------	---------	---------------------

**1.4 S (53 kW | 1.4 Litre)**

01.90 - 03.93	14 NV	- J - 4 000 001→	246-083-001-004C	SWP-D-C	Plug Number (T2): 1
---------------	-------	------------------	------------------	---------	---------------------

**1.4 Si (60 kW | 1.4 Litre)**

09.91 - 03.93	C 14 SE	- J - 4 000 001→	246-083-001-004C	SWP-D-C	Plug Number (T2): 1
---------------	---------	------------------	------------------	---------	---------------------



			<b>VDO</b>		
Date	Engine Code	Chassis No.	Article No.	Product	Information

**OPEL****CORSA A Hatchback (93\_, 94\_, 98\_, 99\_)****1.5 D (37 kW | 1.5 Litre)**

09.87 - 03.93 | 15 D (4EC1) | - J - 4 000 001- | 246-083-001-004C | SWP-D-C | Plug Number (T2): 1

**1.5 TD (49 kW | 1.5 Litre)**

03.88 - 03.93 | 15 DT (T4EC1) | - J - 4 000 001- | 246-083-001-004C | SWP-D-C | Plug Number (T2): 1

**1.6 GSI (55 kW | 1.6 Litre)**

08.88 - 09.92 | C 16 NZ | - J - 4 000 001- | 246-083-001-004C | SWP-D-C | Plug Number (T2): 1

**1.6 GSI (72 kW | 1.6 Litre)**

09.89 - 03.93 | C 16 SEI | - J - 4 000 001- | 246-083-001-004C | SWP-D-C | Plug Number (T2): 1

**1.6 GSI (74 kW | 1.6 Litre)**

05.88 - 03.92 | E 16 SE | - J - 4 000 001- | 246-083-001-004C | SWP-D-C | Plug Number (T2): 1

**1.6 GSI CAT (74 kW | 1.6 Litre)**

02.92 - 03.93 | C 16 SE | - J - 4 000 001- | 246-083-001-004C | SWP-D-C | Plug Number (T2): 1

**CORSA A TR (91\_, 92\_, 96\_, 97\_)****1.0 (33 kW | 1.0 Litre)**

10.82 - 12.88 | 10 S | | 246-082-008-014C | SWP-M-C | Plug Number (T2): 1

**1.2 S (40 kW | 1.2 Litre)**

10.82 - 12.88 | 12 ST | | 246-082-008-014C | SWP-M-C | Plug Number (T2): 1

**1.3 (44 kW | 1.3 Litre)**

09.85 - 10.87 | 13 NB, C 13 N | | 246-082-008-014C | SWP-M-C | Plug Number (T2): 1

**1.3 S (51 kW | 1.3 Litre)**

10.82 - 10.87 | 13 SB | | 246-082-008-014C | SWP-M-C | Plug Number (T2): 1

**CORSA A Box****1.3 (44 kW | 1.3 Litre)**

02.86 - 04.89 | 13 NB | -J2500000 | 246-082-008-014C | SWP-M-C | Plug Number (T2): 1

**CORSA B (73\_, 78\_, 79\_)****1.0 i 12V (40 kW | 1.0 Litre)**

11.96 - 09.00 | X 10 XE | | 246-082-008-014C | SWP-M-C | Plug Number (T2): 1

11.96 - 09.00 | X 10 XE | | 246-082-008-021G | SWP-M-C | Plug Number (T2): 6

11.96 - 09.00 | X 10 XE | | 246-083-001-004C | SWP-D-C | Plug Number (T2): 1

11.96 - 09.00 | X 10 XE | | 246-083-002-014G | SWP-D-C | Plug Number (T2): 6

**1.2 i (33 kW | 1.2 Litre)**

03.93 - 09.00 | 12 NZ | | 246-082-008-014C | SWP-M-C | Plug Number (T2): 1

03.93 - 09.00 | C 12 NZ, X 12 SZ | | 246-082-008-014C | SWP-M-C | Plug Number (T2): 1

03.93 - 09.00 | X 12 SZ, C 12 NZ | | 246-082-008-021G | SWP-M-C | Plug Number (T2): 6

03.93 - 09.00 | 12 NZ | | 246-083-001-004C | SWP-D-C | Plug Number (T2): 1

03.93 - 09.00 | X 12 SZ, C 12 NZ | | 246-083-001-004C | SWP-D-C | Plug Number (T2): 1

03.93 - 09.00 | X 12 SZ, C 12 NZ | | 246-083-002-014G | SWP-D-C | Plug Number (T2): 6

**1.2 i 16V (48 kW | 1.2 Litre)**

03.98 - 08.91 | X 12 XE | -M - 400 000 | 246-082-008-014C | SWP-M-C | Plug Number (T2): 1

03.98 - 09.00 | X 12 XE | | 246-082-008-021G | SWP-M-C | Plug Number (T2): 6

03.98 - 09.00 | X 12 XE | | 246-083-001-004C | SWP-D-C | Plug Number (T2): 1

03.98 - 09.00 | X 12 XE | | 246-083-002-014G | SWP-D-C | Plug Number (T2): 6

**1.4 i (44 kW | 1.4 Litre)**

03.93 - 09.00 | C 14 NZ, X 14 SZ | | 246-082-008-014C | SWP-M-C | Plug Number (T2): 1

03.93 - 09.00 | C 14 NZ, X 14 SZ | | 246-082-008-021G | SWP-M-C | Plug Number (T2): 6

03.93 - 09.00 | C 14 NZ, X 14 SZ | | 246-083-001-004C | SWP-D-C | Plug Number (T2): 1

03.93 - 09.00 | C 14 NZ, X 14 SZ | | 246-083-002-014G | SWP-D-C | Plug Number (T2): 6

**1.4 i 16V (63 kW | 1.4 Litre)**

08.97 - 09.00 | C 14 SEL | | 246-082-008-014C | SWP-M-C | Plug Number (T2): 1

08.97 - 09.00 | C 14 SEL | | 246-083-001-004C | SWP-D-C | Plug Number (T2): 1

**1.4 i 16V (66 kW | 1.4 Litre)**

09.94 - 09.00 | X 14 XE | | 246-082-008-014C | SWP-M-C | Plug Number (T2): 1

09.94 - 09.00 | X 14 XE | | 246-082-008-021G | SWP-M-C | Plug Number (T2): 6

09.94 - 09.00 | X 14 XE | | 246-083-001-004C | SWP-D-C | Plug Number (T2): 1

09.94 - 09.00 | X 14 XE | | 246-083-002-014G | SWP-D-C | Plug Number (T2): 6

**1.4 Si (60 kW | 1.4 Litre)**

03.93 - 09.00 | C 14 SE | | 246-082-008-014C | SWP-M-C | Plug Number (T2): 1

03.93 - 09.00 | C 14 SE | | 246-082-008-021G | SWP-M-C | Plug Number (T2): 6

03.93 - 09.00 | C 14 SE | | 246-083-001-004C | SWP-D-C | Plug Number (T2): 1

03.93 - 09.00 | C 14 SE | | 246-083-002-014G | SWP-D-C | Plug Number (T2): 6



			<b>VDO</b>		
Date	Engine Code	Chassis No.	Article No.	Product	Information

**OPEL****CORSA B (73\_, 78\_, 79\_)****1.5 D (37 kW | 1.5 Litre)**

03.93 - 09.00	15 D (4EC1)		246-082-008-014C	SWP-M-C	Plug Number (T2): 1
03.93 - 09.00	15 D (4EC1)		246-082-008-021G	SWP-M-C	Plug Number (T2): 6
03.93 - 09.00	15 D (4EC1)		246-083-001-004C	SWP-D-C	Plug Number (T2): 1
03.93 - 09.00	15 D (4EC1)		246-083-002-014G	SWP-D-C	Plug Number (T2): 6

**1.5 TD (49 kW | 1.5 Litre)**

03.93 - 09.00	15 DT (T4EC1), X 15 DT (T4EC1)		246-082-008-014C	SWP-M-C	Plug Number (T2): 1
03.93 - 09.00	15 DT (T4EC1), X 15 DT (T4EC1)		246-082-008-021G	SWP-M-C	Plug Number (T2): 6
03.93 - 09.00	15 DT (T4EC1), X 15 DT (T4EC1)		246-083-001-004C	SWP-D-C	Plug Number (T2): 1
03.93 - 09.00	15 DT (T4EC1), X 15 DT (T4EC1)		246-083-002-014G	SWP-D-C	Plug Number (T2): 6

**1.6 GSI 16V (80 kW | 1.6 Litre)**

03.93 - 09.00	C 16 XE		246-082-008-014C	SWP-M-C	Plug Number (T2): 1
03.93 - 09.00	C 16 XE		246-082-008-021G	SWP-M-C	Plug Number (T2): 6
03.93 - 09.00	C 16 XE		246-083-001-004C	SWP-D-C	Plug Number (T2): 1
03.93 - 09.00	C 16 XE		246-083-002-014G	SWP-D-C	Plug Number (T2): 6

**1.6 i 16V (74 kW | 1.6 Litre)**

08.97 - 09.00	C 16 SEL		246-082-008-014C	SWP-M-C	Plug Number (T2): 1
08.97 - 09.00	C 16 SEL		246-083-001-004C	SWP-D-C	Plug Number (T2): 1

**1.6 i 16V (78 kW | 1.6 Litre)**

09.94 - 09.00	X 16 XE		246-082-008-014C	SWP-M-C	Plug Number (T2): 1
09.94 - 09.00	X 16 XE		246-082-008-021G	SWP-M-C	Plug Number (T2): 6
09.94 - 09.00	X 16 XE		246-083-001-004C	SWP-D-C	Plug Number (T2): 1
09.94 - 09.00	X 16 XE		246-083-002-014G	SWP-D-C	Plug Number (T2): 6

**1.7 D (44 kW | 1.7 Litre)**

02.96 - 09.00	17 D (4EE1), X 17 D (4EE1)		246-082-008-014C	SWP-M-C	Plug Number (T2): 1
02.96 - 09.00	17 D (4EE1), X 17 D (4EE1)		246-082-008-021G	SWP-M-C	Plug Number (T2): 6
02.96 - 09.00	17 D (4EE1), X 17 D (4EE1)		246-083-001-004C	SWP-D-C	Plug Number (T2): 1
02.96 - 09.00	17 D (4EE1), X 17 D (4EE1)		246-083-002-014G	SWP-D-C	Plug Number (T2): 6

**CORSA B Estate (F35)****1.4 i 16V (66 kW | 1.4 Litre)**

01.99 -	X 14 XE		246-082-008-014C	SWP-M-C	Plug Number (T2): 1
---------	---------	--	------------------	---------	---------------------

**1.7 D (44 kW | 1.7 Litre)**

01.99 -	X 17 D (4EE1)		246-082-008-014C	SWP-M-C	Plug Number (T2): 1
---------	---------------	--	------------------	---------	---------------------

**CORSA B Box (73\_)****1.4 i (44 kW | 1.4 Litre)**

08.99 - 09.00	X 14 SZ		246-082-008-014C	SWP-M-C	Plug Number (T2): 1
---------------	---------	--	------------------	---------	---------------------

**1.6 (71 kW | 1.6 Litre)**

06.96 -			246-082-008-014C	SWP-M-C	Plug Number (T2): 1; T28: Rear (T29)
---------	--	--	------------------	---------	--------------------------------------

**1.7 D (44 kW | 1.7 Litre)**

08.99 - 09.00	17 D (4EE1), X 17 D (4EE1)		246-082-008-014C	SWP-M-C	Plug Number (T2): 1
---------------	----------------------------	--	------------------	---------	---------------------

**CORSA C (F08, F68)****1.0 (43 kW | 1.0 Litre)**

09.00 -	Z 10 XE		246-082-008-021G	SWP-M-C	Plug Number (T2): 6
09.00 -	Z 10 XE		246-083-002-014G	SWP-D-C	Plug Number (T2): 6

**1.2 (55 kW | 1.2 Litre)**

09.00 -	Z 12 XE		246-082-008-021G	SWP-M-C	Plug Number (T2): 6
09.00 -	Z 12 XE		246-083-002-014G	SWP-D-C	Plug Number (T2): 6

**1.4 (66 kW | 1.4 Litre)**

09.00 -	Z 14 XE		246-082-008-021G	SWP-M-C	Plug Number (T2): 6
09.00 -	Z 14 XE		246-083-002-014G	SWP-D-C	Plug Number (T2): 6

**1.7 DI (48 kW | 1.7 Litre)**

09.00 -	Y 17 DTL		246-082-008-021G	SWP-M-C	Plug Number (T2): 6
09.00 -	Y 17 DTL		246-083-002-014G	SWP-D-C	Plug Number (T2): 6

**1.7 DTI (55 kW | 1.7 Litre)**

09.00 -	Y 17 DT		246-082-008-021G	SWP-M-C	Plug Number (T2): 6
09.00 -	Y 17 DT		246-083-002-014G	SWP-D-C	Plug Number (T2): 6

**1.8 (92 kW | 1.8 Litre)**

09.00 -	Z 18 XE		246-082-008-021G	SWP-M-C	Plug Number (T2): 6
09.00 -	Z 18 XE		246-083-002-014G	SWP-D-C	Plug Number (T2): 6





			<b>VDO</b>		
Date	Engine Code	Chassis No.	Article No.	Product	Information

**OPEL****INSIGNIA****1.4 (103 kW | 1.4 Litre)**

04.11 → A 14 NET A2C53240114 SWP-M-C

**1.6 (85 kW | 1.6 Litre)**

07.08 → A 16 XER A2C53240114 SWP-M-C

**1.6 Turbo (132 kW | 1.6 Litre)**

07.08 → A 16 LET A2C53240114 SWP-M-C

**1.8 (103 kW | 1.8 Litre)**

07.08 → A 18 XER A2C53240114 SWP-M-C

**2.0 Biturbo CDTI (140 kW | 2.0 Litre)**

07.08 → A 20 DTR A2C53240114 SWP-M-C

**2.0 Biturbo CDTI 4x4 (140 kW | 2.0 Litre)**

05.09 → A 20 DTR A2C53240114 SWP-M-C

**2.0 CDTI (118 kW | 2.0 Litre)**

07.08 → A 20 DTH A2C53240114 SWP-M-C

**2.0 CDTI (81 kW | 2.0 Litre)**

07.08 → A 20 DTL, A 20 DTC A2C53240114 SWP-M-C

**2.0 CDTI (96 kW | 2.0 Litre)**

07.08 → A 20 DTJ, A 20 DT A2C53240114 SWP-M-C

**2.0 CDTI 4x4 (118 kW | 2.0 Litre)**

06.10 → A 20 DTH A2C53240114 SWP-M-C

**2.0 E85 Turbo (162 kW | 2.0 Litre)**

09.10 → A 20 NHT A2C53240114 SWP-M-C

**2.0 Turbo (162 kW | 2.0 Litre)**

07.08 → A 20 NHT A2C53240114 SWP-M-C

**2.0 Turbo 4x4 (162 kW | 2.0 Litre)**

07.08 → A 20 NHT A2C53240114 SWP-M-C

**2.8 V6 Turbo 4x4 (191 kW | 2.8 Litre)**

07.08 → A 28 NET A2C53240114 SWP-M-C

**2.8 V6 Turbo OPC 4x4 (239 kW | 2.8 Litre)**

07.09 → A 28 NER A2C53240114 SWP-M-C

**INSIGNIA Saloon****1.4 (103 kW | 1.4 Litre)**

04.11 → A 14 NET A2C53240114 SWP-M-C

**1.6 (85 kW | 1.6 Litre)**

07.08 → A 16 XER A2C53240114 SWP-M-C

**1.6 Turbo (132 kW | 1.6 Litre)**

01.09 → A 16 LET A2C53240114 SWP-M-C

**1.8 (103 kW | 1.8 Litre)**

07.08 → A 18 XER A2C53240114 SWP-M-C

**2.0 Biturbo CDTI (140 kW | 2.0 Litre)**

07.08 → A 20 DTR A2C53240114 SWP-M-C

**2.0 Biturbo CDTI (143 kW | 2.0 Litre)**

01.12 → A 20 DTR A2C53240114 SWP-M-C

**2.0 Biturbo CDTI 4x4 (140 kW | 2.0 Litre)**

07.08 → A 20 DTR A2C53240114 SWP-M-C

**2.0 Biturbo CDTI 4x4 (143 kW | 2.0 Litre)**

01.12 → A 20 DTR A2C53240114 SWP-M-C

**2.0 CDTI (118 kW | 2.0 Litre)**

07.08 → A 20 DTH A2C53240114 SWP-M-C

**2.0 CDTI (81 kW | 2.0 Litre)**

07.08 → A 20 DTC, A 20 DTL A2C53240114 SWP-M-C

**2.0 CDTI (96 kW | 2.0 Litre)**

07.08 → A 20 DTJ, A 20 DT A2C53240114 SWP-M-C

**2.0 CDTI 4x4 (118 kW | 2.0 Litre)**

06.10 → A 20 DTH A2C53240114 SWP-M-C

**2.0 Turbo (162 kW | 2.0 Litre)**

07.08 → A 20 NHT A2C53240114 SWP-M-C

**2.0 Turbo 4x4 (162 kW | 2.0 Litre)**

07.08 → A 20 NHT A2C53240114 SWP-M-C

**2.0 Turbo 4x4 (184 kW | 2.0 Litre)**

09.11 → A 20 NHT A2C53240114 SWP-M-C



			<b>VDO</b>		
Date	Engine Code	Chassis No.	Article No.	Product	Information

**OPEL****INSIGNIA Saloon****2.0 Turbo E85 (162 kW | 2.0 Litre)**

07.08 - A 20 NHT A2C53240114 SWP-M-C

**2.8 V6 Turbo 4x4 (191 kW | 2.8 Litre)**

07.08 - A 28 NET A2C53240114 SWP-M-C

**2.8 V6 Turbo OPC 4x4 (239 kW | 2.8 Litre)**

07.09 - A 28 NER A2C53240114 SWP-M-C

**KADETT E Hatchback (33\_, 34\_, 43\_, 44\_)****1.2 (40 kW | 1.2 Litre)**

09.84 - 07.86 12 SC J 2 500 001- 246-083-001-004C SWP-D-C Plug Number (T2): 1

**1.3 i CAT (44 kW | 1.3 Litre)**

09.85 - 08.91 C 13 N J 2 500 001- 246-083-001-004C SWP-D-C Plug Number (T2): 1

**1.3 N (44 kW | 1.3 Litre)**

09.84 - 08.91 13 N, 13 NB J 2 500 001- 246-083-001-004C SWP-D-C Plug Number (T2): 1

**1.3 S (55 kW | 1.3 Litre)**

09.84 - 12.86 13 S -JE100000 246-082-008-014C SWP-M-C Plug Number (T2): 1

09.84 - 08.87 13 S J 2 500 001- 246-083-001-004C SWP-D-C Plug Number (T2): 1

**1.4 i (44 kW | 1.4 Litre)**

01.90 - 08.91 C 14 NZ J 2 500 001- 246-083-001-004C SWP-D-C Plug Number (T2): 1

**1.4 S (55 kW | 1.4 Litre)**

01.90 - 08.91 14 NV J 2 500 001- 246-083-001-004C SWP-D-C Plug Number (T2): 1

**1.5 TD (53 kW | 1.5 Litre)**

07.88 - 08.91 15 DT (T4EC1) J 2 500 001- 246-083-001-004C SWP-D-C Plug Number (T2): 1

**1.6 D (40 kW | 1.6 Litre)**

09.84 - 12.86 16 D, 16 DA -J5000000 246-082-008-014C SWP-M-C Plug Number (T2): 1

09.84 - 01.89 16 D, 16 DA J 2 500 001- 246-083-001-004C SWP-D-C Plug Number (T2): 1

**1.6 i (55 kW | 1.6 Litre)**

09.86 - 08.91 E 16 NZ -J2500000 246-082-008-014C SWP-M-C Plug Number (T2): 1

09.86 - 08.91 E 16 NZ J 2 500 001- 246-083-001-004C SWP-D-C Plug Number (T2): 1

**1.6 i CAT (55 kW | 1.6 Litre)**

09.86 - 08.91 C 16 LZ, C 16 NZ J 2 500 001- 246-083-001-004C SWP-D-C Plug Number (T2): 1

**1.6 S (60 kW | 1.6 Litre)**

09.86 - 08.91 16 SV -JE100000 246-082-008-014C SWP-M-C Plug Number (T2): 1

09.86 - 08.91 16 SV J 2 500 001- 246-083-001-004C SWP-D-C Plug Number (T2): 1

**1.6 S (66 kW | 1.6 Litre)**

09.84 - 08.86 16 SH 246-082-008-014C SWP-M-C Plug Number (T2): 1

09.84 - 08.86 16 SH J 2 500 001- 246-083-001-004C SWP-D-C Plug Number (T2): 1

**1.7 D (42 kW | 1.7 Litre)**

02.89 - 08.91 17 D J 2 500 001- 246-083-001-004C SWP-D-C Plug Number (T2): 1

**1.8 E (74 kW | 1.8 Litre)**

10.85 - 08.86 C 18 NE 246-082-008-014C SWP-M-C Plug Number (T2): 1

10.85 - 08.86 C 18 NE J 2 500 001- 246-083-001-004C SWP-D-C Plug Number (T2): 1

**1.8 GSI (85 kW | 1.8 Litre)**

09.84 - 08.86 18 E J 2 500 001- 246-083-001-004C SWP-D-C Plug Number (T2): 1

**1.8 i (66 kW | 1.8 Litre)**

06.85 - 08.91 C 18 NT, C 18 NZ, S 18 NV J 2 500 001- 246-083-001-004C SWP-D-C Plug Number (T2): 1

**1.8 S (62 kW | 1.8 Litre)**

09.87 - 08.91 E 18 NV, S 18 NV J 2 500 001- 246-083-001-004C SWP-D-C Plug Number (T2): 1

**2.0 GSI (85 kW | 2.0 Litre)**

09.86 - 08.91 20 NE -JE100000 246-082-008-014C SWP-M-C Plug Number (T2): 1

09.86 - 08.91 20 NE J 2 500 001- 246-083-001-004C SWP-D-C Plug Number (T2): 1

**2.0 GSI (95 kW | 2.0 Litre)**

09.86 - 08.91 20 SEH -J2500000 246-082-008-014C SWP-M-C Plug Number (T2): 1

09.86 - 08.91 20 SEH J 2 500 001- 246-083-001-004C SWP-D-C Plug Number (T2): 1

**2.0 GSI 16V (110 kW | 2.0 Litre)**

03.88 - 08.91 20 XEJ J 2 500 001- 246-083-001-004C SWP-D-C Plug Number (T2): 1

**2.0 GSI 16V (115 kW | 2.0 Litre)**

12.87 - 08.91 20 XE J 2 500 001- 246-083-001-004C SWP-D-C Plug Number (T2): 1

**2.0 GSI 16V CAT (110 kW | 2.0 Litre)**

03.88 - 08.91 C 20 XE J 2 500 001- 246-083-001-004C SWP-D-C Plug Number (T2): 1

**2.0 GSI CAT (85 kW | 2.0 Litre)**

09.86 - 08.91 C 20 NE J 2 500 001- 246-083-001-004C SWP-D-C Plug Number (T2): 1



Date	Engine Code	Chassis No.	Article No.	Product	Information

**OPEL****KADETT E (39\_, 49\_)****1.2 (40 kW | 1.2 Litre)**

08.85 - 07.86	12 SC		246-082-008-014C	SWP-M-C	Plug Number (T2): 1
09.84 - 07.86	12 SC	J 2 500 001→	246-083-001-004C	SWP-D-C	Plug Number (T2): 1

**1.3 i CAT (44 kW | 1.3 Litre)**

09.85 - 08.91	C 13 N	J 2 500 001→	246-083-001-004C	SWP-D-C	Plug Number (T2): 1
---------------	--------	--------------	------------------	---------	---------------------

**1.3 N (44 kW | 1.3 Litre)**

08.85 - 12.86	13 N, 13 NB	→J5000000	246-082-008-014C	SWP-M-C	Plug Number (T2): 1
09.84 - 08.89	13 N, 13 NB	J 2 500 001→	246-083-001-004C	SWP-D-C	Plug Number (T2): 1

**1.3 S (55 kW | 1.3 Litre)**

09.86 - 08.87	13 S	→JE100000	246-082-008-014C	SWP-M-C	Plug Number (T2): 1
09.84 - 08.87	13 S	J 2 500 001→	246-083-001-004C	SWP-D-C	Plug Number (T2): 1

**1.4 i (44 kW | 1.4 Litre)**

01.90 - 08.91	C 14 NZ	J 2 500 001→	246-083-001-004C	SWP-D-C	Plug Number (T2): 1
---------------	---------	--------------	------------------	---------	---------------------

**1.4 S (55 kW | 1.4 Litre)**

01.90 - 08.91	14 NV	J 2 500 001→	246-083-001-004C	SWP-D-C	Plug Number (T2): 1
---------------	-------	--------------	------------------	---------	---------------------

**1.5 TD (53 kW | 1.5 Litre)**

07.88 - 08.91	15 DT (T4EC1)	J 2 500 001→	246-083-001-004C	SWP-D-C	Plug Number (T2): 1
---------------	---------------	--------------	------------------	---------	---------------------

**1.6 D (40 kW | 1.6 Litre)**

08.85 - 12.86	16 D, 16 DA	→J2500000	246-082-008-014C	SWP-M-C	Plug Number (T2): 1
09.84 - 01.89	16 D, 16 DA	J 2 500 001→	246-083-001-004C	SWP-D-C	Plug Number (T2): 1

**1.6 i (55 kW | 1.6 Litre)**

09.86 - 08.91	E 16 NZ	→J5000000	246-082-008-014C	SWP-M-C	Plug Number (T2): 1
09.86 - 08.91	E 16 NZ	J 2 500 001→	246-083-001-004C	SWP-D-C	Plug Number (T2): 1

**1.6 i CAT (55 kW | 1.6 Litre)**

09.86 - 08.91	C 16 LZ, C 16 NZ	J 2 500 001→	246-083-001-004C	SWP-D-C	Plug Number (T2): 1
---------------	------------------	--------------	------------------	---------	---------------------

**1.6 S (60 kW | 1.6 Litre)**

09.86 - 08.91	16 SV	→J2500000	246-082-008-014C	SWP-M-C	Plug Number (T2): 1
09.86 - 08.91	16 SV	J 2 500 001→	246-083-001-004C	SWP-D-C	Plug Number (T2): 1

**1.6 S (66 kW | 1.6 Litre)**

09.84 - 08.86	16 SH		246-082-008-014C	SWP-M-C	Plug Number (T2): 1
09.84 - 08.86	16 SH	J 2 500 001→	246-083-001-004C	SWP-D-C	Plug Number (T2): 1

**1.7 D (42 kW | 1.7 Litre)**

02.89 - 08.91	17 D	J 2 500 001→	246-083-001-004C	SWP-D-C	Plug Number (T2): 1
---------------	------	--------------	------------------	---------	---------------------

**1.8 (84 kW | 1.8 Litre)**

09.87 - 08.90	18 E	J 2 500 001→	246-083-001-004C	SWP-D-C	Plug Number (T2): 1
---------------	------	--------------	------------------	---------	---------------------

**1.8 i (66 kW | 1.8 Litre)**

09.90 - 08.91	C 18 NT, C 18 NZ	→J5000000	246-082-008-014C	SWP-M-C	Plug Number (T2): 1
09.90 - 08.91	C 18 NT, C 18 NZ	J 2 500 001→	246-083-001-004C	SWP-D-C	Plug Number (T2): 1

**1.8 i (74 kW | 1.8 Litre)**

10.85 - 08.86	C 18 NE	J 2 500 001→	246-083-001-004C	SWP-D-C	Plug Number (T2): 1
---------------	---------	--------------	------------------	---------	---------------------

**1.8 i (85 kW | 1.8 Litre)**

09.84 - 08.86	18 E	J 2 500 001→	246-083-001-004C	SWP-D-C	Plug Number (T2): 1
---------------	------	--------------	------------------	---------	---------------------

**1.8 S (62 kW | 1.8 Litre)**

09.87 - 08.91	E 18 NV	→J2500000	246-082-008-014C	SWP-M-C	Plug Number (T2): 1
09.87 - 08.91	E 18 NV	J 2 500 001→	246-083-001-004C	SWP-D-C	Plug Number (T2): 1

**2.0 i (85 kW | 2.0 Litre)**

03.87 - 08.91	20 NE	→J5000000	246-082-008-014C	SWP-M-C	Plug Number (T2): 1
03.87 - 08.91	20 NE	J 2 500 001→	246-083-001-004C	SWP-D-C	Plug Number (T2): 1

**2.0 i CAT (85 kW | 2.0 Litre)**

03.87 - 08.91	C 20 NE	J 2 500 001→	246-083-001-004C	SWP-D-C	Plug Number (T2): 1
---------------	---------	--------------	------------------	---------	---------------------

**KADETT E Estate (35\_, 36\_, 45\_, 46\_)****1.6 S (66 kW | 1.6 Litre)**

09.84 - 08.86	16 SH		246-082-008-014C	SWP-M-C	Plug Number (T2): 1
---------------	-------	--	------------------	---------	---------------------

**KADETT E Convertible (43B\_)****1.3 S (55 kW | 1.3 Litre)**

03.87 - 02.93	13 S		246-083-001-004C	SWP-D-C	Plug Number (T2): 1
---------------	------	--	------------------	---------	---------------------

**1.4 i (44 kW | 1.4 Litre)**

01.90 - 08.91	C 14 NZ		246-083-001-004C	SWP-D-C	Plug Number (T2): 1
---------------	---------	--	------------------	---------	---------------------

**1.4 S (55 kW | 1.4 Litre)**

08.90 - 02.93	14 NV		246-083-001-004C	SWP-D-C	Plug Number (T2): 1
---------------	-------	--	------------------	---------	---------------------



			<b>VDO</b>		
Date	Engine Code	Chassis No.	Article No.	Product	Information

**OPEL****KADETT E Convertible (43B\_)****1.6 i (55 kW | 1.6 Litre)**

10.86 - 02.93 E 16 NZ 246-083-001-004C SWP-D-C Plug Number (T2): 1

**1.6 i (60 kW | 1.6 Litre)**

07.89 - 02.93 16 SV 246-083-001-004C SWP-D-C Plug Number (T2): 1

**1.6 i CAT (55 kW | 1.6 Litre)**

10.87 - 02.93 C 16 LZ, C 16 NZ 246-083-001-004C SWP-D-C Plug Number (T2): 1

**2.0 i (85 kW | 2.0 Litre)**

10.86 - 02.93 20 NE -JE100000 246-082-008-014C SWP-M-C Plug Number (T2): 1

10.86 - 02.93 20 NE 246-083-001-004C SWP-D-C Plug Number (T2): 1

**2.0 i CAT (85 kW | 2.0 Litre)**

10.86 - 02.93 C 20 NE 246-083-001-004C SWP-D-C Plug Number (T2): 1

**KADETT E Box (37\_, 47\_)****1.2 (40 kW | 1.2 Litre)**

09.84 - 07.86 12 SC 246-082-008-014C SWP-M-C Plug Number (T2): 1

**1.3 N (44 kW | 1.3 Litre)**

09.84 - 12.86 13 N, 13 NB -JE100000 246-082-008-014C SWP-M-C Plug Number (T2): 1

**1.6 D (40 kW | 1.6 Litre)**

08.84 - 12.86 16 D, 16 DA -J5000000 246-082-008-014C SWP-M-C Plug Number (T2): 1

**1.6 i (55 kW | 1.6 Litre)**

08.89 - 09.93 C 16 NZ -J5000000 246-082-008-014C SWP-M-C Plug Number (T2): 1

**1.8 i (66 kW | 1.8 Litre)**

09.87 - 09.92 C 18 NT -J5000000 246-082-008-014C SWP-M-C Plug Number (T2): 1

**KADETT E Combo (38\_, 48\_)****1.6 D (40 kW | 1.6 Litre)**

01.86 - 12.89 16 DA -J2500000 246-082-008-014C SWP-M-C Plug Number (T2): 1

**1.6 i (55 kW | 1.6 Litre)**

08.91 - 07.94 C 16 NZ -J5000000 246-082-008-014C SWP-M-C Plug Number (T2): 1

**MERIVA****1.6 (64 kW | 1.6 Litre)**

05.03 - 05.10 Z 16 SE 246-083-002-014G SWP-D-C Plug Number (T2): 6

**OMEGA A (16\_, 17\_, 19\_)****1.8 (65 kW | 1.8 Litre)**

09.87 - 07.90 E 18 NVR 246-082-008-014C SWP-M-C Plug Number (T2): 1

**1.8 (85 kW | 1.8 Litre)**

10.86 - 02.94 18 SEH 246-082-008-014C SWP-M-C Plug Number (T2): 1

**1.8 N (60 kW | 1.8 Litre)**

10.86 - 08.87 18 NV 246-082-008-014C SWP-M-C Plug Number (T2): 1

**2.0 (73 kW | 2.0 Litre)**

09.90 - 02.94 C 20 NEJ 246-082-008-014C SWP-M-C Plug Number (T2): 1

**2.0 (74 kW | 2.0 Litre)**

09.90 - 02.94 C 20 NEF 246-082-008-014C SWP-M-C Plug Number (T2): 1

**2.0 (90 kW | 2.0 Litre)**

10.86 - 07.93 20 SE 246-082-008-014C SWP-M-C Plug Number (T2): 1

**2.3 D (54 kW | 2.3 Litre)**

10.86 - 02.94 23 YD 246-082-008-014C SWP-M-C Plug Number (T2): 1

**2.3 TD (66 kW | 2.3 Litre)**

10.86 - 08.88 23 YDT 246-082-008-014C SWP-M-C Plug Number (T2): 1

**2.3 TD Interc. (74 kW | 2.3 Litre)**

10.88 - 02.94 23 DTR 246-082-008-014C SWP-M-C Plug Number (T2): 1

**2.4 i (92 kW | 2.4 Litre)**

10.88 - 07.91 C 24 NE 246-082-008-014C SWP-M-C Plug Number (T2): 1

**2.6 i (110 kW | 2.6 Litre)**

09.90 - 02.94 C 26 NE 246-082-008-014C SWP-M-C Plug Number (T2): 1

**3.0 (3000) (115 kW | 3.0 Litre)**

03.87 - 12.87 C 30 LE 246-082-008-014C SWP-M-C Plug Number (T2): 1

**3.0 (3000) (130 kW | 3.0 Litre)**

03.87 - 09.90 30 NE 246-082-008-014C SWP-M-C Plug Number (T2): 1

**3.0 (3000) CAT (130 kW | 3.0 Litre)**

08.90 - 02.94 C 30 NE 246-082-008-014C SWP-M-C Plug Number (T2): 1



			<b>VDO</b>		
Date	Engine Code	Chassis No.	Article No.	Product	Information

**OPEL****OMEGA A (16\_, 17\_, 19\_)****3.0 24V (3000) (147 kW | 3.0 Litre)**

10.89 → 02.94 C 30 SEJ 246-082-008-014C SWP-M-C Plug Number (T2): 1

**3.6 24V Lotus (277 kW | 3.6 Litre)**

08.90 → 09.92 C 36 GET 246-082-008-014C SWP-M-C Plug Number (T2): 1

**OMEGA A Estate (66\_, 67\_)****1.8 (65 kW | 1.8 Litre)**

09.87 → 07.90 E 18 NVR 246-082-008-014C SWP-M-C Plug Number (T2): 1

**1.8 (85 kW | 1.8 Litre)**

10.86 → 02.94 18 SEH 246-082-008-014C SWP-M-C Plug Number (T2): 1

**1.8 N (60 kW | 1.8 Litre)**

10.86 → 08.87 18 NV 246-082-008-014C SWP-M-C Plug Number (T2): 1

**2.0 (74 kW | 2.0 Litre)**

09.90 → 02.94 C 20 NEF 246-082-008-014C SWP-M-C Plug Number (T2): 1

**2.0 (90 kW | 2.0 Litre)**

10.86 → 07.93 20 SE 246-082-008-014C SWP-M-C Plug Number (T2): 1

**2.0 i (85 kW | 2.0 Litre)**

10.86 → 02.94 C 20 NE 246-082-008-014C SWP-M-C Plug Number (T2): 1

**2.3 D (54 kW | 2.3 Litre)**

10.86 → 02.94 23 YD 246-082-008-014C SWP-M-C Plug Number (T2): 1

**2.3 TD (66 kW | 2.3 Litre)**

10.86 → 08.88 23 YDT 246-082-008-014C SWP-M-C Plug Number (T2): 1

**2.3 TD Interc. (74 kW | 2.3 Litre)**

10.88 → 02.94 23 DTR 246-082-008-014C SWP-M-C Plug Number (T2): 1

**2.4 i (92 kW | 2.4 Litre)**

10.88 → 07.91 C 24 NE 246-082-008-014C SWP-M-C Plug Number (T2): 1

**2.6 i (110 kW | 2.6 Litre)**

09.90 → 02.94 C 26 NE 246-082-008-014C SWP-M-C Plug Number (T2): 1

**3.0 24V (147 kW | 3.0 Litre)**

10.89 → 02.94 C 30 SEJ 246-082-008-014C SWP-M-C Plug Number (T2): 1

**3.0 CAT (130 kW | 3.0 Litre)**

03.87 → 02.94 C 30 NE 246-082-008-014C SWP-M-C Plug Number (T2): 1

**OMEGA B (25\_, 26\_, 27\_)****2.0 (85 kW | 2.0 Litre)**03.94 → 12.00 20 SE Y-1-000-001→  
→2-1-022-530 246-082-008-021G SWP-M-C Plug Number (T2): 603.94 → 09.99 X 20 SE Y-1-000-001→  
→2-1-022-530 246-082-008-021G SWP-M-C Plug Number (T2): 6**2.0 16V (100 kW | 2.0 Litre)**03.94 → 09.99 X 20 XEV Y-1-000-001→  
→2-1-022-530 246-082-008-021G SWP-M-C Plug Number (T2): 6**2.0 DTI 16V (74 kW | 2.0 Litre)**09.97 → 09.00 X 20 DTH Y-1-000-001→  
→2-1-022-530 246-082-008-021G SWP-M-C Plug Number (T2): 6**2.2 16V (106 kW | 2.2 Litre)**09.99 → 07.03 Y 22 XE, Z 22 XE Y-1-000-001→  
→2-1-022-530 246-082-008-021G SWP-M-C Plug Number (T2): 6**2.2 DTI 16V (88 kW | 2.2 Litre)**09.00 → 07.03 Y 22 DTH Y-1-000-001→  
→2-1-022-530 246-082-008-021G SWP-M-C Plug Number (T2): 6**2.5 DTI (110 kW | 2.5 Litre)**09.01 → 07.03 Y 25 DT Y-1-000-001→  
→2-1-022-530 246-082-008-021G SWP-M-C Plug Number (T2): 6**2.5 TD (96 kW | 2.5 Litre)**04.94 → 07.03 25 DT, X 25 DT, X 25 TD Y-1-000-001→  
→2-1-022-530 246-082-008-021G SWP-M-C Plug Number (T2): 6**2.5 V6 (125 kW | 2.5 Litre)**03.94 → 09.00 X 25 XE Y-1-000-001→  
→2-1-022-530 246-082-008-021G SWP-M-C Plug Number (T2): 6**2.6 V6 (132 kW | 2.6 Litre)**09.00 → 07.03 Y 26 SE Y-1-000-001→  
→2-1-022-530 246-082-008-021G SWP-M-C Plug Number (T2): 6



			<b>VDO</b>		
Date	Engine Code	Chassis No.	Article No.	Product	Information

**OPEL****OMEGA B (25\_, 26\_, 27\_)****3.0 V6 (155 kW | 3.0 Litre)**

04.94 - 02.01	X 30 XE	Y-1-000-001- -2-1-022-530	246-082-008-021G	SWP-M-C	Plug Number (T2): 6
---------------	---------	------------------------------	------------------	---------	---------------------

**3.2 V6 (160 kW | 3.2 Litre)**

02.01 - 07.03	Y 32 SE	Y-1-000-001- -2-1-022-530	246-082-008-021G	SWP-M-C	Plug Number (T2): 6
---------------	---------	------------------------------	------------------	---------	---------------------

**OMEGA B Estate (21\_, 22\_, 23\_)****2.0 (85 kW | 2.0 Litre)**

03.94 - 09.99	X 20 SE		246-083-001-004C	SWP-D-C	Plug Number (T2): 1
03.94 - 09.99	X 20 SE	Y-1-000-001- -2-1-022-530	246-083-002-014G	SWP-D-C	Plug Number (T2): 6

**2.0 16V (100 kW | 2.0 Litre)**

03.94 - 09.99	X 20 XEV		246-083-001-004C	SWP-D-C	Plug Number (T2): 1
03.94 - 09.99	X 20 XEV	Y-1-000-001- -2-1-022-530	246-083-002-014G	SWP-D-C	Plug Number (T2): 6

**2.0 DTI 16V (74 kW | 2.0 Litre)**

09.97 - 09.00	X 20 DTH		246-083-001-004C	SWP-D-C	Plug Number (T2): 1
09.97 - 09.00	X 20 DTH	Y-1-000-001- -2-1-022-530	246-083-002-014G	SWP-D-C	Plug Number (T2): 6

**2.2 16V (106 kW | 2.2 Litre)**

09.99 - 07.03	Y 22 XE, Z 22 XE		246-083-001-004C	SWP-D-C	Plug Number (T2): 1
09.99 - 07.03	Y 22 XE, Z 22 XE	Y-1-000-001- -2-1-022-530	246-083-002-014G	SWP-D-C	Plug Number (T2): 6

**2.2 DTI 16V (88 kW | 2.2 Litre)**

09.00 - 07.03	Y 22 DTH		246-083-001-004C	SWP-D-C	Plug Number (T2): 1
09.00 - 07.03	Y 22 DTH	Y-1-000-001- -2-1-022-530	246-083-002-014G	SWP-D-C	Plug Number (T2): 6

**2.5 DTI (110 kW | 2.5 Litre)**

09.01 - 07.03	Y 25 DT		246-083-001-004C	SWP-D-C	Plug Number (T2): 1
09.01 - 07.03	Y 25 DT	Y-1-000-001- -2-1-022-530	246-083-002-014G	SWP-D-C	Plug Number (T2): 6

**2.5 TD (96 kW | 2.5 Litre)**

04.94 - 02.01	25 DT, X 25 DT, X 25 TD		246-083-001-004C	SWP-D-C	Plug Number (T2): 1
04.94 - 02.01	25 DT, X 25 DT, X 25 TD	Y-1-000-001- -2-1-022-530	246-083-002-014G	SWP-D-C	Plug Number (T2): 6

**2.5 V6 (125 kW | 2.5 Litre)**

03.94 - 09.00	X 25 XE		246-083-001-004C	SWP-D-C	Plug Number (T2): 1
03.94 - 09.00	X 25 XE	Y-1-000-001- -2-1-022-530	246-083-002-014G	SWP-D-C	Plug Number (T2): 6

**2.6 V6 (132 kW | 2.6 Litre)**

09.00 - 07.03	Y 26 SE		246-083-001-004C	SWP-D-C	Plug Number (T2): 1
09.00 - 07.03	Y 26 SE	Y-1-000-001- -2-1-022-530	246-083-002-014G	SWP-D-C	Plug Number (T2): 6

**3.0 V6 (155 kW | 3.0 Litre)**

04.94 - 02.01	X 30 XE		246-083-001-004C	SWP-D-C	Plug Number (T2): 1
04.94 - 02.01	X 30 XE	Y-1-000-001- -2-1-022-530	246-083-002-014G	SWP-D-C	Plug Number (T2): 6

**3.2 V6 (160 kW | 3.2 Litre)**

02.01 - 07.03	Y 32 SE		246-083-001-004C	SWP-D-C	Plug Number (T2): 1
02.01 - 07.03	Y 32 SE	Y-1-000-001- -2-1-022-530	246-083-002-014G	SWP-D-C	Plug Number (T2): 6

**SENATOR B (29\_)****2.6 i (110 kW | 2.6 Litre)**

09.90 - 06.93	C 26 NE		246-082-008-014C	SWP-M-C	Plug Number (T2): 1
---------------	---------	--	------------------	---------	---------------------

**3.0 (115 kW | 3.0 Litre)**

09.87 - 06.93	C 30 LE		246-082-008-014C	SWP-M-C	Plug Number (T2): 1
---------------	---------	--	------------------	---------	---------------------

**3.0 (130 kW | 3.0 Litre)**

01.88 - 09.90	30 NE		246-082-008-014C	SWP-M-C	Plug Number (T2): 1
---------------	-------	--	------------------	---------	---------------------

**3.0 24V (150 kW | 3.0 Litre)**

10.89 - 06.93	C 30 SE		246-082-008-014C	SWP-M-C	Plug Number (T2): 1
---------------	---------	--	------------------	---------	---------------------



			<b>VDO</b>		
Date	Engine Code	Chassis No.	Article No.	Product	Information

**OPEL****TIGRA (95\_)****1.4 16V (63 kW | 1.4 Litre)**

08.97 - 12.00 X 14 XE

246-083-001-004C

SWP-D-C

Plug Number (T2): 1

**1.4 16V (66 kW | 1.4 Litre)**

07.94 - 12.00 X 14 XE

246-082-008-021G

SWP-M-C

Plug Number (T2): 6

07.94 - 12.00 X 14 XE

246-083-001-004C

SWP-D-C

Plug Number (T2): 1

07.95 - 12.00 X 14 XE

246-083-002-014G

SWP-D-C

Plug Number (T2): 6; Vehicle Equipment (T31):  
for vehicles with air conditioning (T32)**1.6 16V (74 kW | 1.6 Litre)**

08.97 - 08.98 C 16 SEL

246-083-001-004C

SWP-D-C

Plug Number (T2): 1

**1.6 16V (78 kW | 1.6 Litre)**

07.94 - 08.98 X 16 XE

246-082-008-021G

SWP-M-C

Plug Number (T2): 6

07.94 - 08.98 X 16 XE

246-083-001-004C

SWP-D-C

Plug Number (T2): 1

07.95 - 08.98 X 16 XE

246-083-002-014G

SWP-D-C

Plug Number (T2): 6; Vehicle Equipment (T31):  
for vehicles with air conditioning (T32)**VECTRA A Hatchback (88\_, 89\_)****1.4 S (55 kW | 1.4 Litre)**

04.88 - 06.92 14 NV

246-083-001-004C

SWP-D-C

Plug Number (T2): 1

**1.6 i (52 kW | 1.6 Litre)**

09.93 - 11.95 X 16 SZ

246-083-001-004C

SWP-D-C

Plug Number (T2): 1

**1.6 i (55 kW | 1.6 Litre)**

09.93 - 11.95 16 LZ2

246-083-001-004C

SWP-D-C

Plug Number (T2): 1

**1.6 i CAT (55 kW | 1.6 Litre)**

09.88 - 11.95 C 16 NZ, C 16 NZ2

246-083-001-004C

SWP-D-C

Plug Number (T2): 1

**1.6 S (60 kW | 1.6 Litre)**

09.88 - 05.93 16 SV

246-083-001-004C

SWP-D-C

Plug Number (T2): 1

**1.7 D (42 kW | 1.7 Litre)**

09.88 - 09.92 17 D

246-083-001-004C

SWP-D-C

Plug Number (T2): 1

**1.7 D (44 kW | 1.7 Litre)**

07.92 - 11.95 17 DR

246-083-001-004C

SWP-D-C

Plug Number (T2): 1

**1.7 TD (60 kW | 1.7 Litre)**

03.90 - 11.95 17 DT (TC4EE1), X 17 DT (TC4EE1)

246-083-001-004C

SWP-D-C

Plug Number (T2): 1

**1.8 i (66 kW | 1.8 Litre)**

09.88 - 10.90 18 SV

246-083-001-004C

SWP-D-C

Plug Number (T2): 1

**1.8 i CAT (66 kW | 1.8 Litre)**

03.90 - 11.95 C 18 NZ

246-083-001-004C

SWP-D-C

Plug Number (T2): 1

**1.8 S (65 kW | 1.8 Litre)**

09.88 - 07.89 E 18 NVR

246-083-001-004C

SWP-D-C

Plug Number (T2): 1

**2.0 (74 kW | 2.0 Litre)**

04.88 - 09.89 C 20 NEF

246-083-001-004C

SWP-D-C

Plug Number (T2): 1

**2.0 i (85 kW | 2.0 Litre)**

09.88 - 10.90 20 NE

246-083-001-004C

SWP-D-C

Plug Number (T2): 1

**2.0 i 16V (100 kW | 2.0 Litre)**

06.94 - 11.95 X 20 XEV

246-083-001-004C

SWP-D-C

Plug Number (T2): 1

**2.0 i 16V (110 kW | 2.0 Litre)**

02.89 - 10.90 20 XEJ

246-083-001-004C

SWP-D-C

Plug Number (T2): 1

**2.0 i 16V CAT (110 kW | 2.0 Litre)**

02.90 - 11.95 C 20 XE

246-083-001-004C

SWP-D-C

Plug Number (T2): 1

**2.0 i CAT (85 kW | 2.0 Litre)**

09.88 - 11.95 C 20 NE

246-083-001-004C

SWP-D-C

Plug Number (T2): 1

**2.0 i GT (95 kW | 2.0 Litre)**

09.88 - 11.95 20 SEH

246-083-001-004C

SWP-D-C

Plug Number (T2): 1

**2.5 V6 (125 kW | 2.5 Litre)**

02.93 - 11.95 C 25 XE

246-083-001-004C

SWP-D-C

Plug Number (T2): 1

**VECTRA A (86\_, 87\_)****1.4 S (55 kW | 1.4 Litre)**

09.88 - 06.92 14 NV

246-082-008-014C

SWP-M-C

Plug Number (T2): 1

**1.6 i (52 kW | 1.6 Litre)**

09.93 - 09.95 X 16 SZ

246-082-008-014C

SWP-M-C

Plug Number (T2): 1

**1.6 i (55 kW | 1.6 Litre)**

09.88 - 07.92 E 16 NZ, C 16 NZ, C 16 NZ2

246-082-008-014C

SWP-M-C

Plug Number (T2): 1



			<b>VDO</b>		
Date	Engine Code	Chassis No.	Article No.	Product	Information

**OPEL****VECTRA A (86\_, 87\_)****1.6 i CAT (55 kW | 1.6 Litre)**

09.88 - 09.95 | C 16 NZ, C 16 NZ2 | 246-082-008-014C | SWP-M-C | Plug Number (T2): 1

**1.7 D (42 kW | 1.7 Litre)**

10.88 - 06.92 | 17 D | 246-082-008-014C | SWP-M-C | Plug Number (T2): 1

**1.7 D (44 kW | 1.7 Litre)**

07.92 - 09.95 | 17 DR | 246-082-008-014C | SWP-M-C | Plug Number (T2): 1

**1.7 TD (60 kW | 1.7 Litre)**

07.91 - 09.95 | 17 DT (TC4EE1), X 17 DT (TC4EE1) | 246-082-008-014C | SWP-M-C | Plug Number (T2): 1

**1.8 i CAT (66 kW | 1.8 Litre)**

03.90 - 09.95 | C 18 NZ | 246-082-008-014C | SWP-M-C | Plug Number (T2): 1

**1.8 S 4x4 (65 kW | 1.8 Litre)**

01.89 - 07.89 | E 18 NVR | 246-082-008-014C | SWP-M-C | Plug Number (T2): 1

**2.0 i (95 kW | 2.0 Litre)**

09.88 - 07.92 | 20 SEH | 246-082-008-014C | SWP-M-C | Plug Number (T2): 1

**2.0 i 16V (100 kW | 2.0 Litre)**

06.94 - 09.95 | X 20 XEV | 246-082-008-014C | SWP-M-C | Plug Number (T2): 1

**2.0 i 4x4 (85 kW | 2.0 Litre)**

01.89 - 10.90 | 20 NE | 246-082-008-014C | SWP-M-C | Plug Number (T2): 1

**2.0 i 4x4 (95 kW | 2.0 Litre)**

01.89 - 07.92 | 20 SEH | 246-082-008-014C | SWP-M-C | Plug Number (T2): 1

**2.0 i 4x4 CAT (85 kW | 2.0 Litre)**

07.92 - 09.95 | C 20 NE | 246-082-008-014C | SWP-M-C | Plug Number (T2): 1

**2.0 i CAT (85 kW | 2.0 Litre)**

07.92 - 09.95 | C 20 NE | 246-082-008-014C | SWP-M-C | Plug Number (T2): 1

**2.0 i Turbo 4x4 (150 kW | 2.0 Litre)**

06.94 - 09.95 | C 20 LET | 246-082-008-014C | SWP-M-C | Plug Number (T2): 1

**2.5 V6 (125 kW | 2.5 Litre)**

05.93 - 09.95 | C 25 XE | 246-082-008-014C | SWP-M-C | Plug Number (T2): 1

**2000 16V 4x4 (110 kW | 2.0 Litre)**

01.89 - 10.90 | 20 XEJ | 246-082-008-014C | SWP-M-C | Plug Number (T2): 1

**2000/GT 16V (110 kW | 2.0 Litre)**

03.90 - 06.94 | 20 XEJ | 246-082-008-014C | SWP-M-C | Plug Number (T2): 1

**VECTRA B Hatchback (38\_)****1.6 i (55 kW | 1.6 Litre)**

10.95 - 01.99 | X 16 SZR | 246-083-002-014G | SWP-D-C | Plug Number (T2): 6

**1.6 i 16V (74 kW | 1.6 Litre)**

10.95 - 01.99 | X 16 XEL, Z 16 XE, Y 16 XE | 246-083-002-014G | SWP-D-C | Plug Number (T2): 6

**1.7 TD (60 kW | 1.7 Litre)**

10.95 - 12.98 | X 17 DT (TC4EE1) | 246-083-002-014G | SWP-D-C | Plug Number (T2): 6

**1.8 i 16V (85 kW | 1.8 Litre)**

10.95 - 01.99 | X 18 XE1 | 246-083-002-014G | SWP-D-C | Plug Number (T2): 6

**2.0 DI 16V (60 kW | 2.0 Litre)**

11.96 - 01.99 | X 20 DTL | 246-083-002-014G | SWP-D-C | Plug Number (T2): 6

**2.0 DTI 16V (74 kW | 2.0 Litre)**

09.97 - 01.99 | X 20 DTH, Y 20 DTH | 246-083-002-014G | SWP-D-C | Plug Number (T2): 6

**2.0 i 16V (100 kW | 2.0 Litre)**

10.95 - 01.99 | X 20 XEV, C 20 SEL | 246-083-002-014G | SWP-D-C | Plug Number (T2): 6

**2.5 i V6 (125 kW | 2.5 Litre)**

10.95 - 01.99 | X 25 XE | 246-083-002-014G | SWP-D-C | Plug Number (T2): 6

**VECTRA B (36\_)****1.6 i (55 kW | 1.6 Litre)**

10.95 - 01.99 | X 16 SZR | 246-082-008-021G | SWP-M-C | Plug Number (T2): 6

**1.6 i 16V (74 kW | 1.6 Litre)**

10.95 - 01.99 | X 16 XEL, Y 16 XE, Z 16 XE | 246-082-008-021G | SWP-M-C | Plug Number (T2): 6

**1.7 TD (60 kW | 1.7 Litre)**

10.95 - 12.98 | X 17 DT (TC4EE1) | 246-082-008-021G | SWP-M-C | Plug Number (T2): 6

**1.8 i 16V (85 kW | 1.8 Litre)**

10.95 - 01.99 | X 18 XE1 | 246-082-008-021G | SWP-M-C | Plug Number (T2): 6

**2.0 DI 16V (60 kW | 2.0 Litre)**

11.96 - 01.99 | X 20 DTL | 246-082-008-021G | SWP-M-C | Plug Number (T2): 6





			<b>VDO</b>		
Date	Engine Code	Chassis No.	Article No.	Product	Information

**OPEL****VECTRA B (36\_)****2.0 DTI 16V (74 kW | 2.0 Litre)**

09.97 - 01.99 X 20 DTH, Y 20 DTH

246-082-008-021G

SWP-M-C

Plug Number (T2): 6

**2.0 i 16V (100 kW | 2.0 Litre)**

10.95 - 01.99 X 20 XEV, C 20 SEL

246-082-008-021G

SWP-M-C

Plug Number (T2): 6

**i 500 2.5 (143 kW | 2.5 Litre)**

05.98 - 01.99 X 25 XE

246-082-008-021G

SWP-M-C

Plug Number (T2): 6

**VECTRA B Estate (31\_)****1.6 i (55 kW | 1.6 Litre)**

11.96 - 01.99 X 16 SZR

246-083-002-014G

SWP-D-C

Plug Number (T2): 6

**1.8 i 16V (85 kW | 1.8 Litre)**

11.96 - 01.99 X 18 XE1

246-083-002-014G

SWP-D-C

Plug Number (T2): 6

**2.0 DI 16V (60 kW | 2.0 Litre)**

11.96 - 01.99 X 20 DTL

246-083-002-014G

SWP-D-C

Plug Number (T2): 6

**2.0 DTI 16V (74 kW | 2.0 Litre)**

09.97 - 01.99 X 20 DTH, Y 20 DTH

246-083-002-014G

SWP-D-C

Plug Number (T2): 6

**2.0 i 16V (100 kW | 2.0 Litre)**

11.96 - 01.99 X 20 XEV, C 20 SEL

246-083-002-014G

SWP-D-C

Plug Number (T2): 6

**i 500 2.5 (143 kW | 2.5 Litre)**

05.98 - 01.99 X 25 XE

246-083-002-014G

SWP-D-C

Plug Number (T2): 6

**VECTRA C GTS****1.8 16V (90 kW | 1.8 Litre)**

08.02 - Z 18 XE

246-082-008-021G

SWP-M-C

Plug Number (T2): 6

08.02 - Z 18 XE

246-083-002-014G

SWP-D-C

Plug Number (T2): 6; T27: 5

**2.0 DTI 16V (74 kW | 2.0 Litre)**

08.02 - Y 20 DTH

246-082-008-021G

SWP-M-C

Plug Number (T2): 6

08.02 - Y 20 DTH

246-083-002-014G

SWP-D-C

Plug Number (T2): 6; T27: 5

**2.2 16V (108 kW | 2.2 Litre)**

08.02 - Z 22 SE

246-082-008-021G

SWP-M-C

Plug Number (T2): 6

08.02 - Z 22 SE

246-083-002-014G

SWP-D-C

Plug Number (T2): 6; T27: 5

**2.2 DTI 16V (92 kW | 2.2 Litre)**

08.02 - Y 22 DTR

246-082-008-021G

SWP-M-C

Plug Number (T2): 6

08.02 - Y 22 DTR

246-083-002-014G

SWP-D-C

Plug Number (T2): 6; T27: 5

**3.2 V6 (155 kW | 3.2 Litre)**

08.02 - Z 32 SE

246-082-008-021G

SWP-M-C

Plug Number (T2): 6

08.02 - Z 32 SE

246-083-002-014G

SWP-D-C

Plug Number (T2): 6; T27: 5

**VECTRA C****1.8 16V (90 kW | 1.8 Litre)**

04.02 - Z 18 XE

246-082-008-021G

SWP-M-C

Plug Number (T2): 6

04.02 - Z 18 XE

246-083-002-014G

SWP-D-C

Plug Number (T2): 6; T27: 5

**2.0 DTI 16V (74 kW | 2.0 Litre)**

04.02 - Y 20 DTH

246-082-008-021G

SWP-M-C

Plug Number (T2): 6

04.02 - Y 20 DTH

246-083-002-014G

SWP-D-C

Plug Number (T2): 6; T27: 5

**2.2 16V (108 kW | 2.2 Litre)**

04.02 - Z 22 SE

246-082-008-021G

SWP-M-C

Plug Number (T2): 6

04.02 - Z 22 SE

246-083-002-014G

SWP-D-C

Plug Number (T2): 6; T27: 5

**2.2 DTI 16V (92 kW | 2.2 Litre)**

04.02 - Y 22 DTR

246-082-008-021G

SWP-M-C

Plug Number (T2): 6

04.02 - Y 22 DTR

246-083-002-014G

SWP-D-C

Plug Number (T2): 6; T27: 5

**ZAFIRA A (F75\_)****1.6 16V (74 kW | 1.6 Litre)**

04.99 - 06.05 X 16 XEL, Z 16 XE

246-082-008-021G

SWP-M-C

Plug Number (T2): 6

04.99 - 06.05 X 16 XEL, Z 16 XE

246-083-002-014G

SWP-D-C

Plug Number (T2): 6

**1.6 CNG (71 kW | 1.6 Litre)**

09.01 - 06.05 Z 16 YNG

246-083-002-014G

SWP-D-C

Plug Number (T2): 6

**1.8 16V (85 kW | 1.8 Litre)**

08.00 - 09.00 X 18 XE1

246-082-008-021G

SWP-M-C

Plug Number (T2): 6

04.99 - 09.00 X 18 XE1

246-083-002-014G

SWP-D-C

Plug Number (T2): 6

**1.8 16V (92 kW | 1.8 Litre)**

09.00 - 06.05 Z 18 XE

246-083-002-014G

SWP-D-C

Plug Number (T2): 6



			<b>VDO</b>		
Date	Engine Code	Chassis No.	Article No.	Product	Information

**OPEL****ZAFIRA A (F75\_)****2.0 DI 16V (60 kW | 2.0 Litre)**

10.99 - 06.05	X 20 DTL		246-082-008-021G	SWP-M-C	Plug Number (T2): 6
10.99 - 06.05	X 20 DTL		246-083-002-014G	SWP-D-C	Plug Number (T2): 6

**2.0 DTI 16V (74 kW | 2.0 Litre)**

09.00 - 06.05	Y 20 DTH		246-083-002-014G	SWP-D-C	Plug Number (T2): 6
---------------	----------	--	------------------	---------	---------------------

**2.0 OPC (141 kW | 2.0 Litre)**

09.01 - 06.05	Z 20 LET		246-083-002-014G	SWP-D-C	Plug Number (T2): 6
---------------	----------	--	------------------	---------	---------------------

**2.2 16V (108 kW | 2.2 Litre)**

09.00 - 06.05	Z 22 SE		246-083-002-014G	SWP-D-C	Plug Number (T2): 6
---------------	---------	--	------------------	---------	---------------------

**PEUGEOT****106 I (1A, 1C)****1.0 (33 kW | 1.0 Litre)**

09.91 - 04.96	TU9, CDY (TU9M)		X10-729-002-007	SWP-M-C	Plug Number (T2): 11
---------------	-----------------	--	-----------------	---------	----------------------

**1.0 (37 kW | 1.0 Litre)**

09.91 - 04.96	CDZ (TU9M)		X10-729-002-007	SWP-M-C	Plug Number (T2): 11
---------------	------------	--	-----------------	---------	----------------------

**1.1 (44 kW | 1.1 Litre)**

09.91 - 04.96	HDZ (TU1M)		X10-729-002-007	SWP-M-C	Plug Number (T2): 11
---------------	------------	--	-----------------	---------	----------------------

**1.3 (72 kW | 1.3 Litre)**

10.93 - 04.96	TU2J2		X10-729-002-007	SWP-M-C	Plug Number (T2): 11
---------------	-------	--	-----------------	---------	----------------------

**1.4 (55 kW | 1.4 Litre)**

09.91 - 04.96	KDY (TU3M), KDX (TU3MC)		X10-729-002-007	SWP-M-C	Plug Number (T2): 11
---------------	-------------------------	--	-----------------	---------	----------------------

**1.4 (69 kW | 1.4 Litre)**

09.91 - 04.96	KFZ (TU3J2/Z)		X10-729-002-007	SWP-M-C	Plug Number (T2): 11
---------------	---------------	--	-----------------	---------	----------------------

**1.4 D (37 kW | 1.4 Litre)**

09.92 - 04.96	K9Y (TUD3Y)		X10-729-002-007	SWP-M-C	Plug Number (T2): 11
---------------	-------------	--	-----------------	---------	----------------------

**1.5 D (40 kW | 1.5 Litre)**

06.94 - 04.96	VJY (TUD5)		X10-729-002-007	SWP-M-C	Plug Number (T2): 11
---------------	------------	--	-----------------	---------	----------------------

**1.5 D (43 kW | 1.5 Litre)**

06.94 - 04.96			X10-729-002-007	SWP-M-C	Plug Number (T2): 11
---------------	--	--	-----------------	---------	----------------------

**1.6 (65 kW | 1.6 Litre)**

06.93 - 04.96	NFZ (TU5JP)		X10-729-002-007	SWP-M-C	Plug Number (T2): 11
---------------	-------------	--	-----------------	---------	----------------------

**1.6 (76 kW | 1.6 Litre)**

01.94 - 04.96	NFY (TU5J2)		X10-729-002-007	SWP-M-C	Plug Number (T2): 11
---------------	-------------	--	-----------------	---------	----------------------

**206 CC (2D)****1.6 16V (80 kW | 1.6 Litre)**

09.00 -	NFU (TU5JP4)		X10-729-002-007	SWP-M-C	Plug Number (T2): 11
---------	--------------	--	-----------------	---------	----------------------

**2.0 S16 (100 kW | 2.0 Litre)**

09.00 -	RFN (EW10J4)		X10-729-002-007	SWP-M-C	Plug Number (T2): 11
---------	--------------	--	-----------------	---------	----------------------

**306 Hatchback (7A, 7C, N3, N5)****1.1 (44 kW | 1.1 Litre)**

04.97 - 05.01	HDZ (TU1M)		X10-729-002-007	SWP-M-C	Plug Number (T2): 11; T24: XN →
---------------	------------	--	-----------------	---------	---------------------------------

**1.4 (55 kW | 1.4 Litre)**

04.97 - 05.01	KDX (TU3MC), KFX (TU3JP), KFW (TU3JP)		X10-729-002-007	SWP-M-C	Plug Number (T2): 11; T24: XN →
---------------	------------------------------------------	--	-----------------	---------	---------------------------------

**1.6 (65 kW | 1.6 Litre)**

04.97 - 10.00	NFZ (TU5JP)		X10-729-002-007	SWP-M-C	Plug Number (T2): 11; T24: XN →
---------------	-------------	--	-----------------	---------	---------------------------------

**1.6 (72 kW | 1.6 Litre)**

10.00 - 05.01	NFT		X10-729-002-007	SWP-M-C	Plug Number (T2): 11; T24: XN →
---------------	-----	--	-----------------	---------	---------------------------------

**1.8 (74 kW | 1.8 Litre)**

04.97 - 05.01	LFZ (XU7JP)		X10-729-002-007	SWP-M-C	Plug Number (T2): 11; T24: XN →
---------------	-------------	--	-----------------	---------	---------------------------------

**1.8 16V (81 kW | 1.8 Litre)**

04.97 - 05.01	LFY (XU7JP4)		X10-729-002-007	SWP-M-C	Plug Number (T2): 11; T24: XN →
---------------	--------------	--	-----------------	---------	---------------------------------

**1.8 D (43 kW | 1.8 Litre)**

04.97 - 05.01	A9A (XUD7)		X10-729-002-007	SWP-M-C	Plug Number (T2): 11; T24: XN →
---------------	------------	--	-----------------	---------	---------------------------------

**1.9 D (47 kW | 1.9 Litre)**

04.97 - 05.01	DJZ (XUD9Y)		X10-729-002-007	SWP-M-C	Plug Number (T2): 11; T24: XN →
---------------	-------------	--	-----------------	---------	---------------------------------



			<b>VDO</b>		
Date	Engine Code	Chassis No.	Article No.	Product	Information

**PEUGEOT****306 Hatchback (7A, 7C, N3, N5)****1.9 D (50 kW | 1.9 Litre)**

04.97 - 05.01 | DJY (XUD9A) | X10-729-002-007 | SWP-M-C | Plug Number (T2): 11; T24: XN →

**1.9 D (51 kW | 1.9 Litre)**

09.98 - 05.01 | WJZ (DW8), WJY (DW8B) | X10-729-002-007 | SWP-M-C | Plug Number (T2): 11; T24: XN →

**1.9 D (55 kW | 1.9 Litre)**

03.98 - 05.01 | DHV (XUD9BSD) | X10-729-002-007 | SWP-M-C | Plug Number (T2): 11; T24: XN →

**1.9 DT (66 kW | 1.9 Litre)**

04.97 - 05.01 | DHY (XUD9TE) | X10-729-002-007 | SWP-M-C | Plug Number (T2): 11; T24: XN →

**2.0 16V (97 kW | 2.0 Litre)**

04.97 - 05.01 | RFV (XU10J4R) | X10-729-002-007 | SWP-M-C | Plug Number (T2): 11; T24: XN →

**2.0 HDI 90 (66 kW | 2.0 Litre)**

06.99 - 05.01 | RHY (DW10TD) | X10-729-002-007 | SWP-M-C | Plug Number (T2): 11; T24: XN →

**2.0 S16 (110 kW | 2.0 Litre)**

04.97 - 05.01 | RFT (XU10J4) | X10-729-002-007 | SWP-M-C | Plug Number (T2): 11; T24: XN →

**2.0 S16 (112 kW | 2.0 Litre)**

04.97 - 05.01 | RFY (XU10J4Z) | X10-729-002-007 | SWP-M-C | Plug Number (T2): 11; T24: XN →

**2.0 S16 (120 kW | 2.0 Litre)**

04.97 - 05.01 | RFS (XU10J4RS) | X10-729-002-007 | SWP-M-C | Plug Number (T2): 11; T24: XN →

**2.0 XSi (89 kW | 2.0 Litre)**

04.97 - 05.01 | RFX (XU10J2) | X10-729-002-007 | SWP-M-C | Plug Number (T2): 11; T24: XN →

**306 (7B, N3, N5)****1.1 (44 kW | 1.1 Litre)**

04.97 - 05.01 | HDZ (TU1M) | X10-729-002-007 | SWP-M-C | Plug Number (T2): 11; T24: XN →

**1.4 SL (55 kW | 1.4 Litre)**04.97 - 05.01 | KDX (TU3MC), KFX (TU3JP),  
KFW (TU3JP) | X10-729-002-007 | SWP-M-C | Plug Number (T2): 11; T24: XN →**1.6 (72 kW | 1.6 Litre)**

10.00 - 05.01 | NFT | X10-729-002-007 | SWP-M-C | Plug Number (T2): 11; T24: XN →

**1.6 SR (65 kW | 1.6 Litre)**

04.97 - 10.00 | NFZ (TU5JP) | X10-729-002-007 | SWP-M-C | Plug Number (T2): 11; T24: XN →

**1.8 16V (81 kW | 1.8 Litre)**

04.97 - 05.01 | LFY (XU7JP4) | X10-729-002-007 | SWP-M-C | Plug Number (T2): 11; T24: XN →

**1.8 ST (74 kW | 1.8 Litre)**

04.97 - 05.01 | LFZ (XU7JP) | X10-729-002-007 | SWP-M-C | Plug Number (T2): 11; T24: XN →

**1.9 D (51 kW | 1.9 Litre)**

09.98 - 05.01 | WJZ (DW8), WJY (DW8B) | X10-729-002-007 | SWP-M-C | Plug Number (T2): 11; T24: XN →

**1.9 D (55 kW | 1.9 Litre)**

03.98 - 05.01 | DHV (XUD9BSD) | X10-729-002-007 | SWP-M-C | Plug Number (T2): 11; T24: XN →

**1.9 SLD (47 kW | 1.9 Litre)**

04.97 - 05.01 | DJZ (XUD9Y) | X10-729-002-007 | SWP-M-C | Plug Number (T2): 11; T24: XN →

**1.9 SLD (50 kW | 1.9 Litre)**

04.97 - 05.01 | DJY (XUD9A) | X10-729-002-007 | SWP-M-C | Plug Number (T2): 11; T24: XN →

**1.9 SRDT (66 kW | 1.9 Litre)**

04.97 - 05.01 | DHY (XUD9TE) | X10-729-002-007 | SWP-M-C | Plug Number (T2): 11; T24: XN →

**2.0 (97 kW | 2.0 Litre)**

04.97 - 05.01 | RFV (XU10J4R) | X10-729-002-007 | SWP-M-C | Plug Number (T2): 11; T24: XN →

**2.0 HDI 90 (66 kW | 2.0 Litre)**

06.99 - 05.01 | RHY (DW10TD) | X10-729-002-007 | SWP-M-C | Plug Number (T2): 11; T24: XN →

**2.0 S16 (110 kW | 2.0 Litre)**

04.97 - 05.01 | RFT (XU10J4) | X10-729-002-007 | SWP-M-C | Plug Number (T2): 11; T24: XN →

**2.0 S16 (112 kW | 2.0 Litre)**

04.97 - 05.01 | RFY (XU10J4Z) | X10-729-002-007 | SWP-M-C | Plug Number (T2): 11; T24: XN →

**2.0 ST (89 kW | 2.0 Litre)**

04.97 - 05.01 | RFX (XU10J2) | X10-729-002-007 | SWP-M-C | Plug Number (T2): 11; T24: XN →

**306 Convertible (7D, N3, N5)****1.6 (65 kW | 1.6 Litre)**

04.96 - 10.00 | NFZ (TU5JP) | X10-729-002-007 | SWP-M-C | Plug Number (T2): 11

**1.6 (72 kW | 1.6 Litre)**

10.00 - 04.02 | NFT | X10-729-002-007 | SWP-M-C | Plug Number (T2): 11

**1.8 (74 kW | 1.8 Litre)**

03.94 - 04.02 | LFZ (XU7JP) | X10-729-002-007 | SWP-M-C | Plug Number (T2): 11



			<b>VDO</b>		
Date	Engine Code	Chassis No.	Article No.	Product	Information

**PEUGEOT****306 Convertible (7D, N3, N5)****1.8 16V (81 kW | 1.8 Litre)**

07.00 - 04.02 LFY (XU7JP4) X10-729-002-007 SWP-M-C Plug Number (T2): 11

**2.0 (89 kW | 2.0 Litre)**

03.94 - 04.02 RFX (XU10J2) X10-729-002-007 SWP-M-C Plug Number (T2): 11

**2.0 16V (97 kW | 2.0 Litre)**

03.97 - 04.02 RFV (XU10J4R) X10-729-002-007 SWP-M-C Plug Number (T2): 11

**307 (3A/C)****1.4 (55 kW | 1.4 Litre)**

08.00 - KFW (TU3JP) A2C53030301 SWP-D-C

**1.4 16V (65 kW | 1.4 Litre)**

11.03 - KFU (ET3J4) A2C53030301 SWP-D-C

**1.4 HDi (50 kW | 1.4 Litre)**

10.01 - 8HX (DV4TD), 8HZ (DV4TD) A2C53030301 SWP-D-C

**1.6 16V (80 kW | 1.6 Litre)**

08.00 - NFU (TU5JP4) A2C53030301 SWP-D-C

**1.6 HDi (66 kW | 1.6 Litre)**

04.05 - 9HX (DV6ATED4) A2C53030301 SWP-D-C

**1.6 HDi 110 (80 kW | 1.6 Litre)**

02.04 - 9HY (DV6TED4), 9HZ (DV6TED4) A2C53030301 SWP-D-C

**2.0 16V (100 kW | 2.0 Litre)**

08.00 - RFN (EW10J4) A2C53030301 SWP-D-C

**2.0 16V (103 kW | 2.0 Litre)**

03.05 - RFJ (EW10A) A2C53030301 SWP-D-C

**2.0 16V (130 kW | 2.0 Litre)**

06.05 - RFK (EW10J4S) A2C53030301 SWP-D-C

**2.0 HDi 110 (79 kW | 2.0 Litre)**

08.00 - RHS (DW10ATED) A2C53030301 SWP-D-C

**2.0 HDi 135 (100 kW | 2.0 Litre)**

10.03 - RHR (DW10BTED4) A2C53030301 SWP-D-C

**2.0 HDi 90 (66 kW | 2.0 Litre)**

08.00 - RHY (DW10TD) A2C53030301 SWP-D-C

**307 Break (3E)****1.4 16V (65 kW | 1.4 Litre)**

11.03 - KFU (ET3J4) A2C53030301 SWP-D-C

**1.4 HDi (50 kW | 1.4 Litre)**

03.02 - 8HZ (DV4TD) A2C53030301 SWP-D-C

**1.6 16V (80 kW | 1.6 Litre)**

03.02 - NFU (TU5JP4) A2C53030301 SWP-D-C

**1.6 HDi (66 kW | 1.6 Litre)**

04.05 - 9HX (DV6ATED4) A2C53030301 SWP-D-C

**1.6 HDi 110 (80 kW | 1.6 Litre)**

02.04 - 9HY (DV6TED4), 9HZ (DV6TED4) A2C53030301 SWP-D-C

**2.0 (100 kW | 2.0 Litre)**

03.02 - RFN (EW10J4) A2C53030301 SWP-D-C

**2.0 16V (130 kW | 2.0 Litre)**

06.05 - RFK (EW10J4S) A2C53030301 SWP-D-C

**2.0 HDi 135 (100 kW | 2.0 Litre)**

02.04 - RHR (DW10BTED4) A2C53030301 SWP-D-C

**2.0 HDi 90 (66 kW | 2.0 Litre)**

03.02 - RHY (DW10TD) A2C53030301 SWP-D-C

**307 SW (3H)****1.6 16V (80 kW | 1.6 Litre)**

03.02 - NFU (TU5JP4) A2C53030301 SWP-D-C

**1.6 HDi 110 (80 kW | 1.6 Litre)**

02.04 - 9HY (DV6TED4), 9HZ (DV6TED4) A2C53030301 SWP-D-C

**2.0 16V (100 kW | 2.0 Litre)**

03.02 - RFN (EW10J4) A2C53030301 SWP-D-C

**2.0 16V (103 kW | 2.0 Litre)**

03.05 - RFJ (EW10A) A2C53030301 SWP-D-C



			<b>VDO</b>		
Date	Engine Code	Chassis No.	Article No.	Product	Information

**PEUGEOT****307 SW (3H)****2.0 HDi 135 (100 kW | 2.0 Litre)**

02.04 - RHR (DW10BTED4) A2C53030301 SWP-D-C

**2.0 HDi 90 (66 kW | 2.0 Litre)**

03.02 - RHY (DW10TD) A2C53030301 SWP-D-C

**308 (4A\_, 4C\_)****1.6 16V (88 kW | 1.6 Litre)**

09.07 - EP6 A2C53030301 SWP-D-C

**1.6 HDi (80 kW | 1.6 Litre)**

09.07 - 9HZ (DV6TED4) A2C53030301 SWP-D-C

**2.0 HDi (100 kW | 2.0 Litre)**

09.07 - RHR (DW10BTED4) A2C53030301 SWP-D-C

**308 SW****1.6 16V (88 kW | 1.6 Litre)**

09.07 - EP6 A2C53030301 SWP-D-C

**1.6 HDi (80 kW | 1.6 Litre)**

09.07 - 9HZ (DV6TED4) A2C53030301 SWP-D-C

**2.0 HDi (100 kW | 2.0 Litre)**

09.07 - RHR (DW10BTED4) A2C53030301 SWP-D-C

**406 (8B)****1.6 (65 kW | 1.6 Litre)**

11.95 - 05.04 BFZ (XU5JP) X10-729-002-007 SWP-M-C Plug Number (T2): 11

**1.8 (66 kW | 1.8 Litre)**

05.97 - 05.04 X10-729-002-007 SWP-M-C Plug Number (T2): 11

**1.8 16V (81 kW | 1.8 Litre)**

11.95 - 10.00 LFY (XU7JP4) X10-729-002-007 SWP-M-C Plug Number (T2): 11

**1.8 16V (85 kW | 1.8 Litre)**

10.00 - 05.04 6FZ (EW7J4) X10-729-002-007 SWP-M-C Plug Number (T2): 11

**1.9 D (55 kW | 1.9 Litre)**

10.96 - 05.04 DHW (XUD9SD) X10-729-002-007 SWP-M-C Plug Number (T2): 11

**1.9 TD (66 kW | 1.9 Litre)**

01.96 - 05.04 DHX (XUD9TE) X10-729-002-007 SWP-M-C Plug Number (T2): 11

**1.9 TD (68 kW | 1.9 Litre)**

01.96 - 05.04 DHY (XUD9TE) X10-729-002-007 SWP-M-C Plug Number (T2): 11

**2.0 16V (100 kW | 2.0 Litre)**

08.00 - 05.04 RFN (EW10J4) X10-729-002-007 SWP-M-C Plug Number (T2): 11

**2.0 16V (97 kW | 2.0 Litre)**

11.95 - 05.04 RFV (XU10J4R) X10-729-002-007 SWP-M-C Plug Number (T2): 11

**2.0 16V (99 kW | 2.0 Litre)**

01.99 - 08.00 RFR (DEW10J4) X10-729-002-007 SWP-M-C Plug Number (T2): 11

**2.0 16V HPi (103 kW | 2.0 Litre)**

05.01 - 05.04 RLZ (EW10D) X10-729-002-007 SWP-M-C Plug Number (T2): 11

**2.0 HDi 110 (79 kW | 2.0 Litre)**08.01 - 05.04 RHS (DW10ATED),  
RHZ (DW10ATED) X10-729-002-007 SWP-M-C Plug Number (T2): 11**2.0 HDi 110 (80 kW | 2.0 Litre)**

06.98 - 08.01 RHZ (DW10ATED) X10-729-002-007 SWP-M-C Plug Number (T2): 11

**2.0 HDi 90 (66 kW | 2.0 Litre)**

02.99 - 05.04 RHY (DW10TD) X10-729-002-007 SWP-M-C Plug Number (T2): 11

**2.0 Turbo (108 kW | 2.0 Litre)**

04.96 - 05.04 RGX (XU10J2TE) X10-729-002-007 SWP-M-C Plug Number (T2): 11

**2.1 TD 12V (80 kW | 2.1 Litre)**

01.96 - 05.04 P8C (XUD11BTE) X10-729-002-007 SWP-M-C Plug Number (T2): 11

**2.2 (116 kW | 2.2 Litre)**

07.00 - 05.04 3FZ (EW12J4) X10-729-002-007 SWP-M-C Plug Number (T2): 11

**2.2 HDi (98 kW | 2.2 Litre)**

03.00 - 05.04 4HX (DW12TED4/FAP) X10-729-002-007 SWP-M-C Plug Number (T2): 11

**3.0 24V (140 kW | 3.0 Litre)**

10.96 - 05.04 XFZ (ES9J4) X10-729-002-007 SWP-M-C Plug Number (T2): 11

**3.0 V6 (152 kW | 3.0 Litre)**

03.00 - 05.04 XFX (ES9J4S) X10-729-002-007 SWP-M-C Plug Number (T2): 11



			<b>VDO</b>		
Date	Engine Code	Chassis No.	Article No.	Product	Information

**PEUGEOT****406 Break (8E/F)****1.8 (66 kW | 1.8 Litre)**

05.97 - 10.04 LFX (XU7JB) X10-729-002-007 SWP-M-C Plug Number (T2): 11

**1.8 16V (81 kW | 1.8 Litre)**

10.96 - 10.00 LFY (XU7JP4) X10-729-002-007 SWP-M-C Plug Number (T2): 11

**1.8 16V (85 kW | 1.8 Litre)**

10.00 - 10.04 6FZ (EW7J4) X10-729-002-007 SWP-M-C Plug Number (T2): 11

**1.9 D (55 kW | 1.9 Litre)**

10.96 - 10.04 DHW (XUD9SD) X10-729-002-007 SWP-M-C Plug Number (T2): 11

**1.9 TD (66 kW | 1.9 Litre)**

10.96 - 10.04 DHX (XUD9TE) X10-729-002-007 SWP-M-C Plug Number (T2): 11

**2.0 16V (100 kW | 2.0 Litre)**

10.00 - 10.04 RFN (EW10J4) X10-729-002-007 SWP-M-C Plug Number (T2): 11

**2.0 16V (97 kW | 2.0 Litre)**

10.96 - 10.04 RFV (XU10J4R) X10-729-002-007 SWP-M-C Plug Number (T2): 11

**2.0 16V (99 kW | 2.0 Litre)**

01.99 - 10.00 RFR (DEW10J4) X10-729-002-007 SWP-M-C Plug Number (T2): 11

**2.0 16V HPi (103 kW | 2.0 Litre)**

05.01 - 10.04 RLZ (EW10D) X10-729-002-007 SWP-M-C Plug Number (T2): 11

**2.0 HDi 110 (79 kW | 2.0 Litre)**08.01 - 10.04 RHS (DW10ATED),  
RHZ (DW10ATED) X10-729-002-007 SWP-M-C Plug Number (T2): 11**2.0 HDi 110 (80 kW | 2.0 Litre)**

02.99 - 04.04 RHZ (DW10ATED) X10-729-002-007 SWP-M-C Plug Number (T2): 11

**2.0 HDi 90 (66 kW | 2.0 Litre)**

02.99 - 10.04 RHY (DW10TD) X10-729-002-007 SWP-M-C Plug Number (T2): 11

**2.0 Turbo (108 kW | 2.0 Litre)**

10.96 - 10.04 RGX (XU10J2TE) X10-729-002-007 SWP-M-C Plug Number (T2): 11

**2.1 TD 12V (80 kW | 2.1 Litre)**

10.96 - 10.04 P8C (XUD11BTE) X10-729-002-007 SWP-M-C Plug Number (T2): 11

**2.2 (116 kW | 2.2 Litre)**

07.00 - 10.04 3FZ (EW12J4) X10-729-002-007 SWP-M-C Plug Number (T2): 11

**2.2 HDi (98 kW | 2.2 Litre)**

03.00 - 10.04 4HX (DW12TED4/FAP) X10-729-002-007 SWP-M-C Plug Number (T2): 11

**3.0 24V (140 kW | 3.0 Litre)**

10.96 - 10.04 XFZ (ES9J4) X10-729-002-007 SWP-M-C Plug Number (T2): 11

**3.0 V6 (152 kW | 3.0 Litre)**

03.00 - 10.04 XFX (ES9J4S) X10-729-002-007 SWP-M-C Plug Number (T2): 11

**406 Coupe (8C)****2.0 16V (100 kW | 2.0 Litre)**

10.00 - 12.04 RFN (EW10J4) X10-729-002-007 SWP-M-C Plug Number (T2): 11

**2.0 16V (97 kW | 2.0 Litre)**

03.97 - 12.04 RFV (XU10J4R) X10-729-002-007 SWP-M-C Plug Number (T2): 11

**2.0 16V (99 kW | 2.0 Litre)**

01.99 - 10.00 RFR (DEW10J4) X10-729-002-007 SWP-M-C Plug Number (T2): 11

**2.2 (116 kW | 2.2 Litre)**

03.02 - 12.04 3FZ (EW12J4) X10-729-002-007 SWP-M-C Plug Number (T2): 11

**2.2 HDi (98 kW | 2.2 Litre)**

03.00 - 12.04 4HX (DW12TED4/FAP) X10-729-002-007 SWP-M-C Plug Number (T2): 11

**3.0 V6 (152 kW | 3.0 Litre)**

03.00 - 12.04 XFX (ES9J4S) X10-729-002-007 SWP-M-C Plug Number (T2): 11

**3.0 V6 24V (140 kW | 3.0 Litre)**

03.97 - 12.04 XFZ (ES9J4) X10-729-002-007 SWP-M-C Plug Number (T2): 11

**407 (6D\_)****1.6 HDi 110 (80 kW | 1.6 Litre)**

05.04 - 9HY (DV6TED4) A2C53030219 SWP-M-C

**1.8 (85 kW | 1.8 Litre)**

05.04 - 6FZ (EW7J4) A2C53030219 SWP-M-C

**1.8 16V (92 kW | 1.8 Litre)**

09.05 - 6FY (EW7A) A2C53030219 SWP-M-C

**2.0 (100 kW | 2.0 Litre)**

05.04 - RFN (EW10J4) A2C53030219 SWP-M-C



			<b>VDO</b>		
Date	Engine Code	Chassis No.	Article No.	Product	Information

**PEUGEOT****407 (6D\_)****2.0 16V (103 kW | 2.0 Litre)**

09.05 - RFJ (EW10A) A2C53030219 SWP-M-C

**2.0 HDi (103 kW | 2.0 Litre)**

08.08 - RHR (DW10BTED4) A2C53030219 SWP-M-C

**2.0 HDi (110 kW | 2.0 Litre)**

02.10 - RHE (DW10CTED4) A2C53030219 SWP-M-C

**2.0 HDi (120 kW | 2.0 Litre)**

07.09 - RHH (DW10CTED4) A2C53030219 SWP-M-C

**2.0 HDi 135 (100 kW | 2.0 Litre)**

05.04 - RHR (DW10BTED4) A2C53030219 SWP-M-C

**2.2 (116 kW | 2.2 Litre)**

05.04 - 3FZ (EW12J4) A2C53030219 SWP-M-C

**2.2 16V (120 kW | 2.2 Litre)**

09.05 - 3FY (EW12J4) A2C53030219 SWP-M-C

**2.2 HDi (120 kW | 2.2 Litre)**

06.08 - 4HP (DW12BTED4) A2C53030219 SWP-M-C

**2.2 HDi 170 (125 kW | 2.2 Litre)**

05.06 - 4HT (DW12BTED4) A2C53030219 SWP-M-C

**2.7 HDi (150 kW | 2.7 Litre)**

10.05 - UHZ (DT17) A2C53030219 SWP-M-C

**3.0 (155 kW | 3.0 Litre)**

05.04 - XFV (ES9A) A2C53030219 SWP-M-C

**407 SW (6E\_)****1.6 HDi 110 (80 kW | 1.6 Litre)**

05.04 - 9HY (DV6TED4) A2C53030219 SWP-M-C

**1.8 (85 kW | 1.8 Litre)**

05.04 - 6FZ (EW7J4) A2C53030219 SWP-M-C

**1.8 16V (92 kW | 1.8 Litre)**

09.05 - 6FY (EW7A) A2C53030219 SWP-M-C

09.05 - 6FY (EW7A) A2C53030301 SWP-D-C

**2.0 (100 kW | 2.0 Litre)**

05.04 - RFN (EW10J4) A2C53030219 SWP-M-C

**2.0 16V (103 kW | 2.0 Litre)**

09.05 - RFJ (EW10A) A2C53030219 SWP-M-C

09.05 - RFJ (EW10A) A2C53030301 SWP-D-C

**2.0 Bioflex (103 kW | 2.0 Litre)**

01.08 - RFJ (EW10A) A2C53030219 SWP-M-C

**2.0 HDi (103 kW | 2.0 Litre)**

08.08 - RHR (DW10BTED4) A2C53030219 SWP-M-C

**2.0 HDi (110 kW | 2.0 Litre)**

02.10 - RHE (DW10CTED4) A2C53030219 SWP-M-C

**2.0 HDi (120 kW | 2.0 Litre)**

07.09 - RHH (DW10CTED4) A2C53030219 SWP-M-C

**2.0 HDi 135 (100 kW | 2.0 Litre)**

05.04 - RHR (DW10BTED4) A2C53030219 SWP-M-C

05.04 - RHR (DW10BTED4) A2C53030301 SWP-D-C

**2.2 (116 kW | 2.2 Litre)**

05.04 - 3FZ (EW12J4) A2C53030219 SWP-M-C

05.04 - 3FZ (EW12J4) A2C53030301 SWP-D-C

**2.2 16V (120 kW | 2.2 Litre)**

09.05 - 3FY (EW12J4) A2C53030219 SWP-M-C

09.05 - 3FY (EW12J4) A2C53030301 SWP-D-C

**2.2 HDi (120 kW | 2.2 Litre)**

06.08 - 4HP (DW12BTED4) A2C53030219 SWP-M-C

**2.2 HDi 170 (125 kW | 2.2 Litre)**

05.06 - 4HT (DW12BTED4) A2C53030219 SWP-M-C

05.06 - 4HT (DW12BTED4) A2C53030301 SWP-D-C

**2.7 HDi (150 kW | 2.7 Litre)**

10.05 - UHZ (DT17) A2C53030219 SWP-M-C

10.05 - UHZ (DT17) A2C53030301 SWP-D-C

**3.0 (155 kW | 3.0 Litre)**

05.04 - XFV (ES9A) A2C53030219 SWP-M-C



			<b>VDO</b>		
Date	Engine Code	Chassis No.	Article No.	Product	Information

**PEUGEOT****407 SW (6E\_)****3.0 (155 kW | 3.0 Litre)**

05.04 - XFV (ES9A)

A2C53030301

SWP-D-C

**407 Coupe (6C\_)****2.0 HDi (100 kW | 2.0 Litre)**

10.05 - RHR (DW10BTED4)

A2C53030219

SWP-M-C

**2.0 HDi (110 kW | 2.0 Litre)**

02.10 - RHE (DW10CTED4)

A2C53030219

SWP-M-C

**2.0 HDi (120 kW | 2.0 Litre)**

06.09 - RHH (DW10CTED4)

A2C53030219

SWP-M-C

**2.2 16V (120 kW | 2.2 Litre)**

10.05 - 3FY (EW12J4)

A2C53030219

SWP-M-C

**2.7 HDi (150 kW | 2.7 Litre)**

10.05 - UHZ (DT17)

A2C53030219

SWP-M-C

**3.0 HDi (177 kW | 3.0 Litre)**

06.09 - DT20C

A2C53030219

SWP-M-C

**3.0 V6 (155 kW | 3.0 Litre)**

10.05 - XFV (ES9A)

A2C53030219

SWP-M-C

**605 (6B)****2.0 (79 kW | 2.0 Litre)**

02.90 - 09.99

X10-729-002-007

SWP-M-C

Plug Number (T2): 11; T24: SL →

**2.0 (84 kW | 2.0 Litre)**

06.89 - 09.99 R5A (XU102C)

X10-729-002-007

SWP-M-C

Plug Number (T2): 11; T24: SL →

**2.0 (89 kW | 2.0 Litre)**

06.89 - 09.99 RFZ (XU10J2Z)

X10-729-002-007

SWP-M-C

Plug Number (T2): 11; T24: SL →

**2.0 16V (97 kW | 2.0 Litre)**

07.94 - 09.99 RFV (XU10J4R)

X10-729-002-007

SWP-M-C

Plug Number (T2): 11; T24: SL →

**2.0 Turbo (104 kW | 2.0 Litre)**

07.92 - 09.99 RGY (XU10J2TE)

X10-729-002-007

SWP-M-C

Plug Number (T2): 11; T24: SL →

**2.0 Turbo (108 kW | 2.0 Litre)**

07.91 - 09.99 RGX (XU10J2TE)

X10-729-002-007

SWP-M-C

Plug Number (T2): 11; T24: SL →

**2.1 D (60 kW | 2.1 Litre)**

06.89 - 07.95 P9A (XUD11A)

X10-729-002-007

SWP-M-C

Plug Number (T2): 11; T24: SL →

**2.1 TD 12V (80 kW | 2.1 Litre)**

08.94 - 09.99 P8C (XUD11BTE)

X10-729-002-007

SWP-M-C

Plug Number (T2): 11; T24: SL →

**2.1 Turbo Diesel (80 kW | 2.1 Litre)**

06.89 - 09.99 PHZ (XUD11ATE)

X10-729-002-007

SWP-M-C

Plug Number (T2): 11; T24: SL →

**2.5 Turbo Diesel (95 kW | 2.5 Litre)**

07.94 - 09.99 THY (DK5ATE)

X10-729-002-007

SWP-M-C

Plug Number (T2): 11; T24: SL →

**3.0 (123 kW | 3.0 Litre)**

10.89 - 09.99 UFZ (ZPJ)

X10-729-002-007

SWP-M-C

Plug Number (T2): 11; T24: SL →

**3.0 SV 24 (147 kW | 3.0 Litre)**

08.89 - 09.99 UKZ (ZPJ4/Z)

X10-729-002-007

SWP-M-C

Plug Number (T2): 11; T24: SL →

**3.0 V6 (140 kW | 3.0 Litre)**

04.97 - 09.99 XFZ (ES9J4)

X10-729-002-007

SWP-M-C

Plug Number (T2): 11; T24: SL →

**807 (E)****2.0 (100 kW | 2.0 Litre)**

06.02 - RFN (EW10J4)

A2C53030301

SWP-D-C

**2.0 16V (103 kW | 2.0 Litre)**

09.05 - RFJ (EW10A)

A2C53030301

SWP-D-C

**2.0 HDi (100 kW | 2.0 Litre)**

06.06 - RHR (DW10BTED4)

A2C53030301

SWP-D-C

**2.0 HDi (79 kW | 2.0 Litre)**06.02 - RHK (DW10UTED4),  
RHM (DW10ATED4),  
RHT (DW10ATED4),  
RHW (DW10ATED4)

A2C53030301

SWP-D-C

**2.2 (116 kW | 2.2 Litre)**

06.02 - 3FZ (EW12J4)

A2C53030301

SWP-D-C

**2.2 HDi (94 kW | 2.2 Litre)**

06.02 - 4HX (DW12TED4/FAP)

A2C53030301

SWP-D-C





			<b>VDO</b>		
Date	Engine Code	Chassis No.	Article No.	Product	Information

**PEUGEOT****EXPERT (224)****1.6 (58 kW | 1.6 Litre)**

02.96 -	222A2 (1580 SPI)		X10-729-002-007	SWP-M-C	Plug Number (T2): 11
---------	------------------	--	-----------------	---------	----------------------

**1.9 D (51 kW | 1.9 Litre)**

12.03 -	WJY (DW8B), WJZ (DW8)		A2C53030301	SWP-D-C	
02.96 -	D9B (XUD9AU)		X10-729-002-007	SWP-M-C	Plug Number (T2): 11

**1.9 TD (66 kW | 1.9 Litre)**

02.96 -	DHX (XUD9TE)		X10-729-002-007	SWP-M-C	Plug Number (T2): 11
---------	--------------	--	-----------------	---------	----------------------

**1.9 TD (68 kW | 1.9 Litre)**

02.96 -	D8B (XUD9TE)		X10-729-002-007	SWP-M-C	Plug Number (T2): 11
---------	--------------	--	-----------------	---------	----------------------

**2.0 (100 kW | 2.0 Litre)**

07.00 -	RFN (EW10J4)		X10-729-002-007	SWP-M-C	Plug Number (T2): 11
---------	--------------	--	-----------------	---------	----------------------

**2.0 HDi (69 kW | 2.0 Litre)**

10.00 - 11.03	RHX (DW10BTED)		A2C53030301	SWP-D-C	
---------------	----------------	--	-------------	---------	--

**2.0 HDi (80 kW | 2.0 Litre)**

07.00 -	RHZ (DW10ATED)		X10-729-002-007	SWP-M-C	Plug Number (T2): 11
---------	----------------	--	-----------------	---------	----------------------

**EXPERT Box (222)****1.6 (58 kW | 1.6 Litre)**

02.96 -	222A2 (1580 SPI)		X10-729-002-007	SWP-M-C	Plug Number (T2): 11
---------	------------------	--	-----------------	---------	----------------------

**1.9 D (51 kW | 1.9 Litre)**

02.96 -	D9B (XUD9AU)		X10-729-002-007	SWP-M-C	Plug Number (T2): 11
---------	--------------	--	-----------------	---------	----------------------

**1.9 D 70 (51 kW | 1.9 Litre)**

12.98 -	WJY (DW8B), WJZ (DW8)		A2C53030301	SWP-D-C	
---------	-----------------------	--	-------------	---------	--

**1.9 TD (66 kW | 1.9 Litre)**

02.96 -	DHX (XUD9TE)		X10-729-002-007	SWP-M-C	Plug Number (T2): 11
---------	--------------	--	-----------------	---------	----------------------

**1.9 TD (68 kW | 1.9 Litre)**

02.96 -	D8B (XUD9TE)		X10-729-002-007	SWP-M-C	Plug Number (T2): 11
---------	--------------	--	-----------------	---------	----------------------

**2.0 HDi (69 kW | 2.0 Litre)**

07.00 -	RHX (DW10BTED)		X10-729-002-007	SWP-M-C	Plug Number (T2): 11
---------	----------------	--	-----------------	---------	----------------------

**2.0 HDi (80 kW | 2.0 Litre)**

07.00 -	RHZ (DW10ATED)		X10-729-002-007	SWP-M-C	Plug Number (T2): 11
---------	----------------	--	-----------------	---------	----------------------

**PARTNER Box (5)****1.1 (44 kW | 1.1 Litre)**

06.96 -	HDZ (TU1M)		X10-729-002-007	SWP-M-C	Plug Number (T2): 11
---------	------------	--	-----------------	---------	----------------------

**1.4 (55 kW | 1.4 Litre)**

06.96 -	KFX (TU3JP), TU32		X10-729-002-007	SWP-M-C	Plug Number (T2): 11
---------	-------------------	--	-----------------	---------	----------------------

**1.8 D (43 kW | 1.8 Litre)**

06.96 -	A9A (XUD7)		X10-729-002-007	SWP-M-C	Plug Number (T2): 11
---------	------------	--	-----------------	---------	----------------------

**1.9 D (51 kW | 1.9 Litre)**

06.96 -	DJY (XUD9A)		X10-729-002-007	SWP-M-C	Plug Number (T2): 11
---------	-------------	--	-----------------	---------	----------------------

**2.0 HDi (66 kW | 2.0 Litre)**

04.00 -	RHY (DW10TD)		X10-729-002-007	SWP-M-C	Plug Number (T2): 11
---------	--------------	--	-----------------	---------	----------------------

**PORSCHE****911****2.0 T (81 kW | 2.0 Litre)**

08.68 - 02.72	901.03, 901.13		246-075-015-001C	SWP-M-G	Plug Number (T2): 1
---------------	----------------	--	------------------	---------	---------------------

**2.2 T (92 kW | 2.2 Litre)**

01.70 - 12.72	911.06, 911.07, 911.08		246-075-015-001C	SWP-M-G	Plug Number (T2): 1
---------------	------------------------	--	------------------	---------	---------------------

**2.3 S (140 kW | 2.3 Litre)**

08.71 - 01.76	911.53, 911.63		246-075-015-001C	SWP-M-G	Plug Number (T2): 1
---------------	----------------	--	------------------	---------	---------------------

**2.3 T (103 kW | 2.3 Litre)**

08.71 - 12.73			246-075-015-001C	SWP-M-G	Plug Number (T2): 1
---------------	--	--	------------------	---------	---------------------

**2.3 T (96 kW | 2.3 Litre)**

01.72 - 12.73			246-075-015-001C	SWP-M-G	Plug Number (T2): 1
---------------	--	--	------------------	---------	---------------------

**2.7 (121 kW | 2.7 Litre)**

09.75 - 06.77			246-075-015-001C	SWP-M-G	Plug Number (T2): 1
---------------	--	--	------------------	---------	---------------------

**3.2 (160 kW | 3.2 Litre)**

08.86 - 08.89	930.25		246-075-015-001C	SWP-M-G	Plug Number (T2): 1
---------------	--------	--	------------------	---------	---------------------



			<b>VDO</b>		
Date	Engine Code	Chassis No.	Article No.	Product	Information

**PORSCHE****911****3.2 (160 kW | 3.2 Litre)**

08.86 - 08.89 | 930.25 | 246-082-008-014C | SWP-M-C | Plug Number (T2): 1

**3.2 SC Carrera (152 kW | 3.2 Litre)**

02.84 - 06.87 | 930.21 | 246-082-008-014C | SWP-M-C | Plug Number (T2): 1

**3.3 Turbo (221 kW | 3.3 Litre)**

06.86 - 08.89 | 930.66 | 246-082-008-014C | SWP-M-C | Plug Number (T2): 1

**3.3 Turbo S (243 kW | 3.3 Litre)**

09.86 - 11.90 | 930.60 | 246-082-008-014C | SWP-M-C | Plug Number (T2): 1

**911 Targa****2.0 T (81 kW | 2.0 Litre)**

06.67 - 02.72 | 901.03, 901.13 | 246-075-015-001C | SWP-M-G | Plug Number (T2): 1

**2.2 T (92 kW | 2.2 Litre)**

01.70 - 12.72 | 911.06 | 246-075-015-001C | SWP-M-G | Plug Number (T2): 1

**2.3 T (96 kW | 2.3 Litre)**

01.72 - 12.73 | 246-075-015-001C | SWP-M-G | Plug Number (T2): 1

**3.3 Turbo (221 kW | 3.3 Litre)**

09.86 - 11.90 | 930.66 | 246-082-008-014C | SWP-M-C | Plug Number (T2): 1

**911 Convertible****3.1 Carrera Speedster (160 kW | 3.1 Litre)**

08.86 - 08.89 | 930.25 | 246-082-008-014C | SWP-M-C | Plug Number (T2): 1

**3.1 Carrera Speedster (170 kW | 3.1 Litre)**

08.86 - 08.89 | 930.20 | 246-082-008-014C | SWP-M-C | Plug Number (T2): 1

**3.1 SC Carrera (152 kW | 3.1 Litre)**

10.84 - 08.89 | 930.21 | 246-082-008-014C | SWP-M-C | Plug Number (T2): 1

**911 (964)****3.3 Turbo (235 kW | 3.3 Litre)**

08.90 - 09.93 | M 30.69 | 246-082-008-014C | SWP-M-C | Plug Number (T2): 1

**3.3 Turbo S (261 kW | 3.3 Litre)**

06.91 - 12.92 | M 30.69S | 246-086-001-002C | HLWP | Plug Number (T2): 3

**3.6 Carrera (184 kW | 3.6 Litre)**

07.89 - 09.93 | M 64.01, M64.02 | 246-082-008-014C | SWP-M-C | Plug Number (T2): 1

07.89 - 09.93 | M 64.01, M 64.02 | 246-082-008-014C | SWP-M-C | Plug Number (T2): 1

**3.6 Carrera 4 (184 kW | 3.6 Litre)**

12.88 - 09.93 | M 64.01 | 246-082-008-014C | SWP-M-C | Plug Number (T2): 1

12.88 - 09.93 | M 64.01 | 246-082-008-014C | SWP-M-C | Plug Number (T2): 1

**3.6 Carrera RS (191 kW | 3.6 Litre)**

06.91 - 09.93 | 64.03 | 246-082-008-014C | SWP-M-C | Plug Number (T2): 1

06.91 - 09.93 | 64.03 | 246-086-001-002C | HLWP | Plug Number (T2): 3

**3.6 Turbo (265 kW | 3.6 Litre)**

01.93 - 09.93 | M 64.50 | 246-082-008-014C | SWP-M-C | Plug Number (T2): 1

01.93 - 09.93 | M 64.50 | 246-082-008-014C | SWP-M-C | Plug Number (T2): 1

**911 Convertible (964)****3.6 Carrera (184 kW | 3.6 Litre)**

01.93 - 05.94 | M 64.01, M 64.02 | 246-075-042-001C | SWP-M-G | Plug Number (T2): 1

01.92 - 12.93 | M 64.01, M 64.02 | 246-082-008-014C | SWP-M-C | Plug Number (T2): 1

**3.6 Carrera 4 (184 kW | 3.6 Litre)**

01.93 - 05.94 | M 64.01 | 246-086-001-002C | HLWP | Plug Number (T2): 3

**911 Convertible (993)****3.6 Carrera (200 kW | 3.6 Litre)**

07.94 - 08.95 | M 64.05, M 64.06, M 64.07, M 64.08 | 246-082-008-014C | SWP-M-C | Plug Number (T2): 1

**3.6 Carrera 4 (200 kW | 3.6 Litre)**

07.94 - 08.95 | M 64.05, M 64.07 | 246-082-008-014C | SWP-M-C | Plug Number (T2): 1

**911 (996)****3.4 Carrera (221 kW | 3.4 Litre)**

09.97 - 09.01 | M 96.01, M 96.04 | 246-086-001-002C | HLWP | Plug Number (T2): 3

09.97 - 09.01 | M 96.01, M 96.04 | 246-086-001-002C | HLWP | Plug Number (T2): 3



			<b>VDO</b>		
Date	Engine Code	Chassis No.	Article No.	Product	Information

**PORSCHE****911 (996)****3.4 Carrera (235 kW | 3.4 Litre)**

05.01 - 08.05 | 246-086-001-002C | HLWP | Plug Number (T2): 3

**3.4 Carrera 4 (221 kW | 3.4 Litre)**

09.97 - 09.01 | M 96.01, M 96.04 | 246-086-001-002C | HLWP | Plug Number (T2): 3

09.97 - 09.01 | M 96.01, M 96.04 | 246-086-001-002C | HLWP | Plug Number (T2): 3

**3.4 Carrera 4 (235 kW | 3.4 Litre)**

05.01 - 08.05 | 246-086-001-002C | HLWP | Plug Number (T2): 3

**3.6 Carrera (235 kW | 3.6 Litre)**

10.01 - 08.05 | M 96.03 | 246-086-001-002C | HLWP | Plug Number (T2): 3

10.01 - 08.05 | M 96.03 | 246-086-001-002C | HLWP | Plug Number (T2): 3

**3.6 Carrera 4 (235 kW | 3.6 Litre)**

10.01 - 08.05 | M 96.03 | 246-086-001-002C | HLWP | Plug Number (T2): 3

10.01 - 08.05 | M 96.03 | 246-086-001-002C | HLWP | Plug Number (T2): 3

**3.6 Carrera 4S (254 kW | 3.6 Litre)**

02.03 - 08.05 | M 96.03 | 246-086-001-002C | HLWP | Plug Number (T2): 3

**3.6 Carrera S (254 kW | 3.6 Litre)**

02.03 - 08.05 | M 96.03 | 246-086-001-002C | HLWP | Plug Number (T2): 3

**3.6 GT2 (340 kW | 3.6 Litre)**

04.01 - 08.05 | M 96.70 | 246-086-001-002C | HLWP | Plug Number (T2): 3

04.01 - 08.05 | M 96.70 | 246-086-001-002C | HLWP | Plug Number (T2): 3

**3.6 GT2 (355 kW | 3.6 Litre)**

10.03 - 08.05 | M 96.70 | 246-086-001-002C | HLWP | Plug Number (T2): 3

**3.6 GT3 (265 kW | 3.6 Litre)**

03.99 - 08.05 | M 96.76 | 246-086-001-002C | HLWP | Plug Number (T2): 3

03.99 - 08.05 | M 96.76 | 246-086-001-002C | HLWP | Plug Number (T2): 3

**3.6 GT3 (280 kW | 3.6 Litre)**

03.03 - 08.05 | M 96.79 | 246-086-001-002C | HLWP | Plug Number (T2): 3

**3.6 Turbo 4 (309 kW | 3.6 Litre)**

06.00 - 08.05 | M 96.70 | 246-086-001-002C | HLWP | Plug Number (T2): 3

**3.6 Turbo 4S (331 kW | 3.6 Litre)**

02.03 - 08.05 | M 96.70 | 246-086-001-002C | HLWP | Plug Number (T2): 3

**911 Convertible (996)****3.4 Carrera (221 kW | 3.4 Litre)**

02.98 - 09.01 | M 96.01, M 96.04 | 246-086-001-002C | HLWP | Plug Number (T2): 3

**3.4 Carrera (235 kW | 3.4 Litre)**

05.01 - 08.05 | 246-086-001-002C | HLWP | Plug Number (T2): 3

**3.4 Carrera 4 (221 kW | 3.4 Litre)**

02.98 - 09.01 | M 96.02, M 96.04 | 246-086-001-002C | HLWP | Plug Number (T2): 3

**3.4 Carrera 4 (235 kW | 3.4 Litre)**

05.01 - 08.05 | 246-086-001-002C | HLWP | Plug Number (T2): 3

**3.6 Carrera (235 kW | 3.6 Litre)**

10.01 - 08.05 | M 96.03 | 246-086-001-002C | HLWP | Plug Number (T2): 3

**3.6 Carrera 4 (235 kW | 3.6 Litre)**

10.01 - 08.05 | M 96.03 | 246-086-001-002C | HLWP | Plug Number (T2): 3

**3.6 Carrera 4S (254 kW | 3.6 Litre)**

06.02 - 08.05 | M 96.03 | 246-086-001-002C | HLWP | Plug Number (T2): 3

**3.6 Carrera S (254 kW | 3.6 Litre)**

06.02 - 08.05 | M 96.03 | 246-086-001-002C | HLWP | Plug Number (T2): 3

**3.6 Turbo 4 (309 kW | 3.6 Litre)**

10.03 - 08.05 | M 96.70 | 246-086-001-002C | HLWP | Plug Number (T2): 3

**3.6 Turbo 4S (331 kW | 3.6 Litre)**

10.03 - 08.05 | M 96.70 | 246-086-001-002C | HLWP | Plug Number (T2): 3

**911 Targa (996)****3.6 (235 kW | 3.6 Litre)**

12.01 - 08.05 | M 96.03 | 246-086-001-002C | HLWP | Plug Number (T2): 3

**911 (997)****3.6 Carrera (239 kW | 3.6 Litre)**

07.04 - | M 96.05 | 246-086-001-007C | HLWP | Plug Number (T2): 3b

**3.6 Carrera (254 kW | 3.6 Litre)**

06.08 - | MA1.02 | 246-086-001-007C | HLWP | Plug Number (T2): 3b



			<b>VDO</b>		
Date	Engine Code	Chassis No.	Article No.	Product	Information

**PORSCHE****911 (997)**

<b>3.6 Carrera 4 (239 kW   3.6 Litre)</b>					
07.04 -	M 96.05		246-086-001-007C	HLWP	Plug Number (T2): 3b
<b>3.6 Carrera 4 (254 kW   3.6 Litre)</b>					
06.08 -	MA1.02		246-086-001-007C	HLWP	Plug Number (T2): 3b
<b>3.6 GT 2 (390 kW   3.6 Litre)</b>					
09.07 -	M 97.70S		246-086-001-007C	HLWP	Plug Number (T2): 3b
<b>3.6 GT 3 (305 kW   3.6 Litre)</b>					
03.06 -	M 97.76		246-086-001-007C	HLWP	Plug Number (T2): 3b
<b>3.6 GT2 RS (456 kW   3.6 Litre)</b>					
05.10 -	M 97.70		246-086-001-007C	HLWP	Plug Number (T2): 3b
<b>3.6 Turbo (353 kW   3.6 Litre)</b>					
03.06 -	M 97.70		246-086-001-007C	HLWP	Plug Number (T2): 3b
<b>3.8 Carrera 4GTS (300 kW   3.8 Litre)</b>					
06.09 -	MA1.01		246-086-001-007C	HLWP	Plug Number (T2): 3b
<b>3.8 Carrera 4S (261 kW   3.8 Litre)</b>					
07.04 -	M 97.01		246-086-001-007C	HLWP	Plug Number (T2): 3b
<b>3.8 Carrera 4S (280 kW   3.8 Litre)</b>					
08.05 -	M 97.01S		246-086-001-007C	HLWP	Plug Number (T2): 3b
<b>3.8 Carrera 4S (283 kW   3.8 Litre)</b>					
06.08 -	MA1.01		246-086-001-007C	HLWP	Plug Number (T2): 3b
<b>3.8 Carrera GTS (300 kW   3.8 Litre)</b>					
06.09 -	MA1.01		246-086-001-007C	HLWP	Plug Number (T2): 3b
<b>3.8 Carrera S (261 kW   3.8 Litre)</b>					
07.04 -	M 97.01		246-086-001-007C	HLWP	Plug Number (T2): 3b
<b>3.8 Carrera S (280 kW   3.8 Litre)</b>					
08.05 -	M 97.01S		246-086-001-007C	HLWP	Plug Number (T2): 3b
<b>3.8 Carrera S (283 kW   3.8 Litre)</b>					
06.08 -	MA1.01		246-086-001-007C	HLWP	Plug Number (T2): 3b
<b>3.8 GT3 (320 kW   3.8 Litre)</b>					
05.09 -	M 97.77		246-086-001-007C	HLWP	Plug Number (T2): 3b
<b>3.8 GT3 RS (331 kW   3.8 Litre)</b>					
08.09 -	M 97.77R		246-086-001-007C	HLWP	Plug Number (T2): 3b
<b>3.8 Turbo (368 kW   3.8 Litre)</b>					
09.09 -	MA1.70		246-086-001-007C	HLWP	Plug Number (T2): 3b
<b>4.0 GT3 RS (368 kW   4.0 Litre)</b>					
07.11 -	M 97.74		246-086-001-007C	HLWP	Plug Number (T2): 3b

**911 Convertible (997)**

<b>3.6 Carrera (239 kW   3.6 Litre)</b>					
04.05 -	M 96.05		246-086-001-007C	HLWP	Plug Number (T2): 3b
<b>3.6 Carrera (254 kW   3.6 Litre)</b>					
06.08 -	MA1.02		246-086-001-007C	HLWP	Plug Number (T2): 3b
<b>3.6 Carrera 4 (239 kW   3.6 Litre)</b>					
04.05 -	M 96.05		246-086-001-007C	HLWP	Plug Number (T2): 3b
<b>3.6 Carrera 4 (254 kW   3.6 Litre)</b>					
06.08 -	MA1.02		246-086-001-007C	HLWP	Plug Number (T2): 3b
<b>3.6 Turbo (353 kW   3.6 Litre)</b>					
09.07 -	M 97.70		246-086-001-007C	HLWP	Plug Number (T2): 3b
<b>3.8 Carrera 4GTS (300 kW   3.8 Litre)</b>					
06.09 -	MA1.01		246-086-001-007C	HLWP	Plug Number (T2): 3b
<b>3.8 Carrera 4S (261 kW   3.8 Litre)</b>					
04.05 -	M 97.01		246-086-001-007C	HLWP	Plug Number (T2): 3b
<b>3.8 Carrera 4S (280 kW   3.8 Litre)</b>					
08.05 -	M 97.01S		246-086-001-007C	HLWP	Plug Number (T2): 3b
<b>3.8 Carrera 4S (283 kW   3.8 Litre)</b>					
06.08 -	MA1.01		246-086-001-007C	HLWP	Plug Number (T2): 3b
<b>3.8 Carrera GTS (300 kW   3.8 Litre)</b>					
06.09 -	MA1.01		246-086-001-007C	HLWP	Plug Number (T2): 3b
<b>3.8 Carrera S (261 kW   3.8 Litre)</b>					
04.05 -	M 97.01		246-086-001-007C	HLWP	Plug Number (T2): 3b
<b>3.8 Carrera S (280 kW   3.8 Litre)</b>					
08.05 -	M 97.01S		246-086-001-007C	HLWP	Plug Number (T2): 3b



			<b>VDO</b>		
Date	Engine Code	Chassis No.	Article No.	Product	Information

**PORSCHE****911 Convertible (997)****3.8 Carrera S (283 kW | 3.8 Litre)**

06.08 -	MA1.01		246-086-001-007C	HLWP	Plug Number (T2): 3b
---------	--------	--	------------------	------	----------------------

**3.8 Turbo (368 kW | 3.8 Litre)**

09.09 -	MA1.70		246-086-001-007C	HLWP	Plug Number (T2): 3b
---------	--------	--	------------------	------	----------------------

**911 Targa (997)****3.6 Carrera 4 (239 kW | 3.6 Litre)**

07.06 -	M 96.05		246-086-001-007C	HLWP	Plug Number (T2): 3b
---------	---------	--	------------------	------	----------------------

**3.6 Carrera 4 (254 kW | 3.6 Litre)**

10.08 -	MA1.02		246-086-001-007C	HLWP	Plug Number (T2): 3b
---------	--------	--	------------------	------	----------------------

**3.8 Carrera 4S (261 kW | 3.8 Litre)**

07.06 -	M 97.01		246-086-001-007C	HLWP	Plug Number (T2): 3b
---------	---------	--	------------------	------	----------------------

**3.8 Carrera 4S (283 kW | 3.8 Litre)**

10.08 -	MA1.01		246-086-001-007C	HLWP	Plug Number (T2): 3b
---------	--------	--	------------------	------	----------------------

**914****1.7 (59 kW | 1.7 Litre)**

01.69 - 12.73	W		246-075-015-001C	SWP-M-G	Plug Number (T2): 1
---------------	---	--	------------------	---------	---------------------

**924****2.0 (92 kW | 2.0 Litre)**

11.75 - 08.89	XJ, XK		246-075-021-006C	SWP-M-G	Plug Number (T2): 1
---------------	--------	--	------------------	---------	---------------------

08.87 - 08.89	XJ, XK		246-075-042-001C	SWP-M-G	Plug Number (T2): 1
---------------	--------	--	------------------	---------	---------------------

**2.0 Carrera GT (154 kW | 2.0 Litre)**

06.80 - 10.86	M 31.50		246-075-021-006C	SWP-M-G	Plug Number (T2): 1
---------------	---------	--	------------------	---------	---------------------

06.80 - 10.86	M 31.50		246-086-001-002C	HLWP	Plug Number (T2): 3
---------------	---------	--	------------------	------	---------------------

**2.0 Turbo (125 kW | 2.0 Litre)**

11.78 - 06.80	M 31.01		246-075-021-006C	SWP-M-G	Plug Number (T2): 1
---------------	---------	--	------------------	---------	---------------------

**2.0 Turbo (130 kW | 2.0 Litre)**

06.80 - 10.86	M 31.03		246-075-021-006C	SWP-M-G	Plug Number (T2): 1
---------------	---------	--	------------------	---------	---------------------

06.80 - 10.86	M 31.03		246-086-001-002C	HLWP	Plug Number (T2): 3
---------------	---------	--	------------------	------	---------------------

**2.5 S (110 kW | 2.5 Litre)**

09.85 - 07.87	M 44.07, M 44.08		246-075-021-006C	SWP-M-G	Plug Number (T2): 1
---------------	------------------	--	------------------	---------	---------------------

09.85 - 07.87	M 44.07, M 44.08		246-086-001-002C	HLWP	Plug Number (T2): 3
---------------	------------------	--	------------------	------	---------------------

**2.5 S (118 kW | 2.5 Litre)**

08.87 - 07.88	M 44.09, M 44.10		246-075-021-006C	SWP-M-G	Plug Number (T2): 1
---------------	------------------	--	------------------	---------	---------------------

08.87 - 07.88	M 44.09, M 44.10		246-086-001-002C	HLWP	Plug Number (T2): 3
---------------	------------------	--	------------------	------	---------------------

**2.5 S (120 kW | 2.5 Litre)**

10.81 - 12.84	M 44.01, M 44.03		246-075-021-006C	SWP-M-G	Plug Number (T2): 1
---------------	------------------	--	------------------	---------	---------------------

10.81 - 12.84	M 44.01, M 44.03		246-086-001-002C	HLWP	Plug Number (T2): 3
---------------	------------------	--	------------------	------	---------------------

**928****4.4 (177 kW | 4.4 Litre)**

09.77 - 08.82	M 28.10		246-075-015-001C	SWP-M-G	Plug Number (T2): 1
---------------	---------	--	------------------	---------	---------------------

09.77 - 08.82	M 28.10	- F - 848 409→ -- H - 840 626	246-075-042-001C	SWP-M-G	Plug Number (T2): 1
---------------	---------	----------------------------------	------------------	---------	---------------------

09.77 - 08.82	M 28.10		246-086-001-002C	HLWP	Plug Number (T2): 3
---------------	---------	--	------------------	------	---------------------

**4.6 S (221 kW | 4.6 Litre)**

09.79 - 07.83	M 28.11, M 28.12		246-086-001-002C	HLWP	Plug Number (T2): 3
---------------	------------------	--	------------------	------	---------------------

**4.6 S (228 kW | 4.6 Litre)**

08.83 - 07.86	M 28.21, M 28.22		246-086-001-002C	HLWP	Plug Number (T2): 3
---------------	------------------	--	------------------	------	---------------------

**4.7 (200 kW | 4.7 Litre)**

08.84 - 07.85			246-086-001-002C	HLWP	Plug Number (T2): 3
---------------	--	--	------------------	------	---------------------

**4.9 S (212 kW | 4.9 Litre)**

09.85 - 05.94	M 28.45, M 28.46		246-086-001-002C	HLWP	Plug Number (T2): 3
---------------	------------------	--	------------------	------	---------------------

**4.9 S,S4 (235 kW | 4.9 Litre)**

08.86 - 07.91	M 28.41, M 28.42		246-086-001-002C	HLWP	Plug Number (T2): 3
---------------	------------------	--	------------------	------	---------------------

**5.0 GT (243 kW | 5.0 Litre)**

01.89 - 07.91	M 28.47		246-086-001-002C	HLWP	Plug Number (T2): 3
---------------	---------	--	------------------	------	---------------------

**5.0 S4 CAT (235 kW | 5.0 Litre)**

08.86 - 07.91	M 28.41, M 28.42		246-086-001-002C	HLWP	Plug Number (T2): 3
---------------	------------------	--	------------------	------	---------------------

**5.4 GTS (257 kW | 5.4 Litre)**

08.91 - 11.95	M 28.49, M 28.50		246-086-001-002C	HLWP	Plug Number (T2): 3
---------------	------------------	--	------------------	------	---------------------



			<b>VDO</b>		
Date	Engine Code	Chassis No.	Article No.	Product	Information

**PORSCHE****944****2.5 (110 kW | 2.5 Litre)**

01.85 - 07.87	M 44.02, M 44.04, M 44.07, M 44.08		246-075-021-006C	SWP-M-G	Plug Number (T2): 1
01.85 - 07.87	M 44.02, M 44.04, M 44.07, M 44.08		246-086-001-002C	HLWP	Plug Number (T2): 3

**2.5 (118 kW | 2.5 Litre)**

08.87 - 12.90	M 44.05, M 44.09, M 44.10		246-075-042-001C	SWP-M-G	Plug Number (T2): 1
08.87 - 12.90	M 44.05, M 44.09, M 44.10		246-086-001-002C	HLWP	Plug Number (T2): 3

**2.5 (120 kW | 2.5 Litre)**

06.81 - 07.87	M 44.01, M 44.03, M 44.05, M 44.06		246-075-021-006C	SWP-M-G	Plug Number (T2): 1
06.81 - 07.87	M 44.01, M 44.03, M 44.05, M 44.06		246-086-001-002C	HLWP	Plug Number (T2): 3

**2.5 S (140 kW | 2.5 Litre)**

08.86 - 07.88	M 44.40		246-075-042-001C	SWP-M-G	Plug Number (T2): 1
08.86 - 07.88	M 44.40		246-086-001-002C	HLWP	Plug Number (T2): 3

**2.5 Turbo (162 kW | 2.5 Litre)**

08.85 - 07.88	M 44.50, M 44.51		246-075-042-001C	SWP-M-G	Plug Number (T2): 1
08.85 - 07.88	M 44.50, M 44.51		246-086-001-002C	HLWP	Plug Number (T2): 3

**2.5 Turbo (184 kW | 2.5 Litre)**

09.87 - 07.91	M 44.52		246-075-042-001C	SWP-M-G	Plug Number (T2): 1
09.87 - 07.91	M 44.52		246-086-001-002C	HLWP	Plug Number (T2): 3

**2.7 (121 kW | 2.7 Litre)**

11.88 - 08.89	M 44.11, M 44.12		246-075-042-001C	SWP-M-G	Plug Number (T2): 1
11.88 - 08.89	M 44.11, M 44.12		246-086-001-002C	HLWP	Plug Number (T2): 3

**3.0 S2 (155 kW | 3.0 Litre)**

12.88 - 07.91	M 44.41		246-075-042-001C	SWP-M-G	Plug Number (T2): 1
12.88 - 07.91	M 44.41		246-086-001-002C	HLWP	Plug Number (T2): 3

**944 Convertible****2.5 Turbo (184 kW | 2.5 Litre)**

11.90 - 07.91	M 44.52		246-086-001-002C	HLWP	Plug Number (T2): 3
---------------	---------	--	------------------	------	---------------------

**3.0 S2 (155 kW | 3.0 Litre)**

12.88 - 07.91	M 44.41		246-075-021-006C	SWP-M-G	Plug Number (T2): 1
12.88 - 07.91	M 44.41		246-086-001-002C	HLWP	Plug Number (T2): 3

**959****2.8 (330 kW | 2.8 Litre)**

01.86 - 04.91	959.50		246-086-001-002C	HLWP	Plug Number (T2): 3
---------------	--------	--	------------------	------	---------------------

**BOXSTER (986)****2.5 (150 kW | 2.5 Litre)**

09.96 - 08.99	M 96.20		246-086-001-002C	HLWP	Plug Number (T2): 3
---------------	---------	--	------------------	------	---------------------

**2.7 (162 kW | 2.7 Litre)**

08.99 - 07.02	M 96.22		246-086-001-002C	HLWP	Plug Number (T2): 3
---------------	---------	--	------------------	------	---------------------

**2.7 (168 kW | 2.7 Litre)**

07.02 - 12.04	M 96.23		246-086-001-002C	HLWP	Plug Number (T2): 3
---------------	---------	--	------------------	------	---------------------

**S 3.2 (191 kW | 3.2 Litre)**

07.02 - 12.04	M 96.24		246-086-001-002C	HLWP	Plug Number (T2): 3
---------------	---------	--	------------------	------	---------------------

**S 3.2 (185 kW | 3.2 Litre)**

08.99 - 07.02	M 96.21		246-086-001-002C	HLWP	Plug Number (T2): 3
---------------	---------	--	------------------	------	---------------------

**S 3.2 (196 kW | 3.2 Litre)**

01.04 - 12.04	M 96.24		246-086-001-002C	HLWP	Plug Number (T2): 3
---------------	---------	--	------------------	------	---------------------

**BOXSTER (987)****2.7 (176 kW | 2.7 Litre)**

11.04 -	M 96.25		246-086-001-007C	HLWP	Plug Number (T2): 3b
---------	---------	--	------------------	------	----------------------

**2.7 (180 kW | 2.7 Litre)**

07.06 -	M 97.20		246-086-001-007C	HLWP	Plug Number (T2): 3b
---------	---------	--	------------------	------	----------------------

**2.9 (188 kW | 2.9 Litre)**

06.09 -	MA1.20		246-086-001-007C	HLWP	Plug Number (T2): 3b
---------	--------	--	------------------	------	----------------------

**S 3.2 (206 kW | 3.2 Litre)**

11.04 -	M 96.26		246-086-001-007C	HLWP	Plug Number (T2): 3b
---------	---------	--	------------------	------	----------------------



			<b>VDO</b>		
Date	Engine Code	Chassis No.	Article No.	Product	Information

**PORSCHE****BOXSTER (987)****S 3.4 (217 kW | 3.4 Litre)**

07.06 → M 97.21

246-086-001-007C

HLWP

Plug Number (T2): 3b

**S 3.4 (223 kW | 3.4 Litre)**

08.08 → M 97.22

246-086-001-007C

HLWP

Plug Number (T2): 3b

**S 3.4 (228 kW | 3.4 Litre)**

06.09 → MA1.21

246-086-001-007C

HLWP

Plug Number (T2): 3b

**Spyder 3.4 (235 kW | 3.4 Litre)**

06.10 → MA1.21

246-086-001-007C

HLWP

Plug Number (T2): 3b

**CARRERA GT****5.7 (450 kW | 5.7 Litre)**

07.03 → M 80.01

246-086-001-007C

HLWP

Plug Number (T2): 3b

**CAYMAN (987)****2.7 (180 kW | 2.7 Litre)**

07.06 → M 97.20

246-086-001-007C

HLWP

Plug Number (T2): 3b

**2.9 (195 kW | 2.9 Litre)**

02.09 → MA1.20

246-086-001-007C

HLWP

Plug Number (T2): 3b

**R 3.4 (243 kW | 3.4 Litre)**

11.10 → MA1.21

246-086-001-007C

HLWP

Plug Number (T2): 3b

**S 3.4 Sport (223 kW | 3.4 Litre)**

08.08 → M 97.22

246-086-001-007C

HLWP

Plug Number (T2): 3b

**S 3.4 (217 kW | 3.4 Litre)**

11.05 → M 97.21

246-086-001-007C

HLWP

Plug Number (T2): 3b

**S 3.4 (235 kW | 3.4 Litre)**

02.09 → MA1.21

246-086-001-007C

HLWP

Plug Number (T2): 3b

**PANAMERA****3.0 D (184 kW | 3.0 Litre)**

08.11 → MCR.CC

246-086-001-007C

HLWP

Plug Number (T2): 3b

**3.6 (220 kW | 3.6 Litre)**

05.10 → M 46.20

246-086-001-007C

HLWP

Plug Number (T2): 3b

**3.6 4 (220 kW | 3.6 Litre)**

05.10 → M 46.40

246-086-001-007C

HLWP

Plug Number (T2): 3b

**4.8 4S (294 kW | 4.8 Litre)**

09.09 → M 48.40

246-086-001-007C

HLWP

Plug Number (T2): 3b

**4.8 S (294 kW | 4.8 Litre)**

09.09 → M 48.20

246-086-001-007C

HLWP

Plug Number (T2): 3b

**4.8 Turbo (368 kW | 4.8 Litre)**

09.09 → M 48.70

246-086-001-007C

HLWP

Plug Number (T2): 3b

**4.8 Turbo (397 kW | 4.8 Litre)**

08.10 → M 48.70

246-086-001-007C

HLWP

Plug Number (T2): 3b

**4.8 Turbo S (405 kW | 4.8 Litre)**

05.11 → M 48.70

246-086-001-007C

HLWP

Plug Number (T2): 3b

**RENAULT****CLIO I (B/C57\_, 5/357\_)****1.1 (34 kW | 1.1 Litre)**

01.91 → 09.98 C1E 700

X10-729-002-006

SWP-M-C

Plug Number (T2): 10; Vehicle Equipment (T31): with rear-window wiper (T34)

**1.2 (5/357Y, 5/357K) (40 kW | 1.2 Litre)**

01.96 → 09.98 D7F 730

X10-729-002-006

SWP-M-C

Plug Number (T2): 10; Vehicle Equipment (T31): with rear-window wiper (T34)

**1.2 (5/357Y, 5/357K) (43 kW | 1.2 Litre)**

01.96 → 09.98 D7F 730

X10-729-002-006

SWP-M-C

Plug Number (T2): 10; Vehicle Equipment (T31): with rear-window wiper (T34)

**1.2 (B/C/S577) (40 kW | 1.2 Litre)**

01.96 → 12.96 C3G 720

X10-729-002-006

SWP-M-C

Plug Number (T2): 10; Vehicle Equipment (T31): with rear-window wiper (T34)



			<b>VDO</b>		
Date	Engine Code	Chassis No.	Article No.	Product	Information

**RENAULT****CLIO I (B/C57\_, 5/357\_)****1.2 (B/C/S57A, B/C57S, 5/357F, 5/357J, 5/357L, 5/357R) (43 kW | 1.2 Litre)**

05.90 - 09.98	E7F 750, E7F 700, E7F 708		X10-729-002-006	SWP-M-C	Plug Number (T2): 10; Vehicle Equipment (T31): with rear-window wiper (T34)
---------------	---------------------------	--	-----------------	---------	-----------------------------------------------------------------------------

**1.2 (B/C57R) (40 kW | 1.2 Litre)**

01.91 - 01.96	E7F 706		X10-729-002-006	SWP-M-C	Plug Number (T2): 10; Vehicle Equipment (T31): with rear-window wiper (T34)
---------------	---------	--	-----------------	---------	-----------------------------------------------------------------------------

**1.4 (59 kW | 1.4 Litre)**

01.91 - 09.98	E7J 710, E7J 711		X10-729-002-006	SWP-M-C	Plug Number (T2): 10; Vehicle Equipment (T31): with rear-window wiper (T34)
---------------	------------------	--	-----------------	---------	-----------------------------------------------------------------------------

**1.4 (B/C57T, B/C57Y) (58 kW | 1.4 Litre)**

01.91 - 09.98	E7J 718, E7J 601, E7J 719, E7J 754		X10-729-002-006	SWP-M-C	Plug Number (T2): 10; Vehicle Equipment (T31): with rear-window wiper (T34)
---------------	------------------------------------	--	-----------------	---------	-----------------------------------------------------------------------------

**1.7 (B/C574) (68 kW | 1.7 Litre)**

01.91 - 12.93	F2N 770		X10-729-002-006	SWP-M-C	Plug Number (T2): 10; Vehicle Equipment (T31): with rear-window wiper (T34)
---------------	---------	--	-----------------	---------	-----------------------------------------------------------------------------

**1.8 (70 kW | 1.8 Litre)**

01.91 - 09.98	F3P 710		X10-729-002-006	SWP-M-C	Plug Number (T2): 10; Vehicle Equipment (T31): with rear-window wiper (T34)
---------------	---------	--	-----------------	---------	-----------------------------------------------------------------------------

**1.8 (B/C578) (66 kW | 1.8 Litre)**

08.94 - 09.98	F3P 754, F3P 755		X10-729-002-006	SWP-M-C	Plug Number (T2): 10; Vehicle Equipment (T31): with rear-window wiper (T34)
---------------	------------------	--	-----------------	---------	-----------------------------------------------------------------------------

**1.8 (B/C57C, B/C57U) (65 kW | 1.8 Litre)**

01.91 - 09.98	F3P 710, F3P 714		X10-729-002-006	SWP-M-C	Plug Number (T2): 10; Vehicle Equipment (T31): with rear-window wiper (T34)
---------------	------------------	--	-----------------	---------	-----------------------------------------------------------------------------

**1.8 16V (C57D) (99 kW | 1.8 Litre)**

01.91 - 03.96	F7P 722		X10-729-002-006	SWP-M-C	Plug Number (T2): 10; Vehicle Equipment (T31): with rear-window wiper (T34)
---------------	---------	--	-----------------	---------	-----------------------------------------------------------------------------

**1.8 Rsi (B/C579) (80 kW | 1.8 Litre)**

01.93 - 08.95	F3P 712		X10-729-002-006	SWP-M-C	Plug Number (T2): 10; Vehicle Equipment (T31): with rear-window wiper (T34)
---------------	---------	--	-----------------	---------	-----------------------------------------------------------------------------

**1.8 Rsi (B/C57H) (79 kW | 1.8 Litre)**

08.95 - 09.98	F3P 758		X10-729-002-006	SWP-M-C	Plug Number (T2): 10; Vehicle Equipment (T31): with rear-window wiper (T34)
---------------	---------	--	-----------------	---------	-----------------------------------------------------------------------------

**1.9 D (B/C/S576, B/C/S57L) (47 kW | 1.9 Litre)**

01.91 - 09.98	F8Q 730, F8Q 732		X10-729-002-006	SWP-M-C	Plug Number (T2): 10; Vehicle Equipment (T31): with rear-window wiper (T34)
---------------	------------------	--	-----------------	---------	-----------------------------------------------------------------------------

**1.9 D (40 kW | 1.9 Litre)**

01.97 - 09.98	F8Q 678		X10-729-002-006	SWP-M-C	Plug Number (T2): 10; Vehicle Equipment (T31): with rear-window wiper (T34)
---------------	---------	--	-----------------	---------	-----------------------------------------------------------------------------

**Williams (B/C57M) (108 kW | 2.0 Litre)**

01.94 - 09.98	F7R 700		X10-729-002-006	SWP-M-C	Plug Number (T2): 10; Vehicle Equipment (T31): with rear-window wiper (T34)
---------------	---------	--	-----------------	---------	-----------------------------------------------------------------------------

**ESPACE II (J/S63\_)****2.0 (J636) (76 kW | 2.0 Litre)**

01.91 - 10.96	J7R 768		X10-729-002-006	SWP-M-C	Plug Number (T2): 10
---------------	---------	--	-----------------	---------	----------------------

**2.1 TD (J633, J634, J/S635, J/S63D) (65 kW | 2.1 Litre)**

01.91 - 10.96	J8S 610, J8S 772, J8S 776, J8S 778		X10-729-002-006	SWP-M-C	Plug Number (T2): 10
---------------	------------------------------------	--	-----------------	---------	----------------------

**2.1 TD (J63E) (66 kW | 2.1 Litre)**

11.94 - 10.96	J8S 612		X10-729-002-006	SWP-M-C	Plug Number (T2): 10
---------------	---------	--	-----------------	---------	----------------------

**2.2 (J/S637, J63G) (79 kW | 2.2 Litre)**

01.91 - 10.96	J7T 772, J7T 773, J7T 776		X10-729-002-006	SWP-M-C	Plug Number (T2): 10
---------------	---------------------------	--	-----------------	---------	----------------------

**2.2 4x4 (J/S637, J63G) (79 kW | 2.2 Litre)**

03.91 - 12.96	J7T 772, J7T 773		X10-729-002-006	SWP-M-C	Plug Number (T2): 10
---------------	------------------	--	-----------------	---------	----------------------

**2.8 V6 (J638, J63J) (110 kW | 2.8 Litre)**

01.91 - 10.96	Z7W 712, Z7W 713, Z7W 717		X10-729-002-006	SWP-M-C	Plug Number (T2): 10
---------------	---------------------------	--	-----------------	---------	----------------------

**KANGOO Express (FC0/1\_)****1.2 (FC01, FC0A, FC0F) (43 kW | 1.2 Litre)**

08.97 -	D7F 710, D7F 720, D7F 722, D7F 726, D7F 744, D7F 746		X10-729-002-006	SWP-M-C	Plug Number (T2): 10
---------	------------------------------------------------------	--	-----------------	---------	----------------------





			<b>VDO</b>		
Date	Engine Code	Chassis No.	Article No.	Product	Information

**RENAULT****KANGOO Express (FC0/1\_)****1.2 16V (FC05) (55 kW | 1.2 Litre)**

10.01 →	D4F 712, D4F 714, D4F 730		X10-729-002-006	SWP-M-C	Plug Number (T2): 10
---------	---------------------------	--	-----------------	---------	----------------------

**1.4 (FC0C, FC0B, FC0H, FC0M) (55 kW | 1.4 Litre)**

08.97 →	E7J 780, E7J 634, E7J 635, K7J 701		X10-729-002-006	SWP-M-C	Plug Number (T2): 10
---------	---------------------------------------	--	-----------------	---------	----------------------

**1.5 dCi (FC07, FC1R) (48 kW | 1.5 Litre)**

12.01 →	K9K 700, K9K 702, K9K 704		X10-729-002-006	SWP-M-C	Plug Number (T2): 10
---------	---------------------------	--	-----------------	---------	----------------------

**1.6 16V (70 kW | 1.6 Litre)**

10.01 →	K4M 752		X10-729-002-006	SWP-M-C	Plug Number (T2): 10
---------	---------	--	-----------------	---------	----------------------

**1.6 16V 4x4 (FC0L, FC0P, FC0S) (70 kW | 1.6 Litre)**

10.01 →	K4M 750, K4M 752, K4M 753		X10-729-002-006	SWP-M-C	Plug Number (T2): 10
---------	---------------------------	--	-----------------	---------	----------------------

**1.9 dCi 4x4 (FC0V) (59 kW | 1.9 Litre)**

10.01 →	F9Q 790, F9Q 782		X10-729-002-006	SWP-M-C	Plug Number (T2): 10
---------	------------------	--	-----------------	---------	----------------------

**1.9 dTi (FC0U) (59 kW | 1.9 Litre)**

02.00 →	F9Q 780		X10-729-002-006	SWP-M-C	Plug Number (T2): 10
---------	---------	--	-----------------	---------	----------------------

**D 55 1.9 (FC0D) (40 kW | 1.9 Litre)**

08.97 →	F8Q 662		X10-729-002-006	SWP-M-C	Plug Number (T2): 10
---------	---------	--	-----------------	---------	----------------------

**D 65 1.9 (FC0E, FC02, FC0J, FC0N) (47 kW | 1.9 Litre)**

08.97 →	F8Q 630, F8Q 632		X10-729-002-006	SWP-M-C	Plug Number (T2): 10
---------	------------------	--	-----------------	---------	----------------------

**MEGANE I Classic (LA0/1\_)****1.4 (LA0E, LA0V) (55 kW | 1.4 Litre)**

09.96 →	E7J 764, E7J 626		X10-729-002-006	SWP-M-C	Plug Number (T2): 10; T27: 4
---------	------------------	--	-----------------	---------	------------------------------

**1.4 16V (LA0D, LA1H, IA0W, LA10) (70 kW | 1.4 Litre)**

03.99 →	K4J 714, K4J 750		X10-729-002-006	SWP-M-C	Plug Number (T2): 10; T27: 4
---------	------------------	--	-----------------	---------	------------------------------

**1.6 16V (La04, LA11, LA0B, LA1C, LA1J) (79 kW | 1.6 Litre)**

03.99 →	K4M 700, K4M 701, K4M 708		X10-729-002-006	SWP-M-C	Plug Number (T2): 10; T27: 4
---------	---------------------------	--	-----------------	---------	------------------------------

**1.6 e (LA0F, LA0S) (66 kW | 1.6 Litre)**

09.96 → 03.99	K7M 702, K7M 703, K7M 790		X10-729-002-006	SWP-M-C	Plug Number (T2): 10; T27: 4
---------------	---------------------------	--	-----------------	---------	------------------------------

**1.6 i (LA0L) (55 kW | 1.6 Litre)**

09.96 → 03.99	K7M 720		X10-729-002-006	SWP-M-C	Plug Number (T2): 10; T27: 4
---------------	---------	--	-----------------	---------	------------------------------

**1.8 16V (LA06, LA12, LA1A, LA1M, LA1R) (85 kW | 1.8 Litre)**

01.01 →	F4P 720, F4P 722		X10-729-002-006	SWP-M-C	Plug Number (T2): 10; T27: 4
---------	------------------	--	-----------------	---------	------------------------------

**1.9 D (LA0A, LA0U) (47 kW | 1.9 Litre)**

09.96 →	F8Q 620, F8Q 624		X10-729-002-006	SWP-M-C	Plug Number (T2): 10; T27: 4
---------	------------------	--	-----------------	---------	------------------------------

**1.9 dCi (LA05, LA1F) (75 kW | 1.9 Litre)**

02.01 →	F9Q 732, F9Q 738, F9Q 733		X10-729-002-006	SWP-M-C	Plug Number (T2): 10; T27: 4
---------	---------------------------	--	-----------------	---------	------------------------------

**1.9 dT (LA0K, LA0Y) (66 kW | 1.9 Litre)**

09.96 →	F8Q 784, F8Q 786		X10-729-002-006	SWP-M-C	Plug Number (T2): 10; T27: 4
---------	------------------	--	-----------------	---------	------------------------------

**1.9 dTi (LA08, LA0N) (72 kW | 1.9 Litre)**

03.97 → 02.01	F9Q 731, F9Q 730, F9Q 734, F9Q 736		X10-729-002-006	SWP-M-C	Plug Number (T2): 10; T27: 4
---------------	---------------------------------------	--	-----------------	---------	------------------------------

**1.9 dTi (LA1U) (59 kW | 1.9 Litre)**

02.01 →	F9Q 744		X10-729-002-006	SWP-M-C	Plug Number (T2): 10; T27: 4
---------	---------	--	-----------------	---------	------------------------------

**1.9 TDI (69 kW | 1.9 Litre)**

09.96 →	F8Q 784		X10-729-002-006	SWP-M-C	Plug Number (T2): 10; T27: 4
---------	---------	--	-----------------	---------	------------------------------

**2.0 i (LA07, LA0G) (84 kW | 2.0 Litre)**

09.96 →	F3R 750, F3R 751, F3R 752, F3R 791, F3R 796, F3R 797, F3R 798		X10-729-002-006	SWP-M-C	Plug Number (T2): 10; T27: 4
---------	---------------------------------------------------------------------	--	-----------------	---------	------------------------------

**2.0 i (LA0G) (80 kW | 2.0 Litre)**

03.99 →	F3R 750, F3R 751, F3R 752, F3R 791, F3R 796, F3R 797, F3R 798		X10-729-002-006	SWP-M-C	Plug Number (T2): 10; T27: 4
---------	---------------------------------------------------------------------	--	-----------------	---------	------------------------------

**MEGANE I Cabriolet (EA0/1\_)****1.4 16V (EA0D, EA1H, EA0W, EA10) (70 kW | 1.4 Litre)**

03.99 →	K4J 714, K4J 750		X10-729-002-006	SWP-M-C	Plug Number (T2): 10
---------	------------------	--	-----------------	---------	----------------------

**1.6 16V (EA0B, EA04, EA11) (79 kW | 1.6 Litre)**

03.99 →	K4M 700, K4M 701, K4M 708		X10-729-002-006	SWP-M-C	Plug Number (T2): 10
---------	---------------------------	--	-----------------	---------	----------------------

**1.6 e (EA0F) (66 kW | 1.6 Litre)**

10.96 → 03.99	K7M 702, K7M 703		X10-729-002-006	SWP-M-C	Plug Number (T2): 10
---------------	------------------	--	-----------------	---------	----------------------



			<b>VDO</b>		
Date	Engine Code	Chassis No.	Article No.	Product	Information

**RENAULT****MEGANE I Cabriolet (EA0/1\_)****2.0 (EA0G) (84 kW | 2.0 Litre)**

04.97 - F3R 750 X10-729-002-006 SWP-M-C Plug Number (T2): 10

**2.0 16V (102 kW | 2.0 Litre)**

01.02 - F4R 770, F4R 746 X10-729-002-006 SWP-M-C Plug Number (T2): 10

**2.0 16V (EA0H) (108 kW | 2.0 Litre)**

10.96 - 11.99 F7R 710, F7R 714 X10-729-002-006 SWP-M-C Plug Number (T2): 10

**2.0 16V IDE (EA03, EA0P, EA14) (103 kW | 2.0 Litre)**

11.99 - F5R 740 X10-729-002-006 SWP-M-C Plug Number (T2): 10

**2.0 i (EA0G) (80 kW | 2.0 Litre)**

03.99 - F3R 791, F3R 796 X10-729-002-006 SWP-M-C Plug Number (T2): 10

**RAPID Box (F40\_, G40\_)****1.0 (27 kW | 1.0 Litre)**

09.91 - 05.92 C1C 706 X10-729-002-006 SWP-M-C Plug Number (T2): 10; T30: Transporter

**1.1 (F401) (33 kW | 1.1 Litre)**09.91 - 04.95 C1E 750, C1E 752, C1E 754,  
C1E 760, C1E 792, C1E 762 X10-729-002-006 SWP-M-C Plug Number (T2): 10; T30: Transporter**1.1 (F40H) (33 kW | 1.1 Litre)**

09.91 - 09.91 C1E 756 X10-729-002-006 SWP-M-C Plug Number (T2): 10; T30: Transporter

**1.2 (F406, G40A) (40 kW | 1.2 Litre)**

09.91 - 03.98 C3G 710, C3G 712 X10-729-002-006 SWP-M-C Plug Number (T2): 10; T30: Transporter

**1.4 (F407) CAT (43 kW | 1.4 Litre)**09.91 - 03.98 C3J 702, C3J 700, C3J 760,  
C3J 762 X10-729-002-006 SWP-M-C Plug Number (T2): 10; T30: Transporter**1.4 (F40D) (58 kW | 1.4 Litre)**

01.94 - 03.98 E7J 728 X10-729-002-006 SWP-M-C Plug Number (T2): 10; T30: Transporter

**1.4 (F40U, F40V) (55 kW | 1.4 Litre)**09.91 - 03.98 E7J 720, E7J 724, E7J 726,  
E7J 773 X10-729-002-006 SWP-M-C Plug Number (T2): 10; T30: Transporter**1.6 D (F404) (40 kW | 1.6 Litre)**09.91 - 08.98 F8M 720, F8M 730, F8M 736,  
F8M 760 X10-729-002-006 SWP-M-C Plug Number (T2): 10; T30: Transporter**1.9 D (F40P, F40N, F40E) (47 kW | 1.9 Litre)**09.91 - 03.98 F8Q 722, F8Q 724, F8Q 774,  
F8Q 776, F8Q 646 X10-729-002-006 SWP-M-C Plug Number (T2): 10; T30: Transporter**1.9 D (F40R) (40 kW | 1.9 Litre)**

09.94 - 03.98 F8Q 640, F8Q 682 X10-729-002-006 SWP-M-C Plug Number (T2): 10; T30: Transporter

**SAFRANE I (B54\_)****2.0 (B540) (77 kW | 2.0 Litre)**

11.92 - 07.96 J7R 732, J7R 733 X10-729-002-006 SWP-M-C Plug Number (T2): 10

**2.0 12V (B542, B54E) (97 kW | 2.0 Litre)**

04.92 - 07.96 J7R 734, J7R 735 X10-729-002-006 SWP-M-C Plug Number (T2): 10

**2.1 dT (B546) (65 kW | 2.1 Litre)**

11.93 - 07.96 J8S 760 X10-729-002-006 SWP-M-C Plug Number (T2): 10

**2.2 (B541) (79 kW | 2.2 Litre)**

04.92 - 07.96 J7T 762 X10-729-002-006 SWP-M-C Plug Number (T2): 10

**2.2 (B543) (101 kW | 2.2 Litre)**

04.92 - 07.96 J7T 760, J7T 761 X10-729-002-006 SWP-M-C Plug Number (T2): 10

**2.5 dT (B548) (83 kW | 2.5 Litre)**

12.92 - 07.96 S8U 762, S8U 763 X10-729-002-006 SWP-M-C Plug Number (T2): 10

**3.0 Biturbo 4x4 (B545) (193 kW | 3.0 Litre)**

02.93 - 07.96 Z7X 726 X10-729-002-006 SWP-M-C Plug Number (T2): 10

**3.0 V6 (B54B, B544) (123 kW | 3.0 Litre)**

12.92 - 07.96 Z7X 721, Z7X 722, Z7X 723 X10-729-002-006 SWP-M-C Plug Number (T2): 10

**3.0 V6 4x4 (B54B, B544) (123 kW | 3.0 Litre)**

12.92 - 07.96 Z7X 721, Z7X 722, Z7X 723 X10-729-002-006 SWP-M-C Plug Number (T2): 10

**SAFRANE II (B54\_)****2.0 16V (B54L) (100 kW | 2.0 Litre)**

07.96 - 12.00 N7Q 710, N7Q 711 X10-729-002-006 SWP-M-C Plug Number (T2): 10

**2.2 dT (B54G) (83 kW | 2.2 Litre)**

07.96 - 12.00 G8T 740 X10-729-002-006 SWP-M-C Plug Number (T2): 10



			<b>VDO</b>		
Date	Engine Code	Chassis No.	Article No.	Product	Information

**RENAULT****SAFRANE II (B54\_)****2.5 20V (B54F) (121 kW | 2.5 Litre)**

07.96 - 12.00 N7U 700, N7U 701

X10-729-002-006

SWP-M-C

Plug Number (T2): 10

**2.9 24V (B54N) (140 kW | 2.9 Litre)**

03.99 - 12.00 L7X 713

X10-729-002-006

SWP-M-C

Plug Number (T2): 10

**3.0 V6 (B54M) (123 kW | 3.0 Litre)**

07.96 - 12.00 Z7X 755

X10-729-002-006

SWP-M-C

Plug Number (T2): 10

**SPORT SPIDER (EF0\_)****2.0 (108 kW | 2.0 Litre)**

12.95 - 08.96 F7R 710

X10-729-002-006

SWP-M-C

Plug Number (T2): 10

**2.0 16V (110 kW | 2.0 Litre)**

03.95 - 10.99 F7R 710

X10-729-002-006

SWP-M-C

Plug Number (T2): 10

**19 I (B/C53\_)****1.2 (40 kW | 1.2 Litre)**

07.91 - 12.92 C1G 730

X10-729-002-006

SWP-M-C

Plug Number (T2): 10; Vehicle Equipment (T31): with rear-window wiper (T34)

**1.4 (59 kW | 1.4 Litre)**

07.91 - 12.92 E6J 700, E6J 701

X10-729-002-006

SWP-M-C

Plug Number (T2): 10; Vehicle Equipment (T31): with rear-window wiper (T34)

**1.4 (B/C532) CAT (43 kW | 1.4 Litre)**

07.91 - 04.92 C3J 710

X10-729-002-006

SWP-M-C

Plug Number (T2): 10; Vehicle Equipment (T31): with rear-window wiper (T34)

**1.7 (B/C53B) (54 kW | 1.7 Litre)**

07.91 - 04.92 F3N 740, F3N 741

X10-729-002-006

SWP-M-C

Plug Number (T2): 10; Vehicle Equipment (T31): with rear-window wiper (T34)

**1.7 (B/C53C) (66 kW | 1.7 Litre)**

07.91 - 04.92 F3N 742, F3N 743

X10-729-002-006

SWP-M-C

Plug Number (T2): 10; Vehicle Equipment (T31): with rear-window wiper (T34)

**1.8 16V (B/C53D) (99 kW | 1.8 Litre)**

07.91 - 04.92 F7P 704

X10-729-002-006

SWP-M-C

Plug Number (T2): 10; Vehicle Equipment (T31): with rear-window wiper (T34)

**1.9 D (B/C534, B/C53J) (47 kW | 1.9 Litre)**

07.91 - 04.92 F8Q 706, F8Q 742

X10-729-002-006

SWP-M-C

Plug Number (T2): 10; Vehicle Equipment (T31): with rear-window wiper (T34)

**19 I Chamade (L53\_)****1.2 (40 kW | 1.2 Litre)**

07.91 - 12.92 C1G 730

X10-729-002-006

SWP-M-C

Plug Number (T2): 10

**1.4 (L532, L53P) (43 kW | 1.4 Litre)**

07.91 - 04.92 C3J 710, C2J 772

X10-729-002-006

SWP-M-C

Plug Number (T2): 10

**1.7 (L53B) (54 kW | 1.7 Litre)**

07.91 - 04.92 F3N 740, F3N 741

X10-729-002-006

SWP-M-C

Plug Number (T2): 10

**1.7 (L53C) (66 kW | 1.7 Litre)**

07.91 - 04.92 F3N 742, F3N 743

X10-729-002-006

SWP-M-C

Plug Number (T2): 10

**1.8 16V (L53D) (99 kW | 1.8 Litre)**

07.91 - 04.92 F7P 704

X10-729-002-006

SWP-M-C

Plug Number (T2): 10

**1.9 D (L534, L53J) (47 kW | 1.9 Litre)**

07.91 - 04.92 F8Q 706, F8Q 742

X10-729-002-006

SWP-M-C

Plug Number (T2): 10

**21 (B48\_)****1.7 (B48F) (54 kW | 1.7 Litre)**

04.91 - 10.92 F3N 726

X10-729-002-006

SWP-M-C

Plug Number (T2): 10

**21 Saloon (L48\_)****2.0 (78 kW | 2.0 Litre)**

05.91 - 10.93 J6R 758

X10-729-002-006

SWP-M-C

Plug Number (T2): 10

**21 Estate (K48\_)****1.7 (K/S481) (55 kW | 1.7 Litre)**

07.91 - 03.93 F2N 712

X10-729-002-006

SWP-M-C

Plug Number (T2): 10

**1.7 (K48F) CAT (54 kW | 1.7 Litre)**

07.91 - 06.93 F3N 726

X10-729-002-006

SWP-M-C

Plug Number (T2): 10



			<b>VDO</b>		
Date	Engine Code	Chassis No.	Article No.	Product	Information

**RENAULT****21 Estate (K48\_)****1.9 D (47 kW | 1.9 Litre)**

07.91 - 08.94	F8Q 710		X10-729-002-006	SWP-M-C	Plug Number (T2): 10
---------------	---------	--	-----------------	---------	----------------------

**TRAFIC Platform/Chassis (PXX)****1.7 (50 kW | 1.7 Litre)**

05.89 - 08.94	F1N 722		X10-729-002-006	SWP-M-C	Plug Number (T2): 10
---------------	---------	--	-----------------	---------	----------------------

**2.0 (60 kW | 2.0 Litre)**

03.89 - 12.91	J5R 726		X10-729-002-006	SWP-M-C	Plug Number (T2): 10
---------------	---------	--	-----------------	---------	----------------------

**2.0 [RWD] (59 kW | 2.0 Litre)**

05.89 - 10.97	J5R 726		X10-729-002-006	SWP-M-C	Plug Number (T2): 10
---------------	---------	--	-----------------	---------	----------------------

**2.1 D (47 kW | 2.1 Litre)**

09.94 - 04.98	J8S 620		X10-729-002-006	SWP-M-C	Plug Number (T2): 10
---------------	---------	--	-----------------	---------	----------------------

**2.1 D [RWD] (43 kW | 2.1 Litre)**

05.89 - 06.94	852 720		X10-729-002-006	SWP-M-C	Plug Number (T2): 10
---------------	---------	--	-----------------	---------	----------------------

**2.1 D [RWD] (47 kW | 2.1 Litre)**

06.94 - 10.97	J8S 620, J8S 758		X10-729-002-006	SWP-M-C	Plug Number (T2): 10
---------------	------------------	--	-----------------	---------	----------------------

**2.2 (70 kW | 2.2 Litre)**

05.89 - 06.94	J7T 780		X10-729-002-006	SWP-M-C	Plug Number (T2): 10
---------------	---------	--	-----------------	---------	----------------------

**2.2 (74 kW | 2.2 Litre)**

09.94 - 04.98	J7T 600		X10-729-002-006	SWP-M-C	Plug Number (T2): 10
---------------	---------	--	-----------------	---------	----------------------

**2.2 4x4 (74 kW | 2.2 Litre)**

09.94 - 04.98	J7T 600		X10-729-002-006	SWP-M-C	Plug Number (T2): 10
---------------	---------	--	-----------------	---------	----------------------

**2.5 D (51 kW | 2.5 Litre)**

05.89 - 03.01	8140.61.240, S8U 720, S8U 722		X10-729-002-006	SWP-M-C	Plug Number (T2): 10
---------------	-------------------------------	--	-----------------	---------	----------------------

**2.5 D (55 kW | 2.5 Litre)**

05.98 - 03.01	S8U 758, S8U 780		X10-729-002-006	SWP-M-C	Plug Number (T2): 10
---------------	------------------	--	-----------------	---------	----------------------

**2.5 D (56 kW | 2.5 Litre)**

03.89 - 08.94	S8U 750		X10-729-002-006	SWP-M-C	Plug Number (T2): 10
---------------	---------	--	-----------------	---------	----------------------

**2.5 D (58 kW | 2.5 Litre)**

09.94 - 04.98	S8U 758		X10-729-002-006	SWP-M-C	Plug Number (T2): 10
---------------	---------	--	-----------------	---------	----------------------

**2.5 D 4x4 (56 kW | 2.5 Litre)**

03.89 - 08.94	S8U 750		X10-729-002-006	SWP-M-C	Plug Number (T2): 10
---------------	---------	--	-----------------	---------	----------------------

**2.5 D 4x4 (58 kW | 2.5 Litre)**

09.94 - 01.99	S8U 758		X10-729-002-006	SWP-M-C	Plug Number (T2): 10
---------------	---------	--	-----------------	---------	----------------------

**SAAB****90****2.0 (74 kW | 2.0 Litre)**

08.84 - 08.87	B 20 I		246-082-008-014C	SWP-M-C	Plug Number (T2): 1
---------------	--------	--	------------------	---------	---------------------

08.84 - 12.85	B 20 I	E600792-	246-082-008-014C	SWP-M-C	Plug Number (T2): 1
---------------	--------	----------	------------------	---------	---------------------

**900 I Combi Coupe****2.0 -16 (93 kW | 2.0 Litre)**

01.89 - 08.92	B202I		246-082-001-001C	SWP-M-C	Plug Number (T2): 2
---------------	-------	--	------------------	---------	---------------------

**2.0 c (74 kW | 2.0 Litre)**

09.83 - 12.88	B 20, B201XC		246-082-001-001C	SWP-M-C	Plug Number (T2): 2
---------------	--------------	--	------------------	---------	---------------------

09.79 - 12.88	B 20, B201XC	214383- -499999	246-082-008-014C	SWP-M-C	Plug Number (T2): 1
---------------	--------------	--------------------	------------------	---------	---------------------

10.80 - 12.83	B 20, B201XC		246-082-008-014C	SWP-M-C	Plug Number (T2): 1
---------------	--------------	--	------------------	---------	---------------------

**2.0 c (79 kW | 2.0 Litre)**

09.83 - 08.84	BT 20, B20T		246-082-001-001C	SWP-M-C	Plug Number (T2): 2
---------------	-------------	--	------------------	---------	---------------------

**2.0 i (81 kW | 2.0 Litre)**

09.85 - 12.89	B201		246-082-001-001C	SWP-M-C	Plug Number (T2): 2
---------------	------	--	------------------	---------	---------------------

**2.0 S Turbo-16 (104 kW | 2.0 Litre)**

09.91 - 06.93	B202S		246-082-001-001C	SWP-M-C	Plug Number (T2): 2
---------------	-------	--	------------------	---------	---------------------

**2.0 Turbo (107 kW | 2.0 Litre)**

09.83 - 07.85	BSI 20, B201S		246-082-001-001C	SWP-M-C	Plug Number (T2): 2
---------------	---------------	--	------------------	---------	---------------------

09.78 - 07.85	BSI 20, B201S		246-082-008-014C	SWP-M-C	Plug Number (T2): 1
---------------	---------------	--	------------------	---------	---------------------

10.80 - 12.83	BSI 20, B201S		246-082-008-014C	SWP-M-C	Plug Number (T2): 1
---------------	---------------	--	------------------	---------	---------------------



			<b>VDO</b>		
Date	Engine Code	Chassis No.	Article No.	Product	Information

**SAAB****900 I Combi Coupe****2.0 Turbo-16 (118 kW | 2.0 Litre)**

11.85 - 06.93 | B202XL | 246-082-001-001C | SWP-M-C | Plug Number (T2): 2

**2.0 Turbo-16 S (129 kW | 2.0 Litre)**

02.84 - 12.88 | B202XL | 246-082-001-001C | SWP-M-C | Plug Number (T2): 2

**2.0 Turbo-16 S CAT (125 kW | 2.0 Litre)**

01.89 - 06.93 | B202XL | 246-082-001-001C | SWP-M-C | Plug Number (T2): 2

**900 I (AC4, AM4)****2.0 -16 (93 kW | 2.0 Litre)**

01.89 - 06.93 | B202I | 246-082-001-001C | SWP-M-C | Plug Number (T2): 2

**2.0 c (79 kW | 2.0 Litre)**

09.83 - 08.84 | BT 20, B20T | 246-082-001-001C | SWP-M-C | Plug Number (T2): 2

11.80 - 08.84 | BT 20, B20T | 246-082-008-014C | SWP-M-C | Plug Number (T2): 1

11.80 - 12.83 | BT 20, B20T | 246-082-008-014C | SWP-M-C | Plug Number (T2): 1

**2.0 S Turbo-16 (107 kW | 2.0 Litre)**

01.92 - 06.93 | B202S | 246-082-001-001C | SWP-M-C | Plug Number (T2): 2

**2.0 Turbo (107 kW | 2.0 Litre)**

09.83 - 07.85 | BSI 20, B201S | 246-082-001-001C | SWP-M-C | Plug Number (T2): 2

10.80 - 07.85 | BSI 20, B201S | 246-082-008-014C | SWP-M-C | Plug Number (T2): 1

10.81 - 12.83 | BSI 20, B201S | 246-082-008-014C | SWP-M-C | Plug Number (T2): 1

**2.0 Turbo-16 S (129 kW | 2.0 Litre)**

01.84 - 12.88 | B202XL | 246-082-001-001C | SWP-M-C | Plug Number (T2): 2

**900 I Convertible****2.0 -16 (93 kW | 2.0 Litre)**

01.90 - 06.93 | B202I | 246-082-001-001C | SWP-M-C | Plug Number (T2): 2

**2.0 S Turbo-16 (104 kW | 2.0 Litre)**

09.91 - 06.93 | B202S | 246-082-001-001C | SWP-M-C | Plug Number (T2): 2

**2.0 Turbo-16 (118 kW | 2.0 Litre)**

11.86 - 06.93 | B202XL | 246-082-001-001C | SWP-M-C | Plug Number (T2): 2

**2.0 Turbo-16 S (129 kW | 2.0 Litre)**

01.89 - 06.93 | B202XL | 246-082-001-001C | SWP-M-C | Plug Number (T2): 2

**9000 Hatchback****2.0 -16 (92 kW | 2.0 Litre)**

03.86 - 12.88 | B202XI | 246-082-001-001C | SWP-M-C | Plug Number (T2): 2

12.85 - 12.88 | B202XI (KAT) | 246-082-008-014C | SWP-M-C | Plug Number (T2): 1

**2.0 -16 (94 kW | 2.0 Litre)**

12.85 - 08.88 | B202XI | 246-082-008-014C | SWP-M-C | Plug Number (T2): 1

**2.0 -16 Turbo (118 kW | 2.0 Litre)**

09.84 - 07.89 | B202XL | 246-082-001-001C | SWP-M-C | Plug Number (T2): 2

**2.0 -16 Turbo (120 kW | 2.0 Litre)**

05.88 - 12.91 | B202XL | 246-082-001-001C | SWP-M-C | Plug Number (T2): 2

**2.0 -16 Turbo (129 kW | 2.0 Litre)**

09.84 - 12.91 | B202XL | 246-082-008-014C | SWP-M-C | Plug Number (T2): 1

**2.0 16v (143 kW | 2.0 Litre)**

09.89 - 01.90 | 246-082-008-014C | SWP-M-C | Plug Number (T2): 1

**2.3 -16 CS (107 kW | 2.3 Litre)**

08.90 - 12.91 | B234I | 246-082-001-001C | SWP-M-C | Plug Number (T2): 2

**2.3 -16 Turbo (143 kW | 2.3 Litre)**

07.91 - 12.91 | B234L | 246-082-001-001C | SWP-M-C | Plug Number (T2): 2

**9000****2.0 -16 (94 kW | 2.0 Litre)**

08.90 - 12.91 | B202I | 246-082-001-001C | SWP-M-C | Plug Number (T2): 2

**2.0 -16 Turbo (129 kW | 2.0 Litre)**

04.85 - 12.91 | B202XL | 246-082-008-014C | SWP-M-C | Plug Number (T2): 1; T28: Rear (T29)

**2.3 -16 CD (107 kW | 2.3 Litre)**

01.90 - 12.91 | B234I | 246-082-001-001C | SWP-M-C | Plug Number (T2): 2

**2.3 -16 Turbo (143 kW | 2.3 Litre)**

09.90 - 12.91 | B234L | 246-082-001-001C | SWP-M-C | Plug Number (T2): 2



			<b>VDO</b>		
Date	Engine Code	Chassis No.	Article No.	Product	Information

**SEAT****ALHAMBRA (7V8, 7V9)****1.8 T 20V (110 kW | 1.8 Litre)**

05.98 - 03.10	AWC, AJH		246-083-002-014G	SWP-D-C	Plug Number (T2): 6
10.97 - 03.10	AWC, AJH		246-083-002-022G	SWP-D-C	
10.97 - 03.10	AWC, AJH		246-086-001-002C	HLWP	Plug Number (T2): 3

**1.9 TDI (110 kW | 1.9 Litre)**

05.05 - 05.07	ARL, BTB		246-083-002-022G	SWP-D-C	
05.05 - 05.07	ARL, BTB		246-086-001-007C	HLWP	Plug Number (T2): 3b

**1.9 TDI (66 kW | 1.9 Litre)**

04.96 - 06.96	1Z, AHU, ANU		246-083-002-014G	SWP-D-C	Plug Number (T2): 6
04.96 - 03.10	1Z, AHU, ANU		246-083-002-022G	SWP-D-C	
04.96 - 03.10	1Z, AHU, ANU		246-086-001-002C	HLWP	Plug Number (T2): 3

**1.9 TDI (81 kW | 1.9 Litre)**

06.00 - 06.00	AFN, AVG		246-083-002-022G	SWP-D-C	
08.96 - 06.00	AFN, AVG		246-086-001-002C	HLWP	Plug Number (T2): 3

**1.9 TDI (85 kW | 1.9 Litre)**

06.00 - 03.10	AUY, BVK		246-083-002-022G	SWP-D-C	
06.00 - 03.10	AUY, BVK		246-086-001-002C	HLWP	Plug Number (T2): 3

**1.9 TDI (96 kW | 1.9 Litre)**

11.02 - 11.08	ASZ		246-083-002-022G	SWP-D-C	
11.02 - 11.08	ASZ		246-086-001-007C	HLWP	Plug Number (T2): 3b

**1.9 TDI 4motion (85 kW | 1.9 Litre)**

06.00 - 03.10	AUY, BVK	- 1 - 500 001 ->	246-083-002-022G	SWP-D-C	
06.00 - 03.10	AUY, BVK		246-086-001-002C	HLWP	Plug Number (T2): 3

**2.0 i (85 kW | 2.0 Litre)**

04.96 - 03.10	ADY, ATM		246-083-002-014G	SWP-D-C	Plug Number (T2): 6
04.96 - 03.10	ADY, ATM		246-083-002-022G	SWP-D-C	
04.96 - 03.10	ADY, ATM		246-086-001-002C	HLWP	Plug Number (T2): 3

**2.0 TDI (103 kW | 2.0 Litre)**

11.05 - 03.10	BRT		246-083-002-022G	SWP-D-C	T26: 1J0 955 665 H
11.05 - 03.10	BRT		246-086-001-007C	HLWP	Plug Number (T2): 3b

**2.8 V6 (150 kW | 2.8 Litre)**

06.00 - 03.10	AYL, AUE		246-083-002-022G	SWP-D-C	
06.00 - 03.10	AYL, AUE		246-086-001-002C	HLWP	Plug Number (T2): 3

**2.8 V6 4motion (150 kW | 2.8 Litre)**

06.00 - 03.10	AYL, AUE		246-083-002-022G	SWP-D-C	
06.00 - 03.10	AYL, AUE		246-086-001-002C	HLWP	Plug Number (T2): 3

**ALHAMBRA (710)****1.4 TSI (110 kW | 1.4 Litre)**

06.10 -	CAVA		246-086-001-007C	HLWP	Plug Number (T2): 3b
---------	------	--	------------------	------	----------------------

**2.0 TDI (103 kW | 2.0 Litre)**

06.10 -	CFFB		246-086-001-007C	HLWP	Plug Number (T2): 3b
---------	------	--	------------------	------	----------------------

**2.0 TDI (125 kW | 2.0 Litre)**

06.10 -	CFGB		246-086-001-007C	HLWP	Plug Number (T2): 3b
---------	------	--	------------------	------	----------------------

**ALTEA (5P1)****1.2 TSI (77 kW | 1.2 Litre)**

04.10 -	CBZB		246-083-002-022G	SWP-D-C	
04.10 -	CBZB		246-086-001-007C	HLWP	Plug Number (T2): 3b

**1.4 16V (63 kW | 1.4 Litre)**

05.06 -	BXW, CGGB		246-083-002-022G	SWP-D-C	
05.06 -	BXW, CGGB		246-086-001-007C	HLWP	Plug Number (T2): 3b

**1.4 TSI (92 kW | 1.4 Litre)**

11.07 -	CAXC		246-083-002-022G	SWP-D-C	
11.07 -	CAXC		246-086-001-007C	HLWP	Plug Number (T2): 3b

**1.6 (75 kW | 1.6 Litre)**

03.04 -	BGU, BSE, BSF, CMXA, CCSA		246-083-002-022G	SWP-D-C	
03.04 -	BGU, BSE, BSF, CMXA, CCSA		246-086-001-007C	HLWP	Plug Number (T2): 3b

**1.6 LPG (75 kW | 1.6 Litre)**

09.09 -	CHGA		246-083-002-022G	SWP-D-C	
09.09 -	CHGA		246-086-001-007C	HLWP	Plug Number (T2): 3b

**1.6 TDI (66 kW | 1.6 Litre)**

11.10 -	CAYB		246-083-002-022G	SWP-D-C	
---------	------	--	------------------	---------	--



			<b>VDO</b>		
Date	Engine Code	Chassis No.	Article No.	Product	Information

**SEAT****ALTEA (5P1)****1.6 TDI (66 kW | 1.6 Litre)**

11.10 -	CAYB		246-086-001-007C	HLWP	Plug Number (T2): 3b
---------	------	--	------------------	------	----------------------

**1.6 TDI (77 kW | 1.6 Litre)**

10.09 -	CAYC		246-083-002-022G	SWP-D-C	
10.09 -	CAYC		246-086-001-007C	HLWP	Plug Number (T2): 3b

**1.8 TFSI (118 kW | 1.8 Litre)**

01.07 -	BYT, BZB, CDAA		246-083-002-022G	SWP-D-C	
01.07 -	BYT, BZB, CDAA		246-086-001-007C	HLWP	Plug Number (T2): 3b

**1.9 TDI (66 kW | 1.9 Litre)**

08.09 -	BXF		246-083-002-022G	SWP-D-C	
08.09 -	BXF		246-086-001-007C	HLWP	Plug Number (T2): 3b

**1.9 TDI (77 kW | 1.9 Litre)**

04.04 -	BKC, BJB, BLS, BXE		246-083-002-022G	SWP-D-C	
04.04 -	BKC, BJB, BLS, BXE		246-086-001-007C	HLWP	Plug Number (T2): 3b

**2.0 FSI (110 kW | 2.0 Litre)**

05.04 - 03.09	BLR, BLY, BVY, BVZ		246-083-002-022G	SWP-D-C	
05.04 - 03.09	BLR, BLY, BVY, BVZ		246-086-001-007C	HLWP	Plug Number (T2): 3b

**2.0 TDI (100 kW | 2.0 Litre)**

03.04 - 05.09	AZV		246-083-002-022G	SWP-D-C	
03.04 - 05.09	AZV		246-086-001-007C	HLWP	Plug Number (T2): 3b

**2.0 TDI (103 kW | 2.0 Litre)**

11.05 -	BMM		246-083-002-022G	SWP-D-C	
11.05 -	BMM		246-086-001-007C	HLWP	Plug Number (T2): 3b

**2.0 TDI (125 kW | 2.0 Litre)**

03.06 -	BMN, CEGA		246-083-002-022G	SWP-D-C	
03.06 -	BMN, CEGA		246-086-001-007C	HLWP	Plug Number (T2): 3b

**2.0 TDI 16V (103 kW | 2.0 Litre)**

03.04 -	BKD, CFHC		246-083-002-022G	SWP-D-C	
03.04 -	BKD, CFHC		246-086-001-007C	HLWP	Plug Number (T2): 3b

**2.0 TFSI (147 kW | 2.0 Litre)**

04.06 - 05.09	BWA		246-083-002-022G	SWP-D-C	
04.06 - 05.09	BWA		246-086-001-007C	HLWP	Plug Number (T2): 3b

**ALTEA XL (5P5, 5P8)****1.2 TSI (77 kW | 1.2 Litre)**

04.10 -	CBZB		246-083-002-022G	SWP-D-C	
04.10 -	CBZB		246-086-001-007C	HLWP	Plug Number (T2): 3b

**1.4 16V (63 kW | 1.4 Litre)**

10.06 -	BXW, CGGB		246-083-002-022G	SWP-D-C	
10.06 -	BXW, CGGB		246-086-001-007C	HLWP	Plug Number (T2): 3b

**1.4 TSI (92 kW | 1.4 Litre)**

11.07 -	CAXC		246-083-002-022G	SWP-D-C	
11.07 -	CAXC		246-086-001-007C	HLWP	Plug Number (T2): 3b

**1.6 (75 kW | 1.6 Litre)**

10.06 -	BSE, BSF, CMXA, CCSA		246-083-002-022G	SWP-D-C	
10.06 -	BSE, BSF, CCSA, CMXA		246-086-001-007C	HLWP	Plug Number (T2): 3b

**1.6 LPG (75 kW | 1.6 Litre)**

09.09 -	CHGA		246-083-002-022G	SWP-D-C	
09.09 -	CHGA		246-086-001-007C	HLWP	Plug Number (T2): 3b

**1.6 Multifuel (75 kW | 1.6 Litre)**

10.06 -	CCSA		246-083-002-022G	SWP-D-C	
10.06 -	CCSA		246-086-001-007C	HLWP	Plug Number (T2): 3b

**1.6 TDI (66 kW | 1.6 Litre)**

11.10 -	CAYB		246-083-002-022G	SWP-D-C	
11.10 -	CAYB		246-086-001-007C	HLWP	Plug Number (T2): 3b

**1.6 TDI (77 kW | 1.6 Litre)**

10.09 -	CAYC		246-083-002-022G	SWP-D-C	
10.09 -	CAYC		246-086-001-007C	HLWP	Plug Number (T2): 3b

**1.8 TFSI (118 kW | 1.8 Litre)**

01.07 -	BYT, BZB, CDAA		246-083-002-022G	SWP-D-C	
01.07 -	BYT, BZB, CDAA		246-086-001-007C	HLWP	Plug Number (T2): 3b

**1.9 TDI (66 kW | 1.9 Litre)**

08.09 -	BXF		246-083-002-022G	SWP-D-C	
---------	-----	--	------------------	---------	--



			<b>VDO</b>		
Date	Engine Code	Chassis No.	Article No.	Product	Information

**SEAT****ALTEA XL (5P5, 5P8)****1.9 TDI (66 kW | 1.9 Litre)**

08.09 →	BXF		246-086-001-007C	HLWP	Plug Number (T2): 3b
---------	-----	--	------------------	------	----------------------

**1.9 TDI (77 kW | 1.9 Litre)**

10.06 →	BLS, BXE, BKC		246-083-002-022G	SWP-D-C	
10.06 →	BLS, BXE		246-086-001-007C	HLWP	Plug Number (T2): 3b

**2.0 FSI (110 kW | 2.0 Litre)**

10.06 → 03.09	BVY, BVZ		246-083-002-022G	SWP-D-C	
10.06 → 03.09	BVY, BVZ		246-086-001-007C	HLWP	Plug Number (T2): 3b

**2.0 TDI (100 kW | 2.0 Litre)**

11.06 → 03.09	AZV		246-083-002-022G	SWP-D-C	
11.06 → 03.09	AZV		246-086-001-007C	HLWP	Plug Number (T2): 3b

**2.0 TDI (103 kW | 2.0 Litre)**

10.06 →	BMM		246-083-002-022G	SWP-D-C	
10.06 →	BMM		246-086-001-007C	HLWP	Plug Number (T2): 3b

**2.0 TDI (125 kW | 2.0 Litre)**

06.07 →	BMN, CEGA		246-083-002-022G	SWP-D-C	
06.07 →	BMN, CEGA		246-086-001-007C	HLWP	Plug Number (T2): 3b

**2.0 TDI 16V (103 kW | 2.0 Litre)**

10.06 →	BKD, CFHC		246-083-002-022G	SWP-D-C	
10.06 →	BKD, CBDB, CFHC		246-086-001-007C	HLWP	Plug Number (T2): 3b

**2.0 TDI 4x4 (103 kW | 2.0 Litre)**

06.07 →	BMM		246-083-002-022G	SWP-D-C	
06.07 →	BMM		246-086-001-007C	HLWP	Plug Number (T2): 3b

**2.0 TDI 4x4 (125 kW | 2.0 Litre)**

06.07 →	BMN, CEGA, CFJA		246-083-002-022G	SWP-D-C	
06.07 →	BMN, CEGA, CFJA		246-086-001-007C	HLWP	Plug Number (T2): 3b

**2.0 TFSI 4x4 (147 kW | 2.0 Litre)**

06.07 → 05.09	BWA		246-083-002-022G	SWP-D-C	
06.07 → 05.09	BWA		246-086-001-007C	HLWP	Plug Number (T2): 3b

**2.0 TFSI 4x4 (155 kW | 2.0 Litre)**

05.09 →	CCZB		246-083-002-022G	SWP-D-C	
05.09 →	CCZB		246-086-001-007C	HLWP	Plug Number (T2): 3b

**AROSA (6H)****1.0 (37 kW | 1.0 Litre)**

05.97 → 06.04	AER, ALL, ALD, ANV, AUC		246-083-002-022G	SWP-D-C	
---------------	-------------------------	--	------------------	---------	--

**1.4 (44 kW | 1.4 Litre)**

04.98 → 06.04	AEX, APQ, ANW, AKV, AKK, AUD		246-083-002-022G	SWP-D-C	
---------------	------------------------------	--	------------------	---------	--

**1.4 16V (74 kW | 1.4 Litre)**

01.00 → 06.04	AFK, AUB, AQQ		246-083-002-022G	SWP-D-C	
---------------	---------------	--	------------------	---------	--

**1.4 TDI (55 kW | 1.4 Litre)**

01.00 → 06.04	AMF		246-083-002-022G	SWP-D-C	
---------------	-----	--	------------------	---------	--

**1.7 SDI (44 kW | 1.7 Litre)**

08.97 → 06.04	AKU		246-083-002-022G	SWP-D-C	
---------------	-----	--	------------------	---------	--

**CORDOBA (6K1, 6K2)****1.0 i (37 kW | 1.0 Litre)**

09.96 → 06.99	AER		246-069-056-001Z	N	
09.96 → 06.99	AER		246-080-010-002Z	N-H	T24: CLX →
09.96 → 06.99	AER		246-082-008-025G	SWP-M-C	
09.96 → 06.99	AER		246-086-001-002C	HLWP	Plug Number (T2): 3; T24: CLX →

**1.4 i (44 kW | 1.4 Litre)**

06.94 → 06.99	ABD, AEX, AKV, APQ		246-069-056-001Z	N	
06.94 → 06.99	ABD, AEX, AKV, APQ		246-080-010-002Z	N-H	T24: CLX →
06.94 → 06.99	ABD, AEX, AKV, APQ		246-082-008-025G	SWP-M-C	
06.94 → 06.99	ABD, AEX, AKV, APQ		246-086-001-002C	HLWP	Plug Number (T2): 3; T24: CLX →

**1.4 i 16V (74 kW | 1.4 Litre)**

09.96 → 06.99	AFH		246-069-056-001Z	N	
09.96 → 06.99	AFH		246-080-010-002Z	N-H	T24: CLX →
09.96 → 06.99	AFH		246-082-008-025G	SWP-M-C	
09.96 → 06.99	AFH		246-086-001-002C	HLWP	Plug Number (T2): 3; T24: CLX →

**1.6 i (55 kW | 1.6 Litre)**

02.93 → 06.99	AEE, ABU, ALM		246-069-056-001Z	N	
---------------	---------------	--	------------------	---	--





			<b>VDO</b>		
Date	Engine Code	Chassis No.	Article No.	Product	Information

**SEAT****CORDOBA (6K1, 6K2)**

<b>1.6 i (55 kW   1.6 Litre)</b>					
02.93 - 06.99	AEE, ABU, ALM		246-080-010-002Z	N-H	T24: CLX →
05.94 - 06.99	1F		246-082-008-025G	SWP-M-C	
02.93 - 06.99	AEE, ABU, ALM		246-082-008-025G	SWP-M-C	
02.93 - 06.99	AEE, ABU, ALM		246-086-001-002C	HLWP	Plug Number (T2): 3; T24: CLX →
05.94 - 06.99	1F		246-086-001-007C	HLWP	Plug Number (T2): 3b
<b>1.6 i (74 kW   1.6 Litre)</b>					
07.96 - 10.99	AFT, AKL		246-069-056-001Z	N	
07.96 - 06.99	AFT, AKL		246-080-010-002Z	N-H	T24: CLX →
07.96 - 10.99	AFT, AKL		246-082-008-025G	SWP-M-C	
07.96 - 10.99	AFT, AKL		246-086-001-002C	HLWP	Plug Number (T2): 3; T24: CLX →
<b>1.7 SDI (44 kW   1.7 Litre)</b>					
07.97 - 06.99	AKU		246-069-056-001Z	N	
07.97 - 06.99	AKU		246-080-010-002Z	N-H	T24: CLX →
07.97 - 06.99	AKU		246-082-008-025G	SWP-M-C	
07.97 - 06.99	AKU		246-086-001-002C	HLWP	Plug Number (T2): 3; T24: CLX →
<b>1.8 i (66 kW   1.8 Litre)</b>					
02.93 - 06.99	ACC, ABS, ADZ		246-069-056-001Z	N	
02.93 - 06.99	ACC, ABS, ADZ		246-080-010-002Z	N-H	T24: CLX →
02.93 - 06.99	ACC, ABS, ADZ		246-082-008-025G	SWP-M-C	
02.93 - 06.99	ACC, ABS, ADZ		246-086-001-002C	HLWP	Plug Number (T2): 3; T24: CLX →
<b>1.8 i 16V (95 kW   1.8 Litre)</b>					
10.93 - 08.96	ADL		246-069-056-001Z	N	
10.93 - 08.96	ADL		246-080-010-002Z	N-H	T24: CLX →
10.93 - 08.96	ADL		246-082-008-025G	SWP-M-C	
10.93 - 08.96	ADL		246-086-001-002C	HLWP	Plug Number (T2): 3; T24: CLX →
<b>1.9 D (47 kW   1.9 Litre)</b>					
01.96 - 08.96	1Y		246-069-056-001Z	N	
01.96 - 08.96	1Y		246-080-010-002Z	N-H	T24: CLX →
01.96 - 08.96	1Y		246-082-008-025G	SWP-M-C	
01.96 - 08.96	1Y		246-086-001-002C	HLWP	Plug Number (T2): 3; T24: CLX →
<b>1.9 D (50 kW   1.9 Litre)</b>					
02.93 - 08.96	1Y		246-069-056-001Z	N	
02.93 - 08.96	1Y		246-080-010-002Z	N-H	T24: CLX →
02.93 - 08.96	1Y		246-082-008-025G	SWP-M-C	
02.93 - 08.96	1Y		246-086-001-002C	HLWP	Plug Number (T2): 3; T24: CLX →
<b>1.9 SDI (47 kW   1.9 Litre)</b>					
08.96 - 06.99	AEY		246-069-056-001Z	N	
08.96 - 06.99	AEY		246-080-010-002Z	N-H	T24: CLX →
08.96 - 06.99	AEY		246-082-008-025G	SWP-M-C	
08.96 - 06.99	AEY		246-086-001-002C	HLWP	Plug Number (T2): 3; T24: CLX →
<b>1.9 TD (55 kW   1.9 Litre)</b>					
02.93 - 08.96	AAZ		246-069-056-001Z	N	
02.93 - 08.96	AAZ		246-080-010-002Z	N-H	T24: CLX →
02.93 - 08.96	AAZ		246-082-008-025G	SWP-M-C	
02.93 - 08.96	AAZ		246-086-001-002C	HLWP	Plug Number (T2): 3; T24: CLX →
<b>1.9 TDI (66 kW   1.9 Litre)</b>					
08.96 - 06.99	1Z, AHU		246-069-056-001Z	N	
08.96 - 06.99	1Z, AHU		246-080-010-002Z	N-H	T24: CLX →
08.96 - 06.99	1Z, AHU		246-082-008-025G	SWP-M-C	
08.96 - 06.99	1Z, AHU		246-086-001-002C	HLWP	Plug Number (T2): 3; T24: CLX →
<b>1.9 TDI (81 kW   1.9 Litre)</b>					
03.97 - 06.99	AFN		246-069-056-001Z	N	
03.97 - 06.99	AFN		246-080-010-002Z	N-H	T24: CLX →
03.97 - 06.99	AFN		246-082-008-025G	SWP-M-C	
03.97 - 06.99	AFN		246-086-001-002C	HLWP	Plug Number (T2): 3; T24: CLX →
<b>2.0 i (85 kW   2.0 Litre)</b>					
02.93 - 06.99	AGG, 2E		246-069-056-001Z	N	
02.93 - 06.99	AGG, 2E		246-080-010-002Z	N-H	T24: CLX →
02.93 - 06.99	AGG, 2E		246-082-008-025G	SWP-M-C	
02.93 - 06.99	AGG, 2E		246-086-001-002C	HLWP	Plug Number (T2): 3; T24: CLX →
<b>2.0 i 16V (110 kW   2.0 Litre)</b>					
08.96 - 06.99	ABF		246-069-056-001Z	N	



			<b>VDO</b>		
Date	Engine Code	Chassis No.	Article No.	Product	Information

**SEAT****CORDOBA (6K1, 6K2)****2.0 i 16V (110 kW | 2.0 Litre)**

08.96 - 06.99	ABF		246-080-010-002Z	N-H	T24: CLX →
08.96 - 06.99	ABF		246-082-008-025G	SWP-M-C	
08.96 - 06.99	ABF		246-086-001-002C	HLWP	Plug Number (T2): 3; T24: CLX →

**CORDOBA Vario (6K5)****1.4 (40 kW | 1.4 Litre)**

12.97 - 04.99	ANX		246-082-008-025G	SWP-M-C	T26: X11 246 003 014
---------------	-----	--	------------------	---------	----------------------

**1.4 i (44 kW | 1.4 Litre)**

09.96 - 06.99	AEX, AKV, APQ		246-069-056-001Z	N	
09.96 - 06.99	AEX, AKV, APQ		246-082-008-025G	SWP-M-C	

**1.6 i (55 kW | 1.6 Litre)**

09.96 - 06.99	AEE, ALM		246-069-056-001Z	N	
05.97 - 06.99	1F	→6K-X-499 999	246-082-008-025G	SWP-M-C	
09.96 - 06.99	AEE, ALM		246-082-008-025G	SWP-M-C	
05.97 - 06.99	1F	→6K-X-499 999	246-083-002-022G	SWP-D-C	
05.97 - 06.99	1F	6K-X-400 000→ →6K-X-499 999	246-086-001-007C	HLWP	Plug Number (T2): 3b

**1.6 i (74 kW | 1.6 Litre)**

09.96 - 06.99	AFT		246-069-056-001Z	N	
09.96 - 06.99	AFT		246-082-008-025G	SWP-M-C	

**1.7 SDI (44 kW | 1.7 Litre)**

07.97 - 06.99	AKU		246-069-056-001Z	N	
07.97 - 06.99	AKU		246-082-008-025G	SWP-M-C	

**1.9 SDI (47 kW | 1.9 Litre)**

09.96 - 06.99	AEY		246-069-056-001Z	N	
09.96 - 06.99	AEY		246-082-008-025G	SWP-M-C	

**1.9 TDI (66 kW | 1.9 Litre)**

08.96 - 06.99	1Z, AHU		246-069-056-001Z	N	
08.96 - 06.99	1Z, AHU		246-082-008-025G	SWP-M-C	

**1.9 TDI (81 kW | 1.9 Litre)**

07.97 - 06.99	AFN		246-069-056-001Z	N	
07.97 - 06.99	AFN		246-082-008-025G	SWP-M-C	

**CORDOBA (6K2)****1.0 (37 kW | 1.0 Litre)**

06.99 - 10.02	ANV, ALD, AUC		246-082-008-025G	SWP-M-C	T26: X11 246 003 014
06.99 - 10.02	ANV, ALD, AUC		246-083-002-022G	SWP-D-C	T26: X11 246 003 014
06.99 - 10.02	ANV, ALD, AUC	6K-X-400 000→ →6K-X-499 999	246-086-001-007C	HLWP	Plug Number (T2): 3b

**1.0 16V (51 kW | 1.0 Litre)**

05.00 - 10.02	AST, AVZ	→6K-X-499 999	246-083-002-022G	SWP-D-C	
05.00 - 10.02	AST, AVZ	6K-X-400 000→ →6K-X-499 999	246-086-001-007C	HLWP	Plug Number (T2): 3b

**1.4 (44 kW | 1.4 Litre)**

06.99 - 10.02	ANW, AKK, AUD	6K-X-400 000→	246-082-008-025G	SWP-M-C	
06.99 - 10.02	ANW, AKK, AUD	6K-X-400 000→	246-083-002-022G	SWP-D-C	
06.99 - 10.02	ANW, AKK, AUD		246-086-001-002C	HLWP	Plug Number (T2): 3; T24: Stella →

**1.4 16V (55 kW | 1.4 Litre)**

05.00 - 10.02	APE, AUA		246-083-002-022G	SWP-D-C	T24: Stella →
05.00 - 10.02	APE, AUA		246-086-001-002C	HLWP	Plug Number (T2): 3; T24: Stella →

**1.4 16V (74 kW | 1.4 Litre)**

02.00 - 10.02	AQQ, AUB	6K-X-400 000→	246-083-002-022G	SWP-D-C	
02.00 - 10.02	AQQ, AUB	6K-X-400 000→ →6K-X-499 999	246-086-001-007C	HLWP	Plug Number (T2): 3b

**1.6 (55 kW | 1.6 Litre)**

06.99 - 10.02	ALM		246-082-008-025G	SWP-M-C	
06.99 - 10.02	ALM		246-083-002-022G	SWP-D-C	
06.99 - 10.02	ALM		246-086-001-002C	HLWP	Plug Number (T2): 3; T24: Stella →

**1.6 (74 kW | 1.6 Litre)**

06.99 - 10.02	AEH		246-082-008-025G	SWP-M-C	
06.99 - 10.02	AEH		246-083-002-022G	SWP-D-C	
06.99 - 10.02	APF, AKL, AEH, AUR		246-086-001-002C	HLWP	Plug Number (T2): 3; T24: Stella →



Date	Engine Code	Chassis No.	Article No.	Product	Information

**SEAT****CORDOBA (6K2)****1.8 T 20V Cupra (115 kW | 1.8 Litre)**

07.00 - 10.02	AQX, AYP		246-083-002-022G	SWP-D-C	T24: Stella →
07.00 - 10.02	AQX, AYP		246-086-001-002C	HLWP	Plug Number (T2): 3; T24: Stella →

**1.9 SDI (50 kW | 1.9 Litre)**

06.99 - 10.02	AQM, AGP		246-082-008-025G	SWP-M-C	
06.99 - 10.02	AQM, AGP		246-083-002-022G	SWP-D-C	
06.99 - 10.02	AQM, AGP		246-086-001-002C	HLWP	Plug Number (T2): 3; T24: Stella →

**1.9 TDI (66 kW | 1.9 Litre)**

06.99 - 10.02	AHU, ALH, AGR		246-082-008-025G	SWP-M-C	
06.99 - 10.02	AHU, ALH, AGR		246-083-002-022G	SWP-D-C	
06.99 - 10.02	AHU, ALH, AGR		246-086-001-002C	HLWP	Plug Number (T2): 3; T24: Stella →

**1.9 TDI (81 kW | 1.9 Litre)**

06.99 - 10.02	ASK, ASV		246-082-008-025G	SWP-M-C	
06.99 - 10.02	ASK, ASV		246-083-002-022G	SWP-D-C	
06.99 - 10.02	ASK, ASV		246-086-001-002C	HLWP	Plug Number (T2): 3; T24: Stella →

**CORDOBA Vario (6K5)****1.4 (44 kW | 1.4 Litre)**

06.99 - 12.02	ANW, AKK, AUD	6K-X-400 000→	246-082-008-025G	SWP-M-C	
06.99 - 12.02	ANW, AKK, AUD	6K-X-400 000→	246-083-002-022G	SWP-D-C	
06.99 - 12.02	ANW, AKK, AUD	6K-X-400 000→ -6K-X-499 999	246-086-001-007C	HLWP	Plug Number (T2): 3b

**1.4 (74 kW | 1.4 Litre)**

02.00 - 12.02	AQQ, AUB		246-083-002-022G	SWP-D-C	T26: 1J0 955 665 H
---------------	----------	--	------------------	---------	--------------------

**1.4 16V (55 kW | 1.4 Litre)**

06.99 - 12.02	APE, AUA	-6K-X-499 999	246-082-008-025G	SWP-M-C	
06.99 - 12.02	APE, AUA	-6K-X-499 999	246-083-002-022G	SWP-D-C	
06.99 - 12.02	APE, AUA	6K-X-400 000→ -6K-X-499 999	246-086-001-007C	HLWP	Plug Number (T2): 3b

**1.6 (55 kW | 1.6 Litre)**

06.99 - 12.02	ALM	6K-X-400 000→	246-082-008-025G	SWP-M-C	
06.99 - 12.02	ALM	6K-X-400 000→	246-083-002-022G	SWP-D-C	
06.99 - 12.02	ALM	6K-X-400 000→ -6K-X-499 999	246-086-001-007C	HLWP	Plug Number (T2): 3b

**1.6 (74 kW | 1.6 Litre)**

06.99 - 12.02	APF, AKL, AEH, AUR	6K-X-400 000→	246-082-008-025G	SWP-M-C	
06.99 - 12.02	APF, AKL, AEH, AUR	6K-X-400 000→	246-083-002-022G	SWP-D-C	
06.99 - 12.02	APF, AKL, AEH, AUR	6K-X-400 000→ -6K-X-499 999	246-086-001-007C	HLWP	Plug Number (T2): 3b

**1.9 SDI (50 kW | 1.9 Litre)**

06.99 - 12.02	AQM, AGP		246-082-008-025G	SWP-M-C	
06.99 - 12.02	AQM, AGP		246-083-002-022G	SWP-D-C	
06.99 - 12.02	AQM, AGP	6K-X-400 000→ -6K-X-499 999	246-086-001-007C	HLWP	Plug Number (T2): 3b

**1.9 TDI (66 kW | 1.9 Litre)**

06.99 - 12.02	ALH, AGR		246-082-008-025G	SWP-M-C	
06.99 - 12.02	ALH, AGR		246-083-002-022G	SWP-D-C	
06.99 - 12.02	ALH, AGR	6K-X-400 000→ -6K-X-499 999	246-086-001-007C	HLWP	Plug Number (T2): 3b

**1.9 TDI (81 kW | 1.9 Litre)**

06.99 - 12.02	ASK, ASV		246-082-008-025G	SWP-M-C	
06.99 - 12.02	ASK, ASV		246-083-002-022G	SWP-D-C	
06.99 - 12.02	ASK, ASV	6K-X-400 000→ -6K-X-499 999	246-086-001-007C	HLWP	Plug Number (T2): 3b

**CORDOBA (6L2)****1.2 (47 kW | 1.2 Litre)**

10.02 - 06.06	AZQ, BME		246-082-008-025G	SWP-M-C	
10.02 - 06.06	AZQ, BME		246-083-002-022G	SWP-D-C	
10.02 - 06.06	AZQ, BME		246-086-001-007C	HLWP	Plug Number (T2): 3b

**1.2 12V (51 kW | 1.2 Litre)**

05.06 - 11.09	BXV		246-082-008-025G	SWP-M-C	
05.06 - 11.09	BXV		246-083-002-022G	SWP-D-C	



			<b>VDO</b>		
Date	Engine Code	Chassis No.	Article No.	Product	Information

**SEAT****CORDOBA (6L2)****1.4 16V (55 kW | 1.4 Litre)**

09.02 - 12.07	BBY, BKY		246-082-008-025G	SWP-M-C	
09.02 - 12.07	BBY, BKY		246-083-002-022G	SWP-D-C	
09.02 - 12.07	BBY, BKY		246-086-001-007C	HLWP	Plug Number (T2): 3b

**1.4 16V (63 kW | 1.4 Litre)**

05.06 - 11.09	BXW		246-082-008-025G	SWP-M-C	
05.06 - 11.09	BXW		246-083-002-022G	SWP-D-C	

**1.4 16V (74 kW | 1.4 Litre)**

10.02 - 11.09	AUB, BBZ		246-082-008-025G	SWP-M-C	
10.02 - 11.09	AUB, BBZ		246-083-002-022G	SWP-D-C	
10.02 - 11.09	AUB, BBZ		246-086-001-007C	HLWP	Plug Number (T2): 3b

**1.4 TDI (51 kW | 1.4 Litre)**

05.05 - 11.09	BNM		246-082-008-025G	SWP-M-C	
---------------	-----	--	------------------	---------	--

**1.4 TDI (55 kW | 1.4 Litre)**

10.02 - 12.05	AMF		246-082-008-025G	SWP-M-C	
10.02 - 12.05	AMF		246-083-002-022G	SWP-D-C	
10.02 - 12.05	AMF		246-086-001-007C	HLWP	Plug Number (T2): 3b

**1.4 TDI (59 kW | 1.4 Litre)**

06.05 - 11.09	BMS, BNV		246-082-008-025G	SWP-M-C	T26: X11 246 003 014
---------------	----------	--	------------------	---------	----------------------

**1.6 (74 kW | 1.6 Litre)**

04.03 - 11.09	BAH		246-082-008-025G	SWP-M-C	
04.03 - 11.09	BAH		246-083-002-022G	SWP-D-C	
04.03 - 11.09	BAH		246-086-001-007C	HLWP	Plug Number (T2): 3b

**1.6 16V (77 kW | 1.6 Litre)**

11.06 - 11.09	BTS		246-082-008-025G	SWP-M-C	T26: X11 246 003 014
11.06 - 11.09	BTS		246-083-002-022G	SWP-D-C	T26: X11 246 003 014

**1.9 SDI (47 kW | 1.9 Litre)**

09.02 - 11.09	ASY		246-082-008-025G	SWP-M-C	
09.02 - 11.09	ASY		246-083-002-022G	SWP-D-C	
09.02 - 11.09	ASY		246-086-001-007C	HLWP	Plug Number (T2): 3b

**1.9 TDI (74 kW | 1.9 Litre)**

09.02 - 11.09	ATD, AXR, BMT		246-082-008-025G	SWP-M-C	
09.02 - 11.09	ATD, AXR, BMT		246-083-002-022G	SWP-D-C	
09.02 - 11.09	ATD, AXR, BMT		246-086-001-007C	HLWP	Plug Number (T2): 3b

**1.9 TDI (96 kW | 1.9 Litre)**

10.02 - 11.09	ASZ, BLT		246-082-008-025G	SWP-M-C	
10.02 - 11.09	ASZ, BLT		246-083-002-022G	SWP-D-C	
10.02 - 11.09	ASZ, BLT		246-086-001-007C	HLWP	Plug Number (T2): 3b

**2.0 (85 kW | 2.0 Litre)**

09.02 - 11.09	AZL, BBX		246-082-008-025G	SWP-M-C	
09.02 - 11.09	AZL, BBX		246-083-002-022G	SWP-D-C	
09.02 - 11.09	AZL, BBX		246-086-001-007C	HLWP	Plug Number (T2): 3b

**EXEO (3R2)****1.6 (75 kW | 1.6 Litre)**

03.09 -	ALZ		246-082-008-025G	SWP-M-C	
03.09 -	ALZ		246-086-001-007C	HLWP	Plug Number (T2): 3b

**1.8 T (110 kW | 1.8 Litre)**

12.08 -	CFMA		246-082-008-025G	SWP-M-C	
12.08 -	CFMA		246-086-001-007C	HLWP	Plug Number (T2): 3b

**1.8 TSI (118 kW | 1.8 Litre)**

05.10 -	CDHB		246-082-008-025G	SWP-M-C	
05.10 -	CDHB		246-086-001-007C	HLWP	Plug Number (T2): 3b

**1.8 TSI (88 kW | 1.8 Litre)**

09.10 -	CDHA		246-082-008-025G	SWP-M-C	
09.10 -	CDHA		246-086-001-007C	HLWP	Plug Number (T2): 3b

**2.0 TDI (105 kW | 2.0 Litre)**

03.09 -	CAGA		246-082-008-025G	SWP-M-C	
03.09 -	CAGA		246-086-001-007C	HLWP	Plug Number (T2): 3b

**2.0 TDI (125 kW | 2.0 Litre)**

03.09 -	CAHA		246-082-008-025G	SWP-M-C	
03.09 -	CAHA		246-086-001-007C	HLWP	Plug Number (T2): 3b



			<b>VDO</b>		
Date	Engine Code	Chassis No.	Article No.	Product	Information

**SEAT****EXEO (3R2)****2.0 TDI (88 kW | 2.0 Litre)**

12.08 →	CAGC		246-082-008-025G	SWP-M-C	
12.08 →	CAGC		246-086-001-007C	HLWP	Plug Number (T2): 3b

**2.0 TFSI (147 kW | 2.0 Litre)**

03.09 →	BWE		246-082-008-025G	SWP-M-C	
03.09 →	BWE		246-086-001-007C	HLWP	Plug Number (T2): 3b

**2.0 TFSI (155 kW | 2.0 Litre)**

05.10 →	CDND		246-082-008-025G	SWP-M-C	
05.10 →	CDND		246-086-001-007C	HLWP	Plug Number (T2): 3b

**EXEO ST (3R5)****1.6 (75 kW | 1.6 Litre)**

06.09 →	ALZ		246-082-008-025G	SWP-M-C	
06.09 →	ALZ		246-086-001-007C	HLWP	Plug Number (T2): 3b

**1.8 T (110 kW | 1.8 Litre)**

06.09 →	CFMA		246-082-008-025G	SWP-M-C	
06.09 →	CFMA		246-086-001-007C	HLWP	Plug Number (T2): 3b

**1.8 TSI (118 kW | 1.8 Litre)**

05.10 →	CDHB		246-082-008-025G	SWP-M-C	
05.10 →	CDHB		246-086-001-007C	HLWP	Plug Number (T2): 3b

**1.8 TSI (88 kW | 1.8 Litre)**

09.10 →	CDHA		246-082-008-025G	SWP-M-C	
09.10 →	CDHA		246-086-001-007C	HLWP	Plug Number (T2): 3b

**2.0 TDI (105 kW | 2.0 Litre)**

06.09 →	CAGA		246-082-008-025G	SWP-M-C	
06.09 →	CAGA		246-086-001-007C	HLWP	Plug Number (T2): 3b

**2.0 TDI (125 kW | 2.0 Litre)**

06.09 →	CAHA		246-082-008-025G	SWP-M-C	
06.09 →	CAHA		246-086-001-007C	HLWP	Plug Number (T2): 3b

**2.0 TDI (88 kW | 2.0 Litre)**

08.09 →	CAGC		246-082-008-025G	SWP-M-C	
08.09 →	CAGC		246-086-001-007C	HLWP	Plug Number (T2): 3b

**2.0 TFSI (147 kW | 2.0 Litre)**

06.09 →	BWE		246-082-008-025G	SWP-M-C	
06.09 →	BWE		246-086-001-007C	HLWP	Plug Number (T2): 3b

**2.0 TFSI (155 kW | 2.0 Litre)**

05.10 →	CDND		246-082-008-025G	SWP-M-C	
05.10 →	CDND		246-086-001-007C	HLWP	Plug Number (T2): 3b

**IBIZA II (6K1)****1.0 (33 kW | 1.0 Litre)**

09.96 → 09.96	AAU	6K - VR 000 001 →	246-069-056-001Z	N	
03.93 → 09.96	AAU		246-080-010-002Z	N-H	T24: CL →
03.93 → 09.96	AAU	6K - VR 000 001 →	246-082-008-025G	SWP-M-C	
03.93 → 06.96	AAU		246-083-002-014G	SWP-D-C	Plug Number (T2): 6
03.93 → 09.96	AAU	6K - VR 000 001 →	246-083-002-022G	SWP-D-C	
03.93 → 09.96	AAU		246-086-001-002C	HLWP	Plug Number (T2): 3; T24: CL →

**1.0 i (37 kW | 1.0 Litre)**

09.96 → 08.99	AER	6K - VR 000 001 →	246-069-056-001Z	N	
09.96 → 08.99	AER		246-080-010-002Z	N-H	T24: CL →
09.96 → 08.99	AER		246-082-008-025G	SWP-M-C	
09.96 → 08.99	AER		246-083-002-014G	SWP-D-C	Plug Number (T2): 6
09.96 → 08.99	AER		246-083-002-022G	SWP-D-C	
09.96 → 08.99	AER		246-086-001-002C	HLWP	Plug Number (T2): 3; T24: CL →

**1.3 i (40 kW | 1.3 Litre)**

09.96 → 08.99	AAV, 2G	6K - VR 000 001 →	246-069-056-001Z	N	
03.93 → 08.99	AAV, 2G		246-080-010-002Z	N-H	T24: CL →
03.93 → 08.99	AAV, 2G	6K - VR 000 001 →	246-082-008-025G	SWP-M-C	
03.93 → 07.94	AAV, 2G		246-083-002-014G	SWP-D-C	Plug Number (T2): 6
03.93 → 08.99	AAV, 2G	6K - VR 000 001 →	246-083-002-022G	SWP-D-C	
03.93 → 08.99	AAV, 2G		246-086-001-002C	HLWP	Plug Number (T2): 3; T24: CL →

**1.4 (40 kW | 1.4 Litre)**

12.97 → 04.99	ANX		246-082-008-025G	SWP-M-C	T26: X11 246 003 014
---------------	-----	--	------------------	---------	----------------------



			<b>VDO</b>		
Date	Engine Code	Chassis No.	Article No.	Product	Information

**SEAT****IBIZA II (6K1)****1.4 (40 kW | 1.4 Litre)**

12.97 → 04.99	ANX		246-083-002-022G	SWP-D-C	T26: X11 246 003 014
12.97 → 04.99			246-086-001-007C	HLWP	Plug Number (T2): 3b

**1.4 i (44 kW | 1.4 Litre)**

09.96 → 08.99	ABD, AEX, AKV, APQ	6K - VR 000 001→	246-069-056-001Z	N	
09.93 → 08.99	ABD, AEX, AKV, APQ		246-080-010-002Z	N-H	T24: CL →
09.93 → 08.99	ABD, AEX, AKV, APQ		246-082-008-025G	SWP-M-C	
09.93 → 12.97	ABD, AEX, AKV, APQ		246-083-002-014G	SWP-D-C	Plug Number (T2): 6
09.93 → 08.99	ABD, AEX, AKV, APQ		246-083-002-022G	SWP-D-C	
09.93 → 08.99	ABD, AEX, AKV, APQ		246-086-001-002C	HLWP	Plug Number (T2): 3; T24: CL →

**1.4 i 16V (74 kW | 1.4 Litre)**

06.97 → 08.99	AFH	6K - VR 000 001→	246-069-056-001Z	N	
06.97 → 08.99	AFH		246-080-010-002Z	N-H	T24: CL →
06.97 → 08.99	AFH		246-082-008-025G	SWP-M-C	
06.97 → 08.99	AFH		246-083-002-014G	SWP-D-C	Plug Number (T2): 6
06.97 → 08.99	AFH		246-083-002-022G	SWP-D-C	
06.97 → 08.99	AFH		246-086-001-002C	HLWP	Plug Number (T2): 3; T24: CL →

**1.6 i (55 kW | 1.6 Litre)**

09.96 → 08.99	AEE, ABU, ALM	6K - VR 000 001→	246-069-056-001Z	N	
03.93 → 08.99	AEE, ABU, ALM		246-080-010-002Z	N-H	T24: CL →
09.94 → 06.99	1F		246-082-008-025G	SWP-M-C	
03.93 → 08.99	AEE, ABU, ALM		246-082-008-025G	SWP-M-C	
03.93 → 12.98	AEE, ABU, ALM		246-083-002-014G	SWP-D-C	Plug Number (T2): 6
09.94 → 06.99	1F		246-083-002-022G	SWP-D-C	
03.93 → 08.99	AEE, ABU, ALM		246-083-002-022G	SWP-D-C	
03.93 → 08.99	AEE, ABU, ALM		246-086-001-002C	HLWP	Plug Number (T2): 3; T24: CL →
09.94 → 06.99	1F		246-086-001-007C	HLWP	Plug Number (T2): 3b

**1.6 i (74 kW | 1.6 Litre)**

09.96 → 08.99	AFT	6K - VR 000 001→	246-069-056-001Z	N	
04.96 → 08.99	AFT		246-080-010-002Z	N-H	T24: CL →
04.96 → 08.99	AFT		246-082-008-025G	SWP-M-C	
07.96 → 05.98	AFT		246-083-002-014G	SWP-D-C	Plug Number (T2): 6
04.96 → 08.99	AFT		246-083-002-022G	SWP-D-C	
04.96 → 08.99	AFT		246-086-001-002C	HLWP	Plug Number (T2): 3; T24: CL →

**1.8 i (66 kW | 1.8 Litre)**

09.96 → 08.99	ABS, ADZ, ACC	6K - VR 000 001→	246-069-056-001Z	N	
03.93 → 08.99	ABS, ADZ, ACC		246-080-010-002Z	N-H	T24: CL →
03.93 → 08.99	ABS, ADZ, ACC	6K - VR 000 001→	246-082-008-025G	SWP-M-C	
03.93 → 06.96	ABS, ADZ, ACC		246-083-002-014G	SWP-D-C	Plug Number (T2): 6
03.93 → 08.99	ABS, ADZ, ACC	6K - VR 000 001→	246-083-002-022G	SWP-D-C	
03.93 → 08.99	ABS, ADZ, ACC		246-086-001-002C	HLWP	Plug Number (T2): 3; T24: CL →

**1.8 i 16V (95 kW | 1.8 Litre)**

11.93 → 08.96	ADL		246-080-010-002Z	N-H	T24: CL →
11.93 → 08.96	ADL		246-082-008-025G	SWP-M-C	
02.94 → 06.96	ADL		246-083-002-014G	SWP-D-C	Plug Number (T2): 6
11.93 → 08.96	ADL		246-083-002-022G	SWP-D-C	
11.93 → 08.96	ADL		246-086-001-002C	HLWP	Plug Number (T2): 3; T24: CL →

**1.9 D (47 kW | 1.9 Litre)**

04.93 → 08.96	1Y		246-080-010-002Z	N-H	T24: CL →
04.93 → 08.96	1Y		246-082-008-025G	SWP-M-C	
04.93 → 08.96	1Y		246-083-002-022G	SWP-D-C	
04.93 → 08.96	1Y		246-086-001-002C	HLWP	Plug Number (T2): 3; T24: CL →

**1.9 D (50 kW | 1.9 Litre)**

10.94 → 08.96	1Y		246-080-010-002Z	N-H	T24: CL →
10.94 → 08.96	1Y		246-082-008-025G	SWP-M-C	
07.96 → 08.96	1Y		246-083-002-014G	SWP-D-C	Plug Number (T2): 6
10.94 → 08.96	1Y		246-083-002-022G	SWP-D-C	
10.94 → 08.96	1Y		246-086-001-002C	HLWP	Plug Number (T2): 3; T24: CL →

**1.9 SDI (47 kW | 1.9 Litre)**

09.96 → 08.99	AEY	6K - VR 000 001→	246-069-056-001Z	N	
08.96 → 08.99	AEY		246-080-010-002Z	N-H	T24: CL →
08.96 → 08.99	AEY		246-082-008-025G	SWP-M-C	
08.96 → 08.99	AEY		246-083-002-022G	SWP-D-C	



			<b>VDO</b>		
Date	Engine Code	Chassis No.	Article No.	Product	Information

**SEAT****IBIZA II (6K1)****1.9 SDI (47 kW | 1.9 Litre)**

08.96 - 08.99	AEY		246-086-001-002C	HLWP	Plug Number (T2): 3; T24: CL →
---------------	-----	--	------------------	------	--------------------------------

**1.9 TD (55 kW | 1.9 Litre)**

03.93 - 08.96	AAZ		246-080-010-002Z	N-H	T24: CL →
03.93 - 08.96	AAZ		246-082-008-025G	SWP-M-C	
03.93 - 06.96	AAZ		246-083-002-014G	SWP-D-C	Plug Number (T2): 6
03.93 - 08.96	AAZ		246-083-002-022G	SWP-D-C	
03.93 - 08.96	AAZ		246-086-001-002C	HLWP	Plug Number (T2): 3; T24: CL →

**1.9 TDI (66 kW | 1.9 Litre)**

09.96 - 08.99	1Z, AHU	6K - VR 000 001→	246-069-056-001Z	N	
08.96 - 08.99	1Z, AHU		246-080-010-002Z	N-H	T24: CL →
08.96 - 08.99	1Z, AHU	6K - VR 000 001→	246-082-008-025G	SWP-M-C	
08.96 - 08.97	1Z, AHU		246-083-002-014G	SWP-D-C	Plug Number (T2): 6
08.96 - 08.99	1Z, AHU	6K - VR 000 001→	246-083-002-022G	SWP-D-C	
08.96 - 08.99	1Z, AHU		246-086-001-002C	HLWP	Plug Number (T2): 3; T24: CL →

**1.9 TDI (81 kW | 1.9 Litre)**

02.97 - 08.99	AFN	6K - VR 000 001→	246-069-056-001Z	N	
02.97 - 08.99	AFN		246-080-010-002Z	N-H	T24: CL →
02.97 - 08.99	AFN	6K - VR 000 001→	246-082-008-025G	SWP-M-C	
03.97 - 08.99	AFN		246-083-002-014G	SWP-D-C	Plug Number (T2): 6
02.97 - 08.99	AFN	6K - VR 000 001→	246-083-002-022G	SWP-D-C	
02.97 - 08.99	AFN		246-086-001-002C	HLWP	Plug Number (T2): 3; T24: CL →

**2.0 i (85 kW | 2.0 Litre)**

09.96 - 08.99	2E, AGG	6K - VR 000 001→	246-069-056-001Z	N	
03.93 - 08.99	2E, AGG		246-080-010-002Z	N-H	T24: CL →
03.93 - 08.99	2E, AGG		246-082-008-025G	SWP-M-C	
03.93 - 06.96	2E, AGG		246-083-002-014G	SWP-D-C	Plug Number (T2): 6
03.93 - 08.99	2E, AGG		246-083-002-022G	SWP-D-C	
03.93 - 08.99	2E, AGG		246-086-001-002C	HLWP	Plug Number (T2): 3; T24: CL →

**2.0 i 16V (110 kW | 2.0 Litre)**

09.96 - 08.99	ABF	6K - VR 000 001→	246-069-056-001Z	N	
08.96 - 08.99	ABF		246-080-010-002Z	N-H	T24: CL →
08.96 - 08.99	ABF		246-082-008-025G	SWP-M-C	
08.96 - 08.99	ABF		246-083-002-014G	SWP-D-C	Plug Number (T2): 6
08.96 - 08.99	ABF		246-083-002-022G	SWP-D-C	
08.96 - 08.99	ABF		246-086-001-002C	HLWP	Plug Number (T2): 3; T24: CL →

**IBIZA III (6K1)****1.0 (37 kW | 1.0 Litre)**

08.99 - 02.02	ALD		246-082-008-025G	SWP-M-C	
08.99 - 02.02	ALD		246-083-002-022G	SWP-D-C	
08.99 - 02.02	ALD, ANV, AUC		246-086-001-002C	HLWP	Plug Number (T2): 3; T24: Stella →

**1.0 (50 kW | 1.0 Litre)**

06.00 - 02.02			246-082-008-025G	SWP-M-C	T26: 1J0 955 665 H
06.00 - 02.02			246-083-002-022G	SWP-D-C	T26: 1J0 955 665 H
06.00 - 02.02			246-086-001-007C	HLWP	Plug Number (T2): 3b

**1.0 16V (51 kW | 1.0 Litre)**

10.99 - 02.02	AST, AVZ		246-082-008-025G	SWP-M-C	T26: 1J0 955 665 H
10.99 - 02.02	AST, AVZ		246-083-002-022G	SWP-D-C	T26: 1J0 955 665 H
10.99 - 02.02	AST, AVZ	6K-X-400 000→	246-086-001-007C	HLWP	Plug Number (T2): 3b

**1.4 (44 kW | 1.4 Litre)**

08.99 - 02.02	AKK		246-082-008-025G	SWP-M-C	
08.99 - 02.02	AKK		246-083-002-022G	SWP-D-C	
08.99 - 02.02	ANW, AKK, AUD		246-086-001-002C	HLWP	Plug Number (T2): 3; T24: Stella →

**1.4 16V (55 kW | 1.4 Litre)**

05.00 - 02.02	APE, AUA		246-082-008-025G	SWP-M-C	T26: X11 246 003 014
05.00 - 02.02	APE, AUA		246-083-002-022G	SWP-D-C	T26: X11 246 003 014
05.00 - 02.02	APE, AUA		246-086-001-002C	HLWP	Plug Number (T2): 3; T24: Stella →

**1.4 16V (74 kW | 1.4 Litre)**

08.99 - 02.02	AQQ		246-082-008-025G	SWP-M-C	
08.99 - 02.02	AQQ		246-083-002-022G	SWP-D-C	
08.99 - 02.02	AQQ, AUB		246-086-001-002C	HLWP	Plug Number (T2): 3; T24: Stella →



			<b>VDO</b>		
Date	Engine Code	Chassis No.	Article No.	Product	Information

**SEAT****IBIZA III (6K1)****1.6 (55 kW | 1.6 Litre)**

08.99 - 02.02	ALM		246-082-008-025G	SWP-M-C	T26: X11 246 003 014
08.99 - 02.02	ALM		246-083-002-022G	SWP-D-C	T26: X11 246 003 014
08.99 - 02.02	ALM		246-086-001-002C	HLWP	Plug Number (T2): 3; T24: Stella →

**1.6 (74 kW | 1.6 Litre)**

08.99 - 02.02	AEH		246-082-008-025G	SWP-M-C	
08.99 - 02.02	AEH		246-083-002-022G	SWP-D-C	
08.99 - 02.02	APF, AEH, AUR, AKL		246-086-001-002C	HLWP	Plug Number (T2): 3; T24: Stella →

**1.8 T 20V Cupra (115 kW | 1.8 Litre)**

07.00 - 02.02	AYP		246-082-008-025G	SWP-M-C	
07.00 - 02.02	AYP		246-083-002-022G	SWP-D-C	
07.00 - 02.02	AQX, AYP		246-086-001-002C	HLWP	Plug Number (T2): 3; T24: Stella →

**1.9 SDI (50 kW | 1.9 Litre)**

08.99 - 02.02	AQM, AGP		246-082-008-025G	SWP-M-C	
08.99 - 02.02	AQM, AGP		246-083-002-022G	SWP-D-C	
08.99 - 02.02	AQM, AGP		246-086-001-002C	HLWP	Plug Number (T2): 3; T24: Stella →

**1.9 TDI (66 kW | 1.9 Litre)**

08.99 - 02.02	ALH, AGR		246-082-008-025G	SWP-M-C	
08.99 - 02.02	ALH, AGR		246-083-002-022G	SWP-D-C	
08.99 - 02.02	ALH, AGR		246-086-001-002C	HLWP	Plug Number (T2): 3; T24: Stella →

**1.9 TDI (81 kW | 1.9 Litre)**

08.99 - 02.02	ASK, ASV		246-082-008-025G	SWP-M-C	
08.99 - 02.02	ASK, ASV		246-083-002-022G	SWP-D-C	
08.99 - 02.02	ASK, ASV		246-086-001-002C	HLWP	Plug Number (T2): 3; T24: Stella →

**IBIZA IV (6L1)****1.2 (44 kW | 1.2 Litre)**

06.07 - 05.08	BBM		246-083-002-022G	SWP-D-C	
06.07 - 05.08	BBM		246-086-001-007C	HLWP	Plug Number (T2): 3b

**1.2 (47 kW | 1.2 Litre)**

02.02 - 06.06	AZQ, BME		246-082-008-025G	SWP-M-C	T26: 1J0 955 665 H
02.02 - 06.06	AZQ, BME		246-083-002-022G	SWP-D-C	T26: 1J0 955 665 H
02.02 - 06.06	AZQ, BME	6L-2-000 001→	246-086-001-007C	HLWP	Plug Number (T2): 3b

**1.2 12V (51 kW | 1.2 Litre)**

05.06 - 11.09	BXV		246-082-008-025G	SWP-M-C	
05.06 - 11.09	BXV		246-083-002-022G	SWP-D-C	
05.06 - 11.09	BXV		246-086-001-007C	HLWP	Plug Number (T2): 3b

**1.4 16V (55 kW | 1.4 Litre)**

02.02 - 12.07	BBY, BKY		246-082-008-025G	SWP-M-C	T26: 1J0 955 665 H
02.02 - 12.07	BBY, BKY		246-083-002-022G	SWP-D-C	T26: 1J0 955 665 H
02.02 - 12.07	BBY, BKY		246-086-001-007C	HLWP	Plug Number (T2): 3b

**1.4 16V (63 kW | 1.4 Litre)**

05.06 - 11.09	BXW		246-082-008-025G	SWP-M-C	
05.06 - 11.09	BXW		246-083-002-022G	SWP-D-C	
05.06 - 11.09	BXW		246-086-001-007C	HLWP	Plug Number (T2): 3b

**1.4 16V (74 kW | 1.4 Litre)**

02.02 - 11.09	BBZ		246-082-008-025G	SWP-M-C	
02.02 - 11.09	BBZ		246-083-002-022G	SWP-D-C	
02.02 - 11.09	AUB, BBZ		246-086-001-007C	HLWP	Plug Number (T2): 3b

**1.4 TDI (51 kW | 1.4 Litre)**

05.05 - 11.09	BNM		246-082-008-025G	SWP-M-C	
05.05 - 11.09	BNM		246-083-002-022G	SWP-D-C	
05.05 - 11.09	BNM		246-086-001-007C	HLWP	Plug Number (T2): 3b

**1.4 TDI (55 kW | 1.4 Litre)**

05.02 - 12.05	AMF		246-082-008-025G	SWP-M-C	T26: 1J0 955 665 H
05.02 - 12.05	AMF		246-083-002-022G	SWP-D-C	T26: 1J0 955 665 H
05.02 - 12.05	AMF		246-086-001-007C	HLWP	Plug Number (T2): 3b

**1.4 TDI (59 kW | 1.4 Litre)**

06.05 - 11.09	BMS, BNV		246-082-008-025G	SWP-M-C	T26: 1J0 955 665 H
06.05 - 11.09	BMS, BNV		246-083-002-022G	SWP-D-C	T26: 1J0 955 665 H
06.05 - 11.09	BMS, BNV		246-086-001-007C	HLWP	Plug Number (T2): 3b

**1.6 (74 kW | 1.6 Litre)**

02.03 - 11.09	BAH		246-082-008-025G	SWP-M-C	
---------------	-----	--	------------------	---------	--





			<b>VDO</b>		
Date	Engine Code	Chassis No.	Article No.	Product	Information

**SEAT****IBIZA IV (6L1)****1.6 (74 kW | 1.6 Litre)**

02.03 - 11.09	BAH		246-083-002-022G	SWP-D-C	
02.03 - 11.09	BAH		246-086-001-007C	HLWP	Plug Number (T2): 3b

**1.6 16V (77 kW | 1.6 Litre)**

11.06 - 11.09	BTS		246-082-008-025G	SWP-M-C	T26: 1J0 955 665 H
11.06 - 11.09	BTS		246-083-002-022G	SWP-D-C	T26: 1J0 955 665 H
11.06 - 11.09	BTS		246-086-001-007C	HLWP	Plug Number (T2): 3b

**1.8 T Cupra R (132 kW | 1.8 Litre)**

01.04 - 02.08	BBU, BLZ		246-082-008-025G	SWP-M-C	T26: 1J0 955 665 H
01.04 - 02.08	BBU, BLZ		246-083-002-022G	SWP-D-C	T26: 1J0 955 665 H
01.04 - 02.08	BBU, BLZ		246-086-001-007C	HLWP	Plug Number (T2): 3b

**1.8 T FR (110 kW | 1.8 Litre)**

12.03 - 05.08	BKV		246-082-008-025G	SWP-M-C	
12.03 - 05.08	BKV		246-083-002-022G	SWP-D-C	
12.03 - 05.08	BJX, BKV		246-086-001-007C	HLWP	Plug Number (T2): 3b

**1.9 SDI (47 kW | 1.9 Litre)**

02.02 - 12.05	ASY		246-082-008-025G	SWP-M-C	
02.02 - 12.05	ASY		246-083-002-022G	SWP-D-C	
02.02 - 12.05	ASY		246-086-001-007C	HLWP	Plug Number (T2): 3b

**1.9 TDI (74 kW | 1.9 Litre)**

02.02 - 11.09	BMT		246-082-008-025G	SWP-M-C	
02.02 - 11.09	BMT		246-083-002-022G	SWP-D-C	
02.02 - 11.09	ATD, AXR, BMT		246-086-001-007C	HLWP	Plug Number (T2): 3b

**1.9 TDI (96 kW | 1.9 Litre)**

02.02 - 11.09	ASZ		246-082-008-025G	SWP-M-C	
02.02 - 11.09	ASZ		246-083-002-022G	SWP-D-C	
02.02 - 11.09	ASZ, BLT		246-086-001-007C	HLWP	Plug Number (T2): 3b

**1.9 TDI Cupra R (118 kW | 1.9 Litre)**

03.04 - 02.08	BPX		246-082-008-025G	SWP-M-C	
03.04 - 02.08	BPX		246-083-002-022G	SWP-D-C	
03.04 - 02.08	BPX, BUK		246-086-001-007C	HLWP	Plug Number (T2): 3b

**2.0 (85 kW | 2.0 Litre)**

04.02 - 11.09	AZL		246-082-008-025G	SWP-M-C	
04.02 - 11.09	AZL		246-083-002-022G	SWP-D-C	
04.02 - 11.09	AZL, BBX		246-086-001-007C	HLWP	Plug Number (T2): 3b

**IBIZA V (6J5)****1.2 (44 kW | 1.2 Litre)**

07.09 -	CGPB	6J-9-000 001→	246-082-008-025G	SWP-M-C	
---------	------	---------------	------------------	---------	--

**1.2 (51 kW | 1.2 Litre)**

03.08 -	BZG, CGPA		246-082-008-025G	SWP-M-C	
03.08 -	BZG, CGPA		246-083-002-022G	SWP-D-C	
03.08 -	BZG, CGPA		246-086-001-007C	HLWP	Plug Number (T2): 3b

**1.2 TDI (55 kW | 1.2 Litre)**

05.10 -	CFWA	6J-9-000 001→	246-082-008-025G	SWP-M-C	
05.10 -	CFWA		246-083-002-022G	SWP-D-C	
05.10 -	CFWA		246-086-001-007C	HLWP	Plug Number (T2): 3b

**1.2 TSI (77 kW | 1.2 Litre)**

09.10 -	CBZB	6J-9-000 001→	246-082-008-025G	SWP-M-C	
09.10 -	CBZB		246-083-002-022G	SWP-D-C	
09.10 -	CBZB		246-086-001-007C	HLWP	Plug Number (T2): 3b

**1.4 (63 kW | 1.4 Litre)**

03.08 -	BXW, CGGB		246-082-008-025G	SWP-M-C	
03.08 -	BXW, CGGB		246-083-002-022G	SWP-D-C	
03.08 -	BXW, CGGB		246-086-001-007C	HLWP	Plug Number (T2): 3b

**1.4 TDI (59 kW | 1.4 Litre)**

07.08 -	BMS		246-082-008-025G	SWP-M-C	
07.08 -	BMS		246-083-002-022G	SWP-D-C	
07.08 -	BMS		246-086-001-007C	HLWP	Plug Number (T2): 3b

**1.4 TSI (110 kW | 1.4 Litre)**

06.09 -	CAVF	6J-9-000 001→	246-082-008-025G	SWP-M-C	
06.09 -	CAVF	6J-9-000 001→	246-083-002-022G	SWP-D-C	
06.09 -	CAVF		246-086-001-007C	HLWP	Plug Number (T2): 3b



			<b>VDO</b>		
Date	Engine Code	Chassis No.	Article No.	Product	Information

**SEAT****IBIZA V (6J5)****1.6 (77 kW | 1.6 Litre)**

05.08 →	BTS		246-082-008-025G	SWP-M-C	
05.08 →	BTS		246-083-002-022G	SWP-D-C	
05.08 →	BTS		246-086-001-007C	HLWP	Plug Number (T2): 3b

**1.6 TDI (66 kW | 1.6 Litre)**

05.09 →	CAYB	6J-9-000 001→	246-082-008-025G	SWP-M-C	
05.09 →	CAYB	6J-9-000 001→	246-083-002-022G	SWP-D-C	
05.09 →	CAYB	6J-9-000 001→	246-086-001-007C	HLWP	Plug Number (T2): 3b

**1.6 TDI (77 kW | 1.6 Litre)**

05.09 →	CAYC, CLNA	6J-9-000 001→	246-082-008-025G	SWP-M-C	
05.09 →	CAYC, CLNA	6J-9-000 001→	246-083-002-022G	SWP-D-C	
05.09 →	CAYC, CLNA	6J-9-000 001→	246-086-001-007C	HLWP	Plug Number (T2): 3b

**1.9 TDI (66 kW | 1.9 Litre)**

07.08 →	BXJ		246-082-008-025G	SWP-M-C	
07.08 →	BXJ		246-083-002-022G	SWP-D-C	
07.08 →	BXJ		246-086-001-007C	HLWP	Plug Number (T2): 3b

**1.9 TDI (77 kW | 1.9 Litre)**

03.08 →	BLS		246-082-008-025G	SWP-M-C	
03.08 →	BLS		246-083-002-022G	SWP-D-C	
03.08 →	BLS		246-086-001-007C	HLWP	Plug Number (T2): 3b

**2.0 (85 kW | 2.0 Litre)**

10.08 →	CEKA		246-082-008-025G	SWP-M-C	
10.08 →	CEKA		246-083-002-022G	SWP-D-C	
10.08 →	CEKA		246-086-001-007C	HLWP	Plug Number (T2): 3b

**2.0 TDI (105 kW | 2.0 Litre)**

01.10 →	CFHD	6J-9-000 001→	246-082-008-025G	SWP-M-C	
01.10 →	CFHD		246-083-002-022G	SWP-D-C	
01.10 →	CFHD	6J-9-000 001→	246-086-001-007C	HLWP	Plug Number (T2): 3b

**IBIZA V SPORTCOUPE (6J1)****1.2 (44 kW | 1.2 Litre)**

07.09 →	CGPB, CHFA	6J-9-000 001→	246-082-008-025G	SWP-M-C	
07.09 →	CGPB, CHFA	6J-9-000 001→	246-083-002-022G	SWP-D-C	
07.09 →	CGPB, CHFA	6J-9-000 001→	246-086-001-007C	HLWP	Plug Number (T2): 3b

**1.2 (51 kW | 1.2 Litre)**

07.08 →	BZG, CGPA		246-082-008-025G	SWP-M-C	
07.08 →	BZG, CGPA		246-083-002-022G	SWP-D-C	
07.08 →	BZG, CGPA		246-086-001-007C	HLWP	Plug Number (T2): 3b

**1.2 TDI (55 kW | 1.2 Litre)**

05.10 →	CFWA	6J-9-000 001→	246-082-008-025G	SWP-M-C	
---------	------	---------------	------------------	---------	--

**1.2 TSI (77 kW | 1.2 Litre)**

09.10 →	CBZB	6J-9-000 001→	246-082-008-025G	SWP-M-C	
09.10 →	CBZB		246-083-002-022G	SWP-D-C	
09.10 →	CBZB	6J-9-000 001→	246-086-001-007C	HLWP	Plug Number (T2): 3b

**1.4 (63 kW | 1.4 Litre)**

07.08 →	BXW, CGGB		246-082-008-025G	SWP-M-C	
07.08 →	BXW, CGGB		246-083-002-022G	SWP-D-C	
07.08 →	BXW, CGGB		246-086-001-007C	HLWP	Plug Number (T2): 3b

**1.4 TDI (59 kW | 1.4 Litre)**

07.08 →	BMS		246-082-008-025G	SWP-M-C	
07.08 →	BMS		246-083-002-022G	SWP-D-C	
07.08 →	BMS		246-086-001-007C	HLWP	Plug Number (T2): 3b

**1.4 TSI (110 kW | 1.4 Litre)**

06.09 →	CAVF	6J-9-000 001→	246-082-008-025G	SWP-M-C	
06.09 →	CAVF	6J-9-000 001→	246-083-002-022G	SWP-D-C	
06.09 →	CAVF	6J-9-000 001→	246-086-001-007C	HLWP	Plug Number (T2): 3b

**1.4 TSI Cupra (132 kW | 1.4 Litre)**

06.09 →	CAVE	6J-9-000 001→	246-082-008-025G	SWP-M-C	
06.09 →	CAVE	6J-9-000 001→	246-083-002-022G	SWP-D-C	
06.09 →	CAVE	6J-9-000 001→	246-086-001-007C	HLWP	Plug Number (T2): 3b

**1.6 (77 kW | 1.6 Litre)**

07.08 →	BTS		246-082-008-025G	SWP-M-C	
07.08 →	BTS		246-083-002-022G	SWP-D-C	



			<b>VDO</b>		
Date	Engine Code	Chassis No.	Article No.	Product	Information

**SEAT****IBIZA V SPORTCOUPE (6J1)****1.6 (77 kW | 1.6 Litre)**

07.08 →	BTS		246-086-001-007C	HLWP	Plug Number (T2): 3b
---------	-----	--	------------------	------	----------------------

**1.6 TDI (66 kW | 1.6 Litre)**

05.09 →	CAYB	6J-9-000 001→	246-082-008-025G	SWP-M-C	
05.09 →	CAYB	6J-9-000 001→	246-083-002-022G	SWP-D-C	
05.09 →	CAYB	6J-9-000 001→	246-086-001-007C	HLWP	Plug Number (T2): 3b

**1.6 TDI (77 kW | 1.6 Litre)**

05.09 →	CAYC, CLNA	6J-9-000 001→	246-082-008-025G	SWP-M-C	
05.09 →	CAYC, CLNA	6J-9-000 001→	246-083-002-022G	SWP-D-C	
05.09 →	CAYC, CLNA	6J-9-000 001→	246-086-001-007C	HLWP	Plug Number (T2): 3b

**1.9 TDI (66 kW | 1.9 Litre)**

07.08 →	BXJ		246-082-008-025G	SWP-M-C	
07.08 →	BXJ		246-083-002-022G	SWP-D-C	
07.08 →	BXJ		246-086-001-007C	HLWP	Plug Number (T2): 3b

**1.9 TDI (77 kW | 1.9 Litre)**

07.08 →	BLS		246-082-008-025G	SWP-M-C	
07.08 →	BLS		246-083-002-022G	SWP-D-C	
07.08 →	BLS		246-086-001-007C	HLWP	Plug Number (T2): 3b

**2.0 (85 kW | 2.0 Litre)**

10.08 →	CEKA		246-082-008-025G	SWP-M-C	
10.08 →	CEKA		246-083-002-022G	SWP-D-C	
10.08 →	CEKA		246-086-001-007C	HLWP	Plug Number (T2): 3b

**2.0 TDI (105 kW | 2.0 Litre)**

01.10 →	CFHD	6J-9-000 001→	246-082-008-025G	SWP-M-C	
01.10 →	CFHD		246-083-002-022G	SWP-D-C	
01.10 →	CFHD	6J-9-000 001→	246-086-001-007C	HLWP	Plug Number (T2): 3b

**IBIZA V ST (6J8)****1.2 (44 kW | 1.2 Litre)**

05.10 →	CGPB	6J-9-000 001→	246-082-008-025G	SWP-M-C	
05.10 →	CGPB		246-083-002-022G	SWP-D-C	
05.10 →	CGPB	6J-9-000 001→	246-086-001-007C	HLWP	Plug Number (T2): 3b

**1.2 (51 kW | 1.2 Litre)**

05.10 →	CGPA	6J-9-000 001→	246-082-008-025G	SWP-M-C	
05.10 →	CGPA		246-083-002-022G	SWP-D-C	
05.10 →	CGPA	6J-9-000 001→	246-086-001-007C	HLWP	Plug Number (T2): 3b

**1.2 TDI (55 kW | 1.2 Litre)**

04.10 →	CFWA	6J-9-000 001→	246-082-008-025G	SWP-M-C	
04.10 →	CFWA		246-083-002-022G	SWP-D-C	
04.10 →	CFWA	6J-9-000 001→	246-086-001-007C	HLWP	Plug Number (T2): 3b

**1.2 TSI (77 kW | 1.2 Litre)**

09.10 →	CBZB	6J-9-000 001→	246-082-008-025G	SWP-M-C	
09.10 →	CBZB		246-083-002-022G	SWP-D-C	
09.10 →	CBZB	6J-9-000 001→	246-086-001-007C	HLWP	Plug Number (T2): 3b

**1.4 (63 kW | 1.4 Litre)**

03.10 →	CGGB	6J-9-000 001→	246-082-008-025G	SWP-M-C	
03.10 →	CGGB		246-083-002-022G	SWP-D-C	
03.10 →	CGGB	6J-9-000 001→	246-086-001-007C	HLWP	Plug Number (T2): 3b

**1.6 TDI (66 kW | 1.6 Litre)**

03.10 →	CAYB	6J-9-000 001→	246-082-008-025G	SWP-M-C	
03.10 →	CAYB		246-083-002-022G	SWP-D-C	
03.10 →	CAYB	6J-9-000 001→	246-086-001-007C	HLWP	Plug Number (T2): 3b

**1.6 TDI (77 kW | 1.6 Litre)**

03.10 →	CAYC, CLNA	6J-9-000 001→	246-082-008-025G	SWP-M-C	
03.10 →	CAYC, CLNA		246-083-002-022G	SWP-D-C	
03.10 →	CAYC, CLNA	6J-9-000 001→	246-086-001-007C	HLWP	Plug Number (T2): 3b

**INCA (6K9)****1.4 16V (55 kW | 1.4 Litre)**

04.00 → 06.03	AUA		246-069-056-001Z	N	T24: Profi
04.00 → 06.03	AUA		246-080-010-002Z	N-H	T24: Profi
04.00 → 06.03	AUA		246-082-008-025G	SWP-M-C	T24: Profi
04.00 → 06.03	AUA		246-083-002-022G	SWP-D-C	T24: Profi



			<b>VDO</b>		
Date	Engine Code	Chassis No.	Article No.	Product	Information

**SEAT****INCA (6K9)****1.4 16V (55 kW | 1.4 Litre)**

04.00 → 06.03	AUA		246-086-001-002C	HLWP	Plug Number (T2): 3
---------------	-----	--	------------------	------	---------------------

**1.4 i (44 kW | 1.4 Litre)**

11.95 → 06.03	AEX, AKV, APQ, AUD		246-069-056-001Z	N	T24: Profi
11.95 → 06.03	AEX, AKV, APQ, AUD		246-080-010-002Z	N-H	T24: Profi
11.95 → 12.97	AEX, AKV, APQ, AUD		246-082-008-021G	SWP-M-C	Plug Number (T2): 6
11.95 → 06.03	AEX, AKV, APQ, AUD		246-082-008-025G	SWP-M-C	T24: Profi
11.95 → 12.97	AEX, AKV, APQ, AUD		246-083-002-014G	SWP-D-C	Plug Number (T2): 6
11.95 → 06.03	AEX, AKV, APQ, AUD		246-083-002-022G	SWP-D-C	T24: Profi
11.95 → 06.03	AEX, AKV, APQ, AUD		246-086-001-002C	HLWP	Plug Number (T2): 3

**1.6 (70 kW | 1.6 Litre)**

08.99 → 04.02			246-082-008-025G	SWP-M-C	
08.99 → 04.02			246-083-002-022G	SWP-D-C	

**1.6 i (55 kW | 1.6 Litre)**

11.95 → 05.98	1F		246-069-056-001Z	N	T24: Profi
11.95 → 05.98	1F		246-080-010-002Z	N-H	T24: Profi
11.95 → 05.98	1F		246-082-008-021G	SWP-M-C	Plug Number (T2): 6
06.97 → 09.00	ALM, AEE	→9K-1-008 000	246-082-008-021G	SWP-M-C	Plug Number (T2): 6
11.95 → 05.98	1F		246-082-008-025G	SWP-M-C	T24: Profi
06.97 → 09.00	ALM, AEE	→9K-1-008 000	246-082-008-025G	SWP-M-C	
11.95 → 05.98	1F		246-083-002-014G	SWP-D-C	Plug Number (T2): 6
11.95 → 05.98	1F		246-083-002-022G	SWP-D-C	T24: Profi
06.97 → 09.00	ALM, AEE	→9K-1-008 000	246-083-002-022G	SWP-D-C	
11.95 → 05.98	1F		246-086-001-002C	HLWP	Plug Number (T2): 3
06.97 → 09.00	ALM, AEE	9K-1-008 001→	246-086-001-007C	HLWP	Plug Number (T2): 3b

**1.7 D (42 kW | 1.7 Litre)**

09.96 → 06.03	AHB		246-069-056-001Z	N	T24: Profi
09.96 → 06.03	AHB		246-080-010-002Z	N-H	T24: Profi
09.96 → 06.03	AHB		246-082-008-021G	SWP-M-C	Plug Number (T2): 6
09.96 → 06.03	AHB		246-082-008-025G	SWP-M-C	T24: Profi
09.96 → 06.03	AHB		246-083-002-014G	SWP-D-C	Plug Number (T2): 6
09.96 → 06.03	AHB		246-083-002-022G	SWP-D-C	T24: Profi
09.96 → 06.03	AHB		246-086-001-002C	HLWP	Plug Number (T2): 3

**1.9 D (47 kW | 1.9 Litre)**

11.95 → 06.03	1Y		246-069-056-001Z	N	T24: Profi
11.95 → 06.03	1Y		246-080-010-002Z	N-H	T24: Profi
11.95 → 06.03	1Y		246-082-008-021G	SWP-M-C	Plug Number (T2): 6
11.95 → 06.03	1Y		246-082-008-025G	SWP-M-C	T24: Profi
11.95 → 06.03	1Y		246-083-002-014G	SWP-D-C	Plug Number (T2): 6
11.95 → 06.03	1Y		246-083-002-022G	SWP-D-C	T24: Profi
11.95 → 06.03	1Y		246-086-001-002C	HLWP	Plug Number (T2): 3

**1.9 SDI (47 kW | 1.9 Litre)**

11.95 → 06.03	AEY, AYQ		246-069-056-001Z	N	T24: Profi
11.95 → 06.03	AEY, AYQ		246-080-010-002Z	N-H	T24: Profi
09.96 → 06.03	AEY, AYQ		246-082-008-021G	SWP-M-C	Plug Number (T2): 6
11.95 → 06.03	AEY, AYQ		246-082-008-025G	SWP-M-C	T24: Profi
09.96 → 06.03	AEY, AYQ		246-083-002-014G	SWP-D-C	Plug Number (T2): 6
11.95 → 06.03	AEY, AYQ		246-083-002-022G	SWP-D-C	T24: Profi
11.95 → 06.03	AEY, AYQ		246-086-001-002C	HLWP	Plug Number (T2): 3

**1.9 TDI (66 kW | 1.9 Litre)**

09.96 → 06.03	ALH		246-069-056-001Z	N	T24: Profi
09.96 → 06.03	ALH		246-080-010-002Z	N-H	T24: Profi
09.96 → 06.03	ALH		246-082-008-025G	SWP-M-C	T24: Profi
09.96 → 06.03	ALH		246-083-002-022G	SWP-D-C	T24: Profi
09.96 → 06.03	ALH		246-086-001-002C	HLWP	Plug Number (T2): 3

**LEON (1M1)****1.4 16V (55 kW | 1.4 Litre)**

11.99 → 06.06	AUA, APE, AHW, AXP, BCA		246-069-056-001Z	N	
11.99 → 06.06	AUA, APE, AHW, AXP, BCA		246-080-010-002Z	N-H	T24: Stella →
11.99 → 06.06	AUA, APE, AHW, AXP, BCA		246-082-008-025G	SWP-M-C	
11.99 → 06.06	AUA, APE, AHW, AXP, BCA		246-083-002-022G	SWP-D-C	
11.99 → 06.06	AUA, APE, AHW, AXP, BCA		246-086-001-002C	HLWP	Plug Number (T2): 3; T24: Stella →



			<b>VDO</b>		
Date	Engine Code	Chassis No.	Article No.	Product	Information

**SEAT****LEON (1M1)****1.4 16V (55 kW | 1.4 Litre)**

11.99 → 06.06	AUA, APE, AHW, AXP, BCA		246-086-001-007C	HLWP	Plug Number (T2): 3b; T24: Stella →; T26: X11-246-003-014
---------------	-------------------------	--	------------------	------	-----------------------------------------------------------

**1.6 (74 kW | 1.6 Litre)**

11.99 → 06.06	APF, AKL, AEH		246-069-056-001Z	N	
11.99 → 06.06	APF, AKL, AEH		246-080-010-002Z	N-H	T24: Stella →
11.99 → 06.06	APF, AKL, AEH		246-082-008-025G	SWP-M-C	
11.99 → 06.06	APF, AKL, AEH		246-083-002-022G	SWP-D-C	
11.99 → 06.06	APF, AKL, AEH		246-086-001-002C	HLWP	Plug Number (T2): 3; T24: Stella →
11.99 → 06.06	APF, AKL, AEH		246-086-001-007C	HLWP	Plug Number (T2): 3b; T24: Stella →; T26: X11-246-003-014

**1.6 (75 kW | 1.6 Litre)**

10.05 → 06.06	BFQ		246-069-056-001Z	N	
10.05 → 06.06	BFQ	1P-6-000 001→	246-083-002-022G	SWP-D-C	

**1.6 16 V (77 kW | 1.6 Litre)**

09.00 → 06.06	ATN, AUS, AZD, BCB		246-069-056-001Z	N	
09.00 → 06.06	ATN, AUS, AZD, BCB		246-080-010-002Z	N-H	T24: Stella →
09.00 → 06.06	ATN, AUS, AZD, BCB		246-082-008-025G	SWP-M-C	
09.00 → 06.06	ATN, AUS, AZD, BCB		246-083-002-022G	SWP-D-C	
09.00 → 06.06	ATN, AUS, AZD, BCB		246-086-001-002C	HLWP	Plug Number (T2): 3; T24: Stella →
09.00 → 06.06	ATN, AUS, AZD, BCB		246-086-001-007C	HLWP	Plug Number (T2): 3b; T24: Stella →; T26: X11-246-003-014

**1.8 20V (92 kW | 1.8 Litre)**

11.99 → 06.06	AGN, APG		246-069-056-001Z	N	
11.99 → 06.06	AGN, APG		246-080-010-002Z	N-H	T24: Stella →
11.99 → 06.06	AGN, APG		246-082-008-025G	SWP-M-C	
11.99 → 06.06	AGN, APG		246-083-002-022G	SWP-D-C	
11.99 → 06.06	AGN, APG		246-086-001-002C	HLWP	Plug Number (T2): 3; T24: Stella →
11.99 → 06.06	AGN, APG		246-086-001-007C	HLWP	Plug Number (T2): 3b; T24: Stella →; T26: X11-246-003-014

**1.8 20V T (132 kW | 1.8 Litre)**

11.99 → 06.06	APP, AUQ		246-069-056-001Z	N	
11.99 → 06.06	APP, AUQ		246-080-010-002Z	N-H	T24: Stella →
11.99 → 06.06	APP, AUQ		246-082-008-025G	SWP-M-C	
11.99 → 06.06	APP, AUQ		246-083-002-022G	SWP-D-C	
11.99 → 06.06	APP, AUQ		246-086-001-002C	HLWP	Plug Number (T2): 3; T24: Stella →
11.99 → 06.06	APP, AUQ		246-086-001-007C	HLWP	Plug Number (T2): 3b; T24: Stella →; T26: X11-246-003-014

**1.8 20V T 4 (132 kW | 1.8 Litre)**

11.99 → 06.06	ARY, AJQ		246-069-056-001Z	N	
11.99 → 06.06	ARY, AJQ		246-080-010-002Z	N-H	T24: Stella →
11.99 → 06.06	AJQ		246-082-008-025G	SWP-M-C	
11.99 → 06.06	AJQ		246-083-002-022G	SWP-D-C	
11.99 → 06.06	ARY, AJQ		246-086-001-002C	HLWP	Plug Number (T2): 3; T24: Stella →
11.99 → 06.06	ARY, AJQ		246-086-001-007C	HLWP	Plug Number (T2): 3b; T24: Stella →; T26: X11-246-003-014

**1.8 T Cupra R (154 kW | 1.8 Litre)**

02.02 → 06.06	AMK		246-069-056-001Z	N	
02.02 → 06.06	AMK		246-080-010-002Z	N-H	T24: Stella →
02.02 → 06.06	AMK		246-082-008-025G	SWP-M-C	
02.02 → 06.06	AMK		246-083-002-022G	SWP-D-C	
02.02 → 06.06	AMK		246-086-001-002C	HLWP	Plug Number (T2): 3; T24: Stella →
02.02 → 06.06	AMK		246-086-001-007C	HLWP	Plug Number (T2): 3b; T24: Stella →; T26: X11-246-003-014

**1.8 T Cupra R (165 kW | 1.8 Litre)**

07.03 → 06.06	BAM		246-069-056-001Z	N	
07.03 → 06.06	BAM		246-082-008-025G	SWP-M-C	
07.03 → 06.06	BAM		246-083-002-022G	SWP-D-C	
07.03 → 06.06	BAM		246-086-001-007C	HLWP	Plug Number (T2): 3b

**1.8 Turbo 4x4 (154 kW | 1.8 Litre)**

05.02 → 05.03	AMK		246-069-056-001Z	N	
05.02 → 05.03	AMK		246-083-002-022G	SWP-D-C	T26: 1J0 955 665 H



			<b>VDO</b>		
Date	Engine Code	Chassis No.	Article No.	Product	Information

**SEAT****LEON (1M1)****1.9 SDI (50 kW | 1.9 Litre)**

11.99 → 06.06	AQM		246-069-056-001Z	N	
11.99 → 06.06	AQM		246-080-010-002Z	N-H	T24: Stella →
11.99 → 06.06	AQM		246-082-008-025G	SWP-M-C	
11.99 → 06.06	AQM		246-083-002-022G	SWP-D-C	
11.99 → 06.06	AQM		246-086-001-002C	HLWP	Plug Number (T2): 3; T24: Stella →
11.99 → 06.06	AQM		246-086-001-007C	HLWP	Plug Number (T2): 3b; T24: Stella →; T26: X11-246-003-014

**1.9 TDI (110 kW | 1.9 Litre)**

02.01 → 06.06	ARL		246-069-056-001Z	N	
02.01 → 06.06	ARL		246-080-010-002Z	N-H	T24: Stella →
02.01 → 06.06	ARL		246-082-008-025G	SWP-M-C	
02.01 → 06.06	ARL		246-083-002-022G	SWP-D-C	
02.01 → 06.06	ARL		246-086-001-002C	HLWP	Plug Number (T2): 3; T24: Stella →
02.01 → 06.06	ARL		246-086-001-007C	HLWP	Plug Number (T2): 3b; T24: Stella →; T26: X11-246-003-014

**1.9 TDI (66 kW | 1.9 Litre)**

11.99 → 06.06	ALH, AGR		246-069-056-001Z	N	
11.99 → 06.06	ALH, AGR		246-080-010-002Z	N-H	T24: Stella →
11.99 → 06.06	ALH, AGR		246-082-008-025G	SWP-M-C	
11.99 → 06.06	ALH, AGR		246-083-002-022G	SWP-D-C	
11.99 → 06.06	ALH, AGR		246-086-001-002C	HLWP	Plug Number (T2): 3; T24: Stella →
11.99 → 06.06	ALH, AGR		246-086-001-007C	HLWP	Plug Number (T2): 3b; T24: Stella →; T26: X11-246-003-014

**1.9 TDI (74 kW | 1.9 Litre)**

10.05 → 06.06	AXR		246-069-056-001Z	N	
10.05 → 06.06	AXR		246-083-002-022G	SWP-D-C	T26: 1J0 955 665 H

**1.9 TDI (81 kW | 1.9 Litre)**

11.99 → 06.06	ASV, AHF		246-069-056-001Z	N	
11.99 → 06.06	ASV, AHF		246-080-010-002Z	N-H	T24: Stella →
11.99 → 06.06	ASV, AHF		246-082-008-025G	SWP-M-C	
11.99 → 06.06	ASV, AHF		246-083-002-022G	SWP-D-C	
11.99 → 06.06	ASV, AHF		246-086-001-002C	HLWP	Plug Number (T2): 3; T24: Stella →
11.99 → 06.06	ASV, AHF		246-086-001-007C	HLWP	Plug Number (T2): 3b; T24: Stella →; T26: X11-246-003-014

**1.9 TDI (96 kW | 1.9 Litre)**

05.03 → 06.06	ASZ		246-069-056-001Z	N	
05.03 → 06.06	ASZ		246-082-008-025G	SWP-M-C	
05.03 → 06.06	ASZ		246-083-002-022G	SWP-D-C	
05.03 → 06.06	ASZ		246-086-001-007C	HLWP	Plug Number (T2): 3b

**1.9 TDI Syncro (110 kW | 1.9 Litre)**

05.02 → 06.06	ARL		246-069-056-001Z	N	
05.02 → 06.06	ARL		246-082-008-025G	SWP-M-C	
05.02 → 06.06	ARL		246-083-002-022G	SWP-D-C	
05.02 → 06.06	ARL		246-086-001-007C	HLWP	Plug Number (T2): 3b

**2.3 VR5 (125 kW | 2.3 Litre)**

09.00 → 11.03	AQN		246-069-056-001Z	N	
09.00 → 11.03	AQN		246-083-002-022G	SWP-D-C	T26: 1J0 955 665 H

**2.8 (150 kW | 2.8 Litre)**

05.02 → 06.04	BDE		246-069-056-001Z	N	
05.02 → 06.04	BDE		246-083-002-022G	SWP-D-C	T26: 1J0 955 665 H

**2.8 Cupra 4 (150 kW | 2.8 Litre)**

02.01 → 06.06	AUE		246-069-056-001Z	N	
02.01 → 06.06	AUE		246-080-010-002Z	N-H	T24: Stella →
02.01 → 06.06	AUE		246-082-008-025G	SWP-M-C	
02.01 → 06.06	AUE		246-083-002-022G	SWP-D-C	
02.01 → 06.06	AUE		246-086-001-002C	HLWP	Plug Number (T2): 3; T24: Stella →
02.01 → 06.06	AUE		246-086-001-007C	HLWP	Plug Number (T2): 3b; T24: Stella →; T26: X11-246-003-014

**LEON (1P1)****1.2 TSI (77 kW | 1.2 Litre)**

02.10 →	CBZB		246-083-002-022G	SWP-D-C	
---------	------	--	------------------	---------	--



			<b>VDO</b>		
Date	Engine Code	Chassis No.	Article No.	Product	Information

**SEAT****LEON (1P1)****1.4 16V (63 kW | 1.4 Litre)**

06.06 → BXW 246-083-002-022G SWP-D-C

**1.4 TSI (92 kW | 1.4 Litre)**

11.07 → CAXC 246-083-002-022G SWP-D-C

**1.6 (75 kW | 1.6 Litre)**

07.05 → BSE, BSF, CCSA, CMXA 1P-6-000 001→ 246-083-002-022G SWP-D-C

07.05 → BSE, BSF, CCSA, CMXA 1P-6-000 001→ 246-086-001-007C HLWP Plug Number (T2): 3b

**1.6 LPG (75 kW | 1.6 Litre)**

12.09 → CHGA 246-083-002-022G SWP-D-C

**1.8 TSI (118 kW | 1.8 Litre)**

06.07 → BZB, CDAA 246-083-002-022G SWP-D-C

**1.9 TDI (66 kW | 1.9 Litre)**

06.07 → BXF 246-083-002-022G SWP-D-C

**1.9 TDI (77 kW | 1.9 Litre)**

07.05 → BKC, BLS, BXE 1P-6-000 001→ 246-083-002-022G SWP-D-C

07.05 → BKC, BLS, BXE 1P-6-000 001→ 246-086-001-007C HLWP Plug Number (T2): 3b

**1.9 TDi (81 kW | 1.9 Litre)**

10.05 → ASV 246-083-002-022G SWP-D-C

**2.0 Cupra R (195 kW | 2.0 Litre)**

09.09 → CDLA 246-083-002-022G SWP-D-C

**2.0 FSI (110 kW | 2.0 Litre)**

07.05 → 05.10 BLR, BLY, BVY, BVZ 1P-6-000 001→ 246-083-002-022G SWP-D-C

07.05 → 05.10 BLR, BLY, BVY, BVZ 1P-6-000 001→ 246-086-001-007C HLWP Plug Number (T2): 3b

**2.0 TDI (100 kW | 2.0 Litre)**

07.05 → 05.10 AZV 246-083-002-022G SWP-D-C

**2.0 TDI (103 kW | 2.0 Litre)**

10.05 → BMM 246-083-002-022G SWP-D-C T26: 1J0 955 665 H

**2.0 TDI (125 kW | 2.0 Litre)**

05.06 → BMN, CEGA, CFJA 1M-6-000 001→ 246-083-002-022G SWP-D-C

**2.0 TDI 16V (103 kW | 2.0 Litre)**

07.05 → BKD, CFHC, CLCB 1P-6-000 001→ 246-083-002-022G SWP-D-C

07.05 → BKD, CFHC, CLCB 1P-6-000 001→ 246-086-001-007C HLWP Plug Number (T2): 3b

**2.0 TFSI (136 kW | 2.0 Litre)**

09.05 → 05.06 BWA1 1P-6-000 001→ 246-083-002-022G SWP-D-C

09.05 → 05.06 BWA1 1P-6-000 001→ 246-086-001-007C HLWP Plug Number (T2): 3b

**2.0 TFSI (147 kW | 2.0 Litre)**

05.05 → 03.09 BWA 246-083-002-022G SWP-D-C

**2.0 TFSI (155 kW | 2.0 Litre)**

06.09 → CCZB 246-083-002-022G SWP-D-C

**2.0 TFSI (177 kW | 2.0 Litre)**

11.06 → CDLD 246-083-002-022G SWP-D-C

**TOLEDO I (1L)****1.6 i (52 kW | 1.6 Litre)**

05.91 → 12.93 1F 246-080-010-002Z N-H T24: CL →

05.91 → 12.93 1F 246-082-008-014C SWP-M-C Plug Number (T2): 1

**1.6 i (54 kW | 1.6 Litre)**

05.91 → 03.99 1F, EZ, ABN 246-080-010-002Z N-H T24: CL →

05.91 → 03.99 1F, EZ, ABN 246-082-008-014C SWP-M-C Plug Number (T2): 1

**1.6 i (55 kW | 1.6 Litre)**

01.93 → 03.99 1F 246-080-010-002Z N-H T24: CL →

01.93 → 03.99 1F 246-082-008-014C SWP-M-C Plug Number (T2): 1

**1.6 i (74 kW | 1.6 Litre)**

11.96 → 03.99 AFT 246-080-010-002Z N-H T24: CL →

11.96 → 03.99 AFT 246-082-008-014C SWP-M-C Plug Number (T2): 1

**1.8 16V (92 kW | 1.8 Litre)**

05.91 → 03.99 PL 246-080-010-002Z N-H T24: CL →

05.91 → 03.99 PL 246-082-008-014C SWP-M-C Plug Number (T2): 1

**1.8 16V (98 kW | 1.8 Litre)**

05.91 → 03.99 KR 246-080-010-002Z N-H T24: CL →

05.91 → 03.99 KR 246-082-008-014C SWP-M-C Plug Number (T2): 1

**1.8 i (65 kW | 1.8 Litre)**

05.91 → 12.96 RP 246-080-010-002Z N-H T24: CL →



			<b>VDO</b>		
Date	Engine Code	Chassis No.	Article No.	Product	Information

**SEAT****TOLEDO I (1L)****1.8 i (65 kW | 1.8 Litre)**

05.91 - 12.96	RP		246-082-008-014C	SWP-M-C	Plug Number (T2): 1
---------------	----	--	------------------	---------	---------------------

**1.8 i (66 kW | 1.8 Litre)**

11.93 - 12.96	ABS, ADZ, ACC		246-080-010-002Z	N-H	T24: CL →
11.93 - 12.96	ABS, ADZ, ACC		246-082-008-014C	SWP-M-C	Plug Number (T2): 1

**1.9 D (47 kW | 1.9 Litre)**

12.95 - 03.99	1Y		246-080-010-002Z	N-H	T24: CL →
12.95 - 03.99	1Y		246-082-008-014C	SWP-M-C	Plug Number (T2): 1

**1.9 D (50 kW | 1.9 Litre)**

05.91 - 03.99	1Y		246-080-010-002Z	N-H	T24: CL →
05.91 - 03.99	1Y		246-082-008-014C	SWP-M-C	Plug Number (T2): 1

**1.9 TD (55 kW | 1.9 Litre)**

05.91 - 03.99	AAZ		246-080-010-002Z	N-H	T24: CL →
05.91 - 03.99	AAZ		246-082-008-014C	SWP-M-C	Plug Number (T2): 1

**1.9 TDI (66 kW | 1.9 Litre)**

08.95 - 03.99	1Z, AHU		246-080-010-002Z	N-H	T24: CL →
08.95 - 03.99	1Z, AHU		246-082-008-014C	SWP-M-C	Plug Number (T2): 1

**1.9 TDI (81 kW | 1.9 Litre)**

11.96 - 03.99	AFN		246-080-010-002Z	N-H	T24: CL →
11.96 - 03.99	AFN		246-082-008-014C	SWP-M-C	Plug Number (T2): 1

**2.0 i (85 kW | 2.0 Litre)**

05.91 - 03.99	2E, AGG		246-080-010-002Z	N-H	T24: CL →
05.91 - 03.99	2E, AGG		246-082-008-014C	SWP-M-C	Plug Number (T2): 1

**2.0 i 16V (110 kW | 2.0 Litre)**

11.93 - 03.99	ABF		246-080-010-002Z	N-H	T24: CL →
11.93 - 03.99	ABF		246-082-008-014C	SWP-M-C	Plug Number (T2): 1

**TOLEDO II (1M2)****1.4 16V (55 kW | 1.4 Litre)**

07.99 - 05.06	AUA, APE, AHW, BCA, AXP		246-069-056-001Z	N	
07.99 - 05.06	AUA, APE, AHW, BCA, AXP		246-080-010-002Z	N-H	T24: Stella →
07.99 - 05.06	AUA, APE, AHW, BCA, AXP	1M-X-000 001→	246-082-008-025G	SWP-M-C	
07.99 - 05.06	AUA, APE, AHW, BCA, AXP		246-086-001-002C	HLWP	Plug Number (T2): 3; T24: Stella →

**1.6 (74 kW | 1.6 Litre)**

04.99 - 09.00	APF, AEH, AKL		246-069-056-001Z	N	
04.99 - 09.00	APF, AEH, AKL		246-080-010-002Z	N-H	T24: Stella →
04.99 - 09.00	APF, AEH, AKL	1M-X-000 001→	246-082-008-025G	SWP-M-C	
04.99 - 09.00	APF, AEH, AKL		246-086-001-002C	HLWP	Plug Number (T2): 3; T24: Stella →

**1.6 (75 kW | 1.6 Litre)**

08.05 - 05.06	BFQ		246-083-002-022G	SWP-D-C	
08.05 - 05.06	BFQ		246-086-001-007C	HLWP	Plug Number (T2): 3b

**1.6 16V (77 kW | 1.6 Litre)**

09.00 - 05.06	AUS, AZD, BCB		246-069-056-001Z	N	
09.00 - 05.06	AUS, AZD, BCB		246-080-010-002Z	N-H	T24: Stella →
09.00 - 05.06	AUS, AZD, BCB	1M-X-000 001→	246-082-008-025G	SWP-M-C	
09.00 - 05.06	AUS, AZD, BCB		246-086-001-002C	HLWP	Plug Number (T2): 3; T24: Stella →

**1.8 20V (92 kW | 1.8 Litre)**

04.99 - 05.06	AGN, APG		246-069-056-001Z	N	
04.99 - 05.06	AGN, APG		246-080-010-002Z	N-H	T24: Stella →
04.99 - 05.06	AGN, APG	1M-X-000 001→	246-082-008-025G	SWP-M-C	
04.99 - 05.06	AGN, APG		246-086-001-002C	HLWP	Plug Number (T2): 3; T24: Stella →

**1.8 20VT (132 kW | 1.8 Litre)**

05.01 - 05.06	APP, AUQ	1M-X-000 001→	246-082-008-025G	SWP-M-C	
05.01 - 05.06	APP, AUQ	1M-X-000 001→	246-083-002-022G	SWP-D-C	
05.01 - 05.06	APP, AUQ	1M-X-000 001→ →1M-X-025 000	246-086-001-007C	HLWP	Plug Number (T2): 3b

**1.8 All-wheel Drive (132 kW | 1.8 Litre)**

05.01 - 04.04	ARY		246-086-001-007C	HLWP	Plug Number (T2): 3b
---------------	-----	--	------------------	------	----------------------

**1.8 All-wheel Drive (154 kW | 1.8 Litre)**

05.02 - 05.03	AMK		246-086-001-007C	HLWP	Plug Number (T2): 3b
---------------	-----	--	------------------	------	----------------------

**1.8 All-wheel Drive (165 kW | 1.8 Litre)**

05.03 - 10.05	BAM		246-086-001-007C	HLWP	Plug Number (T2): 3b
---------------	-----	--	------------------	------	----------------------





			<b>VDO</b>		
Date	Engine Code	Chassis No.	Article No.	Product	Information

**SEAT****TOLEDO II (1M2)****1.9 SDI (50 kW | 1.9 Litre)**

11.99 - 06.04	AQM		246-082-008-025G	SWP-M-C	
11.99 - 06.04	AQM		246-083-002-022G	SWP-D-C	
11.99 - 06.04	AQM		246-086-001-007C	HLWP	Plug Number (T2): 3b

**1.9 TDI (110 kW | 1.9 Litre)**

10.00 - 05.06	ARL		246-069-056-001Z	N	
10.00 - 05.06	ARL		246-080-010-002Z	N-H	T24: Stella →
10.00 - 05.06	ARL	1M-X-000 001→	246-082-008-025G	SWP-M-C	
10.00 - 05.06	ARL		246-086-001-002C	HLWP	Plug Number (T2): 3; T24: Stella →

**1.9 TDI (66 kW | 1.9 Litre)**

04.99 - 05.06	AGR, ALH		246-069-056-001Z	N	
04.99 - 05.06	AGR, ALH		246-080-010-002Z	N-H	T24: Stella →
04.99 - 05.06	AGR, ALH	1M-X-000 001→	246-082-008-025G	SWP-M-C	
04.99 - 05.06	AGR, ALH		246-086-001-002C	HLWP	Plug Number (T2): 3; T24: Stella →

**1.9 TDi (74 kW | 1.9 Litre)**

08.05 - 05.06	AXR		246-083-002-022G	SWP-D-C	
08.05 - 05.06	AXR		246-086-001-007C	HLWP	Plug Number (T2): 3b

**1.9 TDI (81 kW | 1.9 Litre)**

04.99 - 05.06	AHF, ASV		246-069-056-001Z	N	
04.99 - 05.06	AHF, ASV		246-080-010-002Z	N-H	T24: Stella →
04.99 - 05.06	AHF, ASV	1M-X-000 001→	246-082-008-025G	SWP-M-C	
04.99 - 05.06	AHF, ASV		246-086-001-002C	HLWP	Plug Number (T2): 3; T24: Stella →

**1.9 TDI (96 kW | 1.9 Litre)**

05.03 - 05.06	ASZ	1M-X-000 001→	246-082-008-025G	SWP-M-C	
05.03 - 05.06	ASZ	1M-X-000 001→	246-083-002-022G	SWP-D-C	
05.03 - 05.06	ASZ	1M-X-000 001→ →1M-X-025 000	246-086-001-007C	HLWP	Plug Number (T2): 3b

**2.3 V5 (110 kW | 2.3 Litre)**

04.99 - 05.01	AGZ		246-069-056-001Z	N	
04.99 - 05.01	AGZ		246-080-010-002Z	N-H	T24: Stella →
04.99 - 05.01	AGZ	1M-X-000 001→	246-082-008-025G	SWP-M-C	
04.99 - 05.01	AGZ		246-086-001-002C	HLWP	Plug Number (T2): 3; T24: Stella →

**2.3 V5 20V (125 kW | 2.3 Litre)**

05.01 - 05.06	AQN		246-069-056-001Z	N	
05.01 - 05.06	AQN		246-080-010-002Z	N-H	T24: Stella →
05.01 - 05.06	AQN	1M-X-000 001→	246-082-008-025G	SWP-M-C	
05.01 - 05.06	AQN		246-086-001-002C	HLWP	Plug Number (T2): 3; T24: Stella →

**2.8 (150 kW | 2.8 Litre)**

10.00 - 07.01	AUE	→1M-X-025 000	246-082-008-025G	SWP-M-C	
10.00 - 07.01	AUE		246-086-001-007C	HLWP	Plug Number (T2): 3b

**2.8 4x4 (150 kW | 2.8 Litre)**

05.02 - 04.04	BDE		246-082-008-025G	SWP-M-C	
05.02 - 04.04	BDE		246-086-001-007C	HLWP	Plug Number (T2): 3b

**TOLEDO III (5P2)****1.6 (75 kW | 1.6 Litre)**

10.04 - 05.09	CCSA		246-083-002-022G	SWP-D-C	
10.04 - 05.09	BGU, BSE, BSF, CCSA		246-086-001-007C	HLWP	Plug Number (T2): 3b

**1.8 TFSI (118 kW | 1.8 Litre)**

01.07 - 05.09	BZB, BYT, CDAA	5P-7-032 500→	246-083-002-022G	SWP-D-C	
01.07 - 05.09	BYT, BZB, CDAA		246-086-001-007C	HLWP	Plug Number (T2): 3b

**1.9 TDI (77 kW | 1.9 Litre)**

10.04 - 05.09	BJB, BKC, BXE, BLS		246-083-002-022G	SWP-D-C	
10.04 - 05.09	BJB, BKC, BXE, BLS		246-086-001-007C	HLWP	Plug Number (T2): 3b

**2.0 FSI (110 kW | 2.0 Litre)**

10.04 - 05.09	BLR		246-083-002-022G	SWP-D-C	
10.04 - 05.09	BLR, BLY, BVY, BVZ		246-086-001-007C	HLWP	Plug Number (T2): 3b

**2.0 TDI (100 kW | 2.0 Litre)**

09.04 - 05.09	AZV		246-086-001-007C	HLWP	Plug Number (T2): 3b
---------------	-----	--	------------------	------	----------------------

**2.0 TDI (103 kW | 2.0 Litre)**

11.05 - 05.09	BMM		246-083-002-022G	SWP-D-C	
11.05 - 05.09	BMM		246-086-001-007C	HLWP	Plug Number (T2): 3b



			<b>VDO</b>		
Date	Engine Code	Chassis No.	Article No.	Product	Information

**SEAT****TOLEDO III (5P2)****2.0 TDI (125 kW | 2.0 Litre)**

01.06 - 05.09	BMN, CEGA		246-083-002-022G	SWP-D-C	
01.06 - 05.09	BMN, CEGA		246-086-001-007C	HLWP	Plug Number (T2): 3b

**2.0 TDI 16V (103 kW | 2.0 Litre)**

04.04 - 05.09	BKD		246-083-002-022G	SWP-D-C	
04.04 - 05.09	BKD		246-086-001-007C	HLWP	Plug Number (T2): 3b

**2.0 TFSI (147 kW | 2.0 Litre)**

11.05 - 05.09	BWA	5P-7-032 500→	246-083-002-022G	SWP-D-C	
11.05 - 05.09	BWA		246-086-001-007C	HLWP	Plug Number (T2): 3b

**SKODA****FABIA (6Y2)****1.0 (37 kW | 1.0 Litre)**

12.99 - 08.02	ARV, AQV		246-082-008-025G	SWP-M-C	T24: Classic →
12.99 - 08.02	ARV, AQV		246-083-002-022G	SWP-D-C	T24: Classic →
12.99 - 08.02	ARV, AQV		246-086-001-002C	HLWP	Plug Number (T2): 3

**1.2 (40 kW | 1.2 Litre)**

08.02 - 03.08	AWY, BMD		246-082-008-025G	SWP-M-C	
08.02 - 03.08	AWY, BMD		246-083-002-022G	SWP-D-C	

**1.2 (47 kW | 1.2 Litre)**

01.03 - 03.08	AZQ, BME		246-083-002-022G	SWP-D-C	
---------------	----------	--	------------------	---------	--

**1.4 (44 kW | 1.4 Litre)**

08.00 - 08.02	AZE, AZF		246-082-008-025G	SWP-M-C	T24: Classic →
08.00 - 08.02	AZE, AZF		246-083-002-022G	SWP-D-C	T24: Classic →

**1.4 (50 kW | 1.4 Litre)**

08.99 - 03.08	ATZ, AME, AQW		246-083-002-022G	SWP-D-C	T24: Classic →
10.99 - 03.08	ATZ, AME, AQW		246-086-001-002C	HLWP	Plug Number (T2): 3

**1.4 16V (55 kW | 1.4 Litre)**

12.99 - 03.08	AUA, BBY, BKY		246-082-008-025G	SWP-M-C	T24: Classic →
12.99 - 03.08	AUA, BBY, BKY		246-083-002-022G	SWP-D-C	T24: Classic →

**1.4 16V (74 kW | 1.4 Litre)**

12.99 - 03.08	AUB, BBZ		246-082-008-025G	SWP-M-C	T24: Classic →
12.99 - 03.08	AUB, BBZ		246-083-002-022G	SWP-D-C	T24: Classic →
12.99 - 03.08	AUB, BBZ		246-086-001-002C	HLWP	Plug Number (T2): 3

**1.4 TDI (51 kW | 1.4 Litre)**

10.05 - 03.08	BNM		246-083-002-022G	SWP-D-C	
---------------	-----	--	------------------	---------	--

**1.4 TDI (55 kW | 1.4 Litre)**

04.03 - 03.08	AMF		246-083-002-022G	SWP-D-C	
---------------	-----	--	------------------	---------	--

**1.4 TDI (59 kW | 1.4 Litre)**

10.05 - 03.08	BNV		246-083-002-022G	SWP-D-C	
---------------	-----	--	------------------	---------	--

**1.9 SDI (47 kW | 1.9 Litre)**

12.99 - 03.08	ASY		246-082-008-025G	SWP-M-C	T24: Classic →
12.99 - 03.08	ASY		246-083-002-022G	SWP-D-C	T24: Classic →
12.99 - 03.08	ASY		246-086-001-002C	HLWP	Plug Number (T2): 3

**1.9 TDI (74 kW | 1.9 Litre)**

01.00 - 03.08	ATD, AXR		246-083-002-022G	SWP-D-C	T24: Classic →
02.00 - 03.08	ATD, AXR		246-086-001-002C	HLWP	Plug Number (T2): 3

**1.9 TDI RS (96 kW | 1.9 Litre)**

06.03 - 03.08	ASZ, BLT		246-082-008-025G	SWP-M-C	
06.03 - 03.08	ASZ, BLT		246-083-002-022G	SWP-D-C	

**2.0 (85 kW | 2.0 Litre)**

12.99 - 03.08	AQY, AZL		246-083-002-022G	SWP-D-C	T24: Classic →
---------------	----------	--	------------------	---------	----------------

**FABIA Saloon (6Y3)****1.2 (40 kW | 1.2 Litre)**

07.01 - 12.07	AWY		246-082-008-025G	SWP-M-C	
07.01 - 12.07	AWY, BMD		246-086-001-007C	HLWP	Plug Number (T2): 3b

**1.2 (47 kW | 1.2 Litre)**

01.03 - 12.07	AZQ, BME		246-082-008-025G	SWP-M-C	
---------------	----------	--	------------------	---------	--



			<b>VDO</b>		
Date	Engine Code	Chassis No.	Article No.	Product	Information

**SKODA****FABIA Saloon (6Y3)****1.4 (44 kW | 1.4 Litre)**

04.00 - 08.02	AZE		246-082-008-025G	SWP-M-C	
04.00 - 08.02	AZE, AZF		246-086-001-007C	HLWP	Plug Number (T2): 3b

**1.4 (50 kW | 1.4 Litre)**

07.01 - 12.07	AME, AQW, ATZ		246-082-008-025G	SWP-M-C	
---------------	---------------	--	------------------	---------	--

**1.4 16V (55 kW | 1.4 Litre)**

10.99 - 12.07	AUA, BBY, BKY		246-082-008-025G	SWP-M-C	
---------------	---------------	--	------------------	---------	--

**1.4 16V (59 kW | 1.4 Litre)**

04.06 - 12.07	BUD		246-082-008-025G	SWP-M-C	
04.06 - 12.07	BUD		246-086-001-007C	HLWP	Plug Number (T2): 3b

**1.4 16V (74 kW | 1.4 Litre)**

12.99 - 12.07	AUB, BBZ		246-082-008-025G	SWP-M-C	
---------------	----------	--	------------------	---------	--

**1.4 TDI (51 kW | 1.4 Litre)**

10.05 - 12.07	BNM		246-082-008-025G	SWP-M-C	
10.05 - 12.07	BNM		246-086-001-007C	HLWP	Plug Number (T2): 3b

**1.4 TDI (55 kW | 1.4 Litre)**

04.03 - 12.07	AMF		246-082-008-025G	SWP-M-C	
---------------	-----	--	------------------	---------	--

**1.4 TDI (59 kW | 1.4 Litre)**

10.05 - 12.07	BNV		246-082-008-025G	SWP-M-C	
10.05 - 12.07	BNV		246-086-001-007C	HLWP	Plug Number (T2): 3b

**1.9 SDI (47 kW | 1.9 Litre)**

11.99 - 12.07	ASY		246-082-008-025G	SWP-M-C	
---------------	-----	--	------------------	---------	--

**1.9 TDI (74 kW | 1.9 Litre)**

01.00 - 12.07	ATD, AXR		246-082-008-025G	SWP-M-C	
---------------	----------	--	------------------	---------	--

**2.0 (85 kW | 2.0 Litre)**

12.99 - 12.07	AZL		246-082-008-025G	SWP-M-C	
---------------	-----	--	------------------	---------	--

**FABIA Combi (6Y5)****1.2 (40 kW | 1.2 Litre)**

07.01 - 12.07	AWY, BMD		246-083-002-022G	SWP-D-C	
07.01 - 12.07	AWY, BMD		246-086-001-007C	HLWP	Plug Number (T2): 3b

**1.2 (47 kW | 1.2 Litre)**

01.03 - 12.07	AZQ, BME		246-083-002-022G	SWP-D-C	
01.03 - 12.07	AZQ, BME		246-086-001-007C	HLWP	Plug Number (T2): 3b

**1.4 (44 kW | 1.4 Litre)**

04.00 - 12.07	AZE, AZF		246-083-002-022G	SWP-D-C	
04.00 - 12.07	AZE, AZF		246-086-001-007C	HLWP	Plug Number (T2): 3b

**1.4 (50 kW | 1.4 Litre)**

04.00 - 12.07	AME, AQW, ATZ		246-083-002-022G	SWP-D-C	
04.00 - 12.07	AME, AQW, ATZ		246-086-001-007C	HLWP	Plug Number (T2): 3b

**1.4 16V (55 kW | 1.4 Litre)**

05.00 - 12.07	AUA, BBY, BKY		246-083-002-022G	SWP-D-C	
05.00 - 12.07	AUA, BBY, BKY		246-086-001-007C	HLWP	Plug Number (T2): 3b

**1.4 16V (59 kW | 1.4 Litre)**

04.06 - 12.07	BUD		246-083-002-022G	SWP-D-C	
04.06 - 12.07	BUD		246-086-001-007C	HLWP	Plug Number (T2): 3b

**1.4 16V (74 kW | 1.4 Litre)**

04.00 - 12.07	AUB, BBZ		246-083-002-022G	SWP-D-C	
04.00 - 12.07	AUB, BBZ		246-086-001-007C	HLWP	Plug Number (T2): 3b

**1.4 TDI (51 kW | 1.4 Litre)**

10.05 - 12.07	BNM		246-083-002-022G	SWP-D-C	
10.05 - 12.07	BNM		246-086-001-007C	HLWP	Plug Number (T2): 3b

**1.4 TDI (55 kW | 1.4 Litre)**

04.03 - 12.07	AMF		246-083-002-022G	SWP-D-C	
04.03 - 12.07	AMF		246-086-001-007C	HLWP	Plug Number (T2): 3b

**1.4 TDI (59 kW | 1.4 Litre)**

10.05 - 12.07	BNV		246-083-002-022G	SWP-D-C	
10.05 - 12.07	BNV		246-086-001-007C	HLWP	Plug Number (T2): 3b

**1.9 SDI (47 kW | 1.9 Litre)**

04.00 - 12.07	ASY		246-083-002-022G	SWP-D-C	
04.00 - 12.07	ASY		246-086-001-007C	HLWP	Plug Number (T2): 3b

**1.9 TDI (74 kW | 1.9 Litre)**

04.00 - 12.07	ATD, AXR		246-083-002-022G	SWP-D-C	
---------------	----------	--	------------------	---------	--



			<b>VDO</b>		
Date	Engine Code	Chassis No.	Article No.	Product	Information

**SKODA****FABIA Combi (6Y5)****1.9 TDI (74 kW | 1.9 Litre)**

04.00 → 12.07	ATD, AXR		246-086-001-007C	HLWP	Plug Number (T2): 3b
---------------	----------	--	------------------	------	----------------------

**2.0 (85 kW | 2.0 Litre)**

04.00 → 12.07	AZL		246-083-002-022G	SWP-D-C	
04.00 → 12.07	AZL		246-086-001-007C	HLWP	Plug Number (T2): 3b

**FABIA Praktik****1.2 (40 kW | 1.2 Litre)**

07.01 → 12.07	AWY, BMD		246-083-002-022G	SWP-D-C	
07.01 → 12.07	AWY, BMD		246-086-001-007C	HLWP	Plug Number (T2): 3b

**1.2 (47 kW | 1.2 Litre)**

01.03 → 12.07	AZQ, BME		246-083-002-022G	SWP-D-C	
---------------	----------	--	------------------	---------	--

**1.4 (50 kW | 1.4 Litre)**

07.01 → 12.07	AME, AQW, ATZ		246-083-002-022G	SWP-D-C	
07.01 → 12.07	AME, AQW, ATZ		246-086-001-007C	HLWP	Plug Number (T2): 3b

**1.4 TDI (51 kW | 1.4 Litre)**

10.05 → 12.07	BNM		246-083-002-022G	SWP-D-C	
10.05 → 12.07	BNM		246-086-001-007C	HLWP	Plug Number (T2): 3b

**1.9 SDI (47 kW | 1.9 Litre)**

07.01 → 12.07	ASY		246-083-002-022G	SWP-D-C	
---------------	-----	--	------------------	---------	--

**FABIA****1.2 (44 kW | 1.2 Litre)**

12.06 →	BBM, CHFA		246-082-008-025G	SWP-M-C	
12.06 →	BBM		246-083-002-022G	SWP-D-C	

**1.2 (51 kW | 1.2 Litre)**

01.07 →	BZG, CEVA, CGPA		246-082-008-025G	SWP-M-C	
01.07 →	BZG		246-083-002-022G	SWP-D-C	

**1.2 TDI (55 kW | 1.2 Litre)**

05.10 →	CFWA		246-082-008-025G	SWP-M-C	
05.10 →	CFWA		246-083-002-022G	SWP-D-C	

**1.2 TSI (63 kW | 1.2 Litre)**

03.10 →	CBZA		246-082-008-025G	SWP-M-C	
03.10 →	CBZA		246-083-002-022G	SWP-D-C	

**1.2 TSI (77 kW | 1.2 Litre)**

03.10 →	CBZB		246-082-008-025G	SWP-M-C	
03.10 →	CBZB		246-083-002-022G	SWP-D-C	

**1.4 (63 kW | 1.4 Litre)**

01.07 →	BXW		246-082-008-025G	SWP-M-C	
01.07 →	BXW, CGGB	5J-7-000 001 →	246-083-002-022G	SWP-D-C	

**1.4 TDI (51 kW | 1.4 Litre)**

02.07 →	BNM		246-082-008-025G	SWP-M-C	
02.07 →	BNM		246-083-002-022G	SWP-D-C	

**1.4 TDI (59 kW | 1.4 Litre)**

01.07 →	BMS, BNV		246-082-008-025G	SWP-M-C	
01.07 →	BMS, BNV	5J-7-000 001 →	246-083-002-022G	SWP-D-C	

**1.4 TSI (132 kW | 1.4 Litre)**

05.10 →	CAVE		246-082-008-025G	SWP-M-C	
05.10 →	CAVE		246-083-002-022G	SWP-D-C	

**1.6 (77 kW | 1.6 Litre)**

04.07 →	BTS		246-082-008-025G	SWP-M-C	
04.07 →	BTS		246-083-002-022G	SWP-D-C	

**1.6 TDI (55 kW | 1.6 Litre)**

04.10 →	CAYA		246-082-008-025G	SWP-M-C	
04.10 →	CAYA		246-083-002-022G	SWP-D-C	

**1.6 TDI (66 kW | 1.6 Litre)**

03.10 →	CAYB		246-082-008-025G	SWP-M-C	
03.10 →	CAYB		246-083-002-022G	SWP-D-C	

**1.6 TDI (77 kW | 1.6 Litre)**

03.10 →	CAYC		246-082-008-025G	SWP-M-C	
03.10 →	CAYC		246-083-002-022G	SWP-D-C	

**1.9 TDI (77 kW | 1.9 Litre)**

04.07 →	BLS, BSW		246-082-008-025G	SWP-M-C	
---------	----------	--	------------------	---------	--



			<b>VDO</b>		
Date	Engine Code	Chassis No.	Article No.	Product	Information

**SKODA****FABIA****1.9 TDI (77 kW | 1.9 Litre)**

04.07 -	BLS, BSW	5J-7-000 001→	246-083-002-022G	SWP-D-C	
---------	----------	---------------	------------------	---------	--

**FABIA Combi****1.2 (44 kW | 1.2 Litre)**

10.07 -	BBM, CHFA	5J-7-000 001→	246-083-002-022G	SWP-D-C	
10.07 -	BBM, CHFA	5J-7-000 001→ →5J-8-000 001	246-086-001-007C	HLWP	Plug Number (T2): 3b

**1.2 (51 kW | 1.2 Litre)**

10.07 -	BZG, CEVA, CGPA, CHTA	5J-7-000 001→	246-083-002-022G	SWP-D-C	
10.07 -	BZG, CEVA, CGPA	5J-7-000 001→ →5J-8-000 001	246-086-001-007C	HLWP	Plug Number (T2): 3b

**1.2 TDI (55 kW | 1.2 Litre)**

05.10 -	CFWA		246-083-002-022G	SWP-D-C	
05.10 -	CFWA		246-086-001-007C	HLWP	Plug Number (T2): 3b

**1.2 TSI (63 kW | 1.2 Litre)**

03.10 -	CBZA		246-083-002-022G	SWP-D-C	
03.10 -	CBZA		246-086-001-007C	HLWP	Plug Number (T2): 3b

**1.2 TSI (77 kW | 1.2 Litre)**

03.10 -	CBZB		246-083-002-022G	SWP-D-C	
03.10 -	CBZB		246-086-001-007C	HLWP	Plug Number (T2): 3b

**1.4 (63 kW | 1.4 Litre)**

10.07 -	BXW, CGGB	5J-7-000 001→	246-083-002-022G	SWP-D-C	
10.07 -	BXW	5J-7-000 001→ →5J-8-000 001	246-086-001-007C	HLWP	Plug Number (T2): 3b

**1.4 TDI (51 kW | 1.4 Litre)**

10.07 -	BNM	5J-7-000 001→	246-083-002-022G	SWP-D-C	
10.07 -	BNM	5J-7-000 001→ →5J-8-000 001	246-086-001-007C	HLWP	Plug Number (T2): 3b

**1.4 TDI (59 kW | 1.4 Litre)**

10.07 -	BMS, BNV	5J-7-000 001→	246-083-002-022G	SWP-D-C	
10.07 -	BMS, BNV	5J-7-000 001→ →5J-8-000 001	246-086-001-007C	HLWP	Plug Number (T2): 3b

**1.4 TSI (132 kW | 1.4 Litre)**

05.10 -	CAVE		246-083-002-022G	SWP-D-C	
05.10 -	CAVE		246-086-001-007C	HLWP	Plug Number (T2): 3b

**1.6 (77 kW | 1.6 Litre)**

10.07 -	BTS, CFNA	5J-7-000 001→	246-083-002-022G	SWP-D-C	
10.07 -	BTS	5J-7-000 001→ →5J-8-000 001	246-086-001-007C	HLWP	Plug Number (T2): 3b

**1.6 TDI (55 kW | 1.6 Litre)**

04.10 -	CAYA		246-083-002-022G	SWP-D-C	
04.10 -	CAYA		246-086-001-007C	HLWP	Plug Number (T2): 3b

**1.6 TDI (66 kW | 1.6 Litre)**

03.10 -	CAYB		246-083-002-022G	SWP-D-C	
03.10 -	CAYB		246-086-001-007C	HLWP	Plug Number (T2): 3b

**1.6 TDI (77 kW | 1.6 Litre)**

03.10 -	CAYC		246-083-002-022G	SWP-D-C	
03.10 -	CAYC		246-086-001-007C	HLWP	Plug Number (T2): 3b

**1.9 TDI (77 kW | 1.9 Litre)**

10.07 -	BSW, BLS	5J-7-000 001→	246-083-002-022G	SWP-D-C	
10.07 -	BLS, BSW	5J-7-000 001→ →5J-8-000 001	246-086-001-007C	HLWP	Plug Number (T2): 3b

**OCTAVIA (1U2)****1.4 (44 kW | 1.4 Litre)**

04.99 - 03.01	AMD		246-082-008-025G	SWP-M-C	
04.99 - 03.01	AMD		246-083-002-022G	SWP-D-C	
04.99 - 03.01	AMD		246-086-001-007C	HLWP	Plug Number (T2): 3b; T24: LX →; T26: X11-246-003-014

**1.4 16V (55 kW | 1.4 Litre)**

09.00 - 12.10	AXP		246-082-008-025G	SWP-M-C	
09.00 - 12.10	AXP		246-083-002-022G	SWP-D-C	



			<b>VDO</b>		
Date	Engine Code	Chassis No.	Article No.	Product	Information

**SKODA****OCTAVIA (1U2)****1.4 16V (55 kW | 1.4 Litre)**

09.00 - 12.10	AXP, BCA		246-086-001-007C	HLWP	Plug Number (T2): 3b; T24: LX →; T26: X11-246-003-014
---------------	----------	--	------------------	------	-------------------------------------------------------

**1.6 (55 kW | 1.6 Litre)**

09.96 - 09.04	AEE		246-082-008-025G	SWP-M-C	
09.96 - 09.04	AEE		246-083-002-022G	SWP-D-C	
10.96 - 07.98	AEE		246-086-001-002C	HLWP	Plug Number (T2): 3
09.96 - 09.04	AEE		246-086-001-007C	HLWP	Plug Number (T2): 3b; T24: LX →; T26: X11-246-003-014

**1.6 (74 kW | 1.6 Litre)**

02.97 - 12.07	AKL		246-082-008-025G	SWP-M-C	
02.97 - 12.07	AKL		246-083-002-022G	SWP-D-C	
02.97 - 12.97	AEH, AKL		246-086-001-002C	HLWP	Plug Number (T2): 3
02.97 - 12.07	AEH, AKL		246-086-001-007C	HLWP	Plug Number (T2): 3b; T24: LX →; T26: X11-246-003-014

**1.6 (75 kW | 1.6 Litre)**

11.00 - 12.10	AVU		246-082-008-025G	SWP-M-C	
11.00 - 12.10	AVU		246-083-002-022G	SWP-D-C	
11.00 - 12.10	AVU, BFQ		246-086-001-007C	HLWP	Plug Number (T2): 3b; T24: LX →; T26: X11-246-003-014

**1.8 (92 kW | 1.8 Litre)**

09.96 - 07.00	AGN		246-082-008-025G	SWP-M-C	
09.96 - 07.00	AGN		246-083-002-022G	SWP-D-C	
10.96 - 04.99	AGN		246-086-001-002C	HLWP	Plug Number (T2): 3
09.96 - 07.00	AGN		246-086-001-007C	HLWP	Plug Number (T2): 3b; T24: LX →; T26: X11-246-003-014

**1.8 T (110 kW | 1.8 Litre)**

08.97 - 12.10	ARX		246-082-008-025G	SWP-M-C	
08.97 - 12.10	ARX		246-083-002-022G	SWP-D-C	
08.97 - 04.99	ARZ, AGU, ARX, AUM		246-086-001-002C	HLWP	Plug Number (T2): 3
08.97 - 12.10	ARZ, AGU, ARX, AUM		246-086-001-007C	HLWP	Plug Number (T2): 3b; T24: LX →; T26: X11-246-003-014

**1.8 T 4x4 (110 kW | 1.8 Litre)**

05.01 - 05.06	AUM		246-082-008-025G	SWP-M-C	
05.01 - 05.06	AUM		246-083-002-022G	SWP-D-C	
05.01 - 05.06	ARX		246-086-001-007C	HLWP	Plug Number (T2): 3b; T24: LX →; T26: X11-246-003-014

**1.9 SDI (50 kW | 1.9 Litre)**

06.97 - 12.03	AGP		246-082-008-025G	SWP-M-C	
06.97 - 12.03	AGP		246-083-002-022G	SWP-D-C	
06.97 - 12.03	AGP, AQM		246-086-001-002C	HLWP	Plug Number (T2): 3
06.97 - 12.03	AGP, AQM		246-086-001-007C	HLWP	Plug Number (T2): 3b; T24: LX →; T26: X11-246-003-014

**1.9 TDI (66 kW | 1.9 Litre)**

09.96 - 03.10	ALH		246-082-008-025G	SWP-M-C	
09.96 - 03.10	ALH		246-083-002-022G	SWP-D-C	
10.96 - 03.10	ALH, AGR		246-086-001-002C	HLWP	Plug Number (T2): 3
09.96 - 03.10	ALH, AGR		246-086-001-007C	HLWP	Plug Number (T2): 3b; T24: LX →; T26: X11-246-003-014

**1.9 TDI (74 kW | 1.9 Litre)**

10.05 - 12.10	AXR		246-082-008-025G	SWP-M-C	
---------------	-----	--	------------------	---------	--

**1.9 TDI (81 kW | 1.9 Litre)**

08.97 - 01.06	AHF		246-082-008-025G	SWP-M-C	
08.97 - 01.06	AHF		246-083-002-022G	SWP-D-C	
08.97 - 01.06	ASV, AHF		246-086-001-007C	HLWP	Plug Number (T2): 3b; T24: LX →; T26: X11-246-003-014

**1.9 TDI (96 kW | 1.9 Litre)**

09.02 - 09.04	ASZ		246-082-008-025G	SWP-M-C	
09.02 - 09.04	ASZ		246-083-002-022G	SWP-D-C	

**2.0 (85 kW | 2.0 Litre)**

04.99 - 05.07	AZH		246-082-008-025G	SWP-M-C	
04.99 - 05.07	AZH		246-083-002-022G	SWP-D-C	
05.99 - 05.07	AQY, APK, AZH, AEG, AZJ		246-086-001-002C	HLWP	Plug Number (T2): 3



			<b>VDO</b>		
Date	Engine Code	Chassis No.	Article No.	Product	Information

**SKODA****OCTAVIA (1U2)****2.0 (85 kW | 2.0 Litre)**

04.99 - 05.07	AQY, APK, AZH, AEG, AZJ		246-086-001-007C	HLWP	Plug Number (T2): 3b; T24: LX →; T26: X11-246-003-014
---------------	-------------------------	--	------------------	------	-------------------------------------------------------

**RS 1.8 T (132 kW | 1.8 Litre)**

05.01 - 01.06	AUQ		246-082-008-025G	SWP-M-C	
05.01 - 01.06	AUQ		246-083-002-022G	SWP-D-C	
05.01 - 01.06	AUQ		246-086-001-007C	HLWP	Plug Number (T2): 3b; T24: LX →; T26: X11-246-003-014

**OCTAVIA Combi (1U5)****1.4 16V (55 kW | 1.4 Litre)**

08.00 - 12.10	BCA		246-082-008-025G	SWP-M-C	
08.00 - 12.10	BCA		246-083-002-022G	SWP-D-C	
08.00 - 12.10	AXP, BCA		246-086-001-007C	HLWP	Plug Number (T2): 3b; T26: X11-246-003-014
08.00 - 12.10	AXP, BCA		246-086-001-007C	HLWP	Plug Number (T2): 3b; T24: LX →; T26: X11-246-003-014

**1.6 (55 kW | 1.6 Litre)**

07.98 - 09.04	AEE		246-082-008-025G	SWP-M-C	
07.98 - 09.04	AEE		246-083-002-022G	SWP-D-C	
07.98 - 09.04	AEE		246-086-001-002C	HLWP	Plug Number (T2): 3
07.98 - 09.04	AEE		246-086-001-007C	HLWP	Plug Number (T2): 3b; T24: LX →; T26: X11-246-003-014

**1.6 (74 kW | 1.6 Litre)**

07.98 - 12.07	AKL		246-082-008-025G	SWP-M-C	
07.98 - 12.07	AKL		246-083-002-022G	SWP-D-C	
07.98 - 07.98	AEH, AKL		246-086-001-002C	HLWP	Plug Number (T2): 3
07.98 - 12.07	AEH, AKL		246-086-001-007C	HLWP	Plug Number (T2): 3b; T24: LX →; T26: X11-246-003-014

**1.6 (75 kW | 1.6 Litre)**

09.00 - 12.10	BFQ		246-082-008-025G	SWP-M-C	
09.00 - 12.10	BFQ		246-083-002-022G	SWP-D-C	
09.00 - 12.10	AVU, BFQ		246-086-001-007C	HLWP	Plug Number (T2): 3b; T24: LX →; T26: X11-246-003-014

**1.8 20V (92 kW | 1.8 Litre)**

07.98 - 07.00	AGN		246-082-008-025G	SWP-M-C	
07.98 - 07.00	AGN		246-083-002-022G	SWP-D-C	
08.98 - 04.99	AGN		246-086-001-002C	HLWP	Plug Number (T2): 3
07.98 - 07.00	AGN		246-086-001-007C	HLWP	Plug Number (T2): 3b; T24: LX →; T26: X11-246-003-014

**1.8 T (110 kW | 1.8 Litre)**

07.98 - 12.10	ARZ		246-082-008-025G	SWP-M-C	
07.98 - 12.10	ARZ		246-083-002-022G	SWP-D-C	
07.98 - 07.98	AGU, ARZ, ARX, AUM		246-086-001-002C	HLWP	Plug Number (T2): 3
07.98 - 12.10	AGU, ARZ, ARX, AUM		246-086-001-007C	HLWP	Plug Number (T2): 3b; T24: LX →; T26: X11-246-003-014

**1.8 T 4x4 (110 kW | 1.8 Litre)**

05.01 - 05.06	AUM		246-083-002-022G	SWP-D-C	
05.01 - 05.06	ARX		246-086-001-007C	HLWP	Plug Number (T2): 3b; T24: LX →; T26: X11-246-003-014

**1.9 SDI (50 kW | 1.9 Litre)**

07.98 - 12.03	AQM		246-082-008-025G	SWP-M-C	
07.98 - 12.03	AQM		246-083-002-022G	SWP-D-C	
08.98 - 12.03	AGP, AQM		246-086-001-002C	HLWP	Plug Number (T2): 3
07.98 - 12.03	AGP, AQM		246-086-001-007C	HLWP	Plug Number (T2): 3b; T24: LX →; T26: X11-246-003-014

**1.9 TDI (66 kW | 1.9 Litre)**

07.98 - 03.10	AGR		246-082-008-025G	SWP-M-C	
07.98 - 03.10	AGR		246-083-002-022G	SWP-D-C	
07.98 - 07.98	ALH, AGR		246-086-001-002C	HLWP	Plug Number (T2): 3
07.98 - 03.10	ALH, AGR		246-086-001-007C	HLWP	Plug Number (T2): 3b; T24: LX →; T26: X11-246-003-014

**1.9 TDI (74 kW | 1.9 Litre)**

08.00 - 12.10	AXR		246-082-008-025G	SWP-M-C	
---------------	-----	--	------------------	---------	--



			<b>VDO</b>		
Date	Engine Code	Chassis No.	Article No.	Product	Information

**SKODA****OCTAVIA Combi (1U5)****1.9 TDI (74 kW | 1.9 Litre)**

08.00 - 12.10	ATD, AXR		246-086-001-007C	HLWP	Plug Number (T2): 3b
---------------	----------	--	------------------	------	----------------------

**1.9 TDI (81 kW | 1.9 Litre)**

07.98 - 01.06	AHF		246-082-008-025G	SWP-M-C	
07.98 - 01.06	AHF		246-083-002-022G	SWP-D-C	
10.00 - 01.06	ASV, AHF		246-086-001-002C	HLWP	Plug Number (T2): 3
07.98 - 01.06	ASV, AHF		246-086-001-007C	HLWP	Plug Number (T2): 3b; T24: LX ↔; T26: X11-246-003-014

**1.9 TDI (96 kW | 1.9 Litre)**

09.02 - 09.04	ASZ		246-083-002-022G	SWP-D-C	
---------------	-----	--	------------------	---------	--

**1.9 TDI 4x4 (66 kW | 1.9 Litre)**

11.99 - 02.06	AGR		246-082-008-025G	SWP-M-C	
11.99 - 02.06	AGR		246-083-002-022G	SWP-D-C	
11.99 - 02.06	AGR		246-086-001-002C	HLWP	Plug Number (T2): 3
11.99 - 02.06	AGR		246-086-001-007C	HLWP	Plug Number (T2): 3b; T24: LX ↔; T26: X11-246-003-014

**1.9 TDI 4x4 (74 kW | 1.9 Litre)**

09.00 - 01.06	ATD		246-082-008-025G	SWP-M-C	
09.00 - 01.06	ATD		246-083-002-022G	SWP-D-C	
09.00 - 01.06	ATD		246-086-001-007C	HLWP	Plug Number (T2): 3b; T24: LX ↔; T26: X11-246-003-014

**2.0 (85 kW | 2.0 Litre)**

04.99 - 05.07	AZH		246-082-008-025G	SWP-M-C	
04.99 - 05.07	AZH		246-083-002-022G	SWP-D-C	
11.99 - 05.07	APK, AQY, AZH, AEG, AZJ		246-086-001-002C	HLWP	Plug Number (T2): 3
04.99 - 05.07	APK, AQY, AZH, AEG, AZJ		246-086-001-007C	HLWP	Plug Number (T2): 3b; T24: LX ↔; T26: X11-246-003-014

**2.0 4x4 (85 kW | 2.0 Litre)**

08.00 - 09.04	AQY		246-083-002-022G	SWP-D-C	
08.00 - 09.04	AZH, AZJ		246-086-001-007C	HLWP	Plug Number (T2): 3b; T24: LX ↔; T26: X11-246-003-014

**2.0 4x4 (88 kW | 2.0 Litre)**

01.00 - 12.10	ATF		246-082-008-025G	SWP-M-C	
01.00 - 12.10	ATF		246-083-002-022G	SWP-D-C	
01.00 - 12.10	ATF		246-086-001-007C	HLWP	Plug Number (T2): 3b; T24: LX ↔; T26: X11-246-003-014

**RS 1.8 T (132 kW | 1.8 Litre)**

08.02 - 01.06	AUQ		246-083-002-022G	SWP-D-C	
---------------	-----	--	------------------	---------	--

**OCTAVIA (1Z3)****1.2 TSI (77 kW | 1.2 Litre)**

02.10 -	CBZB	1U-9-000 001↔	246-082-008-025G	SWP-M-C	
02.10 -	CBZB	1Z-9-000 001↔	246-083-002-022G	SWP-D-C	
02.10 -	CBZB		246-086-001-007C	HLWP	Plug Number (T2): 3b

**1.4 (55 kW | 1.4 Litre)**

05.04 - 05.06	BCA		246-082-008-025G	SWP-M-C	
05.04 - 05.06	BCA		246-083-002-022G	SWP-D-C	
05.04 - 05.06	BCA	1Z-4-000 001↔	246-086-001-007C	HLWP	Plug Number (T2): 3b

**1.4 (59 kW | 1.4 Litre)**

06.04 -	BUD		246-082-008-025G	SWP-M-C	
06.04 -	BUD	1Z-4-000 001↔	246-083-002-022G	SWP-D-C	
06.04 -	BUD	1Z-4-000 001↔	246-086-001-007C	HLWP	Plug Number (T2): 3b

**1.4 TSI (90 kW | 1.4 Litre)**

11.08 -	CAXA		246-082-008-025G	SWP-M-C	
11.08 -	CAXA	1Z-5-000 001↔	246-083-002-022G	SWP-D-C	
11.08 -	CAXA	1Z-5-000 001↔	246-086-001-007C	HLWP	Plug Number (T2): 3b

**1.6 (75 kW | 1.6 Litre)**

06.04 -	BSF		246-082-008-025G	SWP-M-C	
06.04 -	BSF		246-083-002-022G	SWP-D-C	
06.04 -	BGU, BSE, BSF, CCSA, CMXA	1Z-4-000 001↔	246-086-001-007C	HLWP	Plug Number (T2): 3b

**1.6 FSI (85 kW | 1.6 Litre)**

02.04 - 10.08	BLF	1U-4-000 001↔	246-082-008-025G	SWP-M-C	
02.04 - 10.08	BLF	1U-4-000 001↔	246-083-002-022G	SWP-D-C	





			<b>VDO</b>		
Date	Engine Code	Chassis No.	Article No.	Product	Information

**SKODA****OCTAVIA (1Z3)****1.6 FSI (85 kW | 1.6 Litre)**

02.04 → 10.08	BLF	1Z-4-000 001→	246-086-001-007C	HLWP	Plug Number (T2): 3b
---------------	-----	---------------	------------------	------	----------------------

**1.6 LPG (75 kW | 1.6 Litre)**

08.09 →	CHGA	1Z-9-000 001→	246-083-002-022G	SWP-D-C	
---------	------	---------------	------------------	---------	--

**1.6 MultiFuel (75 kW | 1.6 Litre)**

01.08 →	CCSA		246-082-008-025G	SWP-M-C	
01.08 →	CCSA	1Z-5-000 001→	246-083-002-022G	SWP-D-C	
01.08 →	CCSA	1Z-5-000 001→	246-086-001-007C	HLWP	Plug Number (T2): 3b

**1.6 TDI (77 kW | 1.6 Litre)**

06.09 →	CAYC	1Z-9-000 001→	246-082-008-025G	SWP-M-C	
06.09 →	CAYC	1Z-9-000 001→	246-083-002-022G	SWP-D-C	
06.09 →	CAYC	1Z-9-000 001→	246-086-001-007C	HLWP	Plug Number (T2): 3b

**1.8 TSI (118 kW | 1.8 Litre)**

06.07 →	BZB		246-082-008-025G	SWP-M-C	
06.07 →	BZB	1Z-5-000 001→	246-083-002-022G	SWP-D-C	
06.07 →	BZB		246-086-001-007C	HLWP	Plug Number (T2): 3b

**1.9 TDI (77 kW | 1.9 Litre)**

06.04 → 12.10	BLS		246-082-008-025G	SWP-M-C	
06.04 → 12.10	BLS		246-083-002-022G	SWP-D-C	
06.04 → 12.10	BKC, BJB, BXE, BLS	1Z-4-000 001→	246-086-001-007C	HLWP	Plug Number (T2): 3b

**2.0 FSI (110 kW | 2.0 Litre)**

11.04 →	BLY		246-082-008-025G	SWP-M-C	
11.04 →	BLY		246-083-002-022G	SWP-D-C	
11.04 →	BLR, BLY, BVY, BVZ	1Z-4-000 001→	246-086-001-007C	HLWP	Plug Number (T2): 3b

**2.0 RS (147 kW | 2.0 Litre)**

10.05 →	BWA		246-082-008-025G	SWP-M-C	
10.05 →	BWA, CCZA	1Z-5-000 001→	246-083-002-022G	SWP-D-C	
10.05 →	BWA, CCZA		246-086-001-007C	HLWP	Plug Number (T2): 3b

**2.0 TDI (100 kW | 2.0 Litre)**

02.04 → 05.10	AZV		246-082-008-025G	SWP-M-C	
02.04 → 05.10	AZV	1Z-4-000 001→	246-083-002-022G	SWP-D-C	
02.04 → 05.10	AZV	1Z-4-000 001→	246-086-001-007C	HLWP	Plug Number (T2): 3b

**2.0 TDI (103 kW | 2.0 Litre)**

11.05 →	BMM	1U-5-000 001→	246-082-008-025G	SWP-M-C	
11.05 →	BMM	1Z-5-000 001→	246-083-002-022G	SWP-D-C	
11.05 →	BMM		246-086-001-007C	HLWP	Plug Number (T2): 3b

**2.0 TDI 16V (103 kW | 2.0 Litre)**

02.04 →	BKD		246-082-008-025G	SWP-M-C	
02.04 →	BKD		246-083-002-022G	SWP-D-C	
02.04 →	BKD, CFHC, CLCB	1Z-4-000 001→	246-086-001-007C	HLWP	Plug Number (T2): 3b

**2.0 TDI RS (125 kW | 2.0 Litre)**

04.06 →	BMN		246-082-008-025G	SWP-M-C	
04.06 →	BMN, CEGA	1Z-5-000 001→	246-083-002-022G	SWP-D-C	
04.06 →	BMN, CEGA		246-086-001-007C	HLWP	Plug Number (T2): 3b

**OCTAVIA Combi (1Z5)****1.2 TSI (77 kW | 1.2 Litre)**

02.10 →	CBZB	1U-9-000 001→	246-082-008-025G	SWP-M-C	
02.10 →	CBZB	1U-9-000 001→	246-083-002-022G	SWP-D-C	
02.10 →	CBZB		246-086-001-007C	HLWP	Plug Number (T2): 3b

**1.4 (59 kW | 1.4 Litre)**

05.06 →	BUD, CGGA	1U-5-000 001→	246-082-008-025G	SWP-M-C	
05.06 →	BUD	1Z-5-000 001→	246-083-002-022G	SWP-D-C	
05.06 →	BUD		246-086-001-007C	HLWP	Plug Number (T2): 3b

**1.4 TSI (90 kW | 1.4 Litre)**

11.08 →	CAXA		246-082-008-025G	SWP-M-C	
11.08 →	CAXA	1Z-5-000 001→	246-083-002-022G	SWP-D-C	
11.08 →	CAXA	1Z-5-000 001→	246-086-001-007C	HLWP	Plug Number (T2): 3b

**1.6 (75 kW | 1.6 Litre)**

09.04 →	BSE		246-082-008-025G	SWP-M-C	
09.04 →	BSE		246-083-002-022G	SWP-D-C	
09.04 →	BGU, BSE, BSF, CCSA, CMXA	1Z-4-000 001→	246-086-001-007C	HLWP	Plug Number (T2): 3b



			<b>VDO</b>		
Date	Engine Code	Chassis No.	Article No.	Product	Information

**SKODA****OCTAVIA Combi (1Z5)**

<b>1.6 FSI (85 kW   1.6 Litre)</b>					
02.04 → 10.08	BLF	1U-4-000 001→	246-082-008-025G	SWP-M-C	
02.04 → 10.08	BLF	1U-4-000 001→	246-083-002-022G	SWP-D-C	
02.04 → 10.08	BLF	1Z-4-000 001→	246-086-001-007C	HLWP	Plug Number (T2): 3b
<b>1.6 LPG (75 kW   1.6 Litre)</b>					
08.09 →	CHGA	1Z-9-000 001→	246-083-002-022G	SWP-D-C	
<b>1.6 MultiFuel (75 kW   1.6 Litre)</b>					
01.08 →	CCSA		246-082-008-025G	SWP-M-C	
01.08 →	CCSA	1Z-5-000 001→	246-083-002-022G	SWP-D-C	
01.08 →	CCSA	1Z-5-000 001→	246-086-001-007C	HLWP	Plug Number (T2): 3b
<b>1.6 TDI (77 kW   1.6 Litre)</b>					
06.09 →	CAYC	1Z-9-000 001→	246-082-008-025G	SWP-M-C	
06.09 →	CAYC	1Z-9-000 001→	246-083-002-022G	SWP-D-C	
06.09 →	CAYC	1Z-9-000 001→	246-086-001-007C	HLWP	Plug Number (T2): 3b
<b>1.6 TDI 4x4 (77 kW   1.6 Litre)</b>					
06.09 →	CAYC	1Z-9-000 001→	246-083-002-022G	SWP-D-C	
<b>1.8 TSI (118 kW   1.8 Litre)</b>					
06.07 →	BZB		246-082-008-025G	SWP-M-C	
06.07 →	BZB	1Z-5-000 001→	246-083-002-022G	SWP-D-C	
06.07 →	BZB		246-086-001-007C	HLWP	Plug Number (T2): 3b
<b>1.8 TSI 4x4 (118 kW   1.8 Litre)</b>					
11.08 →	CDA A		246-082-008-025G	SWP-M-C	
11.08 →	CDA A	1Z-5-000 001→	246-083-002-022G	SWP-D-C	
11.08 →	CDA A	1Z-5-000 001→	246-086-001-007C	HLWP	Plug Number (T2): 3b
<b>1.9 TDI (77 kW   1.9 Litre)</b>					
09.04 → 12.10	BKC		246-082-008-025G	SWP-M-C	
09.04 → 12.10	BKC		246-083-002-022G	SWP-D-C	
09.04 → 12.10	BKC, BJB, BXE, BLS	1Z-4-000 001→	246-086-001-007C	HLWP	Plug Number (T2): 3b
<b>1.9 TDI 4x4 (77 kW   1.9 Litre)</b>					
11.04 → 12.10	BLS		246-082-008-025G	SWP-M-C	
11.04 → 12.10	BLS		246-083-002-022G	SWP-D-C	
11.04 → 12.10	BKC, BXE, BLS	1Z-4-000 001→	246-086-001-007C	HLWP	Plug Number (T2): 3b
<b>2.0 FSI (110 kW   2.0 Litre)</b>					
11.04 →	BLR		246-082-008-025G	SWP-M-C	
11.04 →	BLR		246-083-002-022G	SWP-D-C	
11.04 →	BLR, BLY, BVY, BVZ	1Z-4-000 001→	246-086-001-007C	HLWP	Plug Number (T2): 3b
<b>2.0 FSI 4x4 (110 kW   2.0 Litre)</b>					
11.04 →	BLX		246-082-008-025G	SWP-M-C	
11.04 →	BLX		246-083-002-022G	SWP-D-C	
11.04 →	BLX, BVX	1Z-4-000 001→	246-086-001-007C	HLWP	Plug Number (T2): 3b
<b>2.0 RS (147 kW   2.0 Litre)</b>					
10.05 →	BWA		246-082-008-025G	SWP-M-C	
10.05 →	BWA, CCZA	1Z-5-000 001→	246-083-002-022G	SWP-D-C	
10.05 →	BWA, CCZA		246-086-001-007C	HLWP	Plug Number (T2): 3b
<b>2.0 TDI (103 kW   2.0 Litre)</b>					
11.05 →	BMM		246-082-008-025G	SWP-M-C	
11.05 →	BMM	1Z-5-000 001→	246-083-002-022G	SWP-D-C	
11.05 →	BMM		246-086-001-007C	HLWP	Plug Number (T2): 3b
<b>2.0 TDI 16V (100 kW   2.0 Litre)</b>					
02.04 → 05.10	AZV		246-082-008-025G	SWP-M-C	
02.04 → 05.10	AZV	1Z-4-000 001→	246-083-002-022G	SWP-D-C	
02.04 → 05.10	AZV	1Z-4-000 001→	246-086-001-007C	HLWP	Plug Number (T2): 3b
<b>2.0 TDI 16V (103 kW   2.0 Litre)</b>					
02.04 →	BKD		246-082-008-025G	SWP-M-C	
02.04 →	BKD		246-083-002-022G	SWP-D-C	
02.04 →	BKD, CLCB, CFHC	1Z-4-000 001→	246-086-001-007C	HLWP	Plug Number (T2): 3b
<b>2.0 TDI 4x4 (103 kW   2.0 Litre)</b>					
07.06 →	BMM	1U-5-000 001→	246-082-008-025G	SWP-M-C	
07.06 →	BMM	1Z-5-000 001→	246-083-002-022G	SWP-D-C	
07.06 →	BMM		246-086-001-007C	HLWP	Plug Number (T2): 3b
<b>2.0 TDI RS (125 kW   2.0 Litre)</b>					
04.06 →	BMN, CEGA	1U-5-000 001→	246-082-008-025G	SWP-M-C	
04.06 →	BMN, CEGA	1Z-5-000 001→	246-083-002-022G	SWP-D-C	



			<b>VDO</b>		
Date	Engine Code	Chassis No.	Article No.	Product	Information

**SKODA****OCTAVIA Combi (1Z5)****2.0 TDI RS (125 kW | 2.0 Litre)**

04.06 -	BMN, CEGA		246-086-001-007C	HLWP	Plug Number (T2): 3b
---------	-----------	--	------------------	------	----------------------

**ROOMSTER (5J)****1.2 (47 kW | 1.2 Litre)**

05.06 - 01.07	BME		246-082-008-025G	SWP-M-C	
05.06 - 01.07	BME		246-083-002-022G	SWP-D-C	
05.06 - 01.07	BME		246-086-001-007C	HLWP	Plug Number (T2): 3b

**1.2 (51 kW | 1.2 Litre)**

01.07 -	BZG		246-082-008-025G	SWP-M-C	
01.07 -	BZG		246-083-002-022G	SWP-D-C	
01.07 -	BZG, CGPA		246-086-001-007C	HLWP	Plug Number (T2): 3b

**1.2 TSI (63 kW | 1.2 Litre)**

03.10 -	CBZA		246-082-008-025G	SWP-M-C	
03.10 -	CBZA	1U-9-000 001→	246-083-002-022G	SWP-D-C	
03.10 -	CBZA		246-086-001-007C	HLWP	Plug Number (T2): 3b

**1.2 TSI (77 kW | 1.2 Litre)**

03.10 -	CBZB		246-082-008-025G	SWP-M-C	
03.10 -	CBZB	1U-9-000 001→	246-083-002-022G	SWP-D-C	
03.10 -	CBZB		246-086-001-007C	HLWP	Plug Number (T2): 3b

**1.4 (63 kW | 1.4 Litre)**

09.06 -	BXW		246-082-008-025G	SWP-M-C	
09.06 -	BXW		246-083-002-022G	SWP-D-C	
09.06 -	BXW		246-086-001-007C	HLWP	Plug Number (T2): 3b

**1.4 TDI (51 kW | 1.4 Litre)**

07.06 - 03.10	BNM		246-082-008-025G	SWP-M-C	
07.06 - 03.10	BNM		246-083-002-022G	SWP-D-C	
07.06 - 03.10	BNM		246-086-001-007C	HLWP	Plug Number (T2): 3b

**1.4 TDI (59 kW | 1.4 Litre)**

09.06 - 03.10	BMS		246-082-008-025G	SWP-M-C	
09.06 - 03.10	BMS		246-083-002-022G	SWP-D-C	
09.06 - 03.10	BMS, BNV		246-086-001-007C	HLWP	Plug Number (T2): 3b

**1.6 (77 kW | 1.6 Litre)**

09.06 -	BTS		246-082-008-025G	SWP-M-C	
09.06 -	BTS		246-083-002-022G	SWP-D-C	
09.06 -	BTS		246-086-001-007C	HLWP	Plug Number (T2): 3b

**1.6 TDI (66 kW | 1.6 Litre)**

03.10 -	CAYB		246-082-008-025G	SWP-M-C	
03.10 -	CAYB	1U-9-000 001→	246-083-002-022G	SWP-D-C	
03.10 -	CAYB		246-086-001-007C	HLWP	Plug Number (T2): 3b

**1.6 TDI (77 kW | 1.6 Litre)**

03.10 -	CAYC		246-082-008-025G	SWP-M-C	
03.10 -	CAYC	1U-9-000 001→	246-083-002-022G	SWP-D-C	
03.10 -	CAYC		246-086-001-007C	HLWP	Plug Number (T2): 3b

**1.9 TDI (77 kW | 1.9 Litre)**

09.06 - 03.10	BSW		246-082-008-025G	SWP-M-C	
09.06 - 03.10	BSW		246-083-002-022G	SWP-D-C	
09.06 - 03.10	BLS, BSW		246-086-001-007C	HLWP	Plug Number (T2): 3b

**SUPERB (3U4)****1.8 T (110 kW | 1.8 Litre)**

02.02 - 03.08	AWT		246-082-008-025G	SWP-M-C	
02.02 - 03.08	AWT		246-086-001-007C	HLWP	Plug Number (T2): 3b

**1.9 TDI (74 kW | 1.9 Litre)**

08.02 - 10.05	AVB		246-082-008-025G	SWP-M-C	
---------------	-----	--	------------------	---------	--

**1.9 TDI (77 kW | 1.9 Litre)**

10.05 - 05.07	BSV		246-086-001-007C	HLWP	Plug Number (T2): 3b
---------------	-----	--	------------------	------	----------------------

**1.9 TDI (85 kW | 1.9 Litre)**

01.07 - 03.08	BPZ		246-086-001-007C	HLWP	Plug Number (T2): 3b
---------------	-----	--	------------------	------	----------------------

**1.9 TDI (96 kW | 1.9 Litre)**

02.02 - 03.08	AWX		246-082-008-025G	SWP-M-C	
02.02 - 03.08	AWX, AVF		246-086-001-007C	HLWP	Plug Number (T2): 3b



			<b>VDO</b>		
Date	Engine Code	Chassis No.	Article No.	Product	Information

**SKODA****SUPERB (3U4)****2.0 (85 kW | 2.0 Litre)**

02.02 - 03.08	AZM		246-082-008-025G	SWP-M-C	
02.02 - 03.08	AZM		246-086-001-007C	HLWP	Plug Number (T2): 3b

**2.0 (91 kW | 2.0 Litre)**

02.06 - 03.08			246-086-001-007C	HLWP	Plug Number (T2): 3b
---------------	--	--	------------------	------	----------------------

**2.0 TDI (103 kW | 2.0 Litre)**

10.05 - 03.08	BSS		246-086-001-007C	HLWP	Plug Number (T2): 3b
---------------	-----	--	------------------	------	----------------------

**2.5 TDI (114 kW | 2.5 Litre)**

02.02 - 08.03	AYM	3B-V-000 001→	246-082-008-025G	SWP-M-C	
02.02 - 08.03	AYM		246-086-001-007C	HLWP	Plug Number (T2): 3b

**2.5 TDI (120 kW | 2.5 Litre)**

06.03 - 03.08	BDG		246-082-008-025G	SWP-M-C	
06.03 - 03.08	BDG		246-086-001-007C	HLWP	Plug Number (T2): 3b

**2.8 V6 (142 kW | 2.8 Litre)**

02.02 - 03.08	AMX		246-082-008-025G	SWP-M-C	
02.02 - 03.08	AMX		246-086-001-007C	HLWP	Plug Number (T2): 3b

**SUPERB (3T4)****1.4 TSI (92 kW | 1.4 Litre)**

07.08 -	CAXC	3T-8-000 001→	246-082-008-025G	SWP-M-C	
07.08 -	CAXC	3T-8-000 001→	246-086-001-007C	HLWP	Plug Number (T2): 3b

**1.8 TSI (118 kW | 1.8 Litre)**

03.08 -	BZB, CDAA	3T-8-000 001→	246-082-008-025G	SWP-M-C	
03.08 -	BZB, CDAA	3T-8-000 001→	246-086-001-007C	HLWP	Plug Number (T2): 3b

**1.8 TSI 4x4 (118 kW | 1.8 Litre)**

11.08 -	CDAA	3T-8-000 001→	246-082-008-025G	SWP-M-C	
11.08 -	CDAA	3T-8-000 001→	246-086-001-007C	HLWP	Plug Number (T2): 3b

**1.9 TDI (77 kW | 1.9 Litre)**

03.08 -	BLS, BXE	3T-8-000 001→	246-082-008-025G	SWP-M-C	
03.08 -	BLS, BXE	3T-8-000 001→	246-086-001-007C	HLWP	Plug Number (T2): 3b

**2.0 TDI (103 kW | 2.0 Litre)**

03.08 -	BMP	3T-8-000 001→	246-082-008-025G	SWP-M-C	
03.08 -	BMP	3T-8-000 001→	246-086-001-007C	HLWP	Plug Number (T2): 3b

**2.0 TDI (125 kW | 2.0 Litre)**

07.08 -	CBBB, CFGB	3T-8-000 001→	246-082-008-025G	SWP-M-C	
07.08 -	CBBB, CFGB	3T-8-000 001→	246-086-001-007C	HLWP	Plug Number (T2): 3b

**2.0 TDI 16V (103 kW | 2.0 Litre)**

01.09 -	BKD, CFFB, CLJA		246-082-008-025G	SWP-M-C	
01.09 -	BKD, CFFB, CLJA		246-086-001-007C	HLWP	Plug Number (T2): 3b

**2.0 TDI 4x4 (125 kW | 2.0 Litre)**

09.08 -	CBBB, CFGB	3T-8-000 001→	246-082-008-025G	SWP-M-C	
09.08 -	CBBB, CFGB	3T-8-000 001→	246-086-001-007C	HLWP	Plug Number (T2): 3b

**3.6 V6 4x4 (191 kW | 3.6 Litre)**

11.08 -	CDVA	3T-8-000 001→	246-082-008-025G	SWP-M-C	
11.08 -	CDVA	3T-8-000 001→	246-086-001-007C	HLWP	Plug Number (T2): 3b

**SUPERB Estate (3T5)****1.4 TSI (92 kW | 1.4 Litre)**

10.09 -	CAXC		246-086-001-007C	HLWP	Plug Number (T2): 3b
---------	------	--	------------------	------	----------------------

**1.8 TSI (118 kW | 1.8 Litre)**

10.09 -	CDAA		246-086-001-007C	HLWP	Plug Number (T2): 3b
---------	------	--	------------------	------	----------------------

**1.8 TSI 4x4 (118 kW | 1.8 Litre)**

10.09 -	CDAA		246-086-001-007C	HLWP	Plug Number (T2): 3b
---------	------	--	------------------	------	----------------------

**2.0 TDI (103 kW | 2.0 Litre)**

10.09 - 03.10	BMP	3T-8-000 001→	246-086-001-007C	HLWP	Plug Number (T2): 3b
---------------	-----	---------------	------------------	------	----------------------

**2.0 TDI (125 kW | 2.0 Litre)**

10.09 -	CBBB, CFGB		246-086-001-007C	HLWP	Plug Number (T2): 3b
---------	------------	--	------------------	------	----------------------

**2.0 TDI 16V (103 kW | 2.0 Litre)**

10.09 -	BKD, CFFB, CLJA		246-086-001-007C	HLWP	Plug Number (T2): 3b
---------	-----------------	--	------------------	------	----------------------

**2.0 TDI 4x4 (125 kW | 2.0 Litre)**

10.09 -	CBBB, CFGB		246-086-001-007C	HLWP	Plug Number (T2): 3b
---------	------------	--	------------------	------	----------------------

**3.6 V6 4x4 (191 kW | 3.6 Litre)**

10.09 -	CDVA		246-086-001-007C	HLWP	Plug Number (T2): 3b
---------	------	--	------------------	------	----------------------



			<b>VDO</b>		
Date	Engine Code	Chassis No.	Article No.	Product	Information

**SKODA****YETI (5L)****1.2 TSI (77 kW | 1.2 Litre)**

09.09 -	CBZB		246-083-002-022G	SWP-D-C	
09.09 -	CBZB		246-086-001-007C	HLWP	Plug Number (T2): 3b

**1.4 TSI (90 kW | 1.4 Litre)**

06.10 -	CAXA		246-083-002-022G	SWP-D-C	
06.10 -	CAXA		246-086-001-007C	HLWP	Plug Number (T2): 3b

**1.8 TSI 4x4 (118 kW | 1.8 Litre)**

05.09 -	CDA A		246-083-002-022G	SWP-D-C	
05.09 -	CDA A		246-086-001-007C	HLWP	Plug Number (T2): 3b

**2.0 TDI (81 kW | 2.0 Litre)**

11.09 -	CFHA		246-083-002-022G	SWP-D-C	
11.09 -	CFHA		246-086-001-007C	HLWP	Plug Number (T2): 3b

**2.0 TDI 4x4 (103 kW | 2.0 Litre)**

05.09 -	CBDB, CFHC		246-083-002-022G	SWP-D-C	
05.09 -	CBDB, CFHC		246-086-001-007C	HLWP	Plug Number (T2): 3b

**2.0 TDI 4x4 (125 kW | 2.0 Litre)**

11.09 -	CEGA, CFJA		246-083-002-022G	SWP-D-C	
11.09 -	CEGA, CFJA		246-086-001-007C	HLWP	Plug Number (T2): 3b

**2.0 TDI 4x4 (81 kW | 2.0 Litre)**

11.09 -	CFHF		246-083-002-022G	SWP-D-C	
11.09 -	CFHF		246-086-001-007C	HLWP	Plug Number (T2): 3b

**SMART****CABRIO (450)****0.6 (450.400, S1OLD2) (45 kW | 0.6 Litre)**

01.01 - 01.04	M 160 E6AL B05, M 160.920		246-083-002-022G	SWP-D-C	
---------------	---------------------------	--	------------------	---------	--

**0.6 (450.433, S1OLA1) (40 kW | 0.6 Litre)**

03.00 - 01.04	M 160 E6AL B03, M 160.920		246-083-002-022G	SWP-D-C	
---------------	---------------------------	--	------------------	---------	--

**0.8 CDI (450.401, 450.402, 450.403, S1OLC1) (30 kW | 0.8 Litre)**

03.01 - 01.04	OM 660 DE 8LA, OM 660.940		246-083-002-022G	SWP-D-C	
---------------	---------------------------	--	------------------	---------	--

**CITY-COUPÉ (450)****0.6 (450.333, 450.335) (45 kW | 0.6 Litre)**

01.01 - 01.04	M 160 E6AL B05, M 160.920		246-083-002-022G	SWP-D-C	
---------------	---------------------------	--	------------------	---------	--

**0.6 (450.341, S1CLA1) (40 kW | 0.6 Litre)**

07.98 - 01.04	M 160 E6AL B03, M 160.920		246-083-002-022G	SWP-D-C	
---------------	---------------------------	--	------------------	---------	--

**0.6 (450.342, S1CLB1) (33 kW | 0.6 Litre)**

07.98 - 01.04	M 160 E6AL B04, M 160.920		246-083-002-022G	SWP-D-C	
---------------	---------------------------	--	------------------	---------	--

**0.8 CDI (450.300, 450.301, 450.302, 450.303, 450.306...) (30 kW | 0.8 Litre)**

11.99 - 01.04	OM 660 DE 8LA, OM 660.940		246-083-002-022G	SWP-D-C	
---------------	---------------------------	--	------------------	---------	--

**FORTWO Coupe (451)****0.8 CDi (451.300) (33 kW | 0.8 Litre)**

01.07 -	OM 660.950		246-083-002-022G	SWP-D-C	
---------	------------	--	------------------	---------	--

**0.8 CDi (451.391) (40 kW | 0.8 Litre)**

08.09 -	OM 660.951		246-083-002-022G	SWP-D-C	
---------	------------	--	------------------	---------	--

**1.0 (451.330, 451.334) (45 kW | 1.0 Litre)**

01.07 -	M 132.910		246-083-002-022G	SWP-D-C	
---------	-----------	--	------------------	---------	--

**1.0 (451.331, 451.380) (52 kW | 1.0 Litre)**

01.07 -	M 132.910		246-083-002-022G	SWP-D-C	
---------	-----------	--	------------------	---------	--

**1.0 Brabus (451.333) (72 kW | 1.0 Litre)**

01.08 -	M 132.930		246-083-002-022G	SWP-D-C	
---------	-----------	--	------------------	---------	--

**1.0 Turbo (451.332) (62 kW | 1.0 Litre)**

01.07 -	M 132.930		246-083-002-022G	SWP-D-C	
---------	-----------	--	------------------	---------	--

**FORTWO Cabrio (451)****0.8 CDi (451.400) (33 kW | 0.8 Litre)**

01.07 -	OM 660.950		246-082-008-025G	SWP-M-C	
---------	------------	--	------------------	---------	--

**0.8 CDi (451.401) (40 kW | 0.8 Litre)**

08.09 -	OM 660.951		246-082-008-025G	SWP-M-C	
---------	------------	--	------------------	---------	--



			<b>VDO</b>		
Date	Engine Code	Chassis No.	Article No.	Product	Information

**SMART****FORTWO Cabrio (451)**

<b>1.0 (451.431) (52 kW   1.0 Litre)</b>					
01.07 -	M 132.910		246-082-008-025G	SWP-M-C	
<b>1.0 Brabus (451.433) (72 kW   1.0 Litre)</b>					
01.08 -	M 132.930		246-082-008-025G	SWP-M-C	
<b>1.0 Turbo (451.432) (62 kW   1.0 Litre)</b>					
01.07 -	M 132.930		246-082-008-025G	SWP-M-C	
<b>1.0 Turbo Brabus (451.433) (75 kW   1.0 Litre)</b>					
07.10 -	M 132.930		246-082-008-025G	SWP-M-C	

**VAUXHALL****AGILA Mk I (A)**

<b>1.0 12V (43 kW   1.0 Litre)</b>					
09.00 - 08.05	Z 10 XE		246-083-002-014G	SWP-D-C	Plug Number (T2): 6
<b>1.2 16V (55 kW   1.2 Litre)</b>					
09.00 -	Z 12 XE		246-083-002-014G	SWP-D-C	Plug Number (T2): 6

**AMPERA**

<b>EV 150 (D1J0I) (111 kW   0.0 Litre)</b>					
03.12 -	4ET50, A 14 XFL		A2C53240114	SWP-M-C	

**ASTRA Mk III (F)**

<b>1.4 i (44 kW   1.4 Litre)</b>					
04.92 - 03.98	C 14 NZ		246-082-008-014C	SWP-M-C	Plug Number (T2): 1
<b>1.4 i (60 kW   1.4 Litre)</b>					
04.92 - 03.98	C 14 SE		246-082-008-014C	SWP-M-C	Plug Number (T2): 1
<b>1.6 i (52 kW   1.6 Litre)</b>					
08.94 - 07.96	X 16 SZ		246-083-001-004C	SWP-D-C	Plug Number (T2): 1
<b>1.6 i (74 kW   1.6 Litre)</b>					
05.92 - 12.94	C 16 SE		246-082-008-014C	SWP-M-C	Plug Number (T2): 1
<b>1.7 D (42 kW   1.7 Litre)</b>					
03.92 - 09.92	17 D		246-082-008-014C	SWP-M-C	Plug Number (T2): 1
<b>1.7 TD (60 kW   1.7 Litre)</b>					
12.91 - 03.98	17 DT (TC4EE1)		246-082-008-014C	SWP-M-C	Plug Number (T2): 1
<b>2.0 i (85 kW   2.0 Litre)</b>					
03.92 - 03.98	C 20 NE		246-082-008-014C	SWP-M-C	Plug Number (T2): 1

**ASTRA Mk III (F) Hatchback**

<b>1.4 i (44 kW   1.4 Litre)</b>					
10.91 - 12.96	C 14 NZ		246-083-001-004C	SWP-D-C	Plug Number (T2): 1
<b>1.4 i (60 kW   1.4 Litre)</b>					
03.92 - 02.98	C 14 SE		246-083-001-004C	SWP-D-C	Plug Number (T2): 1
<b>1.4 i 16V (66 kW   1.4 Litre)</b>					
02.96 - 02.98	X 14 XE		246-083-001-004C	SWP-D-C	Plug Number (T2): 1
<b>1.4 S (55 kW   1.4 Litre)</b>					
09.91 - 02.98	14 NV		246-083-001-004C	SWP-D-C	Plug Number (T2): 1
<b>1.6 i (55 kW   1.6 Litre)</b>					
09.91 - 02.98	C 16 NZ		246-083-001-004C	SWP-D-C	Plug Number (T2): 1
<b>1.6 i (74 kW   1.6 Litre)</b>					
03.92 - 02.98	C 16 SE		246-083-001-004C	SWP-D-C	Plug Number (T2): 1
<b>1.6 i 16V (74 kW   1.6 Litre)</b>					
08.94 - 02.98	X 16 XEL		246-083-001-004C	SWP-D-C	Plug Number (T2): 1
<b>1.7 D (42 kW   1.7 Litre)</b>					
12.91 - 02.98	17 D		246-083-001-004C	SWP-D-C	Plug Number (T2): 1
<b>1.7 D (44 kW   1.7 Litre)</b>					
10.91 - 08.94	17 DR		246-083-001-004C	SWP-D-C	Plug Number (T2): 1
<b>1.7 TD (50 kW   1.7 Litre)</b>					
08.94 - 02.98	X 17 DTL		246-083-001-004C	SWP-D-C	Plug Number (T2): 1
<b>1.7 TD (60 kW   1.7 Litre)</b>					
12.91 - 02.98	17 DT (TC4EE1)		246-083-001-004C	SWP-D-C	Plug Number (T2): 1



			<b>VDO</b>		
Date	Engine Code	Chassis No.	Article No.	Product	Information

**VAUXHALL****ASTRA Mk III (F) Hatchback**

<b>1.8 i (66 kW   1.8 Litre)</b>					
10.91 → 07.94	C 18 NZ		246-083-001-004C	SWP-D-C	Plug Number (T2): 1
<b>1.8 i 16V (85 kW   1.8 Litre)</b>					
09.94 → 02.98	C 18 XEL		246-083-001-004C	SWP-D-C	Plug Number (T2): 1
<b>2.0 i (85 kW   2.0 Litre)</b>					
10.91 → 07.93	C 20 NE		246-083-001-004C	SWP-D-C	Plug Number (T2): 1
<b>2.0 i 16V (100 kW   2.0 Litre)</b>					
04.95 → 02.98	X 20 XEV		246-083-001-004C	SWP-D-C	Plug Number (T2): 1
<b>2.0 i 16V (110 kW   2.0 Litre)</b>					
09.91 → 02.98	C 20 XE		246-083-001-004C	SWP-D-C	Plug Number (T2): 1

**ASTRA Mk III (F) Estate**

<b>1.4 i (44 kW   1.4 Litre)</b>					
09.91 → 12.96	C 14 NZ		246-083-001-004C	SWP-D-C	Plug Number (T2): 1
<b>1.4 i (60 kW   1.4 Litre)</b>					
09.91 → 02.98	C 14 SE		246-083-001-004C	SWP-D-C	Plug Number (T2): 1
<b>1.4 i 16V (66 kW   1.4 Litre)</b>					
02.96 → 01.98	X 14 XE		246-083-001-004C	SWP-D-C	Plug Number (T2): 1
<b>1.6 i (52 kW   1.6 Litre)</b>					
07.94 → 02.98	X 16 SZ		246-083-001-004C	SWP-D-C	Plug Number (T2): 1
<b>1.6 i (55 kW   1.6 Litre)</b>					
09.91 → 02.98	C 16 NZ, E 16 NZ		246-083-001-004C	SWP-D-C	Plug Number (T2): 1
<b>1.6 i 16V (74 kW   1.6 Litre)</b>					
08.94 → 02.98	X 16 XEL		246-083-001-004C	SWP-D-C	Plug Number (T2): 1
<b>1.7 D (42 kW   1.7 Litre)</b>					
12.91 → 02.98	17 D		246-083-001-004C	SWP-D-C	Plug Number (T2): 1
<b>1.7 D (44 kW   1.7 Litre)</b>					
10.91 → 08.94	17 DR		246-083-001-004C	SWP-D-C	Plug Number (T2): 1
<b>1.7 TD (50 kW   1.7 Litre)</b>					
08.94 → 02.98	X 17 DTL		246-083-001-004C	SWP-D-C	Plug Number (T2): 1
<b>1.7 TD (60 kW   1.7 Litre)</b>					
12.91 → 02.98	17 DT (TC4EE1)		246-083-001-004C	SWP-D-C	Plug Number (T2): 1
<b>1.8 i (66 kW   1.8 Litre)</b>					
10.91 → 07.94	C 18 NZ		246-083-001-004C	SWP-D-C	Plug Number (T2): 1
<b>1.8 i 16V (85 kW   1.8 Litre)</b>					
09.94 → 02.98	C 18 XEL, X 18 XE		246-083-001-004C	SWP-D-C	Plug Number (T2): 1
<b>2.0 i (85 kW   2.0 Litre)</b>					
09.91 → 02.98	C 20 NE		246-083-001-004C	SWP-D-C	Plug Number (T2): 1
<b>2.0 i 16V (100 kW   2.0 Litre)</b>					
04.95 → 02.98	X 20 XEV		246-083-001-004C	SWP-D-C	Plug Number (T2): 1

**ASTRA Mk IV (G) Hatchback**

<b>1.2 16V (48 kW   1.2 Litre)</b>					
04.98 → 09.00	X 12 XE		246-083-002-014G	SWP-D-C	Plug Number (T2): 6
<b>1.4 16V (66 kW   1.4 Litre)</b>					
04.98 → 05.05	X 14 XE		246-083-002-014G	SWP-D-C	Plug Number (T2): 6
<b>1.6 (55 kW   1.6 Litre)</b>					
04.98 → 09.00	X 16 SZR		246-083-002-014G	SWP-D-C	Plug Number (T2): 6
<b>1.6 16V (74 kW   1.6 Litre)</b>					
04.98 → 05.05	X 16 XEL		246-083-002-014G	SWP-D-C	Plug Number (T2): 6
<b>1.7 TD (50 kW   1.7 Litre)</b>					
04.98 → 08.00	X 17 DTL		246-083-002-014G	SWP-D-C	Plug Number (T2): 6
<b>1.8 16V (85 kW   1.8 Litre)</b>					
04.98 → 09.00	X 18 XE1		246-083-002-014G	SWP-D-C	Plug Number (T2): 6
<b>2.0 16V (100 kW   2.0 Litre)</b>					
04.98 → 05.05	X 20 XEV		246-083-002-014G	SWP-D-C	Plug Number (T2): 6
<b>2.0 DI (60 kW   2.0 Litre)</b>					
04.98 → 05.05	X 20 DTL		246-083-002-014G	SWP-D-C	Plug Number (T2): 6
<b>2.0 DTI 16V (74 kW   2.0 Litre)</b>					
08.99 → 05.05	Y 20 DT		246-083-002-014G	SWP-D-C	Plug Number (T2): 6



			<b>VDO</b>		
Date	Engine Code	Chassis No.	Article No.	Product	Information

**VAUXHALL****ASTRA Mk IV (G) Estate****1.4 16V (66 kW | 1.4 Litre)**

04.98 - 05.05 X 14 XE 246-083-002-014G SWP-D-C Plug Number (T2): 6

**1.6 (55 kW | 1.6 Litre)**

04.98 - 04.04 X 16 SZR 246-083-002-014G SWP-D-C Plug Number (T2): 6

**1.6 16V (74 kW | 1.6 Litre)**

04.98 - 04.04 X 16 XEL 246-083-002-014G SWP-D-C Plug Number (T2): 6

**1.7 TD (50 kW | 1.7 Litre)**

04.98 - 08.00 X 17 DTL 246-083-002-014G SWP-D-C Plug Number (T2): 6

**1.8 16V (85 kW | 1.8 Litre)**

04.98 - 08.00 X 18 XE1 246-083-002-014G SWP-D-C Plug Number (T2): 6

**2.0 16V (100 kW | 2.0 Litre)**

04.98 - 05.05 X 20 XEV 246-083-002-014G SWP-D-C Plug Number (T2): 6

**2.0 DI (60 kW | 2.0 Litre)**

04.98 - 04.04 X 20 DTL 246-083-002-014G SWP-D-C Plug Number (T2): 6

**2.0 DTI 16V (74 kW | 2.0 Litre)**

04.98 - 04.04 Y 20 DTH 246-083-002-014G SWP-D-C Plug Number (T2): 6

**ASTRA Mk VI (J) Saloon****1.3 CDTI (70 kW | 1.3 Litre)**

06.12 - A 13 DTE A2C53240114 SWP-M-C

**1.4 (74 kW | 1.4 Litre)**

06.12 - A 14 XER A2C53240114 SWP-M-C

**1.4 Turbo (103 kW | 1.4 Litre)**

06.12 - A 14 NET A2C53240114 SWP-M-C

**1.6 Turbo (132 kW | 1.6 Litre)**

06.12 - A 16 LET A2C53240114 SWP-M-C

**1.6 Turbo (85 kW | 1.6 Litre)**

06.12 - A 16 XER A2C53240114 SWP-M-C

**1.7 CDTI (81 kW | 1.7 Litre)**

06.12 - A 17 DTC, A 17 DTJ, A 17 DTE A2C53240114 SWP-M-C

**1.7 CDTI (96 kW | 1.7 Litre)**

06.12 - A 17 DTF, A 17 DTS A2C53240114 SWP-M-C

**CALIBRA****2.0 i (85 kW | 2.0 Litre)**

06.90 - 08.96 C 20 NE 246-083-001-004C SWP-D-C Plug Number (T2): 1

**2.0 i 16V (100 kW | 2.0 Litre)**

02.94 - 06.97 X 20 XEV 246-083-001-004C SWP-D-C Plug Number (T2): 1

**2.0 i 16V (110 kW | 2.0 Litre)**

09.90 - 04.92 C 20 XE 246-083-001-004C SWP-D-C Plug Number (T2): 1

**2.0 i 16V 4x4 (100 kW | 2.0 Litre)**

02.94 - 07.97 X 20 XEV 246-083-001-004C SWP-D-C Plug Number (T2): 1

**2.0 i 16V 4x4 (110 kW | 2.0 Litre)**

06.90 - 02.94 C 20 XE 246-083-001-004C SWP-D-C Plug Number (T2): 1

**2.0 i 4x4 (85 kW | 2.0 Litre)**

06.90 - 07.97 C 20 NE 246-083-001-004C SWP-D-C Plug Number (T2): 1

**2.0 i Turbo 4x4 (150 kW | 2.0 Litre)**

04.92 - 07.97 C 20 LET 246-083-001-004C SWP-D-C Plug Number (T2): 1

**2.5 i V6 (125 kW | 2.5 Litre)**

08.93 - 07.97 C 25 XE, X 25 XE 246-083-001-004C SWP-D-C Plug Number (T2): 1

**CARLTON Mk III****1.8 (65 kW | 1.8 Litre)**

09.87 - 09.90 E 18 NVR 246-082-008-014C SWP-M-C Plug Number (T2): 1

**1.8 i (85 kW | 1.8 Litre)**

11.86 - 08.92 18 SEH 246-082-008-014C SWP-M-C Plug Number (T2): 1

**2.0 (73 kW | 2.0 Litre)**

09.90 - 03.94 C 20 NEJ 246-082-008-014C SWP-M-C Plug Number (T2): 1

**2.0 (85 kW | 2.0 Litre)**

10.91 - 03.94 C 20 NE 246-082-008-014C SWP-M-C Plug Number (T2): 1

**2.0 i (90 kW | 2.0 Litre)**

11.86 - 09.90 20 SE 246-082-008-014C SWP-M-C Plug Number (T2): 1





			<b>VDO</b>		
Date	Engine Code	Chassis No.	Article No.	Product	Information

**VAUXHALL****CARLTON Mk III****2.2 TD (66 kW | 2.2 Litre)**

11.86 - 08.88 | 23 YDT | 246-082-008-014C | SWP-M-C | Plug Number (T2): 1

**2.3 D (54 kW | 2.3 Litre)**

11.86 - 03.94 | 23 YD | 246-082-008-014C | SWP-M-C | Plug Number (T2): 1

**2.3 TD Interc. (74 kW | 2.3 Litre)**

09.88 - 03.94 | 23 DTR | 246-082-008-014C | SWP-M-C | Plug Number (T2): 1

**2.6 i (110 kW | 2.6 Litre)**

09.90 - 03.94 | C 26 NE | 246-082-008-014C | SWP-M-C | Plug Number (T2): 1

**3.0 3000 (130 kW | 3.0 Litre)**

03.87 - 10.89 | 30 NE | 246-082-008-014C | SWP-M-C | Plug Number (T2): 1

**3.0 3000 24V (150 kW | 3.0 Litre)**

10.89 - 08.93 | C 30 SE | 246-082-008-014C | SWP-M-C | Plug Number (T2): 1

**3.6 24V Lotus (277 kW | 3.6 Litre)**

09.90 - 09.92 | C 36 GET | 246-082-008-014C | SWP-M-C | Plug Number (T2): 1

**CARLTON Mk III Estate****1.8 (65 kW | 1.8 Litre)**

09.87 - 09.90 | E 18 NVR | 246-082-008-014C | SWP-M-C | Plug Number (T2): 1

**1.8 i (85 kW | 1.8 Litre)**

11.86 - 08.92 | 18 SEH | 246-082-008-014C | SWP-M-C | Plug Number (T2): 1

**2.6 i (110 kW | 2.6 Litre)**

09.90 - 03.94 | C 26 NE | 246-082-008-014C | SWP-M-C | Plug Number (T2): 1

**3.0 (130 kW | 3.0 Litre)**

10.89 - 09.90 | C 30 NE | 246-082-008-014C | SWP-M-C | Plug Number (T2): 1

**CAVALIER Mk II Hatchback****1.8 i (82 kW | 1.8 Litre)**

01.85 - 07.88 | 18 SE | 246-082-008-014C | SWP-M-C | Plug Number (T2): 1

**1.8 i (85 kW | 1.8 Litre)**

10.82 - 08.87 | 18 E | 246-082-008-014C | SWP-M-C | Plug Number (T2): 1

**2.0 i CAT (85 kW | 2.0 Litre)**

04.87 - 08.88 | C 20 NE | 246-082-008-014C | SWP-M-C | Plug Number (T2): 1

**CAVALIER Mk II****1.3 S (55 kW | 1.3 Litre)**

09.81 - 08.88 | 13 S | 246-082-008-014C | SWP-M-C | Plug Number (T2): 1

**1.6 D (40 kW | 1.6 Litre)**

09.82 - 08.88 | 16 D | 246-082-008-014C | SWP-M-C | Plug Number (T2): 1

**1.6 S (66 kW | 1.6 Litre)**

09.81 - 08.88 | 16 SH | 246-082-008-014C | SWP-M-C | Plug Number (T2): 1

**1.8 i (82 kW | 1.8 Litre)**

01.85 - 07.88 | 18 SE | 246-082-008-014C | SWP-M-C | Plug Number (T2): 1

**1.8 i (85 kW | 1.8 Litre)**

10.82 - 08.87 | 18 E | 246-082-008-014C | SWP-M-C | Plug Number (T2): 1

**2.0 i (85 kW | 2.0 Litre)**

04.87 - 08.88 | 20 NE | 246-082-008-014C | SWP-M-C | Plug Number (T2): 1

**2.0 i CAT (85 kW | 2.0 Litre)**

09.86 - 08.88 | C 20 NE | 246-082-008-014C | SWP-M-C | Plug Number (T2): 1

**CAVALIER Mk II Estate****1.6 (66 kW | 1.6 Litre)**

10.83 - 08.88 | 16 SH | 246-082-008-014C | SWP-M-C | Plug Number (T2): 1

**1.6 D (40 kW | 1.6 Litre)**

09.82 - 08.88 | 16 DA | 246-082-008-014C | SWP-M-C | Plug Number (T2): 1

**CAVALIER Mk II Convertible****1800i (82 kW | 1.8 Litre)**

11.85 - 08.88 | 18 SE | 246-082-008-014C | SWP-M-C | Plug Number (T2): 1

**CAVALIER Mk III Hatchback****1.6 i (52 kW | 1.6 Litre)**

09.93 - 11.95 | X 16 SZ | 246-083-001-004C | SWP-D-C | Plug Number (T2): 1



			<b>VDO</b>		
Date	Engine Code	Chassis No.	Article No.	Product	Information

**VAUXHALL****CAVALIER Mk III Hatchback****1.7 D (44 kW | 1.7 Litre)**

09.92 → 10.95 17 DR 246-083-001-004C SWP-D-C Plug Number (T2): 1

**1.8 i CAT (66 kW | 1.8 Litre)**

09.90 → 10.95 C 18 NZ 246-083-001-004C SWP-D-C Plug Number (T2): 1

**2.0 i (85 kW | 2.0 Litre)**

10.88 → 10.92 20 NE 246-083-001-004C SWP-D-C Plug Number (T2): 1

**2.0 i 16V (100 kW | 2.0 Litre)**

09.93 → 11.95 X 20 XEV 246-083-001-004C SWP-D-C Plug Number (T2): 1

**2.0 i 16V 4x4 (110 kW | 2.0 Litre)**

01.92 → 11.93 C 20 XE 246-083-001-004C SWP-D-C Plug Number (T2): 1

**2.0 i 4x4 (85 kW | 2.0 Litre)**

01.91 → 10.92 20 NE 246-083-001-004C SWP-D-C Plug Number (T2): 1

**2.0 i CAT (85 kW | 2.0 Litre)**

09.90 → 11.95 C 20 NE 246-083-001-004C SWP-D-C Plug Number (T2): 1

**2.0 SRi (95 kW | 2.0 Litre)**

12.88 → 09.92 20 SEH 246-083-001-004C SWP-D-C Plug Number (T2): 1

**2.5 V6 (125 kW | 2.5 Litre)**

09.88 → 06.94 C 25 XE 246-083-001-004C SWP-D-C Plug Number (T2): 1

**CAVALIER Mk III (87)****1.4 S (55 kW | 1.4 Litre)**

11.88 → 08.92 14 NV 246-082-008-014C SWP-M-C Plug Number (T2): 1

11.88 → 08.92 14 NV 246-083-001-004C SWP-D-C Plug Number (T2): 1

**1.6 (60 kW | 1.6 Litre)**

10.88 → 08.92 16 SV 246-082-008-014C SWP-M-C Plug Number (T2): 1

10.88 → 08.92 16 SV 246-083-001-004C SWP-D-C Plug Number (T2): 1

**1.6 i (52 kW | 1.6 Litre)**

09.93 → 11.95 X 16 SZ 246-083-001-004C SWP-D-C Plug Number (T2): 1

**1.7 D (42 kW | 1.7 Litre)**

11.88 → 09.92 17 D 246-082-008-014C SWP-M-C Plug Number (T2): 1

11.88 → 09.92 17 D 246-083-001-004C SWP-D-C Plug Number (T2): 1

**1.7 D (44 kW | 1.7 Litre)**

07.92 → 11.95 17 DR 246-083-001-004C SWP-D-C Plug Number (T2): 1

**1.7 TD (60 kW | 1.7 Litre)**

09.91 → 10.95 17 DT (TC4EE1) 246-082-008-014C SWP-M-C Plug Number (T2): 1

**1.8 (66 kW | 1.8 Litre)**

10.89 → 08.92 18 SV 246-082-008-014C SWP-M-C Plug Number (T2): 1

10.89 → 08.92 C 18 NZ, 18 SV 246-083-001-004C SWP-D-C Plug Number (T2): 1

**1.8 i CAT (66 kW | 1.8 Litre)**

09.90 → 10.95 C 18 NZ 246-082-008-014C SWP-M-C Plug Number (T2): 1

03.90 → 11.95 C 18 NZ 246-083-001-004C SWP-D-C Plug Number (T2): 1

**2.0 i (85 kW | 2.0 Litre)**

10.88 → 10.90 20 NE 246-082-008-014C SWP-M-C Plug Number (T2): 1

**2.0 i 16V (110 kW | 2.0 Litre)**

10.89 → 11.95 C 20 XE 246-082-008-014C SWP-M-C Plug Number (T2): 1

**2.0 i 16V 4x4 (110 kW | 2.0 Litre)**

10.89 → 10.92 C 20 XE 246-082-008-014C SWP-M-C Plug Number (T2): 1

**2.0 i 4x4 (85 kW | 2.0 Litre)**

01.91 → 10.92 20 NE 246-083-001-004C SWP-D-C Plug Number (T2): 1

**2.0 i 4x4 (95 kW | 2.0 Litre)**

12.88 → 08.92 20 SEH 246-082-008-014C SWP-M-C Plug Number (T2): 1

**2.0 i CAT (85 kW | 2.0 Litre)**

09.90 → 11.95 C 20 NE 246-083-001-004C SWP-D-C Plug Number (T2): 1

**2.0 i Turbo 4x4 (150 kW | 2.0 Litre)**

06.92 → 11.94 C 20 LET 246-083-001-004C SWP-D-C Plug Number (T2): 1

**2.0 SRi (95 kW | 2.0 Litre)**

12.88 → 09.92 20 SEH 246-082-008-014C SWP-M-C Plug Number (T2): 1

**2.0 SRi 16V (100 kW | 2.0 Litre)**

09.93 → 11.95 X 20 XEV 246-083-001-004C SWP-D-C Plug Number (T2): 1

**2.5 V6 (125 kW | 2.5 Litre)**

08.88 → 06.94 C 25 XE 246-083-001-004C SWP-D-C Plug Number (T2): 1



			<b>VDO</b>		
Date	Engine Code	Chassis No.	Article No.	Product	Information

**VAUXHALL****COMBO Mk I (B)****1.2 (33 kW | 1.2 Litre)**

07.94 → 10.01 C 12 NZ, X 12 SZ

246-083-001-004C

SWP-D-C

Plug Number (T2): 1

**1.4 (44 kW | 1.4 Litre)**

07.94 → 09.01 C 14 NZ

246-083-001-004C

SWP-D-C

Plug Number (T2): 1; Vehicle Equipment (T31):  
without air conditioning (T36)**1.4 (60 kW | 1.4 Litre)**

07.94 → 10.01 C 14 SE

246-083-001-004C

SWP-D-C

Plug Number (T2): 1

**1.7 D (44 kW | 1.7 Litre)**

07.94 → 09.01 17 D (4EE1), X 17 D (4EE1)

246-083-001-004C

SWP-D-C

Plug Number (T2): 1; Vehicle Equipment (T31):  
without air conditioning (T36)**CORSA Mk I (B)****1.0 i 12V (40 kW | 1.0 Litre)**

04.97 → 09.00 X 10 XE

246-083-001-004C

SWP-D-C

Plug Number (T2): 1; Vehicle Equipment (T31):  
without air conditioning (T36)

08.97 → 09.00 X 10 XE

246-083-002-014G

SWP-D-C

Plug Number (T2): 6; Vehicle Equipment (T31):  
for vehicles with air conditioning (T32)**1.2 i (33 kW | 1.2 Litre)**

04.93 → 08.98 C 12 NZ, X 12 SZ

246-083-001-004C

SWP-D-C

Plug Number (T2): 1; Vehicle Equipment (T31):  
without air conditioning (T36)

01.96 → 08.98 C 12 NZ

T3000001→

246-083-002-014G

SWP-D-C

Plug Number (T2): 6; Vehicle Equipment (T31):  
for vehicles with air conditioning (T32)**1.2 i 16V (48 kW | 1.2 Litre)**

03.98 → 09.00 X 12 XE

246-083-001-004C

SWP-D-C

Plug Number (T2): 1; Vehicle Equipment (T31):  
without air conditioning (T36)

03.98 → 09.00 X 12 XE

246-083-002-014G

SWP-D-C

Plug Number (T2): 6; Vehicle Equipment (T31):  
for vehicles with air conditioning (T32)**1.4 i (44 kW | 1.4 Litre)**

04.93 → 08.98 C 14 NZ, X 14 SZ

246-083-001-004C

SWP-D-C

Plug Number (T2): 1; Vehicle Equipment (T31):  
without air conditioning (T36)

01.96 → 08.98 C 14 NZ

T3000001→

246-083-002-014G

SWP-D-C

Plug Number (T2): 6; Vehicle Equipment (T31):  
for vehicles with air conditioning (T32)**1.4 i 16V (66 kW | 1.4 Litre)**

09.94 → 09.00 X 14 XE

246-083-001-004C

SWP-D-C

Plug Number (T2): 1; Vehicle Equipment (T31):  
without air conditioning (T36)

01.96 → 09.00 X 14 XE

T3000001→

246-083-002-014G

SWP-D-C

Plug Number (T2): 6; Vehicle Equipment (T31):  
for vehicles with air conditioning (T32)**1.4 i S (60 kW | 1.4 Litre)**

03.93 → 09.00 C 14 SE

246-083-001-004C

SWP-D-C

Plug Number (T2): 1

**1.5 D (37 kW | 1.5 Litre)**

04.93 → 02.96 15 D

246-083-001-004C

SWP-D-C

Plug Number (T2): 1; Vehicle Equipment (T31):  
without air conditioning (T36)**1.5 TD (49 kW | 1.5 Litre)**

04.93 → 10.96 15 DT (T4EC1), X 15 DT (T4EC1)

246-083-001-004C

SWP-D-C

Plug Number (T2): 1; Vehicle Equipment (T31):  
without air conditioning (T36)

02.96 → 10.96 15 DT (T4EC1), X 15 DT (T4EC1)

T3000001→

246-083-002-014G

SWP-D-C

Plug Number (T2): 6; Vehicle Equipment (T31):  
for vehicles with air conditioning (T32)**1.6 GSI 16V (80 kW | 1.6 Litre)**

08.93 → 06.95 C 16 XE

246-083-001-004C

SWP-D-C

Plug Number (T2): 1; Vehicle Equipment (T31):  
without air conditioning (T36)**1.6 i 16V (78 kW | 1.6 Litre)**

04.97 → 09.00 X 16 XE

246-083-001-004C

SWP-D-C

Plug Number (T2): 1; Vehicle Equipment (T31):  
without air conditioning (T36)

04.97 → 09.00 X 16 XE

246-083-002-014G

SWP-D-C

Plug Number (T2): 6; Vehicle Equipment (T31):  
for vehicles with air conditioning (T32)**1.7 D (44 kW | 1.7 Litre)**

02.96 → 09.00 17 D (4EE1), X 17 D (4EE1)

246-083-001-004C

SWP-D-C

Plug Number (T2): 1; Vehicle Equipment (T31):  
without air conditioning (T36)

02.96 → 09.00 17 D (4EE1), X 17 D (4EE1)

T3000001→

246-083-002-014G

SWP-D-C

Plug Number (T2): 6; Vehicle Equipment (T31):  
for vehicles with air conditioning (T32)



			<b>VDO</b>		
Date	Engine Code	Chassis No.	Article No.	Product	Information

**VAUXHALL****CORSA Convertible****1.4 i 16V (66 kW | 1.4 Litre)**

01.98 - 01.99	X 14 XE		246-083-001-004C	SWP-D-C	Plug Number (T2): 1
---------------	---------	--	------------------	---------	---------------------

**CORSAVAN Mk I (B)****1.4 i (44 kW | 1.4 Litre)**

01.94 - 09.00	C 14 NZ		246-083-001-004C	SWP-D-C	Plug Number (T2): 1
---------------	---------	--	------------------	---------	---------------------

**1.5 D (37 kW | 1.5 Litre)**

08.94 - 12.95	15 D		246-083-001-004C	SWP-D-C	Plug Number (T2): 1
---------------	------	--	------------------	---------	---------------------

**1.7 D (44 kW | 1.7 Litre)**

01.94 - 09.00	17 D (4EE1), X 17 D (4EE1)		246-083-001-004C	SWP-D-C	Plug Number (T2): 1
---------------	----------------------------	--	------------------	---------	---------------------

**INSIGNIA****1.6 (85 kW | 1.6 Litre)**

07.08 -	A 16 XER		A2C53240114	SWP-M-C	
---------	----------	--	-------------	---------	--

**1.6 Turbo (132 kW | 1.6 Litre)**

01.09 -	A 16 LET		A2C53240114	SWP-M-C	
---------	----------	--	-------------	---------	--

**1.8 (103 kW | 1.8 Litre)**

07.08 -	A 18 XER		A2C53240114	SWP-M-C	
---------	----------	--	-------------	---------	--

**2.0 CDTI (118 kW | 2.0 Litre)**

07.08 -	A 20 DTH		A2C53240114	SWP-M-C	
---------	----------	--	-------------	---------	--

**2.0 CDTI (140 kW | 2.0 Litre)**

10.08 -	A 20 DTR		A2C53240114	SWP-M-C	
---------	----------	--	-------------	---------	--

**2.0 CDTI (81 kW | 2.0 Litre)**

07.08 -	A 20 DTC		A2C53240114	SWP-M-C	
---------	----------	--	-------------	---------	--

**2.0 CDTI (96 kW | 2.0 Litre)**

07.08 -	A 20 DTJ		A2C53240114	SWP-M-C	
---------	----------	--	-------------	---------	--

**2.0 CDTI 4x4 (118 kW | 2.0 Litre)**

07.08 -	A 20 DTH		A2C53240114	SWP-M-C	
---------	----------	--	-------------	---------	--

**2.0 CDTI 4x4 (140 kW | 2.0 Litre)**

05.09 -	A 20 DTR		A2C53240114	SWP-M-C	
---------	----------	--	-------------	---------	--

**2.0 Turbo (162 kW | 2.0 Litre)**

07.08 -	A 20 NHT		A2C53240114	SWP-M-C	
---------	----------	--	-------------	---------	--

**2.0 Turbo 4x4 (162 kW | 2.0 Litre)**

07.08 -	A 20 NHT		A2C53240114	SWP-M-C	
---------	----------	--	-------------	---------	--

**2.8 V6 Turbo 4x4 (191 kW | 2.8 Litre)**

07.08 -	A 28 NET		A2C53240114	SWP-M-C	
---------	----------	--	-------------	---------	--

**2.8 VXR (239 kW | 2.8 Litre)**

07.09 -	A 28 NER		A2C53240114	SWP-M-C	
---------	----------	--	-------------	---------	--

**INSIGNIA Saloon****1.4 (103 kW | 1.4 Litre)**

04.11 -	A 14 NET		A2C53240114	SWP-M-C	
---------	----------	--	-------------	---------	--

**1.6 (85 kW | 1.6 Litre)**

07.08 -	A 16 XER		A2C53240114	SWP-M-C	
---------	----------	--	-------------	---------	--

**1.6 Turbo (132 kW | 1.6 Litre)**

01.09 -	A 16 LET		A2C53240114	SWP-M-C	
---------	----------	--	-------------	---------	--

**1.8 (103 kW | 1.8 Litre)**

07.08 -	A 18 XER		A2C53240114	SWP-M-C	
---------	----------	--	-------------	---------	--

**2.0 Biturbo CDTI (143 kW | 2.0 Litre)**

03.12 -	A 20 DTR		A2C53240114	SWP-M-C	
---------	----------	--	-------------	---------	--

**2.0 Biturbo CDTI 4x4 (143 kW | 2.0 Litre)**

03.12 -	A 20 DTR		A2C53240114	SWP-M-C	
---------	----------	--	-------------	---------	--

**2.0 CDTI (118 kW | 2.0 Litre)**

07.08 -	A 20 DTH		A2C53240114	SWP-M-C	
---------	----------	--	-------------	---------	--

**2.0 CDTI (140 kW | 2.0 Litre)**

11.08 -	A 20 DTR		A2C53240114	SWP-M-C	
---------	----------	--	-------------	---------	--

**2.0 CDTI (81 kW | 2.0 Litre)**

07.08 -	A 20 DTC		A2C53240114	SWP-M-C	
---------	----------	--	-------------	---------	--

**2.0 CDTI (96 kW | 2.0 Litre)**

07.08 -	A 20 DTJ		A2C53240114	SWP-M-C	
---------	----------	--	-------------	---------	--

**2.0 CDTI 4x4 (118 kW | 2.0 Litre)**

07.08 -	A 20 DTH		A2C53240114	SWP-M-C	
---------	----------	--	-------------	---------	--



			<b>VDO</b>		
Date	Engine Code	Chassis No.	Article No.	Product	Information

**VAUXHALL****INSIGNIA Saloon**

<b>2.0 CDTI 4x4 (140 kW   2.0 Litre)</b>					
05.09 -	A 20 DTR		A2C53240114	SWP-M-C	
<b>2.0 Turbo (162 kW   2.0 Litre)</b>					
07.08 -	A 20 NHT		A2C53240114	SWP-M-C	
<b>2.0 Turbo 4x4 (162 kW   2.0 Litre)</b>					
07.08 -	A 20 NHT		A2C53240114	SWP-M-C	
<b>2.0 Turbo 4x4 (184 kW   2.0 Litre)</b>					
09.11 -	A 20 NHT		A2C53240114	SWP-M-C	
<b>2.8 V6 Turbo 4x4 (191 kW   2.8 Litre)</b>					
07.08 -	A 28 NET		A2C53240114	SWP-M-C	
<b>2.8 VXR (239 kW   2.8 Litre)</b>					
07.09 -	A 28 NER		A2C53240114	SWP-M-C	

**NOVA**

<b>1.0 (33 kW   1.0 Litre)</b>					
04.83 - 10.87	10 S		246-082-008-014C	SWP-M-C	Plug Number (T2): 1
<b>1.2 N (33 kW   1.2 Litre)</b>					
01.85 - 10.87	12 NC, E 12 GV		246-082-008-014C	SWP-M-C	Plug Number (T2): 1
<b>1.2 S (40 kW   1.2 Litre)</b>					
04.83 - 10.87	12 ST		246-082-008-014C	SWP-M-C	Plug Number (T2): 1
<b>1.3 i (44 kW   1.3 Litre)</b>					
09.85 - 10.87	13 NB		246-082-008-014C	SWP-M-C	Plug Number (T2): 1
<b>1.4 S (55 kW   1.4 Litre)</b>					
08.90 - 10.92	14 NV		246-082-008-014C	SWP-M-C	Plug Number (T2): 1

**NOVA Hatchback**

<b>1.0 (33 kW   1.0 Litre)</b>					
05.83 - 03.92	10 S		246-082-008-014C	SWP-M-C	Plug Number (T2): 1
<b>1.2 i CAT (33 kW   1.2 Litre)</b>					
02.92 - 03.93	C 12 NZ		246-082-008-014C	SWP-M-C	Plug Number (T2): 1
<b>1.2 N (38 kW   1.2 Litre)</b>					
05.90 - 03.93	12 NV		246-082-008-014C	SWP-M-C	Plug Number (T2): 1
<b>1.2 S (40 kW   1.2 Litre)</b>					
05.83 - 02.90	12 ST		246-082-008-014C	SWP-M-C	Plug Number (T2): 1
<b>1.3 S (51 kW   1.3 Litre)</b>					
07.83 - 09.89	13 SB		246-082-008-014C	SWP-M-C	Plug Number (T2): 1
<b>1.4 i (44 kW   1.4 Litre)</b>					
08.90 - 03.93	C 14 NZ		246-082-008-014C	SWP-M-C	Plug Number (T2): 1
<b>1.4 S (55 kW   1.4 Litre)</b>					
01.90 - 01.92	14 NV		246-082-008-014C	SWP-M-C	Plug Number (T2): 1
<b>1.5 D (37 kW   1.5 Litre)</b>					
09.91 - 03.93	15 D		246-082-008-014C	SWP-M-C	Plug Number (T2): 1
<b>1.5 TD (49 kW   1.5 Litre)</b>					
01.90 - 03.93	15 DT (T4EC1)		246-082-008-014C	SWP-M-C	Plug Number (T2): 1
<b>1.6 GSI (72 kW   1.6 Litre)</b>					
02.92 - 03.93	C 16 SEI		246-082-008-014C	SWP-M-C	Plug Number (T2): 1
<b>1.6 GSI (74 kW   1.6 Litre)</b>					
05.88 - 01.92	E 16 SE		246-082-008-014C	SWP-M-C	Plug Number (T2): 1

**OMEGA (B)**

<b>2.0 (85 kW   2.0 Litre)</b>					
04.94 - 10.95	X 20 SE		246-082-008-014C	SWP-M-C	Plug Number (T2): 1
<b>2.0 16V (100 kW   2.0 Litre)</b>					
04.94 - 09.99	X 20 XEV	-X1999999	246-082-008-014C	SWP-M-C	Plug Number (T2): 1
<b>2.0 DTI 16V (74 kW   2.0 Litre)</b>					
01.98 - 12.99	X 20 DTH	-X1999999	246-082-008-014C	SWP-M-C	Plug Number (T2): 1
01.00 - 09.00	X 20 DTH	Y1000001-	246-082-008-021G	SWP-M-C	Plug Number (T2): 6
<b>2.5 TD (96 kW   2.5 Litre)</b>					
04.94 - 12.99	25 DT, X 25 DT	-X1999999	246-082-008-014C	SWP-M-C	Plug Number (T2): 1
01.00 - 02.01	25 DT, X 25 DT	Y1000001-	246-082-008-021G	SWP-M-C	Plug Number (T2): 6
<b>2.5 V6 (125 kW   2.5 Litre)</b>					
04.94 - 12.99	X 25 XE	-X1999999	246-082-008-014C	SWP-M-C	Plug Number (T2): 1
01.00 - 09.00	X 25 XE	Y1000001-	246-082-008-021G	SWP-M-C	Plug Number (T2): 6



Date	Engine Code	Chassis No.	Article No.	Product	Information

**VAUXHALL****OMEGA (B)****3.0 V6 (155 kW | 3.0 Litre)**

06.94 - 12.99	X 30 XE	-X1999999	246-082-008-014C	SWP-M-C	Plug Number (T2): 1
01.00 - 07.00	X 30 XE	Y1000001-	246-082-008-021G	SWP-M-C	Plug Number (T2): 6

**OMEGA (B) Estate****2.0 (85 kW | 2.0 Litre)**

04.94 - 10.95	X 20 SE		246-083-001-004C	SWP-D-C	Plug Number (T2): 1
---------------	---------	--	------------------	---------	---------------------

**2.0 16V (100 kW | 2.0 Litre)**

04.94 - 12.99	X 20 XEV	-X1999999	246-083-001-004C	SWP-D-C	Plug Number (T2): 1
---------------	----------	-----------	------------------	---------	---------------------

**2.5 TD (96 kW | 2.5 Litre)**

01.97 - 12.99	25 DT, X 25 DT	-X1999999	246-083-001-004C	SWP-D-C	Plug Number (T2): 1
01.00 - 02.01	25 DT, X 25 DT	Y1000001-	246-083-002-014G	SWP-D-C	Plug Number (T2): 6

**2.5 V6 (125 kW | 2.5 Litre)**

04.94 - 12.99	X 25 XE	-X1999999	246-083-001-004C	SWP-D-C	Plug Number (T2): 1
01.00 - 09.00	X 25 XE	Y1000001-	246-083-002-014G	SWP-D-C	Plug Number (T2): 6

**3.0 V6 (155 kW | 3.0 Litre)**

06.96 - 12.99	X 30 XE	-X1999999	246-083-001-004C	SWP-D-C	Plug Number (T2): 1
01.00 - 07.00	X 30 XE	Y1000001-	246-083-002-014G	SWP-D-C	Plug Number (T2): 6

**SENATOR Mk II (B)****2.5 i (103 kW | 2.5 Litre)**

09.87 - 09.90	25 E		246-082-008-014C	SWP-M-C	Plug Number (T2): 1
---------------	------	--	------------------	---------	---------------------

**2.6 i (110 kW | 2.6 Litre)**

09.90 - 08.93	C 26 NE		246-082-008-014C	SWP-M-C	Plug Number (T2): 1
---------------	---------	--	------------------	---------	---------------------

**3.0 (115 kW | 3.0 Litre)**

09.90 - 10.92	C 30 LE		246-082-008-014C	SWP-M-C	Plug Number (T2): 1
---------------	---------	--	------------------	---------	---------------------

**3.0 (130 kW | 3.0 Litre)**

01.88 - 08.90	30 NE		246-082-008-014C	SWP-M-C	Plug Number (T2): 1
---------------	-------	--	------------------	---------	---------------------

**3.0 24V (150 kW | 3.0 Litre)**

10.89 - 08.93	C 30 SE		246-082-008-014C	SWP-M-C	Plug Number (T2): 1
---------------	---------	--	------------------	---------	---------------------

**3.0 i CAT (130 kW | 3.0 Litre)**

09.90 - 10.92	C 30 NE		246-082-008-014C	SWP-M-C	Plug Number (T2): 1
---------------	---------	--	------------------	---------	---------------------

**TIGRA Mk I (F07)****1.4 16V (66 kW | 1.4 Litre)**

11.94 - 12.00	X 14 XE		246-083-001-004C	SWP-D-C	Plug Number (T2): 1; Vehicle Equipment (T31): without air conditioning (T36)
---------------	---------	--	------------------	---------	------------------------------------------------------------------------------

**1.6 16V (78 kW | 1.6 Litre)**

11.94 - 12.00	X 16 XE		246-083-001-004C	SWP-D-C	Plug Number (T2): 1; Vehicle Equipment (T31): without air conditioning (T36)
---------------	---------	--	------------------	---------	------------------------------------------------------------------------------

**VECTRA (B)****1.6 i (55 kW | 1.6 Litre)**

10.95 - 10.01	X 16 SZR		246-082-008-021G	SWP-M-C	Plug Number (T2): 6
---------------	----------	--	------------------	---------	---------------------

**1.6 i 16V (74 kW | 1.6 Litre)**

10.95 - 10.01	X 16 XEL		246-082-008-021G	SWP-M-C	Plug Number (T2): 6
---------------	----------	--	------------------	---------	---------------------

**1.7 TD (60 kW | 1.7 Litre)**

10.95 - 07.96	X 17 DT (TC4EE1)		246-082-008-021G	SWP-M-C	Plug Number (T2): 6
---------------	------------------	--	------------------	---------	---------------------

**1.8 i 16V (85 kW | 1.8 Litre)**

10.95 - 09.00	X 18 XE, X 18 XE1		246-082-008-021G	SWP-M-C	Plug Number (T2): 6
---------------	-------------------	--	------------------	---------	---------------------

**2.0 DI 16V (60 kW | 2.0 Litre)**

08.96 - 10.01	X 20 DTL		246-082-008-021G	SWP-M-C	Plug Number (T2): 6
---------------	----------	--	------------------	---------	---------------------

**2.0 i 16V (100 kW | 2.0 Litre)**

10.95 - 01.01	X 20 XEV		246-082-008-021G	SWP-M-C	Plug Number (T2): 6
---------------	----------	--	------------------	---------	---------------------

**2.5 i V6 (125 kW | 2.5 Litre)**

10.95 - 08.00	X 25 XE		246-082-008-021G	SWP-M-C	Plug Number (T2): 6
---------------	---------	--	------------------	---------	---------------------

**VECTRA (B) Hatchback****1.6 i (55 kW | 1.6 Litre)**

10.95 - 10.01	X 16 SZR		246-082-008-021G	SWP-M-C	Plug Number (T2): 6
---------------	----------	--	------------------	---------	---------------------

**1.6 i 16V (74 kW | 1.6 Litre)**

10.95 - 10.01	X 16 XEL		246-082-008-021G	SWP-M-C	Plug Number (T2): 6
---------------	----------	--	------------------	---------	---------------------



			<b>VDO</b>		
Date	Engine Code	Chassis No.	Article No.	Product	Information

**VAUXHALL****VECTRA (B) Hatchback****1.7 TD (60 kW | 1.7 Litre)**

10.95 → 07.96 X 17 DT (TC4EE1)

246-082-008-021G

SWP-M-C

Plug Number (T2): 6

**1.8 i 16V (85 kW | 1.8 Litre)**

10.95 → 09.00 X 18 XE, X 18 XE1

246-082-008-021G

SWP-M-C

Plug Number (T2): 6

**2.0 Di 16V (60 kW | 2.0 Litre)**

08.96 → 10.01 X 20 DTL

246-082-008-021G

SWP-M-C

Plug Number (T2): 6

**2.0 i 16V (100 kW | 2.0 Litre)**

10.95 → 01.01 X 20 XEV

246-082-008-021G

SWP-M-C

Plug Number (T2): 6

**2.5 i V6 (125 kW | 2.5 Litre)**

10.95 → 08.00 X 25 XE

246-082-008-021G

SWP-M-C

Plug Number (T2): 6

**VECTRA (B) Estate****1.8 i 16V (85 kW | 1.8 Litre)**

11.96 → 09.00 X 18 XE, X 18 XE1

246-083-002-014G

SWP-D-C

Plug Number (T2): 6

**2.0 DI 16V (60 kW | 2.0 Litre)**

10.96 → 10.01 X 20 DTL

246-083-002-014G

SWP-D-C

Plug Number (T2): 6

**2.0 i 16V (100 kW | 2.0 Litre)**

10.96 → 01.01 X 20 XEV

246-083-002-014G

SWP-D-C

Plug Number (T2): 6

**2.5 i V6 (125 kW | 2.5 Litre)**

11.96 → 08.00 X 25 XE

246-083-002-014G

SWP-D-C

Plug Number (T2): 6

**ZAFIRA Mk I (A) (F75)****1.6 16V (74 kW | 1.6 Litre)**

05.99 → 08.05 X 16 XEL, Z 16 XE

246-083-002-014G

SWP-D-C

Plug Number (T2): 6

**1.8 16V (85 kW | 1.8 Litre)**

05.99 → 08.00 X 18 XE1

246-083-002-014G

SWP-D-C

Plug Number (T2): 6

**2.0 DI 16V (60 kW | 2.0 Litre)**

10.99 → 08.05 X 20 DTL

246-083-002-014G

SWP-D-C

Plug Number (T2): 6

**VOLVO****V70 I (P80\_)****2.0 (93 kW | 2.0 Litre)**

01.97 → 03.00 B 5202 S

246-075-044-002A

SWP-M-G

Plug Number (T2): 2; T25: 1259832

**2.3 T AWD (184 kW | 2.3 Litre)**

05.97 → 03.00 B 5234 FT+

246-075-044-002A

SWP-M-G

Plug Number (T2): 2; T25: 1259832

**2.3 T-5 AWD (176 kW | 2.3 Litre)**

01.97 → 03.00 B 5234 T3

246-075-044-002A

SWP-M-G

Plug Number (T2): 2; T25: 1259832

**2.4 (103 kW | 2.4 Litre)**

08.99 → 05.00 B 5244 S2, B 5244 SG2

246-075-044-002A

SWP-M-G

Plug Number (T2): 2; T25: 1259832

**2.4 Turbo (142 kW | 2.4 Litre)**

01.97 → 03.00 B 5254 T, B 5244 T

246-075-044-002A

SWP-M-G

Plug Number (T2): 2; T25: 1259832

**2.5 (121 kW | 2.5 Litre)**

06.98 → 03.00 B 5254 S

246-075-044-002A

SWP-M-G

Plug Number (T2): 2; T25: 1259832

**2.5 Bifuel (106 kW | 2.5 Litre)**

10.98 → 08.99 GB 5252 S

246-075-044-002A

SWP-M-G

Plug Number (T2): 2; T25: 1259832

**2.5 TDI (103 kW | 2.5 Litre)**

01.97 → 05.00 D 5252 T

246-075-044-002A

SWP-M-G

Plug Number (T2): 2; T25: 1259832

**V90 Estate****2.5 (125 kW | 2.5 Litre)**

11.96 → 10.98 B 6254 FS

246-075-044-002A

SWP-M-G

Plug Number (T2): 2; T25: 1259832

**2.5 (132 kW | 2.5 Litre)**

11.96 → 10.97 B 6244 FS

246-075-044-002A

SWP-M-G

Plug Number (T2): 2; T25: 1259832

**2.9 (132 kW | 2.9 Litre)**

01.97 → 12.98 B 6304 S2

246-075-044-002A

SWP-M-G

Plug Number (T2): 2; T25: 1259832

**2.9 (150 kW | 2.9 Litre)**

01.97 → 12.98 B 6304 G

246-075-044-002A

SWP-M-G

Plug Number (T2): 2; T25: 1259832



			<b>VDO</b>		
Date	Engine Code	Chassis No.	Article No.	Product	Information

**VOLVO****140 (142, 144)****2.0 S (85 kW | 2.0 Litre)**

09.72 - 08.75	B 20 F		246-075-044-002A	SWP-M-G	Plug Number (T2): 2; T25: 1259832
---------------	--------	--	------------------	---------	-----------------------------------

**340-360 (343, 345)****1.3 (49 kW | 1.3 Litre)**

01.89 - 12.90	B 13		246-075-042-001C	SWP-M-G	Plug Number (T2): 1
---------------	------	--	------------------	---------	---------------------

**1.4 (46 kW | 1.4 Litre)**

08.82 - 08.85	B 14.3 E		246-075-042-001C	SWP-M-G	Plug Number (T2): 1
---------------	----------	--	------------------	---------	---------------------

**1.4 (47 kW | 1.4 Litre)**

08.79 - 07.83	B 14.3 E		246-075-042-001C	SWP-M-G	Plug Number (T2): 1
---------------	----------	--	------------------	---------	---------------------

**1.4 (50 kW | 1.4 Litre)**

08.86 - 12.88	B 14.4 S		246-075-042-001C	SWP-M-G	Plug Number (T2): 1
---------------	----------	--	------------------	---------	---------------------

**1.4 (51 kW | 1.4 Litre)**

08.75 - 07.83	B 14.4 S		246-075-042-001C	SWP-M-G	Plug Number (T2): 1
---------------	----------	--	------------------	---------	---------------------

**1.4 (52 kW | 1.4 Litre)**

08.87 - 07.88	B 14.4 S		246-075-042-001C	SWP-M-G	Plug Number (T2): 1
---------------	----------	--	------------------	---------	---------------------

**1.4 (52 kW | 1.4 Litre)**

08.83 - 07.86	B 14.4 S		246-075-042-001C	SWP-M-G	Plug Number (T2): 1
---------------	----------	--	------------------	---------	---------------------

**1.6 Diesel (40 kW | 1.6 Litre)**

08.84 - 07.91	D 16		246-075-042-001C	SWP-M-G	Plug Number (T2): 1
---------------	------	--	------------------	---------	---------------------

**1.7 (59 kW | 1.7 Litre)**

08.85 - 07.91	B 17 2 K		246-075-042-001C	SWP-M-G	Plug Number (T2): 1
---------------	----------	--	------------------	---------	---------------------

**2.0 (65 kW | 2.0 Litre)**

08.80 - 07.84	B 19 A		246-075-042-001C	SWP-M-G	Plug Number (T2): 1
---------------	--------	--	------------------	---------	---------------------

**2.0 (68 kW | 2.0 Litre)**

08.83 - 07.84	B 19 A		246-075-042-001C	SWP-M-G	Plug Number (T2): 1
---------------	--------	--	------------------	---------	---------------------

**2.0 (70 kW | 2.0 Litre)**

08.80 - 07.83	B 19 A, B 200 K		246-075-042-001C	SWP-M-G	Plug Number (T2): 1
---------------	-----------------	--	------------------	---------	---------------------

**2.0 (77 kW | 2.0 Litre)**

08.84 - 07.87	B 200 K		246-075-042-001C	SWP-M-G	Plug Number (T2): 1
---------------	---------	--	------------------	---------	---------------------

**2.0 (80 kW | 2.0 Litre)**

08.88 - 07.89	B 200 F		246-075-042-001C	SWP-M-G	Plug Number (T2): 1
---------------	---------	--	------------------	---------	---------------------

**2.0 (81 kW | 2.0 Litre)**

08.87 - 07.88	B 200 F		246-075-042-001C	SWP-M-G	Plug Number (T2): 1
---------------	---------	--	------------------	---------	---------------------

**2.0 (82 kW | 2.0 Litre)**

08.86 - 07.88	B 200 E, B 200 F		246-075-042-001C	SWP-M-G	Plug Number (T2): 1
---------------	------------------	--	------------------	---------	---------------------

**2.0 (83 kW | 2.0 Litre)**

08.82 - 07.84	B 19 E		246-075-042-001C	SWP-M-G	Plug Number (T2): 1
---------------	--------	--	------------------	---------	---------------------

**2.0 (85 kW | 2.0 Litre)**

08.82 - 07.84	B 19 E		246-075-042-001C	SWP-M-G	Plug Number (T2): 1
---------------	--------	--	------------------	---------	---------------------

**2.0 (87 kW | 2.0 Litre)**

08.84 - 07.86	B 200 E		246-075-042-001C	SWP-M-G	Plug Number (T2): 1
---------------	---------	--	------------------	---------	---------------------

**2.1 (90 kW | 2.1 Litre)**

08.81 - 07.82	B 21 E		246-075-042-001C	SWP-M-G	Plug Number (T2): 1
---------------	--------	--	------------------	---------	---------------------

**740 (744)****2.0 (89 kW | 2.0 Litre)**

08.85 - 07.91	B 200 G		246-075-044-001C	SWP-M-G	Plug Number (T2): 2; T25: 1258016
---------------	---------	--	------------------	---------	-----------------------------------

**2.3 (114 kW | 2.3 Litre)**

08.88 - 07.90	B 234 F		246-075-044-001C	SWP-M-G	Plug Number (T2): 2; T25: 1258016
---------------	---------	--	------------------	---------	-----------------------------------

**2.3 (83 kW | 2.3 Litre)**

09.85 - 12.89	B 230 F		246-075-044-001C	SWP-M-G	Plug Number (T2): 2; T25: 1258016
---------------	---------	--	------------------	---------	-----------------------------------

**2.3 (96 kW | 2.3 Litre)**

08.84 - 07.88	B 230 E		246-075-044-001C	SWP-M-G	Plug Number (T2): 2; T25: 1258016
---------------	---------	--	------------------	---------	-----------------------------------

**2.3 Turbo (115 kW | 2.3 Litre)**

07.88 - 07.89	B 230 FT		246-075-044-001C	SWP-M-G	Plug Number (T2): 2; T25: 1258016
---------------	----------	--	------------------	---------	-----------------------------------

**2.3 Turbo (121 kW | 2.3 Litre)**

08.89 - 07.90	B 230 FT		246-075-044-001C	SWP-M-G	Plug Number (T2): 2; T25: 1258016
---------------	----------	--	------------------	---------	-----------------------------------

**2.4 Diesel (60 kW | 2.4 Litre)**

08.84 - 07.92	D 24		246-075-044-001C	SWP-M-G	Plug Number (T2): 2; T25: 1258016
---------------	------	--	------------------	---------	-----------------------------------

**2.4 TD (83 kW | 2.4 Litre)**

07.85 - 07.90	D 24 T		246-075-044-001C	SWP-M-G	Plug Number (T2): 2; T25: 1258016
---------------	--------	--	------------------	---------	-----------------------------------





			<b>VDO</b>		
Date	Engine Code	Chassis No.	Article No.	Product	Information

**VOLVO****740 Kombi (745)****2.0 (82 kW | 2.0 Litre)**

08.89 - 07.91	B 200 F		246-075-044-001C	SWP-M-G	Plug Number (T2): 2; T25: 1258016
08.89 - 07.91	B 200 F		246-075-044-002A	SWP-M-G	Plug Number (T2): 2; T25: 1259832

**2.0 (89 kW | 2.0 Litre)**

08.85 - 07.92	B 200 G, B 200 E		246-075-044-001C	SWP-M-G	Plug Number (T2): 2; T25: 1258016
08.85 - 07.92	B 200 G, B 200 E		246-075-044-002A	SWP-M-G	Plug Number (T2): 2; T25: 1259832

**2.3 (114 kW | 2.3 Litre)**

08.88 - 07.90	B 234 F		246-075-044-001C	SWP-M-G	Plug Number (T2): 2; T25: 1258016
08.88 - 07.90	B 234 F		246-075-044-002A	SWP-M-G	Plug Number (T2): 2; T25: 1259832

**2.3 (83 kW | 2.3 Litre)**

08.85 - 12.89	B 230 F		246-075-044-001C	SWP-M-G	Plug Number (T2): 2; T25: 1258016
08.85 - 12.89	B 230 F		246-075-044-002A	SWP-M-G	Plug Number (T2): 2; T25: 1259832

**2.3 (96 kW | 2.3 Litre)**

08.85 - 07.88	B 230 E		246-075-044-001C	SWP-M-G	Plug Number (T2): 2; T25: 1258016
08.85 - 07.88	B 230 E		246-075-044-002A	SWP-M-G	Plug Number (T2): 2; T25: 1259832

**2.3 Turbo (115 kW | 2.3 Litre)**

08.86 - 07.89	B 230 FT		246-075-044-001C	SWP-M-G	Plug Number (T2): 2; T25: 1258016
08.86 - 07.89	B 230 FT		246-075-044-002A	SWP-M-G	Plug Number (T2): 2; T25: 1259832

**2.3 Turbo (121 kW | 2.3 Litre)**

08.89 - 07.90	B 230 GT, B 230 FT		246-075-044-001C	SWP-M-G	Plug Number (T2): 2; T25: 1258016
08.89 - 07.90	B 230 GT, B 230 FT		246-075-044-002A	SWP-M-G	Plug Number (T2): 2; T25: 1259832

**2.3 Turbo (134 kW | 2.3 Litre)**

08.85 - 07.88	B 230 ET		246-075-044-001C	SWP-M-G	Plug Number (T2): 2; T25: 1258016
---------------	----------	--	------------------	---------	-----------------------------------

**2.4 Diesel (60 kW | 2.4 Litre)**

08.85 - 07.88	D 24		246-075-044-001C	SWP-M-G	Plug Number (T2): 2; T25: 1258016
08.85 - 07.88	D 24		246-075-044-002A	SWP-M-G	Plug Number (T2): 2; T25: 1259832

**2.4 TD Interc. (90 kW | 2.4 Litre)**

08.86 - 07.88	D 24 TIC		246-075-044-001C	SWP-M-G	Plug Number (T2): 2; T25: 1258016
07.87 - 07.88	D 24 TIC		246-075-044-002A	SWP-M-G	Plug Number (T2): 2; T25: 1259832

**2.4 Turbo-Diesel (80 kW | 2.4 Litre)**

09.85 - 07.92	D 24 T		246-075-044-001C	SWP-M-G	Plug Number (T2): 2; T25: 1258016
09.85 - 07.92	D 24 T		246-075-044-002A	SWP-M-G	Plug Number (T2): 2; T25: 1259832

**760 (704, 764)****2.3 Turbo (704) (134 kW | 2.3 Litre)**

08.84 - 06.85	B 230 ET		246-075-044-001C	SWP-M-G	Plug Number (T2): 2; T25: 1258016
---------------	----------	--	------------------	---------	-----------------------------------

**2.4 TD Interc. (704) (85 kW | 2.4 Litre)**

08.87 - 12.90	D 24 TIC		246-075-044-001C	SWP-M-G	Plug Number (T2): 2; T25: 1258016
---------------	----------	--	------------------	---------	-----------------------------------

**2.4 Turbo Diesel (704) (80 kW | 2.4 Litre)**

04.87 - 07.92	D 24 T		246-075-044-001C	SWP-M-G	Plug Number (T2): 2; T25: 1258016
---------------	--------	--	------------------	---------	-----------------------------------

**2.4 Turbo Diesel (704) (82 kW | 2.4 Litre)**

08.82 - 06.87	D 24 T		246-075-044-001C	SWP-M-G	Plug Number (T2): 2; T25: 1258016
---------------	--------	--	------------------	---------	-----------------------------------

**2.8 (704) (105 kW | 2.8 Litre)**

05.86 - 12.90	B 280 F		246-075-044-001C	SWP-M-G	Plug Number (T2): 2; T25: 1258016
---------------	---------	--	------------------	---------	-----------------------------------

**2.8 (704, 764) (115 kW | 2.8 Litre)**

02.82 - 06.85	B 28 E, B 280 E		246-075-044-001C	SWP-M-G	Plug Number (T2): 2; T25: 1258016
---------------	-----------------	--	------------------	---------	-----------------------------------

**760 Kombi (704, 765)****2.8 (765) (105 kW | 2.8 Litre)**

05.86 - 12.90	B 280 F		246-075-044-001C	SWP-M-G	Plug Number (T2): 2; T25: 1258016
07.86 - 12.90	B 280 F		246-075-044-002A	SWP-M-G	Plug Number (T2): 2; T25: 1259832

**780****2.9 (115 kW | 2.9 Litre)**

08.86 - 07.87	B 280 E		246-075-044-001C	SWP-M-G	Plug Number (T2): 2; T25: 1258016
---------------	---------	--	------------------	---------	-----------------------------------

**850 (LS)****2.0 (105 kW | 2.0 Litre)**

06.91 - 12.96	B 5204 F		246-075-044-001C	SWP-M-G	Plug Number (T2): 2; T25: 1258016
---------------	----------	--	------------------	---------	-----------------------------------

**2.0 (93 kW | 2.0 Litre)**

08.94 - 12.96	B 5202 S		246-075-044-001C	SWP-M-G	Plug Number (T2): 2; T25: 1258016
---------------	----------	--	------------------	---------	-----------------------------------

**2.0 Turbo (155 kW | 2.0 Litre)**

01.94 - 12.96	B 5204 T, B 5204 FT		246-075-044-001C	SWP-M-G	Plug Number (T2): 2; T25: 1258016
---------------	---------------------	--	------------------	---------	-----------------------------------



			<b>VDO</b>		
Date	Engine Code	Chassis No.	Article No.	Product	Information

**VOLVO****850 (LS)****2.3 T5 (166 kW | 2.3 Litre)**

08.93 → 07.96 B 5234 FT 246-075-044-001C SWP-M-G Plug Number (T2): 2; T25: 1258016

**2.3 T5-R (184 kW | 2.3 Litre)**

08.95 → 12.96 B 5234 T4 246-075-044-001C SWP-M-G Plug Number (T2): 2; T25: 1258016

**2.5 (103 kW | 2.5 Litre)**

06.91 → 07.94 B 5252 246-075-044-001C SWP-M-G Plug Number (T2): 2; T25: 1258016

**2.5 (106 kW | 2.5 Litre)**

08.94 → 12.96 B 5252 S 246-075-044-001C SWP-M-G Plug Number (T2): 2; T25: 1258016

**2.5 TDI (103 kW | 2.5 Litre)**

02.96 → 12.96 D 5252 T 246-075-044-001C SWP-M-G Plug Number (T2): 2; T25: 1258016

**850 Estate (LW)****2.0 (105 kW | 2.0 Litre)**

02.93 → 12.96 B 5204 F 246-075-044-001C SWP-M-G Plug Number (T2): 2; T25: 1258016

02.93 → 12.96 B 5204 F 246-075-044-002A SWP-M-G Plug Number (T2): 2; T25: 1259832

**2.0 (93 kW | 2.0 Litre)**

08.94 → 12.96 B 5202 S 246-075-044-001C SWP-M-G Plug Number (T2): 2; T25: 1258016

08.94 → 12.96 B 5202 S 246-075-044-002A SWP-M-G Plug Number (T2): 2; T25: 1259832

**2.0 Turbo (155 kW | 2.0 Litre)**

01.94 → 12.96 B 5204 T, B 5204 FT 246-075-044-001C SWP-M-G Plug Number (T2): 2; T25: 1258016

01.94 → 12.96 B 5204 T, B 5204 FT 246-075-044-002A SWP-M-G Plug Number (T2): 2; T25: 1259832

**2.3 T5 (166 kW | 2.3 Litre)**

03.93 → 12.96 B 5234 FT 246-075-044-001C SWP-M-G Plug Number (T2): 2; T25: 1258016

03.93 → 12.96 B 5234 FT 246-075-044-002A SWP-M-G Plug Number (T2): 2; T25: 1259832

**2.5 (103 kW | 2.5 Litre)**

04.94 → 07.94 B 5252 246-075-044-001C SWP-M-G Plug Number (T2): 2; T25: 1258016

04.94 → 07.94 B 5252 246-075-044-002A SWP-M-G Plug Number (T2): 2; T25: 1259832

**2.5 (125 kW | 2.5 Litre)**

09.92 → 12.96 B 5254 S 246-075-044-001C SWP-M-G Plug Number (T2): 2; T25: 1258016

12.92 → 12.96 B 5254 S 246-075-044-002A SWP-M-G Plug Number (T2): 2; T25: 1259832

**2.5 AWD (142 kW | 2.5 Litre)**

06.96 → 12.96 B 5254 T 246-075-044-001C SWP-M-G Plug Number (T2): 2; T25: 1258016

06.96 → 12.96 B 5254 T 246-075-044-002A SWP-M-G Plug Number (T2): 2; T25: 1259832

**2.5 TDI (103 kW | 2.5 Litre)**

02.96 → 12.96 D 5252 T 246-075-044-001C SWP-M-G Plug Number (T2): 2; T25: 1258016

02.96 → 12.96 D 5252 T 246-075-044-002A SWP-M-G Plug Number (T2): 2; T25: 1259832

**940 (944)****2.0 (82 kW | 2.0 Litre)**

01.92 → 07.94 B 200 F 246-075-044-001C SWP-M-G Plug Number (T2): 2; T25: 1258016

**2.3 (114 kW | 2.3 Litre)**

09.90 → 07.91 B 234 F, B 234 G 246-075-044-001C SWP-M-G Plug Number (T2): 2; T25: 1258016

**2.3 (96 kW | 2.3 Litre)**

09.91 → 12.94 B 230 FB, B 230 G →227665 246-075-044-001C SWP-M-G Plug Number (T2): 2; T25: 1258016

**2.3 Turbo (121 kW | 2.3 Litre)**

09.90 → 07.94 B 230 FT 246-075-044-001C SWP-M-G Plug Number (T2): 2; T25: 1258016

**2.4 TD Intercooler (90 kW | 2.4 Litre)**

08.90 → 07.93 D 24 TIC 246-075-044-001C SWP-M-G Plug Number (T2): 2; T25: 1258016

**2.4 Turbo Diesel (80 kW | 2.4 Litre)**

09.90 → 07.93 D 24 T 246-075-044-001C SWP-M-G Plug Number (T2): 2; T25: 1258016

**940 Kombi (945)****2.0 (82 kW | 2.0 Litre)**

01.92 → 07.94 B 200 F 246-075-044-001C SWP-M-G Plug Number (T2): 2; T25: 1258016

01.92 → 07.94 B 200 F 246-075-044-002A SWP-M-G Plug Number (T2): 2; T25: 1259832

**2.0 Turbo (114 kW | 2.0 Litre)**

01.91 → 07.95 B 200 FT →177655 246-075-044-001C SWP-M-G Plug Number (T2): 2; T25: 1258016

01.91 → 07.95 B 200 FT →204601 246-075-044-002A SWP-M-G Plug Number (T2): 2; T25: 1259832

**2.3 (114 kW | 2.3 Litre)**

09.90 → 07.91 B 234 F →177655 246-075-044-001C SWP-M-G Plug Number (T2): 2; T25: 1258016

09.90 → 07.91 B 234 F →204601 246-075-044-002A SWP-M-G Plug Number (T2): 2; T25: 1259832

**2.3 (96 kW | 2.3 Litre)**

09.90 → 12.94 B 230 FB →177655 246-075-044-001C SWP-M-G Plug Number (T2): 2; T25: 1258016



			<b>VDO</b>		
Date	Engine Code	Chassis No.	Article No.	Product	Information

**VOLVO****940 Kombi (945)****2.3 (96 kW | 2.3 Litre)**

09.90 - 12.94	B 230 FB	204602-- -204601	246-075-044-002A	SWP-M-G	Plug Number (T2): 2; T25: 1259832
---------------	----------	---------------------	------------------	---------	-----------------------------------

**2.3 Turbo (121 kW | 2.3 Litre)**

09.90 - 07.94	B 230 FT	-33113	246-075-044-001C	SWP-M-G	Plug Number (T2): 2; T25: 1258016
09.90 - 07.94	B 230 FT		246-075-044-002A	SWP-M-G	Plug Number (T2): 2; T25: 1259832

**2.3 Turbo (140 kW | 2.3 Litre)**

08.91 - 06.93	B 230 FT+		246-075-044-001C	SWP-M-G	Plug Number (T2): 2; T25: 1258016
08.91 - 06.93	B 230 FT+		246-075-044-002A	SWP-M-G	Plug Number (T2): 2; T25: 1259832

**2.4 Turbo Diesel (80 kW | 2.4 Litre)**

09.90 - 07.93	D 24 T		246-075-044-001C	SWP-M-G	Plug Number (T2): 2; T25: 1258016
---------------	--------	--	------------------	---------	-----------------------------------

**940 II (944)****2.3 (85 kW | 2.3 Litre)**

08.94 - 07.95	B 230 FD	-227665	246-075-044-001C	SWP-M-G	Plug Number (T2): 2; T25: 1258016
---------------	----------	---------	------------------	---------	-----------------------------------

**2.3 Turbo (121 kW | 2.3 Litre)**

08.94 - 12.97	B 230 FT	-227665	246-075-044-001C	SWP-M-G	Plug Number (T2): 2; T25: 1258016
---------------	----------	---------	------------------	---------	-----------------------------------

**2.4 TD Interc. (90 kW | 2.4 Litre)**

08.94 - 12.97	D 24 TIC	-227665	246-075-044-001C	SWP-M-G	Plug Number (T2): 2; T25: 1258016
---------------	----------	---------	------------------	---------	-----------------------------------

**940 II Estate (945)****2.3 (85 kW | 2.3 Litre)**

08.94 - 07.95	B 230 FD	-177655	246-075-044-001C	SWP-M-G	Plug Number (T2): 2; T25: 1258016
08.94 - 07.95	B 230 FD	-204601	246-075-044-002A	SWP-M-G	Plug Number (T2): 2; T25: 1259832

**2.3 (96 kW | 2.3 Litre)**

09.94 - 12.97	B 230 FB	-177655	246-075-044-001C	SWP-M-G	Plug Number (T2): 2; T25: 1258016
09.94 - 12.97	B 230 FB	-204601	246-075-044-002A	SWP-M-G	Plug Number (T2): 2; T25: 1259832

**2.3 Turbo (121 kW | 2.3 Litre)**

09.94 - 12.96	B 230 FT	-33113	246-075-044-001C	SWP-M-G	Plug Number (T2): 2; T25: 1258016
09.94 - 08.96	B 230 FT		246-075-044-002A	SWP-M-G	Plug Number (T2): 2; T25: 1259832

**2.4 TD Interc. (90 kW | 2.4 Litre)**

08.94 - 10.98	D 24 TIC	-177655	246-075-044-001C	SWP-M-G	Plug Number (T2): 2; T25: 1258016
08.94 - 12.97	D 24 TIC	-204601	246-075-044-002A	SWP-M-G	Plug Number (T2): 2; T25: 1259832

**960 (964)****2.4 TD Interc. (85 kW | 2.4 Litre)**

09.91 - 07.94	D 24 TIC		246-075-044-001C	SWP-M-G	Plug Number (T2): 2; T25: 1258016
---------------	----------	--	------------------	---------	-----------------------------------

**2.9 (150 kW | 2.9 Litre)**

09.90 - 07.94	B 6304 F	-89893	246-075-044-001C	SWP-M-G	Plug Number (T2): 2; T25: 1258016
---------------	----------	--------	------------------	---------	-----------------------------------

**960 Kombi (965)****2.4 TD Interc. (85 kW | 2.4 Litre)**

09.91 - 07.94	D 24 TIC	-33113	246-075-044-001C	SWP-M-G	Plug Number (T2): 2; T25: 1258016
09.91 - 07.94	D 24 TIC		246-075-044-002A	SWP-M-G	Plug Number (T2): 2; T25: 1259832

**2.9 (150 kW | 2.9 Litre)**

09.90 - 07.94	B 6304 F, B 6304 S	-33113	246-075-044-001C	SWP-M-G	Plug Number (T2): 2; T25: 1258016
09.90 - 07.94	B 6304 F, B 6304 S		246-075-044-002A	SWP-M-G	Plug Number (T2): 2; T25: 1259832

**960 II (964)****2.5 (125 kW | 2.5 Litre)**

09.94 - 12.96	B 6254 S	-89893	246-075-044-001C	SWP-M-G	Plug Number (T2): 2; T25: 1258016
---------------	----------	--------	------------------	---------	-----------------------------------

**960 II Estate (965)****2.5 (125 kW | 2.5 Litre)**

09.94 - 12.96	B 6254 S	-33113	246-075-044-001C	SWP-M-G	Plug Number (T2): 2; T25: 1258016
09.94 - 12.96	B 6254 S		246-075-044-002A	SWP-M-G	Plug Number (T2): 2; T25: 1259832



			<b>VDO</b>		
Date	Engine Code	Chassis No.	Article No.	Product	Information

**VW****AMAROK****2.0 BiTDI (120 kW | 2.0 Litre)**

09.10 → CDCA 246-082-008-025G SWP-M-C

**2.0 BiTDI 4motion (120 kW | 2.0 Litre)**

09.10 → CDCA 246-082-008-025G SWP-M-C

**2.0 TDI (90 kW | 2.0 Litre)**

09.10 → CDBA 246-082-008-025G SWP-M-C

**2.0 TDI 4motion (90 kW | 2.0 Litre)**

09.10 → CDBA 246-082-008-025G SWP-M-C

**BORA (1J2)****1.4 16V (55 kW | 1.4 Litre)**

03.00 → 05.05 AHW, AKQ, APE, AXP, BCA 246-082-008-025G SWP-M-C

03.00 → 05.05 AHW, AKQ, APE, AXP, BCA 246-083-002-022G SWP-D-C

03.00 → 05.05 AHW, AKQ, APE, AXP, BCA 246-086-001-002C HLWP Plug Number (T2): 3

03.00 → 05.05 AHW, AKQ, APE, AXP, BCA 246-086-001-007C HLWP Plug Number (T2): 3b; T26: X11-246-003-014

**1.6 (74 kW | 1.6 Litre)**

10.98 → 05.05 AEH, AKL, APF 246-082-008-025G SWP-M-C

10.98 → 05.05 AEH, AKL, APF 246-083-002-022G SWP-D-C

10.98 → 05.05 AEH, AKL, APF 246-086-001-002C HLWP Plug Number (T2): 3

10.98 → 05.05 AEH, AKL, APF 246-086-001-007C HLWP Plug Number (T2): 3b; T26: X11-246-003-014

**1.6 (75 kW | 1.6 Litre)**

08.00 → 05.05 AVU, BFQ, BJH 246-082-008-025G SWP-M-C

08.00 → 05.05 AVU, BFQ, BJH 246-086-001-007C HLWP Plug Number (T2): 3b; T26: X11-246-003-014

**1.6 (78 kW | 1.6 Litre)**

06.02 → 10.04 AWB 246-082-008-025G SWP-M-C

**1.6 16V (77 kW | 1.6 Litre)**

05.00 → 05.05 AUS, AZD, ATN, BCB 246-082-008-025G SWP-M-C

05.00 → 05.05 AUS, AZD, ATN, BCB 246-086-001-007C HLWP Plug Number (T2): 3b; T26: X11-246-003-014

**1.6 FSI (81 kW | 1.6 Litre)**

01.02 → 05.05 BAD 246-082-008-025G SWP-M-C

01.02 → 05.05 BAD 246-086-001-007C HLWP Plug Number (T2): 3b; T26: X11-246-003-014

**1.8 (92 kW | 1.8 Litre)**

10.98 → 05.05 AGN, BAF 246-082-008-025G SWP-M-C

10.98 → 05.05 AGN, BAF 246-086-001-007C HLWP Plug Number (T2): 3b; T26: X11-246-003-014

**1.8 4motion (92 kW | 1.8 Litre)**

02.99 → 05.05 AGN 246-082-008-025G SWP-M-C

02.99 → 05.05 AGN 246-083-002-022G SWP-D-C

02.99 → 05.05 AGN 246-086-001-002C HLWP Plug Number (T2): 3

02.99 → 05.05 AGN 246-086-001-007C HLWP Plug Number (T2): 3b; T26: X11-246-003-014

**1.8 T (110 kW | 1.8 Litre)**

05.00 → 05.05 AGU, ARX, AUM, BAE 246-082-008-025G SWP-M-C

05.00 → 05.05 AGU, ARX, AUM, BAE 246-086-001-007C HLWP Plug Number (T2): 3b; T26: X11-246-003-014

**1.8 T (132 kW | 1.8 Litre)**

03.02 → 05.05 AUQ 246-082-008-025G SWP-M-C

03.02 → 05.05 AUQ 246-086-001-007C HLWP Plug Number (T2): 3b; T26: X11-246-003-014

**1.9 SDI (50 kW | 1.9 Litre)**

10.98 → 05.05 AQM, AGP 1J-X-000 001→ 246-082-008-025G SWP-M-C

10.98 → 05.05 AQM, AGP 1J-X-000 001→ 246-083-002-022G SWP-D-C

10.98 → 04.01 AQM, AGP 246-086-001-002C HLWP Plug Number (T2): 3

10.98 → 05.05 AQM, AGP 246-086-001-007C HLWP Plug Number (T2): 3b; T26: X11-246-003-014

**1.9 TDI (110 kW | 1.9 Litre)**

05.00 → 05.05 ARL 246-082-008-025G SWP-M-C

05.00 → 05.05 ARL 246-086-001-007C HLWP Plug Number (T2): 3b; T26: X11-246-003-014

**1.9 TDI (66 kW | 1.9 Litre)**

10.98 → 06.01 ALH, AGR 1J-X-000 001→ 246-082-008-025G SWP-M-C

10.98 → 06.01 ALH, AGR 1J-X-000 001→ 246-083-002-022G SWP-D-C

10.98 → 06.01 ALH, AGR 246-086-001-002C HLWP Plug Number (T2): 3

10.98 → 06.01 ALH, AGR 246-086-001-007C HLWP Plug Number (T2): 3b; T26: X11-246-003-014

**1.9 TDI (74 kW | 1.9 Litre)**

09.00 → 05.05 ATD, AXR 1J-1-300 001→ 246-082-008-025G SWP-M-C

09.00 → 05.05 ATD, AXR 246-086-001-007C HLWP Plug Number (T2): 3b; T26: X11-246-003-014

**1.9 TDI (81 kW | 1.9 Litre)**

10.98 → 06.01 AHF, ASV 1J-X-000 001→ 246-082-008-025G SWP-M-C



			<b>VDO</b>		
Date	Engine Code	Chassis No.	Article No.	Product	Information

**VW****BORA (1J2)**

<b>1.9 TDI (81 kW   1.9 Litre)</b>					
10.98 - 06.01	AHF, ASV	1J-X-000 001→	246-083-002-022G	SWP-D-C	
10.98 - 06.01	AHF, ASV		246-086-001-002C	HLWP	Plug Number (T2): 3
10.98 - 06.01	AHF, ASV		246-086-001-007C	HLWP	Plug Number (T2): 3b; T26: X11-246-003-014
<b>1.9 TDI (85 kW   1.9 Litre)</b>					
12.98 - 06.01	AJM, AUJ	1J-1-300 001→	246-082-008-025G	SWP-M-C	
12.98 - 06.01	AJM, AUJ	1J-1-300 001→	246-083-002-022G	SWP-D-C	
03.99 - 06.01	AJM, AUJ		246-086-001-002C	HLWP	Plug Number (T2): 3
12.98 - 06.01	AJM, AUJ		246-086-001-007C	HLWP	Plug Number (T2): 3b; T26: X11-246-003-014
<b>1.9 TDI (96 kW   1.9 Litre)</b>					
11.00 - 05.05	ASZ		246-082-008-025G	SWP-M-C	
11.00 - 05.05	ASZ		246-086-001-007C	HLWP	Plug Number (T2): 3b; T26: X11-246-003-014
<b>1.9 TDI 4motion (110 kW   1.9 Litre)</b>					
05.01 - 05.05	ARL		246-082-008-025G	SWP-M-C	
05.00 - 05.05	ARL		246-086-001-007C	HLWP	Plug Number (T2): 3b; T26: X11-246-003-014
<b>1.9 TDI 4motion (66 kW   1.9 Litre)</b>					
02.99 - 06.01	AGR	1J-X-000 001→	246-082-008-025G	SWP-M-C	
02.99 - 06.01	AGR	1J-X-000 001→	246-083-002-022G	SWP-D-C	
02.99 - 06.01	AGR		246-086-001-002C	HLWP	Plug Number (T2): 3
02.99 - 06.01	AGR		246-086-001-007C	HLWP	Plug Number (T2): 3b; T26: X11-246-003-014
<b>1.9 TDI 4motion (74 kW   1.9 Litre)</b>					
05.01 - 05.05	ATD		246-082-008-025G	SWP-M-C	
09.00 - 05.05	ATD		246-086-001-007C	HLWP	Plug Number (T2): 3b; T26: X11-246-003-014
<b>1.9 TDI 4motion (85 kW   1.9 Litre)</b>					
02.99 - 06.01	AJM, AUJ	→1J-1-300 000	246-082-008-025G	SWP-M-C	
02.99 - 06.01	AJM, AUJ		246-086-001-007C	HLWP	Plug Number (T2): 3b; T26: X11-246-003-014
<b>1.9 TDI 4motion (96 kW   1.9 Litre)</b>					
05.01 - 05.05	ASZ		246-082-008-025G	SWP-M-C	
11.00 - 05.05	ASZ		246-086-001-007C	HLWP	Plug Number (T2): 3b; T26: X11-246-003-014
<b>2.0 (85 kW   2.0 Litre)</b>					
10.98 - 05.05	APK, AQY, AZG, AZH, AZJ, BBW		246-082-008-025G	SWP-M-C	
10.98 - 05.05	APK, AQY, AZG, AZH, AZJ, BBW		246-083-002-022G	SWP-D-C	
10.98 - 05.05	APK, AQY, AZG, AZH, AZJ, BBW		246-086-001-002C	HLWP	Plug Number (T2): 3
10.98 - 05.05	APK, AQY, AZG, AZH, AZJ, BBW		246-086-001-007C	HLWP	Plug Number (T2): 3b; T26: X11-246-003-014
<b>2.0 4motion (85 kW   2.0 Litre)</b>					
04.00 - 05.05	AZJ		246-082-008-025G	SWP-M-C	
04.00 - 05.05	AZH, AZJ		246-086-001-007C	HLWP	Plug Number (T2): 3b; T26: X11-246-003-014
<b>2.3 V5 (110 kW   2.3 Litre)</b>					
10.98 - 10.00	AGZ		246-082-008-025G	SWP-M-C	
10.98 - 10.00	AGZ		246-083-002-022G	SWP-D-C	
10.98 - 10.00	AGZ		246-086-001-002C	HLWP	Plug Number (T2): 3
10.98 - 10.00	AGZ		246-086-001-007C	HLWP	Plug Number (T2): 3b; T26: X11-246-003-014
<b>2.3 V5 (125 kW   2.3 Litre)</b>					
10.00 - 05.05	AQN		246-082-008-025G	SWP-M-C	
10.00 - 05.05	AQN		246-086-001-007C	HLWP	Plug Number (T2): 3b; T26: X11-246-003-014
<b>2.3 V5 4motion (110 kW   2.3 Litre)</b>					
01.99 - 10.00	AGZ		246-082-008-025G	SWP-M-C	
01.99 - 10.00	AGZ		246-083-002-022G	SWP-D-C	
01.99 - 10.00	AGZ		246-086-001-002C	HLWP	Plug Number (T2): 3
12.98 - 10.00	AGZ		246-086-001-007C	HLWP	Plug Number (T2): 3b; T26: X11-246-003-014
<b>2.3 V5 4motion (125 kW   2.3 Litre)</b>					
10.00 - 05.05	AQN		246-082-008-025G	SWP-M-C	T26: 1J0 955 665 H
10.00 - 05.05	AQN		246-086-001-007C	HLWP	Plug Number (T2): 3b; T26: X11-246-003-014
<b>2.8 V6 4motion (150 kW   2.8 Litre)</b>					
03.99 - 05.05	AQP, AUE, BDE		246-082-008-025G	SWP-M-C	T26: 1J0 955 665 H
03.99 - 05.05	AQP, AUE, BDE		246-086-001-007C	HLWP	Plug Number (T2): 3b; T26: X11-246-003-014
<b>2.8 VR6 (130 kW   2.8 Litre)</b>					
11.98 - 07.02			246-082-008-025G	SWP-M-C	T26: 1J0 955 665 H
<b>2.8 VR6 (147 kW   2.8 Litre)</b>					
02.02 - 07.05	BDF		246-082-008-025G	SWP-M-C	T26: 1J0 955 665 H



			<b>VDO</b>		
Date	Engine Code	Chassis No.	Article No.	Product	Information

**VW****BORA Estate (1J6)**

<b>1.4 16V (55 kW   1.4 Litre)</b>					
09.01 - 05.05	BCA, AHW, AXP		246-083-002-022G	SWP-D-C	
<b>1.6 (74 kW   1.6 Litre)</b>					
05.99 - 05.05	AEH, AKL, APF		246-082-008-025G	SWP-M-C	
05.99 - 05.05	AEH, AKL, APF		246-083-002-022G	SWP-D-C	
05.99 - 05.05	AEH, AKL, APF		246-086-001-002C	HLWP	Plug Number (T2): 3
<b>1.6 (75 kW   1.6 Litre)</b>					
08.00 - 05.05	AVU, BFQ		246-083-002-022G	SWP-D-C	
<b>1.6 16V (77 kW   1.6 Litre)</b>					
02.00 - 05.05	AUS, AZD, ATN, BCB		246-083-002-022G	SWP-D-C	
<b>1.6 FSI (81 kW   1.6 Litre)</b>					
01.02 - 05.05	BAD		246-083-002-022G	SWP-D-C	
<b>1.8 4motion (92 kW   1.8 Litre)</b>					
05.99 - 05.05	AGN		246-082-008-025G	SWP-M-C	
05.99 - 05.05	AGN		246-083-002-022G	SWP-D-C	
05.99 - 05.05	AGN		246-086-001-002C	HLWP	Plug Number (T2): 3
<b>1.8 T (110 kW   1.8 Litre)</b>					
05.00 - 05.05	AGU, ARX, AUM		246-083-002-022G	SWP-D-C	
<b>1.8 T (132 kW   1.8 Litre)</b>					
05.02 - 05.05	AUQ		246-083-002-022G	SWP-D-C	
<b>1.9 TDI (110 kW   1.9 Litre)</b>					
05.01 - 05.05	ARL	1J-1-300 001→	246-082-008-025G	SWP-M-C	
05.01 - 05.05	ARL	1J-1-300 001→	246-083-002-022G	SWP-D-C	
<b>1.9 TDI (66 kW   1.9 Litre)</b>					
07.04 - 05.05	AGR		246-082-008-025G	SWP-M-C	
07.04 - 05.05	AGR		246-083-002-022G	SWP-D-C	
<b>1.9 TDI (74 kW   1.9 Litre)</b>					
09.00 - 05.05	ATD, AXR	1J-1-300 001→	246-082-008-025G	SWP-M-C	
09.00 - 05.05	ATD, AXR	1J-1-300 001→	246-083-002-022G	SWP-D-C	
<b>1.9 TDI (81 kW   1.9 Litre)</b>					
05.99 - 06.01	AHF, ASV	1J-X-000 001→	246-082-008-025G	SWP-M-C	
05.99 - 06.01	AHF, ASV	1J-X-000 001→	246-083-002-022G	SWP-D-C	
05.99 - 06.01	AHF, ASV		246-086-001-002C	HLWP	Plug Number (T2): 3
<b>1.9 TDI (85 kW   1.9 Litre)</b>					
05.99 - 06.01	AJM, AUJ	1J-1-300 001→	246-082-008-025G	SWP-M-C	
05.99 - 06.01	AJM, AUJ	1J-1-300 001→	246-083-002-022G	SWP-D-C	
05.99 - 06.01	AJM, AUJ		246-086-001-002C	HLWP	Plug Number (T2): 3
<b>1.9 TDI (96 kW   1.9 Litre)</b>					
11.00 - 05.05	ASZ		246-082-008-025G	SWP-M-C	
11.00 - 05.05	ASZ		246-083-002-022G	SWP-D-C	
<b>1.9 TDI 4motion (110 kW   1.9 Litre)</b>					
05.01 - 05.05	ARL		246-082-008-025G	SWP-M-C	
05.01 - 05.05	ARL		246-083-002-022G	SWP-D-C	
<b>1.9 TDI 4motion (74 kW   1.9 Litre)</b>					
09.00 - 05.05	ATD	→1J-1-300 000	246-082-008-025G	SWP-M-C	
09.00 - 05.05	ATD	→1J-1-300 000	246-083-002-022G	SWP-D-C	
<b>1.9 TDI 4motion (85 kW   1.9 Litre)</b>					
05.99 - 06.01	AJM, AUJ	→1J-1-300 000	246-082-008-025G	SWP-M-C	
05.99 - 06.01	AJM, AUJ	→1J-1-300 000	246-083-002-022G	SWP-D-C	
05.99 - 06.01	AJM, AUJ		246-086-001-002C	HLWP	Plug Number (T2): 3
<b>1.9 TDI 4motion (96 kW   1.9 Litre)</b>					
11.00 - 05.05	ASZ		246-082-008-025G	SWP-M-C	
11.00 - 05.05	ASZ		246-083-002-022G	SWP-D-C	
<b>2.0 (85 kW   2.0 Litre)</b>					
05.99 - 05.05	AQY, APK, AZG, AZH, AZJ		246-082-008-025G	SWP-M-C	
05.99 - 05.05	AQY, APK, AZG, AZH, AZJ		246-083-002-022G	SWP-D-C	
05.99 - 05.05	AQY, APK, AZG, AZH, AZJ		246-086-001-002C	HLWP	Plug Number (T2): 3
<b>2.0 4motion (85 kW   2.0 Litre)</b>					
04.00 - 05.05	AZH, AZJ		246-083-002-022G	SWP-D-C	
<b>2.3 V5 (110 kW   2.3 Litre)</b>					
05.99 - 10.00	AGZ		246-082-008-025G	SWP-M-C	
05.99 - 10.00	AGZ		246-083-002-022G	SWP-D-C	
05.99 - 10.00	AGZ		246-086-001-002C	HLWP	Plug Number (T2): 3



			<b>VDO</b>		
Date	Engine Code	Chassis No.	Article No.	Product	Information

**VW****BORA Estate (1J6)****2.3 V5 (125 kW | 2.3 Litre)**

10.00 - 05.05	AQN		246-083-002-022G	SWP-D-C	
---------------	-----	--	------------------	---------	--

**2.3 V5 4motion (110 kW | 2.3 Litre)**

05.99 - 10.00	AGZ		246-082-008-025G	SWP-M-C	
05.99 - 10.00	AGZ		246-083-002-022G	SWP-D-C	
05.99 - 10.00	AGZ		246-086-001-002C	HLWP	Plug Number (T2): 3

**2.3 V5 4motion (125 kW | 2.3 Litre)**

10.00 - 05.05	AQN		246-083-002-022G	SWP-D-C	
---------------	-----	--	------------------	---------	--

**2.8 V6 4motion (150 kW | 2.8 Litre)**

05.99 - 05.05	AQP, AUE, BDE		246-082-008-025G	SWP-M-C	
05.99 - 05.05	AQP, AUE, BDE		246-083-002-022G	SWP-D-C	
05.99 - 05.05	AQP, AUE, BDE		246-086-001-002C	HLWP	Plug Number (T2): 3

**2.8 VR6 (130 kW | 2.8 Litre)**

08.02 - 07.03			246-083-002-022G	SWP-D-C	T26: 1J0 955 665 H
---------------	--	--	------------------	---------	--------------------

**CADDY I (14)****1.5 (51 kW | 1.5 Litre)**

08.82 - 07.83	JB	- J - 000 001→ -- N - 000 001	246-069-056-001Z	N	
08.82 - 07.83	JB		246-080-010-002Z	N-H	
08.82 - 07.83	JB		246-082-008-014C	SWP-M-C	Plug Number (T2): 1
08.82 - 07.83	JB		246-086-001-002C	HLWP	Plug Number (T2): 3
08.82 - 07.83	JB		246-086-001-007C	HLWP	Plug Number (T2): 3b; T26: X11-246-003-014

**1.6 (55 kW | 1.6 Litre)**

01.83 - 07.92	EW	- J - 000 001→ -- N - 000 001	246-069-056-001Z	N	
01.83 - 07.92	EW		246-080-010-002Z	N-H	
08.83 - 07.92	EW		246-082-008-014C	SWP-M-C	Plug Number (T2): 1
08.83 - 07.92	EW		246-086-001-002C	HLWP	Plug Number (T2): 3
01.83 - 07.92	EW		246-086-001-007C	HLWP	Plug Number (T2): 3b; T26: X11-246-003-014

**1.6 D (40 kW | 1.6 Litre)**

08.82 - 07.92	JK, ME	- J - 000 001→ -- N - 000 001	246-069-056-001Z	N	
08.82 - 07.92	JK, ME		246-080-010-002Z	N-H	
08.82 - 03.90	JK, ME		246-082-008-014C	SWP-M-C	Plug Number (T2): 1
08.82 - 03.90	JK, ME		246-086-001-002C	HLWP	Plug Number (T2): 3
08.82 - 07.92	JK, ME		246-086-001-007C	HLWP	Plug Number (T2): 3b; T26: X11-246-003-014

**1.8 (70 kW | 1.8 Litre)**

08.85 - 07.92	JH	- J - 000 001→ -- N - 000 001	246-069-056-001Z	N	
08.85 - 07.92	JH		246-080-010-002Z	N-H	
08.85 - 07.90	JH		246-082-008-014C	SWP-M-C	Plug Number (T2): 1
08.85 - 07.90	JH		246-086-001-002C	HLWP	Plug Number (T2): 3
08.85 - 07.92	JH		246-086-001-007C	HLWP	Plug Number (T2): 3b; T26: X11-246-003-014

**CADDY II Estate (9K9B)****1.4 (44 kW | 1.4 Litre)**

11.95 - 01.04	AEX, AKV, APQ, AUD		246-082-008-025G	SWP-M-C	
11.95 - 01.04	AEX, APQ, AUD, AKV	-9K-1-512 000	246-083-002-022G	SWP-D-C	
11.95 - 01.04	AEX, APQ, AUD, AKV	9K-1-512 001→	246-086-001-007C	HLWP	Plug Number (T2): 3b

**1.4 16V (55 kW | 1.4 Litre)**

08.00 - 01.04	AUA		246-082-008-025G	SWP-M-C	
08.00 - 01.04	AUA	-9K-1-512 000	246-083-002-022G	SWP-D-C	
08.00 - 01.04	AUA	9K-1-512 001→	246-086-001-007C	HLWP	Plug Number (T2): 3b

**1.6 (55 kW | 1.6 Litre)**

11.95 - 05.97	1F		246-082-008-025G	SWP-M-C	
06.97 - 09.00	AEE		246-082-008-025G	SWP-M-C	
11.95 - 05.97	1F	-9K-1-512 000	246-083-002-022G	SWP-D-C	
06.97 - 09.00	AEE	-9K-1-512 000	246-083-002-022G	SWP-D-C	
11.95 - 05.97	1F	9K-1-512 001→	246-086-001-007C	HLWP	Plug Number (T2): 3b
06.97 - 09.00	AEE	9K-1-512 001→	246-086-001-007C	HLWP	Plug Number (T2): 3b

**1.6 (65 kW | 1.6 Litre)**

04.96 - 07.03			246-082-008-025G	SWP-M-C	
---------------	--	--	------------------	---------	--



			<b>VDO</b>		
Date	Engine Code	Chassis No.	Article No.	Product	Information

**VW****CADDY II Estate (9K9B)****1.6 (65 kW | 1.6 Litre)**

04.96 - 07.03			246-083-002-022G	SWP-D-C	T26: X11-246-003-014
---------------	--	--	------------------	---------	----------------------

**1.7 SDI (42 kW | 1.7 Litre)**

07.96 - 09.00	AHB		246-082-008-025G	SWP-M-C	
07.96 - 09.00	AHB	-9K-1-512 000	246-083-002-022G	SWP-D-C	
07.96 - 09.00	AHB	9K-1-512 001→	246-086-001-007C	HLWP	Plug Number (T2): 3b

**1.9 D (47 kW | 1.9 Litre)**

11.95 - 01.04	1Y		246-082-008-025G	SWP-M-C	
11.95 - 01.04	1Y	-9K-1-512 000	246-083-002-022G	SWP-D-C	
11.95 - 01.04	1Y	9K-1-512 001→	246-086-001-007C	HLWP	Plug Number (T2): 3b

**1.9 SDI (47 kW | 1.9 Litre)**

11.95 - 01.04	AEY, AYQ		246-082-008-025G	SWP-M-C	
11.95 - 01.04	AEY, AYQ	-9K-1-512 000	246-083-002-022G	SWP-D-C	
11.95 - 01.04	AEY, AYQ	9K-1-512 001→	246-086-001-007C	HLWP	Plug Number (T2): 3b

**1.9 TDI (66 kW | 1.9 Litre)**

10.96 - 01.04	AHU, ALE, ALH		246-082-008-025G	SWP-M-C	
10.96 - 01.04	AHU, ALE, ALH	-9K-1-512 000	246-083-002-022G	SWP-D-C	
10.96 - 01.04	AHU, ALE, ALH	9K-1-512 001→	246-086-001-007C	HLWP	Plug Number (T2): 3b

**CADDY II Box (9K9A)****1.4 (55 kW | 1.4 Litre)**

08.00 - 01.04	AUA		246-069-056-001Z	N	
08.00 - 01.04	AUA		246-080-010-002Z	N-H	
08.00 - 01.04	AUA		246-082-008-025G	SWP-M-C	
08.00 - 01.04	AUA		246-083-002-022G	SWP-D-C	
08.00 - 01.04	AUA		246-086-001-007C	HLWP	Plug Number (T2): 3b; T26: X11-246-003-014

**1.7 SDI (42 kW | 1.7 Litre)**

07.96 - 09.00	AHB		246-069-056-001Z	N	
07.96 - 09.00	AHB		246-080-010-002Z	N-H	
07.96 - 09.00	AHB		246-082-008-025G	SWP-M-C	
07.96 - 09.00	AHB		246-083-002-014G	SWP-D-C	Plug Number (T2): 6
07.96 - 09.00	AHB		246-083-002-022G	SWP-D-C	
07.96 - 09.00	AHB		246-086-001-007C	HLWP	Plug Number (T2): 3b; T26: X11-246-003-014

**1.9 D (47 kW | 1.9 Litre)**

11.95 - 01.04	1Y		246-069-056-001Z	N	
11.95 - 01.04	1Y		246-080-010-002Z	N-H	
11.95 - 01.04	1Y		246-082-008-025G	SWP-M-C	
11.95 - 01.04	1Y		246-083-002-014G	SWP-D-C	Plug Number (T2): 6
11.95 - 01.04	1Y		246-083-002-022G	SWP-D-C	
11.95 - 01.04	1Y		246-086-001-007C	HLWP	Plug Number (T2): 3b; T26: X11-246-003-014

**1.9 SDI (47 kW | 1.9 Litre)**

11.95 - 01.04	AEY, AYQ		246-069-056-001Z	N	
11.95 - 01.04	AEY, AYQ		246-080-010-002Z	N-H	
11.95 - 01.04	AEY, AYQ		246-082-008-025G	SWP-M-C	
11.95 - 01.04	AEY, AYQ		246-083-002-022G	SWP-D-C	
11.95 - 01.04	AEY, AYQ		246-086-001-007C	HLWP	Plug Number (T2): 3b; T26: X11-246-003-014

**1.9 TDI (66 kW | 1.9 Litre)**

09.96 - 01.04	AHU, 1Z, ALH		246-069-056-001Z	N	
09.96 - 01.04	AHU, 1Z, ALH		246-080-010-002Z	N-H	
09.96 - 01.04	1Z, AHU, ALH		246-082-008-025G	SWP-M-C	
12.96 - 01.04	AHU, 1Z, ALH		246-083-002-014G	SWP-D-C	Plug Number (T2): 6
09.96 - 01.04	AHU, 1Z, ALH		246-083-002-022G	SWP-D-C	
12.96 - 01.04	AHU, 1Z, ALH		246-086-001-007C	HLWP	Plug Number (T2): 3b; T26: X11-246-003-014

**60 1.4 (44 kW | 1.4 Litre)**

11.95 - 01.04	AEX, APQ, AUD		246-069-056-001Z	N	
11.95 - 01.04	AEX, APQ, AUD		246-080-010-002Z	N-H	
11.95 - 01.04	AEX, APQ, AUD		246-082-008-025G	SWP-M-C	
11.95 - 12.97	AEX, APQ, AUD		246-083-002-014G	SWP-D-C	Plug Number (T2): 6
11.95 - 01.04	AEX, APQ, AUD		246-083-002-022G	SWP-D-C	
11.95 - 12.97	AEX, APQ, AUD		246-086-001-007C	HLWP	Plug Number (T2): 3b; T26: X11-246-003-014

**75 1.6 (55 kW | 1.6 Litre)**

11.95 - 09.00	AEE		246-069-056-001Z	N	
11.95 - 09.00	AEE		246-080-010-002Z	N-H	





			<b>VDO</b>		
Date	Engine Code	Chassis No.	Article No.	Product	Information

**VW****CADDY II Box (9K9A)****75 1.6 (55 kW | 1.6 Litre)**

11.95 - 05.97	1F		246-082-008-025G	SWP-M-C	
11.95 - 09.00	AEE		246-082-008-025G	SWP-M-C	
11.95 - 05.97	1F	-9K-1-512 000	246-083-002-022G	SWP-D-C	
11.95 - 09.00	AEE		246-083-002-022G	SWP-D-C	
11.95 - 05.97	1F	9K-1-512 001→	246-086-001-007C	HLWP	Plug Number (T2): 3b
11.95 - 09.00	AEE		246-086-001-007C	HLWP	Plug Number (T2): 3b; T26: X11-246-003-014

**CADDY II Pickup (9U7)****1.6 (55 kW | 1.6 Litre)**

06.96 - 12.00	AEE		246-082-008-025G	SWP-M-C	
06.96 - 12.00	AEE		246-086-001-007C	HLWP	Plug Number (T2): 3b

**1.9 D (47 kW | 1.9 Litre)**

06.96 - 12.00	AEF		246-082-008-025G	SWP-M-C	
06.96 - 12.00	AEF		246-086-001-007C	HLWP	Plug Number (T2): 3b

**CADDY III Estate (2KB, 2KJ, 2CB, 2CJ)****1.2 TSI (63 kW | 1.2 Litre)**

09.10 -	CBZA		246-082-008-025G	SWP-M-C	
09.10 -	CBZA		246-083-002-022G	SWP-D-C	

**1.2 TSI (77 kW | 1.2 Litre)**

09.10 -	CBZB		246-082-008-025G	SWP-M-C	
09.10 -	CBZB		246-083-002-022G	SWP-D-C	

**1.4 (55 kW | 1.4 Litre)**

03.04 - 05.06	BCA		246-082-008-025G	SWP-M-C	
03.04 - 05.06	BCA		246-083-002-022G	SWP-D-C	
03.04 - 05.06	BCA		246-086-001-007C	HLWP	Plug Number (T2): 3b

**1.4 16V (59 kW | 1.4 Litre)**

05.06 - 08.10	BUD		246-082-008-025G	SWP-M-C	
05.06 - 08.10	BUD		246-083-002-022G	SWP-D-C	

**1.6 (74 kW | 1.6 Litre)**

03.05 -	BRY		246-082-008-025G	SWP-M-C	
03.05 -	BRY		246-083-002-022G	SWP-D-C	

**1.6 (75 kW | 1.6 Litre)**

04.04 -	BGU, BSE, BSF		246-082-008-025G	SWP-M-C	
04.04 -	BGU, BSE, BSF		246-083-002-022G	SWP-D-C	
04.04 -	BGU, BSE, BSF		246-086-001-007C	HLWP	Plug Number (T2): 3b

**1.6 TDI (55 kW | 1.6 Litre)**

08.10 -	CAYE		246-082-008-025G	SWP-M-C	
08.10 -	CAYE		246-083-002-022G	SWP-D-C	

**1.6 TDI (75 kW | 1.6 Litre)**

08.10 -	CAYD		246-082-008-025G	SWP-M-C	
08.10 -	CAYD		246-083-002-022G	SWP-D-C	

**1.9 TDI (55 kW | 1.9 Litre)**

09.05 - 08.10	BSU		246-082-008-025G	SWP-M-C	
09.05 - 08.10	BSU		246-083-002-022G	SWP-D-C	

**1.9 TDI (77 kW | 1.9 Litre)**

04.04 - 08.10	BJB, BLS		246-082-008-025G	SWP-M-C	
04.04 - 08.10	BJB, BLS		246-083-002-022G	SWP-D-C	
04.04 - 08.10	BJB, BLS		246-086-001-007C	HLWP	Plug Number (T2): 3b

**1.9 TDI 4motion (77 kW | 1.9 Litre)**

05.08 - 08.10	BLS		246-082-008-025G	SWP-M-C	
05.08 - 08.10	BLS		246-083-002-022G	SWP-D-C	

**2.0 EcoFuel (80 kW | 2.0 Litre)**

04.06 -	BSX		246-082-008-025G	SWP-M-C	
04.06 -	BSX		246-083-002-022G	SWP-D-C	

**2.0 SDI (51 kW | 2.0 Litre)**

03.04 - 08.10	BDJ, BST		246-082-008-025G	SWP-M-C	
03.04 - 08.10	BDJ, BST		246-083-002-022G	SWP-D-C	
03.04 - 08.10	BDJ, BST		246-086-001-007C	HLWP	Plug Number (T2): 3b

**2.0 TDI (103 kW | 2.0 Litre)**

09.07 - 08.10	BMM		246-082-008-025G	SWP-M-C	
09.07 - 08.10	BMM		246-083-002-022G	SWP-D-C	



			<b>VDO</b>		
Date	Engine Code	Chassis No.	Article No.	Product	Information

**VW****CADDY III Estate (2KB, 2KJ, 2CB, 2CJ)****2.0 TDI 16V (103 kW | 2.0 Litre)**

11.10 -	CFHC		246-082-008-025G	SWP-M-C	
11.10 -	CFHC		246-083-002-022G	SWP-D-C	

**2.0 TDI 4motion (81 kW | 2.0 Litre)**

08.10 -	CFHF		246-082-008-025G	SWP-M-C	
08.10 -	CFHF		246-083-002-022G	SWP-D-C	

**CADDY III Box (2KA, 2KH, 2CA, 2CH)****1.2 TSI (63 kW | 1.2 Litre)**

09.10 -	CBZA		246-082-008-025G	SWP-M-C	
09.10 -	CBZA		246-083-002-022G	SWP-D-C	
09.10 -	CBZA		246-086-001-007C	HLWP	Plug Number (T2): 3b

**1.2 TSI (77 kW | 1.2 Litre)**

09.10 -	CBZB		246-082-008-025G	SWP-M-C	
09.10 -	CBZB		246-083-002-022G	SWP-D-C	
09.10 -	CBZB		246-086-001-007C	HLWP	Plug Number (T2): 3b

**1.4 (55 kW | 1.4 Litre)**

03.04 - 05.06	BCA		246-082-008-025G	SWP-M-C	
03.04 - 05.06	BCA		246-083-002-022G	SWP-D-C	
03.04 - 05.06	BCA		246-086-001-007C	HLWP	Plug Number (T2): 3b

**1.4 16V (59 kW | 1.4 Litre)**

05.06 - 08.10	BUD		246-082-008-025G	SWP-M-C	
05.06 - 08.10	BUD		246-083-002-022G	SWP-D-C	
05.06 - 08.10	BUD		246-086-001-007C	HLWP	Plug Number (T2): 3b

**1.6 (75 kW | 1.6 Litre)**

04.04 -	BGU, BSE, BSF		246-082-008-025G	SWP-M-C	
04.04 -	BGU, BSE, BSF		246-083-002-022G	SWP-D-C	
04.04 -	BGU, BSE, BSF		246-086-001-007C	HLWP	Plug Number (T2): 3b

**1.6 TDI (55 kW | 1.6 Litre)**

08.10 -	CAYE		246-082-008-025G	SWP-M-C	
08.10 -	CAYE		246-083-002-022G	SWP-D-C	
08.10 -	CAYE		246-086-001-007C	HLWP	Plug Number (T2): 3b

**1.6 TDI (75 kW | 1.6 Litre)**

08.10 -	CAYD		246-082-008-025G	SWP-M-C	
08.10 -	CAYD		246-083-002-022G	SWP-D-C	
08.10 -	CAYD		246-086-001-007C	HLWP	Plug Number (T2): 3b

**1.9 TDI (55 kW | 1.9 Litre)**

09.05 - 08.10	BSU		246-082-008-025G	SWP-M-C	
09.05 - 08.10	BSU		246-083-002-022G	SWP-D-C	
09.05 - 08.10	BSU		246-086-001-007C	HLWP	Plug Number (T2): 3b

**1.9 TDI (77 kW | 1.9 Litre)**

04.04 - 08.10	BJB, BLS		246-082-008-025G	SWP-M-C	
04.04 - 08.10	BJB, BLS		246-083-002-022G	SWP-D-C	
04.04 - 08.10	BJB, BLS		246-086-001-007C	HLWP	Plug Number (T2): 3b

**1.9 TDI 4motion (77 kW | 1.9 Litre)**

11.08 - 08.10	BLS		246-082-008-025G	SWP-M-C	
11.08 - 08.10	BLS		246-083-002-022G	SWP-D-C	

**2.0 EcoFuel (80 kW | 2.0 Litre)**

04.06 -	BSX		246-082-008-025G	SWP-M-C	
04.06 -	BSX		246-083-002-022G	SWP-D-C	
04.06 -	BSX		246-086-001-007C	HLWP	Plug Number (T2): 3b

**2.0 SDI (51 kW | 2.0 Litre)**

03.04 - 08.10	BDJ, BST		246-082-008-025G	SWP-M-C	
03.04 - 08.10	BDJ, BST		246-083-002-022G	SWP-D-C	
03.04 - 08.10	BDJ, BST		246-086-001-007C	HLWP	Plug Number (T2): 3b

**2.0 TDI (103 kW | 2.0 Litre)**

09.07 - 08.10	BMM		246-082-008-025G	SWP-M-C	
09.07 - 08.10	BMM		246-083-002-022G	SWP-D-C	
09.07 - 08.10	BMM		246-086-001-007C	HLWP	Plug Number (T2): 3b

**2.0 TDI 16V (103 kW | 2.0 Litre)**

11.10 -	CFHC		246-082-008-025G	SWP-M-C	
11.10 -	CFHC		246-083-002-022G	SWP-D-C	
11.10 -	CFHC		246-086-001-007C	HLWP	Plug Number (T2): 3b



			<b>VDO</b>		
Date	Engine Code	Chassis No.	Article No.	Product	Information

**VW****CADDY III Box (2KA, 2KH, 2CA, 2CH)****2.0 TDI 4motion (81 kW | 2.0 Litre)**

08.10 →	CFHF		246-082-008-025G	SWP-M-C	
08.10 →	CFHF		246-083-002-022G	SWP-D-C	
08.10 →	CFHF		246-086-001-007C	HLWP	Plug Number (T2): 3b

**CORRADO (53I)****1.8 16V (100 kW | 1.8 Litre)**

04.89 → 07.92	KR		246-069-056-001Z	N	
04.89 → 07.92	KR		246-080-010-002Z	N-H	
04.89 → 07.91	X 18 XE1		246-082-008-014C	SWP-M-C	Plug Number (T2): 1
04.89 → 07.91	KR		246-083-002-006G	SWP-D-C	Plug Number (T2): 1
04.89 → 07.92	KR		246-083-002-014G	SWP-D-C	Plug Number (T2): 6
04.89 → 07.92	KR		246-086-001-007C	HLWP	Plug Number (T2): 3b; T26: X11-246-003-014

**1.8 G60 (118 kW | 1.8 Litre)**

09.88 → 09.93	PG		246-069-056-001Z	N	
09.88 → 09.93	PG		246-080-010-002Z	N-H	
09.88 → 07.91	PG		246-082-008-014C	SWP-M-C	Plug Number (T2): 1
09.88 → 07.91	PG		246-083-002-006G	SWP-D-C	Plug Number (T2): 1
09.88 → 09.93	PG		246-083-002-014G	SWP-D-C	Plug Number (T2): 6
09.88 → 09.93	PG		246-086-001-007C	HLWP	Plug Number (T2): 3b; T26: X11-246-003-014

**2.0 i (85 kW | 2.0 Litre)**

04.93 → 12.95	2E, ADY		246-069-056-001Z	N	
04.93 → 12.95	2E, ADY		246-080-010-002Z	N-H	
04.93 → 07.95	2E, ADY		246-082-008-014C	SWP-M-C	Plug Number (T2): 1
04.93 → 07.95	2E, ADY		246-083-002-006G	SWP-D-C	Plug Number (T2): 1
04.93 → 12.95	2E, ADY		246-083-002-014G	SWP-D-C	Plug Number (T2): 6
04.93 → 12.95	2E, ADY		246-086-001-007C	HLWP	Plug Number (T2): 3b; T26: X11-246-003-014

**2.0 i 16V (100 kW | 2.0 Litre)**

08.91 → 12.95	9A		246-069-056-001Z	N	
08.91 → 12.95	9A		246-080-010-002Z	N-H	
08.91 → 07.94	9A		246-082-008-014C	SWP-M-C	Plug Number (T2): 1
08.91 → 07.94	9A		246-083-002-006G	SWP-D-C	Plug Number (T2): 1
08.91 → 12.95	9A		246-083-002-014G	SWP-D-C	Plug Number (T2): 6
08.91 → 12.95	9A		246-086-001-007C	HLWP	Plug Number (T2): 3b; T26: X11-246-003-014

**2.9 VR6 (140 kW | 2.9 Litre)**

08.91 → 12.95	ABV		246-069-056-001Z	N	
08.91 → 12.95	ABV		246-080-010-002Z	N-H	
08.91 → 07.95	ABV		246-082-008-014C	SWP-M-C	Plug Number (T2): 1
08.91 → 07.95	ABV		246-083-002-006G	SWP-D-C	Plug Number (T2): 1
08.91 → 12.95	ABV		246-083-002-014G	SWP-D-C	Plug Number (T2): 6
08.91 → 12.95	ABV		246-086-001-007C	HLWP	Plug Number (T2): 3b; T26: X11-246-003-014

**DERBY (86)****0.9 (29 kW | 0.9 Litre)**

02.77 → 11.78	HA	→869 2556 859	246-075-021-006C	SWP-M-G	Plug Number (T2): 1
11.78 → 09.81	HA	869 2556 860→	246-082-008-014C	SWP-M-C	Plug Number (T2): 1
02.77 → 09.81	HA		246-086-001-007C	HLWP	Plug Number (T2): 3b; T26: X11-246-003-014

**1.1 (37 kW | 1.1 Litre)**

02.77 → 11.78	HB	→869 2556 859	246-075-021-006C	SWP-M-G	Plug Number (T2): 1
11.78 → 09.81	HB	869 2556 860→	246-082-008-014C	SWP-M-C	Plug Number (T2): 1
02.77 → 09.81	HB		246-086-001-007C	HLWP	Plug Number (T2): 3b; T26: X11-246-003-014

**1.3 (44 kW | 1.3 Litre)**

02.77 → 11.78	HH	→869 2556 859	246-075-021-006C	SWP-M-G	Plug Number (T2): 1
11.78 → 09.81	HH	869 2556 860→	246-082-008-014C	SWP-M-C	Plug Number (T2): 1
02.77 → 09.81	HH		246-086-001-007C	HLWP	Plug Number (T2): 3b; T26: X11-246-003-014

**DERBY (86C, 80)****1.0 (29 kW | 1.0 Litre)**

10.81 → 10.84	GL		246-082-008-014C	SWP-M-C	Plug Number (T2): 1
10.81 → 12.84	GL		246-086-001-007C	HLWP	Plug Number (T2): 3b; T26: X11-246-003-014

**1.1 (37 kW | 1.1 Litre)**

10.81 → 07.83	HB		246-082-008-014C	SWP-M-C	Plug Number (T2): 1
10.81 → 07.83	HB		246-086-001-007C	HLWP	Plug Number (T2): 3b; T26: X11-246-003-014



			<b>VDO</b>		
Date	Engine Code	Chassis No.	Article No.	Product	Information

**VW****DERBY (86C, 80)****1.3 (40 kW | 1.3 Litre)**

08.83 - 10.84	HK		246-082-008-014C	SWP-M-C	Plug Number (T2): 1
08.83 - 12.84	HK		246-086-001-007C	HLWP	Plug Number (T2): 3b; T26: X11-246-003-014

**1.3 (44 kW | 1.3 Litre)**

10.81 - 07.83	HH		246-082-008-014C	SWP-M-C	Plug Number (T2): 1
08.81 - 07.83	HH		246-086-001-007C	HLWP	Plug Number (T2): 3b; T26: X11-246-003-014

**1.3 (55 kW | 1.3 Litre)**

08.83 - 10.84	GK		246-082-008-014C	SWP-M-C	Plug Number (T2): 1
09.82 - 12.84	GK		246-086-001-007C	HLWP	Plug Number (T2): 3b; T26: X11-246-003-014

**EOS (1F7, 1F8)****1.4 TSI (118 kW | 1.4 Litre)**

05.08 -	CAVD		246-082-008-025G	SWP-M-C	
05.08 -	CAVD		246-086-001-007C	HLWP	Plug Number (T2): 3b

**1.4 TSI (90 kW | 1.4 Litre)**

11.07 -	CAXA		246-082-008-025G	SWP-M-C	
11.07 -	CAXA		246-086-001-007C	HLWP	Plug Number (T2): 3b

**1.6 FSI (85 kW | 1.6 Litre)**

06.06 - 05.08	BLF		246-082-008-025G	SWP-M-C	
06.06 - 05.08	BLF		246-086-001-007C	HLWP	Plug Number (T2): 3b

**2.0 FSI (110 kW | 2.0 Litre)**

03.06 - 05.08	BVZ		246-082-008-025G	SWP-M-C	
03.06 - 05.08	BVY, BVZ		246-086-001-007C	HLWP	Plug Number (T2): 3b

**2.0 TDI (103 kW | 2.0 Litre)**

06.06 - 05.08	BMM		246-082-008-025G	SWP-M-C	
06.06 - 05.08	BMM		246-086-001-007C	HLWP	Plug Number (T2): 3b

**2.0 TDI 16V (103 kW | 2.0 Litre)**

05.08 -	CBAB		246-082-008-025G	SWP-M-C	
05.08 -	CBAB		246-086-001-007C	HLWP	Plug Number (T2): 3b

**2.0 TFSI (147 kW | 2.0 Litre)**

03.06 -	CCZA		246-082-008-025G	SWP-M-C	
03.06 -	BPY, BWA, CAWB, CBFA, CCTA, CCZA		246-086-001-007C	HLWP	Plug Number (T2): 3b

**2.0 TSI (155 kW | 2.0 Litre)**

11.09 -	CCZB		246-082-008-025G	SWP-M-C	
11.09 -	CCZB		246-086-001-007C	HLWP	Plug Number (T2): 3b

**3.2 V6 (184 kW | 3.2 Litre)**

06.06 -	CBRA		246-082-008-025G	SWP-M-C	
06.06 -	BUB, CBRA		246-086-001-007C	HLWP	Plug Number (T2): 3b

**3.6 V6 (191 kW | 3.6 Litre)**

05.09 -	CDVA		246-082-008-025G	SWP-M-C	
05.09 -	CDVA		246-086-001-007C	HLWP	Plug Number (T2): 3b

**FOX (5Z1, 5Z3)****1.2 (40 kW | 1.2 Litre)**

04.05 -	BMD, CHFB		246-082-008-025G	SWP-M-C	
04.05 -	BMD, CHFB		246-083-002-022G	SWP-D-C	

**1.4 (55 kW | 1.4 Litre)**

04.05 -	BKR		246-082-008-025G	SWP-M-C	
04.05 -	BKR		246-083-002-022G	SWP-D-C	

**1.4 TDI (51 kW | 1.4 Litre)**

04.05 -	BNM		246-082-008-025G	SWP-M-C	
04.05 -	BNM		246-083-002-022G	SWP-D-C	

**GOLF I (17)****1.1 (37 kW | 1.1 Litre)**

04.74 - 12.77	FA, GG	→177 3207 177	246-075-021-006C	SWP-M-G	Plug Number (T2): 1
12.77 - 07.79	FA, GG	177 3207 178→	246-082-008-014C	SWP-M-C	Plug Number (T2): 1
08.78 - 07.83	FA, GG		246-086-001-007C	HLWP	Plug Number (T2): 3b; T26: X11-246-003-014

**1.1 (38 kW | 1.1 Litre)**

01.81 - 07.83	FJ		246-082-008-014C	SWP-M-C	Plug Number (T2): 1
01.81 - 07.83	FJ		246-086-001-007C	HLWP	Plug Number (T2): 3b; T26: X11-246-003-014



			<b>VDO</b>		
Date	Engine Code	Chassis No.	Article No.	Product	Information

**VW****GOLF I (17)**

<b>1.1 (44 kW   1.1 Litre)</b>					
01.81 → 07.83	HC		246-086-001-007C	HLWP	Plug Number (T2): 3b; T26: X11-246-003-014
<b>1.3 (44 kW   1.3 Litre)</b>					
08.79 → 07.83	GF		246-082-008-014C	SWP-M-C	Plug Number (T2): 1
08.79 → 07.83	GF		246-086-001-007C	HLWP	Plug Number (T2): 3b; T26: X11-246-003-014
<b>1.5 (51 kW   1.5 Litre)</b>					
08.77 → 12.77	JB	→177 3207 177	246-075-021-006C	SWP-M-G	Plug Number (T2): 1
04.74 → 12.75	FH		246-075-021-006C	SWP-M-G	Plug Number (T2): 1
12.77 → 07.83	JB	177 3207 178→	246-082-008-014C	SWP-M-C	Plug Number (T2): 1
08.78 → 07.83	JB		246-086-001-007C	HLWP	Plug Number (T2): 3b; T26: X11-246-003-014
<b>1.5 D (37 kW   1.5 Litre)</b>					
08.76 → 12.77	CK	→177 3207 177	246-075-021-006C	SWP-M-G	Plug Number (T2): 1
12.77 → 07.80	CK	177 3207 178→	246-082-008-014C	SWP-M-C	Plug Number (T2): 1
08.78 → 07.80	CK		246-086-001-007C	HLWP	Plug Number (T2): 3b; T26: X11-246-003-014
<b>1.6 (55 kW   1.6 Litre)</b>					
08.75 → 02.84	FP, FN, EM		246-075-021-006C	SWP-M-G	Plug Number (T2): 1
<b>1.6 D (40 kW   1.6 Litre)</b>					
08.80 → 07.83	CR, JK		246-082-008-014C	SWP-M-C	Plug Number (T2): 1
08.80 → 07.83	CR, JK		246-086-001-007C	HLWP	Plug Number (T2): 3b; T26: X11-246-003-014
<b>1.6 GTI (81 kW   1.6 Litre)</b>					
08.78 → 07.82	EG		246-082-008-014C	SWP-M-C	Plug Number (T2): 1
08.78 → 07.82	EG		246-086-001-007C	HLWP	Plug Number (T2): 3b; T26: X11-246-003-014
<b>1.6 TD (51 kW   1.6 Litre)</b>					
03.82 → 07.83	CY		246-082-008-014C	SWP-M-C	Plug Number (T2): 1
03.82 → 07.83	CY		246-086-001-007C	HLWP	Plug Number (T2): 3b; T26: X11-246-003-014
<b>1.8 GTI (82 kW   1.8 Litre)</b>					
08.82 → 07.83	DX, JJ		246-082-008-014C	SWP-M-C	Plug Number (T2): 1
08.82 → 09.83	DX, JJ		246-086-001-007C	HLWP	Plug Number (T2): 3b; T26: X11-246-003-014

**GOLF I Cabriolet (155)**

<b>1.5 (51 kW   1.5 Litre)</b>					
02.79 → 07.83	JB		246-082-008-014C	SWP-M-C	Plug Number (T2): 1
01.79 → 11.83	JB		246-086-001-007C	HLWP	Plug Number (T2): 3b; T24: GL →; T26: X11-246-003-014
<b>1.6 (53 kW   1.6 Litre)</b>					
08.87 → 02.90	RE	- J - 000 001→ →- P - 000 001	246-069-056-001Z	N	
08.89 → 02.90	RE	- L - 000 001→	246-080-010-002Z	N-H	
04.86 → 02.90	RE		246-082-008-014C	SWP-M-C	Plug Number (T2): 1
04.86 → 02.90	RE		246-086-001-007C	HLWP	Plug Number (T2): 3b; T24: GL →; T26: X11-246-003-014
<b>1.6 (55 kW   1.6 Litre)</b>					
08.87 → 04.92	EW, HN	- J - 000 001→ →- P - 000 001	246-069-056-001Z	N	
08.89 → 04.92	EW, HN	- L - 000 001→	246-080-010-002Z	N-H	
08.83 → 04.92	EW, HN		246-082-008-014C	SWP-M-C	Plug Number (T2): 1
08.83 → 04.92	EW, HN		246-086-001-007C	HLWP	Plug Number (T2): 3b; T24: GL →; T26: X11-246-003-014
<b>1.6 (81 kW   1.6 Litre)</b>					
08.79 → 07.82	EG		246-082-008-014C	SWP-M-C	Plug Number (T2): 1
08.79 → 07.82	EG		246-086-001-007C	HLWP	Plug Number (T2): 3b; T24: GL →; T26: X11-246-003-014
<b>1.8 (66 kW   1.8 Litre)</b>					
08.87 → 09.92	EX	- J - 000 001→ →- P - 000 001	246-069-056-001Z	N	
08.89 → 09.92	EX	- L - 000 001→	246-080-010-002Z	N-H	
08.83 → 09.92	EX		246-082-008-014C	SWP-M-C	Plug Number (T2): 1
08.83 → 09.92	EX		246-086-001-007C	HLWP	Plug Number (T2): 3b; T24: GL →; T26: X11-246-003-014
<b>1.8 (70 kW   1.8 Litre)</b>					
08.87 → 04.93	JH	- J - 000 001→ →- P - 000 001	246-069-056-001Z	N	
08.89 → 04.93	JH	- L - 000 001→	246-080-010-002Z	N-H	



			<b>VDO</b>		
Date	Engine Code	Chassis No.	Article No.	Product	Information

**VW****GOLF I Cabriolet (155)****1.8 (70 kW | 1.8 Litre)**

08.83 - 04.93	JH		246-082-008-014C	SWP-M-C	Plug Number (T2): 1
08.83 - 04.93	JH		246-086-001-007C	HLWP	Plug Number (T2): 3b; T24: GL →; T26: X11-246-003-014

**1.8 (72 kW | 1.8 Litre)**

08.89 - 03.93	2H	- J - 000 001→ -- P - 000 001	246-069-056-001Z	N	
08.89 - 03.93	2H	- L - 000 001→	246-080-010-002Z	N-H	
08.89 - 03.93	2H		246-082-008-014C	SWP-M-C	Plug Number (T2): 1
08.89 - 03.93	2H		246-086-001-007C	HLWP	Plug Number (T2): 3b; T24: GL →; T26: X11-246-003-014

**1.8 (82 kW | 1.8 Litre)**

08.87 - 12.89	DX, EV, PB	- J - 000 001→ -- P - 000 001	246-069-056-001Z	N	
08.89 - 12.89	DX, EV, PB	- L - 000 001→	246-080-010-002Z	N-H	
08.83 - 12.89	DX, EV, PB		246-082-008-014C	SWP-M-C	Plug Number (T2): 1
08.82 - 12.89	DX, EV, PB		246-086-001-007C	HLWP	Plug Number (T2): 3b; T24: GL →; T26: X11-246-003-014

**GOLF II (19E, 1G1)****1.0 (33 kW | 1.0 Litre)**

11.83 - 07.85	GN		246-082-008-014C	SWP-M-C	Plug Number (T2): 1
11.83 - 08.85	GN		246-086-001-007C	HLWP	Plug Number (T2): 3b; T24: C →; T26: X11-246-003-014

**1.0 (37 kW | 1.0 Litre)**

10.85 - 01.86	HZ	→G - 383 355	246-082-008-014C	SWP-M-C	Plug Number (T2): 1
01.86 - 07.88	HZ	G - 383 356→	246-083-002-014G	SWP-D-C	Plug Number (T2): 6
08.85 - 10.91	HZ		246-086-001-007C	HLWP	Plug Number (T2): 3b; T24: C →; T26: X11-246-003-014

**1.3 (37 kW | 1.3 Litre)**

08.86 - 12.87	NU		246-083-002-014G	SWP-D-C	Plug Number (T2): 6
08.85 - 12.87	NU		246-086-001-007C	HLWP	Plug Number (T2): 3b; T24: C →; T26: X11-246-003-014

**1.3 (40 kW | 1.3 Litre)**

08.83 - 01.86	HK, MH	→G - 383 355	246-082-008-014C	SWP-M-C	Plug Number (T2): 1
01.86 - 06.87	HK, MH	G - 383 356→	246-083-002-014G	SWP-D-C	Plug Number (T2): 6
08.83 - 06.87	HK, MH		246-086-001-007C	HLWP	Plug Number (T2): 3b; T24: C →; T26: X11-246-003-014

**1.3 (43 kW | 1.3 Litre)**

08.83 - 07.85	GT		246-082-008-014C	SWP-M-C	Plug Number (T2): 1
08.83 - 10.86	GT		246-086-001-007C	HLWP	Plug Number (T2): 3b; T24: C →; T26: X11-246-003-014

**1.3 CAT (40 kW | 1.3 Litre)**

01.89 - 10.91	MH, NZ, 2G		246-083-002-014G	SWP-D-C	Plug Number (T2): 6
06.86 - 12.92	MH, NZ, 2G		246-083-002-022G	SWP-D-C	
06.86 - 12.92	MH, NZ, 2G		246-086-001-007C	HLWP	Plug Number (T2): 3b; T24: C →; T26: X11-246-003-014

**1.6 (51 kW | 1.6 Litre)**

08.88 - 10.91	PN		246-083-002-014G	SWP-D-C	Plug Number (T2): 6
10.86 - 12.92	PN	19-E-300 001→	246-083-002-022G	SWP-D-C	
08.86 - 07.91	EZA, PN		246-083-002-022G	SWP-D-C	T26: X11-246-003-014
10.86 - 12.92	PN		246-086-001-007C	HLWP	Plug Number (T2): 3b; T24: C →; T26: X11-246-003-014

**1.6 (53 kW | 1.6 Litre)**

02.86 - 10.91	RF		246-083-002-014G	SWP-D-C	Plug Number (T2): 6
02.86 - 10.91	RF		246-083-002-022G	SWP-D-C	
02.86 - 10.91	RF		246-086-001-007C	HLWP	Plug Number (T2): 3b; T24: C →; T26: X11-246-003-014

**1.6 (55 kW | 1.6 Litre)**

08.83 - 01.86	EZ, HM, ABN	→G - 383 355	246-082-008-014C	SWP-M-C	Plug Number (T2): 1
01.86 - 10.91	EZ, HM, ABN	G - 383 356→	246-083-002-014G	SWP-D-C	Plug Number (T2): 6
08.83 - 07.92	EZ, HM, ABN		246-086-001-007C	HLWP	Plug Number (T2): 3b; T24: C →; T26: X11-246-003-014



			<b>VDO</b>		
Date	Engine Code	Chassis No.	Article No.	Product	Information

**VW****GOLF II (19E, 1G1)****1.6 D (37 kW | 1.6 Litre)**

08.83 → 10.91			246-086-001-007C	HLWP	Plug Number (T2): 3b; T24: C →; T26: X11-246-003-014
---------------	--	--	------------------	------	------------------------------------------------------

**1.6 D (40 kW | 1.6 Litre)**

08.83 → 01.86	JP, ME	→G - 383 355	246-082-008-014C	SWP-M-C	Plug Number (T2): 1
01.86 → 10.91	JP, ME	G - 383 356→	246-083-002-014G	SWP-D-C	Plug Number (T2): 6
08.83 → 10.91	JP, ME		246-086-001-007C	HLWP	Plug Number (T2): 3b; T24: C →; T26: X11-246-003-014

**1.6 TD (44 kW | 1.6 Litre)**

08.89 → 10.91	1V		246-083-002-014G	SWP-D-C	Plug Number (T2): 6
08.89 → 10.91	1V		246-083-002-022G	SWP-D-C	
08.89 → 10.91	1V		246-086-001-007C	HLWP	Plug Number (T2): 3b; T24: C →; T26: X11-246-003-014

**1.6 TD (51 kW | 1.6 Litre)**

08.83 → 01.86	JR, MF	→G - 383 355	246-082-008-014C	SWP-M-C	Plug Number (T2): 1
01.86 → 10.91	JR, MF	G - 383 356→	246-083-002-014G	SWP-D-C	Plug Number (T2): 6
08.83 → 10.91	JR, MF		246-086-001-007C	HLWP	Plug Number (T2): 3b; T24: C →; T26: X11-246-003-014

**1.6 TD (59 kW | 1.6 Litre)**

04.89 → 10.91	RA, SB		246-083-002-014G	SWP-D-C	Plug Number (T2): 6
04.89 → 10.91	RA, SB		246-083-002-022G	SWP-D-C	
04.89 → 10.91	RA, SB		246-086-001-007C	HLWP	Plug Number (T2): 3b; T24: C →; T26: X11-246-003-014

**1.8 (62 kW | 1.8 Litre)**

08.88 → 01.90	RH		246-083-002-014G	SWP-D-C	Plug Number (T2): 6
08.86 → 01.90	RH		246-083-002-022G	SWP-D-C	
08.86 → 01.90	RH		246-086-001-007C	HLWP	Plug Number (T2): 3b; T24: C →; T26: X11-246-003-014

**1.8 (66 kW | 1.8 Litre)**

08.84 → 01.86	GX, GU, HV	→G - 383 355	246-082-008-014C	SWP-M-C	Plug Number (T2): 1
01.86 → 10.91	GX, GU, HV	G - 383 356→	246-083-002-014G	SWP-D-C	Plug Number (T2): 6
08.84 → 10.91	GX, GU, HV		246-086-001-007C	HLWP	Plug Number (T2): 3b; T24: C →; T26: X11-246-003-014

**1.8 GTI (79 kW | 1.8 Litre)**

08.85 → 10.87	RD		246-086-001-007C	HLWP	Plug Number (T2): 3b; T24: C →; T26: X11-246-003-014
---------------	----	--	------------------	------	------------------------------------------------------

**1.8 GTI (82 kW | 1.8 Litre)**

01.84 → 01.86	EV, PB, GZ, DX	→G - 383 355	246-082-008-014C	SWP-M-C	Plug Number (T2): 1
01.86 → 10.91	EV, PB, GZ, DX	G - 383 356→	246-083-002-014G	SWP-D-C	Plug Number (T2): 6
08.83 → 10.91	EV, PB, GZ, DX		246-086-001-007C	HLWP	Plug Number (T2): 3b; T24: C →; T26: X11-246-003-014

**1.8 GTI 16V (102 kW | 1.8 Litre)**

02.86 → 06.90	KR		246-083-002-014G	SWP-D-C	Plug Number (T2): 6
02.86 → 06.90	KR		246-083-002-022G	SWP-D-C	
02.86 → 06.90	KR		246-086-001-007C	HLWP	Plug Number (T2): 3b; T24: C →; T26: X11-246-003-014

**1.8 GTI 16V (95 kW | 1.8 Litre)**

02.86 → 10.91	PL		246-083-002-014G	SWP-D-C	Plug Number (T2): 6
02.86 → 10.91	PL		246-083-002-022G	SWP-D-C	
02.86 → 10.91	PL		246-086-001-007C	HLWP	Plug Number (T2): 3b; T24: C →; T26: X11-246-003-014

**1.8 GTI CAT (79 kW | 1.8 Litre)**

01.87 → 10.91	PF		246-083-002-014G	SWP-D-C	Plug Number (T2): 6
01.87 → 10.91	PF		246-083-002-022G	SWP-D-C	
01.87 → 10.91	PF		246-086-001-007C	HLWP	Plug Number (T2): 3b; T24: C →; T26: X11-246-003-014

**1.8 GTI G60 (118 kW | 1.8 Litre)**

04.90 → 07.91	PG		246-083-002-014G	SWP-D-C	Plug Number (T2): 6
04.90 → 07.91	PG		246-086-001-007C	HLWP	Plug Number (T2): 3b; T24: C →; T26: X11-246-003-014

**1.8 GTI G60 Syncro (118 kW | 1.8 Litre)**

04.89 → 07.91	1H, PG		246-083-002-014G	SWP-D-C	Plug Number (T2): 6
08.88 → 07.91	1H, PG		246-083-002-022G	SWP-D-C	



			<b>VDO</b>		
Date	Engine Code	Chassis No.	Article No.	Product	Information

**VW****GOLF II (19E, 1G1)****1.8 GTI G60 Syncro (118 kW | 1.8 Litre)**

08.88 → 07.91	1H, PG		246-086-001-007C	HLWP	Plug Number (T2): 3b; T24: C →; T26: X11-246-003-014
---------------	--------	--	------------------	------	------------------------------------------------------

**1.8 i CAT (66 kW | 1.8 Litre)**

08.87 → 10.91	RP, GX	G - 383 356→	246-083-002-014G	SWP-D-C	Plug Number (T2): 6
08.87 → 10.91	RP, GX		246-083-002-022G	SWP-D-C	
08.87 → 10.91	RP, GX		246-086-001-007C	HLWP	Plug Number (T2): 3b; T24: C →; T26: X11-246-003-014

**1.8 i Syncro CAT (66 kW | 1.8 Litre)**

08.87 → 10.91	RP		246-083-002-022G	SWP-D-C	T26: X11-246-003-014
08.87 → 10.91	RP		246-086-001-007C	HLWP	Plug Number (T2): 3b; T24: C →; T26: X11-246-003-014

**1.8 Syncro (66 kW | 1.8 Litre)**

02.86 → 07.91	GX, GU		246-083-002-014G	SWP-D-C	Plug Number (T2): 6
02.86 → 07.91	GX, GU		246-083-002-022G	SWP-D-C	
02.86 → 07.91	GX, GU		246-086-001-007C	HLWP	Plug Number (T2): 3b; T24: C →; T26: X11-246-003-014

**1.8 Syncro (72 kW | 1.8 Litre)**

08.88 → 07.91	1P		246-083-002-022G	SWP-D-C	T26: X11-246-003-014
08.88 → 07.91	1P		246-086-001-007C	HLWP	Plug Number (T2): 3b; T24: C →; T26: X11-246-003-014

**GOLF III (1H1)****1.0 (37 kW | 1.0 Litre)**

10.94 → 09.96			246-083-002-022G	SWP-D-C	
---------------	--	--	------------------	---------	--

**1.4 (40 kW | 1.4 Litre)**

11.91 → 08.97	AEX, ABD		246-069-056-001Z	N	
11.91 → 08.97	AEX, ABD		246-080-010-002Z	N-H	T24: CL →
11.91 → 06.95	AEX, ABD		246-083-002-014G	SWP-D-C	Plug Number (T2): 6
11.91 → 08.97	AEX, ABD	1H-N-000 001→	246-083-002-022G	SWP-D-C	
11.91 → 06.95	AEX, ABD		246-086-001-002C	HLWP	Plug Number (T2): 3
11.91 → 08.97	AEX, ABD		246-086-001-007C	HLWP	Plug Number (T2): 3b; T24: CL →; T26: X11-246-003-014

**1.4 (44 kW | 1.4 Litre)**

10.91 → 08.97	ABD, AEX		246-069-056-001Z	N	
10.91 → 08.97	ABD, AEX		246-080-010-002Z	N-H	T24: CL →
07.94 → 08.97	ABD, AEX		246-083-002-014G	SWP-D-C	Plug Number (T2): 6
10.91 → 08.97	ABD, AEX	1H-N-000 001→	246-083-002-022G	SWP-D-C	
07.94 → 08.97	ABD, AEX		246-086-001-002C	HLWP	Plug Number (T2): 3
10.91 → 08.97	ABD, AEX		246-086-001-007C	HLWP	Plug Number (T2): 3b; T24: CL →; T26: X11-246-003-014

**1.6 (55 kW | 1.6 Litre)**

09.92 → 08.97	ABU, AEA, AEE		246-069-056-001Z	N	
09.92 → 08.97	ABU, AEA, AEE		246-080-010-002Z	N-H	T24: CL →
09.92 → 08.97	ABU, AEA, AEE		246-083-002-014G	SWP-D-C	Plug Number (T2): 6
09.92 → 08.97	AEA		246-083-002-022G	SWP-D-C	
09.92 → 08.97	ABU, AEA, AEE		246-086-001-002C	HLWP	Plug Number (T2): 3
09.92 → 08.97	ABU, AEA, AEE		246-086-001-007C	HLWP	Plug Number (T2): 3b; T24: CL →; T26: X11-246-003-014

**1.6 (74 kW | 1.6 Litre)**

07.95 → 08.97	AEK, AFT, AKS		246-069-056-001Z	N	
07.95 → 08.97	AEK, AFT, AKS		246-080-010-002Z	N-H	T24: CL →
07.95 → 08.97	AEK, AFT, AKS		246-083-002-014G	SWP-D-C	Plug Number (T2): 6
07.95 → 08.97	AEK, AFT, AKS	1H-N-000 001→	246-083-002-022G	SWP-D-C	
07.95 → 08.97	AEK, AFT, AKS		246-086-001-002C	HLWP	Plug Number (T2): 3
07.95 → 08.97	AEK, AFT, AKS		246-086-001-007C	HLWP	Plug Number (T2): 3b; T24: CL →; T26: X11-246-003-014

**1.8 (55 kW | 1.8 Litre)**

11.91 → 08.97	AAM		246-069-056-001Z	N	
11.91 → 08.97	AAM		246-080-010-002Z	N-H	T24: CL →
11.91 → 08.97	AAM		246-083-002-014G	SWP-D-C	Plug Number (T2): 6
11.91 → 08.97	AAM	1H-N-000 001→	246-083-002-022G	SWP-D-C	
11.91 → 08.97	AAM		246-086-001-002C	HLWP	Plug Number (T2): 3





			<b>VDO</b>		
Date	Engine Code	Chassis No.	Article No.	Product	Information

**VW****GOLF III (1H1)****1.8 (55 kW | 1.8 Litre)**

11.91 → 08.97	AAM		246-086-001-007C	HLWP	Plug Number (T2): 3b; T24: CL →; T26: X11-246-003-014
---------------	-----	--	------------------	------	-------------------------------------------------------

**1.8 (66 kW | 1.8 Litre)**

11.91 → 08.97	ABS, ADZ, ACC		246-069-056-001Z	N	
11.91 → 08.97	ABS, ADZ, ACC		246-080-010-002Z	N-H	T24: CL →
11.91 → 08.97	ABS, ADZ, ACC		246-083-002-014G	SWP-D-C	Plug Number (T2): 6
11.91 → 08.97	ABS, ADZ, ACC	1H-N-000 001→	246-083-002-022G	SWP-D-C	
11.91 → 08.97	ABS, ADZ, ACC		246-086-001-002C	HLWP	Plug Number (T2): 3
11.91 → 08.97	ABS, ADZ, ACC		246-086-001-007C	HLWP	Plug Number (T2): 3b; T24: CL →; T26: X11-246-003-014

**1.8 Syncro (1HX1) (66 kW | 1.8 Litre)**

01.93 → 08.97	ABS, ADZ		246-069-056-001Z	N	
01.93 → 08.97	ABS, ADZ		246-080-010-002Z	N-H	T24: CL →
01.93 → 08.97	ABS, ADZ		246-083-002-014G	SWP-D-C	Plug Number (T2): 6
01.93 → 08.97	ABS, ADZ	1H-N-000 001→	246-083-002-022G	SWP-D-C	
01.93 → 08.97	ABS, ADZ		246-086-001-002C	HLWP	Plug Number (T2): 3
01.93 → 08.97	ABS, ADZ		246-086-001-007C	HLWP	Plug Number (T2): 3b; T24: CL →; T26: X11-246-003-014

**1.9 D (48 kW | 1.9 Litre)**

11.91 → 08.97	1Y		246-069-056-001Z	N	
11.91 → 08.97	1Y		246-080-010-002Z	N-H	T24: CL →
11.91 → 08.97	1Y		246-083-002-014G	SWP-D-C	Plug Number (T2): 6
11.91 → 08.97	1Y		246-083-002-022G	SWP-D-C	
11.91 → 08.97	1Y		246-086-001-002C	HLWP	Plug Number (T2): 3
11.91 → 08.97	1Y		246-086-001-007C	HLWP	Plug Number (T2): 3b; T24: CL →; T26: X11-246-003-014

**1.9 SDI (47 kW | 1.9 Litre)**

07.95 → 08.97	AEY		246-069-056-001Z	N	
07.95 → 08.97	AEY		246-080-010-002Z	N-H	T24: CL →
07.95 → 08.97	AEY		246-083-002-014G	SWP-D-C	Plug Number (T2): 6
07.95 → 08.97	AEY		246-083-002-022G	SWP-D-C	
07.95 → 08.97	AEY		246-086-001-002C	HLWP	Plug Number (T2): 3
07.95 → 08.97	AEY		246-086-001-007C	HLWP	Plug Number (T2): 3b; T24: CL →; T26: X11-246-003-014

**1.9 TD,GTD (55 kW | 1.9 Litre)**

11.91 → 08.97	AAZ		246-069-056-001Z	N	
11.91 → 08.97	AAZ		246-080-010-002Z	N-H	T24: CL →
11.91 → 08.97	AAZ		246-083-002-014G	SWP-D-C	Plug Number (T2): 6
11.91 → 08.97	AAZ		246-083-002-022G	SWP-D-C	
11.91 → 08.97	AAZ		246-086-001-002C	HLWP	Plug Number (T2): 3
11.91 → 08.97	AAZ		246-086-001-007C	HLWP	Plug Number (T2): 3b; T24: CL →; T26: X11-246-003-014

**1.9 TDI (66 kW | 1.9 Litre)**

09.93 → 08.97	1Z, AHU, ALE		246-069-056-001Z	N	
09.93 → 08.97	1Z, AHU, ALE		246-080-010-002Z	N-H	T24: CL →
09.93 → 08.97	1Z, AHU, ALE		246-083-002-014G	SWP-D-C	Plug Number (T2): 6
09.93 → 08.97	1Z, AHU, ALE		246-083-002-022G	SWP-D-C	
09.93 → 08.97	1Z, AHU, ALE		246-086-001-002C	HLWP	Plug Number (T2): 3
09.93 → 08.97	1Z, AHU, ALE		246-086-001-007C	HLWP	Plug Number (T2): 3b; T24: CL →; T26: X11-246-003-014

**1.9 TDI (81 kW | 1.9 Litre)**

04.96 → 08.97	AFN		246-069-056-001Z	N	
04.96 → 08.97	AFN		246-080-010-002Z	N-H	T24: CL →
04.96 → 08.97	AFN		246-083-002-014G	SWP-D-C	Plug Number (T2): 6
04.96 → 08.97	AFN		246-083-002-022G	SWP-D-C	
04.96 → 08.97	AFN		246-086-001-002C	HLWP	Plug Number (T2): 3
04.96 → 08.97	AFN		246-086-001-007C	HLWP	Plug Number (T2): 3b; T24: CL →; T26: X11-246-003-014

**1.9 TDI Syncro (1HX1) (66 kW | 1.9 Litre)**

08.95 → 08.97	1Z, AHU, ALE		246-069-056-001Z	N	
08.95 → 08.97	1Z, AHU, ALE		246-080-010-002Z	N-H	T24: CL →
05.96 → 08.97	1Z, AHU, ALE		246-083-002-014G	SWP-D-C	Plug Number (T2): 6



			<b>VDO</b>		
Date	Engine Code	Chassis No.	Article No.	Product	Information

**VW****GOLF III (1H1)****1.9 TDI Syncro (1HX1) (66 kW | 1.9 Litre)**

08.95 - 08.97	1Z, AHU, ALE		246-083-002-022G	SWP-D-C	
05.96 - 08.97	1Z, AHU, ALE		246-086-001-002C	HLWP	Plug Number (T2): 3
08.95 - 08.97	1Z, AHU, ALE		246-086-001-007C	HLWP	Plug Number (T2): 3b; T24: CL →; T26: X11-246-003-014

**2.0 (85 kW | 2.0 Litre)**

11.91 - 08.97	2E, ABA, ADY, AGG, AKR		246-069-056-001Z	N	
11.91 - 08.97	2E, ABA, ADY, AGG, AKR		246-080-010-002Z	N-H	T24: CL →
11.91 - 08.97	2E, ABA, ADY, AGG, AKR		246-083-002-014G	SWP-D-C	Plug Number (T2): 6
11.91 - 08.97	2E, ABA, ADY, AGG, AKR	1H-N-000 001→	246-083-002-022G	SWP-D-C	
11.91 - 08.97	2E, ABA, ADY, AGG, AKR		246-086-001-002C	HLWP	Plug Number (T2): 3
11.91 - 08.97	2E, ABA, ADY, AGG, AKR		246-086-001-007C	HLWP	Plug Number (T2): 3b; T24: CL →; T26: X11-246-003-014

**2.0 GTI 16V (110 kW | 2.0 Litre)**

08.92 - 08.97	ABF		246-069-056-001Z	N	
08.92 - 08.97	ABF		246-080-010-002Z	N-H	T24: CL →
08.92 - 08.97	ABF		246-083-002-014G	SWP-D-C	Plug Number (T2): 6
08.92 - 08.97	ABF	1H-N-000 001→	246-083-002-022G	SWP-D-C	
08.92 - 08.97	ABF		246-086-001-002C	HLWP	Plug Number (T2): 3
08.92 - 08.97	ABF		246-086-001-007C	HLWP	Plug Number (T2): 3b; T24: CL →; T26: X11-246-003-014

**2.0 Syncro (1HX1) (85 kW | 2.0 Litre)**

08.95 - 08.97	AGG		246-069-056-001Z	N	
08.95 - 08.97	AGG		246-080-010-002Z	N-H	T24: CL →
08.95 - 08.97	AGG		246-083-002-014G	SWP-D-C	Plug Number (T2): 6
08.95 - 08.97	AGG	1H-N-000 001→	246-083-002-022G	SWP-D-C	
08.95 - 08.97	AGG		246-086-001-002C	HLWP	Plug Number (T2): 3
08.95 - 08.97	AGG		246-086-001-007C	HLWP	Plug Number (T2): 3b; T24: CL →; T26: X11-246-003-014

**2.8 VR6 (128 kW | 2.8 Litre)**

01.92 - 08.97	AAA		246-069-056-001Z	N	
01.92 - 08.97	AAA		246-080-010-002Z	N-H	T24: CL →
01.92 - 08.97	AAA		246-083-002-014G	SWP-D-C	Plug Number (T2): 6
01.92 - 08.97	AAA	1H-N-000 001→	246-083-002-022G	SWP-D-C	
01.92 - 08.97	AAA		246-086-001-002C	HLWP	Plug Number (T2): 3
01.92 - 08.97	AAA		246-086-001-007C	HLWP	Plug Number (T2): 3b; T24: CL →; T26: X11-246-003-014

**2.9 VR6 Syncro (1HX1) (140 kW | 2.9 Litre)**

10.94 - 08.97	ABV		246-069-056-001Z	N	
10.94 - 08.97	ABV		246-080-010-002Z	N-H	T24: CL →
10.94 - 08.97	ABV		246-083-002-014G	SWP-D-C	Plug Number (T2): 6
10.94 - 08.97	ABV	1H-N-000 001→	246-083-002-022G	SWP-D-C	
10.94 - 08.97	ABV		246-086-001-002C	HLWP	Plug Number (T2): 3
10.94 - 08.97	ABV		246-086-001-007C	HLWP	Plug Number (T2): 3b; T24: CL →; T26: X11-246-003-014

**Citystromer (20 kW | 0.0 Litre)**

11.94 - 08.97			246-069-056-001Z	N	
11.94 - 08.97			246-080-010-002Z	N-H	T24: CL →
11.94 - 08.97			246-083-002-022G	SWP-D-C	
11.94 - 08.97			246-086-001-007C	HLWP	Plug Number (T2): 3b; T24: CL →; T26: X11-246-003-014

**GOLF III Variant (1H5)****1.4 (40 kW | 1.4 Litre)**

07.93 - 04.99	ABD		246-069-056-001Z	N	
07.93 - 04.99	ABD		246-080-010-002Z	N-H	T24: CL →
09.93 - 06.95	ABD		246-083-002-014G	SWP-D-C	Plug Number (T2): 6
07.93 - 04.99	ABD		246-083-002-022G	SWP-D-C	
07.93 - 04.99	ABD		246-086-001-007C	HLWP	Plug Number (T2): 3b; T24: CL →; T26: X11-246-003-014

**1.4 (44 kW | 1.4 Litre)**

07.93 - 04.99	ABD, AEX, APQ		246-069-056-001Z	N	
07.93 - 04.99	ABD, AEX, APQ		246-080-010-002Z	N-H	T24: CL →



			<b>VDO</b>		
Date	Engine Code	Chassis No.	Article No.	Product	Information

**VW****GOLF III Variant (1H5)****1.4 (44 kW | 1.4 Litre)**

07.93 - 04.99	ABD, AEX, APQ		246-083-002-022G	SWP-D-C	
07.93 - 04.99	ABD, AEX, APQ		246-086-001-007C	HLWP	Plug Number (T2): 3b; T24: CL →; T26: X11-246-003-014

**1.6 (55 kW | 1.6 Litre)**

07.93 - 12.97	ABU, AEA, AEE		246-082-008-021G	SWP-M-C	Plug Number (T2): 6
07.93 - 12.97	ABU, AEA, AEE		246-083-002-022G	SWP-D-C	
07.93 - 12.97	ABU, AEA, AEE		246-086-001-007C	HLWP	Plug Number (T2): 3b

**1.6 (74 kW | 1.6 Litre)**

07.94 - 04.99	AEK, AFT, AKS		246-069-056-001Z	N	
07.94 - 04.99	AEK, AFT, AKS		246-080-010-002Z	N-H	T24: CL →
10.94 - 12.95	AEK, AFT, AKS		246-083-002-014G	SWP-D-C	Plug Number (T2): 6
07.94 - 04.99	AEK, AFT, AKS		246-083-002-022G	SWP-D-C	
07.94 - 04.99	AEK, AFT, AKS		246-086-001-007C	HLWP	Plug Number (T2): 3b; T24: CL →; T26: X11-246-003-014

**1.8 (55 kW | 1.8 Litre)**

07.93 - 04.99	AAM, ANN		246-069-056-001Z	N	
07.93 - 04.99	AAM, ANN		246-080-010-002Z	N-H	T24: CL →
09.93 - 04.99	AAM, ANN		246-083-002-014G	SWP-D-C	Plug Number (T2): 6
07.93 - 04.99	AAM, ANN		246-083-002-022G	SWP-D-C	
07.93 - 04.99	AAM, ANN		246-086-001-007C	HLWP	Plug Number (T2): 3b; T24: CL →; T26: X11-246-003-014

**1.8 (66 kW | 1.8 Litre)**

07.93 - 04.99	ABS, ADZ, ANP		246-069-056-001Z	N	
07.93 - 04.99	ABS, ADZ, ANP		246-080-010-002Z	N-H	T24: CL →
09.93 - 04.99	ABS, ADZ, ANP		246-083-002-014G	SWP-D-C	Plug Number (T2): 6
07.93 - 04.99	ABS, ADZ, ANP		246-083-002-022G	SWP-D-C	
07.93 - 04.99	ABS, ADZ, ANP		246-086-001-007C	HLWP	Plug Number (T2): 3b; T24: CL →; T26: X11-246-003-014

**1.8 Syncro (66 kW | 1.8 Litre)**

10.94 - 04.99	ADZ		246-069-056-001Z	N	
10.94 - 04.99	ADZ		246-080-010-002Z	N-H	T24: CL →
10.94 - 04.99	ADZ		246-083-002-014G	SWP-D-C	Plug Number (T2): 6
10.94 - 04.99	ADZ		246-083-002-022G	SWP-D-C	
10.94 - 04.99	ADZ		246-086-001-002C	HLWP	Plug Number (T2): 3
10.94 - 04.99	ADZ		246-086-001-007C	HLWP	Plug Number (T2): 3b; T24: CL →; T26: X11-246-003-014

**1.9 D (48 kW | 1.9 Litre)**

07.93 - 04.99	1Y		246-069-056-001Z	N	
07.93 - 04.99	1Y		246-080-010-002Z	N-H	T24: CL →
09.93 - 04.96	1Y		246-083-002-014G	SWP-D-C	Plug Number (T2): 6
07.93 - 04.99	1Y		246-083-002-022G	SWP-D-C	
07.93 - 04.99	1Y		246-086-001-007C	HLWP	Plug Number (T2): 3b; T24: CL →; T26: X11-246-003-014

**1.9 SDI (47 kW | 1.9 Litre)**

07.95 - 04.99	AEY		246-069-056-001Z	N	
07.95 - 04.99	AEY		246-080-010-002Z	N-H	T24: CL →
07.95 - 04.99	AEY		246-086-001-007C	HLWP	Plug Number (T2): 3b; T24: CL →; T26: X11-246-003-014

**1.9 TD (55 kW | 1.9 Litre)**

07.93 - 04.99	AAZ		246-069-056-001Z	N	
07.93 - 04.99	AAZ		246-080-010-002Z	N-H	T24: CL →
09.93 - 04.99	AAZ		246-083-002-014G	SWP-D-C	Plug Number (T2): 6
07.93 - 04.99	AAZ		246-083-002-022G	SWP-D-C	
07.93 - 04.99	AAZ		246-086-001-007C	HLWP	Plug Number (T2): 3b; T24: CL →; T26: X11-246-003-014

**1.9 TDI (66 kW | 1.9 Litre)**

03.94 - 04.99	1Z, AHU, ALE		246-069-056-001Z	N	
03.94 - 04.99	1Z, AHU, ALE		246-080-010-002Z	N-H	T24: CL →
03.94 - 07.96	1Z, AHU, ALE		246-083-002-014G	SWP-D-C	Plug Number (T2): 6
03.94 - 04.99	1Z, AHU, ALE		246-083-002-022G	SWP-D-C	
03.94 - 04.99	1Z, AHU, ALE		246-086-001-007C	HLWP	Plug Number (T2): 3b; T24: CL →; T26: X11-246-003-014



			<b>VDO</b>		
Date	Engine Code	Chassis No.	Article No.	Product	Information

**VW****GOLF III Variant (1H5)****1.9 TDI (81 kW | 1.9 Litre)**

04.96 - 04.99	AFN		246-069-056-001Z	N	
04.96 - 04.99	AFN		246-080-010-002Z	N-H	T24: CL →
04.96 - 04.99	AFN		246-083-002-022G	SWP-D-C	
04.96 - 04.99	AFN		246-086-001-007C	HLWP	Plug Number (T2): 3b; T24: CL →; T26: X11-246-003-014

**1.9 TDI Syncro (66 kW | 1.9 Litre)**

07.95 - 04.99	1Z, AHU, ALE		246-069-056-001Z	N	
07.95 - 04.99	1Z, AHU, ALE		246-080-010-002Z	N-H	T24: CL →
07.95 - 07.96	1Z, AHU, ALE		246-083-002-014G	SWP-D-C	Plug Number (T2): 6
07.95 - 04.99	1Z, AHU, ALE		246-083-002-022G	SWP-D-C	
07.95 - 07.96	1Z, AHU, ALE		246-086-001-002C	HLWP	Plug Number (T2): 3
07.95 - 04.99	1Z, AHU, ALE		246-086-001-007C	HLWP	Plug Number (T2): 3b; T24: CL →; T26: X11-246-003-014

**2.0 (85 kW | 2.0 Litre)**

07.93 - 04.99	2E, ADY, AGG, AKR		246-069-056-001Z	N	
07.93 - 04.99	2E, ADY, AGG, AKR		246-080-010-002Z	N-H	T24: CL →
09.93 - 04.96	2E, ADY, AGG, AKR		246-083-002-014G	SWP-D-C	Plug Number (T2): 6
07.93 - 04.99	2E, ADY, AGG, AKR		246-086-001-007C	HLWP	Plug Number (T2): 3b; T24: CL →; T26: X11-246-003-014

**2.0 Syncro (85 kW | 2.0 Litre)**

08.95 - 04.99	AGG		246-069-056-001Z	N	
08.95 - 04.99	AGG		246-080-010-002Z	N-H	T24: CL →
08.95 - 04.99	AGG		246-086-001-007C	HLWP	Plug Number (T2): 3b; T24: CL →; T26: X11-246-003-014

**2.9 VR6 (140 kW | 2.9 Litre)**

10.94 - 04.99	ABV		246-069-056-001Z	N	
10.94 - 04.99	ABV		246-080-010-002Z	N-H	T24: CL →
07.95 - 04.99	ABV		246-083-002-014G	SWP-D-C	Plug Number (T2): 6
07.95 - 04.99	ABV		246-086-001-002C	HLWP	Plug Number (T2): 3
10.94 - 04.99	ABV		246-086-001-007C	HLWP	Plug Number (T2): 3b; T24: CL →; T26: X11-246-003-014

**2.9 VR6 Syncro (140 kW | 2.9 Litre)**

10.94 - 04.99	ABV		246-069-056-001Z	N	
10.94 - 04.99	ABV		246-080-010-002Z	N-H	T24: CL →
10.94 - 04.99	ABV		246-086-001-007C	HLWP	Plug Number (T2): 3b; T24: CL →; T26: X11-246-003-014

**GOLF III Cabriolet (1E7)****1.6 (74 kW | 1.6 Litre)**

10.94 - 05.98	AEK, AFT, AKS		246-069-056-001Z	N	
10.94 - 05.98	AEK, AFT, AKS		246-080-010-002Z	N-H	
10.94 - 12.97	AEK, AFT, AKS		246-082-008-021G	SWP-M-C	Plug Number (T2): 6
10.94 - 05.98	AEK, AFT, AKS		246-082-008-025G	SWP-M-C	
10.94 - 12.97	AEK, AFT, AKS		246-086-001-002C	HLWP	Plug Number (T2): 3
10.94 - 05.98	AEK, AFT, AKS		246-086-001-007C	HLWP	Plug Number (T2): 3b; T26: X11-246-003-014

**1.8 (55 kW | 1.8 Litre)**

07.93 - 05.98	AAM		246-069-056-001Z	N	
07.93 - 05.98	AAM		246-080-010-002Z	N-H	
09.93 - 12.97	AAM		246-082-008-021G	SWP-M-C	Plug Number (T2): 6
09.93 - 12.97	AAM		246-086-001-002C	HLWP	Plug Number (T2): 3
07.93 - 05.98	AAM		246-086-001-007C	HLWP	Plug Number (T2): 3b; T26: X11-246-003-014

**1.8 (66 kW | 1.8 Litre)**

07.93 - 05.98	ABS, ADZ		246-069-056-001Z	N	
07.93 - 05.98	ABS, ADZ		246-080-010-002Z	N-H	
09.93 - 12.97	ABS, ADZ		246-082-008-021G	SWP-M-C	Plug Number (T2): 6
09.93 - 12.97	ABS, ADZ		246-086-001-002C	HLWP	Plug Number (T2): 3
07.93 - 05.98	ABS, ADZ		246-086-001-007C	HLWP	Plug Number (T2): 3b; T26: X11-246-003-014

**1.9 TDI (66 kW | 1.9 Litre)**

08.95 - 05.98	1Z, AHU, ALE		246-069-056-001Z	N	
08.95 - 05.98	1Z, AHU, ALE		246-080-010-002Z	N-H	
08.95 - 12.97	1Z, AHU, ALE		246-082-008-021G	SWP-M-C	Plug Number (T2): 6
08.95 - 05.98	1Z, AHU, ALE		246-082-008-025G	SWP-M-C	



			<b>VDO</b>		
Date	Engine Code	Chassis No.	Article No.	Product	Information

**VW****GOLF III Cabriolet (1E7)****1.9 TDI (66 kW | 1.9 Litre)**

08.95 - 12.97	1Z, AHU, ALE		246-086-001-002C	HLWP	Plug Number (T2): 3
08.95 - 05.98	1Z, AHU, ALE		246-086-001-007C	HLWP	Plug Number (T2): 3b; T26: X11-246-003-014

**1.9 TDI (81 kW | 1.9 Litre)**

07.96 - 05.98	AFN		246-069-056-001Z	N	
07.96 - 05.98	AFN		246-080-010-002Z	N-H	
10.96 - 12.97	AFN		246-082-008-021G	SWP-M-C	Plug Number (T2): 6
10.96 - 12.97	AFN		246-086-001-002C	HLWP	Plug Number (T2): 3
07.96 - 05.98	AFN		246-086-001-007C	HLWP	Plug Number (T2): 3b; T26: X11-246-003-014

**2.0 (85 kW | 2.0 Litre)**

07.93 - 05.98	2E, ADY, AGG, AKR		246-069-056-001Z	N	
07.93 - 05.98	2E, ADY, AGG, AKR		246-080-010-002Z	N-H	
09.93 - 12.97	2E, ADY, AGG, AKR		246-082-008-021G	SWP-M-C	Plug Number (T2): 6
09.93 - 12.97	2E, ADY, AGG, AKR		246-086-001-002C	HLWP	Plug Number (T2): 3
07.93 - 05.98	2E, ADY, AGG, AKR		246-086-001-007C	HLWP	Plug Number (T2): 3b; T26: X11-246-003-014

**GOLF IV (1J1)****1.0 (51 kW | 1.0 Litre)**

08.97 - 05.02			246-083-002-022G	SWP-D-C	
---------------	--	--	------------------	---------	--

**1.0 Turbo (82 kW | 1.0 Litre)**

08.97 - 05.02			246-083-002-022G	SWP-D-C	
---------------	--	--	------------------	---------	--

**1.4 16V (55 kW | 1.4 Litre)**

10.97 - 06.05	AHW, AKQ, AXP, APE, BCA		246-083-002-022G	SWP-D-C	
10.97 - 06.05	AHW, AKQ, AXP, APE, BCA		246-086-001-002C	HLWP	Plug Number (T2): 3
08.97 - 06.05	AHW, AKQ, AXP, APE, BCA		246-086-001-007C	HLWP	Plug Number (T2): 3b; T26: X11-246-003-014

**1.6 (74 kW | 1.6 Litre)**

08.97 - 02.00	AEH, AKL, APF		246-083-002-022G	SWP-D-C	
02.01 - 06.01	BAH		246-083-002-022G	SWP-D-C	T26: X11-246-003-014
08.97 - 02.00	AEH, AKL, APF		246-086-001-007C	HLWP	Plug Number (T2): 3b; T26: X11-246-003-014

**1.6 (75 kW | 1.6 Litre)**

08.00 - 06.05	AVU, BFQ, BJH		246-083-002-022G	SWP-D-C	
08.00 - 06.05	AVU, BFQ, BJH		246-086-001-002C	HLWP	Plug Number (T2): 3
08.00 - 06.05	AVU, BFQ, BJH		246-086-001-007C	HLWP	Plug Number (T2): 3b; T26: X11-246-003-014

**1.6 (78 kW | 1.6 Litre)**

08.03 - 06.05	AWB		246-082-008-025G	SWP-M-C	
08.03 - 06.05	AWB		246-083-002-022G	SWP-D-C	

**1.6 16V (77 kW | 1.6 Litre)**

02.00 - 06.05	ATN, AUS, AZD, BCB		246-083-002-022G	SWP-D-C	
02.00 - 06.05	ATN, AUS, AZD, BCB		246-086-001-007C	HLWP	Plug Number (T2): 3b; T26: X11-246-003-014

**1.6 FSI (81 kW | 1.6 Litre)**

01.02 - 06.05	BAD		246-082-008-025G	SWP-M-C	
01.02 - 06.05	BAD		246-083-002-022G	SWP-D-C	
01.02 - 06.05	BAD		246-086-001-007C	HLWP	Plug Number (T2): 3b; T26: X11-246-003-014

**1.8 (92 kW | 1.8 Litre)**

10.97 - 06.05	AGN, BAF		246-083-002-022G	SWP-D-C	
10.97 - 05.99	AGN, BAF		246-086-001-002C	HLWP	Plug Number (T2): 3
08.97 - 06.05	AGN, BAF		246-086-001-007C	HLWP	Plug Number (T2): 3b; T26: X11-246-003-014

**1.8 4motion (92 kW | 1.8 Litre)**

05.98 - 05.99	AGN		246-086-001-002C	HLWP	Plug Number (T2): 3
05.98 - 06.05	AGN		246-086-001-007C	HLWP	Plug Number (T2): 3b; T26: X11-246-003-014

**1.8 T (110 kW | 1.8 Litre)**

05.99 - 06.05	AGU, AUM, ARZ, AWD, AQA		246-083-002-022G	SWP-D-C	
10.97 - 05.99	AGU, AUM, ARZ, AWD, AQA		246-086-001-002C	HLWP	Plug Number (T2): 3
08.97 - 06.05	AGU, AUM, ARZ, AWD, AQA		246-086-001-007C	HLWP	Plug Number (T2): 3b; T26: X11-246-003-014

**1.8 T GTI (132 kW | 1.8 Litre)**

08.01 - 06.05	AUQ		246-083-002-022G	SWP-D-C	
08.01 - 06.05	AUQ		246-086-001-007C	HLWP	Plug Number (T2): 3b; T26: X11-246-003-014

**1.9 SDI (50 kW | 1.9 Litre)**

08.97 - 06.05	AGP, AQM	1J-W-000 001 →	246-083-002-022G	SWP-D-C	
10.97 - 06.05	AGP, AQM		246-086-001-002C	HLWP	Plug Number (T2): 3
08.97 - 06.05	AGP, AQM		246-086-001-007C	HLWP	Plug Number (T2): 3b; T26: X11-246-003-014

**1.9 TDI (110 kW | 1.9 Litre)**

05.00 - 06.05	ARL		246-083-002-022G	SWP-D-C	
---------------	-----	--	------------------	---------	--



			<b>VDO</b>		
Date	Engine Code	Chassis No.	Article No.	Product	Information

**VW****GOLF IV (1J1)**

<b>1.9 TDI (110 kW   1.9 Litre)</b>					
05.00 - 06.05	ARL		246-086-001-007C	HLWP	Plug Number (T2): 3b; T26: X11-246-003-014
<b>1.9 TDI (66 kW   1.9 Litre)</b>					
10.97 - 05.04	AGR, ALH	1J-W-000 001→	246-083-002-022G	SWP-D-C	
10.97 - 05.04	AGR, ALH		246-086-001-007C	HLWP	Plug Number (T2): 3b; T26: X11-246-003-014
<b>1.9 TDI (74 kW   1.9 Litre)</b>					
09.00 - 06.05	ATD, AXR		246-083-002-022G	SWP-D-C	
09.00 - 06.05	ATD, AXR		246-086-001-007C	HLWP	Plug Number (T2): 3b; T26: X11-246-003-014
<b>1.9 TDI (81 kW   1.9 Litre)</b>					
08.97 - 05.04	AHF, ASV	1J-W-000 001→	246-083-002-022G	SWP-D-C	
08.97 - 05.04	AHF, ASV		246-086-001-007C	HLWP	Plug Number (T2): 3b; T26: X11-246-003-014
<b>1.9 TDI (85 kW   1.9 Litre)</b>					
12.98 - 06.01	AJM		246-083-002-022G	SWP-D-C	
12.98 - 06.01	AJM, AUJ		246-086-001-002C	HLWP	Plug Number (T2): 3
12.98 - 06.01	AJM, AUJ		246-086-001-007C	HLWP	Plug Number (T2): 3b; T26: X11-246-003-014
<b>1.9 TDI (96 kW   1.9 Litre)</b>					
11.00 - 06.05	ASZ		246-083-002-022G	SWP-D-C	
11.00 - 06.05	ASZ		246-086-001-007C	HLWP	Plug Number (T2): 3b; T26: X11-246-003-014
<b>1.9 TDI 4motion (110 kW   1.9 Litre)</b>					
02.00 - 06.05	ARL		246-083-002-022G	SWP-D-C	
02.00 - 06.05	ARL		246-086-001-007C	HLWP	Plug Number (T2): 3b; T26: X11-246-003-014
<b>1.9 TDI 4motion (66 kW   1.9 Litre)</b>					
07.98 - 04.02	AGR, ALH	1J-W-000 001→	246-083-002-022G	SWP-D-C	
07.98 - 05.99	AGR, ALH		246-086-001-002C	HLWP	Plug Number (T2): 3
07.98 - 04.02	AGR, ALH		246-086-001-007C	HLWP	Plug Number (T2): 3b; T26: X11-246-003-014
<b>1.9 TDI 4motion (74 kW   1.9 Litre)</b>					
09.00 - 06.05	ATD	→1J-1-300 001	246-083-002-022G	SWP-D-C	
09.00 - 06.05	ATD		246-086-001-007C	HLWP	Plug Number (T2): 3b; T26: X11-246-003-014
<b>1.9 TDI 4motion (85 kW   1.9 Litre)</b>					
09.99 - 06.01	AJM, AUJ	→1J-1-300 001	246-083-002-022G	SWP-D-C	
09.99 - 06.01	AJM, AUJ		246-086-001-007C	HLWP	Plug Number (T2): 3b; T26: X11-246-003-014
<b>1.9 TDI 4motion (96 kW   1.9 Litre)</b>					
11.00 - 06.05	ASZ		246-083-002-022G	SWP-D-C	
11.00 - 06.05	ASZ		246-086-001-007C	HLWP	Plug Number (T2): 3b; T26: X11-246-003-014
<b>2.0 (85 kW   2.0 Litre)</b>					
08.98 - 05.04	APK, AQY, AZJ, AZG		246-083-002-022G	SWP-D-C	
08.98 - 05.04	APK, AQY, AZJ, AZG		246-086-001-002C	HLWP	Plug Number (T2): 3
07.98 - 05.04	APK, AQY, AZJ, AZG		246-086-001-007C	HLWP	Plug Number (T2): 3b; T26: X11-246-003-014
<b>2.0 4motion (85 kW   2.0 Litre)</b>					
10.00 - 06.05	AZH, AZJ		246-083-002-022G	SWP-D-C	
10.00 - 06.05	AZH, AZJ		246-086-001-007C	HLWP	Plug Number (T2): 3b; T26: X11-246-003-014
<b>2.3 V5 (110 kW   2.3 Litre)</b>					
08.97 - 10.00	AGZ		246-083-002-022G	SWP-D-C	
08.97 - 10.00	AGZ		246-086-001-007C	HLWP	Plug Number (T2): 3b; T26: X11-246-003-014
<b>2.3 V5 (125 kW   2.3 Litre)</b>					
10.00 - 06.05	AQN		246-083-002-022G	SWP-D-C	
10.00 - 06.05	AQN		246-086-001-007C	HLWP	Plug Number (T2): 3b; T26: X11-246-003-014
<b>2.3 V5 4motion (110 kW   2.3 Litre)</b>					
12.98 - 05.99	AGZ		246-083-002-022G	SWP-D-C	
12.98 - 05.99	AGZ		246-086-001-002C	HLWP	Plug Number (T2): 3
12.98 - 10.00	AGZ		246-086-001-007C	HLWP	Plug Number (T2): 3b; T26: X11-246-003-014
<b>2.3 V5 4motion (125 kW   2.3 Litre)</b>					
10.00 - 06.05	AQN		246-083-002-022G	SWP-D-C	
10.00 - 06.05	AQN		246-086-001-007C	HLWP	Plug Number (T2): 3b; T26: X11-246-003-014
<b>2.8 (128 kW   2.8 Litre)</b>					
08.97 - 09.99	AAA		246-083-002-022G	SWP-D-C	
<b>2.8 V6 4motion (150 kW   2.8 Litre)</b>					
03.99 - 06.05	AQP, AUE, BDE		246-083-002-022G	SWP-D-C	
03.99 - 06.05	AQP, AUE, BDE		246-086-001-007C	HLWP	Plug Number (T2): 3b; T26: X11-246-003-014
<b>2.8 VR6 (130 kW   2.8 Litre)</b>					
10.00 - 07.02			246-083-002-022G	SWP-D-C	T26: X11-246-003-014
<b>2.8 VR6 (147 kW   2.8 Litre)</b>					
03.02 - 10.05	BDF		246-082-008-025G	SWP-M-C	T26: 1J0 955 665 H



					
Date	Engine Code	Chassis No.	Article No.	Product	Information

**VW****GOLF IV (1J1)****2.8 VR6 (147 kW | 2.8 Litre)**

03.02 - 10.05	BDF		246-083-002-022G	SWP-D-C	T26: 1J0 955 665 H
---------------	-----	--	------------------	---------	--------------------

**3.2 R32 4motion (177 kW | 3.2 Litre)**

09.02 - 06.05	BFH		246-082-008-025G	SWP-M-C	
09.02 - 06.05	BFH		246-083-002-022G	SWP-D-C	
09.02 - 06.05	BFH, BML		246-086-001-007C	HLWP	Plug Number (T2): 3b

**GOLF IV Variant (1J5)****1.4 16V (55 kW | 1.4 Litre)**

05.99 - 06.06	AHW, AKQ, AXP, APE, BCA		246-082-008-021G	SWP-M-C	Plug Number (T2): 6
05.99 - 06.06	AHW, AKQ, AXP, APE, BCA		246-083-002-022G	SWP-D-C	
05.99 - 06.06	AHW, AKQ, AXP, APE, BCA		246-086-001-007C	HLWP	Plug Number (T2): 3b

**1.6 (74 kW | 1.6 Litre)**

05.99 - 02.00	AEH, AKL, APF		246-082-008-021G	SWP-M-C	Plug Number (T2): 6
05.99 - 02.00	AEH, AKL, APF		246-083-002-022G	SWP-D-C	
05.99 - 02.00	AEH, AKL, APF		246-086-001-007C	HLWP	Plug Number (T2): 3b

**1.6 (75 kW | 1.6 Litre)**

08.00 - 06.06	AVU, BFQ		246-083-002-022G	SWP-D-C	
08.00 - 06.06	AVU, BFQ		246-086-001-002C	HLWP	Plug Number (T2): 3

**1.6 16V (77 kW | 1.6 Litre)**

02.00 - 06.06	AZD, AUS, ATN, BCB		246-082-008-021G	SWP-M-C	Plug Number (T2): 6
02.00 - 06.06	AZD, AUS, ATN, BCB		246-083-002-022G	SWP-D-C	
02.00 - 06.06	AZD, AUS, ATN, BCB		246-086-001-007C	HLWP	Plug Number (T2): 3b

**1.6 FSi (81 kW | 1.6 Litre)**

01.02 - 06.06	BAD		246-082-008-021G	SWP-M-C	Plug Number (T2): 6
01.02 - 06.06	BAD		246-083-002-022G	SWP-D-C	
01.02 - 06.06	BAD		246-086-001-007C	HLWP	Plug Number (T2): 3b

**1.6 FSi (85 kW | 1.6 Litre)**

10.03 - 07.04	BAG		246-086-001-007C	HLWP	Plug Number (T2): 3b
---------------	-----	--	------------------	------	----------------------

**1.8 4motion (92 kW | 1.8 Litre)**

05.99 - 06.06	AGN		246-083-002-022G	SWP-D-C	
05.99 - 06.06	AGN		246-086-001-002C	HLWP	Plug Number (T2): 3

**1.8 T (110 kW | 1.8 Litre)**

05.00 - 06.06	AGU, AUM, AWD, AQA, ARZ		246-082-008-021G	SWP-M-C	Plug Number (T2): 6
05.00 - 06.06	AGU, AUM, AWD, AQA, ARZ		246-083-002-022G	SWP-D-C	
05.00 - 06.06	AGU, AUM, AWD, AQA, ARZ		246-086-001-007C	HLWP	Plug Number (T2): 3b

**1.9 SDI (50 kW | 1.9 Litre)**

05.99 - 06.06	AGP, AQM		246-082-008-021G	SWP-M-C	Plug Number (T2): 6
05.99 - 06.06	AGP, AQM	1J-W-000 001→	246-083-002-022G	SWP-D-C	
05.99 - 06.06	AGP, AQM		246-086-001-007C	HLWP	Plug Number (T2): 3b

**1.9 TDI (66 kW | 1.9 Litre)**

05.99 - 05.06	AGR, ALH		246-082-008-021G	SWP-M-C	Plug Number (T2): 6
05.99 - 05.06	AGR, ALH	1J-W-000 001→	246-083-002-022G	SWP-D-C	
05.99 - 05.06	AGR, ALH		246-086-001-007C	HLWP	Plug Number (T2): 3b

**1.9 TDI (74 kW | 1.9 Litre)**

09.00 - 06.06	ATD, AXR		246-083-002-022G	SWP-D-C	
09.00 - 06.06	ATD, AXR		246-086-001-002C	HLWP	Plug Number (T2): 3

**1.9 TDI (81 kW | 1.9 Litre)**

05.99 - 06.01	AHF, ASV		246-082-008-021G	SWP-M-C	Plug Number (T2): 6
05.99 - 06.01	AHF, ASV	1J-W-000 001→	246-083-002-022G	SWP-D-C	
05.99 - 06.01	AHF, ASV		246-086-001-007C	HLWP	Plug Number (T2): 3b

**1.9 TDI (85 kW | 1.9 Litre)**

08.99 - 06.01	AJM, AUJ		246-082-008-021G	SWP-M-C	Plug Number (T2): 6
08.99 - 06.01	AJM, AUJ		246-083-002-022G	SWP-D-C	
08.99 - 06.01	AJM, AUJ		246-086-001-007C	HLWP	Plug Number (T2): 3b

**1.9 TDI (96 kW | 1.9 Litre)**

11.00 - 06.06	ASZ		246-082-008-021G	SWP-M-C	Plug Number (T2): 6
11.00 - 06.06	ASZ		246-083-002-022G	SWP-D-C	
11.00 - 06.06	ASZ		246-086-001-007C	HLWP	Plug Number (T2): 3b

**1.9 TDI 4motion (66 kW | 1.9 Litre)**

05.99 - 04.02	AGR, ALH		246-082-008-021G	SWP-M-C	Plug Number (T2): 6
05.99 - 04.02	AGR, ALH	1J-W-000 001→	246-083-002-022G	SWP-D-C	
05.99 - 04.02	AGR, ALH		246-086-001-007C	HLWP	Plug Number (T2): 3b



			<b>VDO</b>		
Date	Engine Code	Chassis No.	Article No.	Product	Information

**VW****GOLF IV Variant (1J5)****1.9 TDI 4motion (74 kW | 1.9 Litre)**

09.00 - 06.06	ATD		246-082-008-021G	SWP-M-C	Plug Number (T2): 6
09.00 - 06.06	ATD		246-083-002-022G	SWP-D-C	
09.00 - 06.06	ATD		246-086-001-007C	HLWP	Plug Number (T2): 3b

**1.9 TDI 4motion (85 kW | 1.9 Litre)**

05.99 - 06.01	AJM	-1J-1-300 001	246-083-002-022G	SWP-D-C	
09.99 - 06.01	AJM		246-086-001-002C	HLWP	Plug Number (T2): 3

**1.9 TDI 4motion (96 kW | 1.9 Litre)**

11.00 - 06.06	ASZ		246-082-008-021G	SWP-M-C	Plug Number (T2): 6
11.00 - 06.06	ASZ		246-083-002-022G	SWP-D-C	
11.00 - 06.06	ASZ		246-086-001-007C	HLWP	Plug Number (T2): 3b

**2.0 (85 kW | 2.0 Litre)**

05.99 - 06.06	APK, AQY, AZJ		246-082-008-021G	SWP-M-C	Plug Number (T2): 6
05.99 - 06.06	APK, AQY, AZJ		246-083-002-022G	SWP-D-C	
05.99 - 06.06	APK, AQY, AZJ		246-086-001-007C	HLWP	Plug Number (T2): 3b

**2.0 4motion (85 kW | 2.0 Litre)**

10.00 - 06.06	AZH, AZJ		246-082-008-021G	SWP-M-C	Plug Number (T2): 6
10.00 - 06.06	AZH, AZJ		246-083-002-022G	SWP-D-C	
10.00 - 06.06	AZH, AZJ		246-086-001-007C	HLWP	Plug Number (T2): 3b

**2.0 Bi-Fuel (85 kW | 2.0 Litre)**

02.02 - 06.06	BEH		246-082-008-021G	SWP-M-C	Plug Number (T2): 6
02.02 - 06.06	BEH		246-083-002-022G	SWP-D-C	
02.02 - 06.06	BEH		246-086-001-007C	HLWP	Plug Number (T2): 3b

**2.3 V5 (110 kW | 2.3 Litre)**

05.99 - 06.06	AGZ		246-083-002-022G	SWP-D-C	
05.99 - 06.06	AGZ		246-086-001-002C	HLWP	Plug Number (T2): 3

**2.3 V5 (125 kW | 2.3 Litre)**

10.00 - 06.06	AQN		246-082-008-021G	SWP-M-C	Plug Number (T2): 6
10.00 - 06.06	AQN		246-083-002-022G	SWP-D-C	
10.00 - 06.06	AQN		246-086-001-007C	HLWP	Plug Number (T2): 3b

**2.3 V5 4motion (110 kW | 2.3 Litre)**

05.99 - 06.06	AGZ		246-083-002-022G	SWP-D-C	
05.99 - 06.06	AGZ		246-086-001-002C	HLWP	Plug Number (T2): 3

**2.3 V5 4motion (125 kW | 2.3 Litre)**

10.00 - 06.06	AQN		246-082-008-021G	SWP-M-C	Plug Number (T2): 6
10.00 - 06.06	AQN		246-083-002-022G	SWP-D-C	
10.00 - 06.06	AQN		246-086-001-007C	HLWP	Plug Number (T2): 3b

**2.8 V6 4motion (150 kW | 2.8 Litre)**

05.99 - 06.06	AQP, AUE, BDE		246-083-002-022G	SWP-D-C	
05.99 - 06.06	AQP, AUE, BDE		246-086-001-002C	HLWP	Plug Number (T2): 3

**GOLF IV Cabriolet (1E7)****1.6 (74 kW | 1.6 Litre)**

06.98 - 06.02	AKS, AFT		246-069-056-001Z	N	
06.98 - 06.02	AKS, AFT		246-082-008-025G	SWP-M-C	
06.98 - 06.02	AKS, AFT		246-086-001-007C	HLWP	Plug Number (T2): 3b; T26: X11-246-003-014

**1.8 (55 kW | 1.8 Litre)**

06.98 - 06.02	AAM, ANN		246-069-056-001Z	N	
06.98 - 10.98	AAM, ANN	-X - 017 970	246-082-008-021G	SWP-M-C	Plug Number (T2): 6
06.98 - 06.02	AAM, ANN		246-082-008-025G	SWP-M-C	
06.98 - 06.02	AAM, ANN		246-086-001-002C	HLWP	Plug Number (T2): 3
06.98 - 06.02	AAM, ANN		246-086-001-007C	HLWP	Plug Number (T2): 3b; T26: X11-246-003-014

**1.8 (66 kW | 1.8 Litre)**

06.98 - 06.02	ADZ, ANP		246-069-056-001Z	N	
06.98 - 10.98	ADZ, ANP	-X - 017 970	246-082-008-021G	SWP-M-C	Plug Number (T2): 6
06.98 - 06.02	ADZ, ANP		246-082-008-025G	SWP-M-C	
06.98 - 06.02	ADZ, ANP		246-086-001-002C	HLWP	Plug Number (T2): 3
06.98 - 06.02	ADZ, ANP		246-086-001-007C	HLWP	Plug Number (T2): 3b; T26: X11-246-003-014

**1.9 TDI (66 kW | 1.9 Litre)**

06.98 - 06.02	ALE, AHU		246-069-056-001Z	N	
06.98 - 06.02	ALE, AHU		246-082-008-025G	SWP-M-C	
06.98 - 06.02	ALE, AHU		246-086-001-007C	HLWP	Plug Number (T2): 3b; T26: X11-246-003-014





			<b>VDO</b>		
Date	Engine Code	Chassis No.	Article No.	Product	Information

**VW****GOLF IV Cabriolet (1E7)****1.9 TDI (81 kW | 1.9 Litre)**

06.98 - 06.02	AFN, AVG		246-069-056-001Z	N	
06.98 - 10.98	AFN, AVG	-X - 017 970	246-082-008-021G	SWP-M-C	Plug Number (T2): 6
06.98 - 06.02	AFN, AVG		246-082-008-025G	SWP-M-C	
06.98 - 06.02	AFN, AVG		246-086-001-002C	HLWP	Plug Number (T2): 3
06.98 - 06.02	AFN, AVG		246-086-001-007C	HLWP	Plug Number (T2): 3b; T26: X11-246-003-014

**2.0 (85 kW | 2.0 Litre)**

06.98 - 06.02	AGG, AKR, AWF, AWG, ATU		246-069-056-001Z	N	
06.98 - 06.02	AGG, AKR, AWF, AWG, ATU		246-082-008-025G	SWP-M-C	
06.98 - 06.02	AGG, AKR, AWF, AWG, ATU		246-086-001-007C	HLWP	Plug Number (T2): 3b; T26: X11-246-003-014

**GOLF V (1K1)****1.0 (48 kW | 1.0 Litre)**

08.05 - 11.08	BJR	1K-6-000 001→	246-082-008-025G	SWP-M-C	
08.05 - 11.08	BJR	1K-6-000 001→	246-083-002-022G	SWP-D-C	
08.05 - 11.08			246-086-001-007C	HLWP	Plug Number (T2): 3b

**1.0 (53 kW | 1.0 Litre)**

10.05 - 11.08		→1K-7-108 000	246-082-008-025G	SWP-M-C	
10.05 - 11.08		→1K-7-108 000	246-083-002-022G	SWP-D-C	
10.05 - 11.08			246-086-001-007C	HLWP	Plug Number (T2): 3b

**1.4 16V (55 kW | 1.4 Litre)**

10.03 - 05.06	BCA		246-082-008-025G	SWP-M-C	
10.03 - 05.06	BCA		246-083-002-022G	SWP-D-C	
10.03 - 05.06	BCA		246-086-001-007C	HLWP	Plug Number (T2): 3b

**1.4 16V (59 kW | 1.4 Litre)**

05.06 - 11.08	BUD	→1K-7-108 000	246-082-008-025G	SWP-M-C	
05.06 - 11.08	BUD	→1K-7-108 000	246-083-002-022G	SWP-D-C	
05.06 - 11.08	BUD		246-086-001-007C	HLWP	Plug Number (T2): 3b

**1.4 FSI (66 kW | 1.4 Litre)**

10.03 - 07.06	BKG, BLN		246-082-008-025G	SWP-M-C	
10.03 - 07.06	BKG, BLN		246-083-002-022G	SWP-D-C	
10.03 - 07.06	BKG, BLN		246-086-001-007C	HLWP	Plug Number (T2): 3b

**1.4 TSI (103 kW | 1.4 Litre)**

05.06 - 11.08	BMV		246-082-008-025G	SWP-M-C	
05.06 - 11.08	BMV		246-083-002-022G	SWP-D-C	
05.06 - 11.08	BMV		246-086-001-007C	HLWP	Plug Number (T2): 3b

**1.4 TSI (125 kW | 1.4 Litre)**

11.05 - 11.08	BLG		246-082-008-025G	SWP-M-C	
11.05 - 11.08	BLG		246-083-002-022G	SWP-D-C	
11.05 - 11.08	BLG		246-086-001-007C	HLWP	Plug Number (T2): 3b

**1.4 TSI (90 kW | 1.4 Litre)**

05.07 - 11.08	CAXA		246-083-002-022G	SWP-D-C	
05.07 - 11.08	CAXA		246-086-001-007C	HLWP	Plug Number (T2): 3b

**1.6 (75 kW | 1.6 Litre)**

01.04 - 11.08	BGU, BSE, BSF		246-082-008-025G	SWP-M-C	
01.04 - 11.08	BGU, BSE, BSF		246-083-002-022G	SWP-D-C	
01.04 - 11.08	BGU, BSE, BSF		246-086-001-007C	HLWP	Plug Number (T2): 3b

**1.6 FSI (74 kW | 1.6 Litre)**

02.06 - 11.08		1J-6-000 001→	246-082-008-025G	SWP-M-C	
02.06 - 11.08		1J-6-000 001→	246-083-002-022G	SWP-D-C	
02.06 - 11.08			246-086-001-007C	HLWP	Plug Number (T2): 3b

**1.6 FSI (85 kW | 1.6 Litre)**

10.03 - 07.08	BAG, BLF, BLP		246-082-008-025G	SWP-M-C	
10.03 - 07.08	BAG, BLF, BLP		246-083-002-022G	SWP-D-C	
10.03 - 07.08	BAG, BLF, BLP		246-086-001-007C	HLWP	Plug Number (T2): 3b

**1.6 MultiFuel (75 kW | 1.6 Litre)**

10.07 - 11.08	CCSA		246-086-001-007C	HLWP	Plug Number (T2): 3b
---------------	------	--	------------------	------	----------------------

**1.8 GTI (132 kW | 1.8 Litre)**

08.06 - 11.08			246-086-001-007C	HLWP	Plug Number (T2): 3b
---------------	--	--	------------------	------	----------------------

**1.9 TDI (66 kW | 1.9 Litre)**

05.04 - 11.08	BRU, BXF, BXJ		246-082-008-025G	SWP-M-C	
05.04 - 11.08	BRU, BXF, BXJ		246-083-002-022G	SWP-D-C	
05.04 - 11.08	BRU, BXF, BXJ		246-086-001-007C	HLWP	Plug Number (T2): 3b



					
Date	Engine Code	Chassis No.	Article No.	Product	Information

## VW

## GOLF V (1K1)

## 1.9 TDI (77 kW | 1.9 Litre)

10.03 → 11.08	BKC, BLS, BXE		246-082-008-025G	SWP-M-C	
10.03 → 11.08	BKC, BLS, BXE		246-083-002-022G	SWP-D-C	
10.03 → 11.08	BKC, BLS, BXE		246-086-001-007C	HLWP	Plug Number (T2): 3b

## 1.9 TDI 4motion (77 kW | 1.9 Litre)

08.04 → 11.08	BKC, BLS, BXE	1J-3-450 001→	246-082-008-025G	SWP-M-C	
08.04 → 11.08	BKC, BLS, BXE	1J-3-450 001→	246-083-002-022G	SWP-D-C	
08.04 → 11.08	BKC, BLS, BXE		246-086-001-007C	HLWP	Plug Number (T2): 3b

## 2.0 (85 kW | 2.0 Litre)

08.06 → 11.08	BHY		246-086-001-007C	HLWP	Plug Number (T2): 3b
---------------	-----	--	------------------	------	----------------------

## 2.0 FSI (110 kW | 2.0 Litre)

01.04 → 11.08	AXW, BLR, BLX, BLY, BVX, BVY, BVZ		246-082-008-025G	SWP-M-C	
01.04 → 11.08	AXW, BLR, BLX, BLY, BVX, BVY, BVZ		246-083-002-022G	SWP-D-C	
01.04 → 11.08	AXW, BLR, BLX, BLY, BVX, BVY, BVZ		246-086-001-007C	HLWP	Plug Number (T2): 3b

## 2.0 FSI 4motion (110 kW | 2.0 Litre)

08.04 → 11.08	BLX		246-082-008-025G	SWP-M-C	
08.04 → 11.08	BLX		246-083-002-022G	SWP-D-C	
08.04 → 11.08	BLX, BVX		246-086-001-007C	HLWP	Plug Number (T2): 3b

## 2.0 GTI (147 kW | 2.0 Litre)

10.04 → 02.09	AXX, BWA, BPY, CAWB, CBFA, CCTA		246-082-008-025G	SWP-M-C	
10.04 → 02.09	AXX, BWA, BPY, CAWB, CBFA, CCTA		246-083-002-022G	SWP-D-C	
10.04 → 02.09	AXX, BWA, BPY, CAWB, CBFA, CCTA		246-086-001-007C	HLWP	Plug Number (T2): 3b

## 2.0 GTI (169 kW | 2.0 Litre)

09.06 → 12.08	BYD	→1K-7-108 000	246-082-008-025G	SWP-M-C	
09.06 → 12.08	BYD	→1K-7-108 000	246-083-002-022G	SWP-D-C	
09.06 → 12.08	BYD		246-086-001-007C	HLWP	Plug Number (T2): 3b

## 2.0 SDI (55 kW | 2.0 Litre)

01.04 → 11.08	BDK		246-082-008-025G	SWP-M-C	
01.04 → 11.08	BDK		246-083-002-022G	SWP-D-C	
01.04 → 11.08	BDK		246-086-001-007C	HLWP	Plug Number (T2): 3b

## 2.0 TDI (100 kW | 2.0 Litre)

10.03 → 11.08	AZV		246-082-008-025G	SWP-M-C	
10.03 → 11.08	AZV		246-083-002-022G	SWP-D-C	
10.03 → 11.08	AZV, CBDA		246-086-001-007C	HLWP	Plug Number (T2): 3b

## 2.0 TDI (103 kW | 2.0 Litre)

12.04 → 11.08	BMM	1J-4-000 001→	246-082-008-025G	SWP-M-C	
12.04 → 11.08	BMM	1J-4-000 001→	246-083-002-022G	SWP-D-C	
12.04 → 11.08	BMM		246-086-001-007C	HLWP	Plug Number (T2): 3b

## 2.0 TDI (125 kW | 2.0 Litre)

11.05 → 11.08	BMN	1J-3-450 001→	246-082-008-025G	SWP-M-C	
11.05 → 11.08	BMN	1J-3-450 001→	246-083-002-022G	SWP-D-C	
11.05 → 11.08	BMN		246-086-001-007C	HLWP	Plug Number (T2): 3b

## 2.0 TDI 16V (103 kW | 2.0 Litre)

10.03 → 11.08	BKD		246-082-008-025G	SWP-M-C	
10.03 → 11.08	BKD		246-083-002-022G	SWP-D-C	
10.03 → 11.08	BKD		246-086-001-007C	HLWP	Plug Number (T2): 3b

## 2.0 TDI 16V 4motion (103 kW | 2.0 Litre)

08.04 → 11.08	BKD	1J-3-450 001→	246-082-008-025G	SWP-M-C	
08.04 → 11.08	BKD	1J-3-450 001→	246-083-002-022G	SWP-D-C	
08.04 → 11.08	BKD		246-086-001-007C	HLWP	Plug Number (T2): 3b

## 2.0 TDI 4motion (103 kW | 2.0 Litre)

08.04 → 11.08	BMM	1J-4-000 001→	246-082-008-025G	SWP-M-C	
08.04 → 11.08	BMM	1J-4-000 001→	246-083-002-022G	SWP-D-C	
08.04 → 11.08	BMM		246-086-001-007C	HLWP	Plug Number (T2): 3b

## 2.5 FSI (110 kW | 2.5 Litre)

06.05 → 11.08	BGP		246-082-008-025G	SWP-M-C	
06.05 → 11.08	BGP		246-083-002-022G	SWP-D-C	



			<b>VDO</b>		
Date	Engine Code	Chassis No.	Article No.	Product	Information

**VW****GOLF V (1K1)****2.5 FSI (110 kW | 2.5 Litre)**

06.05 → 11.08	BGP, BGQ		246-086-001-007C	HLWP	Plug Number (T2): 3b
---------------	----------	--	------------------	------	----------------------

**3.2 (184 kW | 3.2 Litre)**

09.05 → 11.08	BUB		246-086-001-007C	HLWP	Plug Number (T2): 3b
---------------	-----	--	------------------	------	----------------------

**3.2 R32 4motion (184 kW | 3.2 Litre)**

11.05 → 11.08	BUB, CBRA	→1K-7-108 000	246-082-008-025G	SWP-M-C	
11.05 → 11.08	BUB, CBRA	→1K-7-108 000	246-083-002-022G	SWP-D-C	
11.05 → 11.08	BUB, CBRA		246-086-001-007C	HLWP	Plug Number (T2): 3b

**GOLF V Variant (1K5)****1.4 (59 kW | 1.4 Litre)**

06.07 →	BUD		246-083-002-022G	SWP-D-C	
06.07 →	BUD		246-086-001-007C	HLWP	Plug Number (T2): 3b

**1.4 TSI (103 kW | 1.4 Litre)**

06.07 →	BMV		246-083-002-022G	SWP-D-C	
06.07 →	BMV		246-086-001-007C	HLWP	Plug Number (T2): 3b

**1.4 TSI (118 kW | 1.4 Litre)**

07.08 →	CAVD		246-086-001-007C	HLWP	Plug Number (T2): 3b
---------	------	--	------------------	------	----------------------

**1.4 TSI (125 kW | 1.4 Litre)**

06.07 →	BLG		246-083-002-022G	SWP-D-C	
06.07 →	BLG		246-086-001-007C	HLWP	Plug Number (T2): 3b

**1.4 TSI (90 kW | 1.4 Litre)**

06.07 →	CAXA		246-083-002-022G	SWP-D-C	
06.07 →	CAXA		246-086-001-007C	HLWP	Plug Number (T2): 3b

**1.6 (75 kW | 1.6 Litre)**

06.07 →	BSE, BSF, CCSA		246-083-002-022G	SWP-D-C	
06.07 →	BSE, BSF, CCSA		246-086-001-007C	HLWP	Plug Number (T2): 3b

**1.6 MultiFuel (75 kW | 1.6 Litre)**

11.07 →	CCSA		246-086-001-007C	HLWP	Plug Number (T2): 3b
---------	------	--	------------------	------	----------------------

**1.9 TDI (77 kW | 1.9 Litre)**

06.07 →	BLS, BXE		246-083-002-022G	SWP-D-C	
06.07 →	BKC, BLS, BXE		246-086-001-007C	HLWP	Plug Number (T2): 3b

**1.9 TDI 4motion (77 kW | 1.9 Litre)**

01.08 →	BLS		246-083-002-022G	SWP-D-C	
01.08 →	BLS		246-086-001-007C	HLWP	Plug Number (T2): 3b

**2.0 (147 kW | 2.0 Litre)**

06.07 →	BWA, CCTA, CAWB		246-083-002-022G	SWP-D-C	
06.07 →	BWA, CAWB, CCTA		246-086-001-007C	HLWP	Plug Number (T2): 3b

**2.0 TDI (100 kW | 2.0 Litre)**

06.07 →	AZV		246-086-001-007C	HLWP	Plug Number (T2): 3b
---------	-----	--	------------------	------	----------------------

**2.0 TDI (103 kW | 2.0 Litre)**

06.07 →	BMM		246-083-002-022G	SWP-D-C	
06.07 →	BMM		246-086-001-007C	HLWP	Plug Number (T2): 3b

**2.0 TDI 16V (103 kW | 2.0 Litre)**

06.07 →	BKD, CBDB		246-083-002-022G	SWP-D-C	
06.07 →	BKD, CBDB		246-086-001-007C	HLWP	Plug Number (T2): 3b

**2.0 TDI 4motion (100 kW | 2.0 Litre)**

06.07 →	AZV		246-086-001-007C	HLWP	Plug Number (T2): 3b
---------	-----	--	------------------	------	----------------------

**GOLF VI (5K1)****1.2 TSI (77 kW | 1.2 Litre)**

05.09 →	CBZB		246-083-002-022G	SWP-D-C	
05.09 →	CBZB		246-086-001-007C	HLWP	Plug Number (T2): 3b

**1.4 (59 kW | 1.4 Litre)**

10.08 →	CGGA		246-083-002-022G	SWP-D-C	
10.08 →	CGGA		246-086-001-007C	HLWP	Plug Number (T2): 3b

**1.4 TSI (118 kW | 1.4 Litre)**

10.08 →	CAVD		246-083-002-022G	SWP-D-C	
10.08 →	CAVD		246-086-001-007C	HLWP	Plug Number (T2): 3b

**1.4 TSI (90 kW | 1.4 Litre)**

10.08 →	CAXA		246-083-002-022G	SWP-D-C	
10.08 →	CAXA		246-086-001-007C	HLWP	Plug Number (T2): 3b



			<b>VDO</b>		
Date	Engine Code	Chassis No.	Article No.	Product	Information

**VW****GOLF VI (5K1)****1.6 (75 kW | 1.6 Litre)**

10.08 →	BSE, BSF, CCSA		246-083-002-022G	SWP-D-C	
10.08 →	BSE, BSF, CCSA		246-086-001-007C	HLWP	Plug Number (T2): 3b

**1.6 BiFuel (75 kW | 1.6 Litre)**

03.09 →	CHGA	1K-9-400 001 →	246-083-002-022G	SWP-D-C	
03.09 →	CHGA		246-086-001-007C	HLWP	Plug Number (T2): 3b

**1.6 MultiFuel (75 kW | 1.6 Litre)**

10.08 →	CCSA		246-083-002-022G	SWP-D-C	
---------	------	--	------------------	---------	--

**1.6 TDI (66 kW | 1.6 Litre)**

02.09 →	CAYB	1K-9-400 001 →	246-083-002-022G	SWP-D-C	
02.09 →	CAYB		246-086-001-007C	HLWP	Plug Number (T2): 3b

**1.6 TDI (77 kW | 1.6 Litre)**

02.09 →	CAYC	1K-9-400 001 →	246-083-002-022G	SWP-D-C	
02.09 →	CAYC		246-086-001-007C	HLWP	Plug Number (T2): 3b

**1.8 TSI (118 kW | 1.8 Litre)**

06.09 →	CDAA	1K-9-400 001 →	246-083-002-022G	SWP-D-C	
06.09 →	CDAA		246-086-001-007C	HLWP	Plug Number (T2): 3b

**2.0 GTi (155 kW | 2.0 Litre)**

04.09 →	CCZB	1K-9-400 001 →	246-083-002-022G	SWP-D-C	
04.09 →	CCZB		246-086-001-007C	HLWP	Plug Number (T2): 3b

**2.0 R 4motion (199 kW | 2.0 Litre)**

11.09 →	CDLF	1K-9-400 001 →	246-083-002-022G	SWP-D-C	
11.09 →	CDLF		246-086-001-007C	HLWP	Plug Number (T2): 3b

**2.0 TDI (100 kW | 2.0 Litre)**

10.08 →	CBAA, CFFA		246-083-002-022G	SWP-D-C	
10.08 →	CBAA, CFFA		246-086-001-007C	HLWP	Plug Number (T2): 3b

**2.0 TDI (103 kW | 2.0 Litre)**

10.08 →	CBAB, CFFB, CJAA		246-083-002-022G	SWP-D-C	
10.08 →	CBAB, CFFB, CJAA		246-086-001-007C	HLWP	Plug Number (T2): 3b

**2.0 TDI (125 kW | 2.0 Litre)**

04.09 →	CBBB, CFGB	1K-9-400 001 →	246-083-002-022G	SWP-D-C	
04.09 →	CBBB, CFGB		246-086-001-007C	HLWP	Plug Number (T2): 3b

**2.0 TDI (81 kW | 2.0 Litre)**

10.08 →	CBDC		246-083-002-022G	SWP-D-C	
10.08 →	CBDC		246-086-001-007C	HLWP	Plug Number (T2): 3b

**2.0 TDI 4motion (103 kW | 2.0 Litre)**

05.09 →	CBAB, CFFB	1K-9-400 001 →	246-083-002-022G	SWP-D-C	
05.09 →	CBAB, CFFB		246-086-001-007C	HLWP	Plug Number (T2): 3b

**GOLF VI Variant (AJ5)****1.2 TSI (63 kW | 1.2 Litre)**

07.10 →	CBZA	5U-9-000 001 →	246-082-008-025G	SWP-M-C	
07.10 →	CBZA		246-083-002-022G	SWP-D-C	
07.10 →	CBZA		246-086-001-007C	HLWP	Plug Number (T2): 3b

**1.2 TSI (77 kW | 1.2 Litre)**

08.09 →	CBZB		246-083-002-022G	SWP-D-C	
08.09 →	CBZB		246-086-001-007C	HLWP	Plug Number (T2): 3b

**1.4 (59 kW | 1.4 Litre)**

07.09 →	BUD, CGGA		246-083-002-022G	SWP-D-C	
07.09 →	BUD, CGGA		246-086-001-007C	HLWP	Plug Number (T2): 3b

**1.4 TSI (118 kW | 1.4 Litre)**

07.09 →	CAVD		246-083-002-022G	SWP-D-C	
07.09 →	CAVD		246-086-001-007C	HLWP	Plug Number (T2): 3b

**1.4 TSI (90 kW | 1.4 Litre)**

07.09 →	CAXA		246-083-002-022G	SWP-D-C	
07.09 →	CAXA		246-086-001-007C	HLWP	Plug Number (T2): 3b

**1.6 (75 kW | 1.6 Litre)**

07.09 →	BSE, BSF, CCSA, CMXA		246-083-002-022G	SWP-D-C	
07.09 →	BSE, BSF, CCSA, CMXA		246-086-001-007C	HLWP	Plug Number (T2): 3b

**1.6 TDI (66 kW | 1.6 Litre)**

12.09 →	CAYB		246-083-002-022G	SWP-D-C	
12.09 →	CAYB		246-086-001-007C	HLWP	Plug Number (T2): 3b



			<b>VDO</b>		
Date	Engine Code	Chassis No.	Article No.	Product	Information

**VW****GOLF VI Variant (AJ5)****1.6 TDI (77 kW | 1.6 Litre)**

07.09 →	CAYC		246-083-002-022G	SWP-D-C	
07.09 →	CAYC		246-086-001-007C	HLWP	Plug Number (T2): 3b

**1.6 TDI 4motion (77 kW | 1.6 Litre)**

07.09 →	CAYC		246-083-002-022G	SWP-D-C	
07.09 →	CAYC		246-086-001-007C	HLWP	Plug Number (T2): 3b

**2.0 TDI (100 kW | 2.0 Litre)**

07.09 →			246-083-002-022G	SWP-D-C	
07.09 →			246-086-001-007C	HLWP	Plug Number (T2): 3b

**2.0 TDI (103 kW | 2.0 Litre)**

07.09 →	BMM		246-083-002-022G	SWP-D-C	
07.09 →	BMM		246-086-001-007C	HLWP	Plug Number (T2): 3b

**2.0 TDI 16V (103 kW | 2.0 Litre)**

07.09 →	CBDB, CFHC		246-083-002-022G	SWP-D-C	
07.09 →	CBDB, CFHC		246-086-001-007C	HLWP	Plug Number (T2): 3b

**GOLF PLUS (5M1, 521)****1.0 (48 kW | 1.0 Litre)**

08.05 →	BJR	→1K-7-550 000	246-083-002-022G	SWP-D-C	
08.05 →			246-086-001-007C	HLWP	Plug Number (T2): 3b

**1.0 (53 kW | 1.0 Litre)**

10.05 →		→1K-7-550 000	246-083-002-022G	SWP-D-C	
10.05 →			246-086-001-007C	HLWP	Plug Number (T2): 3b

**1.2 TSI (77 kW | 1.2 Litre)**

11.09 →	CBZB	1K-9-899 999→	246-083-002-022G	SWP-D-C	
11.09 →	CBZB		246-086-001-007C	HLWP	Plug Number (T2): 3b

**1.4 16V (55 kW | 1.4 Litre)**

01.05 →	BCA	→1K-7-550 000	246-083-002-022G	SWP-D-C	
01.05 →	BCA		246-086-001-007C	HLWP	Plug Number (T2): 3b

**1.4 16V (59 kW | 1.4 Litre)**

05.06 →	BUD		246-083-002-022G	SWP-D-C	
05.06 →	BUD, CGGA		246-086-001-007C	HLWP	Plug Number (T2): 3b

**1.4 FSI (66 kW | 1.4 Litre)**

07.05 →	BLN	→1K-7-550 000	246-083-002-022G	SWP-D-C	
07.05 →	BLN		246-086-001-007C	HLWP	Plug Number (T2): 3b

**1.4 TSI (103 kW | 1.4 Litre)**

05.06 → 06.08	BMV	→1K-7-550 000	246-083-002-022G	SWP-D-C	
05.06 → 06.08	BMV		246-086-001-007C	HLWP	Plug Number (T2): 3b

**1.4 TSI (118 kW | 1.4 Litre)**

06.08 →	CAVD		246-083-002-022G	SWP-D-C	
06.08 →	CAVD		246-086-001-007C	HLWP	Plug Number (T2): 3b

**1.4 TSI (125 kW | 1.4 Litre)**

05.06 → 06.08	BLG		246-083-002-022G	SWP-D-C	
05.06 → 06.08	BLG		246-086-001-007C	HLWP	Plug Number (T2): 3b

**1.4 TSI (90 kW | 1.4 Litre)**

06.07 →	CAXA		246-083-002-022G	SWP-D-C	
06.07 →	CAXA		246-086-001-007C	HLWP	Plug Number (T2): 3b

**1.6 (75 kW | 1.6 Litre)**

05.05 →	CCSA		246-083-002-022G	SWP-D-C	
05.05 →	BSE, BSF, CCSA, CMXA		246-086-001-007C	HLWP	Plug Number (T2): 3b

**1.6 BiFuel (75 kW | 1.6 Litre)**

05.09 →	CHGA	1K-9-899 999→	246-083-002-022G	SWP-D-C	
---------	------	---------------	------------------	---------	--

**1.6 FSI (85 kW | 1.6 Litre)**

01.05 → 05.08	BLF	→1K-7-550 000	246-083-002-022G	SWP-D-C	
01.05 → 05.08	BLF		246-086-001-007C	HLWP	Plug Number (T2): 3b

**1.6 MultiFuel (75 kW | 1.6 Litre)**

11.07 →	CCSA, CHGA		246-083-002-022G	SWP-D-C	
11.07 →	CCSA, CHGA		246-086-001-007C	HLWP	Plug Number (T2): 3b

**1.6 TDI (66 kW | 1.6 Litre)**

02.09 →	CAYB	1K-9-899 999→	246-083-002-022G	SWP-D-C	
---------	------	---------------	------------------	---------	--

**1.6 TDI (77 kW | 1.6 Litre)**

03.09 →	CAYC	1K-9-899 999→	246-083-002-022G	SWP-D-C	
03.09 →	CAYC		246-086-001-007C	HLWP	Plug Number (T2): 3b



			<b>VDO</b>		
Date	Engine Code	Chassis No.	Article No.	Product	Information

**VW****GOLF PLUS (5M1, 521)****1.9 TDI (66 kW | 1.9 Litre)**

05.05 - 12.08	BRU, BXF, BXJ		246-083-002-022G	SWP-D-C	
05.05 - 12.08	BRU, BXF, BXJ		246-086-001-007C	HLWP	Plug Number (T2): 3b

**1.9 TDI (77 kW | 1.9 Litre)**

01.05 - 01.09	BKC, BLS, BXE		246-083-002-022G	SWP-D-C	
01.05 - 01.09	BKC, BLS, BXE		246-086-001-007C	HLWP	Plug Number (T2): 3b

**2.0 FSI (110 kW | 2.0 Litre)**

05.05 - 06.08	BLR		246-083-002-022G	SWP-D-C	
05.05 - 06.08	BLR, BLY, BVY, BVZ		246-086-001-007C	HLWP	Plug Number (T2): 3b

**2.0 TDI (100 kW | 2.0 Litre)**

05.05 -	AZV, CBDA, CFHB		246-083-002-022G	SWP-D-C	
05.05 -	AZV, CBDA		246-086-001-007C	HLWP	Plug Number (T2): 3b

**2.0 TDI (103 kW | 2.0 Litre)**

12.05 - 05.09	BMM		246-083-002-022G	SWP-D-C	
12.05 - 05.09	BMM		246-086-001-007C	HLWP	Plug Number (T2): 3b

**2.0 TDI (81 kW | 2.0 Litre)**

01.09 -	CBDC	1K-9-899 999→	246-083-002-022G	SWP-D-C	
01.09 -	CBDC		246-086-001-007C	HLWP	Plug Number (T2): 3b

**2.0 TDI (96 kW | 2.0 Litre)**

05.05 - 05.07	BEE		246-083-002-022G	SWP-D-C	
05.05 - 05.07	BVB		246-086-001-007C	HLWP	Plug Number (T2): 3b

**2.0 TDI 16V (103 kW | 2.0 Litre)**

01.05 -	BKD, CBDB, CFHC		246-083-002-022G	SWP-D-C	
01.05 -	BKD, CBDB, CFHC		246-086-001-007C	HLWP	Plug Number (T2): 3b

**ILTIS (183)****1.6 TD (51 kW | 1.6 Litre)**

08.87 - 12.88	1C		246-082-008-014C	SWP-M-C	Plug Number (T2): 1
---------------	----	--	------------------	---------	---------------------

**1.7 (55 kW | 1.7 Litre)**

03.79 - 12.88	YX, WL		246-082-008-014C	SWP-M-C	Plug Number (T2): 1
---------------	--------	--	------------------	---------	---------------------

**JETTA I (16)****1.1 (37 kW | 1.1 Litre)**

08.78 - 02.84	GG, FA		246-075-021-006C	SWP-M-G	Plug Number (T2): 1
08.80 - 07.83	GG, FA		246-082-008-014C	SWP-M-C	Plug Number (T2): 1
08.78 - 02.84	GG, FA		246-086-001-007C	HLWP	Plug Number (T2): 3b; T26: X11-246-003-014

**1.3 (44 kW | 1.3 Litre)**

08.79 - 02.84	GF		246-075-021-006C	SWP-M-G	Plug Number (T2): 1
08.79 - 07.83	GF		246-082-008-014C	SWP-M-C	Plug Number (T2): 1
08.79 - 02.84	GF		246-086-001-007C	HLWP	Plug Number (T2): 3b; T26: X11-246-003-014

**1.5 (51 kW | 1.5 Litre)**

08.78 - 02.84	JB		246-075-021-006C	SWP-M-G	Plug Number (T2): 1
08.78 - 07.83	JB		246-082-008-014C	SWP-M-C	Plug Number (T2): 1
08.78 - 02.84	JB		246-086-001-007C	HLWP	Plug Number (T2): 3b; T26: X11-246-003-014

**1.5 D (37 kW | 1.5 Litre)**

08.78 - 07.80	CK		246-075-021-006C	SWP-M-G	Plug Number (T2): 1
08.78 - 07.80	CK		246-086-001-007C	HLWP	Plug Number (T2): 3b; T26: X11-246-003-014

**1.6 (63 kW | 1.6 Litre)**

08.78 - 02.84	FR		246-075-021-006C	SWP-M-G	Plug Number (T2): 1
08.80 - 07.83	FR		246-082-008-014C	SWP-M-C	Plug Number (T2): 1
08.78 - 02.84	FR		246-086-001-007C	HLWP	Plug Number (T2): 3b; T26: X11-246-003-014

**1.6 D (40 kW | 1.6 Litre)**

08.80 - 02.84	CR, JK		246-075-021-006C	SWP-M-G	Plug Number (T2): 1
08.80 - 07.83	CR, JK		246-082-008-014C	SWP-M-C	Plug Number (T2): 1
08.80 - 02.84	CR, JK		246-086-001-007C	HLWP	Plug Number (T2): 3b; T26: X11-246-003-014

**1.6 GLI (81 kW | 1.6 Litre)**

08.78 - 07.82	EG		246-075-021-006C	SWP-M-G	Plug Number (T2): 1
08.78 - 07.82	EG		246-082-008-014C	SWP-M-C	Plug Number (T2): 1
08.78 - 07.82	EG		246-086-001-007C	HLWP	Plug Number (T2): 3b; T26: X11-246-003-014

**1.6 TD (51 kW | 1.6 Litre)**

03.82 - 02.84	CY		246-082-008-014C	SWP-M-C	Plug Number (T2): 1
03.82 - 02.84	CY		246-086-001-007C	HLWP	Plug Number (T2): 3b; T26: X11-246-003-014



			<b>VDO</b>		
Date	Engine Code	Chassis No.	Article No.	Product	Information

**VW****JETTA I (16)****1.8 (82 kW | 1.8 Litre)**

08.82 - 07.83	DX, JJ		246-082-008-014C	SWP-M-C	Plug Number (T2): 1
08.82 - 02.84	DX, JJ		246-086-001-007C	HLWP	Plug Number (T2): 3b; T26: X11-246-003-014

**JETTA II (19E, 1G2, 165)****1.3 (40 kW | 1.3 Litre)**

01.84 - 06.87	HK, MH		246-082-008-014C	SWP-M-C	Plug Number (T2): 1
01.84 - 06.87	HK, MH		246-086-001-007C	HLWP	Plug Number (T2): 3b; T24: C →; T26: X11-246-003-014

**1.3 (43 kW | 1.3 Litre)**

01.84 - 10.86	GT		246-082-008-014C	SWP-M-C	Plug Number (T2): 1
01.84 - 10.86	GT		246-086-001-007C	HLWP	Plug Number (T2): 3b; T24: C →; T26: X11-246-003-014

**1.3 CAT (40 kW | 1.3 Litre)**

08.88 - 07.90	MH, NZ, 2G		246-082-008-014C	SWP-M-C	Plug Number (T2): 1
06.87 - 12.91	MH, NZ, 2G		246-086-001-007C	HLWP	Plug Number (T2): 3b; T24: C →; T26: X11-246-003-014

**1.6 (51 kW | 1.6 Litre)**

10.86 - 10.91	PN		246-082-008-014C	SWP-M-C	Plug Number (T2): 1
10.86 - 10.91	PN		246-086-001-007C	HLWP	Plug Number (T2): 3b; T24: C →; T26: X11-246-003-014

**1.6 (53 kW | 1.6 Litre)**

08.86 - 10.91	RF		246-082-008-014C	SWP-M-C	Plug Number (T2): 1
03.86 - 10.91	RF		246-086-001-007C	HLWP	Plug Number (T2): 3b; T24: C →; T26: X11-246-003-014

**1.6 (55 kW | 1.6 Litre)**

01.84 - 07.91	EZ, HM, ABN		246-082-008-014C	SWP-M-C	Plug Number (T2): 1
01.84 - 07.92	EZ, HM, ABN		246-086-001-007C	HLWP	Plug Number (T2): 3b; T24: C →; T26: X11-246-003-014

**1.6 D (40 kW | 1.6 Litre)**

01.84 - 10.91	JP, ME		246-082-008-014C	SWP-M-C	Plug Number (T2): 1
01.84 - 10.91	JP, ME		246-086-001-007C	HLWP	Plug Number (T2): 3b; T24: C →; T26: X11-246-003-014

**1.6 TD (44 kW | 1.6 Litre)**

01.90 - 10.91	1V		246-086-001-007C	HLWP	Plug Number (T2): 3b; T24: C →; T26: X11-246-003-014
---------------	----	--	------------------	------	------------------------------------------------------

**1.6 TD (51 kW | 1.6 Litre)**

08.84 - 10.91	JR, MF		246-082-008-014C	SWP-M-C	Plug Number (T2): 1
01.84 - 10.91	JR, MF		246-086-001-007C	HLWP	Plug Number (T2): 3b; T24: C →; T26: X11-246-003-014

**1.6 TD (59 kW | 1.6 Litre)**

04.89 - 10.91	RA, SB		246-082-008-014C	SWP-M-C	Plug Number (T2): 1
04.89 - 10.91	RA, SB		246-083-002-022G	SWP-D-C	
04.89 - 10.91	RA, SB		246-086-001-007C	HLWP	Plug Number (T2): 3b; T24: C →; T26: X11-246-003-014

**1.8 (62 kW | 1.8 Litre)**

08.88 - 01.90	RH		246-082-008-014C	SWP-M-C	Plug Number (T2): 1
08.86 - 01.90	RH		246-086-001-007C	HLWP	Plug Number (T2): 3b; T24: C →; T26: X11-246-003-014

**1.8 (66 kW | 1.8 Litre)**

08.88 - 10.91	GX, GU, HV		246-082-008-014C	SWP-M-C	Plug Number (T2): 1
08.87 - 10.91	GX, GU, HV		246-083-002-014G	SWP-D-C	Plug Number (T2): 6
08.84 - 10.91	GX, GU, HV		246-086-001-007C	HLWP	Plug Number (T2): 3b; T24: C →; T26: X11-246-003-014

**1.8 (79 kW | 1.8 Litre)**

08.85 - 10.87	RD		246-086-001-007C	HLWP	Plug Number (T2): 3b; T24: C →; T26: X11-246-003-014
---------------	----	--	------------------	------	------------------------------------------------------

**1.8 (82 kW | 1.8 Litre)**

01.84 - 07.88	EV, PB, GZ		246-082-008-014C	SWP-M-C	Plug Number (T2): 1
01.84 - 10.91	EV, PB, GZ		246-086-001-007C	HLWP	Plug Number (T2): 3b; T24: C →; T26: X11-246-003-014

**1.8 16V (102 kW | 1.8 Litre)**

06.87 - 12.89	KR		246-082-008-014C	SWP-M-C	Plug Number (T2): 1
---------------	----	--	------------------	---------	---------------------



			<b>VDO</b>		
Date	Engine Code	Chassis No.	Article No.	Product	Information

**VW****JETTA II (19E, 1G2, 165)****1.8 16V (102 kW | 1.8 Litre)**

06.87 - 12.89	KR		246-086-001-007C	HLWP	Plug Number (T2): 3b; T24: C →; T26: X11-246-003-014
---------------	----	--	------------------	------	------------------------------------------------------

**1.8 16V (95 kW | 1.8 Litre)**

08.86 - 10.91	PL		246-082-008-014C	SWP-M-C	Plug Number (T2): 1
08.86 - 10.91	PL		246-086-001-007C	HLWP	Plug Number (T2): 3b; T24: C →; T26: X11-246-003-014

**1.8 CAT (66 kW | 1.8 Litre)**

08.87 - 10.91	RP, GX		246-082-008-014C	SWP-M-C	Plug Number (T2): 1
08.87 - 10.91	RP, GX		246-086-001-007C	HLWP	Plug Number (T2): 3b; T24: C →; T26: X11-246-003-014

**1.8 CAT (79 kW | 1.8 Litre)**

01.87 - 10.91	PF		246-082-008-014C	SWP-M-C	Plug Number (T2): 1
01.87 - 10.91	PF		246-086-001-007C	HLWP	Plug Number (T2): 3b; T24: C →; T26: X11-246-003-014

**1.8 Syncro (66 kW | 1.8 Litre)**

08.87 - 07.88	GU, RP		246-083-002-014G	SWP-D-C	Plug Number (T2): 6
08.87 - 12.88	GU, RP		246-086-001-007C	HLWP	Plug Number (T2): 3b; T24: C →; T26: X11-246-003-014

**1.8 Syncro (72 kW | 1.8 Litre)**

08.88 - 07.91	1P		246-083-002-014G	SWP-D-C	Plug Number (T2): 6
08.88 - 07.91	1P		246-086-001-007C	HLWP	Plug Number (T2): 3b; T24: C →; T26: X11-246-003-014

**2.0 (100 kW | 2.0 Litre)**

08.89 - 07.92	9A		246-083-002-022G	SWP-D-C	T30: Jetta Syncro
---------------	----	--	------------------	---------	-------------------

**JETTA III (1K2)****1.4 TSI (103 kW | 1.4 Litre)**

07.06 - 10.10	BMV		246-082-008-025G	SWP-M-C	
07.06 - 10.10	BMV		246-086-001-007C	HLWP	Plug Number (T2): 3b

**1.4 TSI (118 kW | 1.4 Litre)**

07.08 - 10.10	CAVD		246-082-008-025G	SWP-M-C	
07.08 - 10.10	CAVD		246-086-001-007C	HLWP	Plug Number (T2): 3b

**1.4 TSI (125 kW | 1.4 Litre)**

07.06 - 10.10	BLG		246-082-008-025G	SWP-M-C	
07.06 - 10.10	BLG		246-086-001-007C	HLWP	Plug Number (T2): 3b

**1.4 TSI (90 kW | 1.4 Litre)**

05.07 - 10.10	CAXA		246-086-001-007C	HLWP	Plug Number (T2): 3b
---------------	------	--	------------------	------	----------------------

**1.6 (75 kW | 1.6 Litre)**

10.05 - 10.10	BSE, BSF, CCSA		246-086-001-007C	HLWP	Plug Number (T2): 3b
---------------	----------------	--	------------------	------	----------------------

**1.6 FSI (85 kW | 1.6 Litre)**

09.05 - 10.10	BLF		246-086-001-007C	HLWP	Plug Number (T2): 3b
---------------	-----	--	------------------	------	----------------------

**1.6 MultiFuel (75 kW | 1.6 Litre)**

01.08 - 10.10	CCSA		246-082-008-025G	SWP-M-C	
01.08 - 10.10	CCSA		246-086-001-007C	HLWP	Plug Number (T2): 3b

**1.6 TDI (77 kW | 1.6 Litre)**

06.09 - 10.10	CAYC		246-082-008-025G	SWP-M-C	
06.09 - 10.10	CAYC		246-086-001-007C	HLWP	Plug Number (T2): 3b

**1.9 TDI (77 kW | 1.9 Litre)**

08.05 - 10.10	BKC, BLS, BXE		246-086-001-007C	HLWP	Plug Number (T2): 3b
---------------	---------------	--	------------------	------	----------------------

**2.0 (136 kW | 2.0 Litre)**

08.05 - 06.08			246-082-008-025G	SWP-M-C	
08.05 - 06.08			246-086-001-007C	HLWP	Plug Number (T2): 3b

**2.0 FSI (110 kW | 2.0 Litre)**

08.05 - 10.10	BLR, BLY, BVZ, BVY		246-086-001-007C	HLWP	Plug Number (T2): 3b
---------------	--------------------	--	------------------	------	----------------------

**2.0 TDI (100 kW | 2.0 Litre)**

09.05 - 10.10	AZV, CBDA		246-086-001-007C	HLWP	Plug Number (T2): 3b
---------------	-----------	--	------------------	------	----------------------

**2.0 TDI (103 kW | 2.0 Litre)**

10.05 - 10.10	BMM		246-086-001-007C	HLWP	Plug Number (T2): 3b
---------------	-----	--	------------------	------	----------------------

**2.0 TDI (125 kW | 2.0 Litre)**

10.06 - 10.10	BMN		246-082-008-025G	SWP-M-C	
10.06 - 10.10	BMN, CEGA		246-086-001-007C	HLWP	Plug Number (T2): 3b





			<b>VDO</b>		
Date	Engine Code	Chassis No.	Article No.	Product	Information

**VW****JETTA III (1K2)****2.0 TDI 16V (103 kW | 2.0 Litre)**

08.05 - 10.10	CBDB, CJAA, BKD		246-086-001-007C	HLWP	Plug Number (T2): 3b
---------------	-----------------	--	------------------	------	----------------------

**2.0 TFSI (147 kW | 2.0 Litre)**

10.05 - 10.10	BPY, BWA, CAWB, CBFA, CCTA		246-086-001-007C	HLWP	Plug Number (T2): 3b
---------------	----------------------------	--	------------------	------	----------------------

**2.5 FSI (110 kW | 2.5 Litre)**

01.06 - 10.10	BTK		246-082-008-025G	SWP-M-C	
---------------	-----	--	------------------	---------	--

01.06 - 10.10	BGP, BTK		246-086-001-007C	HLWP	Plug Number (T2): 3b
---------------	----------	--	------------------	------	----------------------

**2.5 FSI (125 kW | 2.5 Litre)**

07.08 - 10.10	CBTA, CCCA		246-082-008-025G	SWP-M-C	
---------------	------------	--	------------------	---------	--

07.08 - 10.10	CBTA, CCCA		246-086-001-007C	HLWP	Plug Number (T2): 3b
---------------	------------	--	------------------	------	----------------------

**KAEFER****1200 1.2 (11) (25 kW | 1.2 Litre)**

01.60 - 12.85	D	F114 2000 001→	246-075-021-006C	SWP-M-G	Plug Number (T2): 1
---------------	---	----------------	------------------	---------	---------------------

**KARMANN GHIA Convertible (14, 34)****1200 (25 kW | 1.2 Litre)**

09.57 - 12.64	D	F114 2000 001→	246-075-021-006C	SWP-M-G	Plug Number (T2): 1
---------------	---	----------------	------------------	---------	---------------------

**K 70 (48)****1.8 (74 kW | 1.8 Litre)**

08.73 - 10.74	DC		246-075-021-006C	SWP-M-G	Plug Number (T2): 1
---------------	----	--	------------------	---------	---------------------

**LUPO (6X1, 6E1)****1.0 (37 kW | 1.0 Litre)**

10.98 - 07.05	ANV, ALD, AER, ALL, AUC		246-083-002-022G	SWP-D-C	
---------------	-------------------------	--	------------------	---------	--

09.98 - 07.05	ANV, ALD, AER, ALL, AUC		246-086-001-007C	HLWP	Plug Number (T2): 3b; T26: X11-246-003-014
---------------	-------------------------	--	------------------	------	--------------------------------------------

**1.2 TDI 3L (45 kW | 1.2 Litre)**

07.99 - 07.05	ANY, AYZ		246-083-002-022G	SWP-D-C	
---------------	----------	--	------------------	---------	--

07.99 - 07.05	ANY, AYZ		246-086-001-007C	HLWP	Plug Number (T2): 3b; T26: X11-246-003-014
---------------	----------	--	------------------	------	--------------------------------------------

**1.4 (44 kW | 1.4 Litre)**

10.00 - 07.05	AUD		246-083-002-022G	SWP-D-C	
---------------	-----	--	------------------	---------	--

10.00 - 07.05	AUD		246-086-001-007C	HLWP	Plug Number (T2): 3b; T26: X11-246-003-014
---------------	-----	--	------------------	------	--------------------------------------------

**1.4 16V (55 kW | 1.4 Litre)**

10.98 - 07.05	AHW, AKQ, APE, AUA, BBY		246-083-002-022G	SWP-D-C	
---------------	-------------------------	--	------------------	---------	--

09.98 - 07.05	AHW, AKQ, APE, AUA, BBY		246-086-001-007C	HLWP	Plug Number (T2): 3b; T26: X11-246-003-014
---------------	-------------------------	--	------------------	------	--------------------------------------------

**1.4 16V (74 kW | 1.4 Litre)**

08.99 - 07.05	AFK, AQQ, AUB		246-083-002-022G	SWP-D-C	
---------------	---------------	--	------------------	---------	--

08.99 - 07.05	AFK, AQQ, AUB		246-086-001-007C	HLWP	Plug Number (T2): 3b; T26: X11-246-003-014
---------------	---------------	--	------------------	------	--------------------------------------------

**1.4 FSI (77 kW | 1.4 Litre)**

02.01 - 07.05	ARR		246-083-002-022G	SWP-D-C	
---------------	-----	--	------------------	---------	--

02.01 - 07.05	ARR		246-086-001-007C	HLWP	Plug Number (T2): 3b; T26: X11-246-003-014
---------------	-----	--	------------------	------	--------------------------------------------

**1.4 TDI (55 kW | 1.4 Litre)**

05.99 - 07.05	AMF		246-083-002-022G	SWP-D-C	
---------------	-----	--	------------------	---------	--

01.99 - 07.05	AMF		246-086-001-007C	HLWP	Plug Number (T2): 3b; T26: X11-246-003-014
---------------	-----	--	------------------	------	--------------------------------------------

**1.6 GTI (92 kW | 1.6 Litre)**

09.00 - 07.05	AVY		246-083-002-022G	SWP-D-C	
---------------	-----	--	------------------	---------	--

09.00 - 07.05	AVY		246-086-001-007C	HLWP	Plug Number (T2): 3b; T26: X11-246-003-014
---------------	-----	--	------------------	------	--------------------------------------------

**1.7 SDI (44 kW | 1.7 Litre)**

10.98 - 07.05	AKU		246-083-002-022G	SWP-D-C	
---------------	-----	--	------------------	---------	--

09.98 - 07.05	AKU		246-086-001-007C	HLWP	Plug Number (T2): 3b; T26: X11-246-003-014
---------------	-----	--	------------------	------	--------------------------------------------

**NEW BEETLE (9C1, 1C1)****1.4 (55 kW | 1.4 Litre)**

11.01 -	BCA		246-082-008-025G	SWP-M-C	
---------	-----	--	------------------	---------	--

11.01 -	BCA		246-086-001-007C	HLWP	Plug Number (T2): 3b
---------	-----	--	------------------	------	----------------------

**1.6 (74 kW | 1.6 Litre)**

10.99 - 09.00	AWH		246-082-008-025G	SWP-M-C	
---------------	-----	--	------------------	---------	--

10.99 - 09.00	AWH		246-086-001-007C	HLWP	Plug Number (T2): 3b
---------------	-----	--	------------------	------	----------------------

**1.6 (75 kW | 1.6 Litre)**

06.00 -	AYD, BFS		246-082-008-025G	SWP-M-C	
---------	----------	--	------------------	---------	--

06.00 -	AYD, BFS		246-086-001-007C	HLWP	Plug Number (T2): 3b
---------	----------	--	------------------	------	----------------------



			<b>VDO</b>		
Date	Engine Code	Chassis No.	Article No.	Product	Information

**VW****NEW BEETLE (9C1, 1C1)****1.8 T (110 kW | 1.8 Litre)**

10.99 →	APH, AVC, AWU, AWW, AGU, BKF		246-082-008-025G	SWP-M-C	
10.99 →	APH, AVC, AWU, AWW, AGU, BKF		246-086-001-007C	HLWP	Plug Number (T2): 3b

**1.8 T (132 kW | 1.8 Litre)**

11.01 → 06.05	AWP, BNU		246-082-008-025G	SWP-M-C	T26: 1J0 955 665 H
---------------	----------	--	------------------	---------	--------------------

**1.9 TDI (66 kW | 1.9 Litre)**

01.98 → 06.04	ALH	1J-W-000 001→	246-082-008-025G	SWP-M-C	
11.98 → 06.04	ALH		246-086-001-002C	HLWP	Plug Number (T2): 3

**1.9 TDI (74 kW | 1.9 Litre)**

02.01 →	ATD, BEW		246-082-008-025G	SWP-M-C	
02.01 →	ATD, BEW		246-086-001-007C	HLWP	Plug Number (T2): 3b

**1.9 TDI (77 kW | 1.9 Litre)**

07.05 →	BSW		246-082-008-025G	SWP-M-C	
---------	-----	--	------------------	---------	--

**2.0 (85 kW | 2.0 Litre)**

01.98 →	AQY, AEG, APK, AZG, BEV, AVH, AZJ, BER, BEJ, BHP, CBPA		246-082-008-025G	SWP-M-C	
11.98 →	AQY, AEG, APK, AZG, BEV, AVH, AZJ, BER, BEJ, BHP, CBPA		246-086-001-002C	HLWP	Plug Number (T2): 3

**2.3 V5 (125 kW | 2.3 Litre)**

10.00 →	AQN		246-082-008-025G	SWP-M-C	
10.00 →	AQN		246-086-001-007C	HLWP	Plug Number (T2): 3b

**2.5 (110 kW | 2.5 Litre)**

07.05 →	BPS		246-082-008-025G	SWP-M-C	
---------	-----	--	------------------	---------	--

**RSI 3.2 (1C9) (165 kW | 3.2 Litre)**

04.00 → 05.01	AXJ		246-082-008-025G	SWP-M-C	
04.00 → 05.01	AXJ		246-086-001-007C	HLWP	Plug Number (T2): 3b

**NEW BEETLE Convertible (1Y7)****1.4 (55 kW | 1.4 Litre)**

01.03 → 09.10	BCA		246-082-008-025G	SWP-M-C	
01.03 → 09.10	BCA		246-086-001-007C	HLWP	Plug Number (T2): 3b

**1.6 (75 kW | 1.6 Litre)**

01.03 → 09.10	BFS		246-082-008-025G	SWP-M-C	
01.03 → 09.10	BFS		246-086-001-007C	HLWP	Plug Number (T2): 3b

**1.8 T (110 kW | 1.8 Litre)**

01.03 → 09.10	AWU, AWW, BKF		246-082-008-025G	SWP-M-C	
01.03 → 09.10	AWU, AWW, BKF		246-086-001-007C	HLWP	Plug Number (T2): 3b

**1.9 TDI (74 kW | 1.9 Litre)**

06.03 → 09.10	AXR		246-082-008-025G	SWP-M-C	
06.03 → 09.10	AXR		246-086-001-007C	HLWP	Plug Number (T2): 3b

**1.9 TDI (77 kW | 1.9 Litre)**

07.05 → 09.10	BSW		246-082-008-025G	SWP-M-C	
---------------	-----	--	------------------	---------	--

**2.0 (85 kW | 2.0 Litre)**

09.02 → 10.10	AZJ, BDC, BGD, BEV		246-082-008-025G	SWP-M-C	
09.02 → 10.10	AZJ, BDC, BGD, BEV		246-086-001-007C	HLWP	Plug Number (T2): 3b

**2.5 (110 kW | 2.5 Litre)**

07.05 → 09.10	BPR		246-082-008-025G	SWP-M-C	
---------------	-----	--	------------------	---------	--

**PASSAT (32)****1.3 (40 kW | 1.3 Litre)**

05.73 → 12.76	FY	→327 2088 829	246-075-021-006C	SWP-M-G	Plug Number (T2): 1
05.73 → 01.78	ZA		246-075-021-006C	SWP-M-G	Plug Number (T2): 1
12.76 → 07.80	FY	327 2088 830→	246-082-008-014C	SWP-M-C	Plug Number (T2): 1
05.73 → 01.78	ZA		246-082-008-014C	SWP-M-C	Plug Number (T2): 1

**1.3 (44 kW | 1.3 Litre)**

05.73 → 12.76	ZF	→327 2088 829	246-075-021-006C	SWP-M-G	Plug Number (T2): 1
12.76 → 01.78	ZF	327 2088 830→	246-082-008-014C	SWP-M-C	Plug Number (T2): 1

**1.5 (55 kW | 1.5 Litre)**

07.73 → 12.75	YJ, ZB		246-075-021-006C	SWP-M-G	Plug Number (T2): 1
---------------	--------	--	------------------	---------	---------------------

**1.5 (63 kW | 1.5 Litre)**

05.73 → 12.75	ZC		246-075-021-006C	SWP-M-G	Plug Number (T2): 1
---------------	----	--	------------------	---------	---------------------

**1.5 D (37 kW | 1.5 Litre)**

08.77 → 07.80	CK		246-082-008-014C	SWP-M-C	Plug Number (T2): 1
---------------	----	--	------------------	---------	---------------------



			<b>VDO</b>		
Date	Engine Code	Chassis No.	Article No.	Product	Information

**VW****PASSAT (32)****1.6 (53 kW | 1.6 Litre)**

08.75 → 07.80 FS 246-082-008-014C SWP-M-C Plug Number (T2): 1

**1.6 (63 kW | 1.6 Litre)**

09.75 → 12.76 YP →327 2088 829 246-075-021-006C SWP-M-G Plug Number (T2): 1

12.76 → 07.80 YP 327 2088 830→ 246-082-008-014C SWP-M-C Plug Number (T2): 1

**PASSAT Variant (33)****1.3 (40 kW | 1.3 Litre)**

05.73 → 07.80 FY 246-075-021-006C SWP-M-G Plug Number (T2): 1

05.73 → 01.78 ZA 246-075-021-006C SWP-M-G Plug Number (T2): 1

**1.3 (44 kW | 1.3 Litre)**

10.73 → 01.78 ZF 246-075-021-006C SWP-M-G Plug Number (T2): 1

**1.5 (55 kW | 1.5 Litre)**

10.73 → 08.75 YJ, ZB 246-075-021-006C SWP-M-G Plug Number (T2): 1

**1.5 (63 kW | 1.5 Litre)**

10.73 → 12.75 ZC 246-075-021-006C SWP-M-G Plug Number (T2): 1

**1.5 D (37 kW | 1.5 Litre)**

02.77 → 07.80 CK 246-075-021-006C SWP-M-G Plug Number (T2): 1

**1.6 (55 kW | 1.6 Litre)**

08.77 → 07.80 YN 246-082-008-014C SWP-M-C Plug Number (T2): 1

**1.6 (63 kW | 1.6 Litre)**

08.75 → 07.80 YP 246-075-021-006C SWP-M-G Plug Number (T2): 1

**PASSAT (32B)****1.3 (40 kW | 1.3 Litre)**

08.82 → 07.83 X 16 XEL 246-082-008-014C SWP-M-C Plug Number (T2): 1

08.80 → 07.83 FY 246-086-001-007C HLWP Plug Number (T2): 3b; T26: X11-246-003-014

**1.3 (44 kW | 1.3 Litre)**

01.85 → 07.86 X 16 XEL 246-082-008-014C SWP-M-C Plug Number (T2): 1

08.80 → 07.86 EP, EU 246-082-008-014C SWP-M-C Plug Number (T2): 1

08.80 → 07.86 FZ 246-086-001-007C HLWP Plug Number (T2): 3b; T26: X11-246-003-014

08.80 → 07.86 EP, EU 246-086-001-007C HLWP Plug Number (T2): 3b

**1.6 (51 kW | 1.6 Litre)**

08.87 → 03.88 X 16 XEL 246-082-008-014C SWP-M-C Plug Number (T2): 1

08.87 → 03.88 PP 246-086-001-007C HLWP Plug Number (T2): 3b; T26: X11-246-003-014

**1.6 (53 kW | 1.6 Litre)**

02.86 → 03.88 RL 246-082-008-014C SWP-M-C Plug Number (T2): 1

02.86 → 03.88 RL 246-086-001-007C HLWP Plug Number (T2): 3b; T26: X11-246-003-014

**1.6 (55 kW | 1.6 Litre)**

08.80 → 03.88 DT 246-082-008-014C SWP-M-C Plug Number (T2): 1

08.80 → 03.88 WV, YN 246-086-001-007C HLWP Plug Number (T2): 3b; T26: X11-246-003-014

08.80 → 03.88 DT 246-086-001-007C HLWP Plug Number (T2): 3b

**1.6 (63 kW | 1.6 Litre)**

08.82 → 12.82 YP 246-082-008-014C SWP-M-C Plug Number (T2): 1

01.81 → 02.83 YP 246-086-001-007C HLWP Plug Number (T2): 3b; T26: X11-246-003-014

**1.6 D (40 kW | 1.6 Litre)**

01.85 → 03.88 CR, JK 246-082-008-014C SWP-M-C Plug Number (T2): 1

08.80 → 03.88 CR, JK 246-086-001-007C HLWP Plug Number (T2): 3b; T26: X11-246-003-014

**1.6 TD (51 kW | 1.6 Litre)**

04.82 → 03.88 CY 246-086-001-007C HLWP Plug Number (T2): 3b; T26: X11-246-003-014

**1.6 TD (59 kW | 1.6 Litre)**

05.86 → 03.88 RA 246-086-001-007C HLWP Plug Number (T2): 3b; T26: X11-246-003-014

**1.8 (64 kW | 1.8 Litre)**

05.86 → 03.88 RM 246-082-008-014C SWP-M-C Plug Number (T2): 1

05.86 → 03.88 RM 246-086-001-007C HLWP Plug Number (T2): 3b; T26: X11-246-003-014

**1.8 (66 kW | 1.8 Litre)**

01.83 → 03.88 DS, JN, JV 246-086-001-007C HLWP Plug Number (T2): 3b; T26: X11-246-003-014

**1.8 (82 kW | 1.8 Litre)**

12.83 → 03.88 DZ 246-086-001-007C HLWP Plug Number (T2): 3b; T26: X11-246-003-014

**1.9 (85 kW | 1.9 Litre)**

08.82 → 07.83 WN 246-082-008-014C SWP-M-C Plug Number (T2): 1

01.81 → 07.83 WN 246-086-001-007C HLWP Plug Number (T2): 3b; T26: X11-246-003-014



			<b>VDO</b>		
Date	Engine Code	Chassis No.	Article No.	Product	Information

**VW****PASSAT (32B)****2.0 (85 kW | 2.0 Litre)**

01.85 → 03.88	JS, HP		246-082-008-014C	SWP-M-C	Plug Number (T2): 1
08.83 → 03.88	JS, HP		246-086-001-007C	HLWP	Plug Number (T2): 3b; T26: X11-246-003-014

**2.1 (85 kW | 2.1 Litre)**

01.81 → 07.83	WE		246-086-001-007C	HLWP	Plug Number (T2): 3b; T26: X11-246-003-014
---------------	----	--	------------------	------	--------------------------------------------

**2.2 (100 kW | 2.2 Litre)**

01.85 → 03.88	KV		246-086-001-007C	HLWP	Plug Number (T2): 3b; T26: X11-246-003-014
---------------	----	--	------------------	------	--------------------------------------------

**2.2 (85 kW | 2.2 Litre)**

08.85 → 03.88	KX		246-082-008-014C	SWP-M-C	Plug Number (T2): 1
08.85 → 03.88	KX		246-086-001-007C	HLWP	Plug Number (T2): 3b; T26: X11-246-003-014

**PASSAT Saloon (32B)****1.6 (51 kW | 1.6 Litre)**

08.87 → 03.88	PP		246-082-008-014C	SWP-M-C	Plug Number (T2): 1
08.87 → 03.88	PP		246-086-001-007C	HLWP	Plug Number (T2): 3b; T26: X11-246-003-014

**1.6 (53 kW | 1.6 Litre)**

01.85 → 03.88	RL		246-086-001-007C	HLWP	Plug Number (T2): 3b; T26: X11-246-003-014
---------------	----	--	------------------	------	--------------------------------------------

**1.6 (55 kW | 1.6 Litre)**

01.85 → 03.88	DT		246-082-008-014C	SWP-M-C	Plug Number (T2): 1
01.85 → 03.88	DT		246-086-001-007C	HLWP	Plug Number (T2): 3b; T26: X11-246-003-014

**1.6 TD (51 kW | 1.6 Litre)**

01.85 → 03.88	CY		246-082-008-014C	SWP-M-C	Plug Number (T2): 1
01.85 → 03.88	CY		246-086-001-007C	HLWP	Plug Number (T2): 3b; T26: X11-246-003-014

**1.8 (64 kW | 1.8 Litre)**

05.86 → 03.88	RM		246-086-001-007C	HLWP	Plug Number (T2): 3b; T26: X11-246-003-014
---------------	----	--	------------------	------	--------------------------------------------

**1.8 (66 kW | 1.8 Litre)**

01.85 → 03.88	DS, JN		246-082-008-014C	SWP-M-C	Plug Number (T2): 1
01.85 → 03.88	DS, JN		246-086-001-007C	HLWP	Plug Number (T2): 3b; T26: X11-246-003-014

**2.2 (85 kW | 2.2 Litre)**

07.86 → 03.88	KX		246-082-008-014C	SWP-M-C	Plug Number (T2): 1
01.85 → 03.88	KX		246-086-001-007C	HLWP	Plug Number (T2): 3b; T26: X11-246-003-014

**PASSAT Variant (32B)****1.3 (40 kW | 1.3 Litre)**

08.81 → 07.83	FY		246-082-008-014C	SWP-M-C	Plug Number (T2): 1
---------------	----	--	------------------	---------	---------------------

**1.3 (44 kW | 1.3 Litre)**

08.83 → 07.86	FZ		246-082-008-014C	SWP-M-C	Plug Number (T2): 1
08.80 → 07.86	EP, EU		246-082-008-014C	SWP-M-C	Plug Number (T2): 1
08.80 → 07.86	EP, EU		246-086-001-007C	HLWP	Plug Number (T2): 3b

**1.6 (51 kW | 1.6 Litre)**

08.87 → 03.88	PP		246-086-001-007C	HLWP	Plug Number (T2): 3b; T26: X11-246-003-014
---------------	----	--	------------------	------	--------------------------------------------

**1.6 (53 kW | 1.6 Litre)**

02.86 → 03.88	RL		246-082-008-014C	SWP-M-C	Plug Number (T2): 1
03.87 → 03.88	RL		246-086-001-007C	HLWP	Plug Number (T2): 3b; T26: X11-246-003-014

**1.6 (55 kW | 1.6 Litre)**

08.81 → 07.86	VV, YN		246-082-008-014C	SWP-M-C	Plug Number (T2): 1
08.80 → 03.88	DT		246-082-008-014C	SWP-M-C	Plug Number (T2): 1
03.87 → 03.88	VV, YN		246-086-001-007C	HLWP	Plug Number (T2): 3b; T26: X11-246-003-014
08.80 → 03.88	DT		246-086-001-007C	HLWP	Plug Number (T2): 3b

**1.6 (63 kW | 1.6 Litre)**

08.81 → 12.82	YP		246-082-008-014C	SWP-M-C	Plug Number (T2): 1
---------------	----	--	------------------	---------	---------------------

**1.6 D (40 kW | 1.6 Litre)**

08.81 → 03.88	CR, JK		246-082-008-014C	SWP-M-C	Plug Number (T2): 1
03.87 → 03.88	CR, JK		246-086-001-007C	HLWP	Plug Number (T2): 3b; T26: X11-246-003-014

**1.6 TD (51 kW | 1.6 Litre)**

04.82 → 03.88	CY		246-082-008-014C	SWP-M-C	Plug Number (T2): 1
03.87 → 03.88	CY		246-086-001-007C	HLWP	Plug Number (T2): 3b; T26: X11-246-003-014

**1.8 (64 kW | 1.8 Litre)**

05.86 → 03.88	RM	→H - 175 000	246-082-008-014C	SWP-M-C	Plug Number (T2): 1
06.87 → 03.88	RM	H - 175 001→	246-083-002-006G	SWP-D-C	Plug Number (T2): 1
03.87 → 03.88	RM		246-086-001-007C	HLWP	Plug Number (T2): 3b; T26: X11-246-003-014

**1.8 (66 kW | 1.8 Litre)**

08.84 → 07.86	DS, JN, JV		246-082-008-014C	SWP-M-C	Plug Number (T2): 1
---------------	------------	--	------------------	---------	---------------------



			<b>VDO</b>		
Date	Engine Code	Chassis No.	Article No.	Product	Information

**VW****PASSAT Variant (32B)****1.8 (66 kW | 1.8 Litre)**

03.87 → 03.88	DS, JN, JV		246-086-001-007C	HLWP	Plug Number (T2): 3b; T26: X11-246-003-014
---------------	------------	--	------------------	------	--------------------------------------------

**1.8 (82 kW | 1.8 Litre)**

03.87 → 03.88	DZ		246-086-001-007C	HLWP	Plug Number (T2): 3b; T26: X11-246-003-014
---------------	----	--	------------------	------	--------------------------------------------

**1.8 Syncro (66 kW | 1.8 Litre)**

03.87 → 03.88	DS, JN		246-086-001-007C	HLWP	Plug Number (T2): 3b; T26: X11-246-003-014
---------------	--------	--	------------------	------	--------------------------------------------

**1.9 (85 kW | 1.9 Litre)**

08.81 → 07.83	WN		246-082-008-014C	SWP-M-C	Plug Number (T2): 1
---------------	----	--	------------------	---------	---------------------

**2.0 (85 kW | 2.0 Litre)**

08.84 → 03.88	JS, HP		246-082-008-014C	SWP-M-C	Plug Number (T2): 1
---------------	--------	--	------------------	---------	---------------------

03.87 → 03.88	JS, HP		246-086-001-007C	HLWP	Plug Number (T2): 3b; T26: X11-246-003-014
---------------	--------	--	------------------	------	--------------------------------------------

**2.0 Syncro (85 kW | 2.0 Litre)**

08.84 → 06.87	JS	→H - 175 000	246-082-008-014C	SWP-M-C	Plug Number (T2): 1
---------------	----	--------------	------------------	---------	---------------------

06.87 → 03.88	JS	H - 175 001→	246-083-002-006G	SWP-D-C	Plug Number (T2): 1
---------------	----	--------------	------------------	---------	---------------------

03.87 → 03.88	JS		246-086-001-007C	HLWP	Plug Number (T2): 3b; T26: X11-246-003-014
---------------	----	--	------------------	------	--------------------------------------------

**2.1 (85 kW | 2.1 Litre)**

01.81 → 07.83	WE		246-082-008-014C	SWP-M-C	Plug Number (T2): 1
---------------	----	--	------------------	---------	---------------------

01.81 → 07.83	WE		246-086-001-007C	HLWP	Plug Number (T2): 3b
---------------	----	--	------------------	------	----------------------

**2.2 (100 kW | 2.2 Litre)**

01.85 → 03.88	KV		246-082-008-014C	SWP-M-C	Plug Number (T2): 1
---------------	----	--	------------------	---------	---------------------

03.87 → 03.88	KV		246-086-001-007C	HLWP	Plug Number (T2): 3b; T26: X11-246-003-014
---------------	----	--	------------------	------	--------------------------------------------

**2.2 (85 kW | 2.2 Litre)**

08.85 → 03.88	KX		246-082-008-014C	SWP-M-C	Plug Number (T2): 1
---------------	----	--	------------------	---------	---------------------

03.87 → 03.88	KX		246-086-001-007C	HLWP	Plug Number (T2): 3b; T26: X11-246-003-014
---------------	----	--	------------------	------	--------------------------------------------

**2.2 Syncro (88 kW | 2.2 Litre)**

08.85 → 06.87	JT	→H - 175 000	246-082-008-014C	SWP-M-C	Plug Number (T2): 1
---------------	----	--------------	------------------	---------	---------------------

06.87 → 03.88	JT	H - 175 001→	246-083-002-006G	SWP-D-C	Plug Number (T2): 1
---------------	----	--------------	------------------	---------	---------------------

03.87 → 03.88	JT		246-086-001-007C	HLWP	Plug Number (T2): 3b; T26: X11-246-003-014
---------------	----	--	------------------	------	--------------------------------------------

**PASSAT (3A2, 35I)****1.6 (53 kW | 1.6 Litre)**

02.88 → 09.91	1F, EZ		246-069-056-001Z	N	
---------------	--------	--	------------------	---	--

04.88 → 09.91	1F, EZ		246-080-010-002Z	N-H	T24: CL →
---------------	--------	--	------------------	-----	-----------

08.88 → 07.90	1F, EZ		246-082-008-014C	SWP-M-C	Plug Number (T2): 1
---------------	--------	--	------------------	---------	---------------------

08.88 → 07.90	1F, EZ		246-086-001-007C	HLWP	Plug Number (T2): 3b; T26: X11-246-003-014
---------------	--------	--	------------------	------	--------------------------------------------

**1.6 (55 kW | 1.6 Litre)**

02.88 → 12.88	ABN, EZ		246-069-056-001Z	N	
---------------	---------	--	------------------	---	--

04.88 → 12.88	ABN, EZ		246-080-010-002Z	N-H	T24: CL →
---------------	---------	--	------------------	-----	-----------

02.88 → 12.88	ABN, EZ	→M - 400 000	246-082-008-014C	SWP-M-C	Plug Number (T2): 1
---------------	---------	--------------	------------------	---------	---------------------

04.88 → 12.88	ABN, EZ	→M - 400 000	246-086-001-007C	HLWP	Plug Number (T2): 3b; T26: X11-246-003-014
---------------	---------	--------------	------------------	------	--------------------------------------------

**1.6 (74 kW | 1.6 Litre)**

10.94 → 08.96	AEK, AFT		246-069-056-001Z	N	
---------------	----------	--	------------------	---	--

10.94 → 08.96	AEK, AFT		246-080-010-002Z	N-H	T24: CL →
---------------	----------	--	------------------	-----	-----------

10.94 → 11.95	AEK, AFT		246-082-008-021G	SWP-M-C	Plug Number (T2): 6
---------------	----------	--	------------------	---------	---------------------

10.94 → 08.96	AEK, AFT		246-082-008-025G	SWP-M-C	
---------------	----------	--	------------------	---------	--

10.94 → 11.95	AEK, AFT		246-083-002-014G	SWP-D-C	Plug Number (T2): 6
---------------	----------	--	------------------	---------	---------------------

10.94 → 11.95	AEK, AFT		246-086-001-002C	HLWP	Plug Number (T2): 3
---------------	----------	--	------------------	------	---------------------

10.94 → 08.96	AEK, AFT		246-086-001-007C	HLWP	Plug Number (T2): 3b; T26: X11-246-003-014
---------------	----------	--	------------------	------	--------------------------------------------

**1.6 TD (59 kW | 1.6 Litre)**

08.88 → 09.93	RA, SB		246-069-056-001Z	N	
---------------	--------	--	------------------	---	--

08.88 → 09.93	RA, SB		246-080-010-002Z	N-H	T24: CL →
---------------	--------	--	------------------	-----	-----------

08.88 → 07.91	RA, SB		246-082-008-014C	SWP-M-C	Plug Number (T2): 1
---------------	--------	--	------------------	---------	---------------------

08.91 → 09.93	RA, SB		246-082-008-021G	SWP-M-C	Plug Number (T2): 6
---------------	--------	--	------------------	---------	---------------------

08.91 → 09.93	RA, SB		246-086-001-002C	HLWP	Plug Number (T2): 3
---------------	--------	--	------------------	------	---------------------

08.88 → 07.91	RA, SB		246-086-001-007C	HLWP	Plug Number (T2): 3b; T26: X11-246-003-014
---------------	--------	--	------------------	------	--------------------------------------------

**1.8 (55 kW | 1.8 Litre)**

08.90 → 08.96	AAM		246-069-056-001Z	N	
---------------	-----	--	------------------	---	--

08.90 → 08.96	AAM		246-080-010-002Z	N-H	T24: CL →
---------------	-----	--	------------------	-----	-----------

08.90 → 08.91	AAM	→M - 400 000	246-082-008-014C	SWP-M-C	Plug Number (T2): 1
---------------	-----	--------------	------------------	---------	---------------------

08.91 → 08.96	AAM	N - 000 001→	246-082-008-021G	SWP-M-C	Plug Number (T2): 6
---------------	-----	--------------	------------------	---------	---------------------

10.93 → 08.96	AAM		246-083-002-014G	SWP-D-C	Plug Number (T2): 6
---------------	-----	--	------------------	---------	---------------------

08.91 → 08.96	AAM	N - 000 001→	246-086-001-002C	HLWP	Plug Number (T2): 3
---------------	-----	--------------	------------------	------	---------------------

08.90 → 08.91	AAM	→M - 400 000	246-086-001-007C	HLWP	Plug Number (T2): 3b; T26: X11-246-003-014
---------------	-----	--------------	------------------	------	--------------------------------------------



			<b>VDO</b>		
Date	Engine Code	Chassis No.	Article No.	Product	Information

**VW****PASSAT (3A2, 35I)****1.8 (66 kW | 1.8 Litre)**

02.88 - 08.96	ABS, RP, ADZ		246-069-056-001Z	N	
04.88 - 08.96	ABS, RP, ADZ		246-080-010-002Z	N-H	T24: CL →
04.88 - 08.91	ABS, RP, ADZ	→M - 400 000	246-082-008-014C	SWP-M-C	Plug Number (T2): 1
08.91 - 09.94	ABS, RP, ADZ	N - 000 001→	246-082-008-021G	SWP-M-C	Plug Number (T2): 6
10.93 - 09.94	ABS, RP, ADZ		246-083-002-014G	SWP-D-C	Plug Number (T2): 6
08.91 - 09.94	ABS, RP, ADZ	N - 000 001→	246-086-001-002C	HLWP	Plug Number (T2): 3
04.88 - 08.91	ABS, RP, ADZ	→M - 400 000	246-086-001-007C	HLWP	Plug Number (T2): 3b; T26: X11-246-003-014

**1.8 (79 kW | 1.8 Litre)**

04.88 - 07.93	PF		246-069-056-001Z	N	
04.88 - 07.93	PF		246-080-010-002Z	N-H	T24: CL →
04.88 - 07.90	PF		246-082-008-014C	SWP-M-C	Plug Number (T2): 1
04.88 - 07.90	PF		246-086-001-007C	HLWP	Plug Number (T2): 3b; T26: X11-246-003-014

**1.8 (82 kW | 1.8 Litre)**

04.88 - 07.92	PB		246-069-056-001Z	N	
04.88 - 07.92	PB		246-080-010-002Z	N-H	T24: CL →
04.88 - 07.90	PB		246-082-008-014C	SWP-M-C	Plug Number (T2): 1
04.88 - 07.90	PB		246-086-001-007C	HLWP	Plug Number (T2): 3b; T26: X11-246-003-014

**1.8 16V (100 kW | 1.8 Litre)**

04.88 - 12.89	KR		246-069-056-001Z	N	
04.88 - 12.89	KR		246-080-010-002Z	N-H	T24: CL →
04.88 - 12.89	KR	→M - 400 000	246-082-008-014C	SWP-M-C	Plug Number (T2): 1
04.88 - 12.89	KR	→M - 400 000	246-086-001-007C	HLWP	Plug Number (T2): 3b; T26: X11-246-003-014

**1.8 G60 Syncro (118 kW | 1.8 Litre)**

08.88 - 08.96	PG		246-069-056-001Z	N	
08.88 - 08.96	PG		246-080-010-002Z	N-H	T24: CL →
08.90 - 08.91	PG	→M - 500 000	246-082-008-014C	SWP-M-C	Plug Number (T2): 1
08.91 - 10.93	PG	N - 000 001→	246-082-008-021G	SWP-M-C	Plug Number (T2): 6
08.91 - 10.93	PG	N - 000 001→	246-086-001-002C	HLWP	Plug Number (T2): 3
08.91 - 08.96	PG		246-086-001-007C	HLWP	Plug Number (T2): 3b; T26: X11-246-003-014

**1.9 D (50 kW | 1.9 Litre)**

05.89 - 10.93	1Y		246-069-056-001Z	N	
05.89 - 10.93	1Y		246-080-010-002Z	N-H	T24: CL →
05.89 - 09.91	1Y	→M - 400 000	246-082-008-014C	SWP-M-C	Plug Number (T2): 1
08.91 - 10.93	1Y	N - 000 001→	246-082-008-021G	SWP-M-C	Plug Number (T2): 6
08.91 - 10.93	1Y	N - 000 001→	246-086-001-002C	HLWP	Plug Number (T2): 3
05.89 - 08.91	1Y	→M - 400 000	246-086-001-007C	HLWP	Plug Number (T2): 3b; T26: X11-246-003-014

**1.9 TD (55 kW | 1.9 Litre)**

03.91 - 08.96	AAZ		246-069-056-001Z	N	
03.91 - 08.96	AAZ		246-080-010-002Z	N-H	T24: CL →
03.91 - 08.91	AAZ	→M - 400 000	246-082-008-014C	SWP-M-C	Plug Number (T2): 1
08.91 - 08.96	AAZ	N - 000 001→	246-082-008-021G	SWP-M-C	Plug Number (T2): 6
10.93 - 08.96	AAZ		246-083-002-014G	SWP-D-C	Plug Number (T2): 6
08.91 - 08.96	AAZ	N - 000 001→	246-086-001-002C	HLWP	Plug Number (T2): 3
03.91 - 08.91	AAZ	→M - 400 000	246-086-001-007C	HLWP	Plug Number (T2): 3b; T26: X11-246-003-014

**1.9 TDI (66 kW | 1.9 Litre)**

10.93 - 08.96	1Z, AHU		246-069-056-001Z	N	
10.93 - 08.96	1Z, AHU		246-080-010-002Z	N-H	T24: CL →
10.93 - 07.96	1Z, AHU		246-082-008-021G	SWP-M-C	Plug Number (T2): 6
10.93 - 08.96	1Z, AHU		246-082-008-025G	SWP-M-C	
10.93 - 07.96	1Z, AHU		246-083-002-014G	SWP-D-C	Plug Number (T2): 6
10.93 - 07.96	1Z, AHU		246-086-001-002C	HLWP	Plug Number (T2): 3
10.93 - 08.96	1Z, AHU		246-086-001-007C	HLWP	Plug Number (T2): 3b; T26: X11-246-003-014

**1.9 TDI (81 kW | 1.9 Litre)**

03.96 - 08.96	AFN		246-069-056-001Z	N	
03.96 - 08.96	AFN		246-080-010-002Z	N-H	T24: CL →
03.96 - 08.96	AFN		246-082-008-021G	SWP-M-C	Plug Number (T2): 6
03.96 - 08.96	AFN		246-082-008-025G	SWP-M-C	
03.96 - 08.96	AFN		246-083-002-014G	SWP-D-C	Plug Number (T2): 6
03.96 - 08.96	AFN		246-086-001-002C	HLWP	Plug Number (T2): 3
03.96 - 08.96	AFN		246-086-001-007C	HLWP	Plug Number (T2): 3b; T26: X11-246-003-014

**2.0 (79 kW | 2.0 Litre)**

03.95 - 08.96	AEP		246-069-056-001Z	N	
---------------	-----	--	------------------	---	--



			<b>VDO</b>		
Date	Engine Code	Chassis No.	Article No.	Product	Information

**VW****PASSAT (3A2, 35I)****2.0 (79 kW | 2.0 Litre)**

03.95 - 08.96	AEP		246-080-010-002Z	N-H	T24: CL →
03.95 - 08.96	AEP		246-082-008-021G	SWP-M-C	Plug Number (T2): 6
03.95 - 08.96	AEP		246-082-008-025G	SWP-M-C	
03.95 - 08.96	AEP		246-083-002-014G	SWP-D-C	Plug Number (T2): 6
03.95 - 08.96	AEP		246-086-001-002C	HLWP	Plug Number (T2): 3
03.95 - 08.96	AEP		246-086-001-007C	HLWP	Plug Number (T2): 3b; T26: X11-246-003-014

**2.0 (85 kW | 2.0 Litre)**

02.90 - 08.96	2E, ADY, ABA, AGG		246-069-056-001Z	N	
02.90 - 08.96	2E, ADY, ABA, AGG		246-080-010-002Z	N-H	T24: CL →
02.90 - 09.91	2E, ADY, ABA, AGG	→M - 500 000	246-082-008-014C	SWP-M-C	Plug Number (T2): 1
08.91 - 09.94	2E, ADY, ABA, AGG	N - 000 001→	246-082-008-021G	SWP-M-C	Plug Number (T2): 6
10.93 - 09.94	2E, ADY, ABA, AGG		246-083-002-014G	SWP-D-C	Plug Number (T2): 6
08.91 - 09.94	2E, ADY, ABA, AGG	N - 000 001→	246-086-001-002C	HLWP	Plug Number (T2): 3
03.90 - 08.91	2E, ADY, ABA, AGG	→M - 400 000	246-086-001-007C	HLWP	Plug Number (T2): 3b; T26: X11-246-003-014

**2.0 16V (100 kW | 2.0 Litre)**

08.88 - 09.93	9A		246-069-056-001Z	N	
08.88 - 09.93	9A		246-080-010-002Z	N-H	T24: CL →
08.88 - 08.91	9A	→M - 400 000	246-082-008-014C	SWP-M-C	Plug Number (T2): 1
08.91 - 09.91	9A	N - 000 001→	246-082-008-021G	SWP-M-C	Plug Number (T2): 6
08.91 - 09.91	9A	N - 000 001→	246-086-001-002C	HLWP	Plug Number (T2): 3
08.88 - 08.91	9A	→M - 400 000	246-086-001-007C	HLWP	Plug Number (T2): 3b; T26: X11-246-003-014

**2.0 16V (110 kW | 2.0 Litre)**

01.94 - 08.96	ABF		246-069-056-001Z	N	
01.94 - 08.96	ABF		246-080-010-002Z	N-H	T24: CL →
01.94 - 08.96	ABF		246-082-008-021G	SWP-M-C	Plug Number (T2): 6
01.94 - 08.96	ABF		246-082-008-025G	SWP-M-C	
01.94 - 08.96	ABF		246-083-002-014G	SWP-D-C	Plug Number (T2): 6
01.94 - 08.96	ABF		246-086-001-002C	HLWP	Plug Number (T2): 3
01.94 - 08.96	ABF		246-086-001-007C	HLWP	Plug Number (T2): 3b; T26: X11-246-003-014

**2.0 Syncro (85 kW | 2.0 Litre)**

10.90 - 08.96	2E, AGG, ADY		246-069-056-001Z	N	
10.90 - 08.96	2E, AGG, ADY		246-080-010-002Z	N-H	T24: CL →
10.90 - 08.96	2E, AGG, ADY		246-083-002-022G	SWP-D-C	
08.91 - 08.96	2E, AGG, ADY		246-086-001-007C	HLWP	Plug Number (T2): 3b; T26: X11-246-003-014

**2.8 VR6 (128 kW | 2.8 Litre)**

06.91 - 08.96	AAA		246-069-056-001Z	N	
06.91 - 08.96	AAA		246-080-010-002Z	N-H	T24: CL →
06.91 - 08.91	X 12 XE	→M - 400 000	246-082-008-014C	SWP-M-C	Plug Number (T2): 1
08.91 - 08.96	AAA	N - 000 001→	246-082-008-021G	SWP-M-C	Plug Number (T2): 6
10.93 - 08.96	AAA		246-083-002-014G	SWP-D-C	Plug Number (T2): 6
08.91 - 08.96	AAA	N - 000 001→	246-086-001-002C	HLWP	Plug Number (T2): 3
06.91 - 08.91	AAA	→M - 400 000	246-086-001-007C	HLWP	Plug Number (T2): 3b; T26: X11-246-003-014

**PASSAT Variant (3A5, 35I)****1.6 (53 kW | 1.6 Litre)**

04.88 - 09.91	1F, EZ		246-069-056-001Z	N	
06.88 - 09.91	1F, EZ		246-080-010-002Z	N-H	T24: CL →
08.88 - 07.90	1F, EZ		246-083-002-014G	SWP-D-C	Plug Number (T2): 6
04.88 - 09.91	1F, EZ		246-083-002-022G	SWP-D-C	
08.88 - 07.90	1F, EZ		246-086-001-007C	HLWP	Plug Number (T2): 3b; T26: X11-246-003-014

**1.6 (55 kW | 1.6 Litre)**

04.88 - 12.88	EZ		246-069-056-001Z	N	
06.88 - 12.88	EZ		246-080-010-002Z	N-H	T24: CL →
04.88 - 12.88	EZ		246-083-002-014G	SWP-D-C	Plug Number (T2): 6
04.88 - 12.88	EZ		246-083-002-022G	SWP-D-C	
04.88 - 12.88	EZ	→M - 400 000	246-086-001-007C	HLWP	Plug Number (T2): 3b; T26: X11-246-003-014

**1.6 (74 kW | 1.6 Litre)**

07.94 - 12.95	AEK, AFT		246-069-056-001Z	N	
07.94 - 12.95	AEK, AFT		246-080-010-002Z	N-H	T24: CL →
07.94 - 12.95	AEK, AFT		246-082-008-025G	SWP-M-C	
10.94 - 11.95	AEK, AFT		246-083-002-014G	SWP-D-C	Plug Number (T2): 6
07.94 - 12.95	AEK, AFT		246-083-002-022G	SWP-D-C	



			<b>VDO</b>		
Date	Engine Code	Chassis No.	Article No.	Product	Information

**VW****PASSAT Variant (3A5, 35I)****1.6 (74 kW | 1.6 Litre)**

10.94 → 11.95	AEK, AFT		246-086-001-002C	HLWP	Plug Number (T2): 3
07.94 → 12.95	AEK, AFT	- N - 000 001→	246-086-001-007C	HLWP	Plug Number (T2): 3b; T26: X11-246-003-014

**1.6 TD (59 kW | 1.6 Litre)**

08.88 → 09.93	RA, SB		246-069-056-001Z	N	
08.88 → 09.93	RA, SB		246-080-010-002Z	N-H	T24: CL →
08.88 → 09.93	RA, SB		246-083-002-014G	SWP-D-C	Plug Number (T2): 6
08.88 → 09.93	RA, SB		246-083-002-022G	SWP-D-C	
08.88 → 08.91	RA, SB		246-086-001-007C	HLWP	Plug Number (T2): 3b; T26: X11-246-003-014

**1.8 (55 kW | 1.8 Litre)**

08.90 → 05.97	AAM		246-069-056-001Z	N	
08.90 → 05.97	AAM		246-080-010-002Z	N-H	T24: CL →
08.90 → 12.96	AAM		246-083-002-014G	SWP-D-C	Plug Number (T2): 6
08.90 → 05.97	AAM		246-083-002-022G	SWP-D-C	
08.91 → 12.96	AAM	N - 000 001→	246-086-001-002C	HLWP	Plug Number (T2): 3
08.90 → 08.91	AAM	→M - 400 000	246-086-001-007C	HLWP	Plug Number (T2): 3b; T26: X11-246-003-014

**1.8 (66 kW | 1.8 Litre)**

02.88 → 05.97	ABS, RP, ADZ		246-069-056-001Z	N	
06.88 → 05.97	ABS, RP, ADZ		246-080-010-002Z	N-H	T24: CL →
04.88 → 09.94	ABS, RP, ADZ		246-083-002-014G	SWP-D-C	Plug Number (T2): 6
02.88 → 05.97	ABS, RP, ADZ		246-083-002-022G	SWP-D-C	
08.91 → 09.94	ABS, RP, ADZ	N - 000 001→	246-086-001-002C	HLWP	Plug Number (T2): 3
04.88 → 08.91	ABS, RP, ADZ	→M - 400 000	246-086-001-007C	HLWP	Plug Number (T2): 3b; T26: X11-246-003-014

**1.8 (79 kW | 1.8 Litre)**

04.88 → 07.90	PF		246-069-056-001Z	N	
06.88 → 07.90	PF		246-080-010-002Z	N-H	T24: CL →
08.88 → 07.90	PF		246-083-002-014G	SWP-D-C	Plug Number (T2): 6
04.88 → 07.90	PF		246-083-002-022G	SWP-D-C	
08.88 → 07.90	PF		246-086-001-007C	HLWP	Plug Number (T2): 3b; T26: X11-246-003-014

**1.8 (82 kW | 1.8 Litre)**

04.88 → 07.92	PB		246-069-056-001Z	N	
06.88 → 07.92	PB		246-080-010-002Z	N-H	T24: CL →
04.88 → 07.92	PB		246-083-002-022G	SWP-D-C	

**1.8 16V (100 kW | 1.8 Litre)**

04.88 → 12.89	KR		246-069-056-001Z	N	
06.88 → 12.89	KR		246-080-010-002Z	N-H	T24: CL →
09.89 → 12.89	KR		246-083-002-006G	SWP-D-C	Plug Number (T2): 1
08.88 → 12.89	KR		246-083-002-014G	SWP-D-C	Plug Number (T2): 6
04.88 → 12.89	KR		246-083-002-022G	SWP-D-C	
08.88 → 12.89	KR	→M - 400 000	246-086-001-007C	HLWP	Plug Number (T2): 3b; T26: X11-246-003-014

**1.8 G60 Syncro (118 kW | 1.8 Litre)**

08.88 → 05.97	PG		246-069-056-001Z	N	
08.88 → 05.97	PG		246-080-010-002Z	N-H	T24: CL →
08.88 → 05.97	PG		246-083-002-022G	SWP-D-C	
08.91 → 05.97	PG	- N - 000 001→	246-086-001-007C	HLWP	Plug Number (T2): 3b; T26: X11-246-003-014

**1.9 D (50 kW | 1.9 Litre)**

05.89 → 10.93	1Y		246-069-056-001Z	N	
05.89 → 10.93	1Y		246-080-010-002Z	N-H	T24: CL →
05.89 → 07.90	1Y		246-083-002-014G	SWP-D-C	Plug Number (T2): 6
05.89 → 10.93	1Y		246-083-002-022G	SWP-D-C	
05.89 → 07.90	1Y		246-086-001-007C	HLWP	Plug Number (T2): 3b; T26: X11-246-003-014

**1.9 TD (55 kW | 1.9 Litre)**

03.91 → 05.97	AAZ		246-069-056-001Z	N	
03.91 → 05.97	AAZ		246-080-010-002Z	N-H	T24: CL →
03.91 → 12.96	AAZ		246-083-002-014G	SWP-D-C	Plug Number (T2): 6
03.91 → 05.97	AAZ		246-083-002-022G	SWP-D-C	
08.91 → 12.96	AAZ	N - 000 001→	246-086-001-002C	HLWP	Plug Number (T2): 3
03.91 → 08.91	AAZ	→M - 400 000	246-086-001-007C	HLWP	Plug Number (T2): 3b; T26: X11-246-003-014

**1.9 TDI (66 kW | 1.9 Litre)**

10.93 → 05.97	1Z, AHU		246-069-056-001Z	N	
10.93 → 05.97	1Z, AHU		246-080-010-002Z	N-H	T24: CL →
10.93 → 05.97	1Z, AHU		246-082-008-025G	SWP-M-C	
10.93 → 12.96	1Z, AHU		246-083-002-014G	SWP-D-C	Plug Number (T2): 6





			<b>VDO</b>		
Date	Engine Code	Chassis No.	Article No.	Product	Information

**VW****PASSAT Variant (3A5, 35I)****1.9 TDI (66 kW | 1.9 Litre)**

10.93 - 05.97	1Z, AHU		246-083-002-022G	SWP-D-C	
10.93 - 12.96	1Z, AHU		246-086-001-002C	HLWP	Plug Number (T2): 3
10.93 - 05.97	1Z, AHU	- N - 000 001→	246-086-001-007C	HLWP	Plug Number (T2): 3b; T26: X11-246-003-014

**1.9 TDI (81 kW | 1.9 Litre)**

03.96 - 05.97	AFN		246-069-056-001Z	N	
03.96 - 05.97	AFN		246-080-010-002Z	N-H	T24: CL →
03.96 - 05.97	AFN		246-082-008-025G	SWP-M-C	
03.96 - 12.96	AFN		246-083-002-014G	SWP-D-C	Plug Number (T2): 6
03.96 - 05.97	AFN		246-083-002-022G	SWP-D-C	
03.96 - 12.96	AFN		246-086-001-002C	HLWP	Plug Number (T2): 3
03.96 - 05.97	AFN	- N - 000 001→	246-086-001-007C	HLWP	Plug Number (T2): 3b; T26: X11-246-003-014

**2.0 (79 kW | 2.0 Litre)**

03.95 - 08.96	AEP		246-069-056-001Z	N	
03.95 - 08.96	AEP		246-080-010-002Z	N-H	T24: CL →
03.95 - 08.96	AEP		246-082-008-025G	SWP-M-C	
03.95 - 08.96	AEP		246-083-002-014G	SWP-D-C	Plug Number (T2): 6
03.95 - 08.96	AEP		246-083-002-022G	SWP-D-C	
03.95 - 08.96	AEP		246-086-001-002C	HLWP	Plug Number (T2): 3
03.95 - 08.96	AEP	- N - 000 001→	246-086-001-007C	HLWP	Plug Number (T2): 3b; T26: X11-246-003-014

**2.0 (85 kW | 2.0 Litre)**

02.90 - 05.97	2E, ADY, AGG		246-069-056-001Z	N	
02.90 - 05.97	2E, ADY, AGG		246-080-010-002Z	N-H	T24: CL →
10.93 - 10.96	2E, ADY, AGG		246-082-008-025G	SWP-M-C	
08.90 - 08.91	2E, ADY, AGG	→M - 500 000	246-083-002-006G	SWP-D-C	Plug Number (T2): 1
03.90 - 07.95	2E, ADY, AGG	N - 000 001→	246-083-002-014G	SWP-D-C	Plug Number (T2): 6
02.90 - 05.97	2E, ADY, AGG		246-083-002-022G	SWP-D-C	
10.93 - 10.96	2E, ADY, AGG		246-083-002-022G	SWP-D-C	
08.91 - 07.95	2E, ADY, AGG	N - 000 001→	246-086-001-002C	HLWP	Plug Number (T2): 3
03.90 - 08.91	2E, ADY, AGG		246-086-001-007C	HLWP	Plug Number (T2): 3b; T26: X11-246-003-014

**2.0 16V (100 kW | 2.0 Litre)**

08.88 - 09.93	9A		246-069-056-001Z	N	
08.88 - 09.93	9A		246-080-010-002Z	N-H	T24: CL →
08.88 - 09.91	9A		246-083-002-014G	SWP-D-C	Plug Number (T2): 6
08.88 - 09.93	9A		246-083-002-022G	SWP-D-C	
08.91 - 09.91	9A	N - 000 001→	246-086-001-002C	HLWP	Plug Number (T2): 3
08.88 - 08.91	9A	→M - 400 000	246-086-001-007C	HLWP	Plug Number (T2): 3b; T26: X11-246-003-014

**2.0 16V (110 kW | 2.0 Litre)**

01.94 - 05.97	ABF		246-069-056-001Z	N	
01.94 - 05.97	ABF		246-080-010-002Z	N-H	T24: CL →
01.94 - 05.97	ABF		246-082-008-025G	SWP-M-C	
01.94 - 12.96	ABF		246-083-002-014G	SWP-D-C	Plug Number (T2): 6
01.94 - 05.97	ABF		246-083-002-022G	SWP-D-C	
01.94 - 12.96	ABF		246-086-001-002C	HLWP	Plug Number (T2): 3
01.94 - 05.97	ABF	- N - 000 001→	246-086-001-007C	HLWP	Plug Number (T2): 3b; T26: X11-246-003-014

**2.0 Syncro (85 kW | 2.0 Litre)**

10.90 - 05.97	2E, ADY, AGG		246-069-056-001Z	N	
10.90 - 05.97	2E, ADY, AGG		246-080-010-002Z	N-H	T24: CL →
01.94 - 09.94	2E, ADY, AGG		246-083-002-014G	SWP-D-C	Plug Number (T2): 6
10.90 - 05.97	2E, ADY, AGG		246-083-002-022G	SWP-D-C	
01.94 - 09.94	2E, ADY, AGG		246-086-001-002C	HLWP	Plug Number (T2): 3
08.91 - 05.97	2E, ADY, AGG	- N - 000 001→	246-086-001-007C	HLWP	Plug Number (T2): 3b; T26: X11-246-003-014

**2.8 VR6 (128 kW | 2.8 Litre)**

06.91 - 05.97	AAA		246-069-056-001Z	N	
06.91 - 05.97	AAA		246-080-010-002Z	N-H	T24: CL →
06.91 - 12.96	AAA		246-083-002-014G	SWP-D-C	Plug Number (T2): 6
06.91 - 05.97	AAA		246-083-002-022G	SWP-D-C	
08.91 - 12.96	AAA	N - 000 001→	246-086-001-002C	HLWP	Plug Number (T2): 3
06.91 - 05.97	AAA	→M - 400 000	246-086-001-007C	HLWP	Plug Number (T2): 3b; T26: X11-246-003-014

**2.9 VR6 Syncro (135 kW | 2.9 Litre)**

01.94 - 05.97	ABV		246-069-056-001Z	N	
01.94 - 05.97	ABV		246-080-010-002Z	N-H	T24: CL →
01.94 - 05.97	ABV		246-082-008-025G	SWP-M-C	



			<b>VDO</b>		
Date	Engine Code	Chassis No.	Article No.	Product	Information

**VW****PASSAT Variant (3A5, 35I)****2.9 VR6 Syncro (135 kW | 2.9 Litre)**

01.94 - 05.97	ABV		246-083-002-014G	SWP-D-C	Plug Number (T2): 6
01.94 - 05.97	ABV		246-083-002-022G	SWP-D-C	
01.94 - 05.97	ABV		246-086-001-002C	HLWP	Plug Number (T2): 3
01.94 - 05.97	ABV	- N - 000 001 →	246-086-001-007C	HLWP	Plug Number (T2): 3b; T26: X11-246-003-014

**PASSAT (3B2)****1.6 (74 kW | 1.6 Litre)**

10.96 - 12.96	AHL, ANA, ARM, ADP		246-082-008-021G	SWP-M-C	Plug Number (T2): 6
10.96 - 11.00	ADP		246-082-008-025G	SWP-M-C	
10.96 - 12.96	AHL, ANA, ARM, ADP		246-083-002-014G	SWP-D-C	Plug Number (T2): 6
10.96 - 11.00	ADP		246-083-002-022G	SWP-D-C	
10.96 - 10.97	AHL, ANA, ARM, ADP		246-086-001-002C	HLWP	Plug Number (T2): 3
10.96 - 11.00	AHL, ANA, ARM, ADP		246-086-001-007C	HLWP	Plug Number (T2): 3b; T26: X11-246-003-014

**1.8 (85 kW | 1.8 Litre)**

01.97 - 11.00	AFY		246-082-008-025G	SWP-M-C	
01.97 - 11.00	AFY		246-086-001-007C	HLWP	Plug Number (T2): 3b; T26: X11-246-003-014

**1.8 (92 kW | 1.8 Litre)**

10.96 - 11.00	ADR		246-082-008-025G	SWP-M-C	
10.96 - 11.00	ADR		246-083-002-022G	SWP-D-C	
10.96 - 01.99	ADR, APT, ARG		246-086-001-002C	HLWP	Plug Number (T2): 3
10.96 - 11.00	ADR, APT, ARG		246-086-001-007C	HLWP	Plug Number (T2): 3b; T26: X11-246-003-014

**1.8 Syncro/4motion (92 kW | 1.8 Litre)**

10.96 - 11.00	ADR, APT, ARG	→3B-X-278 070	246-082-008-025G	SWP-M-C	
10.96 - 11.00	ADR, APT, ARG	→3B-X-278 070	246-083-002-022G	SWP-D-C	
10.96 - 11.00	ADR, APT, ARG		246-086-001-007C	HLWP	Plug Number (T2): 3b; T26: X11-246-003-014

**1.8 T (110 kW | 1.8 Litre)**

10.96 - 11.00	AEB, ANB, APU	→3B-X-278 070	246-082-008-025G	SWP-M-C	
10.96 - 11.00	AEB, ANB, APU	→3B-X-278 070	246-083-002-022G	SWP-D-C	
10.96 - 12.98	AEB, ANB, APU		246-086-001-002C	HLWP	Plug Number (T2): 3
10.96 - 11.00	AEB, ANB, APU		246-086-001-007C	HLWP	Plug Number (T2): 3b; T26: X11-246-003-014

**1.9 TDI (66 kW | 1.9 Litre)**

10.96 - 12.96	AHU, AHH		246-082-008-021G	SWP-M-C	Plug Number (T2): 6
10.96 - 12.96	AHU, AHH		246-083-002-014G	SWP-D-C	Plug Number (T2): 6
10.96 - 12.96	AHU, AHH		246-086-001-002C	HLWP	Plug Number (T2): 3
10.96 - 11.00	AHU, AHH		246-086-001-007C	HLWP	Plug Number (T2): 3b; T26: X11-246-003-014

**1.9 TDI (74 kW | 1.9 Litre)**

02.00 - 11.00	AVB		246-086-001-007C	HLWP	Plug Number (T2): 3b; T26: X11-246-003-014
---------------	-----	--	------------------	------	--------------------------------------------

**1.9 TDI (81 kW | 1.9 Litre)**

10.96 - 11.00	AFN, AVG		246-086-001-007C	HLWP	Plug Number (T2): 3b; T26: X11-246-003-014
---------------	----------	--	------------------	------	--------------------------------------------

**1.9 TDI (85 kW | 1.9 Litre)**

08.98 - 11.00	AJM, ATJ	3B-V-000 001 →	246-082-008-025G	SWP-M-C	
08.98 - 11.00	AJM, ATJ	3B-V-000 001 →	246-083-002-022G	SWP-D-C	
08.98 - 04.99	AJM, ATJ		246-086-001-002C	HLWP	Plug Number (T2): 3
08.98 - 11.00	AJM, ATJ		246-086-001-007C	HLWP	Plug Number (T2): 3b; T26: X11-246-003-014

**1.9 TDI 4motion (85 kW | 1.9 Litre)**

08.99 - 11.00	AJM, ATJ	3B-Y-350 001 →	246-082-008-025G	SWP-M-C	
08.99 - 11.00	AJM, ATJ	3B-Y-350 001 →	246-083-002-022G	SWP-D-C	
09.99 - 11.00	AJM, ATJ		246-086-001-002C	HLWP	Plug Number (T2): 3
08.99 - 11.00	AJM, ATJ		246-086-001-007C	HLWP	Plug Number (T2): 3b; T26: X11-246-003-014

**1.9 TDI Syncro/4motion (81 kW | 1.9 Litre)**

10.96 - 11.00	AFN, AVG		246-083-002-022G	SWP-D-C	
10.96 - 11.00	AFN, AVG		246-086-001-007C	HLWP	Plug Number (T2): 3b; T26: X11-246-003-014

**2.0 (88 kW | 2.0 Litre)**

04.00 - 11.00	ASU, AUZ		246-082-008-025G	SWP-M-C	T26: 1J0 955 665 H
04.00 - 11.00	ASU, AUZ		246-086-001-007C	HLWP	Plug Number (T2): 3b; T26: X11-246-003-014

**2.0 4motion (88 kW | 2.0 Litre)**

04.00 - 11.00	ASU		246-082-008-025G	SWP-M-C	T26: 1J0 955 665 H
04.00 - 11.00	ASU		246-086-001-007C	HLWP	Plug Number (T2): 3b; T26: X11-246-003-014

**2.3 VR5 (110 kW | 2.3 Litre)**

10.96 - 11.00	AGZ	→3B-X-278 070	246-082-008-025G	SWP-M-C	
10.96 - 11.00	AGZ	→3B-X-278 070	246-083-002-022G	SWP-D-C	
10.96 - 04.98	AGZ		246-086-001-002C	HLWP	Plug Number (T2): 3



			<b>VDO</b>		
Date	Engine Code	Chassis No.	Article No.	Product	Information

**VW****PASSAT (3B2)****2.3 VR5 (110 kW | 2.3 Litre)**

10.96 - 11.00	AGZ		246-086-001-007C	HLWP	Plug Number (T2): 3b; T26: X11-246-003-014
---------------	-----	--	------------------	------	--------------------------------------------

**2.3 VR5 Syncro/4motion (110 kW | 2.3 Litre)**

10.97 - 11.00	AGZ	-3B-X-278 070	246-082-008-025G	SWP-M-C	
10.97 - 11.00	AGZ	-3B-X-278 070	246-083-002-022G	SWP-D-C	
10.97 - 04.99	AGZ		246-086-001-002C	HLWP	Plug Number (T2): 3
10.97 - 11.00	AGZ		246-086-001-007C	HLWP	Plug Number (T2): 3b; T26: X11-246-003-014

**2.5 TDI (110 kW | 2.5 Litre)**

07.98 - 11.00	AFB, AKN	-3B-V-000 001	246-082-008-025G	SWP-M-C	
07.98 - 11.00	AFB, AKN	-3B-V-000 001	246-083-002-022G	SWP-D-C	
08.98 - 11.00	AFB, AKN		246-086-001-002C	HLWP	Plug Number (T2): 3
07.98 - 11.00	AFB, AKN		246-086-001-007C	HLWP	Plug Number (T2): 3b; T26: X11-246-003-014

**2.5 TDI Syncro/4motion (110 kW | 2.5 Litre)**

04.99 - 11.00	AFB, AKN		246-082-008-025G	SWP-M-C	
04.99 - 11.00	AFB, AKN		246-083-002-022G	SWP-D-C	
02.99 - 04.99	AFB, AKN		246-086-001-002C	HLWP	Plug Number (T2): 3
12.98 - 11.00	AFB, AKN		246-086-001-007C	HLWP	Plug Number (T2): 3b; T26: X11-246-003-014

**2.8 V6 (132 kW | 2.8 Litre)**

05.97 - 09.99	AGE		246-086-001-007C	HLWP	Plug Number (T2): 3b; T26: X11-246-003-014
---------------	-----	--	------------------	------	--------------------------------------------

**2.8 V6 (140 kW | 2.8 Litre)**

09.99 - 11.00	ATX, BBG		246-086-001-007C	HLWP	Plug Number (T2): 3b; T26: X11-246-003-014
---------------	----------	--	------------------	------	--------------------------------------------

**2.8 V6 (142 kW | 2.8 Litre)**

08.96 - 11.00	ACK		246-082-008-025G	SWP-M-C	
08.96 - 11.00	ACK		246-083-002-022G	SWP-D-C	
06.97 - 04.99	ACK, APR, AQD		246-086-001-002C	HLWP	Plug Number (T2): 3
08.96 - 11.00	ACK, APR, AQD		246-086-001-007C	HLWP	Plug Number (T2): 3b; T26: X11-246-003-014

**2.8 V6 4motion (140 kW | 2.8 Litre)**

09.99 - 11.00	ATX		246-086-001-007C	HLWP	Plug Number (T2): 3b; T26: X11-246-003-014
---------------	-----	--	------------------	------	--------------------------------------------

**2.8 V6 Syncro/4motion (142 kW | 2.8 Litre)**

10.96 - 11.00	ACK, ALG, APR, AQD	-3B-X-278 070	246-082-008-025G	SWP-M-C	
10.96 - 11.00	ACK, ALG, APR, AQD	-3B-X-278 070	246-083-002-022G	SWP-D-C	
01.97 - 09.99	ACK, ALG, APR, AQD		246-086-001-002C	HLWP	Plug Number (T2): 3
10.96 - 11.00	ACK, ALG, APR, AQD		246-086-001-007C	HLWP	Plug Number (T2): 3b; T26: X11-246-003-014

**PASSAT Variant (3B5)****1.6 (74 kW | 1.6 Litre)**

06.97 - 11.00	AHL, ANA, ARM, ADP	-3B-X-278 070	246-082-008-025G	SWP-M-C	
06.97 - 11.00	AHL, ANA, ARM, ADP	-3B-X-278 070	246-083-002-022G	SWP-D-C	
06.97 - 05.99	AHL, ANA, ARM, ADP		246-086-001-002C	HLWP	Plug Number (T2): 3

**1.8 (85 kW | 1.8 Litre)**

06.97 - 11.00	AFY		246-082-008-025G	SWP-M-C	
06.97 - 11.00	AFY		246-083-002-022G	SWP-D-C	

**1.8 (92 kW | 1.8 Litre)**

06.97 - 11.00	ADR, APT, ARG	-3B-X-278 070	246-082-008-025G	SWP-M-C	
06.97 - 11.00	ADR, APT, ARG	-3B-X-278 070	246-083-002-022G	SWP-D-C	
06.97 - 12.98	ADR, APT, ARG		246-086-001-002C	HLWP	Plug Number (T2): 3

**1.8 Syncro/4motion (92 kW | 1.8 Litre)**

06.97 - 11.00	ADR		246-082-008-025G	SWP-M-C	
06.97 - 11.00	ADR		246-083-002-022G	SWP-D-C	
08.97 - 01.99	ADR, APT, ARG		246-086-001-002C	HLWP	Plug Number (T2): 3

**1.8 T (110 kW | 1.8 Litre)**

06.97 - 11.00	AEB		246-082-008-025G	SWP-M-C	
06.97 - 11.00	AEB		246-083-002-022G	SWP-D-C	
06.97 - 12.98	AEB, ANB, APU		246-086-001-002C	HLWP	Plug Number (T2): 3

**1.9 TDI (66 kW | 1.9 Litre)**

06.97 - 11.00	AHU, AHH	3B-V-000 001 →	246-082-008-025G	SWP-M-C	
06.97 - 11.00	AHU, AHH	3B-V-000 001 →	246-083-002-022G	SWP-D-C	
06.97 - 08.98	AHU, AHH		246-086-001-002C	HLWP	Plug Number (T2): 3

**1.9 TDI (74 kW | 1.9 Litre)**

02.00 - 11.00	AVB		246-082-008-025G	SWP-M-C	
02.00 - 11.00	AVB		246-083-002-022G	SWP-D-C	

**1.9 TDI (81 kW | 1.9 Litre)**

06.97 - 11.00	AFN		246-082-008-025G	SWP-M-C	
---------------	-----	--	------------------	---------	--



			<b>VDO</b>		
Date	Engine Code	Chassis No.	Article No.	Product	Information

**VW****PASSAT Variant (3B5)****1.9 TDI (81 kW | 1.9 Litre)**

06.97 - 11.00	AFN		246-083-002-022G	SWP-D-C	
06.97 - 04.99	AFN, AVG		246-086-001-002C	HLWP	Plug Number (T2): 3

**1.9 TDI (85 kW | 1.9 Litre)**

08.98 - 11.00	AJM, ATJ	-3B-W-500 000	246-082-008-025G	SWP-M-C	
08.98 - 11.00	AJM, ATJ	-3B-W-500 000	246-083-002-022G	SWP-D-C	
08.98 - 11.00	AJM, ATJ		246-086-001-002C	HLWP	Plug Number (T2): 3

**1.9 TDI 4motion (85 kW | 1.9 Litre)**

08.99 - 11.00	ATJ	3B-Y-350 001→	246-082-008-025G	SWP-M-C	
08.99 - 11.00	ATJ	3B-Y-350 001→	246-083-002-022G	SWP-D-C	
09.99 - 11.00	ATJ		246-086-001-002C	HLWP	Plug Number (T2): 3

**1.9 TDI Syncro/4motion (81 kW | 1.9 Litre)**

06.97 - 11.00	AFN		246-082-008-025G	SWP-M-C	
06.97 - 11.00	AFN		246-083-002-022G	SWP-D-C	

**2.0 (88 kW | 2.0 Litre)**

04.00 - 11.00	ASU, AUZ		246-082-008-025G	SWP-M-C	T26: 1J0 955 665 H
04.00 - 11.00	ASU, AUZ		246-083-002-022G	SWP-D-C	T26: 1J0 955 665 H

**2.0 4motion (88 kW | 2.0 Litre)**

04.00 - 11.00	ASU		246-082-008-025G	SWP-M-C	
04.00 - 11.00	ASU		246-083-002-022G	SWP-D-C	

**2.3 VR5 (110 kW | 2.3 Litre)**

06.97 - 11.00	AGZ	-3B-X-278 070	246-082-008-025G	SWP-M-C	
06.97 - 11.00	AGZ	-3B-X-278 070	246-083-002-022G	SWP-D-C	
06.97 - 04.98	AGZ		246-086-001-002C	HLWP	Plug Number (T2): 3

**2.3 VR5 Syncro/4motion (110 kW | 2.3 Litre)**

10.97 - 11.00	AGZ	-3B-X-278 070	246-082-008-025G	SWP-M-C	
10.97 - 11.00	AGZ	-3B-X-278 070	246-083-002-022G	SWP-D-C	
10.97 - 04.99	AGZ		246-086-001-002C	HLWP	Plug Number (T2): 3

**2.5 TDI (110 kW | 2.5 Litre)**

07.98 - 11.00	AFB		246-082-008-025G	SWP-M-C	
07.98 - 11.00	AFB		246-083-002-022G	SWP-D-C	
08.98 - 11.00	AFB, AKN		246-086-001-002C	HLWP	Plug Number (T2): 3

**2.5 TDI Syncro/4motion (110 kW | 2.5 Litre)**

12.98 - 11.00	AFB, AKN		246-082-008-025G	SWP-M-C	T26: 1J0 955 665 H
12.98 - 11.00	AFB, AKN		246-083-002-022G	SWP-D-C	T26: 1J0 955 665 H
05.99 - 11.00	AFB, AKN		246-086-001-002C	HLWP	Plug Number (T2): 3

**2.8 V6 (132 kW | 2.8 Litre)**

09.97 - 09.99	AGE	-3B-X-278 070	246-082-008-025G	SWP-M-C	
09.97 - 09.99	AGE	-3B-X-278 070	246-083-002-022G	SWP-D-C	

**2.8 V6 (140 kW | 2.8 Litre)**

09.99 - 11.00	ATX		246-082-008-025G	SWP-M-C	T26: 1J0 955 665 H
09.99 - 11.00	ATX		246-083-002-022G	SWP-D-C	T26: 1J0 955 665 H

**2.8 V6 (142 kW | 2.8 Litre)**

06.97 - 11.00	ACK, APR, AQD	-3B-X-278 070	246-082-008-025G	SWP-M-C	
06.97 - 11.00	ACK, APR, AQD	-3B-X-278 070	246-083-002-022G	SWP-D-C	
08.97 - 12.98	ACK, APR, AQD		246-086-001-002C	HLWP	Plug Number (T2): 3

**2.8 V6 4motion (140 kW | 2.8 Litre)**

09.99 - 11.00	ATX		246-082-008-025G	SWP-M-C	
09.99 - 11.00	ATX		246-083-002-022G	SWP-D-C	

**2.8 V6 Syncro/4motion (142 kW | 2.8 Litre)**

06.97 - 11.00	ACK, ALG, APR, AQD	-3B-X-278 070	246-082-008-025G	SWP-M-C	
06.97 - 11.00	ACK, ALG, APR, AQD	-3B-X-278 070	246-083-002-022G	SWP-D-C	
06.97 - 09.99	ACK, ALG, APR, AQD		246-086-001-002C	HLWP	Plug Number (T2): 3

**PASSAT (3B3)****1.6 (75 kW | 1.6 Litre)**

11.00 - 05.05	ALZ	-3B-5-250 000	246-082-008-025G	SWP-M-C	
11.00 - 05.05	ALZ		246-086-001-007C	HLWP	Plug Number (T2): 3b; T26: X11-246-003-014

**1.8 T (125 kW | 1.8 Litre)**

02.01 - 05.05	AWM	-3B-5-250 000	246-082-008-025G	SWP-M-C	
02.01 - 05.05	AWM		246-086-001-007C	HLWP	Plug Number (T2): 3b; T26: X11-246-003-014

**1.8 T 20V (110 kW | 1.8 Litre)**

11.00 - 05.05	AWT, AWL	-3B-5-250 000	246-082-008-025G	SWP-M-C	
---------------	----------	---------------	------------------	---------	--



			<b>VDO</b>		
Date	Engine Code	Chassis No.	Article No.	Product	Information

**VW****PASSAT (3B3)****1.8 T 20V (110 kW | 1.8 Litre)**

11.00 → 05.05	AWT, AWL	→3B-5-250 000	246-083-002-022G	SWP-D-C	
11.00 → 05.05	AWT, AWL		246-086-001-007C	HLWP	Plug Number (T2): 3b; T26: X11-246-003-014

**1.9 TDI (74 kW | 1.9 Litre)**

11.00 → 05.05	AVB	→3B-5-250 000	246-082-008-025G	SWP-M-C	
11.00 → 05.05	AVB		246-086-001-007C	HLWP	Plug Number (T2): 3b; T26: X11-246-003-014

**1.9 TDI (96 kW | 1.9 Litre)**

11.00 → 05.05	AVF, AWX	→3B-5-250 000	246-082-008-025G	SWP-M-C	
11.00 → 05.05	AVF, AWX		246-086-001-007C	HLWP	Plug Number (T2): 3b; T26: X11-246-003-014

**1.9 TDI 4motion (96 kW | 1.9 Litre)**

11.00 → 05.05	AVF	→3B-5-250 000	246-082-008-025G	SWP-M-C	
11.00 → 05.05	AVF		246-086-001-007C	HLWP	Plug Number (T2): 3b; T26: X11-246-003-014

**2.0 (85 kW | 2.0 Litre)**

11.00 → 05.05	AZM, BFF	→3B-5-250 000	246-082-008-025G	SWP-M-C	
11.00 → 05.05	AZM, BFF		246-086-001-007C	HLWP	Plug Number (T2): 3b; T26: X11-246-003-014

**2.0 (96 kW | 2.0 Litre)**

11.01 → 05.05	ALT	→3B-5-250 000	246-082-008-025G	SWP-M-C	
11.01 → 05.05	ALT		246-086-001-007C	HLWP	Plug Number (T2): 3b; T26: X11-246-003-014

**2.0 4motion (85 kW | 2.0 Litre)**

11.00 → 05.05	AZM	→3B-5-250 000	246-082-008-025G	SWP-M-C	
11.00 → 05.05	AZM		246-086-001-007C	HLWP	Plug Number (T2): 3b; T26: X11-246-003-014

**2.0 TDI (100 kW | 2.0 Litre)**

12.03 → 05.05	BGW, BHW	→3B-5-250 000	246-082-008-025G	SWP-M-C	
12.03 → 05.05	BGW, BHW	→3B-5-250 000	246-083-002-022G	SWP-D-C	

**2.3 V5 (125 kW | 2.3 Litre)**

11.00 → 05.05	AZX	→3B-5-250 000	246-082-008-025G	SWP-M-C	
11.00 → 05.05	AZX		246-086-001-007C	HLWP	Plug Number (T2): 3b; T26: X11-246-003-014

**2.3 V5 4motion (125 kW | 2.3 Litre)**

11.00 → 05.05	AZX	→3B-5-250 000	246-082-008-025G	SWP-M-C	
11.00 → 05.05	AZX		246-086-001-007C	HLWP	Plug Number (T2): 3b; T26: X11-246-003-014

**2.5 TDI (110 kW | 2.5 Litre)**

11.00 → 05.05	AKN, AFB	3B-V-000 001→	246-082-008-025G	SWP-M-C	
11.00 → 05.05	AKN, AFB		246-086-001-007C	HLWP	Plug Number (T2): 3b; T26: X11-246-003-014

**2.5 TDI (120 kW | 2.5 Litre)**

05.03 → 05.05	BDG		246-082-008-025G	SWP-M-C	
---------------	-----	--	------------------	---------	--

**2.5 TDI 4motion (110 kW | 2.5 Litre)**

11.00 → 05.05	AKN, AFB	-3-450 001→	246-082-008-025G	SWP-M-C	
11.00 → 05.05	AKN, AFB		246-086-001-007C	HLWP	Plug Number (T2): 3b; T26: X11-246-003-014

**2.5 TDI 4motion (132 kW | 2.5 Litre)**

01.03 → 05.05	BAU, BDH	-3-450 001→	246-082-008-025G	SWP-M-C	
---------------	----------	-------------	------------------	---------	--

**2.8 (142 kW | 2.8 Litre)**

05.02 → 05.03	AMX, ATQ		246-082-008-025G	SWP-M-C	T26: 1J0 955 665 H
---------------	----------	--	------------------	---------	--------------------

**2.8 4motion (142 kW | 2.8 Litre)**

11.00 → 05.05	AMX, ATQ	→3B-5-250 000	246-082-008-025G	SWP-M-C	
11.00 → 05.05	AMX, ATQ	→3B-5-250 000	246-083-002-022G	SWP-D-C	
11.00 → 05.05	AMX, ATQ		246-086-001-007C	HLWP	Plug Number (T2): 3b; T26: X11-246-003-014

**4.0 W8 4motion (202 kW | 4.0 Litre)**

09.01 → 05.05	BDN, BDP	→3B-5-250 000	246-082-008-025G	SWP-M-C	
09.01 → 05.05	BDN, BDP		246-086-001-007C	HLWP	Plug Number (T2): 3b; T26: X11-246-003-014

**PASSAT Variant (3B6)****1.6 (75 kW | 1.6 Litre)**

11.00 → 05.05	ALZ	→3B-5-250 000	246-082-008-025G	SWP-M-C	
11.00 → 05.05	ALZ	→3B-5-250 000	246-083-002-022G	SWP-D-C	

**1.8 T 20V (110 kW | 1.8 Litre)**

11.00 → 05.05	AWT	→3B-5-250 000	246-082-008-025G	SWP-M-C	
11.00 → 05.05	AWT	→3B-5-250 000	246-083-002-022G	SWP-D-C	

**1.9 TDI (74 kW | 1.9 Litre)**

11.00 → 05.05	AVB		246-082-008-025G	SWP-M-C	
11.00 → 05.05	AVB		246-083-002-022G	SWP-D-C	

**1.9 TDI (96 kW | 1.9 Litre)**

11.00 → 05.05	AVF, AWX		246-082-008-025G	SWP-M-C	
11.00 → 05.05	AVF, AWX		246-083-002-022G	SWP-D-C	



			<b>VDO</b>		
Date	Engine Code	Chassis No.	Article No.	Product	Information

**VW****PASSAT Variant (3B6)****1.9 TDI 4motion (96 kW | 1.9 Litre)**

11.00 - 05.05	AVF		246-082-008-025G	SWP-M-C	
11.00 - 05.05	AVF		246-083-002-022G	SWP-D-C	

**2.0 (85 kW | 2.0 Litre)**

11.00 - 05.05	AZM	-3B-5-250 000	246-082-008-025G	SWP-M-C	
11.00 - 05.05	AZM	-3B-5-250 000	246-083-002-022G	SWP-D-C	

**2.0 (96 kW | 2.0 Litre)**

11.01 - 05.05	ALT	-3B-5-250 000	246-082-008-025G	SWP-M-C	
11.01 - 05.05	ALT	-3B-5-250 000	246-083-002-022G	SWP-D-C	

**2.0 4motion (85 kW | 2.0 Litre)**

11.00 - 05.05	AZM	-3B-5-250 000	246-082-008-025G	SWP-M-C	
11.00 - 05.05	AZM	-3B-5-250 000	246-083-002-022G	SWP-D-C	

**2.0 TDI (100 kW | 2.0 Litre)**

12.03 - 05.05	BGW, BHW		246-082-008-025G	SWP-M-C	T26: 1J0 955 665 H
12.03 - 05.05	BGW, BHW		246-083-002-022G	SWP-D-C	T26: 1J0 955 665 H

**2.3 VR5 (125 kW | 2.3 Litre)**

11.00 - 05.05	AZX	-3B-5-250 000	246-082-008-025G	SWP-M-C	
11.00 - 05.05	AZX	-3B-5-250 000	246-083-002-022G	SWP-D-C	

**2.3 VR5 4motion (125 kW | 2.3 Litre)**

11.00 - 05.05	AZX	-3B-5-250 000	246-082-008-025G	SWP-M-C	
11.00 - 05.05	AZX	-3B-5-250 000	246-083-002-022G	SWP-D-C	

**2.5 TDI (110 kW | 2.5 Litre)**

11.00 - 05.05	AFB		246-082-008-025G	SWP-M-C	
11.00 - 05.05	AFB		246-083-002-022G	SWP-D-C	

**2.5 TDI (120 kW | 2.5 Litre)**

05.03 - 05.05	BDG		246-082-008-025G	SWP-M-C	
05.03 - 05.05	BDG		246-083-002-022G	SWP-D-C	

**2.5 TDI 4motion (110 kW | 2.5 Litre)**

11.00 - 05.05	AFB		246-082-008-025G	SWP-M-C	
11.00 - 05.05	AFB		246-083-002-022G	SWP-D-C	

**2.5 TDI 4motion (132 kW | 2.5 Litre)**

01.03 - 05.05	BAU		246-082-008-025G	SWP-M-C	
01.03 - 05.05	BAU		246-083-002-022G	SWP-D-C	

**2.8 4motion (142 kW | 2.8 Litre)**

11.00 - 05.05	AMX, ATQ	-3B-5-250 000	246-082-008-025G	SWP-M-C	
11.00 - 05.05	AMX, ATQ	-3B-5-250 000	246-083-002-022G	SWP-D-C	

**4.0 W8 4motion (202 kW | 4.0 Litre)**

09.01 - 05.05	BDN, BDP	-3B-5-250 000	246-082-008-025G	SWP-M-C	
09.01 - 05.05	BDN, BDP	-3B-5-250 000	246-083-002-022G	SWP-D-C	

**PASSAT (3C2)****1.4 TSI (90 kW | 1.4 Litre)**

05.07 - 07.10	CAXA		246-082-008-025G	SWP-M-C	
05.07 - 07.10	CAXA		246-083-002-022G	SWP-D-C	
05.07 - 07.10	CAXA		246-086-001-007C	HLWP	Plug Number (T2): 3b

**1.4 TSI EcoFuel (110 kW | 1.4 Litre)**

01.09 - 07.10	CDGA	3C-B-050 000→	246-082-008-025G	SWP-M-C	
01.09 - 07.10	CDGA	3C-B-050 000→	246-083-002-022G	SWP-D-C	
01.09 - 07.10	CDGA	3C-B-050 000→	246-086-001-007C	HLWP	Plug Number (T2): 3b

**1.6 (75 kW | 1.6 Litre)**

05.05 - 07.10	BSE, BSF		246-082-008-025G	SWP-M-C	
05.05 - 07.10	BSE, BSF		246-083-002-022G	SWP-D-C	
05.05 - 07.10	BSE, BSF		246-086-001-007C	HLWP	Plug Number (T2): 3b

**1.6 FSI (85 kW | 1.6 Litre)**

03.05 - 06.08	BLF		246-082-008-025G	SWP-M-C	
03.05 - 06.08	BLF		246-083-002-022G	SWP-D-C	
03.05 - 06.08	BLF		246-086-001-007C	HLWP	Plug Number (T2): 3b

**1.6 TDI (77 kW | 1.6 Litre)**

08.09 - 07.10	CAYC	3C-B-050 000→	246-082-008-025G	SWP-M-C	
08.09 - 07.10	CAYC	3C-B-050 000→	246-083-002-022G	SWP-D-C	
08.09 - 07.10	CAYC	3C-B-050 000→	246-086-001-007C	HLWP	Plug Number (T2): 3b

**1.8 TSI (112 kW | 1.8 Litre)**

11.09 - 07.10	CDAB, CGYA	3C-B-050 000→	246-082-008-025G	SWP-M-C	
---------------	------------	---------------	------------------	---------	--



			<b>VDO</b>		
Date	Engine Code	Chassis No.	Article No.	Product	Information

**VW****PASSAT (3C2)****1.8 TSI (112 kW | 1.8 Litre)**

11.09 → 07.10	CDAB, CGYA	3C-B-050 000→	246-083-002-022G	SWP-D-C	
11.09 → 07.10	CDAB, CGYA	3C-B-050 000→	246-086-001-007C	HLWP	Plug Number (T2): 3b

**1.8 TSI (118 kW | 1.8 Litre)**

05.07 → 07.10	BZB, CDAA		246-082-008-025G	SWP-M-C	
05.07 → 07.10	BZB, CDAA		246-083-002-022G	SWP-D-C	
05.07 → 07.10	BZB, CDAA		246-086-001-007C	HLWP	Plug Number (T2): 3b

**1.9 TDI (77 kW | 1.9 Litre)**

03.05 → 11.08	BKC, BLS, BXE		246-082-008-025G	SWP-M-C	
03.05 → 11.08	BKC, BLS, BXE		246-083-002-022G	SWP-D-C	
03.05 → 11.08	BKC, BXE, BLS		246-086-001-007C	HLWP	Plug Number (T2): 3b

**2.0 BlueTDI (105 kW | 2.0 Litre)**

01.09 →	CBAC	3C-B-050 000→	246-082-008-025G	SWP-M-C	
01.09 →	CBAC	3C-B-050 000→	246-083-002-022G	SWP-D-C	
01.09 →	CBAC	3C-B-050 000→	246-086-001-007C	HLWP	Plug Number (T2): 3b

**2.0 FSI (110 kW | 2.0 Litre)**

03.05 → 07.10	BLR, BLY, BVY, BVZ		246-082-008-025G	SWP-M-C	
03.05 → 07.10	BLR, BLY, BVY, BVZ		246-083-002-022G	SWP-D-C	
03.05 → 07.10	BLR, BLY, BVY, BVZ		246-086-001-007C	HLWP	Plug Number (T2): 3b

**2.0 FSI (147 kW | 2.0 Litre)**

07.05 → 07.10	AXX, BPY, BWA, CAWB, CBFA, CCTA, CCZA		246-082-008-025G	SWP-M-C	
07.05 → 07.10	AXX, BPY, BWA, CAWB, CBFA, CCTA, CCZA		246-083-002-022G	SWP-D-C	
07.05 → 07.10	AXX, BPY, BWA, CAWB, CBFA, CCTA, CCZA		246-086-001-007C	HLWP	Plug Number (T2): 3b

**2.0 FSI 4motion (110 kW | 2.0 Litre)**

09.05 → 07.10	BLX, BLY, BVX		246-082-008-025G	SWP-M-C	
09.05 → 07.10	BLX, BLY, BVX		246-083-002-022G	SWP-D-C	
09.05 → 07.10	BLX, BLY, BVX		246-086-001-007C	HLWP	Plug Number (T2): 3b

**2.0 TDI (100 kW | 2.0 Litre)**

03.05 → 11.10	BMA, CBAA		246-082-008-025G	SWP-M-C	
03.05 → 11.10	BMA, CBAA		246-083-002-022G	SWP-D-C	
03.05 → 11.10	BMA, CBAA		246-086-001-007C	HLWP	Plug Number (T2): 3b

**2.0 TDI (103 kW | 2.0 Litre)**

03.05 →	BMP		246-082-008-025G	SWP-M-C	
03.05 →	BMP		246-083-002-022G	SWP-D-C	
03.05 →	BMP		246-086-001-007C	HLWP	Plug Number (T2): 3b

**2.0 TDI (120 kW | 2.0 Litre)**

08.05 →	BUZ		246-082-008-025G	SWP-M-C	
08.05 →	BUZ		246-083-002-022G	SWP-D-C	
08.05 →	BUZ		246-086-001-007C	HLWP	Plug Number (T2): 3b

**2.0 TDI (125 kW | 2.0 Litre)**

08.05 →	BMR, CBBB		246-082-008-025G	SWP-M-C	
08.05 →	BMR, CBBB		246-083-002-022G	SWP-D-C	
08.05 →	BMR, CBBB		246-086-001-007C	HLWP	Plug Number (T2): 3b

**2.0 TDI (81 kW | 2.0 Litre)**

11.08 → 07.10	CBDC		246-082-008-025G	SWP-M-C	
11.08 → 07.10	CBDC		246-083-002-022G	SWP-D-C	
11.08 → 07.10	CBDC		246-086-001-007C	HLWP	Plug Number (T2): 3b

**2.0 TDI (88 kW | 2.0 Litre)**

11.05 → 05.07	BWV		246-082-008-025G	SWP-M-C	
11.05 → 05.07	BWV		246-083-002-022G	SWP-D-C	
11.05 → 05.07	BWV		246-086-001-007C	HLWP	Plug Number (T2): 3b

**2.0 TDI (90 kW | 2.0 Litre)**

08.05 → 07.06	BVE		246-082-008-025G	SWP-M-C	
08.05 → 07.06	BVE		246-083-002-022G	SWP-D-C	
08.05 → 07.06	BVE		246-086-001-007C	HLWP	Plug Number (T2): 3b

**2.0 TDI 16V (103 kW | 2.0 Litre)**

03.05 →	BKP, CBAB		246-082-008-025G	SWP-M-C	
03.05 →	BKP, CBAB		246-083-002-022G	SWP-D-C	
03.05 →	BKP, CBAB		246-086-001-007C	HLWP	Plug Number (T2): 3b



			<b>VDO</b>		
Date	Engine Code	Chassis No.	Article No.	Product	Information

**VW****PASSAT (3C2)****2.0 TDI 16V 4motion (103 kW | 2.0 Litre)**

03.05 →	BKP, CBAB		246-082-008-025G	SWP-M-C	
03.05 →	BKP, CBAB		246-083-002-022G	SWP-D-C	
03.05 →	BKP, CBAB		246-086-001-007C	HLWP	Plug Number (T2): 3b

**2.0 TDI 4motion (103 kW | 2.0 Litre)**

03.05 →	BMP		246-082-008-025G	SWP-M-C	
03.05 →	BMP		246-083-002-022G	SWP-D-C	
03.05 →	BMP		246-086-001-007C	HLWP	Plug Number (T2): 3b

**2.0 TDI 4motion (125 kW | 2.0 Litre)**

05.09 →	CBBB	3C-B-050 000→	246-082-008-025G	SWP-M-C	
05.09 →	CBBB	3C-B-050 000→	246-083-002-022G	SWP-D-C	
05.09 →	CBBB	3C-B-050 000→	246-086-001-007C	HLWP	Plug Number (T2): 3b

**3.2 FSI 4motion (184 kW | 3.2 Litre)**

11.05 → 07.10	AXZ		246-082-008-025G	SWP-M-C	
11.05 → 07.10	AXZ		246-083-002-022G	SWP-D-C	
11.05 → 07.10	AXZ		246-086-001-007C	HLWP	Plug Number (T2): 3b

**3.6 FSI (206 kW | 3.6 Litre)**

06.05 → 07.10	BLV		246-082-008-025G	SWP-M-C	
06.05 → 07.10	BLV		246-083-002-022G	SWP-D-C	
06.05 → 07.10	BLV		246-086-001-007C	HLWP	Plug Number (T2): 3b

**3.6 FSI 4motion (206 kW | 3.6 Litre)**

09.05 → 07.10	BLV		246-082-008-025G	SWP-M-C	
09.05 → 07.10	BLV		246-083-002-022G	SWP-D-C	
09.05 → 07.10	BLV		246-086-001-007C	HLWP	Plug Number (T2): 3b

**3.6 R36 4motion (220 kW | 3.6 Litre)**

04.07 → 07.10	BWS		246-082-008-025G	SWP-M-C	
04.07 → 07.10	BWS		246-083-002-022G	SWP-D-C	
04.07 → 07.10	BWS		246-086-001-007C	HLWP	Plug Number (T2): 3b

**PASSAT Variant (3C5)****1.4 TSI (90 kW | 1.4 Litre)**

05.07 → 11.10	CAXA		246-083-002-022G	SWP-D-C	
05.07 → 11.10	CAXA		246-086-001-007C	HLWP	Plug Number (T2): 3b

**1.4 TSI EcoFuel (110 kW | 1.4 Litre)**

01.09 → 11.10	CDGA	3C-B-050 000→	246-083-002-022G	SWP-D-C	
01.09 → 11.10	CDGA	3C-B-050 000→	246-086-001-007C	HLWP	Plug Number (T2): 3b

**1.6 (75 kW | 1.6 Litre)**

08.05 → 11.10	BSE		246-082-008-025G	SWP-M-C	
08.05 → 11.10	BSE		246-083-002-022G	SWP-D-C	
08.05 → 11.10	BSE, BSF		246-086-001-007C	HLWP	Plug Number (T2): 3b

**1.6 FSI (85 kW | 1.6 Litre)**

08.05 → 06.08	BLF		246-082-008-025G	SWP-M-C	T26: 1J0 955 665 H
08.05 → 06.08	BLF		246-083-002-022G	SWP-D-C	T26: 1J0 955 665 H
08.05 → 06.08	BLF		246-086-001-007C	HLWP	Plug Number (T2): 3b

**1.6 TDI (77 kW | 1.6 Litre)**

08.09 → 11.10	CAYC	3C-B-050 000→	246-083-002-022G	SWP-D-C	
08.09 → 11.10	CAYC	3C-B-050 000→	246-086-001-007C	HLWP	Plug Number (T2): 3b

**1.8 TSI (112 kW | 1.8 Litre)**

11.09 → 11.10	CDAB, CGYA	3C-B-050 000→	246-083-002-022G	SWP-D-C	
11.09 → 11.10	CDAB, CGYA	3C-B-050 000→	246-086-001-007C	HLWP	Plug Number (T2): 3b

**1.8 TSI (118 kW | 1.8 Litre)**

05.07 → 10.11	BZB, CDAA		246-083-002-022G	SWP-D-C	
05.07 → 10.11	BZB, CDAA		246-086-001-007C	HLWP	Plug Number (T2): 3b

**1.9 TDI (77 kW | 1.9 Litre)**

08.05 → 11.08	BKC, BLS, BXE		246-082-008-025G	SWP-M-C	T26: 1J0 955 665 H
08.05 → 11.08	BKC, BLS, BXE		246-083-002-022G	SWP-D-C	T26: 1J0 955 665 H
08.05 → 11.08	BKC, BLS, BXE		246-086-001-007C	HLWP	Plug Number (T2): 3b

**2.0 BlueTDI (105 kW | 2.0 Litre)**

01.09 →	CBAC	3C-B-050 000→	246-083-002-022G	SWP-D-C	
01.09 →	CBAC	3C-B-050 000→	246-086-001-007C	HLWP	Plug Number (T2): 3b

**2.0 FSI (110 kW | 2.0 Litre)**

08.05 → 11.10	BLY		246-082-008-025G	SWP-M-C	
08.05 → 11.10	BLY		246-083-002-022G	SWP-D-C	





			<b>VDO</b>		
Date	Engine Code	Chassis No.	Article No.	Product	Information

**VW****PASSAT Variant (3C5)****2.0 FSI (110 kW | 2.0 Litre)**

08.05 - 11.10	BLR, BLY, BVY, BVZ		246-086-001-007C	HLWP	Plug Number (T2): 3b
---------------	--------------------	--	------------------	------	----------------------

**2.0 FSI (147 kW | 2.0 Litre)**

08.05 - 11.10	BWA		246-082-008-025G	SWP-M-C	
08.05 - 11.10	BWA		246-083-002-022G	SWP-D-C	
08.05 - 11.10	AXX, BPY, BWA, CAWB, CBFA, CCTA, CCZA		246-086-001-007C	HLWP	Plug Number (T2): 3b

**2.0 FSI 4motion (110 kW | 2.0 Litre)**

09.05 - 11.10	BLY		246-082-008-025G	SWP-M-C	
09.05 - 11.10	BLY		246-083-002-022G	SWP-D-C	
09.05 - 11.10	BLX, BLY, BVX		246-086-001-007C	HLWP	Plug Number (T2): 3b

**2.0 TDI (100 kW | 2.0 Litre)**

08.05 - 11.10	BMA		246-082-008-025G	SWP-M-C	
08.05 - 11.10	BMA		246-083-002-022G	SWP-D-C	
08.05 - 11.10	BMA, CBAA		246-086-001-007C	HLWP	Plug Number (T2): 3b

**2.0 TDI (103 kW | 2.0 Litre)**

08.05 -	BMP		246-082-008-025G	SWP-M-C	T26: 1J0 955 665 H
08.05 -	BMP		246-083-002-022G	SWP-D-C	T26: 1J0 955 665 H
08.05 -	BMP		246-086-001-007C	HLWP	Plug Number (T2): 3b

**2.0 TDI (120 kW | 2.0 Litre)**

08.05 -	BUZ		246-083-002-022G	SWP-D-C	
08.05 -	BUZ		246-086-001-007C	HLWP	Plug Number (T2): 3b

**2.0 TDI (125 kW | 2.0 Litre)**

08.05 -	BMR		246-082-008-025G	SWP-M-C	
08.05 -	BMR		246-083-002-022G	SWP-D-C	
08.05 -	BMR, CBBB		246-086-001-007C	HLWP	Plug Number (T2): 3b

**2.0 TDI (81 kW | 2.0 Litre)**

11.08 - 11.10	CBDC		246-083-002-022G	SWP-D-C	
11.08 - 11.10	CBDC		246-086-001-007C	HLWP	Plug Number (T2): 3b

**2.0 TDI (90 kW | 2.0 Litre)**

08.05 - 02.06	BVE		246-082-008-025G	SWP-M-C	T26: 1J0 955 665 H
08.05 - 02.06	BVE		246-083-002-022G	SWP-D-C	T26: 1J0 955 665 H
08.05 - 02.06	BVE		246-086-001-007C	HLWP	Plug Number (T2): 3b

**2.0 TDI 16V (103 kW | 2.0 Litre)**

08.05 -	BKP		246-082-008-025G	SWP-M-C	
08.05 -	BKP		246-083-002-022G	SWP-D-C	
08.05 -	BKP, CBAB		246-086-001-007C	HLWP	Plug Number (T2): 3b

**2.0 TDI 16V 4motion (103 kW | 2.0 Litre)**

08.05 -	BKP		246-082-008-025G	SWP-M-C	
08.05 -	BKP		246-083-002-022G	SWP-D-C	
08.05 -	BKP, CBAB		246-086-001-007C	HLWP	Plug Number (T2): 3b

**2.0 TDI 4motion (103 kW | 2.0 Litre)**

08.05 -	BMP		246-082-008-025G	SWP-M-C	T26: 1J0 955 665 H
08.05 -	BMP		246-083-002-022G	SWP-D-C	T26: 1J0 955 665 H
08.05 -	BMP		246-086-001-007C	HLWP	Plug Number (T2): 3b

**2.0 TDI 4motion (125 kW | 2.0 Litre)**

05.09 -	CBBB	3C-B-050 000→	246-083-002-022G	SWP-D-C	
05.09 -	CBBB	3C-B-050 000→	246-086-001-007C	HLWP	Plug Number (T2): 3b

**3.2 FSI 4motion (184 kW | 3.2 Litre)**

11.05 - 11.10	AXZ		246-082-008-025G	SWP-M-C	
11.05 - 11.10	AXZ		246-083-002-022G	SWP-D-C	
11.05 - 11.10	AXZ		246-086-001-007C	HLWP	Plug Number (T2): 3b

**3.6 FSI (206 kW | 3.6 Litre)**

09.05 - 11.10	BLV		246-083-002-022G	SWP-D-C	
09.05 - 11.10	BLV		246-086-001-007C	HLWP	Plug Number (T2): 3b

**3.6 FSI 4motion (206 kW | 3.6 Litre)**

09.05 - 11.10	BLV		246-083-002-022G	SWP-D-C	
09.05 - 11.10	BLV		246-086-001-007C	HLWP	Plug Number (T2): 3b

**3.6 R36 4motion (220 kW | 3.6 Litre)**

04.07 - 11.10	BWS		246-082-008-025G	SWP-M-C	
04.07 - 11.10	BWS		246-083-002-022G	SWP-D-C	
04.07 - 11.10	BWS		246-086-001-007C	HLWP	Plug Number (T2): 3b



Date	Engine Code	Chassis No.	Article No.	Product	Information

**VW****PASSAT CC (357)****1.8 TSI (118 kW | 1.8 Litre)**

06.08 → 11.10 | BZB, CDA A | 246-082-008-025G | SWP-M-C

**2.0 BlueTDI (105 kW | 2.0 Litre)**

05.09 → 11.10 | CBAC | 3C-B-050 000→ | 246-082-008-025G | SWP-M-C

**2.0 TDI (100 kW | 2.0 Litre)**

06.08 → 05.11 | CBAA | 246-082-008-025G | SWP-M-C

**2.0 TDI (103 kW | 2.0 Litre)**

06.08 → | CBAB | 246-082-008-025G | SWP-M-C

**2.0 TDI (125 kW | 2.0 Litre)**

06.08 → | CBBB | 246-082-008-025G | SWP-M-C

**2.0 TDI 4motion (103 kW | 2.0 Litre)**

08.09 → | CBAB | 3C-B-050 000→ | 246-082-008-025G | SWP-M-C

**2.0 TDI 4motion (125 kW | 2.0 Litre)**

11.09 → | CBBB | 3C-B-050 000→ | 246-082-008-025G | SWP-M-C

**2.0 TSI (147 kW | 2.0 Litre)**

06.08 → | CAWB, CBFA, CCTA, CCZA | 246-082-008-025G | SWP-M-C

**3.6 FSI 4motion (220 kW | 3.6 Litre)**

06.08 → 05.10 | BWS | 246-082-008-025G | SWP-M-C

**PHAETON (3D\_)****3.0 V6 TDI 4motion (165 kW | 3.0 Litre)**

09.04 → | BMK | 246-082-008-025G | SWP-M-C

**3.0 V6 TDI 4motion (171 kW | 3.0 Litre)**

06.07 → | CARA | 246-082-008-025G | SWP-M-C

**3.0 V6 TDI 4motion (176 kW | 3.0 Litre)**

11.08 → | CARB, CEXA | 3D-9-100 001→ | 246-082-008-025G | SWP-M-C

**3.2 V6 (177 kW | 3.2 Litre)**

04.02 → | AYT, BKL | 246-082-008-025G | SWP-M-C

**3.2 V6 4motion (177 kW | 3.2 Litre)**

02.04 → | BRK, BKL | 246-082-008-025G | SWP-M-C

**3.6 V6 4motion (206 kW | 3.6 Litre)**

11.08 → | CHNA | 3D-9-100 001→ | 246-082-008-025G | SWP-M-C

**4.2 V8 4motion (246 kW | 4.2 Litre)**

05.03 → | BGH, BGJ | 246-082-008-025G | SWP-M-C

**5.0 V10 TDI 4motion (230 kW | 5.0 Litre)**

11.02 → | AJS | 246-082-008-025G | SWP-M-C

**6.0 W12 4motion (309 kW | 6.0 Litre)**

04.02 → | BAN | 246-082-008-025G | SWP-M-C

**6.0 W12 4motion (331 kW | 6.0 Litre)**

05.05 → | BRN, BTT | 246-082-008-025G | SWP-M-C | T26: 3B0 955 665C

**POLO (86)****0.9 (29 kW | 0.9 Litre)**

09.75 → 12.78 | HA | →869 2556 859 | 246-075-021-006C | SWP-M-G | Plug Number (T2): 1

12.78 → 09.81 | HA | 869 2556 560→ | 246-082-008-014C | SWP-M-C | Plug Number (T2): 1

09.75 → 09.81 | HA | 869 2556 860→ | 246-086-001-007C | HLWP | Plug Number (T2): 3b; T26: X11-246-003-014

**1.1 (37 kW | 1.1 Litre)**

03.75 → 12.78 | HB | →869 2556 859 | 246-075-021-006C | SWP-M-G | Plug Number (T2): 1

12.78 → 07.81 | HB | 869 2556 560→ | 246-082-008-014C | SWP-M-C | Plug Number (T2): 1

03.75 → 09.81 | HB | 869 2556 860→ | 246-086-001-007C | HLWP | Plug Number (T2): 3b; T26: X11-246-003-014

**1.1 (44 kW | 1.1 Litre)**

03.75 → 07.77 | HC | 246-075-021-006C | SWP-M-G | Plug Number (T2): 1

03.75 → 09.81 | HC | 869 2556 860→ | 246-086-001-007C | HLWP | Plug Number (T2): 3b; T26: X11-246-003-014

**1.3 (44 kW | 1.3 Litre)**

08.77 → 12.78 | HH | →869 2556 859 | 246-075-021-006C | SWP-M-G | Plug Number (T2): 1

12.78 → 09.81 | HH | 869 2556 560→ | 246-082-008-014C | SWP-M-C | Plug Number (T2): 1

12.76 → 09.81 | HH | 869 2556 860→ | 246-086-001-007C | HLWP | Plug Number (T2): 3b; T26: X11-246-003-014

**POLO (86C, 80)****0.9 (29 kW | 0.9 Litre)**

10.81 → 12.81 | HA | 246-086-001-007C | HLWP | Plug Number (T2): 3b; T26: X11-246-003-014

**1.0 (29 kW | 1.0 Litre)**

08.83 → 10.86 | GL | 246-082-008-014C | SWP-M-C | Plug Number (T2): 1



			<b>VDO</b>		
Date	Engine Code	Chassis No.	Article No.	Product	Information

**VW****POLO (86C, 80)**

<b>1.0 (29 kW   1.0 Litre)</b>					
10.81 - 10.86	GL		246-086-001-007C	HLWP	Plug Number (T2): 3b; T26: X11-246-003-014
<b>1.0 (33 kW   1.0 Litre)</b>					
08.85 - 01.92	HZ		246-086-001-007C	HLWP	Plug Number (T2): 3b; T26: X11-246-003-014
<b>1.0 CAT (33 kW   1.0 Litre)</b>					
10.90 - 09.94	AAK, AAU, ACM		246-082-008-014C	SWP-M-C	Plug Number (T2): 1
10.90 - 09.94	AAK, AAU, ACM		246-083-002-014G	SWP-D-C	Plug Number (T2): 6
10.90 - 09.94	AAK, AAU, ACM		246-086-001-002C	HLWP	Plug Number (T2): 3
08.89 - 09.94	AAK, AAU, ACM		246-086-001-007C	HLWP	Plug Number (T2): 3b; T26: X11-246-003-014
<b>1.1 (37 kW   1.1 Litre)</b>					
10.81 - 07.83	HB		246-082-008-014C	SWP-M-C	Plug Number (T2): 1
10.81 - 09.89	HB		246-086-001-007C	HLWP	Plug Number (T2): 3b; T26: X11-246-003-014
<b>1.3 (40 kW   1.3 Litre)</b>					
08.85 - 07.88	HK, MH		246-082-008-014C	SWP-M-C	Plug Number (T2): 1
08.86 - 07.88	HK, MH		246-083-002-006G	SWP-D-C	Plug Number (T2): 1
08.83 - 07.88	HK, MH		246-086-001-007C	HLWP	Plug Number (T2): 3b; T26: X11-246-003-014
<b>1.3 (43 kW   1.3 Litre)</b>					
08.82 - 07.88	HJ, GT		246-082-008-014C	SWP-M-C	Plug Number (T2): 1
08.82 - 07.88	HJ, GT		246-086-001-007C	HLWP	Plug Number (T2): 3b
<b>1.3 (44 kW   1.3 Litre)</b>					
10.81 - 07.83	HH		246-082-008-014C	SWP-M-C	Plug Number (T2): 1
10.81 - 07.83	HH		246-086-001-007C	HLWP	Plug Number (T2): 3b; T26: X11-246-003-014
<b>1.3 (55 kW   1.3 Litre)</b>					
08.86 - 09.89	GK		246-082-008-014C	SWP-M-C	Plug Number (T2): 1
08.86 - 09.89	GK		246-083-002-006G	SWP-D-C	Plug Number (T2): 1
09.82 - 09.89	GK		246-086-001-007C	HLWP	Plug Number (T2): 3b; T26: X11-246-003-014
<b>1.3 CAT (40 kW   1.3 Litre)</b>					
08.88 - 10.90	MH, NZ, 2G, AAV		246-082-008-014C	SWP-M-C	Plug Number (T2): 1
08.88 - 10.90	MH, NZ, 2G, AAV		246-083-002-006G	SWP-D-C	Plug Number (T2): 1
07.87 - 09.94	MH, NZ, 2G, AAV		246-086-001-007C	HLWP	Plug Number (T2): 3b; T26: X11-246-003-014
<b>1.3 CAT (55 kW   1.3 Litre)</b>					
10.89 - 03.91	3F		246-082-008-014C	SWP-M-C	Plug Number (T2): 1
10.89 - 10.90	3F		246-083-002-006G	SWP-D-C	Plug Number (T2): 1
10.90 - 03.91	3F		246-083-002-014G	SWP-D-C	Plug Number (T2): 6
10.90 - 03.91	3F		246-086-001-002C	HLWP	Plug Number (T2): 3
10.89 - 03.91	3F		246-086-001-007C	HLWP	Plug Number (T2): 3b; T26: X11-246-003-014
<b>1.3 D (33 kW   1.3 Litre)</b>					
08.86 - 07.90	MN		246-082-008-014C	SWP-M-C	Plug Number (T2): 1
08.86 - 07.90	MN		246-083-002-006G	SWP-D-C	Plug Number (T2): 1
08.86 - 07.90	MN		246-086-001-007C	HLWP	Plug Number (T2): 3b; T26: X11-246-003-014
<b>1.4 D (35 kW   1.4 Litre)</b>					
10.90 - 07.91	1W		246-082-008-014C	SWP-M-C	Plug Number (T2): 1
10.90 - 07.91	1W		246-083-002-014G	SWP-D-C	Plug Number (T2): 6
10.90 - 07.91	1W		246-086-001-002C	HLWP	Plug Number (T2): 3
10.90 - 09.94	1W		246-086-001-007C	HLWP	Plug Number (T2): 3b; T26: X11-246-003-014

**POLO CLASSIC (86C, 80)**

<b>1.0 (29 kW   1.0 Litre)</b>					
01.85 - 10.86	GL		246-082-008-014C	SWP-M-C	Plug Number (T2): 1
<b>1.0 (33 kW   1.0 Litre)</b>					
08.86 - 10.90	HZ, AAU, AAK		246-082-008-014C	SWP-M-C	Plug Number (T2): 1
<b>1.3 (40 kW   1.3 Litre)</b>					
08.85 - 07.86	HK, MH		246-082-008-014C	SWP-M-C	Plug Number (T2): 1
<b>1.3 CAT (40 kW   1.3 Litre)</b>					
07.87 - 10.90	MH, NZ		246-082-008-014C	SWP-M-C	Plug Number (T2): 1
<b>1.3 D (33 kW   1.3 Litre)</b>					
08.86 - 12.88	MN		246-082-008-014C	SWP-M-C	Plug Number (T2): 1
<b>1.4 D (35 kW   1.4 Litre)</b>					
10.90 - 09.94	1W		246-082-008-014C	SWP-M-C	Plug Number (T2): 1
10.90 - 09.94	1W		246-086-001-007C	HLWP	Plug Number (T2): 3b



			<b>VDO</b>		
Date	Engine Code	Chassis No.	Article No.	Product	Information

**VW****POLO Coupe (86C, 80)**

<b>1.0 (29 kW   1.0 Litre)</b>					
05.82 - 10.86	GL		246-082-008-014C	SWP-M-C	Plug Number (T2): 1
05.82 - 10.86	GL		246-086-001-007C	HLWP	Plug Number (T2): 3b
<b>1.0 (33 kW   1.0 Litre)</b>					
08.85 - 01.92	HZ		246-082-008-014C	SWP-M-C	Plug Number (T2): 1
08.85 - 01.92	HZ		246-086-001-007C	HLWP	Plug Number (T2): 3b
<b>1.0 CAT (33 kW   1.0 Litre)</b>					
08.89 - 09.94	AAK, AAU, ACM		246-082-008-014C	SWP-M-C	Plug Number (T2): 1
08.89 - 09.94	AAK, AAU, ACM		246-086-001-007C	HLWP	Plug Number (T2): 3b
<b>1.1 (37 kW   1.1 Litre)</b>					
10.81 - 07.83	HB		246-082-008-014C	SWP-M-C	Plug Number (T2): 1
10.81 - 07.83	HB		246-086-001-007C	HLWP	Plug Number (T2): 3b
<b>1.3 (40 kW   1.3 Litre)</b>					
08.83 - 06.87	HK, MH		246-082-008-014C	SWP-M-C	Plug Number (T2): 1
08.86 - 06.87	HK, MH		246-083-002-006G	SWP-D-C	Plug Number (T2): 1
<b>1.3 (44 kW   1.3 Litre)</b>					
08.82 - 07.83	HH		246-082-008-014C	SWP-M-C	Plug Number (T2): 1
<b>1.3 (55 kW   1.3 Litre)</b>					
08.86 - 09.89	GK		246-082-008-014C	SWP-M-C	Plug Number (T2): 1
08.86 - 09.89	GK		246-083-002-006G	SWP-D-C	Plug Number (T2): 1
<b>1.3 (57 kW   1.3 Litre)</b>					
03.91 - 09.94	3F		246-082-008-014C	SWP-M-C	Plug Number (T2): 1
03.91 - 09.94	3F		246-086-001-007C	HLWP	Plug Number (T2): 3b
<b>1.3 CAT (40 kW   1.3 Litre)</b>					
10.90 - 08.94	2G, AAV, MH, NZ		246-082-008-014C	SWP-M-C	Plug Number (T2): 1
10.90 - 08.94	2G, AAV, MH, NZ		246-083-002-014G	SWP-D-C	Plug Number (T2): 6
10.90 - 08.94	2G, AAV, MH, NZ		246-086-001-002C	HLWP	Plug Number (T2): 3
<b>1.3 CAT (55 kW   1.3 Litre)</b>					
10.89 - 09.94	3F		246-082-008-014C	SWP-M-C	Plug Number (T2): 1
10.89 - 10.90	3F		246-083-002-006G	SWP-D-C	Plug Number (T2): 1
10.90 - 09.94	3F		246-083-002-014G	SWP-D-C	Plug Number (T2): 6
10.90 - 09.94	3F		246-086-001-002C	HLWP	Plug Number (T2): 3
<b>1.3 D (33 kW   1.3 Litre)</b>					
08.86 - 08.90	MN		246-082-008-014C	SWP-M-C	Plug Number (T2): 1
08.86 - 08.90	MN		246-083-002-006G	SWP-D-C	Plug Number (T2): 1
<b>1.3 G40 (83 kW   1.3 Litre)</b>					
10.90 - 09.94	PY		246-082-008-014C	SWP-M-C	Plug Number (T2): 1
10.90 - 09.94	PY		246-083-002-014G	SWP-D-C	Plug Number (T2): 6
10.90 - 09.94	PY		246-086-001-002C	HLWP	Plug Number (T2): 3
<b>1.3 G40 (85 kW   1.3 Litre)</b>					
01.87 - 08.90	PY		246-082-008-014C	SWP-M-C	Plug Number (T2): 1
01.87 - 08.90	PY		246-083-002-006G	SWP-D-C	Plug Number (T2): 1
<b>1.4 D (35 kW   1.4 Litre)</b>					
10.90 - 09.94	1W		246-082-008-014C	SWP-M-C	Plug Number (T2): 1
10.90 - 09.94	1W		246-083-002-014G	SWP-D-C	Plug Number (T2): 6
10.90 - 09.94	1W		246-086-001-002C	HLWP	Plug Number (T2): 3

**POLO Box (86CF)**

<b>1.0 (33 kW   1.0 Litre)</b>					
08.92 - 07.94	AAU	-T - 300 000	246-082-008-014C	SWP-M-C	Plug Number (T2): 1
08.92 - 07.94	AAU	-T - 300 000	246-083-002-014G	SWP-D-C	Plug Number (T2): 6
08.92 - 07.94	AAU		246-083-002-022G	SWP-D-C	
08.92 - 07.94	AAU		246-086-001-002C	HLWP	Plug Number (T2): 3
<b>1.3 (40 kW   1.3 Litre)</b>					
08.92 - 07.94	AAV		246-082-008-014C	SWP-M-C	Plug Number (T2): 1
08.92 - 07.94	AAV		246-083-002-014G	SWP-D-C	Plug Number (T2): 6
08.92 - 07.94	AAV		246-083-002-022G	SWP-D-C	
08.92 - 07.94	AAV		246-086-001-002C	HLWP	Plug Number (T2): 3
<b>1.4 D (35 kW   1.4 Litre)</b>					
08.92 - 07.94	1W		246-082-008-014C	SWP-M-C	Plug Number (T2): 1
08.92 - 07.94	1W		246-083-002-014G	SWP-D-C	Plug Number (T2): 6
08.92 - 07.94	1W		246-083-002-022G	SWP-D-C	
08.92 - 07.94	1W		246-086-001-002C	HLWP	Plug Number (T2): 3



			<b>VDO</b>		
Date	Engine Code	Chassis No.	Article No.	Product	Information

**VW****POLO (6N1)****1.7 SDI (42 kW | 1.7 Litre)**

04.97 - 10.99	AHG		246-069-056-001Z	N	
04.97 - 10.99	AHG	-6N-V-350 000	246-080-010-002Z	N-H	
04.97 - 10.99	AHG	6N-W-001 001→	246-082-008-025G	SWP-M-C	
04.97 - 10.99	AHG	6N-W-001 001→	246-083-002-022G	SWP-D-C	
04.97 - 10.99	AHG		246-086-001-007C	HLWP	Plug Number (T2): 3b; T26: X11-246-003-014

**100 1.4 16V (74 kW | 1.4 Litre)**

04.96 - 10.99	AFH		246-069-056-001Z	N	
04.96 - 10.99	AFH	-6N-V-350 000	246-080-010-002Z	N-H	
04.96 - 05.96	AFH	-T - 300 000	246-082-008-014C	SWP-M-C	Plug Number (T2): 1
04.96 - 10.99	AFH		246-082-008-025G	SWP-M-C	
04.96 - 05.96	AFH	-T - 300 000	246-083-002-014G	SWP-D-C	Plug Number (T2): 6
04.96 - 10.99	AFH		246-083-002-022G	SWP-D-C	
04.96 - 10.99	AFH		246-086-001-002C	HLWP	Plug Number (T2): 3
04.96 - 10.99	AFH		246-086-001-007C	HLWP	Plug Number (T2): 3b; T26: X11-246-003-014

**120 1.6 16V GTI (88 kW | 1.6 Litre)**

09.98 - 10.99	AJV		246-069-056-001Z	N	
09.98 - 10.99	AJV	-6N-V-350 000	246-080-010-002Z	N-H	
09.98 - 10.99	AJV		246-082-008-025G	SWP-M-C	
09.98 - 10.99	AJV		246-083-002-022G	SWP-D-C	
09.98 - 10.99	AJV		246-086-001-007C	HLWP	Plug Number (T2): 3b; T26: X11-246-003-014

**45 1.0 (33 kW | 1.0 Litre)**

10.94 - 09.96	AEV		246-069-056-001Z	N	
10.94 - 09.96	AEV	-6N-V-350 000	246-080-010-002Z	N-H	
10.94 - 09.96	AEV		246-083-002-022G	SWP-D-C	
10.94 - 09.96	AEV		246-086-001-007C	HLWP	Plug Number (T2): 3b; T26: X11-246-003-014

**50 1.0 (37 kW | 1.0 Litre)**

09.96 - 10.99	AER, ALL		246-069-056-001Z	N	
09.96 - 10.99	AER, ALL	-6N-V-350 000	246-080-010-002Z	N-H	
09.96 - 10.99	AER, ALL		246-082-008-025G	SWP-M-C	
09.96 - 10.99	AER, ALL		246-083-002-022G	SWP-D-C	
09.96 - 07.98	AER, ALL		246-086-001-002C	HLWP	Plug Number (T2): 3
09.96 - 10.99	AER, ALL		246-086-001-007C	HLWP	Plug Number (T2): 3b; T26: X11-246-003-014

**55 1.3 (40 kW | 1.3 Litre)**

10.94 - 07.95	ADX		246-069-056-001Z	N	
10.94 - 07.95	ADX	-6N-V-350 000	246-080-010-002Z	N-H	
10.94 - 06.95	ADX		246-082-008-014C	SWP-M-C	Plug Number (T2): 1
10.94 - 06.95	ADX		246-083-002-014G	SWP-D-C	Plug Number (T2): 6
10.94 - 07.95	ADX		246-083-002-022G	SWP-D-C	
10.94 - 06.95	ADX		246-086-001-002C	HLWP	Plug Number (T2): 3
10.94 - 07.95	ADX		246-086-001-007C	HLWP	Plug Number (T2): 3b; T26: X11-246-003-014

**55 1.4 (40 kW | 1.4 Litre)**

08.95 - 10.99	AEX		246-069-056-001Z	N	
08.95 - 10.99	AEX	-6N-V-350 000	246-080-010-002Z	N-H	
08.95 - 05.96	AEX	-T - 300 000	246-082-008-014C	SWP-M-C	Plug Number (T2): 1
08.95 - 05.96	AEX	-T - 300 000	246-083-002-014G	SWP-D-C	Plug Number (T2): 6
05.96 - 10.99	AEX		246-083-002-022G	SWP-D-C	
08.95 - 12.97	AEX		246-086-001-002C	HLWP	Plug Number (T2): 3
08.95 - 10.99	AEX		246-086-001-007C	HLWP	Plug Number (T2): 3b; T26: X11-246-003-014

**60 1.4 (44 kW | 1.4 Litre)**

07.95 - 10.99	AEX, APQ, AKV		246-069-056-001Z	N	
07.95 - 10.99	AEX, APQ, AKV	-6N-V-350 000	246-080-010-002Z	N-H	
05.96 - 10.99	AEX, APQ, AKV		246-083-002-022G	SWP-D-C	
07.96 - 12.97	AEX, APQ, AKV		246-086-001-002C	HLWP	Plug Number (T2): 3
07.95 - 10.99	AEX, APQ, AKV		246-086-001-007C	HLWP	Plug Number (T2): 3b; T26: X11-246-003-014

**60 1.7 SDI (44 kW | 1.7 Litre)**

08.97 - 10.99	AKU		246-069-056-001Z	N	
08.97 - 10.99	AKU	-6N-V-350 000	246-080-010-002Z	N-H	
08.97 - 10.99	AKU	6N-W-001 001→	246-082-008-025G	SWP-M-C	
08.97 - 10.99	AKU	6N-W-001 001→	246-083-002-022G	SWP-D-C	
08.97 - 10.99	AKU		246-086-001-007C	HLWP	Plug Number (T2): 3b; T26: X11-246-003-014

**64 1.9 D (47 kW | 1.9 Litre)**

10.94 - 10.99	AEF		246-069-056-001Z	N	
---------------	-----	--	------------------	---	--



			<b>VDO</b>		
Date	Engine Code	Chassis No.	Article No.	Product	Information

**VW****POLO (6N1)****64 1.9 D (47 kW | 1.9 Litre)**

10.94 - 10.99	AEF	-6N-V-350 000	246-080-010-002Z	N-H	
01.95 - 05.96	AEF	-T - 300 000	246-082-008-014C	SWP-M-C	Plug Number (T2): 1
01.95 - 05.96	AEF	-T - 300 000	246-083-002-014G	SWP-D-C	Plug Number (T2): 6
10.94 - 10.99	AEF	6N-W-001 001→	246-083-002-022G	SWP-D-C	
01.95 - 10.99	AEF		246-086-001-002C	HLWP	Plug Number (T2): 3
10.94 - 10.99	AEF		246-086-001-007C	HLWP	Plug Number (T2): 3b; T26: X11-246-003-014

**64 1.9 SDI (47 kW | 1.9 Litre)**

07.96 - 10.99	AGD		246-069-056-001Z	N	
07.96 - 10.99	AGD	-6N-V-350 000	246-080-010-002Z	N-H	
07.96 - 10.99	AGD	6N-W-001 001→	246-082-008-025G	SWP-M-C	
07.96 - 10.99	AGD	6N-W-001 001→	246-083-002-022G	SWP-D-C	
07.96 - 10.99	AGD		246-086-001-007C	HLWP	Plug Number (T2): 3b; T26: X11-246-003-014

**75 1.6 (55 kW | 1.6 Litre)**

10.94 - 10.99	AEA, AEE, AHS		246-069-056-001Z	N	
10.94 - 10.99	AEA, AEE, AHS	-6N-V-350 000	246-080-010-002Z	N-H	
10.94 - 06.95	AEA, AEE, AHS		246-082-008-014C	SWP-M-C	Plug Number (T2): 1
10.94 - 06.95	AEA, AEE, AHS		246-083-002-014G	SWP-D-C	Plug Number (T2): 6
05.96 - 10.99	AEA, AEE, AHS		246-083-002-022G	SWP-D-C	
10.94 - 06.95	AEA, AEE, AHS		246-086-001-002C	HLWP	Plug Number (T2): 3
10.94 - 10.99	AEA, AEE, AHS		246-086-001-007C	HLWP	Plug Number (T2): 3b; T26: X11-246-003-014

**POLO Box (6NF)****1.0 (33 kW | 1.0 Litre)**

10.94 - 12.99	AAU		246-069-056-001Z	N	
07.96 - 12.99	AAU		246-083-002-022G	SWP-D-C	
07.96 - 12.99	AAU		246-086-001-002C	HLWP	Plug Number (T2): 3

**1.4 (44 kW | 1.4 Litre)**

05.98 - 12.99	AEX, APQ		246-069-056-001Z	N	
05.98 - 12.99	AEX, APQ		246-083-002-022G	SWP-D-C	

**1.7 SDI (44 kW | 1.7 Litre)**

08.97 - 12.99	AKU		246-069-056-001Z	N	
08.97 - 12.99	AKU		246-083-002-022G	SWP-D-C	

**1.9 D (47 kW | 1.9 Litre)**

10.94 - 12.99	AEF		246-069-056-001Z	N	
07.96 - 12.99	AEF		246-083-002-022G	SWP-D-C	
07.96 - 12.99	AEF		246-086-001-002C	HLWP	Plug Number (T2): 3

**1.9 SDI (47 kW | 1.9 Litre)**

07.96 - 12.99	AGD		246-069-056-001Z	N	
07.96 - 12.99	AGD		246-083-002-022G	SWP-D-C	

**POLO CLASSIC (6KV2)****1.0 (37 kW | 1.0 Litre)**

08.96 - 12.01	AER		246-082-008-025G	SWP-M-C	T26: X11 246 003 014
---------------	-----	--	------------------	---------	----------------------

**1.6 (65 kW | 1.6 Litre)**

05.96 - 09.01			246-082-008-025G	SWP-M-C	T26: X11 246 003 014
---------------	--	--	------------------	---------	----------------------

**1.8 (73 kW | 1.8 Litre)**

05.96 - 09.01			246-082-008-025G	SWP-M-C	T26: X11 246 003 014
---------------	--	--	------------------	---------	----------------------

**1.8 (82 kW | 1.8 Litre)**

08.00 - 07.02			246-082-008-025G	SWP-M-C	T26: X11 246 003 014
---------------	--	--	------------------	---------	----------------------

**1.8 (85 kW | 1.8 Litre)**

04.97 - 07.98			246-082-008-025G	SWP-M-C	T26: X11 246 003 014
---------------	--	--	------------------	---------	----------------------

**100 1.6 (74 kW | 1.6 Litre)**

12.95 - 09.01	AFT, AUR, AEH, APF, AKL		246-069-056-001Z	N	
12.95 - 09.01	AFT, AUR, AEH, APF, AKL	-6N-V-350 000	246-080-010-002Z	N-H	
12.95 - 09.01	AFT, AUR, AEH, APF, AKL		246-082-008-025G	SWP-M-C	
05.96 - 09.99	AFT, AUR, AEH, APF, AKL		246-086-001-002C	HLWP	Plug Number (T2): 3
12.95 - 09.01	AFT, AUR, AEH, APF, AKL		246-086-001-007C	HLWP	Plug Number (T2): 3b; T26: X11-246-003-014

**110 1.9 TDI (81 kW | 1.9 Litre)**

06.98 - 09.01	AFN, ASV		246-069-056-001Z	N	
06.98 - 09.01	AFN, ASV	-6N-V-350 000	246-080-010-002Z	N-H	
06.98 - 09.01	AFN, ASV	6K-Y-502- 795→	246-082-008-025G	SWP-M-C	
06.98 - 09.99	AFN, ASV		246-086-001-002C	HLWP	Plug Number (T2): 3



			<b>VDO</b>		
Date	Engine Code	Chassis No.	Article No.	Product	Information

**VW****POLO CLASSIC (6KV2)****110 1.9 TDI (81 kW | 1.9 Litre)**

06.98 - 09.01	AFN, ASV		246-086-001-007C	HLWP	Plug Number (T2): 3b; T26: X11-246-003-014
---------------	----------	--	------------------	------	--------------------------------------------

**2.0 (74 kW | 2.0 Litre)**

06.99 - 07.05			246-082-008-025G	SWP-M-C	T26: X11 246 003 014
---------------	--	--	------------------	---------	----------------------

**2.0 (85 kW | 2.0 Litre)**

08.99 - 09.01	ADC		246-069-056-001Z	N	
08.99 - 09.01	ADC	-6N-V-350 000	246-080-010-002Z	N-H	
08.99 - 09.01	ADC		246-082-008-025G	SWP-M-C	
08.99 - 09.01	ADC		246-086-001-007C	HLWP	Plug Number (T2): 3b; T26: X11-246-003-014

**57 1.7 SDI (42 kW | 1.7 Litre)**

07.97 - 09.01	AKW		246-069-056-001Z	N	
07.97 - 09.01	AKW	-6N-V-350 000	246-080-010-002Z	N-H	
07.97 - 09.01	AKW	6K-Y-502- 795→	246-082-008-025G	SWP-M-C	
07.97 - 09.01	AKW		246-086-001-007C	HLWP	Plug Number (T2): 3b; T26: X11-246-003-014

**60 1.4 (44 kW | 1.4 Litre)**

12.95 - 09.01	AEX, AKV, AKK, AUD, ANW, APQ		246-069-056-001Z	N	
12.95 - 09.01	AEX, AKV, AKK, AUD, ANW, APQ	-6N-V-350 000	246-080-010-002Z	N-H	
12.95 - 09.01	AEX, AKV, AKK, AUD, ANW, APQ		246-082-008-025G	SWP-M-C	
05.96 - 09.99	AEX, AKV, AKK, AUD, ANW, APQ		246-086-001-002C	HLWP	Plug Number (T2): 3
12.95 - 09.01	AEX, AKV, AKK, AUD, ANW, APQ		246-086-001-007C	HLWP	Plug Number (T2): 3b; T26: X11-246-003-014

**64 1.9 D (47 kW | 1.9 Litre)**

01.96 - 10.96	1Y		246-082-008-025G	SWP-M-C	
01.96 - 10.96	1Y	6K-Y-502 795→	246-086-001-007C	HLWP	Plug Number (T2): 3b

**64 1.9 SDI (47 kW | 1.9 Litre)**

12.95 - 08.99	AEY		246-069-056-001Z	N	
12.95 - 08.99	AEY	-6N-V-350 000	246-080-010-002Z	N-H	
12.95 - 08.99	AEY	6K-Y-502- 795→	246-082-008-025G	SWP-M-C	
05.96 - 08.99	AEY		246-086-001-002C	HLWP	Plug Number (T2): 3
12.95 - 08.99	AEY		246-086-001-007C	HLWP	Plug Number (T2): 3b; T26: X11-246-003-014

**68 1.9 SDI (50 kW | 1.9 Litre)**

08.99 - 09.01	AQM, AGP		246-069-056-001Z	N	
08.99 - 09.01	AQM, AGP	-6N-V-350 000	246-080-010-002Z	N-H	
08.99 - 09.01	AQM, AGP	6K-Y-502- 795→	246-082-008-025G	SWP-M-C	
10.99 - 09.01	AQM, AGP		246-086-001-002C	HLWP	Plug Number (T2): 3
08.99 - 09.01	AQM, AGP		246-086-001-007C	HLWP	Plug Number (T2): 3b; T26: X11-246-003-014

**75 1.4 16V (55 kW | 1.4 Litre)**

10.99 - 09.01	APE, AUA		246-069-056-001Z	N	
10.99 - 09.01	APE, AUA	-6N-V-350 000	246-080-010-002Z	N-H	
10.99 - 09.01	APE, AUA		246-082-008-025G	SWP-M-C	
10.99 - 09.01	APE, AUA		246-086-001-002C	HLWP	Plug Number (T2): 3
10.99 - 09.01	APE, AUA		246-086-001-007C	HLWP	Plug Number (T2): 3b; T26: X11-246-003-014

**75 1.6 (55 kW | 1.6 Litre)**

11.95 - 09.01	AEE, ALM		246-069-056-001Z	N	
11.95 - 09.01	AEE, ALM	-6N-V-350 000	246-080-010-002Z	N-H	
11.95 - 05.96	AEE, ALM	-T - 300 000	246-082-008-014C	SWP-M-C	Plug Number (T2): 1
11.95 - 09.97	1F		246-082-008-025G	SWP-M-C	
11.95 - 09.01	AEE, ALM		246-082-008-025G	SWP-M-C	
11.95 - 05.96	AEE, ALM	-T - 300 000	246-083-002-014G	SWP-D-C	Plug Number (T2): 6
11.95 - 09.01	AEE, ALM		246-083-002-022G	SWP-D-C	
11.95 - 09.99	AEE, ALM		246-086-001-002C	HLWP	Plug Number (T2): 3
11.95 - 09.97	1F	6K-Y-502 795→	246-086-001-007C	HLWP	Plug Number (T2): 3b
11.95 - 09.01	AEE, ALM		246-086-001-007C	HLWP	Plug Number (T2): 3b; T26: X11-246-003-014

**90 1.8 (66 kW | 1.8 Litre)**

01.97 - 09.01	ADD		246-069-056-001Z	N	
01.97 - 09.01	ADD	-6N-V-350 000	246-080-010-002Z	N-H	
01.97 - 09.01	ADD		246-082-008-025G	SWP-M-C	
01.97 - 09.01	ADD		246-086-001-007C	HLWP	Plug Number (T2): 3b; T26: X11-246-003-014

**90 1.9 TDI (66 kW | 1.9 Litre)**

09.96 - 09.01	AHU, ALE, ALH, AGR		246-069-056-001Z	N	
09.96 - 09.01	AHU, ALE, ALH, AGR	-6N-V-350 000	246-080-010-002Z	N-H	
09.96 - 09.01	AHU, ALE, ALH, AGR	6K-Y-502- 795→	246-082-008-025G	SWP-M-C	
09.96 - 09.01	AHU, ALE, ALH, AGR		246-086-001-007C	HLWP	Plug Number (T2): 3b; T26: X11-246-003-014



			<b>VDO</b>		
Date	Engine Code	Chassis No.	Article No.	Product	Information

**VW****POLO Variant (6KV5)****1.4 (40 kW | 1.4 Litre)**

12.98 - 09.01	AKP		246-069-056-001Z	N	
12.98 - 09.01	AKP		246-083-002-022G	SWP-D-C	

**1.4 (44 kW | 1.4 Litre)**

05.97 - 09.01	AEX, AKV, AKK, ANW, APQ, AUD		246-069-056-001Z	N	
05.97 - 09.01	AEX, AKV, AKK, ANW, APQ, AUD		246-083-002-022G	SWP-D-C	

**1.4 16V (55 kW | 1.4 Litre)**

10.99 - 09.01	APE, AUA		246-069-056-001Z	N	
10.99 - 09.01	APE, AUA		246-083-002-022G	SWP-D-C	
10.99 - 09.01	APE, AUA		246-086-001-002C	HLWP	Plug Number (T2): 3

**1.6 (55 kW | 1.6 Litre)**

05.97 - 09.01	AEE, ALM		246-069-056-001Z	N	
05.97 - 12.98	AEE, ALM		246-083-002-014G	SWP-D-C	Plug Number (T2): 6
05.97 - 09.01	AEE, ALM		246-083-002-022G	SWP-D-C	
05.97 - 12.98	AEE, ALM		246-086-001-002C	HLWP	Plug Number (T2): 3

**1.6 (74 kW | 1.6 Litre)**

05.97 - 09.01	AFT, AEH, APF, AKL, AUR		246-069-056-001Z	N	
05.97 - 05.98	AFT, AEH, APF, AKL, AUR		246-083-002-014G	SWP-D-C	Plug Number (T2): 6
05.97 - 09.01	AFT, AEH, APF, AKL, AUR		246-083-002-022G	SWP-D-C	
05.97 - 05.98	AFT, AEH, APF, AKL, AUR		246-086-001-002C	HLWP	Plug Number (T2): 3

**1.7 SDI (42 kW | 1.7 Litre)**

08.97 - 09.01	AKW		246-069-056-001Z	N	
08.97 - 09.01	AKW		246-083-002-022G	SWP-D-C	

**1.8 (66 kW | 1.8 Litre)**

05.97 - 09.01	ADZ		246-069-056-001Z	N	
05.97 - 09.01	ADZ		246-083-002-022G	SWP-D-C	

**1.9 SDI (47 kW | 1.9 Litre)**

06.97 - 09.01	AEY		246-069-056-001Z	N	
06.97 - 05.98	AEY		246-083-002-014G	SWP-D-C	Plug Number (T2): 6
06.97 - 09.01	AEY		246-083-002-022G	SWP-D-C	
06.97 - 09.01	AEY		246-086-001-002C	HLWP	Plug Number (T2): 3

**1.9 SDI (50 kW | 1.9 Litre)**

08.99 - 09.01	AGP, AQM		246-069-056-001Z	N	
10.99 - 09.01	AGP, AQM		246-083-002-022G	SWP-D-C	
10.99 - 09.01	AGP, AQM		246-086-001-002C	HLWP	Plug Number (T2): 3

**1.9 TDI (66 kW | 1.9 Litre)**

05.97 - 09.01	AHU, ALE, AGR, ALH		246-069-056-001Z	N	
05.97 - 09.01	AHU, ALE, AGR, ALH		246-083-002-022G	SWP-D-C	

**1.9 TDI (81 kW | 1.9 Litre)**

06.98 - 09.01	AFN, ASV		246-069-056-001Z	N	
06.98 - 09.01	AFN, ASV		246-083-002-022G	SWP-D-C	
06.98 - 09.01	AFN, ASV		246-086-001-002C	HLWP	Plug Number (T2): 3

**POLO PLAYA****1.4 (62 kW | 1.4 Litre)**

05.96 - 07.02	AGY		246-082-008-025G	SWP-M-C	T26: X11 246 003 014
---------------	-----	--	------------------	---------	----------------------

**POLO (6N2)****1.0 (37 kW | 1.0 Litre)**

10.99 - 09.01	ALD, AUC		246-069-056-001Z	N	
10.99 - 09.01	ALD, AUC		246-082-008-025G	SWP-M-C	
10.99 - 09.01	ALD, AUC		246-083-002-022G	SWP-D-C	
10.99 - 09.01	ALD, AUC		246-086-001-002C	HLWP	Plug Number (T2): 3

**1.4 (40 kW | 1.4 Litre)**

10.99 - 09.01	ANX, AKP		246-069-056-001Z	N	
10.99 - 09.01	ANX, AKP		246-082-008-025G	SWP-M-C	
10.99 - 09.01	ANX, AKP		246-083-002-022G	SWP-D-C	
10.99 - 09.01	ANX, AKP		246-086-001-002C	HLWP	Plug Number (T2): 3

**1.4 (44 kW | 1.4 Litre)**

10.99 - 09.01	AKK, AUD		246-069-056-001Z	N	
10.99 - 09.01	AKK, AUD		246-082-008-025G	SWP-M-C	
10.99 - 09.01	AKK, AUD		246-083-002-022G	SWP-D-C	
10.99 - 09.01	AKK, AUD		246-086-001-002C	HLWP	Plug Number (T2): 3





			<b>VDO</b>		
Date	Engine Code	Chassis No.	Article No.	Product	Information

**VW****POLO (6N2)****1.4 16V (55 kW | 1.4 Litre)**

10.99 - 09.01	AHW, AUA, APE		246-069-056-001Z	N	
10.99 - 09.01	AHW, AUA, APE		246-082-008-025G	SWP-M-C	
10.99 - 09.01	AHW, AUA, APE		246-083-002-022G	SWP-D-C	
10.99 - 09.01	AHW, AUA, APE		246-086-001-002C	HLWP	Plug Number (T2): 3

**1.4 16V (74 kW | 1.4 Litre)**

10.99 - 09.01	AFK, AUB, AQQ		246-069-056-001Z	N	
10.99 - 09.01	AFK, AUB, AQQ		246-082-008-025G	SWP-M-C	
10.99 - 09.01	AFK, AUB, AQQ		246-083-002-022G	SWP-D-C	
10.99 - 09.01	AFK, AUB, AQQ		246-086-001-002C	HLWP	Plug Number (T2): 3

**1.4 TDI (55 kW | 1.4 Litre)**

10.99 - 09.01	AMF		246-069-056-001Z	N	
10.99 - 09.01	AMF	6N-W-001 001→	246-082-008-025G	SWP-M-C	
10.99 - 09.01	AMF	6N-W-001 001→	246-083-002-022G	SWP-D-C	
10.99 - 09.01	AMF		246-086-001-002C	HLWP	Plug Number (T2): 3

**1.6 16V GTI (92 kW | 1.6 Litre)**

10.99 - 09.01	ARC, AVY		246-069-056-001Z	N	
10.99 - 09.01	ARC, AVY		246-082-008-025G	SWP-M-C	
11.99 - 09.01	ARC, AVY		246-083-002-022G	SWP-D-C	
11.99 - 09.01	ARC, AVY		246-086-001-002C	HLWP	Plug Number (T2): 3

**1.7 SDI (44 kW | 1.7 Litre)**

10.99 - 09.01	AKU		246-069-056-001Z	N	
10.99 - 09.01	AKU	6N-W-001 001→	246-082-008-025G	SWP-M-C	
10.99 - 09.01	AKU	6N-W-001 001→	246-083-002-022G	SWP-D-C	
10.99 - 09.01	AKU		246-086-001-002C	HLWP	Plug Number (T2): 3

**1.9 D (47 kW | 1.9 Litre)**

10.99 - 09.01	AEF		246-069-056-001Z	N	
10.99 - 09.01	AEF	6N-W-001 001→	246-082-008-025G	SWP-M-C	
10.99 - 09.01	AEF	6N-W-001 001→	246-083-002-022G	SWP-D-C	
10.99 - 09.01	AEF		246-086-001-002C	HLWP	Plug Number (T2): 3

**1.9 SDI (47 kW | 1.9 Litre)**

10.99 - 09.01	AGD, ASX		246-069-056-001Z	N	
10.99 - 09.01	AGD, ASX	6N-W-001 001→	246-082-008-025G	SWP-M-C	
10.99 - 09.01	AGD, ASX	6N-W-001 001→	246-083-002-022G	SWP-D-C	
10.99 - 09.01	AGD, ASX		246-086-001-002C	HLWP	Plug Number (T2): 3

**POLO (9N\_)****1.2 (40 kW | 1.2 Litre)**

01.02 - 05.07	AWY, BMD		246-082-008-025G	SWP-M-C	
01.02 - 05.07	AWY, BMD		246-083-002-022G	SWP-D-C	
01.02 - 05.07	AWY, BMD		246-086-001-007C	HLWP	Plug Number (T2): 3b

**1.2 (44 kW | 1.2 Litre)**

05.07 - 11.09	BBM		246-082-008-025G	SWP-M-C	
05.07 - 11.09	BBM		246-083-002-022G	SWP-D-C	
05.07 - 11.09	BBM		246-086-001-007C	HLWP	Plug Number (T2): 3b

**1.2 12V (47 kW | 1.2 Litre)**

10.01 - 07.07	AZQ, BME		246-082-008-025G	SWP-M-C	
10.01 - 07.07	AZQ, BME		246-083-002-022G	SWP-D-C	

**1.2 12V (51 kW | 1.2 Litre)**

05.07 - 11.09	BZG		246-082-008-025G	SWP-M-C	
05.07 - 11.09	BZG		246-083-002-022G	SWP-D-C	
05.07 - 11.09	BZG		246-086-001-007C	HLWP	Plug Number (T2): 3b

**1.4 (63 kW | 1.4 Litre)**

06.05 - 11.09			246-083-002-022G	SWP-D-C	
06.05 - 11.09			246-086-001-007C	HLWP	Plug Number (T2): 3b

**1.4 16V (55 kW | 1.4 Litre)**

10.01 - 05.08	AUA, BBY, BKY		246-082-008-025G	SWP-M-C	
10.01 - 05.08	AUA, BBY, BKY		246-083-002-022G	SWP-D-C	

**1.4 16V (59 kW | 1.4 Litre)**

05.06 - 11.09	BUD		246-082-008-025G	SWP-M-C	
05.06 - 11.09	BUD		246-083-002-022G	SWP-D-C	
05.06 - 11.09	BUD		246-086-001-007C	HLWP	Plug Number (T2): 3b



			<b>VDO</b>		
Date	Engine Code	Chassis No.	Article No.	Product	Information

**VW****POLO (9N\_)****1.4 16V (74 kW | 1.4 Litre)**

10.01 - 05.08	AUB, BBZ		246-082-008-025G	SWP-M-C	
10.01 - 05.08	AUB, BBZ		246-083-002-022G	SWP-D-C	

**1.4 FSI (63 kW | 1.4 Litre)**

02.02 - 07.06	AXU		246-082-008-025G	SWP-M-C	
02.02 - 07.06	AXU		246-083-002-022G	SWP-D-C	

**1.4 TDI (51 kW | 1.4 Litre)**

04.05 - 11.09	BNM, BWB		246-082-008-025G	SWP-M-C	
04.05 - 11.09	BNM, BWB		246-083-002-022G	SWP-D-C	
04.05 - 11.09	BNM, BWB	9N-2-000 001 →	246-086-001-007C	HLWP	Plug Number (T2): 3b

**1.4 TDI (55 kW | 1.4 Litre)**

10.01 - 06.05	AMF, BAY		246-082-008-025G	SWP-M-C	
10.01 - 06.05	AMF, BAY		246-083-002-022G	SWP-D-C	

**1.4 TDI (59 kW | 1.4 Litre)**

04.05 - 11.09	BMS, BNV		246-082-008-025G	SWP-M-C	
04.05 - 11.09	BMS, BNV		246-083-002-022G	SWP-D-C	
04.05 - 11.09	BMS, BNV	9N-2-000 001 →	246-086-001-007C	HLWP	Plug Number (T2): 3b

**1.6 16V (77 kW | 1.6 Litre)**

05.06 - 11.09	BTS		246-082-008-025G	SWP-M-C	T26: 1J0 955 665 H
05.06 - 11.09	BTS		246-083-002-022G	SWP-D-C	
05.06 - 11.09	BTS		246-086-001-007C	HLWP	Plug Number (T2): 3b

**1.8 GTI (110 kW | 1.8 Litre)**

09.05 - 11.09	BJX		246-082-008-025G	SWP-M-C	T26: 1J0 955 665 H
09.05 - 11.09	BJX		246-083-002-022G	SWP-D-C	
09.05 - 11.09	BJX		246-086-001-007C	HLWP	Plug Number (T2): 3b

**1.8 GTi Cup Edition (132 kW | 1.8 Litre)**

05.06 - 11.09	BBU		246-082-008-025G	SWP-M-C	
05.06 - 11.09	BBU		246-083-002-022G	SWP-D-C	
05.06 - 11.09	BBU		246-086-001-007C	HLWP	Plug Number (T2): 3b

**1.9 SDI (47 kW | 1.9 Litre)**

10.01 - 11.09	ASY		246-082-008-025G	SWP-M-C	
10.01 - 11.09	ASY		246-083-002-022G	SWP-D-C	

**1.9 TDI (74 kW | 1.9 Litre)**

10.01 - 11.09	ATD, AXR, BMT		246-082-008-025G	SWP-M-C	
10.01 - 11.09	ATD, AXR, BMT		246-083-002-022G	SWP-D-C	

**1.9 TDI (96 kW | 1.9 Litre)**

11.03 - 11.09	ASZ, BLT		246-082-008-025G	SWP-M-C	
11.03 - 11.09	ASZ, BLT		246-083-002-022G	SWP-D-C	
11.03 - 11.09	ASZ, BLT	9N-2-000 001 →	246-086-001-007C	HLWP	Plug Number (T2): 3b

**2.0 (85 kW | 2.0 Litre)**

10.04 - 11.09	BBX		246-083-002-022G	SWP-D-C	
10.04 - 11.09	BBX		246-086-001-007C	HLWP	Plug Number (T2): 3b

**POLO Saloon (9A4)****1.0 (37 kW | 1.0 Litre)**

08.96 - 12.01	AER		246-082-008-025G	SWP-M-C	T26: X11 246 003 014
08.96 - 12.01	AER		246-086-001-007C	HLWP	Plug Number (T2): 3b

**1.0 (58 kW | 1.0 Litre)**

02.03 - 10.03	ARA		246-082-008-025G	SWP-M-C	
02.03 - 10.03	ARA		246-086-001-007C	HLWP	Plug Number (T2): 3b

**1.4 (55 kW | 1.4 Litre)**

07.03 -	BBY, BKY		246-082-008-025G	SWP-M-C	
07.03 -	BBY, BKY		246-083-002-022G	SWP-D-C	
07.03 -	BBY, BKY	9N-2-000 001 →	246-086-001-007C	HLWP	Plug Number (T2): 3b

**1.4 (63 kW | 1.4 Litre)**

12.03 - 05.05	BLM		246-082-008-025G	SWP-M-C	
12.03 - 05.05	BLM		246-086-001-007C	HLWP	Plug Number (T2): 3b

**1.4 (74 kW | 1.4 Litre)**

11.03 -	BBZ		246-082-008-025G	SWP-M-C	
11.03 -	BBZ		246-083-002-022G	SWP-D-C	
11.03 -	BBZ	9N-2-000 001 →	246-086-001-007C	HLWP	Plug Number (T2): 3b

**1.4 TDI (55 kW | 1.4 Litre)**

07.03 -	BAY		246-082-008-025G	SWP-M-C	
---------	-----	--	------------------	---------	--



			<b>VDO</b>		
Date	Engine Code	Chassis No.	Article No.	Product	Information

**VW****POLO Saloon (9A4)****1.4 TDI (55 kW | 1.4 Litre)**

07.03 →	BAY		246-083-002-022G	SWP-D-C	
07.03 →	BAY	9N-2-000 001→	246-086-001-007C	HLWP	Plug Number (T2): 3b

**1.6 (74 kW | 1.6 Litre)**

09.02 →	BAH, CFZA		246-082-008-025G	SWP-M-C	T26: 1J0 955 665 H
09.02 →	BAH		246-086-001-007C	HLWP	Plug Number (T2): 3b

**1.6 Total Flex (74 kW | 1.6 Litre)**

10.04 →	BPA		246-086-001-007C	HLWP	Plug Number (T2): 3b
---------	-----	--	------------------	------	----------------------

**1.9 SDI (47 kW | 1.9 Litre)**

09.02 →	ASY		246-082-008-025G	SWP-M-C	
09.02 →	ASY		246-083-002-022G	SWP-D-C	
09.02 →	ASY	9N-2-000 001→	246-086-001-007C	HLWP	Plug Number (T2): 3b

**1.9 TDi (74 kW | 1.9 Litre)**

09.02 →	ATD		246-082-008-025G	SWP-M-C	T26: 1J0 955 665 H
09.02 →	ATD		246-086-001-007C	HLWP	Plug Number (T2): 3b

**2.0 (85 kW | 2.0 Litre)**

09.02 →	BBX		246-082-008-025G	SWP-M-C	T26: 1J0 955 665 H
09.02 →	BBX		246-086-001-007C	HLWP	Plug Number (T2): 3b

**SANTANA (32B)****1.3 (44 kW | 1.3 Litre)**

08.81 → 07.83	FZ		246-086-001-007C	HLWP	Plug Number (T2): 3b; T26: X11-246-003-014
---------------	----	--	------------------	------	--------------------------------------------

**1.6 (55 kW | 1.6 Litre)**

08.81 → 12.84	WV		246-082-008-014C	SWP-M-C	Plug Number (T2): 1
08.81 → 12.84	WV		246-086-001-007C	HLWP	Plug Number (T2): 3b; T26: X11-246-003-014

**1.6 (63 kW | 1.6 Litre)**

08.81 → 12.82	YP		246-082-008-014C	SWP-M-C	Plug Number (T2): 1
08.81 → 12.82	YP		246-086-001-007C	HLWP	Plug Number (T2): 3b; T26: X11-246-003-014

**1.6 D (40 kW | 1.6 Litre)**

08.81 → 12.84	CR, JK		246-082-008-014C	SWP-M-C	Plug Number (T2): 1
08.81 → 12.84	CR, JK		246-086-001-007C	HLWP	Plug Number (T2): 3b; T26: X11-246-003-014

**1.6 TD (51 kW | 1.6 Litre)**

12.81 → 07.84	CY		246-082-008-014C	SWP-M-C	Plug Number (T2): 1
12.81 → 12.84	CY		246-086-001-007C	HLWP	Plug Number (T2): 3b; T26: X11-246-003-014

**1.8 (66 kW | 1.8 Litre)**

01.83 → 12.84	DS		246-082-008-014C	SWP-M-C	Plug Number (T2): 1
01.83 → 12.84	DS		246-086-001-007C	HLWP	Plug Number (T2): 3b; T26: X11-246-003-014

**1.9 (85 kW | 1.9 Litre)**

08.81 → 07.83	WN		246-082-008-014C	SWP-M-C	Plug Number (T2): 1
08.81 → 07.83	WN		246-086-001-007C	HLWP	Plug Number (T2): 3b; T26: X11-246-003-014

**2.0 (85 kW | 2.0 Litre)**

08.83 → 12.84	JS, HP		246-082-008-014C	SWP-M-C	Plug Number (T2): 1
08.83 → 12.84	JS, HP		246-086-001-007C	HLWP	Plug Number (T2): 3b; T26: X11-246-003-014

**2.1 (85 kW | 2.1 Litre)**

08.82 → 12.83	WE		246-086-001-007C	HLWP	Plug Number (T2): 3b; T26: X11-246-003-014
---------------	----	--	------------------	------	--------------------------------------------

**SCIROCCO (53)****1.1 (37 kW | 1.1 Litre)**

04.74 → 01.77	FA	→537 2037 126	246-075-021-006C	SWP-M-G	Plug Number (T2): 1
01.77 → 07.79	FA	537 2037 127→	246-082-008-014C	SWP-M-C	Plug Number (T2): 1

**1.3 (44 kW | 1.3 Litre)**

08.79 → 07.80	GF		246-082-008-014C	SWP-M-C	Plug Number (T2): 1
---------------	----	--	------------------	---------	---------------------

**1.5 (51 kW | 1.5 Litre)**

02.74 → 12.75	FH		246-075-021-006C	SWP-M-G	Plug Number (T2): 1
08.77 → 07.80	JB		246-082-008-014C	SWP-M-C	Plug Number (T2): 1

**1.5 (55 kW | 1.5 Litre)**

02.74 → 08.75	ZB, YJ		246-075-021-006C	SWP-M-G	Plug Number (T2): 1
---------------	--------	--	------------------	---------	---------------------

**1.5 (63 kW | 1.5 Litre)**

02.74 → 09.75	ZC		246-075-021-006C	SWP-M-G	Plug Number (T2): 1
---------------	----	--	------------------	---------	---------------------

**1.6 (55 kW | 1.6 Litre)**

08.75 → 01.77	FP, FN	→537 2037 126	246-075-021-006C	SWP-M-G	Plug Number (T2): 1
01.77 → 07.77	FP, FN	537 2037 127→	246-082-008-014C	SWP-M-C	Plug Number (T2): 1



			<b>VDO</b>		
Date	Engine Code	Chassis No.	Article No.	Product	Information

**VW****SCIROCCO (53)****1.6 (63 kW | 1.6 Litre)**

08.75 → 01.77	FR	→537 2037 126	246-075-021-006C	SWP-M-G	Plug Number (T2): 1
08.76 → 07.80	FR	537 2037 127→	246-082-008-014C	SWP-M-C	Plug Number (T2): 1

**1.6 (81 kW | 1.6 Litre)**

08.76 → 01.77	EG	→537 2037 126	246-075-021-006C	SWP-M-G	Plug Number (T2): 1
01.77 → 07.80	EG	537 2037 127→	246-082-008-014C	SWP-M-C	Plug Number (T2): 1

**SCIROCCO (53B)****1.3 (44 kW | 1.3 Litre)**

08.81 → 07.83	X 16 SZR		246-082-008-014C	SWP-M-C	Plug Number (T2): 1
08.80 → 12.83	GF		246-086-001-007C	HLWP	Plug Number (T2): 3b; T26: X11-246-003-014

**1.5 (51 kW | 1.5 Litre)**

08.81 → 07.83	JB		246-082-008-014C	SWP-M-C	Plug Number (T2): 1
08.80 → 12.83	JB		246-086-001-007C	HLWP	Plug Number (T2): 3b; T26: X11-246-003-014

**1.6 (53 kW | 1.6 Litre)**

04.86 → 07.90	RE		246-086-001-007C	HLWP	Plug Number (T2): 3b; T26: X11-246-003-014
---------------	----	--	------------------	------	--------------------------------------------

**1.6 (55 kW | 1.6 Litre)**

01.83 → 12.89	EW		246-082-008-014C	SWP-M-C	Plug Number (T2): 1
01.83 → 12.89	EW		246-086-001-007C	HLWP	Plug Number (T2): 3b; T26: X11-246-003-014

**1.6 (63 kW | 1.6 Litre)**

08.80 → 07.83	FR		246-082-008-014C	SWP-M-C	Plug Number (T2): 1
08.80 → 04.84	FR		246-086-001-007C	HLWP	Plug Number (T2): 3b; T26: X11-246-003-014

**1.6 (81 kW | 1.6 Litre)**

08.80 → 07.82	EG		246-086-001-007C	HLWP	Plug Number (T2): 3b; T26: X11-246-003-014
---------------	----	--	------------------	------	--------------------------------------------

**1.8 (66 kW | 1.8 Litre)**

08.83 → 07.90	EX		246-082-008-014C	SWP-M-C	Plug Number (T2): 1
08.83 → 07.92	EX		246-086-001-007C	HLWP	Plug Number (T2): 3b; T26: X11-246-003-014

**1.8 (70 kW | 1.8 Litre)**

11.85 → 07.92	JH		246-082-008-014C	SWP-M-C	Plug Number (T2): 1
11.85 → 07.92	JH		246-086-001-007C	HLWP	Plug Number (T2): 3b; T26: X11-246-003-014

**1.8 (82 kW | 1.8 Litre)**

08.82 → 07.87	DX, EV, PB, JJ		246-082-008-014C	SWP-M-C	Plug Number (T2): 1
08.82 → 12.89	DX, EV, PB, JJ		246-086-001-007C	HLWP	Plug Number (T2): 3b; T26: X11-246-003-014

**1.8 16V (102 kW | 1.8 Litre)**

10.85 → 07.89	KR		246-082-008-014C	SWP-M-C	Plug Number (T2): 1
10.85 → 07.89	KR		246-086-001-007C	HLWP	Plug Number (T2): 3b; T26: X11-246-003-014

**1.8 16V (95 kW | 1.8 Litre)**

03.86 → 07.90	PL		246-082-008-014C	SWP-M-C	Plug Number (T2): 1
03.86 → 07.92	PL		246-086-001-007C	HLWP	Plug Number (T2): 3b; T26: X11-246-003-014

**SHARAN (7M8, 7M9, 7M6)****1.8 T 20V (110 kW | 1.8 Litre)**

11.97 → 03.10	AJH, AWC		246-083-002-014G	SWP-D-C	Plug Number (T2): 6
09.97 → 03.10	AJH, AWC		246-083-002-022G	SWP-D-C	
11.97 → 03.10	AJH, AWC		246-086-001-002C	HLWP	Plug Number (T2): 3
09.97 → 03.10	AJH, AWC		246-086-001-007C	HLWP	Plug Number (T2): 3b; T26: X11-246-003-014

**1.9 TDI (110 kW | 1.9 Litre)**

06.05 → 03.10	BTB		246-083-002-022G	SWP-D-C	
06.05 → 03.10	BTB		246-086-001-007C	HLWP	Plug Number (T2): 3b

**1.9 TDI (66 kW | 1.9 Litre)**

09.95 → 06.96	1Z, AHU, ANU		246-083-002-014G	SWP-D-C	Plug Number (T2): 6
09.95 → 03.10	1Z, AHU, ANU		246-083-002-022G	SWP-D-C	
09.95 → 06.96	1Z, AHU, ANU		246-086-001-002C	HLWP	Plug Number (T2): 3
09.95 → 03.10	1Z, AHU, ANU		246-086-001-007C	HLWP	Plug Number (T2): 3b; T26: X11-246-003-014

**1.9 TDI (81 kW | 1.9 Litre)**

09.96 → 04.00	AFN, AVG		246-083-002-014G	SWP-D-C	Plug Number (T2): 6
09.96 → 04.00	AFN, AVG		246-083-002-022G	SWP-D-C	
09.96 → 04.00	AFN, AVG		246-086-001-002C	HLWP	Plug Number (T2): 3
09.96 → 04.00	AFN, AVG		246-086-001-007C	HLWP	Plug Number (T2): 3b; T26: X11-246-003-014

**1.9 TDI (85 kW | 1.9 Litre)**

04.00 → 03.10	AUY, BVK	- 1 - 000 001→	246-083-002-022G	SWP-D-C	
04.00 → 03.10	AUY, BVK		246-086-001-007C	HLWP	Plug Number (T2): 3b; T26: X11-246-003-014



			<b>VDO</b>		
Date	Engine Code	Chassis No.	Article No.	Product	Information

**VW****SHARAN (7M8, 7M9, 7M6)****1.9 TDI (96 kW | 1.9 Litre)**

11.02 → 03.10	ASZ		246-083-002-022G	SWP-D-C	
11.02 → 03.10	ASZ		246-086-001-007C	HLWP	Plug Number (T2): 3b

**1.9 TDI 4motion (85 kW | 1.9 Litre)**

04.00 → 03.10	AUY, BVK		246-083-002-022G	SWP-D-C	
04.00 → 03.10	AUY, BVK		246-086-001-007C	HLWP	Plug Number (T2): 3b; T26: X11-246-003-014

**2.0 (110 kW | 2.0 Litre)**

09.95 → 02.00	ABF		246-083-002-022G	SWP-D-C	T26: X11-246-003-014
09.95 → 02.00	ABF		246-086-001-007C	HLWP	Plug Number (T2): 3b

**2.0 (85 kW | 2.0 Litre)**

09.95 → 03.10	ADY, ATM		246-083-002-014G	SWP-D-C	Plug Number (T2): 6
09.95 → 03.10	ADY, ATM		246-083-002-022G	SWP-D-C	
09.95 → 03.10	ADY, ATM		246-086-001-002C	HLWP	Plug Number (T2): 3
09.95 → 03.10	ADY, ATM		246-086-001-007C	HLWP	Plug Number (T2): 3b; T26: X11-246-003-014

**2.0 LPG (85 kW | 2.0 Litre)**

04.06 → 03.10	ATM		246-083-002-022G	SWP-D-C	
04.06 → 03.10	ATM		246-086-001-007C	HLWP	Plug Number (T2): 3b

**2.0 TDI (103 kW | 2.0 Litre)**

11.05 → 03.10	BRT		246-083-002-022G	SWP-D-C	T26: 3B0 955 665 C
11.05 → 03.10	BRT		246-086-001-007C	HLWP	Plug Number (T2): 3b

**2.8 V6 24V (150 kW | 2.8 Litre)**

04.00 → 03.10	AYL		246-083-002-022G	SWP-D-C	
04.00 → 03.10	AYL		246-086-001-007C	HLWP	Plug Number (T2): 3b; T26: X11-246-003-014

**2.8 V6 24V 4motion (150 kW | 2.8 Litre)**

04.00 → 03.10	AYL	- 1 - 000 001→	246-083-002-022G	SWP-D-C	
04.00 → 03.10	AYL		246-086-001-007C	HLWP	Plug Number (T2): 3b; T26: X11-246-003-014

**2.8 VR6 (128 kW | 2.8 Litre)**

09.95 → 03.98	AAA, AMY		246-083-002-014G	SWP-D-C	Plug Number (T2): 6
04.00 → 04.00	AAA, AMY		246-083-002-022G	SWP-D-C	
09.95 → 03.98	AAA, AMY		246-086-001-002C	HLWP	Plug Number (T2): 3
09.95 → 04.00	AAA, AMY		246-086-001-007C	HLWP	Plug Number (T2): 3b; T26: X11-246-003-014

**2.8 VR6 Syncro (128 kW | 2.8 Litre)**

11.96 → 04.00	AAA, AMY	- 1 - 000 001→	246-083-002-022G	SWP-D-C	
11.96 → 04.00	AAA, AMY		246-086-001-007C	HLWP	Plug Number (T2): 3b; T26: X11-246-003-014

**SHARAN (7N)****1.4 TSI (110 kW | 1.4 Litre)**

05.10 →	CAVA		246-083-002-022G	SWP-D-C	
05.10 →	CAVA		246-086-001-007C	HLWP	Plug Number (T2): 3b

**2.0 TDI (100 kW | 2.0 Litre)**

05.10 →	CFFA		246-083-002-022G	SWP-D-C	
05.10 →	CFFA		246-086-001-007C	HLWP	Plug Number (T2): 3b

**2.0 TDI (103 kW | 2.0 Litre)**

05.10 →	CFFB		246-083-002-022G	SWP-D-C	
05.10 →	CFFB		246-086-001-007C	HLWP	Plug Number (T2): 3b

**2.0 TDI (125 kW | 2.0 Litre)**

08.10 →	CFGB		246-083-002-022G	SWP-D-C	
08.10 →	CFGB		246-086-001-007C	HLWP	Plug Number (T2): 3b

**TIGUAN (5N\_)****1.4 TSI (110 kW | 1.4 Litre)**

05.08 →	BWK, CAVA		246-083-002-022G	SWP-D-C	
05.08 →	BWK, CAVA		246-086-001-007C	HLWP	Plug Number (T2): 3b

**1.4 TSI (90 kW | 1.4 Litre)**

08.10 →	CAXA		246-083-002-022G	SWP-D-C	
08.10 →	CAXA		246-086-001-007C	HLWP	Plug Number (T2): 3b

**1.4 TSI 4motion (110 kW | 1.4 Litre)**

09.07 →	BWK, CAVA, CTHA		246-083-002-022G	SWP-D-C	
09.07 →	BWK, CAVA		246-086-001-007C	HLWP	Plug Number (T2): 3b

**2.0 TDI (103 kW | 2.0 Litre)**

03.08 →	CBAB		246-083-002-022G	SWP-D-C	
03.08 →	CBAB		246-086-001-007C	HLWP	Plug Number (T2): 3b



			<b>VDO</b>		
Date	Engine Code	Chassis No.	Article No.	Product	Information

**VW****TIGUAN (5N\_)****2.0 TDI (81 kW | 2.0 Litre)**

05.10 →	CFFD		246-083-002-022G	SWP-D-C	
05.10 →	CFFD		246-086-001-007C	HLWP	Plug Number (T2): 3b

**2.0 TDI 4motion (100 kW | 2.0 Litre)**

11.07 →	CBA A		246-083-002-022G	SWP-D-C	
11.07 →	CBA A		246-086-001-007C	HLWP	Plug Number (T2): 3b

**2.0 TDI 4motion (103 kW | 2.0 Litre)**

09.07 →	CBAB, CLJA, CFFB		246-083-002-022G	SWP-D-C	
09.07 →	CBAB		246-086-001-007C	HLWP	Plug Number (T2): 3b

**2.0 TDI 4motion (125 kW | 2.0 Litre)**

09.07 →	CBBB, CFGB		246-083-002-022G	SWP-D-C	
09.07 →	CBBB		246-086-001-007C	HLWP	Plug Number (T2): 3b

**2.0 TFSI 4motion (125 kW | 2.0 Litre)**

09.07 →	CAWA, CCZC		246-083-002-022G	SWP-D-C	
09.07 →	CAWA		246-086-001-007C	HLWP	Plug Number (T2): 3b

**2.0 TFSI 4motion (147 kW | 2.0 Litre)**

09.07 →	CAWB, CCZA, CCTA		246-083-002-022G	SWP-D-C	
09.07 →	CAWB, CCZA		246-086-001-007C	HLWP	Plug Number (T2): 3b

**TOUAREG (7LA, 7L6, 7L7)****2.5 R5 TDI (120 kW | 2.5 Litre)**

08.03 → 05.10	BLK		246-083-002-022G	SWP-D-C	
08.03 → 05.10	BLK		246-086-001-007C	HLWP	Plug Number (T2): 3b

**2.5 R5 TDI (128 kW | 2.5 Litre)**

01.03 → 05.10	BAC, BPE		246-083-002-022G	SWP-D-C	
01.03 → 05.10	BAC, BPE		246-086-001-007C	HLWP	Plug Number (T2): 3b

**3.0 TDI (155 kW | 3.0 Litre)**

04.06 → 05.10	BUN, CASB		246-083-002-022G	SWP-D-C	
04.06 → 05.10	BUN, CASB		246-086-001-007C	HLWP	Plug Number (T2): 3b

**3.0 V6 TDI (165 kW | 3.0 Litre)**

11.04 → 05.10	BKS		246-083-002-022G	SWP-D-C	
11.04 → 05.10	BKS, CATA		246-086-001-007C	HLWP	Plug Number (T2): 3b

**3.0 V6 TDI (176 kW | 3.0 Litre)**

11.07 → 05.10	CASA, CASC		246-083-002-022G	SWP-D-C	
11.07 → 05.10	CASA, CASC		246-086-001-007C	HLWP	Plug Number (T2): 3b

**3.2 V6 (162 kW | 3.2 Litre)**

10.02 → 11.06	AZZ, BAA, BKJ		246-083-002-022G	SWP-D-C	
10.02 → 11.06	AZZ, BKJ, BAA, BMW, BRJ, BMX		246-086-001-007C	HLWP	Plug Number (T2): 3b; T26: X11-246-003-014

**3.2 V6 (177 kW | 3.2 Litre)**

11.04 → 11.06	BMX		246-083-002-022G	SWP-D-C	
11.04 → 11.06			246-086-001-007C	HLWP	Plug Number (T2): 3b

**3.6 V6 FSI (206 kW | 3.6 Litre)**

10.05 → 05.10	BHK, BHL		246-083-002-022G	SWP-D-C	
10.05 → 05.10	BHK, BHL		246-086-001-007C	HLWP	Plug Number (T2): 3b

**4.2 V8 (228 kW | 4.2 Litre)**

12.02 → 11.06	AXQ, BHX		246-083-002-022G	SWP-D-C	
12.02 → 11.06	AXQ		246-086-001-007C	HLWP	Plug Number (T2): 3b

**4.2 V8 FSI (257 kW | 4.2 Litre)**

06.06 → 05.10	BAR		246-083-002-022G	SWP-D-C	
06.06 → 05.10	BAR		246-086-001-007C	HLWP	Plug Number (T2): 3b

**5.0 R50 TDI (257 kW | 5.0 Litre)**

08.07 → 05.10	CBWA		246-083-002-022G	SWP-D-C	T26: 3B0 955 665 C
08.07 → 05.10	CBWA		246-086-001-007C	HLWP	Plug Number (T2): 3b

**5.0 V10 TDI (230 kW | 5.0 Litre)**

10.02 → 05.10	AYH, BLE, BWF		246-083-002-022G	SWP-D-C	
10.02 → 05.10	AYH, BLE, BWF		246-086-001-007C	HLWP	Plug Number (T2): 3b; T26: X11-246-003-014

**6.0 W12 (331 kW | 6.0 Litre)**

08.04 → 05.10	BJN		246-083-002-022G	SWP-D-C	
08.04 → 05.10	BJN		246-086-001-007C	HLWP	Plug Number (T2): 3b

**TOUAREG (7P5)****3.0 V6 TDI (176 kW | 3.0 Litre)**

01.10 →	CASA		246-083-002-022G	SWP-D-C	
---------	------	--	------------------	---------	--



					
Date	Engine Code	Chassis No.	Article No.	Product	Information

**VW****TOUAREG (7P5)****3.0 V6 TDI (176 kW | 3.0 Litre)**

01.10 →	CASA		246-086-001-007C	HLWP	Plug Number (T2): 3b
---------	------	--	------------------	------	----------------------

**3.0 V6 TSI Hybrid (245 kW | 3.0 Litre)**

04.10 →	CGEA, CGFA		246-083-002-022G	SWP-D-C	
04.10 →	CGEA, CGFA		246-086-001-007C	HLWP	Plug Number (T2): 3b

**3.6 V6 FSI (206 kW | 3.6 Litre)**

04.10 →	CGRA		246-083-002-022G	SWP-D-C	
04.10 →	CGRA		246-086-001-007C	HLWP	Plug Number (T2): 3b

**4.2 V8 TDI (250 kW | 4.2 Litre)**

01.10 →	CKDA		246-083-002-022G	SWP-D-C	
01.10 →	CKDA		246-086-001-007C	HLWP	Plug Number (T2): 3b

**TOURAN (1T1, 1T2)****1.4 FSI (125 kW | 1.4 Litre)**

11.06 → 05.10	BLG, CAVB		246-083-002-022G	SWP-D-C	
---------------	-----------	--	------------------	---------	--

**1.4 TSI (103 kW | 1.4 Litre)**

02.06 → 05.10	BMV, CAVC		246-083-002-022G	SWP-D-C	
---------------	-----------	--	------------------	---------	--

**1.4 TSI EcoFuel (110 kW | 1.4 Litre)**

05.09 → 05.10	CDGA		246-083-002-022G	SWP-D-C	
---------------	------	--	------------------	---------	--

**1.6 (75 kW | 1.6 Litre)**

07.03 → 05.10	BGU, BSE, BSF	→1T-4-074 111	246-083-002-022G	SWP-D-C	
07.03 → 05.10	BGU, BSE, BSF		246-086-001-007C	HLWP	Plug Number (T2): 3b

**1.6 FSI (85 kW | 1.6 Litre)**

02.03 → 01.07	BAG, BLF, BLP	→1T-4-074 111	246-083-002-022G	SWP-D-C	
02.03 → 01.07	BAG, BLF, BLP		246-086-001-007C	HLWP	Plug Number (T2): 3b

**1.6 TDI (77 kW | 1.6 Litre)**

04.10 → 05.10	CAYC		246-083-002-022G	SWP-D-C	
---------------	------	--	------------------	---------	--

**1.9 TDI (66 kW | 1.9 Litre)**

11.04 → 05.10	BRU, BXJ, BXF		246-083-002-022G	SWP-D-C	
11.04 → 05.10	BRU, BXJ, BXF		246-086-001-007C	HLWP	Plug Number (T2): 3b

**1.9 TDI (74 kW | 1.9 Litre)**

02.03 → 05.04	AVQ	→1T-4-074 111	246-083-002-022G	SWP-D-C	
02.03 → 05.04	AVQ		246-086-001-007C	HLWP	Plug Number (T2): 3b

**1.9 TDI (77 kW | 1.9 Litre)**

08.03 → 05.10	BKC, BLS, BXE	→1T-4-074 111	246-083-002-022G	SWP-D-C	
08.03 → 05.10	BKC, BLS, BXE		246-086-001-007C	HLWP	Plug Number (T2): 3b

**2.0 EcoFuel (80 kW | 2.0 Litre)**

02.06 → 05.09	BSX		246-083-002-022G	SWP-D-C	
---------------	-----	--	------------------	---------	--

**2.0 FSI (110 kW | 2.0 Litre)**

10.03 → 11.05	BLX, BLY, AXW, BLR, BVY, BVZ	→1T-4-074 111	246-083-002-022G	SWP-D-C	
10.03 → 11.05	BLX, BLY, AXW, BLR, BVY, BVZ		246-086-001-007C	HLWP	Plug Number (T2): 3b

**2.0 FSI (85 kW | 2.0 Litre)**

10.04 → 05.10	BJZ		246-083-002-022G	SWP-D-C	
---------------	-----	--	------------------	---------	--

**2.0 TDI (100 kW | 2.0 Litre)**

02.03 → 05.10	AZV	→1T-4-074 111	246-083-002-022G	SWP-D-C	
02.03 → 05.10	AZV		246-086-001-007C	HLWP	Plug Number (T2): 3b

**2.0 TDI (103 kW | 2.0 Litre)**

12.05 → 05.10	BMM		246-083-002-022G	SWP-D-C	
---------------	-----	--	------------------	---------	--

**2.0 TDI (125 kW | 2.0 Litre)**

12.05 → 05.10	BMN, CFJA		246-083-002-022G	SWP-D-C	
---------------	-----------	--	------------------	---------	--

**2.0 TDI 16V (103 kW | 2.0 Litre)**

08.03 → 05.10	BKD	→1T-4-074 111	246-083-002-022G	SWP-D-C	
---------------	-----	---------------	------------------	---------	--

**TOURAN (1T3)****1.2 TSI (77 kW | 1.2 Litre)**

05.10 →	CBZB		246-083-002-022G	SWP-D-C	
---------	------	--	------------------	---------	--

**1.6 TDI (66 kW | 1.6 Litre)**

05.10 →	CAYB		246-083-002-022G	SWP-D-C	
---------	------	--	------------------	---------	--

**VENTO (1H2)****1.4 (40 kW | 1.4 Litre)**

11.91 → 09.98	ABD, AEX		246-069-056-001Z	N	
01.92 → 09.98	ABD, AEX		246-080-010-002Z	N-H	T24: CL →



			<b>VDO</b>		
Date	Engine Code	Chassis No.	Article No.	Product	Information

**VW****VENTO (1H2)****1.4 (40 kW | 1.4 Litre)**

11.91 - 07.95	ABD, AEX		246-082-008-021G	SWP-M-C	Plug Number (T2): 6
11.91 - 07.95	ABD, AEX		246-083-002-014G	SWP-D-C	Plug Number (T2): 6
11.91 - 09.98	ABD, AEX		246-086-001-007C	HLWP	Plug Number (T2): 3b; T26: X11-246-003-014

**1.4 (44 kW | 1.4 Litre)**

11.91 - 09.98	ABD, AEX		246-069-056-001Z	N	
01.92 - 09.98	ABD, AEX		246-080-010-002Z	N-H	T24: CL →
07.95 - 12.97	ABU, AEA, AEE		246-082-008-021G	SWP-M-C	Plug Number (T2): 6
07.95 - 12.97	ABD, AEX		246-083-002-014G	SWP-D-C	Plug Number (T2): 6
11.91 - 09.98	ABD, AEX		246-086-001-007C	HLWP	Plug Number (T2): 3b; T26: X11-246-003-014

**1.6 (55 kW | 1.6 Litre)**

09.92 - 09.98	ABU, AEA, AEE		246-069-056-001Z	N	
09.92 - 09.98	ABU, AEA, AEE		246-080-010-002Z	N-H	T24: CL →
09.92 - 12.97	ABU, AEA, AEE		246-082-008-021G	SWP-M-C	Plug Number (T2): 6
09.92 - 09.98	ABU, AEA, AEE	1H-R-456 001→	246-082-008-025G	SWP-M-C	
09.92 - 12.97	ABU, AEA, AEE		246-083-002-014G	SWP-D-C	Plug Number (T2): 6
09.92 - 09.98	ABU, AEA, AEE		246-086-001-007C	HLWP	Plug Number (T2): 3b; T26: X11-246-003-014

**1.6 (74 kW | 1.6 Litre)**

10.94 - 09.98	AEK, AFT		246-069-056-001Z	N	
10.94 - 09.98	AEK, AFT		246-080-010-002Z	N-H	T24: CL →
10.94 - 12.97	AEK, AFT		246-082-008-021G	SWP-M-C	Plug Number (T2): 6
10.94 - 09.98	AEK, AFT		246-082-008-025G	SWP-M-C	
10.94 - 12.97	AEK, AFT		246-083-002-014G	SWP-D-C	Plug Number (T2): 6
10.94 - 09.98	AEK, AFT		246-086-001-007C	HLWP	Plug Number (T2): 3b; T26: X11-246-003-014

**1.8 (55 kW | 1.8 Litre)**

11.91 - 09.98	AAM		246-069-056-001Z	N	
01.92 - 09.98	AAM		246-080-010-002Z	N-H	T24: CL →
11.91 - 12.97	AAM		246-082-008-021G	SWP-M-C	Plug Number (T2): 6
11.91 - 12.97	AAM		246-083-002-014G	SWP-D-C	Plug Number (T2): 6
11.91 - 09.98	AAM		246-086-001-007C	HLWP	Plug Number (T2): 3b; T26: X11-246-003-014

**1.8 (66 kW | 1.8 Litre)**

11.91 - 09.98	ABS, ADZ		246-069-056-001Z	N	
01.92 - 09.98	ABS, ADZ		246-080-010-002Z	N-H	T24: CL →
11.91 - 12.97	ABS, ADZ		246-082-008-021G	SWP-M-C	Plug Number (T2): 6
11.91 - 12.97	ABS, ADZ		246-083-002-014G	SWP-D-C	Plug Number (T2): 6
11.91 - 09.98	ABS, ADZ		246-086-001-007C	HLWP	Plug Number (T2): 3b; T26: X11-246-003-014

**1.9 D (48 kW | 1.9 Litre)**

11.91 - 09.98	1Y		246-069-056-001Z	N	
01.92 - 09.98	1Y		246-080-010-002Z	N-H	T24: CL →
11.91 - 12.97	1Y		246-082-008-021G	SWP-M-C	Plug Number (T2): 6
11.91 - 12.97	1Y		246-083-002-014G	SWP-D-C	Plug Number (T2): 6
11.91 - 09.98	1Y		246-086-001-007C	HLWP	Plug Number (T2): 3b; T26: X11-246-003-014

**1.9 SDI (47 kW | 1.9 Litre)**

04.97 - 09.98	AEY		246-069-056-001Z	N	
04.97 - 09.98	AEY		246-080-010-002Z	N-H	T24: CL →
04.97 - 12.97	AEY		246-082-008-021G	SWP-M-C	Plug Number (T2): 6
04.97 - 09.98	AEY		246-082-008-025G	SWP-M-C	
04.97 - 12.97	AEY		246-083-002-014G	SWP-D-C	Plug Number (T2): 6
04.97 - 09.98	AEY		246-086-001-007C	HLWP	Plug Number (T2): 3b; T26: X11-246-003-014

**1.9 TD (55 kW | 1.9 Litre)**

11.91 - 09.98	AAZ		246-069-056-001Z	N	
01.92 - 09.98	AAZ		246-080-010-002Z	N-H	T24: CL →
11.91 - 12.97	AAZ		246-082-008-021G	SWP-M-C	Plug Number (T2): 6
11.91 - 12.97	AAZ		246-083-002-014G	SWP-D-C	Plug Number (T2): 6
11.91 - 09.98	AAZ		246-086-001-007C	HLWP	Plug Number (T2): 3b; T26: X11-246-003-014

**1.9 TDI (66 kW | 1.9 Litre)**

09.93 - 09.98	1Z, AHU, ALE		246-069-056-001Z	N	
09.93 - 09.98	1Z, AHU, ALE		246-080-010-002Z	N-H	T24: CL →
09.93 - 12.97	1Z, AHU, ALE		246-082-008-021G	SWP-M-C	Plug Number (T2): 6
09.93 - 12.97	1Z, AHU, ALE		246-083-002-014G	SWP-D-C	Plug Number (T2): 6
09.93 - 09.98	1Z, AHU, ALE		246-086-001-007C	HLWP	Plug Number (T2): 3b; T26: X11-246-003-014

**1.9 TDI (81 kW | 1.9 Litre)**

04.96 - 09.98	AFN		246-069-056-001Z	N	
---------------	-----	--	------------------	---	--





			<b>VDO</b>		
Date	Engine Code	Chassis No.	Article No.	Product	Information

**VW****VENTO (1H2)****1.9 TDI (81 kW | 1.9 Litre)**

04.96 - 09.98	AFN		246-080-010-002Z	N-H	T24: CL →
04.96 - 12.97	AFN		246-082-008-021G	SWP-M-C	Plug Number (T2): 6
04.96 - 09.98	AFN		246-082-008-025G	SWP-M-C	
04.96 - 12.97	AFN		246-083-002-014G	SWP-D-C	Plug Number (T2): 6
04.96 - 09.98	AFN		246-086-001-007C	HLWP	Plug Number (T2): 3b; T26: X11-246-003-014

**2.0 (85 kW | 2.0 Litre)**

11.91 - 09.98	2E, ADY, AGG, AKR		246-069-056-001Z	N	
01.92 - 09.98	2E, ADY, AGG, AKR		246-080-010-002Z	N-H	T24: CL →
11.91 - 12.97	2E, ADY, AGG, AKR		246-082-008-021G	SWP-M-C	Plug Number (T2): 6
11.91 - 12.97	2E, ADY, AGG, AKR		246-083-002-014G	SWP-D-C	Plug Number (T2): 6
11.91 - 09.98	2E, ADY, AGG, AKR		246-086-001-007C	HLWP	Plug Number (T2): 3b; T26: X11-246-003-014

**2.8 VR6 (128 kW | 2.8 Litre)**

01.92 - 09.98	AAA		246-069-056-001Z	N	
01.92 - 09.98	AAA		246-080-010-002Z	N-H	T24: CL →
01.92 - 12.97	AAA		246-082-008-021G	SWP-M-C	Plug Number (T2): 6
01.92 - 09.98	AAA		246-082-008-025G	SWP-M-C	
01.92 - 12.97	AAA		246-083-002-014G	SWP-D-C	Plug Number (T2): 6
01.92 - 09.98	AAA		246-086-001-007C	HLWP	Plug Number (T2): 3b; T26: X11-246-003-014

**1500,1600 Variant (36)****1.5 (33 kW | 1.5 Litre)**

04.61 - 07.73	K		246-075-021-006C	SWP-M-G	Plug Number (T2): 1
---------------	---	--	------------------	---------	---------------------

**1.6 L (40 kW | 1.6 Litre)**

08.65 - 07.73	T, U		246-075-021-006C	SWP-M-G	Plug Number (T2): 1
---------------	------	--	------------------	---------	---------------------

**LT 28-35 | Bus (281-363)****2.0 (55 kW | 2.0 Litre)**

04.75 - 08.77	CH	→287 2600 000	246-075-021-006C	SWP-M-G	Plug Number (T2): 1
08.77 - 11.82	CH	287 2600 001→	246-082-008-014C	SWP-M-C	Plug Number (T2): 1

**2.4 (66 kW | 2.4 Litre)**

12.82 - 07.92	DL		246-082-008-014C	SWP-M-C	Plug Number (T2): 1
---------------	----	--	------------------	---------	---------------------

**2.4 D (51 kW | 2.4 Litre)**

08.89 - 07.92	ACT, 1S		246-082-008-014C	SWP-M-C	Plug Number (T2): 1
---------------	---------	--	------------------	---------	---------------------

**2.4 D (55 kW | 2.4 Litre)**

01.79 - 07.92	CP, DW	28-D-007 274→	246-086-001-007C	HLWP	Plug Number (T2): 3b
---------------	--------	---------------	------------------	------	----------------------

**2.4 i (69 kW | 2.4 Litre)**

08.89 - 06.96	1E		246-082-008-014C	SWP-M-C	Plug Number (T2): 1
---------------	----	--	------------------	---------	---------------------

**2.4 TD (68 kW | 2.4 Litre)**

08.89 - 08.92	1G	28-D-007 274→	246-086-001-007C	HLWP	Plug Number (T2): 3b
---------------	----	---------------	------------------	------	----------------------

**2.4 TD (70 kW | 2.4 Litre)**

09.92 - 06.96	ACL	28-D-007 274→	246-086-001-007C	HLWP	Plug Number (T2): 3b
---------------	-----	---------------	------------------	------	----------------------

**2.4 TD (75 kW | 2.4 Litre)**

12.82 - 07.89	DV		246-082-008-014C	SWP-M-C	Plug Number (T2): 1
---------------	----	--	------------------	---------	---------------------

**LT 28-35 | Box (281-363)****2.0 (55 kW | 2.0 Litre)**

04.75 - 09.83	CH	28-D-007-274→	246-075-021-006C	SWP-M-G	Plug Number (T2): 1
04.75 - 09.83	CH	28-D-007 274→	246-086-001-007C	HLWP	Plug Number (T2): 3b

**2.4 (66 kW | 2.4 Litre)**

12.82 - 07.92	DL	28-D-007 274→	246-086-001-007C	HLWP	Plug Number (T2): 3b
---------------	----	---------------	------------------	------	----------------------

**2.4 D (51 kW | 2.4 Litre)**

08.92 - 05.96	1S, ACT		246-082-008-014C	SWP-M-C	Plug Number (T2): 1
---------------	---------	--	------------------	---------	---------------------

08.92 - 05.96	1S, ACT	- P - 000 001→	246-086-001-007C	HLWP	Plug Number (T2): 3b; T26: X11-246-003-014
---------------	---------	----------------	------------------	------	--------------------------------------------

**2.4 D (55 kW | 2.4 Litre)**

01.79 - 07.92	CP, DW	28-D-007 274→	246-086-001-007C	HLWP	Plug Number (T2): 3b
---------------	--------	---------------	------------------	------	----------------------

**2.4 i (69 kW | 2.4 Litre)**

03.94 - 06.96	1E		246-082-008-014C	SWP-M-C	Plug Number (T2): 1
---------------	----	--	------------------	---------	---------------------

03.94 - 06.96	1E	- P - 000 001→	246-086-001-007C	HLWP	Plug Number (T2): 3b; T26: X11-246-003-014
---------------	----	----------------	------------------	------	--------------------------------------------

**2.4 TD (68 kW | 2.4 Litre)**

08.92 - 08.92	1G	- P - 000 001→	246-086-001-007C	HLWP	Plug Number (T2): 3b; T26: X11-246-003-014
---------------	----	----------------	------------------	------	--------------------------------------------

**2.4 TD (70 kW | 2.4 Litre)**

08.92 - 05.96	ACL	- P - 000 001→	246-086-001-007C	HLWP	Plug Number (T2): 3b; T26: X11-246-003-014
---------------	-----	----------------	------------------	------	--------------------------------------------



			<b>VDO</b>		
Date	Engine Code	Chassis No.	Article No.	Product	Information

**VW****LT 28-35 I Box (281-363)****2.4 TD (75 kW | 2.4 Litre)**

08.92 → 08.92	DV	- P - 000 001→	246-086-001-007C	HLWP	Plug Number (T2): 3b; T26: X11-246-003-014
---------------	----	----------------	------------------	------	--------------------------------------------

**2.7 D (48 kW | 2.7 Litre)**

01.76 → 08.77	CG	→287 2600 000	246-075-021-006C	SWP-M-G	Plug Number (T2): 1
08.77 → 01.80	CG	287 2600 001→	246-082-008-014C	SWP-M-C	Plug Number (T2): 1

**LT 28-35 I Platform/Chassis (281-363)****2.0 (55 kW | 2.0 Litre)**

12.82 → 09.83	CH	- D - 007 274→	246-086-001-007C	HLWP	Plug Number (T2): 3b; T26: X11-246-003-014
---------------	----	----------------	------------------	------	--------------------------------------------

**2.4 (66 kW | 2.4 Litre)**

08.88 → 07.92	DL		246-082-008-014C	SWP-M-C	Plug Number (T2): 1
12.82 → 07.92	DL	- D - 007 274→	246-086-001-007C	HLWP	Plug Number (T2): 3b; T26: X11-246-003-014

**2.4 D (51 kW | 2.4 Litre)**

08.90 → 06.96	1S, ACT	- D - 007 274→	246-086-001-007C	HLWP	Plug Number (T2): 3b; T26: X11-246-003-014
---------------	---------	----------------	------------------	------	--------------------------------------------

**2.4 D (55 kW | 2.4 Litre)**

01.79 → 02.91	CP, DW		246-082-008-014C	SWP-M-C	Plug Number (T2): 1
12.82 → 02.91	CP, DW	- D - 007 274→	246-086-001-007C	HLWP	Plug Number (T2): 3b; T26: X11-246-003-014

**2.4 i (69 kW | 2.4 Litre)**

03.94 → 06.96	1E		246-082-008-014C	SWP-M-C	Plug Number (T2): 1
03.94 → 06.96	1E	- D - 007 274→	246-086-001-007C	HLWP	Plug Number (T2): 3b; T26: X11-246-003-014

**2.4 TD (68 kW | 2.4 Litre)**

08.90 → 08.92	1G	- D - 007 274→	246-086-001-007C	HLWP	Plug Number (T2): 3b; T26: X11-246-003-014
---------------	----	----------------	------------------	------	--------------------------------------------

**2.4 TD (70 kW | 2.4 Litre)**

09.92 → 06.96	ACL		246-082-008-014C	SWP-M-C	Plug Number (T2): 1
08.92 → 06.96	ACL	- D - 007 274→	246-086-001-007C	HLWP	Plug Number (T2): 3b; T26: X11-246-003-014

**2.4 TD (75 kW | 2.4 Litre)**

12.82 → 07.92	DV		246-082-008-014C	SWP-M-C	Plug Number (T2): 1
12.82 → 09.93	DV	- D - 007 274→	246-086-001-007C	HLWP	Plug Number (T2): 3b; T26: X11-246-003-014

**2.7 D (48 kW | 2.7 Litre)**

11.75 → 01.80	CG	28-D-007-274→	246-075-021-006C	SWP-M-G	Plug Number (T2): 1
11.75 → 01.80	CG	28-D-007 274→	246-086-001-007C	HLWP	Plug Number (T2): 3b

**LT 40-55 I Box (291-512)****2.0 (55 kW | 2.0 Litre)**

08.78 → 11.82	CH		246-082-008-014C	SWP-M-C	Plug Number (T2): 1
---------------	----	--	------------------	---------	---------------------

**2.4 D (51 kW | 2.4 Litre)**

07.90 → 07.92	1S, ACT		246-082-008-014C	SWP-M-C	Plug Number (T2): 1
---------------	---------	--	------------------	---------	---------------------

**2.4 TD (68 kW | 2.4 Litre)**

10.88 → 08.92	1G		246-082-008-014C	SWP-M-C	Plug Number (T2): 1
---------------	----	--	------------------	---------	---------------------

**2.4 TD (75 kW | 2.4 Litre)**

02.86 → 08.92	DV		246-082-008-014C	SWP-M-C	Plug Number (T2): 1
---------------	----	--	------------------	---------	---------------------

**2.4 TD 4WD (75 kW | 2.4 Litre)**

08.85 → 07.91	DV		246-082-008-014C	SWP-M-C	Plug Number (T2): 1
---------------	----	--	------------------	---------	---------------------

**LT 40-55 I Platform/Chassis (293-909)****2.0 (55 kW | 2.0 Litre)**

04.75 → 09.83	CH		246-075-021-006C	SWP-M-G	Plug Number (T2): 1
---------------	----	--	------------------	---------	---------------------

**LT 28-35 II Bus (2DM)****2.3 (105 kW | 2.3 Litre)**

05.96 → 07.06	AGL		246-082-008-014C	SWP-M-C	Plug Number (T2): 1
05.96 → 07.06	AGL		246-086-001-007C	HLWP	Plug Number (T2): 3b

**2.5 SDI (55 kW | 2.5 Litre)**

07.96 → 07.06	AGX		246-082-008-014C	SWP-M-C	Plug Number (T2): 1
07.96 → 07.06	AGX		246-086-001-007C	HLWP	Plug Number (T2): 3b

**2.5 TDI (61 kW | 2.5 Litre)**

05.01 → 07.06	BBE		246-082-008-014C	SWP-M-C	Plug Number (T2): 1
05.01 → 07.06	BBE		246-086-001-007C	HLWP	Plug Number (T2): 3b

**2.5 TDI (66 kW | 2.5 Litre)**

05.99 → 07.06	APA		246-082-008-014C	SWP-M-C	Plug Number (T2): 1
05.99 → 07.06	APA		246-086-001-007C	HLWP	Plug Number (T2): 3b

**2.5 TDI (70 kW | 2.5 Litre)**

05.01 → 07.06	BBF		246-082-008-014C	SWP-M-C	Plug Number (T2): 1
---------------	-----	--	------------------	---------	---------------------



			<b>VDO</b>		
Date	Engine Code	Chassis No.	Article No.	Product	Information

**VW****LT 28-35 II Bus (2DM)**

<b>2.5 TDI (70 kW   2.5 Litre)</b>					
05.01 → 07.06	BBF		246-086-001-007C	HLWP	Plug Number (T2): 3b
<b>2.5 TDI (75 kW   2.5 Litre)</b>					
05.96 → 08.99	AHD		246-082-008-014C	SWP-M-C	Plug Number (T2): 1
05.96 → 08.99	AHD		246-086-001-007C	HLWP	Plug Number (T2): 3b
<b>2.5 TDI (80 kW   2.5 Litre)</b>					
05.99 → 07.06	ANJ, AVR		246-082-008-014C	SWP-M-C	Plug Number (T2): 1
05.99 → 07.06	ANJ, AVR		246-086-001-007C	HLWP	Plug Number (T2): 3b

**LT 28-46 II Box (2DX0AE)**

<b>2.3 (105 kW   2.3 Litre)</b>					
05.96 → 07.06	AGL		246-082-008-014C	SWP-M-C	Plug Number (T2): 1
05.96 → 07.06	AGL		246-086-001-002C	HLWP	Plug Number (T2): 3
05.96 → 07.06	AGL		246-086-001-007C	HLWP	Plug Number (T2): 3b; T26: X11-246-003-014
<b>2.5 SDI (55 kW   2.5 Litre)</b>					
09.96 → 07.06	AGX		246-086-001-007C	HLWP	Plug Number (T2): 3b; T26: X11-246-003-014
<b>2.5 TDI (61 kW   2.5 Litre)</b>					
05.01 → 07.06	BBE		246-086-001-007C	HLWP	Plug Number (T2): 3b; T26: X11-246-003-014
<b>2.5 TDI (66 kW   2.5 Litre)</b>					
05.99 → 07.06	APA		246-086-001-007C	HLWP	Plug Number (T2): 3b; T26: X11-246-003-014
<b>2.5 TDI (70 kW   2.5 Litre)</b>					
05.01 → 07.06	BBF		246-086-001-007C	HLWP	Plug Number (T2): 3b; T26: X11-246-003-014
<b>2.5 TDI (75 kW   2.5 Litre)</b>					
05.96 → 04.97	AHD		246-082-008-014C	SWP-M-C	Plug Number (T2): 1
05.96 → 04.97	AHD		246-086-001-002C	HLWP	Plug Number (T2): 3
05.96 → 08.99	AHD		246-086-001-007C	HLWP	Plug Number (T2): 3b; T26: X11-246-003-014
<b>2.5 TDI (80 kW   2.5 Litre)</b>					
05.99 → 07.06	ANJ, AVR		246-086-001-007C	HLWP	Plug Number (T2): 3b; T26: X11-246-003-014
<b>2.8 TDI (116 kW   2.8 Litre)</b>					
04.02 → 07.06	AUH, BCQ		246-086-001-007C	HLWP	Plug Number (T2): 3b; T26: X11-246-003-014
<b>2.8 TDI (92 kW   2.8 Litre)</b>					
06.97 → 09.98	AGK		246-082-008-014C	SWP-M-C	Plug Number (T2): 1
06.97 → 09.98	AGK		246-086-001-002C	HLWP	Plug Number (T2): 3
06.97 → 12.98	AGK		246-086-001-007C	HLWP	Plug Number (T2): 3b; T26: X11-246-003-014
<b>2.8 TDI (96 kW   2.8 Litre)</b>					
01.99 → 07.06	ATA		246-086-001-007C	HLWP	Plug Number (T2): 3b; T26: X11-246-003-014

**LT 28-46 II Platform/Chassis (2DX0FE)**

<b>2.3 (105 kW   2.3 Litre)</b>					
06.96 → 07.06	AGL		246-082-008-014C	SWP-M-C	Plug Number (T2): 1
06.96 → 07.06	AGL		246-086-001-002C	HLWP	Plug Number (T2): 3
<b>2.5 SDI (55 kW   2.5 Litre)</b>					
09.96 → 07.06	AGX		246-082-008-014C	SWP-M-C	Plug Number (T2): 1
09.96 → 07.06	AGX		246-086-001-002C	HLWP	Plug Number (T2): 3
<b>2.5 TDI (61 kW   2.5 Litre)</b>					
05.01 → 07.06	BBE		246-082-008-014C	SWP-M-C	Plug Number (T2): 1
05.01 → 07.06	BBE		246-086-001-007C	HLWP	Plug Number (T2): 3b
<b>2.5 TDI (66 kW   2.5 Litre)</b>					
05.99 → 07.06	APA		246-082-008-014C	SWP-M-C	Plug Number (T2): 1
05.99 → 07.06	APA		246-086-001-007C	HLWP	Plug Number (T2): 3b
<b>2.5 TDI (70 kW   2.5 Litre)</b>					
05.01 → 07.06	BBF		246-082-008-014C	SWP-M-C	Plug Number (T2): 1
05.01 → 07.06	BBF		246-086-001-007C	HLWP	Plug Number (T2): 3b
<b>2.5 TDI (75 kW   2.5 Litre)</b>					
06.96 → 08.99	AHD		246-082-008-014C	SWP-M-C	Plug Number (T2): 1
06.96 → 08.99	AHD		246-086-001-007C	HLWP	Plug Number (T2): 3b
<b>2.5 TDI (80 kW   2.5 Litre)</b>					
05.99 → 07.06	ANJ, AVR		246-082-008-014C	SWP-M-C	Plug Number (T2): 1
05.99 → 07.06	ANJ, AVR		246-086-001-007C	HLWP	Plug Number (T2): 3b
<b>2.8 TDI (116 kW   2.8 Litre)</b>					
04.02 → 07.06	AUH, BCQ		246-082-008-014C	SWP-M-C	Plug Number (T2): 1
04.02 → 07.06	AUH, BCQ		246-086-001-007C	HLWP	Plug Number (T2): 3b



			<b>VDO</b>	
Date	Engine Code	Chassis No.	Article No.	Product Information

**VW****LT 28-46 II Platform/Chassis (2DX0FE)****2.8 TDI (92 kW | 2.8 Litre)**

06.97 - 12.98	AGK		246-082-008-014C	SWP-M-C	Plug Number (T2): 1
06.97 - 12.98	AGK		246-086-001-007C	HLWP	Plug Number (T2): 3b

**2.8 TDI (96 kW | 2.8 Litre)**

01.99 - 07.06	ATA		246-082-008-014C	SWP-M-C	Plug Number (T2): 1
01.99 - 07.06	ATA		246-086-001-007C	HLWP	Plug Number (T2): 3b

**TRANSPORTER II Bus****1.6 (34 kW | 1.6 Litre)**

08.67 - 07.70	AF		246-075-021-006C	SWP-M-G	Plug Number (T2): 1
08.67 - 07.70	AF		246-086-001-007C	HLWP	Plug Number (T2): 3b

**1.6 (37 kW | 1.6 Litre)**

08.70 - 04.79	AD, AH, AS		246-086-001-007C	HLWP	Plug Number (T2): 3b
---------------	------------	--	------------------	------	----------------------

**1.7 (49 kW | 1.7 Litre)**

08.71 - 10.73	CA, CB		246-086-001-007C	HLWP	Plug Number (T2): 3b
---------------	--------	--	------------------	------	----------------------

**1.8 (50 kW | 1.8 Litre)**

11.73 - 07.75	AP		246-086-001-007C	HLWP	Plug Number (T2): 3b
---------------	----	--	------------------	------	----------------------

**2.0 (51 kW | 2.0 Litre)**

08.75 - 04.79	CJ, GD, GE		246-086-001-007C	HLWP	Plug Number (T2): 3b
---------------	------------	--	------------------	------	----------------------

**TRANSPORTER II Box****1.6 (37 kW | 1.6 Litre)**

08.70 - 04.79	AE, AD, AS		246-086-001-007C	HLWP	Plug Number (T2): 3b
---------------	------------	--	------------------	------	----------------------

**1.7 (49 kW | 1.7 Litre)**

08.71 - 12.73	CA, CB		246-086-001-007C	HLWP	Plug Number (T2): 3b
---------------	--------	--	------------------	------	----------------------

**1.8 (50 kW | 1.8 Litre)**

11.73 - 07.75	AP		246-086-001-007C	HLWP	Plug Number (T2): 3b
---------------	----	--	------------------	------	----------------------

**2.0 (51 kW | 2.0 Litre)**

08.75 - 07.79	GE, GD, CJ		246-086-001-007C	HLWP	Plug Number (T2): 3b
---------------	------------	--	------------------	------	----------------------

**TRANSPORTER II Platform/Chassis****1.6 (37 kW | 1.6 Litre)**

08.68 - 07.79	AS, AD		246-075-021-006C	SWP-M-G	Plug Number (T2): 1
08.68 - 07.79	AS, AD		246-086-001-007C	HLWP	Plug Number (T2): 3b

**TRANSPORTER III Bus****1.6 (37 kW | 1.6 Litre)**

05.79 - 12.82	CT		246-082-008-014C	SWP-M-C	Plug Number (T2): 1
05.79 - 12.82	CT		246-086-001-007C	HLWP	Plug Number (T2): 3b; T26: X11-246-003-014

**1.6 D (37 kW | 1.6 Litre)**

01.81 - 07.87	CS		246-086-001-007C	HLWP	Plug Number (T2): 3b; T26: X11-246-003-014
---------------	----	--	------------------	------	--------------------------------------------

**1.6 TD (51 kW | 1.6 Litre)**

08.84 - 07.91	JX		246-082-008-014C	SWP-M-C	Plug Number (T2): 1
08.84 - 07.92	JX		246-086-001-007C	HLWP	Plug Number (T2): 3b; T26: X11-246-003-014

**1.6 TD Syncro (51 kW | 1.6 Litre)**

03.86 - 09.91	JX		246-082-008-014C	SWP-M-C	Plug Number (T2): 1
03.86 - 07.92	JX		246-086-001-007C	HLWP	Plug Number (T2): 3b; T26: X11-246-003-014

**1.7 D (42 kW | 1.7 Litre)**

10.86 - 07.91	KY		246-082-008-014C	SWP-M-C	Plug Number (T2): 1
10.86 - 07.92	KY		246-086-001-007C	HLWP	Plug Number (T2): 3b; T26: X11-246-003-014

**1.9 (44 kW | 1.9 Litre)**

08.82 - 07.92	DF		246-086-001-007C	HLWP	Plug Number (T2): 3b; T26: X11-246-003-014
---------------	----	--	------------------	------	--------------------------------------------

**1.9 (57 kW | 1.9 Litre)**

08.82 - 07.92	DG		246-086-001-007C	HLWP	Plug Number (T2): 3b; T26: X11-246-003-014
---------------	----	--	------------------	------	--------------------------------------------

**1.9 (61 kW | 1.9 Litre)**

01.83 - 07.85	DH		246-082-008-014C	SWP-M-C	Plug Number (T2): 1
01.83 - 07.85	DH		246-086-001-007C	HLWP	Plug Number (T2): 3b; T26: X11-246-003-014

**1.9 (66 kW | 1.9 Litre)**

08.83 - 07.85	GW		246-086-001-007C	HLWP	Plug Number (T2): 3b; T26: X11-246-003-014
---------------	----	--	------------------	------	--------------------------------------------

**1.9 Syncro (57 kW | 1.9 Litre)**

02.85 - 07.91	X 16 SZ		246-082-008-014C	SWP-M-C	Plug Number (T2): 1
02.85 - 07.92	DG		246-086-001-007C	HLWP	Plug Number (T2): 3b; T26: X11-246-003-014



			<b>VDO</b>		
Date	Engine Code	Chassis No.	Article No.	Product	Information

**VW****TRANSPORTER III Bus**

<b>2.0 (51 kW   2.0 Litre)</b>					
05.79 - 12.82	CU, CV		246-082-008-014C	SWP-M-C	Plug Number (T2): 1
05.79 - 12.82	CU, CV		246-086-001-007C	HLWP	Plug Number (T2): 3b; T26: X11-246-003-014
<b>2.1 (64 kW   2.1 Litre)</b>					
10.86 - 07.91	SR		246-082-008-014C	SWP-M-C	Plug Number (T2): 1
10.86 - 07.92	SR		246-086-001-007C	HLWP	Plug Number (T2): 3b; T26: X11-246-003-014
<b>2.1 (70 kW   2.1 Litre)</b>					
08.85 - 07.92	MV		246-086-001-007C	HLWP	Plug Number (T2): 3b; T26: X11-246-003-014
<b>2.1 (82 kW   2.1 Litre)</b>					
08.85 - 07.92	DJ		246-086-001-007C	HLWP	Plug Number (T2): 3b; T26: X11-246-003-014
<b>2.1 CAT (70 kW   2.1 Litre)</b>					
06.89 - 07.92	MV		246-086-001-007C	HLWP	Plug Number (T2): 3b; T26: X11-246-003-014
<b>2.1 i (68 kW   2.1 Litre)</b>					
07.89 - 07.92	SS		246-086-001-007C	HLWP	Plug Number (T2): 3b; T26: X11-246-003-014
<b>2.1 Syncro (64 kW   2.1 Litre)</b>					
10.86 - 08.91	SR		246-082-008-014C	SWP-M-C	Plug Number (T2): 1
10.86 - 07.92	SR		246-086-001-007C	HLWP	Plug Number (T2): 3b; T26: X11-246-003-014
<b>2.1 Syncro (70 kW   2.1 Litre)</b>					
08.85 - 09.91	MV		246-082-008-014C	SWP-M-C	Plug Number (T2): 1
08.85 - 07.92	MV		246-086-001-007C	HLWP	Plug Number (T2): 3b; T26: X11-246-003-014
<b>2.1 Syncro (82 kW   2.1 Litre)</b>					
01.86 - 07.92	DJ		246-086-001-007C	HLWP	Plug Number (T2): 3b; T26: X11-246-003-014

**TRANSPORTER III Box**

<b>1.6 TD Syncro (51 kW   1.6 Litre)</b>					
03.86 - 09.91	JX		246-082-008-014C	SWP-M-C	Plug Number (T2): 1
<b>1.9 (44 kW   1.9 Litre)</b>					
08.85 - 07.91	DF		246-082-008-014C	SWP-M-C	Plug Number (T2): 1
<b>1.9 (66 kW   1.9 Litre)</b>					
08.83 - 07.85	GW		246-082-008-014C	SWP-M-C	Plug Number (T2): 1
<b>1.9 Syncro (57 kW   1.9 Litre)</b>					
11.84 - 07.91	DG		246-082-008-014C	SWP-M-C	Plug Number (T2): 1
<b>2.0 (51 kW   2.0 Litre)</b>					
05.79 - 12.82	CU		246-082-008-014C	SWP-M-C	Plug Number (T2): 1

**TRANSPORTER III Platform/Chassis**

<b>1.6 D (37 kW   1.6 Litre)</b>					
01.81 - 07.87	CS		246-082-008-014C	SWP-M-C	Plug Number (T2): 1
01.81 - 07.87	CS		246-086-001-007C	HLWP	Plug Number (T2): 3b; T26: X11-246-003-014
<b>1.6 TD (51 kW   1.6 Litre)</b>					
10.84 - 07.92	JX		246-086-001-007C	HLWP	Plug Number (T2): 3b; T26: X11-246-003-014
<b>1.6 TD Syncro (51 kW   1.6 Litre)</b>					
03.86 - 07.92	JX		246-086-001-007C	HLWP	Plug Number (T2): 3b; T26: X11-246-003-014
<b>1.7 D (42 kW   1.7 Litre)</b>					
07.89 - 07.92	KY		246-086-001-007C	HLWP	Plug Number (T2): 3b; T26: X11-246-003-014
<b>1.9 (44 kW   1.9 Litre)</b>					
09.82 - 07.91	DF		246-082-008-014C	SWP-M-C	Plug Number (T2): 1
09.82 - 07.92	DF		246-086-001-007C	HLWP	Plug Number (T2): 3b; T26: X11-246-003-014
<b>1.9 (57 kW   1.9 Litre)</b>					
08.82 - 07.91	DG		246-082-008-014C	SWP-M-C	Plug Number (T2): 1
08.82 - 07.92	DG		246-086-001-007C	HLWP	Plug Number (T2): 3b; T26: X11-246-003-014
<b>1.9 Syncro (57 kW   1.9 Litre)</b>					
12.84 - 07.92	DG		246-086-001-007C	HLWP	Plug Number (T2): 3b; T26: X11-246-003-014
<b>2.0 (51 kW   2.0 Litre)</b>					
05.79 - 04.86	CU		246-086-001-007C	HLWP	Plug Number (T2): 3b; T26: X11-246-003-014
<b>2.1 (70 kW   2.1 Litre)</b>					
08.85 - 07.92	MV		246-086-001-007C	HLWP	Plug Number (T2): 3b; T26: X11-246-003-014
<b>2.1 (82 kW   2.1 Litre)</b>					
03.86 - 09.91	DJ		246-082-008-014C	SWP-M-C	Plug Number (T2): 1
03.86 - 07.92	DJ		246-086-001-007C	HLWP	Plug Number (T2): 3b; T26: X11-246-003-014
<b>2.1 i (68 kW   2.1 Litre)</b>					
07.89 - 07.91	SS		246-082-008-014C	SWP-M-C	Plug Number (T2): 1
07.89 - 07.92	SS		246-086-001-007C	HLWP	Plug Number (T2): 3b; T26: X11-246-003-014



Date	Engine Code	Chassis No.	Article No.	Product	Information

**VW****TRANSPORTER III Platform/Chassis****2.1 Syncro (70 kW | 2.1 Litre)**

08.85 - 07.92	MV		246-086-001-007C	HLWP	Plug Number (T2): 3b; T26: X11-246-003-014
---------------	----	--	------------------	------	--------------------------------------------

**2.1 Syncro (82 kW | 2.1 Litre)**

03.86 - 07.92	DJ		246-086-001-007C	HLWP	Plug Number (T2): 3b; T26: X11-246-003-014
---------------	----	--	------------------	------	--------------------------------------------

**TRANSPORTER IV Bus (70XB, 70XC, 7DB, 7DW)****1.8 (49 kW | 1.8 Litre)**

12.90 - 07.92	PD		246-069-056-001Z	N	
12.90 - 07.92	PD		246-080-010-002Z	N-H	
12.90 - 07.92	PD		246-082-008-014C	SWP-M-C	Plug Number (T2): 1
12.90 - 07.92	PD		246-083-002-014G	SWP-D-C	Plug Number (T2): 6
12.90 - 07.92	PD		246-086-001-002C	HLWP	Plug Number (T2): 3
12.90 - 07.92	PD		246-086-001-007C	HLWP	Plug Number (T2): 3b; T26: X11-246-003-014

**1.9 D (44 kW | 1.9 Litre)**

09.90 - 04.03	1X		246-069-056-001Z	N	
09.90 - 04.03	1X		246-080-010-002Z	N-H	
09.90 - 12.94	1X		246-082-008-014C	SWP-M-C	Plug Number (T2): 1
09.90 - 12.94	1X		246-083-002-014G	SWP-D-C	Plug Number (T2): 6
09.90 - 12.94	1X		246-086-001-002C	HLWP	Plug Number (T2): 3
09.90 - 04.03	1X		246-086-001-007C	HLWP	Plug Number (T2): 3b; T26: X11-246-003-014

**1.9 TD (50 kW | 1.9 Litre)**

10.92 - 04.03	ABL		246-069-056-001Z	N	
10.92 - 04.03	ABL		246-080-010-002Z	N-H	
01.96 - 06.97	ABL		246-082-008-014C	SWP-M-C	Plug Number (T2): 1
01.96 - 06.97	ABL		246-083-002-014G	SWP-D-C	Plug Number (T2): 6
10.92 - 04.03	ABL		246-083-002-022G	SWP-D-C	
01.96 - 05.97	ABL	-W - 000 001	246-086-001-002C	HLWP	Plug Number (T2): 3
05.97 - 06.97	ABL	W - 000 001-	246-086-001-007C	HLWP	Plug Number (T2): 3b; T26: X11-246-003-014

**2.0 (62 kW | 2.0 Litre)**

09.90 - 04.03	AAC		246-069-056-001Z	N	
09.90 - 04.03	AAC		246-080-010-002Z	N-H	
09.90 - 12.95	AAC		246-082-008-014C	SWP-M-C	Plug Number (T2): 1
09.90 - 12.95	AAC		246-083-002-014G	SWP-D-C	Plug Number (T2): 6
09.90 - 12.95	AAC		246-086-001-002C	HLWP	Plug Number (T2): 3
09.90 - 04.03	AAC		246-086-001-007C	HLWP	Plug Number (T2): 3b; T26: X11-246-003-014

**2.4 D (55 kW | 2.4 Litre)**

08.97 - 04.03	AJA		246-069-056-001Z	N	
08.97 - 04.03	AJA		246-080-010-002Z	N-H	
08.97 - 04.03	AJA		246-083-002-006G	SWP-D-C	Plug Number (T2): 1
08.97 - 04.03	AJA		246-083-002-022G	SWP-D-C	

**2.4 D (57 kW | 2.4 Litre)**

09.90 - 04.98	AAB		246-069-056-001Z	N	
09.90 - 04.98	AAB		246-080-010-002Z	N-H	
09.90 - 12.95	AAB		246-082-008-014C	SWP-M-C	Plug Number (T2): 1
09.90 - 12.95	AAB		246-083-002-014G	SWP-D-C	Plug Number (T2): 6
09.90 - 12.95	AAB		246-086-001-002C	HLWP	Plug Number (T2): 3
09.90 - 04.98	AAB		246-086-001-007C	HLWP	Plug Number (T2): 3b; T26: X11-246-003-014

**2.4 D Syncro (57 kW | 2.4 Litre)**

10.92 - 09.98	AAB		246-069-056-001Z	N	
10.92 - 09.98	AAB		246-080-010-002Z	N-H	
11.92 - 06.95	AAB		246-082-008-014C	SWP-M-C	Plug Number (T2): 1
11.92 - 09.98	AAB		246-083-002-006G	SWP-D-C	Plug Number (T2): 1
10.92 - 09.98	AAB		246-083-002-022G	SWP-D-C	
10.92 - 09.98	AAB		246-086-001-007C	HLWP	Plug Number (T2): 3b; T26: X11-246-003-014

**2.5 (81 kW | 2.5 Litre)**

11.90 - 04.03	AAF, ACU, AEN, AEU		246-069-056-001Z	N	
11.90 - 04.03	AAF, ACU, AEN, AEU		246-080-010-002Z	N-H	
11.90 - 12.93	AAF, ACU, AEN, AEU		246-082-008-014C	SWP-M-C	Plug Number (T2): 1
11.90 - 12.93	AAF, ACU, AEN, AEU		246-083-002-014G	SWP-D-C	Plug Number (T2): 6
11.90 - 12.93	AAF, ACU, AEN, AEU		246-086-001-002C	HLWP	Plug Number (T2): 3
11.90 - 04.03	AAF, ACU, AEN, AEU		246-086-001-007C	HLWP	Plug Number (T2): 3b; T26: X11-246-003-014

**2.5 (85 kW | 2.5 Litre)**

08.96 - 04.03	AET, AVT, APL		246-069-056-001Z	N	
---------------	---------------	--	------------------	---	--



			<b>VDO</b>		
Date	Engine Code	Chassis No.	Article No.	Product	Information

**VW****TRANSPORTER IV Bus (70XB, 70XC, 7DB, 7DW)****2.5 (85 kW | 2.5 Litre)**

08.96 → 04.03	AET, AVT, APL		246-080-010-002Z	N-H	
08.96 → 04.03	AET, AVT, APL		246-083-002-022G	SWP-D-C	
08.96 → 04.03	AET, AVT, APL		246-086-001-007C	HLWP	Plug Number (T2): 3b; T26: X11-246-003-014

**2.5 Syncro (81 kW | 2.5 Litre)**

11.92 → 04.03	AAF, ACU, AEN, AEU		246-069-056-001Z	N	
11.92 → 04.03	AAF, ACU, AEN, AEU		246-080-010-002Z	N-H	
11.92 → 06.95	AAF, ACU, AEN, AEU		246-082-008-014C	SWP-M-C	Plug Number (T2): 1
11.92 → 04.03	AAF, ACU, AEN, AEU		246-083-002-006G	SWP-D-C	Plug Number (T2): 1
11.92 → 04.03	AAF, ACU, AEN, AEU		246-083-002-022G	SWP-D-C	
11.92 → 04.03	AAF, ACU, AEN, AEU		246-086-001-007C	HLWP	Plug Number (T2): 3b; T26: X11-246-003-014

**2.5 Syncro (85 kW | 2.5 Litre)**

07.96 → 04.03	AET, AVT, APL		246-069-056-001Z	N	
07.96 → 04.03	AET, AVT, APL		246-080-010-002Z	N-H	
07.96 → 05.97	AET, AVT, APL		246-082-008-014C	SWP-M-C	Plug Number (T2): 1
07.96 → 05.97	AET, AVT, APL		246-083-002-014G	SWP-D-C	Plug Number (T2): 6
07.96 → 04.03	AET, AVT, APL		246-083-002-022G	SWP-D-C	
07.96 → 05.97	AET, AVT, APL		246-086-001-002C	HLWP	Plug Number (T2): 3
07.96 → 04.03	AET, AVT, APL		246-086-001-007C	HLWP	Plug Number (T2): 3b; T26: X11-246-003-014

**2.5 TDI (111 kW | 2.5 Litre)**

05.98 → 04.03	AHY, AXG		246-069-056-001Z	N	
05.98 → 04.03	AHY, AXG		246-080-010-002Z	N-H	
05.98 → 04.03	AHY, AXG		246-082-008-021G	SWP-M-C	Plug Number (T2): 6
05.98 → 04.03	AHY		246-083-002-022G	SWP-D-C	
05.98 → 04.03	AHY, AXG		246-086-001-007C	HLWP	Plug Number (T2): 3b; T26: X11-246-003-014

**2.5 TDI (65 kW | 2.5 Litre)**

05.98 → 04.03	AJT, AYY		246-069-056-001Z	N	
05.98 → 04.03	AJT, AYY		246-080-010-002Z	N-H	
05.98 → 04.03	AJT, AYY		246-082-008-021G	SWP-M-C	Plug Number (T2): 6
05.98 → 04.03	AJT		246-083-002-022G	SWP-D-C	
05.98 → 04.03	AJT, AYY		246-086-001-007C	HLWP	Plug Number (T2): 3b; T26: X11-246-003-014

**2.5 TDI (75 kW | 2.5 Litre)**

09.95 → 04.03	ACV, AUF, AYC		246-069-056-001Z	N	
09.95 → 04.03	ACV, AUF, AYC		246-080-010-002Z	N-H	
01.96 → 04.03	ACV, AUF, AYC		246-082-008-014C	SWP-M-C	Plug Number (T2): 1
01.96 → 04.03	ACV, AUF, AYC		246-083-002-014G	SWP-D-C	Plug Number (T2): 6
09.95 → 04.03	ACV		246-083-002-022G	SWP-D-C	
01.96 → 05.97	ACV, AUF, AYC	→W - 000 001	246-086-001-002C	HLWP	Plug Number (T2): 3
05.97 → 04.03	ACV, AUF, AYC	W - 000 001→	246-086-001-007C	HLWP	Plug Number (T2): 3b; T26: X11-246-003-014

**2.5 TDI Syncro (75 kW | 2.5 Litre)**

01.96 → 04.03	ACV, AXL		246-069-056-001Z	N	
01.96 → 04.03	ACV, AXL		246-080-010-002Z	N-H	
01.96 → 04.98	ACV, AXL		246-082-008-014C	SWP-M-C	Plug Number (T2): 1
01.96 → 04.98	ACV, AXL		246-083-002-014G	SWP-D-C	Plug Number (T2): 6
01.96 → 04.03	ACV, AXL		246-083-002-022G	SWP-D-C	
01.96 → 04.98	ACV, AXL	→W - 000 001	246-086-001-002C	HLWP	Plug Number (T2): 3
05.97 → 04.03	ACV, AXL	W - 000 001→	246-086-001-007C	HLWP	Plug Number (T2): 3b; T26: X11-246-003-014

**2.8 V6 (150 kW | 2.8 Litre)**

04.00 → 04.03	AMV		246-069-056-001Z	N	
04.00 → 04.03	AMV		246-080-010-002Z	N-H	
04.00 → 04.03	AMV		246-082-008-021G	SWP-M-C	Plug Number (T2): 6
04.00 → 04.03	AMV		246-082-008-025G	SWP-M-C	
04.00 → 04.03	AMV		246-083-002-022G	SWP-D-C	
04.00 → 04.03	AMV		246-086-001-007C	HLWP	Plug Number (T2): 3b; T26: X11-246-003-014

**2.8 VR 6 (103 kW | 2.8 Litre)**

11.95 → 04.00	AES		246-069-056-001Z	N	
11.95 → 04.00	AES		246-080-010-002Z	N-H	
01.96 → 04.96	AES		246-082-008-014C	SWP-M-C	Plug Number (T2): 1
01.96 → 04.96	AES		246-083-002-014G	SWP-D-C	Plug Number (T2): 6
11.95 → 04.00	AES		246-083-002-022G	SWP-D-C	
01.96 → 05.97	AES	→W - 000 001	246-086-001-002C	HLWP	Plug Number (T2): 3
05.97 → 04.00	AES	W - 000 001→	246-086-001-007C	HLWP	Plug Number (T2): 3b; T26: X11-246-003-014



			<b>VDO</b>		
Date	Engine Code	Chassis No.	Article No.	Product	Information

**VW****TRANSPORTER IV Box (70XA)**

<b>1.6 (62 kW   1.6 Litre)</b>					
08.92 → 07.99			246-083-002-022G	SWP-D-C	T26: X11-246-003-014
<b>1.9 D (45 kW   1.9 Litre)</b>					
09.90 → 04.03	1X		246-080-010-002Z	N-H	
<b>1.9 TD (50 kW   1.9 Litre)</b>					
10.92 → 04.03	ABL		246-080-010-002Z	N-H	
10.92 → 12.95	ABL		246-082-008-014C	SWP-M-C	Plug Number (T2): 1
10.92 → 12.95	ABL		246-083-002-014G	SWP-D-C	Plug Number (T2): 6
10.92 → 04.03	ABL		246-083-002-022G	SWP-D-C	
10.92 → 12.95	ABL		246-086-001-002C	HLWP	Plug Number (T2): 3
<b>2.0 (62 kW   2.0 Litre)</b>					
09.90 → 04.03	AAC		246-080-010-002Z	N-H	
09.90 → 12.95	AAC		246-082-008-014C	SWP-M-C	Plug Number (T2): 1
09.90 → 12.95	AAC		246-083-002-014G	SWP-D-C	Plug Number (T2): 6
09.90 → 12.95	AAC		246-086-001-002C	HLWP	Plug Number (T2): 3
<b>2.4 D (55 kW   2.4 Litre)</b>					
08.97 → 04.03	AJA		246-080-010-002Z	N-H	
08.97 → 04.03	AJA		246-083-002-022G	SWP-D-C	
<b>2.4 D (57 kW   2.4 Litre)</b>					
09.90 → 04.98	AAB		246-080-010-002Z	N-H	
<b>2.4 D Syncro (57 kW   2.4 Litre)</b>					
10.92 → 09.98	AAB		246-080-010-002Z	N-H	
10.92 → 09.98	AAB		246-083-002-022G	SWP-D-C	
<b>2.5 (81 kW   2.5 Litre)</b>					
11.90 → 04.03	AAF, ACU, AEN, AEU		246-080-010-002Z	N-H	
<b>2.5 (85 kW   2.5 Litre)</b>					
08.96 → 04.03	AET, AVT, APL		246-080-010-002Z	N-H	
08.96 → 04.03	AET, AVT, APL		246-083-002-022G	SWP-D-C	
<b>2.5 Syncro (81 kW   2.5 Litre)</b>					
10.92 → 04.03	AAF, ACU, AEN, AEU		246-080-010-002Z	N-H	
10.92 → 04.03	AAF, ACU, AEN, AEU		246-083-002-022G	SWP-D-C	
<b>2.5 Syncro (85 kW   2.5 Litre)</b>					
08.96 → 04.03	AET, AVT, APL		246-080-010-002Z	N-H	
08.96 → 05.97	AET, AVT, APL		246-082-008-014C	SWP-M-C	Plug Number (T2): 1
08.96 → 05.97	AET, AVT, APL		246-083-002-014G	SWP-D-C	Plug Number (T2): 6
08.96 → 04.03	AET, AVT, APL		246-083-002-022G	SWP-D-C	
08.96 → 05.97	AET, AVT, APL		246-086-001-002C	HLWP	Plug Number (T2): 3
<b>2.5 TDI (111 kW   2.5 Litre)</b>					
09.00 → 04.03	AXG		246-082-008-014C	SWP-M-C	Plug Number (T2): 1
09.00 → 04.03	AXG		246-082-008-021G	SWP-M-C	Plug Number (T2): 6
09.00 → 04.03	AXG		246-082-008-025G	SWP-M-C	
09.00 → 04.03	AXG		246-083-002-022G	SWP-D-C	
09.00 → 04.03	AXG		246-086-001-007C	HLWP	Plug Number (T2): 3b
<b>2.5 TDI (65 kW   2.5 Litre)</b>					
12.98 → 04.03	AJT, AYY		246-080-010-002Z	N-H	
12.98 → 04.03	AJT, AYY		246-082-008-021G	SWP-M-C	Plug Number (T2): 6
12.98 → 04.03	AJT		246-083-002-022G	SWP-D-C	
<b>2.5 TDI (75 kW   2.5 Litre)</b>					
09.95 → 04.03	ACV, AUF, AYC		246-080-010-002Z	N-H	
01.96 → 04.03	ACV, AUF, AYC		246-082-008-014C	SWP-M-C	Plug Number (T2): 1
01.96 → 04.03	ACV, AUF, AYC		246-083-002-014G	SWP-D-C	Plug Number (T2): 6
09.95 → 04.03	AUF		246-083-002-022G	SWP-D-C	
01.96 → 05.97	ACV, AUF, AYC	→W - 000 001	246-086-001-002C	HLWP	Plug Number (T2): 3
05.97 → 04.03	ACV, AUF, AYC	W - 000 001→	246-086-001-007C	HLWP	Plug Number (T2): 3b; T26: X11-246-003-014
<b>2.5 TDI Syncro (75 kW   2.5 Litre)</b>					
09.95 → 04.03	ACV, AXL		246-080-010-002Z	N-H	
05.98 → 04.03	ACV, AXL		246-082-008-014C	SWP-M-C	Plug Number (T2): 1
05.98 → 04.03	ACV, AXL		246-083-002-014G	SWP-D-C	Plug Number (T2): 6
09.95 → 04.03	ACV, AXL		246-083-002-022G	SWP-D-C	
05.98 → 04.03	ACV, AXL		246-086-001-002C	HLWP	Plug Number (T2): 3
<b>2.8 VR6 (150 kW   2.8 Litre)</b>					
06.00 → 04.03	AMV		246-082-008-021G	SWP-M-C	Plug Number (T2): 6





			<b>VDO</b>		
Date	Engine Code	Chassis No.	Article No.	Product	Information

**VW****TRANSPORTER IV Platform/Chassis (70XD)****1.9 D (45 kW | 1.9 Litre)**

07.90 - 04.03	1X		246-069-056-001Z	N	
09.90 - 04.03	1X		246-080-010-002Z	N-H	

**1.9 TD (50 kW | 1.9 Litre)**

10.92 - 04.03	ABL		246-069-056-001Z	N	
10.92 - 04.03	ABL		246-080-010-002Z	N-H	
10.92 - 12.95	ABL		246-082-008-014C	SWP-M-C	Plug Number (T2): 1
10.92 - 12.95	ABL		246-083-002-014G	SWP-D-C	Plug Number (T2): 6
10.92 - 12.95	ABL		246-086-001-002C	HLWP	Plug Number (T2): 3

**2.0 (62 kW | 2.0 Litre)**

07.90 - 04.03	AAC		246-069-056-001Z	N	
09.90 - 04.03	AAC		246-080-010-002Z	N-H	
09.90 - 12.95	AAC		246-082-008-014C	SWP-M-C	Plug Number (T2): 1
09.90 - 12.95	AAC		246-086-001-002C	HLWP	Plug Number (T2): 3

**2.4 D (55 kW | 2.4 Litre)**

08.97 - 04.03	AJA		246-069-056-001Z	N	
08.97 - 04.03	AJA		246-080-010-002Z	N-H	

**2.4 D (57 kW | 2.4 Litre)**

09.90 - 04.98	AAB		246-069-056-001Z	N	
09.90 - 04.98	AAB		246-080-010-002Z	N-H	

**2.4 D Syncro (57 kW | 2.4 Litre)**

10.92 - 09.98	AAB		246-069-056-001Z	N	
10.92 - 09.98	AAB		246-080-010-002Z	N-H	

**2.5 (81 kW | 2.5 Litre)**

11.90 - 04.03	AAF, ACU, AEN, AEU		246-069-056-001Z	N	
11.90 - 04.03	AAF, ACU, AEN, AEU		246-080-010-002Z	N-H	

**2.5 (85 kW | 2.5 Litre)**

08.96 - 04.03	AET, AVT, APL		246-069-056-001Z	N	
08.96 - 04.03	AET, AVT, APL		246-080-010-002Z	N-H	

**2.5 Syncro (81 kW | 2.5 Litre)**

10.92 - 04.03	AAF, ACU, AEN, AEU		246-069-056-001Z	N	
10.92 - 04.03	AAF, ACU, AEN, AEU		246-080-010-002Z	N-H	
07.95 - 04.03	AAF, ACU, AEN, AEU		246-082-008-014C	SWP-M-C	Plug Number (T2): 1

**2.5 Syncro (85 kW | 2.5 Litre)**

08.96 - 04.03	AET, AVT, APL		246-069-056-001Z	N	
08.96 - 04.03	AET, AVT, APL		246-080-010-002Z	N-H	
05.99 - 04.03	AET, AVT, APL		246-082-008-014C	SWP-M-C	Plug Number (T2): 1
05.99 - 04.03	AET, AVT, APL		246-086-001-002C	HLWP	Plug Number (T2): 3

**2.5 TDI (65 kW | 2.5 Litre)**

05.98 - 04.03	AJT, AYY		246-069-056-001Z	N	
05.98 - 04.03	AJT, AYY		246-080-010-002Z	N-H	
05.98 - 04.03	AJT, AYY		246-082-008-021G	SWP-M-C	Plug Number (T2): 6

**2.5 TDI (75 kW | 2.5 Litre)**

09.95 - 04.03	ACV, AUF, AYC		246-069-056-001Z	N	
09.95 - 04.03	ACV, AUF, AYC		246-080-010-002Z	N-H	
01.96 - 03.98	ACV, AUF, AYC		246-082-008-014C	SWP-M-C	Plug Number (T2): 1
01.96 - 04.96	ACV, AUF, AYC		246-083-002-014G	SWP-D-C	Plug Number (T2): 6
01.96 - 05.97	ACV, AUF, AYC	-W - 000 001	246-086-001-002C	HLWP	Plug Number (T2): 3
05.97 - 04.03	ACV, AUF, AYC	W - 000 001-	246-086-001-007C	HLWP	Plug Number (T2): 3b; T26: X11-246-003-014

**2.5 TDI Syncro (75 kW | 2.5 Litre)**

05.98 - 04.03	ACV, AXL		246-082-008-014C	SWP-M-C	Plug Number (T2): 1
05.98 - 04.03	ACV, AXL		246-082-008-021G	SWP-M-C	Plug Number (T2): 6
05.98 - 04.03	ACV, AXL		246-086-001-007C	HLWP	Plug Number (T2): 3b

**TRANSPORTER V Bus (7HB, 7HJ, 7EB, 7EJ, 7EF)****1.9 TDI (62 kW | 1.9 Litre)**

01.06 - 11.09	BRR	7H-6-000 001- -7H-6-200 000	246-082-008-025G	SWP-M-C	
01.06 - 11.09	BRR	7J-6 000 001-	246-083-002-022G	SWP-D-C	
01.06 - 11.09	BRR		246-086-001-007C	HLWP	Plug Number (T2): 3b

**1.9 TDI (63 kW | 1.9 Litre)**

04.03 - 11.09	AXC	7H-3-000 001- -7H-3-001 000	246-082-008-025G	SWP-M-C	
---------------	-----	--------------------------------	------------------	---------	--



			<b>VDO</b>		
Date	Engine Code	Chassis No.	Article No.	Product	Information

**VW****TRANSPORTER V Bus (7HB, 7HJ, 7EB, 7EJ, 7EF)**

<b>1.9 TDI (63 kW   1.9 Litre)</b>					
04.03 - 11.09	AXC		246-083-002-022G	SWP-D-C	
04.03 - 11.09	AXC	7J-3-000 001→ -7J-3-001 000	246-086-001-007C	HLWP	Plug Number (T2): 3b
<b>1.9 TDI (75 kW   1.9 Litre)</b>					
06.06 - 11.09	BRS	7H-6-000 001→ -7H-6-200 000	246-082-008-025G	SWP-M-C	
06.06 - 11.09	BRS		246-083-002-022G	SWP-D-C	
06.06 - 11.09	BRS		246-086-001-007C	HLWP	Plug Number (T2): 3b
<b>1.9 TDI (77 kW   1.9 Litre)</b>					
04.03 - 11.09	AXB	7H-3-000 001→ -7H-3-001 000	246-082-008-025G	SWP-M-C	
04.03 - 11.09	AXB		246-083-002-022G	SWP-D-C	
04.03 - 11.09	AXB	7J-3-000 001→ -7J-3-001 000	246-086-001-007C	HLWP	Plug Number (T2): 3b
<b>2.0 (85 kW   2.0 Litre)</b>					
11.03 -	AXA	7H-3-000 001→ -7H-3-001 000	246-082-008-025G	SWP-M-C	
11.03 -	AXA		246-083-002-022G	SWP-D-C	
11.03 -	AXA	7J-3-000 001→ -7J-3-001 000	246-086-001-007C	HLWP	Plug Number (T2): 3b
<b>2.0 BiTDI (132 kW   2.0 Litre)</b>					
09.09 -	CFCA	7H-9-000 001→ -7H-9-200 000	246-082-008-025G	SWP-M-C	
09.09 -	CFCA	7H-9000 001→ -7H-9-200 000	246-083-002-022G	SWP-D-C	
09.09 -	CFCA	7H-9-000 001→ -7H-9-200 000	246-086-001-007C	HLWP	Plug Number (T2): 3b
<b>2.0 BiTDI 4motion (132 kW   2.0 Litre)</b>					
09.09 -	CFCA	7H-9-000 001→ -7H-9-200 000	246-082-008-025G	SWP-M-C	
09.09 -	CFCA	7H-9000 001→ -7H-9-200 000	246-083-002-022G	SWP-D-C	
09.09 -	CFCA	7H-9-000 001→ -7H-9-200 000	246-086-001-007C	HLWP	Plug Number (T2): 3b
<b>2.0 TDI (100 kW   2.0 Litre)</b>					
05.10 -	CAAE, CCHB	7H-A-000 001→ -7H-A-050 000	246-082-008-025G	SWP-M-C	
<b>2.0 TDI (103 kW   2.0 Litre)</b>					
09.09 -	CAAC, CCHA	7H-9-000 001→ -7H-9-200 000	246-082-008-025G	SWP-M-C	
09.09 -	CAAC, CCHA	7H-9000 001→ -7H-9-200 000	246-083-002-022G	SWP-D-C	
09.09 -	CAAC, CCHA	7H-9-000 001→ -7H-9-200 000	246-086-001-007C	HLWP	Plug Number (T2): 3b
<b>2.0 TDI (62 kW   2.0 Litre)</b>					
09.09 -	CAAA	7H-9-000 001→ -7H-9-200 000	246-082-008-025G	SWP-M-C	
09.09 -	CAAA	7H-9000 001→ -7H-9-200 000	246-083-002-022G	SWP-D-C	
09.09 -	CAAA	7H-9-000 001→ -7H-9-200 000	246-086-001-007C	HLWP	Plug Number (T2): 3b
<b>2.0 TDI (75 kW   2.0 Litre)</b>					
09.09 -	CAAB	7H-9-000 001→ -7H-9-200 000	246-082-008-025G	SWP-M-C	
09.09 -	CAAB	7H-9000 001→ -7H-9-200 000	246-083-002-022G	SWP-D-C	
09.09 -	CAAB	7H-9-000 001→ -7H-9-200 000	246-086-001-007C	HLWP	Plug Number (T2): 3b
<b>2.0 TDI 4motion (100 kW   2.0 Litre)</b>					
05.10 -	CAAE, CCHB	7H-A-000 001→ -7H-A-050 000	246-082-008-025G	SWP-M-C	



			<b>VDO</b>		
Date	Engine Code	Chassis No.	Article No.	Product	Information

**VW****TRANSPORTER V Bus (7HB, 7HJ, 7EB, 7EJ, 7EF)****2.0 TDI 4motion (103 kW | 2.0 Litre)**

09.09 -	CAAC, CCHA	7H-9-000 001→ →7H-9-200 000	246-082-008-025G	SWP-M-C	
09.09 -	CAAC, CCHA	7H-9000 001→ →7H-9-200 000	246-083-002-022G	SWP-D-C	
09.09 -	CAAC, CCHA	7H-9-000 001→ →7H-9-200 000	246-086-001-007C	HLWP	Plug Number (T2): 3b

**2.5 TDi (120 kW | 2.5 Litre)**

11.03 - 11.09	BLJ	7H-3-000 001→ →7H-3-001 000	246-082-008-025G	SWP-M-C	
11.03 - 11.09	BLJ		246-086-001-007C	HLWP	Plug Number (T2): 3b

**2.5 TDI (128 kW | 2.5 Litre)**

04.03 - 11.09	AXE, BPC	7H-3-000 001→ →7H-3-001 000	246-082-008-025G	SWP-M-C	
04.03 - 11.09	AXE, BPC		246-083-002-022G	SWP-D-C	
04.03 - 11.09	AXE, BPC	7J-3-000 001→ →7J-3-001 000	246-086-001-007C	HLWP	Plug Number (T2): 3b

**2.5 TDI (96 kW | 2.5 Litre)**

04.03 - 11.09	AXD, BNZ	7H-3-000 001→ →7H-3-001 000	246-082-008-025G	SWP-M-C	
04.03 - 11.09	AXD, BNZ		246-083-002-022G	SWP-D-C	
04.03 - 11.09	AXD, BNZ	7J-3-000 001→ →7J-3-001 000	246-086-001-007C	HLWP	Plug Number (T2): 3b

**2.5 TDI 4motion (128 kW | 2.5 Litre)**

07.04 - 11.09	AXE, BPC	7H-4-000 001→ →7H-4-150 000	246-082-008-025G	SWP-M-C	
07.04 - 11.09	AXE, BPC		246-083-002-022G	SWP-D-C	
07.04 - 11.09	AXE, BPC	7J-3-000 001→ →7J-3-001 000	246-086-001-007C	HLWP	Plug Number (T2): 3b

**2.5 TDI 4motion (96 kW | 2.5 Litre)**

07.04 - 11.09	AXD, BNZ	7H-4-000 001→ →7H-4-150 000	246-082-008-025G	SWP-M-C	
07.04 - 11.09	AXD, BNZ		246-083-002-022G	SWP-D-C	
07.04 - 11.09	AXD, BNZ	7J-3-000 001→ →7J-3-001 000	246-086-001-007C	HLWP	Plug Number (T2): 3b

**3.2 V6 (170 kW | 3.2 Litre)**

02.04 - 06.04	BDL	7H-4-000 001→ →7H-4-150 000	246-082-008-025G	SWP-M-C	
02.04 - 06.04	BDL		246-083-002-022G	SWP-D-C	
02.04 - 06.04	BDL	7J-3-000 001→ →7J-3-001 000	246-086-001-007C	HLWP	Plug Number (T2): 3b

**3.2 V6 (173 kW | 3.2 Litre)**

02.04 - 11.09	BKK, CFLA	7H-4-000 001→ →7H-4-150 000	246-082-008-025G	SWP-M-C	
02.04 - 11.09	BKK, CFLA		246-083-002-022G	SWP-D-C	
02.04 - 11.09	BKK, CFLA	7J-3-000 001→ →7J-3-001 000	246-086-001-007C	HLWP	Plug Number (T2): 3b

**3.2 V6 4motion (173 kW | 3.2 Litre)**

11.03 - 11.09	BKK, CFLA	7H-3-000 001→ →7H-3-001 000	246-082-008-025G	SWP-M-C	
11.03 - 11.09	BKK, CFLA		246-083-002-022G	SWP-D-C	T26: X11 246 003 014
11.03 - 11.09	BKK, CFLA		246-086-001-007C	HLWP	Plug Number (T2): 3b

**TRANSPORTER V Box (7HA, 7HH, 7EA, 7EH)****1.9 TDI (62 kW | 1.9 Litre)**

01.06 - 11.09	BRR	7H-6-000 001→ →7H-6-200 000	246-082-008-025G	SWP-M-C	
01.06 - 11.09	BRR		246-083-002-022G	SWP-D-C	
01.06 - 11.09	BRR		246-086-001-007C	HLWP	Plug Number (T2): 3b

**1.9 TDI (63 kW | 1.9 Litre)**

04.03 - 11.09	AXC	7H-3-000 001→ →7H-3-001 000	246-082-008-025G	SWP-M-C	
04.03 - 11.09	AXC		246-083-002-022G	SWP-D-C	



			<b>VDO</b>		
Date	Engine Code	Chassis No.	Article No.	Product	Information

**VW****TRANSPORTER V Box (7HA, 7HH, 7EA, 7EH)**

<b>1.9 TDI (63 kW   1.9 Litre)</b>					
04.03 - 11.09	AXC	7J-3-000 001→ →7J-3-001 000	246-086-001-007C	HLWP	Plug Number (T2): 3b
<b>1.9 TDI (75 kW   1.9 Litre)</b>					
06.06 - 11.09	BRS	7H-6-000 001→ →7H-6-200 000	246-082-008-025G	SWP-M-C	
06.06 - 11.09	BRS	→7J-6-050 000	246-083-002-022G	SWP-D-C	
06.06 - 11.09	BRS		246-086-001-007C	HLWP	Plug Number (T2): 3b
<b>1.9 TDI (77 kW   1.9 Litre)</b>					
04.03 - 11.09	AXB	7H-3-000 001→ →7H-3-001 000	246-082-008-025G	SWP-M-C	
04.03 - 11.09	AXB		246-083-002-022G	SWP-D-C	
04.03 - 11.09	AXB	7J-3-000 001→ →7J-3-001 000	246-086-001-007C	HLWP	Plug Number (T2): 3b
<b>2.0 (85 kW   2.0 Litre)</b>					
11.03 -	AXA	7H-3-000 001→ →7H-3-001 000	246-082-008-025G	SWP-M-C	
11.03 -	AXA		246-083-002-022G	SWP-D-C	
11.03 -	AXA	7J-3-000 001→ →7J-3-001 000	246-086-001-007C	HLWP	Plug Number (T2): 3b
<b>2.0 BiTDI (132 kW   2.0 Litre)</b>					
09.09 -	CFCA	7H-9-000 001→ →7H-9-200 000	246-082-008-025G	SWP-M-C	
09.09 -	CFCA	7H-9000 001→ →7H-9-200 000	246-083-002-022G	SWP-D-C	
09.09 -	CFCA	7H-9-000 001→ →7H-9-200 000	246-086-001-007C	HLWP	Plug Number (T2): 3b
<b>2.0 BiTDI 4motion (132 kW   2.0 Litre)</b>					
09.09 -	CFCA	7H-9-000 001→ →7H-9-200 000	246-082-008-025G	SWP-M-C	
09.09 -	CFCA	7H-9000 001→ →7H-9-200 000	246-083-002-022G	SWP-D-C	
09.09 -	CFCA	7H-9-000 001→ →7H-9-200 000	246-086-001-007C	HLWP	Plug Number (T2): 3b
<b>2.0 TDI (103 kW   2.0 Litre)</b>					
09.09 -	CAAC, CCHA	7H-9-000 001→ →7H-9-200 000	246-082-008-025G	SWP-M-C	
09.09 -	CAAC, CCHA	7H-9000 001→ →7H-9-200 000	246-083-002-022G	SWP-D-C	
09.09 -	CAAC, CCHA	7H-9-000 001→ →7H-9-200 000	246-086-001-007C	HLWP	Plug Number (T2): 3b
<b>2.0 TDI (62 kW   2.0 Litre)</b>					
09.09 -	CAAA	7H-9-000 001→ →7H-9-200 000	246-082-008-025G	SWP-M-C	
09.09 -	CAAA	7H-9000 001→ →7H-9-200 000	246-083-002-022G	SWP-D-C	
09.09 -	CAAA	7H-9-000 001→ →7H-9-200 000	246-086-001-007C	HLWP	Plug Number (T2): 3b
<b>2.0 TDI (75 kW   2.0 Litre)</b>					
09.09 -	CAAB	7H-9-000 001→ →7H-9-200 000	246-082-008-025G	SWP-M-C	
09.09 -	CAAB	7H-9000 001→ →7H-9-200 000	246-083-002-022G	SWP-D-C	
09.09 -	CAAB	7H-9-000 001→ →7H-9-200 000	246-086-001-007C	HLWP	Plug Number (T2): 3b
<b>2.0 TDI 4motion (103 kW   2.0 Litre)</b>					
09.09 -	CAAC, CCHA	7H-9-000 001→ →7H-9-200 000	246-082-008-025G	SWP-M-C	
09.09 -	CAAC, CCHA	7H-9000 001→ →7H-9-200 000	246-083-002-022G	SWP-D-C	
09.09 -	CAAC, CCHA	7H-9-000 001→ →7H-9-200 000	246-086-001-007C	HLWP	Plug Number (T2): 3b



			<b>VDO</b>		
Date	Engine Code	Chassis No.	Article No.	Product	Information

**VW****TRANSPORTER V Box (7HA, 7HH, 7EA, 7EH)****2.5 TDI (128 kW | 2.5 Litre)**

04.03 - 11.09	AXE, BPC	7H-3-000 001 → →7H-3-001 000	246-082-008-025G	SWP-M-C	
04.03 - 11.09	AXE, BPC		246-083-002-022G	SWP-D-C	
04.03 - 11.09	AXE, BPC	7J-3-000 001 → →7J-3-001 000	246-086-001-007C	HLWP	Plug Number (T2): 3b

**2.5 TDI (96 kW | 2.5 Litre)**

04.03 - 11.09	AXD, BNZ	7H-3-000 001 → →7H-3-001 000	246-082-008-025G	SWP-M-C	
04.03 - 11.09	AXD, BNZ		246-083-002-022G	SWP-D-C	
04.03 - 11.09	AXD, BNZ	7J-3-000 001 → →7J-3-001 000	246-086-001-007C	HLWP	Plug Number (T2): 3b

**2.5 TDI 4motion (128 kW | 2.5 Litre)**

07.04 - 11.09	AXE, BPC	7H-4-000 001 → →7H-4-150 000	246-082-008-025G	SWP-M-C	
07.04 - 11.09	AXE, BPC		246-083-002-022G	SWP-D-C	
07.04 - 11.09	AXE, BPC	7J-3-000 001 → →7J-3-001 000	246-086-001-007C	HLWP	Plug Number (T2): 3b

**2.5 TDI 4motion (96 kW | 2.5 Litre)**

07.04 - 11.09	AXD, BNZ	7H-4-000 001 → →7H-4-150 000	246-082-008-025G	SWP-M-C	
07.04 - 11.09	AXD, BNZ		246-083-002-022G	SWP-D-C	
07.04 - 11.09	AXD, BNZ	7J-3-000 001 → →7J-3-001 000	246-086-001-007C	HLWP	Plug Number (T2): 3b

**3.2 4motion (173 kW | 3.2 Litre)**

11.03 - 11.09	BKK, CFLA	7H-3-000 001 → →7H-3-001 000	246-082-008-025G	SWP-M-C	
11.03 - 11.09	BKK, CFLA		246-083-002-022G	SWP-D-C	T26: X11 246 003 014
11.03 - 11.09	BKK, CFLA		246-086-001-007C	HLWP	Plug Number (T2): 3b

**3.2 V6 (170 kW | 3.2 Litre)**

04.03 - 06.04	BDL	7H-3-000 001 → →7H-3-001 000	246-082-008-025G	SWP-M-C	
04.03 - 06.04	BDL		246-083-002-022G	SWP-D-C	
04.03 - 06.04	BDL	7J-3-000 001 → →7J-3-001 000	246-086-001-007C	HLWP	Plug Number (T2): 3b

**3.2 V6 (173 kW | 3.2 Litre)**

02.04 - 11.09	BKK, CFLA	7H-4-000 001 → →7H-4-150 000	246-082-008-025G	SWP-M-C	
02.04 - 11.09	BKK, CFLA		246-083-002-022G	SWP-D-C	
02.04 - 11.09	BKK, CFLA	7J-3-000 001 → →7J-3-001 000	246-086-001-007C	HLWP	Plug Number (T2): 3b

**TRANSPORTER V Platform/Chassis (7JD, 7JE, 7JL, 7JY, 7JZ, 7FD)****1.9 TDI (62 kW | 1.9 Litre)**

01.06 - 11.09	BRR	7H-6-000 001 → →7H-6-200 000	246-082-008-025G	SWP-M-C	
01.06 - 11.09	BRR		246-086-001-007C	HLWP	Plug Number (T2): 3b

**1.9 TDI (63 kW | 1.9 Litre)**

04.03 - 11.09	AXC	7H-3-000 001 → →7H-3-001 000	246-082-008-025G	SWP-M-C	
04.03 - 11.09	AXC	7J-3-000 001 → →7J-3-001 000	246-086-001-007C	HLWP	Plug Number (T2): 3b

**1.9 TDI (75 kW | 1.9 Litre)**

06.06 - 11.09	BRS	7H-6-000 001 → →7H-6-200 000	246-082-008-025G	SWP-M-C	
06.06 - 11.09	BRS		246-086-001-007C	HLWP	Plug Number (T2): 3b

**1.9 TDI (77 kW | 1.9 Litre)**

04.03 - 11.09	AXB	7H-3-000 001 → →7H-3-001 000	246-082-008-025G	SWP-M-C	
04.03 - 11.09	AXB	7J-3-000 001 → →7J-3-001 000	246-086-001-007C	HLWP	Plug Number (T2): 3b



			<b>VDO</b>		
Date	Engine Code	Chassis No.	Article No.	Product	Information

**VW****TRANSPORTER V Platform/Chassis (7JD, 7JE, 7JL, 7JY, 7JZ, 7FD)****2.0 (85 kW | 2.0 Litre)**

11.03 →	AXA	7H-3-000 001→ →7H-3-001 000	246-082-008-025G	SWP-M-C	
11.03 →	AXA	7J-3-000 001→ →7J-3-001 000	246-086-001-007C	HLWP	Plug Number (T2): 3b

**2.0 BiTDI (132 kW | 2.0 Litre)**

09.09 →	CFCA	7H-9-000 001→ →7H-9-200 000	246-082-008-025G	SWP-M-C	
09.09 →	CFCA	7H-9000 001→ →7H-9-200 000	246-083-002-022G	SWP-D-C	
09.09 →	CFCA	7H-9-000 001→ →7H-9-200 000	246-086-001-007C	HLWP	Plug Number (T2): 3b

**2.0 BiTDI 4motion (132 kW | 2.0 Litre)**

09.09 →	CFCA	7H-9-000 001→ →7H-9-200 000	246-082-008-025G	SWP-M-C	
09.09 →	CFCA	7H-9000 001→ →7H-9-200 000	246-083-002-022G	SWP-D-C	
09.09 →	CFCA	7H-9-000 001→ →7H-9-200 000	246-086-001-007C	HLWP	Plug Number (T2): 3b

**2.0 TDI (103 kW | 2.0 Litre)**

09.09 →	CAAC	7H-9-000 001→ →7H-9-200 000	246-082-008-025G	SWP-M-C	
09.09 →	CAAC	7H-9000 001→ →7H-9-200 000	246-083-002-022G	SWP-D-C	
09.09 →	CAAC	7H-9-000 001→ →7H-9-200 000	246-086-001-007C	HLWP	Plug Number (T2): 3b

**2.0 TDI (62 kW | 2.0 Litre)**

09.09 →	CAAA	7H-9-000 001→ →7H-9-200 000	246-082-008-025G	SWP-M-C	
09.09 →	CAAA	7H-9000 001→ →7H-9-200 000	246-083-002-022G	SWP-D-C	
09.09 →	CAAA	7H-9-000 001→ →7H-9-200 000	246-086-001-007C	HLWP	Plug Number (T2): 3b

**2.0 TDI (75 kW | 2.0 Litre)**

09.09 →	CAAB	7H-9-000 001→ →7H-9-200 000	246-082-008-025G	SWP-M-C	
09.09 →	CAAB	7H-9000 001→ →7H-9-200 000	246-083-002-022G	SWP-D-C	
09.09 →	CAAB	7H-9-000 001→ →7H-9-200 000	246-086-001-007C	HLWP	Plug Number (T2): 3b

**2.0 TDI 4motion (103 kW | 2.0 Litre)**

09.09 →	CAAC	7H-9-000 001→ →7H-9-200 000	246-082-008-025G	SWP-M-C	
09.09 →	CAAC	7H-9000 001→ →7H-9-200 000	246-083-002-022G	SWP-D-C	
09.09 →	CAAC	7H-9-000 001→ →7H-9-200 000	246-086-001-007C	HLWP	Plug Number (T2): 3b

**2.5 TDI (128 kW | 2.5 Litre)**

04.03 → 11.09	AXE, BPC	7H-3-000 001→ →7H-3-001 000	246-082-008-025G	SWP-M-C	
04.03 → 11.09	AXE, BPC	7J-3-000 001→ →7J-3-001 000	246-086-001-007C	HLWP	Plug Number (T2): 3b

**2.5 TDI (96 kW | 2.5 Litre)**

04.03 → 11.09	AXD, BNZ	7H-3-000 001→ →7H-3-001 000	246-082-008-025G	SWP-M-C	
04.03 → 11.09	AXD, BNZ	7J-3-000 001→ →7J-3-001 000	246-086-001-007C	HLWP	Plug Number (T2): 3b

**2.5 TDI 4motion (128 kW | 2.5 Litre)**

04.04 → 11.09	AXE, BPC	7H-4-000 001→ →7H-4-150 000	246-082-008-025G	SWP-M-C	
04.04 → 11.09	AXE, BPC		246-086-001-007C	HLWP	Plug Number (T2): 3b



			<b>VDO</b>		
<b>Date</b>	<b>Engine Code</b>	<b>Chassis No.</b>	<b>Article No.</b>	<b>Product</b>	<b>Information</b>

**VW****TRANSPORTER V Platform/Chassis (7JD, 7JE, 7JL, 7JY, 7JZ, 7FD)****2.5 TDI 4motion (96 kW | 2.5 Litre)**

07.04 → 11.09	AXD, BNZ	7H-4-000 001→ →7H-4-150 000	246-082-008-025G	SWP-M-C	
---------------	----------	--------------------------------	------------------	---------	--

07.04 → 11.09	AXD, BNZ		246-086-001-007C	HLWP	Plug Number (T2): 3b
---------------	----------	--	------------------	------	----------------------

**3.2 V6 (170 kW | 3.2 Litre)**

02.04 → 11.09	BDL	7H-4-000 001→ →7H-4-150 000	246-082-008-025G	SWP-M-C	
---------------	-----	--------------------------------	------------------	---------	--

02.04 → 11.09	BDL	7J-3-000 001→ →7J-3-001 000	246-086-001-007C	HLWP	Plug Number (T2): 3b
---------------	-----	--------------------------------	------------------	------	----------------------

**3.2 V6 (173 kW | 3.2 Litre)**

08.03 → 05.06	BKK	7H-3-000 001→ →7H-3-001 000	246-082-008-025G	SWP-M-C	
---------------	-----	--------------------------------	------------------	---------	--

08.03 → 05.06	BKK	7J-3-000 001→ →7J-3-001 000	246-086-001-007C	HLWP	Plug Number (T2): 3b
---------------	-----	--------------------------------	------------------	------	----------------------



# Cross-Reference Article No. > OE No. (all manufacturers)

Article No.	OE No.	Manufacturer	Article No. (new)	Product Name
246-061-009-002D	000 869 21 20	MERCEDES BENZ		R
246-061-009-002D	A000 869 21 20	MERCEDES BENZ		R
246-063-004-001G	000 869 10 22	MERCEDES BENZ		V
246-063-004-001G	1342553	VOLVO		V
246-063-004-001G	608 869 00 14	MERCEDES BENZ		V
246-063-004-001G	A000 869 10 22	MERCEDES BENZ		V
246-063-004-001G	A608 869 00 14	MERCEDES BENZ		V
246-063-013-001D	1 355 299	BMW		V
246-063-013-001D	300786	SCANIA		V
246-063-013-001D	61 66 1 355 299	BMW		V
246-063-013-001D	81.26484-0002	MAN		V
246-068-003-001G	000 860 60 47	MERCEDES BENZ		N
246-068-003-001G	A000 860 60 47	MERCEDES BENZ		N
246-068-013-004D	1307159	VOLVO		N
246-068-050-003D	1307159	VOLVO	246-068-013-004D	N
246-069-026-001G	000 869 24 47	MERCEDES BENZ		N
246-069-026-001G	A000 869 24 47	MERCEDES BENZ		N
246-069-029-004G	322 869 00 47	MERCEDES BENZ		N
246-069-029-004G	A322 869 00 47	MERCEDES BENZ		N
246-069-050-005D	300792	SCANIA		N
246-069-050-005D	4831689	VOLVO		N
246-069-056-001Z	191 955 985 A	SEAT		N
246-069-056-001Z	191 955 985 A	VW		N
246-069-056-001Z	246-069-056-001A	VDO		N
246-069-059-001Z	1 379 735	BMW		N
246-069-059-001Z	246-069-059-001A	VDO		N
246-069-059-001Z	61 66 1 379 735	BMW		N
246-075-010-001C	000 869 24 21	MERCEDES BENZ		SWP-M-G
246-075-010-001C	81.26485-6008	MAN		SWP-M-G
246-075-010-001C	A000 869 24 21	MERCEDES BENZ		SWP-M-G
246-075-015-001C	000 869 22 21	MERCEDES BENZ		SWP-M-G
246-075-015-001C	928 628 074 01	PORSCHE		SWP-M-G
246-075-015-001C	A000 869 22 21	MERCEDES BENZ		SWP-M-G
246-075-015-016C	1254197	VOLVO	246-075-021-006C	SWP-M-G
246-075-017-001	108 869 01 21	MERCEDES BENZ	246-075-017-002C	SWP-M-G
246-075-017-001	A108 869 01 21	MERCEDES BENZ	246-075-017-002C	SWP-M-G
246-075-017-002C	000 869 30 21	MERCEDES BENZ		SWP-M-G
246-075-017-002C	108 869 01 21	MERCEDES BENZ		SWP-M-G
246-075-017-002C	115 869 02 21	MERCEDES BENZ		SWP-M-G
246-075-017-002C	A000 869 30 21	MERCEDES BENZ		SWP-M-G
246-075-017-002C	A108 869 01 21	MERCEDES BENZ		SWP-M-G
246-075-017-002C	A115 869 02 21	MERCEDES BENZ		SWP-M-G
246-075-021-001	823 955 651	AUDI	246-075-021-006C	SWP-M-G
246-075-021-001	823 955 651	VW	246-075-021-006C	SWP-M-G
246-075-021-003	73PG17K624AA	FORD	246-075-023-004C	SWP-M-G
246-075-021-004	000 869 29 21	MERCEDES BENZ	246-075-021-007C	SWP-M-G





Article No.	OE No.	Manufacturer	Article No. (new)	Product Name
246-075-021-004	A000 869 29 21	MERCEDES BENZ	246-075-021-007C	SWP-M-G
246-075-021-006C	1254197	VOLVO		SWP-M-G
246-075-021-006C	823 955 651	AUDI		SWP-M-G
246-075-021-006C	823 955 651	VW		SWP-M-G
246-075-021-007C	000 869 29 21	MERCEDES BENZ		SWP-M-G
246-075-021-007C	000 869 30 21	MERCEDES BENZ		SWP-M-G
246-075-021-007C	A000 869 29 21	MERCEDES BENZ		SWP-M-G
246-075-021-007C	A000 869 30 21	MERCEDES BENZ		SWP-M-G
246-075-023-003	1 359 115	BMW	246-075-023-004C	SWP-M-G
246-075-023-003	1 359 116	BMW	246-075-023-004C	SWP-M-G
246-075-023-003	3276564	VOLVO	246-075-023-004C	SWP-M-G
246-075-023-003	61 67 1 359 115	BMW	246-075-023-004C	SWP-M-G
246-075-023-003	61 67 1 359 116	BMW	246-075-023-004C	SWP-M-G
246-075-023-003	73PG17K624AA	FORD	246-075-023-004C	SWP-M-G
246-075-023-004C	1 359 115	BMW		SWP-M-G
246-075-023-004C	1 359 116	BMW		SWP-M-G
246-075-023-004C	3276564	VOLVO		SWP-M-G
246-075-023-004C	61 67 1 359 115	BMW		SWP-M-G
246-075-023-004C	61 67 1 359 116	BMW		SWP-M-G
246-075-023-004C	73PG17K624AA	FORD		SWP-M-G
246-075-023-020	928 628 074 01	PORSCHE	246-075-015-001C	SWP-M-G
246-075-024-002C	000 869 31 21	MERCEDES BENZ		SWP-M-G
246-075-024-002C	A000 869 31 21	MERCEDES BENZ		SWP-M-G
246-075-024-004	81.26485-6008	MAN	246-075-010-001C	SWP-M-G
246-075-040-020C	1585878	VOLVO		SWP-M-G
246-075-042-001C	1 368 549	BMW		SWP-M-G
246-075-042-001C	1 370 033	BMW		SWP-M-G
246-075-042-001C	1 370 465	BMW		SWP-M-G
246-075-042-001C	3205207	VOLVO		SWP-M-G
246-075-042-001C	61 66 1 368 549	BMW		SWP-M-G
246-075-042-001C	61 66 1 370 033	BMW		SWP-M-G
246-075-042-001C	61 66 1 370 465	BMW		SWP-M-G
246-075-042-001C	823 955 651	PORSCHE		SWP-M-G
246-075-042-001C	86VB17K624AA	FORD		SWP-M-G
246-075-042-001C	928 628 172 01	PORSCHE		SWP-M-G
246-075-044-001C	1258016	VOLVO		SWP-M-G
246-075-044-001C	246-082-008-016Z	VDO		SWP-M-G
246-075-044-001C	8TW 006 848-101	HELLA		SWP-M-G
246-075-044-001C	9178094	VOLVO		SWP-M-G
246-075-044-002A	1259832	VOLVO		SWP-M-G
246-075-044-002A	8TW 004 223-031	HELLA		SWP-M-G
246-075-044-003A	1395994	SCANIA		SWP-M-G
246-075-050-007C	000 860 15 26	MERCEDES BENZ		SWP-M-G
246-075-050-007C	A000 860 15 26	MERCEDES BENZ		SWP-M-G
246-075-051-007C	1606929	VOLVO		SWP-M-G
246-080-003-001	126 860 07 47	MERCEDES BENZ	246-080-003-006D	N-H



Article No.	OE No.	Manufacturer	Article No. (new)	Product Name
246-080-003-001	A126 860 07 47	MERCEDES BENZ	246-080-003-006D	N-H
246-080-003-006D	126 860 07 47	MERCEDES BENZ		N-H
246-080-003-006D	A126 860 07 47	MERCEDES BENZ		N-H
246-080-010-002Z	191 955 986 A	SEAT		N-H
246-080-010-002Z	191 955 986 A	VW		N-H
246-080-010-002Z	246-080-010-002D	VDO		N-H
246-080-013-001Z	1 378 799	BMW		N-H
246-080-013-001Z	246-080-013-001A	VDO		N-H
246-080-013-001Z	61 66 1 378 799	BMW		N-H
246-080-013-003Z	246-080-013-003A	VDO		N-H
246-080-013-003Z	61 66 8 350 355	BMW		N-H
246-080-013-003Z	8 350 355	BMW		N-H
246-082-001-001C	367110	SCANIA		SWP-M-C
246-082-001-001C	8TW 004 223-031	HELLA		SWP-M-C
246-082-001-001C	95 06 379	SAAB		SWP-M-C
246-082-001-002C	353546	SCANIA		SWP-M-C
246-082-003-001	295970	SCANIA	246-082-008-012C	SWP-M-C
246-082-003-002	690 955 651	VW	246-082-008-012C	SWP-M-C
246-082-003-002	81.26485-6016	MAN	246-082-008-012C	SWP-M-C
246-082-003-003	000 860 13 26	MERCEDES BENZ	246-082-008-014C	SWP-M-C
246-082-003-003	A000 860 13 26	MERCEDES BENZ	246-082-008-014C	SWP-M-C
246-082-003-004C	0665345	DAF	246-082-008-012C	SWP-M-C
246-082-003-004C	9 665 345	IVECO	246-082-008-012C	SWP-M-C
246-082-003-005C	85 93 477	SAAB	246-082-008-014C	SWP-M-C
246-082-003-007	431 955 651	AUDI	246-082-008-014C	SWP-M-C
246-082-003-007	431 955 651	SEAT	246-082-008-014C	SWP-M-C
246-082-003-007	431 955 651	VW	246-082-008-014C	SWP-M-C
246-082-003-009C	000 860 12 26	MERCEDES BENZ	246-082-008-012C	SWP-M-C
246-082-003-009C	A000 860 12 26	MERCEDES BENZ	246-082-008-012C	SWP-M-C
246-082-003-011	6153469	FORD	246-082-008-014C	SWP-M-C
246-082-003-011	86VB17K624AA	FORD	246-082-008-014C	SWP-M-C
246-082-003-013	1 368 549	BMW	246-075-042-001C	SWP-M-G
246-082-003-013	1 370 033	BMW	246-075-042-001C	SWP-M-G
246-082-003-013	1 370 465	BMW	246-075-042-001C	SWP-M-G
246-082-003-013	61 66 1 368 549	BMW	246-075-042-001C	SWP-M-G
246-082-003-013	61 66 1 370 033	BMW	246-075-042-001C	SWP-M-G
246-082-003-013	61 66 1 370 465	BMW	246-075-042-001C	SWP-M-G
246-082-003-016	000 860 20 26	MERCEDES BENZ	246-082-008-014C	SWP-M-C
246-082-003-016	A000 860 20 26	MERCEDES BENZ	246-082-008-014C	SWP-M-C
246-082-005-001	124 869 00 21	MERCEDES BENZ	246-082-005-002C	SWP-M-C
246-082-005-001	124 869 01 21	MERCEDES BENZ	246-082-005-002C	SWP-M-C
246-082-005-001	124 869 03 21	MERCEDES BENZ	246-082-005-002C	SWP-M-C
246-082-005-001	124 869 04 21	MERCEDES BENZ	246-082-005-002C	SWP-M-C
246-082-005-001	124 869 05 21	MERCEDES BENZ	246-082-005-002C	SWP-M-C
246-082-005-001	124 869 06 21	MERCEDES BENZ	246-082-005-002C	SWP-M-C
246-082-005-001	A124 869 00 21	MERCEDES BENZ	246-082-005-002C	SWP-M-C



Article No.	OE No.	Manufacturer	Article No. (new)	Product Name
246-082-005-001	A124 869 01 21	MERCEDES BENZ	246-082-005-002C	SWP-M-C
246-082-005-001	A124 869 03 21	MERCEDES BENZ	246-082-005-002C	SWP-M-C
246-082-005-001	A124 869 04 21	MERCEDES BENZ	246-082-005-002C	SWP-M-C
246-082-005-001	A124 869 05 21	MERCEDES BENZ	246-082-005-002C	SWP-M-C
246-082-005-001	A124 869 06 21	MERCEDES BENZ	246-082-005-002C	SWP-M-C
246-082-005-002C	124 869 00 21	MERCEDES BENZ		SWP-M-C
246-082-005-002C	124 869 01 21	MERCEDES BENZ		SWP-M-C
246-082-005-002C	124 869 03 21	MERCEDES BENZ		SWP-M-C
246-082-005-002C	124 869 04 21	MERCEDES BENZ		SWP-M-C
246-082-005-002C	124 869 05 21	MERCEDES BENZ		SWP-M-C
246-082-005-002C	124 869 06 21	MERCEDES BENZ		SWP-M-C
246-082-005-002C	8TW 005 496-011	HELLA		SWP-M-C
246-082-005-002C	A124 869 00 21	MERCEDES BENZ		SWP-M-C
246-082-005-002C	A124 869 01 21	MERCEDES BENZ		SWP-M-C
246-082-005-002C	A124 869 03 21	MERCEDES BENZ		SWP-M-C
246-082-005-002C	A124 869 04 21	MERCEDES BENZ		SWP-M-C
246-082-005-002C	A124 869 05 21	MERCEDES BENZ		SWP-M-C
246-082-005-002C	A124 869 06 21	MERCEDES BENZ		SWP-M-C
246-082-008-001Z	1H5 955 651	SEAT	246-082-008-021G	SWP-M-C
246-082-008-001Z	1H5 955 651	VW	246-082-008-021G	SWP-M-C
246-082-008-003	140 869 02 21	MERCEDES BENZ	246-082-008-013P	SWP-M-C
246-082-008-003	A140 869 02 21	MERCEDES BENZ	246-082-008-013P	SWP-M-C
246-082-008-005	000 860 32 26	MERCEDES BENZ	246-082-008-012C	SWP-M-C
246-082-008-005	A000 860 32 26	MERCEDES BENZ	246-082-008-012C	SWP-M-C
246-082-008-008	14 50 156	OPEL	246-082-008-014C	SWP-M-C
246-082-008-008	14 50 174	OPEL	246-082-008-014C	SWP-M-C
246-082-008-008	90045820	OPEL	246-082-008-014C	SWP-M-C
246-082-008-009	000 860 33 26	MERCEDES BENZ	246-082-008-014C	SWP-M-C
246-082-008-009	A000 860 33 26	MERCEDES BENZ	246-082-008-014C	SWP-M-C
246-082-008-011C	202 869 00 21	MERCEDES BENZ	246-082-008-013P	SWP-M-C
246-082-008-011C	A202 869 00 21	MERCEDES BENZ	246-082-008-013P	SWP-M-C
246-082-008-012C	000 860 12 26	MERCEDES BENZ		SWP-M-C
246-082-008-012C	000 860 32 26	MERCEDES BENZ		SWP-M-C
246-082-008-012C	0665345	DAF		SWP-M-C
246-082-008-012C	246-082-008-012V	VDO		SWP-M-C
246-082-008-012C	295970	SCANIA		SWP-M-C
246-082-008-012C	690 955 651	VW		SWP-M-C
246-082-008-012C	81.26485-6016	MAN		SWP-M-C
246-082-008-012C	9 665 345	IVECO		SWP-M-C
246-082-008-012C	A000 860 12 26	MERCEDES BENZ		SWP-M-C
246-082-008-012C	A000 860 32 26	MERCEDES BENZ		SWP-M-C
246-082-008-013P	140 869 02 21	MERCEDES BENZ		SWP-M-C
246-082-008-013P	202 869 00 21	MERCEDES BENZ		SWP-M-C
246-082-008-013P	A140 869 02 21	MERCEDES BENZ		SWP-M-C
246-082-008-013P	A202 869 00 21	MERCEDES BENZ		SWP-M-C
246-082-008-014C	000 860 13 26	MERCEDES BENZ		SWP-M-C



Article No.	OE No.	Manufacturer	Article No. (new)	Product Name
246-082-008-014C	000 860 20 26	MERCEDES BENZ		SWP-M-C
246-082-008-014C	000 860 33 26	MERCEDES BENZ		SWP-M-C
246-082-008-014C	14 50 156	OPEL		SWP-M-C
246-082-008-014C	14 50 174	OPEL		SWP-M-C
246-082-008-014C	14 50 174	VAUXHALL		SWP-M-C
246-082-008-014C	2108 5208009 20	LADA		SWP-M-C
246-082-008-014C	431 955 651	AUDI		SWP-M-C
246-082-008-014C	431 955 651	PORSCHE		SWP-M-C
246-082-008-014C	431 955 651	SEAT		SWP-M-C
246-082-008-014C	431 955 651	VW		SWP-M-C
246-082-008-014C	6153469	FORD		SWP-M-C
246-082-008-014C	85 93 477	SAAB		SWP-M-C
246-082-008-014C	86VB17K624AA	FORD		SWP-M-C
246-082-008-014C	8TW 004 223-031	HELLA		SWP-M-C
246-082-008-014C	90045820	OPEL		SWP-M-C
246-082-008-014C	A000 860 13 26	MERCEDES BENZ		SWP-M-C
246-082-008-014C	A000 860 20 26	MERCEDES BENZ		SWP-M-C
246-082-008-014C	A000 860 33 26	MERCEDES BENZ		SWP-M-C
246-082-008-015N	0001753V001000000	SMART	246-082-008-025G	SWP-M-C
246-082-008-015N	210 869 08 21	MERCEDES BENZ	246-082-008-025G	SWP-M-C
246-082-008-015N	67 12 8 377 612	BMW	246-082-008-025G	SWP-M-C
246-082-008-015N	8 377 612	BMW	246-082-008-025G	SWP-M-C
246-082-008-015N	996 628 172 00	PORSCHE	246-082-008-025G	SWP-M-C
246-082-008-015N	A210 869 08 21	MERCEDES BENZ	246-082-008-025G	SWP-M-C
246-082-008-016Z	9178094	VOLVO	246-075-044-001C	SWP-M-G
246-082-008-017	67 12 8 362 154	BMW	246-082-008-025G	SWP-M-C
246-082-008-017	8 362 154	BMW	246-082-008-025G	SWP-M-C
246-082-008-018	14 50 184	OPEL	246-082-008-021G	SWP-M-C
246-082-008-018	90585761	OPEL	246-082-008-021G	SWP-M-C
246-082-008-019	1J5 955 651	AUDI	246-082-008-025G	SWP-M-C
246-082-008-019	1J5 955 651	SEAT	246-082-008-025G	SWP-M-C
246-082-008-019	1J5 955 651	SKODA	246-082-008-025G	SWP-M-C
246-082-008-019	1J5 955 651	VW	246-082-008-025G	SWP-M-C
246-082-008-021G	14 50 184	OPEL		SWP-M-C
246-082-008-021G	14 50 184	VAUXHALL		SWP-M-C
246-082-008-021G	1H5 955 651	SEAT		SWP-M-C
246-082-008-021G	1H5 955 651	VW		SWP-M-C
246-082-008-021G	8TW 004 223-061	HELLA		SWP-M-C
246-082-008-021G	90585761	OPEL		SWP-M-C
246-082-008-021G	90585761	VAUXHALL		SWP-M-C
246-082-008-022	1J5 955 651	AUDI	246-082-008-025G	SWP-M-C
246-082-008-022	1J5 955 651	SEAT	246-082-008-025G	SWP-M-C
246-082-008-022	1J5 955 651	SKODA	246-082-008-025G	SWP-M-C
246-082-008-022	1J5 955 651	VW	246-082-008-025G	SWP-M-C
246-082-008-025G	0001753V001000000	SMART		SWP-M-C
246-082-008-025G	1 199 567	BMW		SWP-M-C



Article No.	OE No.	Manufacturer	Article No. (new)	Product Name
246-082-008-025G	1J5 955 651	AUDI		SWP-M-C
246-082-008-025G	1J5 955 651	SEAT		SWP-M-C
246-082-008-025G	1J5 955 651	SKODA		SWP-M-C
246-082-008-025G	1J5 955 651	VW		SWP-M-C
246-082-008-025G	1K5 955 651	AUDI		SWP-M-C
246-082-008-025G	1K5 955 651	SEAT		SWP-M-C
246-082-008-025G	1K5 955 651	SKODA		SWP-M-C
246-082-008-025G	1K5 955 651	VW		SWP-M-C
246-082-008-025G	1T0 955 651	SKODA		SWP-M-C
246-082-008-025G	1T0 955 651	VW		SWP-M-C
246-082-008-025G	210 869 08 21	MERCEDES BENZ		SWP-M-C
246-082-008-025G	221 869 01 21	MERCEDES BENZ		SWP-M-C
246-082-008-025G	221 869 01 21	SMART		SWP-M-C
246-082-008-025G	3020175	VDO		SWP-M-C
246-082-008-025G	431 955 651	PORSCHE		SWP-M-C
246-082-008-025G	67 12 1 199 567	BMW		SWP-M-C
246-082-008-025G	67 12 7 302 588	BMW		SWP-M-C
246-082-008-025G	67 12 8 362 154	BMW		SWP-M-C
246-082-008-025G	67 12 8 377 612	BMW		SWP-M-C
246-082-008-025G	7 302 588	BMW		SWP-M-C
246-082-008-025G	76806-SMG-E01	HONDA		SWP-M-C
246-082-008-025G	8 362 154	BMW		SWP-M-C
246-082-008-025G	8 377 612	BMW		SWP-M-C
246-082-008-025G	8TW 006 848-021	HELLA		SWP-M-C
246-082-008-025G	8TW 006 848-041	HELLA		SWP-M-C
246-082-008-025G	996 628 172 00	PORSCHE		SWP-M-C
246-082-008-025G	A210 869 08 21	MERCEDES BENZ		SWP-M-C
246-082-008-025G	A221 869 01 21	MERCEDES BENZ		SWP-M-C
246-082-008-025G	A221 869 01 21	SMART		SWP-M-C
246-082-008-026	1T0 955 651	SKODA	246-082-008-025G	SWP-M-C
246-082-008-026	1T0 955 651	VW	246-082-008-025G	SWP-M-C
246-083-001-001	14 50 175	OPEL	246-083-001-004C	SWP-D-C
246-083-001-001	90226604	OPEL	246-083-001-004C	SWP-D-C
246-083-001-002	333 955 651	VW	246-083-002-006G	SWP-D-C
246-083-001-004C	14 50 175	OPEL		SWP-D-C
246-083-001-004C	14 50 175	VAUXHALL		SWP-D-C
246-083-001-004C	246-083-001-001	VDO		SWP-D-C
246-083-001-004C	46797755	ALFA		SWP-D-C
246-083-001-004C	46797755	FIAT		SWP-D-C
246-083-001-004C	46797755	LANCIA		SWP-D-C
246-083-001-004C	71719636	ALFA		SWP-D-C
246-083-001-004C	71719636	FIAT		SWP-D-C
246-083-001-004C	71719636	LANCIA		SWP-D-C
246-083-001-004C	8TW 005 206-031	HELLA		SWP-D-C
246-083-001-004C	90226604	OPEL		SWP-D-C
246-083-001-004C	90492357	VAUXHALL		SWP-D-C



Article No.	OE No.	Manufacturer	Article No. (new)	Product Name
246-083-001-006C	81.26485-6027	MAN		SWP-D-C
246-083-002-001Z	1H6 955 651	SEAT	246-083-002-014G	SWP-D-C
246-083-002-001Z	1H6 955 651	VW	246-083-002-014G	SWP-D-C
246-083-002-002C	333 955 651	VW	246-083-002-006G	SWP-D-C
246-083-002-005C	0000038V001000000	SMART	246-083-002-022G	SWP-D-C
246-083-002-006G	333 955 651	VW		SWP-D-C
246-083-002-006G	8TW 005 206-011	HELLA		SWP-D-C
246-083-002-006G	8TW 005 206-017	HELLA		SWP-D-C
246-083-002-006G	8TW 005 206-031	HELLA		SWP-D-C
246-083-002-007	1H6 955 651	SEAT	246-083-002-014G	SWP-D-C
246-083-002-008	14 50 185	OPEL	246-083-002-014G	SWP-D-C
246-083-002-008	90585762	OPEL	246-083-002-014G	SWP-D-C
246-083-002-009	67 12 8 377 987	BMW	246-083-002-022G	SWP-D-C
246-083-002-009	8 377 987	BMW	246-083-002-022G	SWP-D-C
246-083-002-010	1J6 955 651	AUDI	246-083-002-022G	SWP-D-C
246-083-002-010	1J6 955 651	SEAT	246-083-002-022G	SWP-D-C
246-083-002-010	1J6 955 651	SKODA	246-083-002-022G	SWP-D-C
246-083-002-010	1J6 955 651	VW	246-083-002-022G	SWP-D-C
246-083-002-012G	14 50 185	OPEL	246-083-002-014G	SWP-D-C
246-083-002-012G	90585762	OPEL	246-083-002-014G	SWP-D-C
246-083-002-014G	14 50 185	OPEL		SWP-D-C
246-083-002-014G	14 50 185	VAUXHALL		SWP-D-C
246-083-002-014G	1H6 955 651	SEAT		SWP-D-C
246-083-002-014G	1H6 955 651	VW		SWP-D-C
246-083-002-014G	7222079	FORD		SWP-D-C
246-083-002-014G	8TW 005 206-051	HELLA		SWP-D-C
246-083-002-014G	90585762	OPEL		SWP-D-C
246-083-002-014G	90585762	VAUXHALL		SWP-D-C
246-083-002-014G	95VW17K624AA	FORD		SWP-D-C
246-083-002-015	1J6 955 651	AUDI	246-083-002-022G	SWP-D-C
246-083-002-015	1J6 955 651	SEAT	246-083-002-022G	SWP-D-C
246-083-002-015	1J6 955 651	SKODA	246-083-002-022G	SWP-D-C
246-083-002-015	1J6 955 651	VW	246-083-002-022G	SWP-D-C
246-083-002-019	1T0 955 651 A	AUDI	246-083-002-022G	SWP-D-C
246-083-002-019	1T0 955 651 A	SEAT	246-083-002-022G	SWP-D-C
246-083-002-019	1T0 955 651 A	SKODA	246-083-002-022G	SWP-D-C
246-083-002-019	1T0 955 651 A	VW	246-083-002-022G	SWP-D-C
246-083-002-022G	1J6 955 651	AUDI		SWP-D-C
246-083-002-022G	1K6 955 651	AUDI		SWP-D-C
246-083-002-022G	1T0 955 651 A	AUDI		SWP-D-C
246-083-002-022G	67 12 8 377 987	BMW		SWP-D-C
246-083-002-022G	8 377 987	BMW		SWP-D-C
246-083-002-022G	204 866 02 21	MERCEDES BENZ		SWP-D-C
246-083-002-022G	A204 866 02 21	MERCEDES BENZ		SWP-D-C
246-083-002-022G	1J6 955 651	SEAT		SWP-D-C
246-083-002-022G	1K6 955 651	SEAT		SWP-D-C



Article No.	OE No.	Manufacturer	Article No. (new)	Product Name
246-083-002-022G	1T0 955 651 A	SEAT		SWP-D-C
246-083-002-022G	1J6 955 651	SKODA		SWP-D-C
246-083-002-022G	1K6 955 651	SKODA		SWP-D-C
246-083-002-022G	1T0 955 651 A	SKODA		SWP-D-C
246-083-002-022G	1J6 955 651	VW		SWP-D-C
246-083-002-022G	1K6 955 651	VW		SWP-D-C
246-083-002-022G	1T0 955 651 A	VW		SWP-D-C
246-083-002-022G	5K0 955 651	VW		SWP-D-C
246-083-002-022G	0000038V001000000	SMART		SWP-D-C
246-083-002-022G	3043125	VDO		SWP-D-C
246-083-002-022G	3091387	VDO		SWP-D-C
246-083-002-022G	8TW 006 847-021	HELLA		SWP-D-C
246-086-001-002C	191 955 681	VW		HLWP
246-086-001-002C	1J0 955 681	AUDI		HLWP
246-086-001-002C	1J0 955 681	SEAT		HLWP
246-086-001-002C	1J0 955 681	SKODA		HLWP
246-086-001-002C	3B0 955 681	VW		HLWP
246-086-001-002C	8TW 006 849-011	HELLA		HLWP
246-086-001-002C	996 624 502 00	PORSCHE		HLWP
246-086-001-002C	MR911031	MINI		HLWP
246-086-001-004	67 12 8 377 430	BMW	246-086-001-007C	HLWP
246-086-001-004	67 12 8 377 613	BMW	246-086-001-007C	HLWP
246-086-001-004	8 377 430	BMW	246-086-001-007C	HLWP
246-086-001-004	8 377 613	BMW	246-086-001-007C	HLWP
246-086-001-005	3B0 955 681	VW	246-086-001-002C	HLWP
246-086-001-006	191 955 681	VW	246-086-001-002C	HLWP
246-086-001-006	1J0 955 681	AUDI	246-086-001-002C	HLWP
246-086-001-006	1J0 955 681	SEAT	246-086-001-002C	HLWP
246-086-001-007C	3B0 955 681 A	SKODA		HLWP
246-086-001-007C	3B0 955 681 A	VW		HLWP
246-086-001-007C	3B7 955 681	AUDI		HLWP
246-086-001-007C	3B7 955 681	SEAT		HLWP
246-086-001-007C	3B7 955 681	SKODA		HLWP
246-086-001-007C	3B7 955 681	VW		HLWP
246-086-001-007C	67 12 8 377 430	BMW		HLWP
246-086-001-007C	67 12 8 377 613	BMW		HLWP
246-086-001-007C	8 377 430	BMW		HLWP
246-086-001-007C	8 377 613	BMW		HLWP
246-086-001-007C	970 624 502 00	PORSCHE		HLWP
246-086-001-007C	997 624 502 00	PORSCHE		HLWP
246-086-001-016	3B7 955 681	AUDI	246-086-001-007C	HLWP
246-086-001-016	3B7 955 681	SEAT	246-086-001-007C	HLWP
246-086-001-016	3B7 955 681	SKODA	246-086-001-007C	HLWP
246-086-001-016	3B7 955 681	VW	246-086-001-007C	HLWP
246-086-001-017	3B0 955 681 A	AUDI	246-086-001-007C	HLWP
246-086-001-017	3B0 955 681 A	SEAT	246-086-001-007C	HLWP



Article No.	OE No.	Manufacturer	Article No. (new)	Product Name
246-086-001-017	3B0 955 681 A	SKODA	246-086-001-007C	HLWP
246-086-001-017	3B0 955 681 A	VW	246-086-001-007C	HLWP
395-060-017-001C	1 369 263	BMW		FLS
395-060-017-001C	61 31 1 369 263	BMW		FLS
88-205-001	000 869 01 58	MERCEDES BENZ		C
88-205-001	A000 869 01 58	MERCEDES BENZ		C
88-326-004	107 869 00 24	MERCEDES BENZ		C
88-326-004	A107 869 00 24	MERCEDES BENZ		C
89-602-050	81.26481-0033	MAN		G
A2C53030219	0000643497	CITROEN		SWP-M-C
A2C53030219	0000643497	PEUGEOT		SWP-M-C
A2C53030219	3030219	VDO		SWP-M-C
A2C53030219	643497	CITROEN		SWP-M-C
A2C53030219	643497	PEUGEOT		SWP-M-C
A2C53030219	9643447780	CITROEN		SWP-M-C
A2C53030219	9643447780	PEUGEOT		SWP-M-C
A2C53030301	0000643492	CITROEN		SWP-D-C
A2C53030301	0000643492	PEUGEOT		SWP-D-C
A2C53030301	3030301	VDO		SWP-D-C
A2C53030301	643492	CITROEN		SWP-D-C
A2C53030301	643492	PEUGEOT		SWP-D-C
A2C53030301	9641553980	FIAT		SWP-D-C
A2C53030301	9643447980	CITROEN		SWP-D-C
A2C53030301	9643447980	PEUGEOT		SWP-D-C
A2C53240114	1 450 058	OPEL		SWP-M-C
A2C53240114	13250356	CHEVROLET		SWP-M-C
A2C53240114	13250356	OPEL		SWP-M-C
A2C53240114	13250356	SAAB		SWP-M-C
A2C53240114	3240114	SIEMENS		SWP-M-C
A2C53240479Z	20 92 6495	SWAG		SWP-M-C
A2C53240479Z	3240479	VDO		SWP-M-C
A2C53240479Z	6 934 159	BMW		SWP-M-C
A2C53240479Z	6 934 160	BMW		SWP-M-C
A2C53240479Z	67 12 6 934 159	BMW		SWP-M-C
A2C53240479Z	67 12 6 934 160	BMW		SWP-M-C
A2C53240479Z	67 12 7 302 589	BMW		SWP-M-C
A2C53240479Z	7 302 589	BMW		SWP-M-C
A2C53240479Z	A2C53240479	VDO		SWP-M-C
A2C53304876	3304876	CONTINENTAL		HLWP
A2C53304876	67 63 7 217 792	BMW		HLWP
A2C53304876	7 217 792	BMW		HLWP
A2C53304876	8K0 955 681	VW		HLWP
X10-729-002-004	1652613	FORD		SWP-M-C
X10-729-002-004	1E0076672	MAZDA		SWP-M-C
X10-729-002-004	1E00-76-672	MAZDA		SWP-M-C
X10-729-002-004	7003178	FORD		SWP-M-C





Article No.	OE No.	Manufacturer	Article No. (new)	Product Name
X10-729-002-004	87AB17K624AC	FORD		SWP-M-C
X10-729-002-004	8TW 006 847-007	HELLA		SWP-M-C
X10-729-002-004	93BB17K624BA	FORD		SWP-M-C
X10-729-002-005	6833495	FORD		SWP-M-C
X10-729-002-005	7003177	FORD		SWP-M-C
X10-729-002-005	8TW 006 848-007	HELLA		SWP-M-C
X10-729-002-005	92AB17K624AA	FORD		SWP-M-C
X10-729-002-005	93BB17K624AA	FORD		SWP-M-C
X10-729-002-006	7700802336	RENAULT		SWP-M-C
X10-729-002-006	8TW 006 848-057	HELLA		SWP-M-C
X10-729-002-007	0000643458	CITROEN		SWP-M-C
X10-729-002-007	0000643458	PEUGEOT		SWP-M-C
X10-729-002-007	643458	CITROEN		SWP-M-C
X10-729-002-007	643458	PEUGEOT		SWP-M-C
X10-729-002-007	8TW 006 848-077	HELLA		SWP-M-C
X10-729-002-008	6140949	FORD		SWP-M-C
X10-729-002-008	83BB17K624BA	FORD		SWP-M-C
X10-729-002-008	8TW 006 849-007	HELLA		SWP-M-C
X11-246-003-014	1J0 973 722 A	AUDI		A
X11-246-003-014	1J0 973 722 A	SEAT		A
X11-246-003-014	1J0 973 722 A	SKODA		A
X11-246-003-014	1J0 973 722 A	VW		A



# Cross-Reference Article No. > OE No. (sorted by manufacturers)

Article No.	OE No.	Article No. (new)	Product Name
<b>ALFA ROMEO</b>			
246-083-001-004C	46797755		SWP-D-C
246-083-001-004C	71719636		SWP-D-C

## AUDI

246-075-021-001	823 955 651	246-075-021-006C	SWP-M-G
246-075-021-006C	823 955 651		SWP-M-G
246-082-003-007	431 955 651	246-082-008-014C	SWP-M-C
246-082-008-014C	431 955 651		SWP-M-C
246-082-008-019	1J5 955 651	246-082-008-025G	SWP-M-C
246-082-008-022	1J5 955 651	246-082-008-025G	SWP-M-C
246-082-008-025G	1J5 955 651		SWP-M-C
246-082-008-025G	1K5 955 651		SWP-M-C
246-083-002-010	1J6 955 651	246-083-002-022G	SWP-D-C
246-083-002-015	1J6 955 651	246-083-002-022G	SWP-D-C
246-083-002-019	1T0 955 651 A	246-083-002-022G	SWP-D-C
246-083-002-022G	1J6 955 651		SWP-D-C
246-083-002-022G	1K6 955 651		SWP-D-C
246-083-002-022G	1T0 955 651 A		SWP-D-C
246-086-001-002C	1J0 955 681		HLWP
246-086-001-006	1J0 955 681	246-086-001-002C	HLWP
246-086-001-007C	3B7 955 681		HLWP
246-086-001-016	3B7 955 681	246-086-001-007C	HLWP
246-086-001-017	3B0 955 681 A	246-086-001-007C	HLWP
X11-246-003-014	1J0 973 722 A		A

## BMW

246-063-013-001D	1 355 299		V
246-063-013-001D	61 66 1 355 299		V
246-069-059-001Z	1 379 735		N
246-069-059-001Z	61 66 1 379 735		N
246-075-023-003	1 359 115	246-075-023-004C	SWP-M-G
246-075-023-003	1 359 116	246-075-023-004C	SWP-M-G
246-075-023-003	61 67 1 359 115	246-075-023-004C	SWP-M-G
246-075-023-003	61 67 1 359 116	246-075-023-004C	SWP-M-G
246-075-023-004C	1 359 115		SWP-M-G
246-075-023-004C	1 359 116		SWP-M-G
246-075-023-004C	61 67 1 359 115		SWP-M-G
246-075-023-004C	61 67 1 359 116		SWP-M-G
246-075-042-001C	1 368 549		SWP-M-G
246-075-042-001C	1 370 033		SWP-M-G
246-075-042-001C	1 370 465		SWP-M-G
246-075-042-001C	61 66 1 368 549		SWP-M-G



Article No.	OE No.	Article No. (new)	Product Name
246-075-042-001C	61 66 1 370 033		SWP-M-G
246-075-042-001C	61 66 1 370 465		SWP-M-G
246-080-013-001Z	1 378 799		N-H
246-080-013-001Z	61 66 1 378 799		N-H
246-080-013-003Z	61 66 8 350 355		N-H
246-080-013-003Z	8 350 355		N-H
246-082-003-013	1 368 549	246-075-042-001C	SWP-M-G
246-082-003-013	1 370 033	246-075-042-001C	SWP-M-G
246-082-003-013	1 370 465	246-075-042-001C	SWP-M-G
246-082-003-013	61 66 1 368 549	246-075-042-001C	SWP-M-G
246-082-003-013	61 66 1 370 033	246-075-042-001C	SWP-M-G
246-082-003-013	61 66 1 370 465	246-075-042-001C	SWP-M-G
246-082-008-015N	67 12 8 377 612	246-082-008-025G	SWP-M-C
246-082-008-015N	8 377 612	246-082-008-025G	SWP-M-C
246-082-008-017	67 12 8 362 154	246-082-008-025G	SWP-M-C
246-082-008-017	8 362 154	246-082-008-025G	SWP-M-C
246-082-008-025G	1 199 567		SWP-M-C
246-082-008-025G	67 12 1 199 567		SWP-M-C
246-082-008-025G	67 12 7 302 588		SWP-M-C
246-082-008-025G	67 12 8 362 154		SWP-M-C
246-082-008-025G	67 12 8 377 612		SWP-M-C
246-082-008-025G	7 302 588		SWP-M-C
246-082-008-025G	8 362 154		SWP-M-C
246-082-008-025G	8 377 612		SWP-M-C
246-083-002-009	67 12 8 377 987	246-083-002-022G	SWP-D-C
246-083-002-009	8 377 987	246-083-002-022G	SWP-D-C
246-083-002-022G	67 12 8 377 987		SWP-D-C
246-083-002-022G	8 377 987		SWP-D-C
246-086-001-004	67 12 8 377 430	246-086-001-007C	HLWP
246-086-001-004	67 12 8 377 613	246-086-001-007C	HLWP
246-086-001-004	8 377 430	246-086-001-007C	HLWP
246-086-001-004	8 377 613	246-086-001-007C	HLWP
246-086-001-007C	67 12 8 377 430		HLWP
246-086-001-007C	67 12 8 377 613		HLWP
246-086-001-007C	8 377 430		HLWP
246-086-001-007C	8 377 613		HLWP
395-060-017-001C	1 369 263		FLS
395-060-017-001C	61 31 1 369 263		FLS
A2C53240479Z	6 934 159		SWP-M-C
A2C53240479Z	6 934 160		SWP-M-C
A2C53240479Z	67 12 6 934 159		SWP-M-C
A2C53240479Z	67 12 6 934 160		SWP-M-C
A2C53240479Z	67 12 7 302 589		SWP-M-C
A2C53240479Z	7 302 589		SWP-M-C
A2C53304876	67 63 7 217 792		HLWP
A2C53304876	7 217 792		HLWP



Article No.	OE No.	Article No. (new)	Product Name
<b>CHEVROLET</b>			
A2C53240114	13250356		SWP-M-C

<b>CITROËN</b>			
A2C53030219	0000643497		SWP-M-C
A2C53030219	643497		SWP-M-C
A2C53030219	9643447780		SWP-M-C
A2C53030301	0000643492		SWP-D-C
A2C53030301	643492		SWP-D-C
A2C53030301	9643447980		SWP-D-C
X10-729-002-007	0000643458		SWP-M-C
X10-729-002-007	643458		SWP-M-C

<b>CONTINENTAL</b>			
A2C53304876	3304876		HLWP

<b>DAF</b>			
246-082-003-004C	0665345	246-082-008-012C	SWP-M-C
246-082-008-012C	0665345		SWP-M-C

<b>FIAT</b>			
246-083-001-004C	46797755		SWP-D-C
246-083-001-004C	71719636		SWP-D-C
A2C53030301	9641553980		SWP-D-C

<b>FORD</b>			
246-075-021-003	73PG17K624AA	246-075-023-004C	SWP-M-G
246-075-023-003	73PG17K624AA	246-075-023-004C	SWP-M-G
246-075-023-004C	73PG17K624AA		SWP-M-G
246-075-042-001C	86VB17K624AA		SWP-M-G
246-082-003-011	6153469	246-082-008-014C	SWP-M-C
246-082-003-011	86VB17K624AA	246-082-008-014C	SWP-M-C
246-082-008-014C	6153469		SWP-M-C
246-082-008-014C	86VB17K624AA		SWP-M-C
246-083-002-014G	7222079		SWP-D-C
246-083-002-014G	95VW17K624AA		SWP-D-C
X10-729-002-004	1652613		SWP-M-C
X10-729-002-004	7003178		SWP-M-C
X10-729-002-004	87AB17K624AC		SWP-M-C



Article No.	OE No.	Article No. (new)	Product Name
X10-729-002-004	93BB17K624BA		SWP-M-C
X10-729-002-005	6833495		SWP-M-C
X10-729-002-005	7003177		SWP-M-C
X10-729-002-005	92AB17K624AA		SWP-M-C
X10-729-002-005	93BB17K624AA		SWP-M-C
X10-729-002-008	6140949		SWP-M-C
X10-729-002-008	83BB17K624BA		SWP-M-C

**HELLA**

246-075-044-001C	8TW 006 848-101		SWP-M-G
246-075-044-002A	8TW 004 223-031		SWP-M-G
246-082-001-001C	8TW 004 223-031		SWP-M-C
246-082-005-002C	8TW 005 496-011		SWP-M-C
246-082-008-014C	8TW 004 223-031		SWP-M-C
246-082-008-021G	8TW 004 223-061		SWP-M-C
246-082-008-025G	8TW 006 848-021		SWP-M-C
246-082-008-025G	8TW 006 848-041		SWP-M-C
246-083-001-004C	8TW 005 206-031		SWP-D-C
246-083-002-006G	8TW 005 206-011		SWP-D-C
246-083-002-006G	8TW 005 206-017		SWP-D-C
246-083-002-006G	8TW 005 206-031		SWP-D-C
246-083-002-014G	8TW 005 206-051		SWP-D-C
246-083-002-022G	8TW 006 847-021		SWP-D-C
246-086-001-002C	8TW 006 849-011		HLWP
X10-729-002-004	8TW 006 847-007		SWP-M-C
X10-729-002-005	8TW 006 848-007		SWP-M-C
X10-729-002-006	8TW 006 848-057		SWP-M-C
X10-729-002-007	8TW 006 848-077		SWP-M-C
X10-729-002-008	8TW 006 849-007		SWP-M-C

**HONDA**

246-082-008-025G	76806-SMG-E01		SWP-M-C
------------------	---------------	--	---------

**IVECO**

246-082-003-004C	9 665 345	246-082-008-012C	SWP-M-C
246-082-008-012C	9 665 345		SWP-M-C

**LADA**

246-082-008-014C	2108 5208009 20		SWP-M-C
------------------	-----------------	--	---------



Article No.	OE No.	Article No. (new)	Product Name
<b>LANCIA</b>			
246-083-001-004C	46797755		SWP-D-C
246-083-001-004C	71719636		SWP-D-C

<b>MAN</b>			
246-063-013-001D	81.26484-0002		V
246-075-010-001C	81.26485-6008		SWP-M-G
246-075-024-004	81.26485-6008	246-075-010-001C	SWP-M-G
246-082-003-002	81.26485-6016	246-082-008-012C	SWP-M-C
246-082-008-012C	81.26485-6016		SWP-M-C
246-083-001-006C	81.26485-6027		SWP-D-C
89-602-050	81.26481-0033		G

<b>MAZDA</b>			
X10-729-002-004	1E0076672		SWP-M-C
X10-729-002-004	1E00-76-672		SWP-M-C

<b>MERCEDES-BENZ</b>			
246-061-009-002D	000 869 21 20		R
246-061-009-002D	A000 869 21 20		R
246-063-004-001G	000 869 10 22		V
246-063-004-001G	608 869 00 14		V
246-063-004-001G	A000 869 10 22		V
246-063-004-001G	A608 869 00 14		V
246-068-003-001G	000 860 60 47		N
246-068-003-001G	A000 860 60 47		N
246-069-026-001G	000 869 24 47		N
246-069-026-001G	A000 869 24 47		N
246-069-029-004G	322 869 00 47		N
246-069-029-004G	A322 869 00 47		N
246-075-010-001C	000 869 24 21		SWP-M-G
246-075-010-001C	A000 869 24 21		SWP-M-G
246-075-015-001C	000 869 22 21		SWP-M-G
246-075-015-001C	A000 869 22 21		SWP-M-G
246-075-017-001	108 869 01 21	246-075-017-002C	SWP-M-G
246-075-017-001	A108 869 01 21	246-075-017-002C	SWP-M-G
246-075-017-002C	000 869 30 21		SWP-M-G
246-075-017-002C	108 869 01 21		SWP-M-G
246-075-017-002C	115 869 02 21		SWP-M-G
246-075-017-002C	A000 869 30 21		SWP-M-G
246-075-017-002C	A108 869 01 21		SWP-M-G
246-075-017-002C	A115 869 02 21		SWP-M-G



Article No.	OE No.	Article No. (new)	Product Name
246-075-021-004	000 869 29 21	246-075-021-007C	SWP-M-G
246-075-021-004	A000 869 29 21	246-075-021-007C	SWP-M-G
246-075-021-007C	000 869 29 21		SWP-M-G
246-075-021-007C	000 869 30 21		SWP-M-G
246-075-021-007C	A000 869 29 21		SWP-M-G
246-075-021-007C	A000 869 30 21		SWP-M-G
246-075-024-002C	000 869 31 21		SWP-M-G
246-075-024-002C	A000 869 31 21		SWP-M-G
246-075-050-007C	000 860 15 26		SWP-M-G
246-075-050-007C	A000 860 15 26		SWP-M-G
246-080-003-001	126 860 07 47	246-080-003-006D	N-H
246-080-003-001	A126 860 07 47	246-080-003-006D	N-H
246-080-003-006D	126 860 07 47		N-H
246-080-003-006D	A126 860 07 47		N-H
246-082-003-003	000 860 13 26	246-082-008-014C	SWP-M-C
246-082-003-003	A000 860 13 26	246-082-008-014C	SWP-M-C
246-082-003-009C	000 860 12 26	246-082-008-012C	SWP-M-C
246-082-003-009C	A000 860 12 26	246-082-008-012C	SWP-M-C
246-082-003-016	000 860 20 26	246-082-008-014C	SWP-M-C
246-082-003-016	A000 860 20 26	246-082-008-014C	SWP-M-C
246-082-005-001	124 869 00 21	246-082-005-002C	SWP-M-C
246-082-005-001	124 869 01 21	246-082-005-002C	SWP-M-C
246-082-005-001	124 869 03 21	246-082-005-002C	SWP-M-C
246-082-005-001	124 869 04 21	246-082-005-002C	SWP-M-C
246-082-005-001	124 869 05 21	246-082-005-002C	SWP-M-C
246-082-005-001	124 869 06 21	246-082-005-002C	SWP-M-C
246-082-005-001	A124 869 00 21	246-082-005-002C	SWP-M-C
246-082-005-001	A124 869 01 21	246-082-005-002C	SWP-M-C
246-082-005-001	A124 869 03 21	246-082-005-002C	SWP-M-C
246-082-005-001	A124 869 04 21	246-082-005-002C	SWP-M-C
246-082-005-001	A124 869 05 21	246-082-005-002C	SWP-M-C
246-082-005-001	A124 869 06 21	246-082-005-002C	SWP-M-C
246-082-005-002C	124 869 00 21		SWP-M-C
246-082-005-002C	124 869 01 21		SWP-M-C
246-082-005-002C	124 869 03 21		SWP-M-C
246-082-005-002C	124 869 04 21		SWP-M-C
246-082-005-002C	124 869 05 21		SWP-M-C
246-082-005-002C	124 869 06 21		SWP-M-C
246-082-005-002C	A124 869 00 21		SWP-M-C
246-082-005-002C	A124 869 01 21		SWP-M-C
246-082-005-002C	A124 869 03 21		SWP-M-C
246-082-005-002C	A124 869 04 21		SWP-M-C
246-082-005-002C	A124 869 05 21		SWP-M-C
246-082-005-002C	A124 869 06 21		SWP-M-C
246-082-008-003	140 869 02 21	246-082-008-013P	SWP-M-C
246-082-008-003	A140 869 02 21	246-082-008-013P	SWP-M-C



Article No.	OE No.	Article No. (new)	Product Name
246-082-008-005	000 860 32 26	246-082-008-012C	SWP-M-C
246-082-008-005	A000 860 32 26	246-082-008-012C	SWP-M-C
246-082-008-009	000 860 33 26	246-082-008-014C	SWP-M-C
246-082-008-009	A000 860 33 26	246-082-008-014C	SWP-M-C
246-082-008-011C	202 869 00 21	246-082-008-013P	SWP-M-C
246-082-008-011C	A202 869 00 21	246-082-008-013P	SWP-M-C
246-082-008-012C	000 860 12 26		SWP-M-C
246-082-008-012C	000 860 32 26		SWP-M-C
246-082-008-012C	A000 860 12 26		SWP-M-C
246-082-008-012C	A000 860 32 26		SWP-M-C
246-082-008-013P	140 869 02 21		SWP-M-C
246-082-008-013P	202 869 00 21		SWP-M-C
246-082-008-013P	A140 869 02 21		SWP-M-C
246-082-008-013P	A202 869 00 21		SWP-M-C
246-082-008-014C	000 860 13 26		SWP-M-C
246-082-008-014C	000 860 20 26		SWP-M-C
246-082-008-014C	000 860 33 26		SWP-M-C
246-082-008-014C	A000 860 13 26		SWP-M-C
246-082-008-014C	A000 860 20 26		SWP-M-C
246-082-008-014C	A000 860 33 26		SWP-M-C
246-082-008-015N	210 869 08 21	246-082-008-025G	SWP-M-C
246-082-008-015N	A210 869 08 21	246-082-008-025G	SWP-M-C
246-082-008-025G	210 869 08 21		SWP-M-C
246-082-008-025G	221 869 01 21		SWP-M-C
246-082-008-025G	A210 869 08 21		SWP-M-C
246-082-008-025G	A221 869 01 21		SWP-M-C
246-083-002-022G	204 866 02 21		SWP-D-C
246-083-002-022G	A204 866 02 21		SWP-D-C
88-205-001	000 869 01 58		C
88-205-001	A000 869 01 58		C
88-326-004	107 869 00 24		C
88-326-004	A107 869 00 24		C

**mitsubishi**

246-086-001-002C

MR911031

HLWP

**Opel**

246-082-008-008

90045820

246-082-008-014C

SWP-M-C

246-082-008-008

14 50 156

246-082-008-014C

SWP-M-C

246-082-008-008

14 50 174

246-082-008-014C

SWP-M-C

246-082-008-014C

90045820

SWP-M-C

246-082-008-014C

14 50 156

SWP-M-C

246-082-008-014C

14 50 174

SWP-M-C





Article No.	OE No.	Article No. (new)	Product Name
246-082-008-018	90585761	246-082-008-021G	SWP-M-C
246-082-008-018	14 50 184	246-082-008-021G	SWP-M-C
246-082-008-021G	90585761		SWP-M-C
246-082-008-021G	14 50 184		SWP-M-C
246-083-001-001	90226604	246-083-001-004C	SWP-D-C
246-083-001-001	14 50 175	246-083-001-004C	SWP-D-C
246-083-001-004C	90226604		SWP-D-C
246-083-001-004C	14 50 175		SWP-D-C
246-083-002-008	90585762	246-083-002-014G	SWP-D-C
246-083-002-008	14 50 185	246-083-002-014G	SWP-D-C
246-083-002-012G	90585762	246-083-002-014G	SWP-D-C
246-083-002-012G	14 50 185	246-083-002-014G	SWP-D-C
246-083-002-014G	90585762		SWP-D-C
246-083-002-014G	14 50 185		SWP-D-C
A2C53240114	13250356		SWP-M-C
A2C53240114	1 450 058		SWP-M-C

## PEUGEOT

A2C53030219	0000643497		SWP-M-C
A2C53030219	643497		SWP-M-C
A2C53030219	9643447780		SWP-M-C
A2C53030301	0000643492		SWP-D-C
A2C53030301	643492		SWP-D-C
A2C53030301	9643447980		SWP-D-C
X10-729-002-007	0000643458		SWP-M-C
X10-729-002-007	643458		SWP-M-C

## PORSCHE

246-075-015-001C	928 628 074 01		SWP-M-G
246-075-023-020	928 628 074 01	246-075-015-001C	SWP-M-G
246-075-042-001C	823 955 651		SWP-M-G
246-075-042-001C	928 628 172 01		SWP-M-G
246-082-008-014C	431 955 651		SWP-M-C
246-082-008-015N	996 628 172 00	246-082-008-025G	SWP-M-C
246-082-008-025G	431 955 651		SWP-M-C
246-082-008-025G	996 628 172 00		SWP-M-C
246-086-001-002C	996 624 502 00		HLWP
246-086-001-007C	970 624 502 00		HLWP
246-086-001-007C	997 624 502 00		HLWP

## RENAULT

X10-729-002-006	7700802336		SWP-M-C
-----------------	------------	--	---------



Article No.	OE No.	Article No. (new)	Product Name
<b>SAAB</b>			
246-082-001-001C	95 06 379		SWP-M-C
246-082-003-005C	85 93 477	246-082-008-014C	SWP-M-C
246-082-008-014C	85 93 477		SWP-M-C
A2C53240114	13250356		SWP-M-C

**SCANIA**

246-063-013-001D	300786		V
246-069-050-005D	300792		N
246-075-044-003A	1395994		SWP-M-G
246-082-001-001C	367110		SWP-M-C
246-082-001-002C	353546		SWP-M-C
246-082-003-001	295970	246-082-008-012C	SWP-M-C
246-082-008-012C	295970		SWP-M-C

**SEAT**

246-069-056-001Z	191 955 985 A		N
246-080-010-002Z	191 955 986 A		N-H
246-082-003-007	431 955 651	246-082-008-014C	SWP-M-C
246-082-008-001Z	1H5 955 651	246-082-008-021G	SWP-M-C
246-082-008-014C	431 955 651		SWP-M-C
246-082-008-019	1J5 955 651	246-082-008-025G	SWP-M-C
246-082-008-021G	1H5 955 651		SWP-M-C
246-082-008-022	1J5 955 651	246-082-008-025G	SWP-M-C
246-082-008-025G	1J5 955 651		SWP-M-C
246-082-008-025G	1K5 955 651		SWP-M-C
246-083-002-001Z	1H6 955 651	246-083-002-014G	SWP-D-C
246-083-002-007	1H6 955 651	246-083-002-014G	SWP-D-C
246-083-002-010	1J6 955 651	246-083-002-022G	SWP-D-C
246-083-002-014G	1H6 955 651		SWP-D-C
246-083-002-015	1J6 955 651	246-083-002-022G	SWP-D-C
246-083-002-019	1T0 955 651 A	246-083-002-022G	SWP-D-C
246-083-002-022G	1J6 955 651		SWP-D-C
246-083-002-022G	1K6 955 651		SWP-D-C
246-083-002-022G	1T0 955 651 A		SWP-D-C
246-086-001-002C	1J0 955 681		HLWP
246-086-001-006	1J0 955 681	246-086-001-002C	HLWP
246-086-001-007C	3B7 955 681		HLWP
246-086-001-016	3B7 955 681	246-086-001-007C	HLWP
246-086-001-017	3B0 955 681 A	246-086-001-007C	HLWP
X11-246-003-014	1J0 973 722 A		A



Article No.	OE No.	Article No. (new)	Product Name
<b>SIEMENS</b>			
A2C53240114	3240114		SWP-M-C

<b>SKODA</b>			
246-082-008-019	1J5 955 651	246-082-008-025G	SWP-M-C
246-082-008-022	1J5 955 651	246-082-008-025G	SWP-M-C
246-082-008-025G	1J5 955 651		SWP-M-C
246-082-008-025G	1K5 955 651		SWP-M-C
246-082-008-025G	1T0 955 651		SWP-M-C
246-082-008-026	1T0 955 651	246-082-008-025G	SWP-M-C
246-083-002-010	1J6 955 651	246-083-002-022G	SWP-D-C
246-083-002-015	1J6 955 651	246-083-002-022G	SWP-D-C
246-083-002-019	1T0 955 651 A	246-083-002-022G	SWP-D-C
246-083-002-022G	1J6 955 651		SWP-D-C
246-083-002-022G	1K6 955 651		SWP-D-C
246-083-002-022G	1T0 955 651 A		SWP-D-C
246-086-001-002C	1J0 955 681		HLWP
246-086-001-007C	3B0 955 681 A		HLWP
246-086-001-007C	3B7 955 681		HLWP
246-086-001-016	3B7 955 681	246-086-001-007C	HLWP
246-086-001-017	3B0 955 681 A	246-086-001-007C	HLWP
X11-246-003-014	1J0 973 722 A		A

<b>SMART (MCC)</b>			
246-082-008-015N	0001753V001000000	246-082-008-025G	SWP-M-C
246-082-008-025G	0001753V001000000		SWP-M-C
246-082-008-025G	221 869 01 21		SWP-M-C
246-082-008-025G	A221 869 01 21		SWP-M-C
246-083-002-005C	0000038V001000000	246-083-002-022G	SWP-D-C
246-083-002-022G	0000038V001000000		SWP-D-C

<b>SWAG</b>			
A2C53240479Z	20 92 6495		SWP-M-C

<b>VAUXHALL</b>			
246-082-008-014C	14 50 174		SWP-M-C
246-082-008-021G	90585761		SWP-M-C
246-082-008-021G	14 50 184		SWP-M-C
246-083-001-004C	90492357		SWP-D-C
246-083-001-004C	14 50 175		SWP-D-C



Article No.	OE No.	Article No. (new)	Product Name
246-083-002-014G	90585762		SWP-D-C
246-083-002-014G	14 50 185		SWP-D-C

**VDO**

246-069-056-001Z	246-069-056-001A		N
246-069-059-001Z	246-069-059-001A		N
246-075-044-001C	246-082-008-016Z		SWP-M-G
246-080-010-002Z	246-080-010-002D		N-H
246-080-013-001Z	246-080-013-001A		N-H
246-080-013-003Z	246-080-013-003A		N-H
246-082-008-012C	246-082-008-012V		SWP-M-C
246-082-008-025G	3020175		SWP-M-C
246-083-001-004C	246-083-001-001		SWP-D-C
246-083-002-022G	3043125		SWP-D-C
246-083-002-022G	3091387		SWP-D-C
A2C53030219	3030219		SWP-M-C
A2C53030301	3030301		SWP-D-C
A2C53240479Z	3240479		SWP-M-C
A2C53240479Z	A2C53240479		SWP-M-C

**VOLVO**

246-063-004-001G	1342553		V
246-068-013-004D	1307159		N
246-068-050-003D	1307159	246-068-013-004D	N
246-069-050-005D	4831689		N
246-075-015-016C	1254197	246-075-021-006C	SWP-M-G
246-075-021-006C	1254197		SWP-M-G
246-075-023-003	3276564	246-075-023-004C	SWP-M-G
246-075-023-004C	3276564		SWP-M-G
246-075-040-020C	1585878		SWP-M-G
246-075-042-001C	3205207		SWP-M-G
246-075-044-001C	1258016		SWP-M-G
246-075-044-001C	9178094		SWP-M-G
246-075-044-002A	1259832		SWP-M-G
246-075-051-007C	1606929		SWP-M-G
246-082-008-016Z	9178094	246-075-044-001C	SWP-M-G

**VW**

246-069-056-001Z	191 955 985 A		N
246-075-021-001	823 955 651	246-075-021-006C	SWP-M-G
246-075-021-006C	823 955 651		SWP-M-G
246-080-010-002Z	191 955 986 A		N-H



Article No.	OE No.	Article No. (new)	Product Name
246-082-003-002	690 955 651	246-082-008-012C	SWP-M-C
246-082-003-007	431 955 651	246-082-008-014C	SWP-M-C
246-082-008-001Z	1H5 955 651	246-082-008-021G	SWP-M-C
246-082-008-012C	690 955 651		SWP-M-C
246-082-008-014C	431 955 651		SWP-M-C
246-082-008-019	1J5 955 651	246-082-008-025G	SWP-M-C
246-082-008-021G	1H5 955 651		SWP-M-C
246-082-008-022	1J5 955 651	246-082-008-025G	SWP-M-C
246-082-008-025G	1J5 955 651		SWP-M-C
246-082-008-025G	1K5 955 651		SWP-M-C
246-082-008-025G	1T0 955 651		SWP-M-C
246-082-008-026	1T0 955 651	246-082-008-025G	SWP-M-C
246-083-001-002	333 955 651	246-083-002-006G	SWP-D-C
246-083-002-001Z	1H6 955 651	246-083-002-014G	SWP-D-C
246-083-002-002C	333 955 651	246-083-002-006G	SWP-D-C
246-083-002-006G	333 955 651		SWP-D-C
246-083-002-010	1J6 955 651	246-083-002-022G	SWP-D-C
246-083-002-014G	1H6 955 651		SWP-D-C
246-083-002-015	1J6 955 651	246-083-002-022G	SWP-D-C
246-083-002-019	1T0 955 651 A	246-083-002-022G	SWP-D-C
246-083-002-022G	1J6 955 651		SWP-D-C
246-083-002-022G	1K6 955 651		SWP-D-C
246-083-002-022G	1T0 955 651 A		SWP-D-C
246-083-002-022G	5K0 955 651		SWP-D-C
246-086-001-002C	191 955 681		HLWP
246-086-001-002C	3B0 955 681		HLWP
246-086-001-005	3B0 955 681	246-086-001-002C	HLWP
246-086-001-006	191 955 681	246-086-001-002C	HLWP
246-086-001-007C	3B0 955 681 A		HLWP
246-086-001-007C	3B7 955 681		HLWP
246-086-001-016	3B7 955 681	246-086-001-007C	HLWP
246-086-001-017	3B0 955 681 A	246-086-001-007C	HLWP
A2C53304876	8K0 955 681		HLWP
X11-246-003-014	1J0 973 722 A		A



# Cross-Reference

## OE No. > Article No. (all manufacturers)

OE No.	Manufacturer	Article No.	Article No. (new)	Product Name
000038V001000000	SMART	246-083-002-005C	246-083-002-022G	SWP-D-C
000038V001000000	SMART	246-083-002-022G		SWP-D-C
0000643458	CITROEN	X10-729-002-007		SWP-M-C
0000643458	PEUGEOT	X10-729-002-007		SWP-M-C
0000643492	CITROEN	A2C53030301		SWP-D-C
0000643492	PEUGEOT	A2C53030301		SWP-D-C
0000643497	CITROEN	A2C53030219		SWP-M-C
0000643497	PEUGEOT	A2C53030219		SWP-M-C
0001753V001000000	SMART	246-082-008-015N	246-082-008-025G	SWP-M-C
0001753V001000000	SMART	246-082-008-025G		SWP-M-C
000 860 12 26	MERCEDES BENZ	246-082-003-009C	246-082-008-012C	SWP-M-C
000 860 12 26	MERCEDES BENZ	246-082-008-012C		SWP-M-C
000 860 13 26	MERCEDES BENZ	246-082-003-003	246-082-008-014C	SWP-M-C
000 860 13 26	MERCEDES BENZ	246-082-008-014C		SWP-M-C
000 860 15 26	MERCEDES BENZ	246-075-050-007C		SWP-M-G
000 860 20 26	MERCEDES BENZ	246-082-003-016	246-082-008-014C	SWP-M-C
000 860 20 26	MERCEDES BENZ	246-082-008-014C		SWP-M-C
000 860 32 26	MERCEDES BENZ	246-082-008-005	246-082-008-012C	SWP-M-C
000 860 32 26	MERCEDES BENZ	246-082-008-012C		SWP-M-C
000 860 33 26	MERCEDES BENZ	246-082-008-009	246-082-008-014C	SWP-M-C
000 860 33 26	MERCEDES BENZ	246-082-008-014C		SWP-M-C
000 860 60 47	MERCEDES BENZ	246-068-003-001G		N
000 869 01 58	MERCEDES BENZ	88-205-001		C
000 869 10 22	MERCEDES BENZ	246-063-004-001G		V
000 869 21 20	MERCEDES BENZ	246-061-009-002D		R
000 869 22 21	MERCEDES BENZ	246-075-015-001C		SWP-M-G
000 869 24 21	MERCEDES BENZ	246-075-010-001C		SWP-M-G
000 869 24 47	MERCEDES BENZ	246-069-026-001G		N
000 869 29 21	MERCEDES BENZ	246-075-021-004	246-075-021-007C	SWP-M-G
000 869 29 21	MERCEDES BENZ	246-075-021-007C		SWP-M-G
000 869 30 21	MERCEDES BENZ	246-075-017-002C		SWP-M-G
000 869 30 21	MERCEDES BENZ	246-075-021-007C		SWP-M-G
000 869 31 21	MERCEDES BENZ	246-075-024-002C		SWP-M-G
0665345	DAF	246-082-003-004C	246-082-008-012C	SWP-M-C
0665345	DAF	246-082-008-012C		SWP-M-C
107 869 00 24	MERCEDES BENZ	88-326-004		C
108 869 01 21	MERCEDES BENZ	246-075-017-001	246-075-017-002C	SWP-M-G
108 869 01 21	MERCEDES BENZ	246-075-017-002C		SWP-M-G
115 869 02 21	MERCEDES BENZ	246-075-017-002C		SWP-M-G
1 199 567	BMW	246-082-008-025G		SWP-M-C
124 869 00 21	MERCEDES BENZ	246-082-005-001	246-082-005-002C	SWP-M-C
124 869 00 21	MERCEDES BENZ	246-082-005-002C		SWP-M-C
124 869 01 21	MERCEDES BENZ	246-082-005-001	246-082-005-002C	SWP-M-C
124 869 01 21	MERCEDES BENZ	246-082-005-002C		SWP-M-C
124 869 03 21	MERCEDES BENZ	246-082-005-001	246-082-005-002C	SWP-M-C
124 869 03 21	MERCEDES BENZ	246-082-005-002C		SWP-M-C



OE No.	Manufacturer	Article No.	Article No. (new)	Product Name
124 869 04 21	MERCEDES BENZ	246-082-005-001	246-082-005-002C	SWP-M-C
124 869 04 21	MERCEDES BENZ	246-082-005-002C		SWP-M-C
124 869 05 21	MERCEDES BENZ	246-082-005-001	246-082-005-002C	SWP-M-C
124 869 05 21	MERCEDES BENZ	246-082-005-002C		SWP-M-C
124 869 06 21	MERCEDES BENZ	246-082-005-001	246-082-005-002C	SWP-M-C
124 869 06 21	MERCEDES BENZ	246-082-005-002C		SWP-M-C
1254197	VOLVO	246-075-015-016C	246-075-021-006C	SWP-M-G
1254197	VOLVO	246-075-021-006C		SWP-M-G
1258016	VOLVO	246-075-044-001C		SWP-M-G
1259832	VOLVO	246-075-044-002A		SWP-M-G
126 860 07 47	MERCEDES BENZ	246-080-003-001	246-080-003-006D	N-H
126 860 07 47	MERCEDES BENZ	246-080-003-006D		N-H
1307159	VOLVO	246-068-013-004D		N
1307159	VOLVO	246-068-050-003D	246-068-013-004D	N
13250356	CHEVROLET	A2C53240114		SWP-M-C
13250356	OPEL	A2C53240114		SWP-M-C
13250356	SAAB	A2C53240114		SWP-M-C
1342553	VOLVO	246-063-004-001G		V
1 355 299	BMW	246-063-013-001D		V
1 359 115	BMW	246-075-023-003	246-075-023-004C	SWP-M-G
1 359 115	BMW	246-075-023-004C		SWP-M-G
1 359 116	BMW	246-075-023-003	246-075-023-004C	SWP-M-G
1 359 116	BMW	246-075-023-004C		SWP-M-G
1 368 549	BMW	246-075-042-001C		SWP-M-G
1 368 549	BMW	246-082-003-013	246-075-042-001C	SWP-M-G
1 369 263	BMW	395-060-017-001C		FLS
1 370 033	BMW	246-075-042-001C		SWP-M-G
1 370 033	BMW	246-082-003-013	246-075-042-001C	SWP-M-G
1 370 465	BMW	246-075-042-001C		SWP-M-G
1 370 465	BMW	246-082-003-013	246-075-042-001C	SWP-M-G
1 378 799	BMW	246-080-013-001Z		N-H
1 379 735	BMW	246-069-059-001Z		N
1395994	SCANIA	246-075-044-003A		SWP-M-G
140 869 02 21	MERCEDES BENZ	246-082-008-003	246-082-008-013P	SWP-M-C
140 869 02 21	MERCEDES BENZ	246-082-008-013P		SWP-M-C
1 450 058	OPEL	A2C53240114		SWP-M-C
14 50 156	OPEL	246-082-008-008	246-082-008-014C	SWP-M-C
14 50 156	OPEL	246-082-008-014C		SWP-M-C
14 50 174	OPEL	246-082-008-008	246-082-008-014C	SWP-M-C
14 50 174	OPEL	246-082-008-014C		SWP-M-C
14 50 174	VAUXHALL	246-082-008-014C		SWP-M-C
14 50 175	OPEL	246-083-001-001	246-083-001-004C	SWP-D-C
14 50 175	OPEL	246-083-001-004C		SWP-D-C
14 50 175	VAUXHALL	246-083-001-004C		SWP-D-C
14 50 184	OPEL	246-082-008-018	246-082-008-021G	SWP-M-C
14 50 184	OPEL	246-082-008-021G		SWP-M-C



OE No.	Manufacturer	Article No.	Article No. (new)	Product Name
14 50 184	VAUXHALL	246-082-008-021G		SWP-M-C
14 50 185	OPEL	246-083-002-008	246-083-002-014G	SWP-D-C
14 50 185	OPEL	246-083-002-012G	246-083-002-014G	SWP-D-C
14 50 185	OPEL	246-083-002-014G		SWP-D-C
14 50 185	VAUXHALL	246-083-002-014G		SWP-D-C
1585878	VOLVO	246-075-040-020C		SWP-M-G
1606929	VOLVO	246-075-051-007C		SWP-M-G
1652613	FORD	X10-729-002-004		SWP-M-C
191 955 681	VW	246-086-001-002C		HLWP
191 955 681	VW	246-086-001-006	246-086-001-002C	HLWP
191 955 985 A	SEAT	246-069-056-001Z		N
191 955 985 A	VW	246-069-056-001Z		N
191 955 986 A	SEAT	246-080-010-002Z		N-H
191 955 986 A	VW	246-080-010-002Z		N-H
1E0076672	MAZDA	X10-729-002-004		SWP-M-C
1E00-76-672	MAZDA	X10-729-002-004		SWP-M-C
1H5 955 651	SEAT	246-082-008-001Z	246-082-008-021G	SWP-M-C
1H5 955 651	SEAT	246-082-008-021G		SWP-M-C
1H5 955 651	VW	246-082-008-001Z	246-082-008-021G	SWP-M-C
1H5 955 651	VW	246-082-008-021G		SWP-M-C
1H6 955 651	SEAT	246-083-002-001Z	246-083-002-014G	SWP-D-C
1H6 955 651	SEAT	246-083-002-007	246-083-002-014G	SWP-D-C
1H6 955 651	SEAT	246-083-002-014G		SWP-D-C
1H6 955 651	VW	246-083-002-001Z	246-083-002-014G	SWP-D-C
1H6 955 651	VW	246-083-002-014G		SWP-D-C
1J0 955 681	AUDI	246-086-001-002C		HLWP
1J0 955 681	AUDI	246-086-001-006	246-086-001-002C	HLWP
1J0 955 681	SEAT	246-086-001-002C		HLWP
1J0 955 681	SEAT	246-086-001-006	246-086-001-002C	HLWP
1J0 955 681	SKODA	246-086-001-002C		HLWP
1J0 973 722 A	AUDI	X11-246-003-014		A
1J0 973 722 A	SEAT	X11-246-003-014		A
1J0 973 722 A	SKODA	X11-246-003-014		A
1J0 973 722 A	VW	X11-246-003-014		A
1J5 955 651	AUDI	246-082-008-019	246-082-008-025G	SWP-M-C
1J5 955 651	AUDI	246-082-008-022	246-082-008-025G	SWP-M-C
1J5 955 651	AUDI	246-082-008-025G		SWP-M-C
1J5 955 651	SEAT	246-082-008-019	246-082-008-025G	SWP-M-C
1J5 955 651	SEAT	246-082-008-022	246-082-008-025G	SWP-M-C
1J5 955 651	SEAT	246-082-008-025G		SWP-M-C
1J5 955 651	SKODA	246-082-008-019	246-082-008-025G	SWP-M-C
1J5 955 651	SKODA	246-082-008-022	246-082-008-025G	SWP-M-C
1J5 955 651	SKODA	246-082-008-025G		SWP-M-C
1J5 955 651	VW	246-082-008-019	246-082-008-025G	SWP-M-C
1J5 955 651	VW	246-082-008-022	246-082-008-025G	SWP-M-C
1J5 955 651	VW	246-082-008-025G		SWP-M-C





OE No.	Manufacturer	Article No.	Article No. (new)	Product Name
1J6 955 651	AUDI	246-083-002-010	246-083-002-022G	SWP-D-C
1J6 955 651	AUDI	246-083-002-015	246-083-002-022G	SWP-D-C
1J6 955 651	AUDI	246-083-002-022G		SWP-D-C
1J6 955 651	SEAT	246-083-002-010	246-083-002-022G	SWP-D-C
1J6 955 651	SEAT	246-083-002-015	246-083-002-022G	SWP-D-C
1J6 955 651	SEAT	246-083-002-022G		SWP-D-C
1J6 955 651	SKODA	246-083-002-010	246-083-002-022G	SWP-D-C
1J6 955 651	SKODA	246-083-002-015	246-083-002-022G	SWP-D-C
1J6 955 651	SKODA	246-083-002-022G		SWP-D-C
1J6 955 651	VW	246-083-002-010	246-083-002-022G	SWP-D-C
1J6 955 651	VW	246-083-002-015	246-083-002-022G	SWP-D-C
1J6 955 651	VW	246-083-002-022G		SWP-D-C
1K5 955 651	AUDI	246-082-008-025G		SWP-M-C
1K5 955 651	SEAT	246-082-008-025G		SWP-M-C
1K5 955 651	SKODA	246-082-008-025G		SWP-M-C
1K5 955 651	VW	246-082-008-025G		SWP-M-C
1K6 955 651	AUDI	246-083-002-022G		SWP-D-C
1K6 955 651	SEAT	246-083-002-022G		SWP-D-C
1K6 955 651	SKODA	246-083-002-022G		SWP-D-C
1K6 955 651	VW	246-083-002-022G		SWP-D-C
1T0 955 651	SKODA	246-082-008-025G		SWP-M-C
1T0 955 651	SKODA	246-082-008-026	246-082-008-025G	SWP-M-C
1T0 955 651	VW	246-082-008-025G		SWP-M-C
1T0 955 651	VW	246-082-008-026	246-082-008-025G	SWP-M-C
1T0 955 651 A	AUDI	246-083-002-019	246-083-002-022G	SWP-D-C
1T0 955 651 A	AUDI	246-083-002-022G		SWP-D-C
1T0 955 651 A	SEAT	246-083-002-019	246-083-002-022G	SWP-D-C
1T0 955 651 A	SEAT	246-083-002-022G		SWP-D-C
1T0 955 651 A	SKODA	246-083-002-019	246-083-002-022G	SWP-D-C
1T0 955 651 A	SKODA	246-083-002-022G		SWP-D-C
1T0 955 651 A	VW	246-083-002-019	246-083-002-022G	SWP-D-C
1T0 955 651 A	VW	246-083-002-022G		SWP-D-C
20 92 6495	SWAG	A2C53240479Z		SWP-M-C
202 869 00 21	MERCEDES BENZ	246-082-008-011C	246-082-008-013P	SWP-M-C
202 869 00 21	MERCEDES BENZ	246-082-008-013P		SWP-M-C
204 866 02 21	MERCEDES BENZ	246-083-002-022G		SWP-D-C
210 869 08 21	MERCEDES BENZ	246-082-008-015N	246-082-008-025G	SWP-M-C
210 869 08 21	MERCEDES BENZ	246-082-008-025G		SWP-M-C
2108 5208009 20	LADA	246-082-008-014C		SWP-M-C
221 869 01 21	MERCEDES BENZ	246-082-008-025G		SWP-M-C
221 869 01 21	SMART	246-082-008-025G		SWP-M-C
246-069-056-001A	VDO	246-069-056-001Z		N
246-069-059-001A	VDO	246-069-059-001Z		N
246-080-010-002D	VDO	246-080-010-002Z		N-H
246-080-013-001A	VDO	246-080-013-001Z		N-H
246-080-013-003A	VDO	246-080-013-003Z		N-H



OE No.	Manufacturer	Article No.	Article No. (new)	Product Name
246-082-008-012V	VDO	246-082-008-012C		SWP-M-C
246-082-008-016Z	VDO	246-075-044-001C		SWP-M-G
246-083-001-001	VDO	246-083-001-004C		SWP-D-C
295970	SCANIA	246-082-003-001	246-082-008-012C	SWP-M-C
295970	SCANIA	246-082-008-012C		SWP-M-C
300786	SCANIA	246-063-013-001D		V
300792	SCANIA	246-069-050-005D		N
3020175	VDO	246-082-008-025G		SWP-M-C
3030219	VDO	A2C53030219		SWP-M-C
3030301	VDO	A2C53030301		SWP-D-C
3043125	VDO	246-083-002-022G		SWP-D-C
3091387	VDO	246-083-002-022G		SWP-D-C
3205207	VOLVO	246-075-042-001C		SWP-M-G
322 869 00 47	MERCEDES BENZ	246-069-029-004G		N
3240114	SIEMENS	A2C53240114		SWP-M-C
3240479	VDO	A2C53240479Z		SWP-M-C
3276564	VOLVO	246-075-023-003	246-075-023-004C	SWP-M-G
3276564	VOLVO	246-075-023-004C		SWP-M-G
3304876	CONTINENTAL	A2C53304876		HLWP
333 955 651	VW	246-083-001-002	246-083-002-006G	SWP-D-C
333 955 651	VW	246-083-002-002C	246-083-002-006G	SWP-D-C
333 955 651	VW	246-083-002-006G		SWP-D-C
353546	SCANIA	246-082-001-002C		SWP-M-C
367110	SCANIA	246-082-001-001C		SWP-M-C
3B0 955 681	VW	246-086-001-002C		HLWP
3B0 955 681	VW	246-086-001-005	246-086-001-002C	HLWP
3B0 955 681 A	AUDI	246-086-001-017	246-086-001-007C	HLWP
3B0 955 681 A	SEAT	246-086-001-017	246-086-001-007C	HLWP
3B0 955 681 A	SKODA	246-086-001-007C		HLWP
3B0 955 681 A	SKODA	246-086-001-017	246-086-001-007C	HLWP
3B0 955 681 A	VW	246-086-001-007C		HLWP
3B0 955 681 A	VW	246-086-001-017	246-086-001-007C	HLWP
3B7 955 681	AUDI	246-086-001-007C		HLWP
3B7 955 681	AUDI	246-086-001-016	246-086-001-007C	HLWP
3B7 955 681	SEAT	246-086-001-007C		HLWP
3B7 955 681	SEAT	246-086-001-016	246-086-001-007C	HLWP
3B7 955 681	SKODA	246-086-001-007C		HLWP
3B7 955 681	SKODA	246-086-001-016	246-086-001-007C	HLWP
3B7 955 681	VW	246-086-001-007C		HLWP
3B7 955 681	VW	246-086-001-016	246-086-001-007C	HLWP
431 955 651	AUDI	246-082-003-007	246-082-008-014C	SWP-M-C
431 955 651	AUDI	246-082-008-014C		SWP-M-C
431 955 651	PORSCHE	246-082-008-014C		SWP-M-C
431 955 651	PORSCHE	246-082-008-025G		SWP-M-C
431 955 651	SEAT	246-082-003-007	246-082-008-014C	SWP-M-C
431 955 651	SEAT	246-082-008-014C		SWP-M-C



OE No.	Manufacturer	Article No.	Article No. (new)	Product Name
431 955 651	VW	246-082-003-007	246-082-008-014C	SWP-M-C
431 955 651	VW	246-082-008-014C		SWP-M-C
46797755	ALFA	246-083-001-004C		SWP-D-C
46797755	FIAT	246-083-001-004C		SWP-D-C
46797755	LANCIA	246-083-001-004C		SWP-D-C
4831689	VOLVO	246-069-050-005D		N
5K0 955 651	VW	246-083-002-022G		SWP-D-C
608 869 00 14	MERCEDES BENZ	246-063-004-001G		V
61 31 1 369 263	BMW	395-060-017-001C		FLS
6140949	FORD	X10-729-002-008		SWP-M-C
6153469	FORD	246-082-003-011	246-082-008-014C	SWP-M-C
6153469	FORD	246-082-008-014C		SWP-M-C
61 66 1 355 299	BMW	246-063-013-001D		V
61 66 1 368 549	BMW	246-075-042-001C		SWP-M-G
61 66 1 368 549	BMW	246-082-003-013	246-075-042-001C	SWP-M-G
61 66 1 370 033	BMW	246-075-042-001C		SWP-M-G
61 66 1 370 033	BMW	246-082-003-013	246-075-042-001C	SWP-M-G
61 66 1 370 465	BMW	246-075-042-001C		SWP-M-G
61 66 1 370 465	BMW	246-082-003-013	246-075-042-001C	SWP-M-G
61 66 1 378 799	BMW	246-080-013-001Z		N-H
61 66 1 379 735	BMW	246-069-059-001Z		N
61 66 8 350 355	BMW	246-080-013-003Z		N-H
61 67 1 359 115	BMW	246-075-023-003	246-075-023-004C	SWP-M-G
61 67 1 359 115	BMW	246-075-023-004C		SWP-M-G
61 67 1 359 116	BMW	246-075-023-003	246-075-023-004C	SWP-M-G
61 67 1 359 116	BMW	246-075-023-004C		SWP-M-G
643458	CITROEN	X10-729-002-007		SWP-M-C
643458	PEUGEOT	X10-729-002-007		SWP-M-C
643492	CITROEN	A2C53030301		SWP-D-C
643492	PEUGEOT	A2C53030301		SWP-D-C
643497	CITROEN	A2C53030219		SWP-M-C
643497	PEUGEOT	A2C53030219		SWP-M-C
67 12 1 199 567	BMW	246-082-008-025G		SWP-M-C
67 12 6 934 159	BMW	A2C53240479Z		SWP-M-C
67 12 6 934 160	BMW	A2C53240479Z		SWP-M-C
67 12 7 302 588	BMW	246-082-008-025G		SWP-M-C
67 12 7 302 589	BMW	A2C53240479Z		SWP-M-C
67 12 8 362 154	BMW	246-082-008-017	246-082-008-025G	SWP-M-C
67 12 8 362 154	BMW	246-082-008-025G		SWP-M-C
67 12 8 377 430	BMW	246-086-001-004	246-086-001-007C	HLWP
67 12 8 377 430	BMW	246-086-001-007C		HLWP
67 12 8 377 612	BMW	246-082-008-015N	246-082-008-025G	SWP-M-C
67 12 8 377 612	BMW	246-082-008-025G		SWP-M-C
67 12 8 377 613	BMW	246-086-001-004	246-086-001-007C	HLWP
67 12 8 377 613	BMW	246-086-001-007C		HLWP
67 12 8 377 987	BMW	246-083-002-009	246-083-002-022G	SWP-D-C



OE No.	Manufacturer	Article No.	Article No. (new)	Product Name
67 12 8 377 987	BMW	246-083-002-022G		SWP-D-C
67 63 7 217 792	BMW	A2C53304876		HLWP
6833495	FORD	X10-729-002-005		SWP-M-C
690 955 651	VW	246-082-003-002	246-082-008-012C	SWP-M-C
690 955 651	VW	246-082-008-012C		SWP-M-C
6 934 159	BMW	A2C53240479Z		SWP-M-C
6 934 160	BMW	A2C53240479Z		SWP-M-C
7003177	FORD	X10-729-002-005		SWP-M-C
7003178	FORD	X10-729-002-004		SWP-M-C
71719636	ALFA	246-083-001-004C		SWP-D-C
71719636	FIAT	246-083-001-004C		SWP-D-C
71719636	LANCIA	246-083-001-004C		SWP-D-C
7 217 792	BMW	A2C53304876		HLWP
7222079	FORD	246-083-002-014G		SWP-D-C
7 302 588	BMW	246-082-008-025G		SWP-M-C
7 302 589	BMW	A2C53240479Z		SWP-M-C
73PG17K624AA	FORD	246-075-021-003	246-075-023-004C	SWP-M-G
73PG17K624AA	FORD	246-075-023-003	246-075-023-004C	SWP-M-G
73PG17K624AA	FORD	246-075-023-004C		SWP-M-G
76806-SMG-E01	HONDA	246-082-008-025G		SWP-M-C
7700802336	RENAULT	X10-729-002-006		SWP-M-C
81.26481-0033	MAN	89-602-050		G
81.26484-0002	MAN	246-063-013-001D		V
81.26485-6008	MAN	246-075-010-001C		SWP-M-G
81.26485-6008	MAN	246-075-024-004	246-075-010-001C	SWP-M-G
81.26485-6016	MAN	246-082-003-002	246-082-008-012C	SWP-M-C
81.26485-6016	MAN	246-082-008-012C		SWP-M-C
81.26485-6027	MAN	246-083-001-006C		SWP-D-C
823 955 651	AUDI	246-075-021-001	246-075-021-006C	SWP-M-G
823 955 651	AUDI	246-075-021-006C		SWP-M-G
823 955 651	PORSCHE	246-075-042-001C		SWP-M-G
823 955 651	VW	246-075-021-001	246-075-021-006C	SWP-M-G
823 955 651	VW	246-075-021-006C		SWP-M-G
8 350 355	BMW	246-080-013-003Z		N-H
8 362 154	BMW	246-082-008-017	246-082-008-025G	SWP-M-C
8 362 154	BMW	246-082-008-025G		SWP-M-C
8 377 430	BMW	246-086-001-004	246-086-001-007C	HLWP
8 377 430	BMW	246-086-001-007C		HLWP
8 377 612	BMW	246-082-008-015N	246-082-008-025G	SWP-M-C
8 377 612	BMW	246-082-008-025G		SWP-M-C
8 377 613	BMW	246-086-001-004	246-086-001-007C	HLWP
8 377 613	BMW	246-086-001-007C		HLWP
8 377 987	BMW	246-083-002-009	246-083-002-022G	SWP-D-C
8 377 987	BMW	246-083-002-022G		SWP-D-C
83BB17K624BA	FORD	X10-729-002-008		SWP-M-C
85 93 477	SAAB	246-082-003-005C	246-082-008-014C	SWP-M-C



OE No.	Manufacturer	Article No.	Article No. (new)	Product Name
85 93 477	SAAB	246-082-008-014C		SWP-M-C
86VB17K624AA	FORD	246-075-042-001C		SWP-M-G
86VB17K624AA	FORD	246-082-003-011	246-082-008-014C	SWP-M-C
86VB17K624AA	FORD	246-082-008-014C		SWP-M-C
87AB17K624AC	FORD	X10-729-002-004		SWP-M-C
8K0 955 681	VW	A2C53304876		HLWP
8TW 004 223-031	HELLA	246-075-044-002A		SWP-M-G
8TW 004 223-031	HELLA	246-082-001-001C		SWP-M-C
8TW 004 223-031	HELLA	246-082-008-014C		SWP-M-C
8TW 004 223-061	HELLA	246-082-008-021G		SWP-M-C
8TW 005 206-011	HELLA	246-083-002-006G		SWP-D-C
8TW 005 206-017	HELLA	246-083-002-006G		SWP-D-C
8TW 005 206-031	HELLA	246-083-001-004C		SWP-D-C
8TW 005 206-031	HELLA	246-083-002-006G		SWP-D-C
8TW 005 206-051	HELLA	246-083-002-014G		SWP-D-C
8TW 005 496-011	HELLA	246-082-005-002C		SWP-M-C
8TW 006 847-007	HELLA	X10-729-002-004		SWP-M-C
8TW 006 847-021	HELLA	246-083-002-022G		SWP-D-C
8TW 006 848-007	HELLA	X10-729-002-005		SWP-M-C
8TW 006 848-021	HELLA	246-082-008-025G		SWP-M-C
8TW 006 848-041	HELLA	246-082-008-025G		SWP-M-C
8TW 006 848-057	HELLA	X10-729-002-006		SWP-M-C
8TW 006 848-077	HELLA	X10-729-002-007		SWP-M-C
8TW 006 848-101	HELLA	246-075-044-001C		SWP-M-G
8TW 006 849-007	HELLA	X10-729-002-008		SWP-M-C
8TW 006 849-011	HELLA	246-086-001-002C		HLWP
90045820	OPEL	246-082-008-008	246-082-008-014C	SWP-M-C
90045820	OPEL	246-082-008-014C		SWP-M-C
90226604	OPEL	246-083-001-001	246-083-001-004C	SWP-D-C
90226604	OPEL	246-083-001-004C		SWP-D-C
90492357	VAUXHALL	246-083-001-004C		SWP-D-C
90585761	OPEL	246-082-008-018	246-082-008-021G	SWP-M-C
90585761	OPEL	246-082-008-021G		SWP-M-C
90585761	VAUXHALL	246-082-008-021G		SWP-M-C
90585762	OPEL	246-083-002-008	246-083-002-014G	SWP-D-C
90585762	OPEL	246-083-002-012G	246-083-002-014G	SWP-D-C
90585762	OPEL	246-083-002-014G		SWP-D-C
90585762	VAUXHALL	246-083-002-014G		SWP-D-C
9178094	VOLVO	246-075-044-001C		SWP-M-G
9178094	VOLVO	246-082-008-016Z	246-075-044-001C	SWP-M-G
928 628 074 01	PORSCHE	246-075-015-001C		SWP-M-G
928 628 074 01	PORSCHE	246-075-023-020	246-075-015-001C	SWP-M-G
928 628 172 01	PORSCHE	246-075-042-001C		SWP-M-G
92AB17K624AA	FORD	X10-729-002-005		SWP-M-C
93BB17K624AA	FORD	X10-729-002-005		SWP-M-C
93BB17K624BA	FORD	X10-729-002-004		SWP-M-C



OE No.	Manufacturer	Article No.	Article No. (new)	Product Name
95 06 379	SAAB	246-082-001-001C		SWP-M-C
95VW17K624AA	FORD	246-083-002-014G		SWP-D-C
9641553980	FIAT	A2C53030301		SWP-D-C
9643447780	CITROEN	A2C53030219		SWP-M-C
9643447780	PEUGEOT	A2C53030219		SWP-M-C
9643447980	CITROEN	A2C53030301		SWP-D-C
9643447980	PEUGEOT	A2C53030301		SWP-D-C
9 665 345	IVECO	246-082-003-004C	246-082-008-012C	SWP-M-C
9 665 345	IVECO	246-082-008-012C		SWP-M-C
970 624 502 00	PORSCHE	246-086-001-007C		HLWP
996 624 502 00	PORSCHE	246-086-001-002C		HLWP
996 628 172 00	PORSCHE	246-082-008-015N	246-082-008-025G	SWP-M-C
996 628 172 00	PORSCHE	246-082-008-025G		SWP-M-C
997 624 502 00	PORSCHE	246-086-001-007C		HLWP
A000 860 12 26	MERCEDES BENZ	246-082-003-009C	246-082-008-012C	SWP-M-C
A000 860 12 26	MERCEDES BENZ	246-082-008-012C		SWP-M-C
A000 860 13 26	MERCEDES BENZ	246-082-003-003	246-082-008-014C	SWP-M-C
A000 860 13 26	MERCEDES BENZ	246-082-008-014C		SWP-M-C
A000 860 15 26	MERCEDES BENZ	246-075-050-007C		SWP-M-G
A000 860 20 26	MERCEDES BENZ	246-082-003-016	246-082-008-014C	SWP-M-C
A000 860 20 26	MERCEDES BENZ	246-082-008-014C		SWP-M-C
A000 860 32 26	MERCEDES BENZ	246-082-008-005	246-082-008-012C	SWP-M-C
A000 860 32 26	MERCEDES BENZ	246-082-008-012C		SWP-M-C
A000 860 33 26	MERCEDES BENZ	246-082-008-009	246-082-008-014C	SWP-M-C
A000 860 33 26	MERCEDES BENZ	246-082-008-014C		SWP-M-C
A000 860 60 47	MERCEDES BENZ	246-068-003-001G		N
A000 869 01 58	MERCEDES BENZ	88-205-001		C
A000 869 10 22	MERCEDES BENZ	246-063-004-001G		V
A000 869 21 20	MERCEDES BENZ	246-061-009-002D		R
A000 869 22 21	MERCEDES BENZ	246-075-015-001C		SWP-M-G
A000 869 24 21	MERCEDES BENZ	246-075-010-001C		SWP-M-G
A000 869 24 47	MERCEDES BENZ	246-069-026-001G		N
A000 869 29 21	MERCEDES BENZ	246-075-021-004	246-075-021-007C	SWP-M-G
A000 869 29 21	MERCEDES BENZ	246-075-021-007C		SWP-M-G
A000 869 30 21	MERCEDES BENZ	246-075-017-002C		SWP-M-G
A000 869 30 21	MERCEDES BENZ	246-075-021-007C		SWP-M-G
A000 869 31 21	MERCEDES BENZ	246-075-024-002C		SWP-M-G
A107 869 00 24	MERCEDES BENZ	88-326-004		C
A108 869 01 21	MERCEDES BENZ	246-075-017-001	246-075-017-002C	SWP-M-G
A108 869 01 21	MERCEDES BENZ	246-075-017-002C		SWP-M-G
A115 869 02 21	MERCEDES BENZ	246-075-017-002C		SWP-M-G
A124 869 00 21	MERCEDES BENZ	246-082-005-001	246-082-005-002C	SWP-M-C
A124 869 00 21	MERCEDES BENZ	246-082-005-002C		SWP-M-C
A124 869 01 21	MERCEDES BENZ	246-082-005-001	246-082-005-002C	SWP-M-C
A124 869 01 21	MERCEDES BENZ	246-082-005-002C		SWP-M-C
A124 869 03 21	MERCEDES BENZ	246-082-005-001	246-082-005-002C	SWP-M-C



OE No.	Manufacturer	Article No.	Article No. (new)	Product Name
A124 869 03 21	MERCEDES BENZ	246-082-005-002C		SWP-M-C
A124 869 04 21	MERCEDES BENZ	246-082-005-001	246-082-005-002C	SWP-M-C
A124 869 04 21	MERCEDES BENZ	246-082-005-002C		SWP-M-C
A124 869 05 21	MERCEDES BENZ	246-082-005-001	246-082-005-002C	SWP-M-C
A124 869 05 21	MERCEDES BENZ	246-082-005-002C		SWP-M-C
A124 869 06 21	MERCEDES BENZ	246-082-005-001	246-082-005-002C	SWP-M-C
A124 869 06 21	MERCEDES BENZ	246-082-005-002C		SWP-M-C
A126 860 07 47	MERCEDES BENZ	246-080-003-001	246-080-003-006D	N-H
A126 860 07 47	MERCEDES BENZ	246-080-003-006D		N-H
A140 869 02 21	MERCEDES BENZ	246-082-008-003	246-082-008-013P	SWP-M-C
A140 869 02 21	MERCEDES BENZ	246-082-008-013P		SWP-M-C
A202 869 00 21	MERCEDES BENZ	246-082-008-011C	246-082-008-013P	SWP-M-C
A202 869 00 21	MERCEDES BENZ	246-082-008-013P		SWP-M-C
A204 866 02 21	MERCEDES BENZ	246-083-002-022G		SWP-D-C
A210 869 08 21	MERCEDES BENZ	246-082-008-015N	246-082-008-025G	SWP-M-C
A210 869 08 21	MERCEDES BENZ	246-082-008-025G		SWP-M-C
A221 869 01 21	MERCEDES BENZ	246-082-008-025G		SWP-M-C
A221 869 01 21	SMART	246-082-008-025G		SWP-M-C
A2C53240479	VDO	A2C53240479Z		SWP-M-C
A322 869 00 47	MERCEDES BENZ	246-069-029-004G		N
A608 869 00 14	MERCEDES BENZ	246-063-004-001G		V
MR911031	MITSUBISHI	246-086-001-002C		HLWP



# Cross-Reference OE No. > Article No. (sorted by manufacturers)

OE No.	Article No.	Article No. (new)	Product Name
<b>ALFA ROMEO</b>			
46797755	246-083-001-004C		SWP-D-C
71719636	246-083-001-004C		SWP-D-C

## AUDI

1J0 955 681	246-086-001-002C		HLWP
1J0 955 681	246-086-001-006	246-086-001-002C	HLWP
1J0 973 722 A	X11-246-003-014		A
1J5 955 651	246-082-008-019	246-082-008-025G	SWP-M-C
1J5 955 651	246-082-008-022	246-082-008-025G	SWP-M-C
1J5 955 651	246-082-008-025G		SWP-M-C
1J6 955 651	246-083-002-010	246-083-002-022G	SWP-D-C
1J6 955 651	246-083-002-015	246-083-002-022G	SWP-D-C
1J6 955 651	246-083-002-022G		SWP-D-C
1K5 955 651	246-082-008-025G		SWP-M-C
1K6 955 651	246-083-002-022G		SWP-D-C
1T0 955 651 A	246-083-002-019	246-083-002-022G	SWP-D-C
1T0 955 651 A	246-083-002-022G		SWP-D-C
3B0 955 681 A	246-086-001-017	246-086-001-007C	HLWP
3B7 955 681	246-086-001-007C		HLWP
3B7 955 681	246-086-001-016	246-086-001-007C	HLWP
431 955 651	246-082-003-007	246-082-008-014C	SWP-M-C
431 955 651	246-082-008-014C		SWP-M-C
823 955 651	246-075-021-001	246-075-021-006C	SWP-M-G
823 955 651	246-075-021-006C		SWP-M-G

## BMW

1 199 567	246-082-008-025G		SWP-M-C
1 355 299	246-063-013-001D		V
1 359 115	246-075-023-003	246-075-023-004C	SWP-M-G
1 359 115	246-075-023-004C		SWP-M-G
1 359 116	246-075-023-003	246-075-023-004C	SWP-M-G
1 359 116	246-075-023-004C		SWP-M-G
1 368 549	246-075-042-001C		SWP-M-G
1 368 549	246-082-003-013	246-075-042-001C	SWP-M-G
1 369 263	395-060-017-001C		FLS
1 370 033	246-075-042-001C		SWP-M-G
1 370 033	246-082-003-013	246-075-042-001C	SWP-M-G
1 370 465	246-075-042-001C		SWP-M-G
1 370 465	246-082-003-013	246-075-042-001C	SWP-M-G
1 378 799	246-080-013-001Z		N-H
1 379 735	246-069-059-001Z		N
6 934 159	A2C53240479Z		SWP-M-C





OE No.	Article No.	Article No. (new)	Product Name
6 934 160	A2C53240479Z		SWP-M-C
61 31 1 369 263	395-060-017-001C		FLS
61 66 1 355 299	246-063-013-001D		V
61 66 1 368 549	246-075-042-001C		SWP-M-G
61 66 1 368 549	246-082-003-013	246-075-042-001C	SWP-M-G
61 66 1 370 033	246-075-042-001C		SWP-M-G
61 66 1 370 033	246-082-003-013	246-075-042-001C	SWP-M-G
61 66 1 370 465	246-075-042-001C		SWP-M-G
61 66 1 370 465	246-082-003-013	246-075-042-001C	SWP-M-G
61 66 1 378 799	246-080-013-001Z		N-H
61 66 1 379 735	246-069-059-001Z		N
61 66 8 350 355	246-080-013-003Z		N-H
61 67 1 359 115	246-075-023-003	246-075-023-004C	SWP-M-G
61 67 1 359 115	246-075-023-004C		SWP-M-G
61 67 1 359 116	246-075-023-003	246-075-023-004C	SWP-M-G
61 67 1 359 116	246-075-023-004C		SWP-M-G
67 12 1 199 567	246-082-008-025G		SWP-M-C
67 12 6 934 159	A2C53240479Z		SWP-M-C
67 12 6 934 160	A2C53240479Z		SWP-M-C
67 12 7 302 588	246-082-008-025G		SWP-M-C
67 12 7 302 589	A2C53240479Z		SWP-M-C
67 12 8 362 154	246-082-008-017	246-082-008-025G	SWP-M-C
67 12 8 362 154	246-082-008-025G		SWP-M-C
67 12 8 377 430	246-086-001-004	246-086-001-007C	HLWP
67 12 8 377 430	246-086-001-007C		HLWP
67 12 8 377 612	246-082-008-015N	246-082-008-025G	SWP-M-C
67 12 8 377 612	246-082-008-025G		SWP-M-C
67 12 8 377 613	246-086-001-004	246-086-001-007C	HLWP
67 12 8 377 613	246-086-001-007C		HLWP
67 12 8 377 987	246-083-002-009	246-083-002-022G	SWP-D-C
67 12 8 377 987	246-083-002-022G		SWP-D-C
67 63 7 217 792	A2C53304876		HLWP
7 217 792	A2C53304876		HLWP
7 302 588	246-082-008-025G		SWP-M-C
7 302 589	A2C53240479Z		SWP-M-C
8 350 355	246-080-013-003Z		N-H
8 362 154	246-082-008-017	246-082-008-025G	SWP-M-C
8 362 154	246-082-008-025G		SWP-M-C
8 377 430	246-086-001-004	246-086-001-007C	HLWP
8 377 430	246-086-001-007C		HLWP
8 377 612	246-082-008-015N	246-082-008-025G	SWP-M-C
8 377 612	246-082-008-025G		SWP-M-C
8 377 613	246-086-001-004	246-086-001-007C	HLWP
8 377 613	246-086-001-007C		HLWP
8 377 987	246-083-002-009	246-083-002-022G	SWP-D-C
8 377 987	246-083-002-022G		SWP-D-C



OE No.	Article No.	Article No. (new)	Product Name
<b>CHEVROLET</b>			
13250356	A2C53240114		SWP-M-C

<b>CITROËN</b>			
0000643458	X10-729-002-007		SWP-M-C
0000643492	A2C53030301		SWP-D-C
0000643497	A2C53030219		SWP-M-C
643458	X10-729-002-007		SWP-M-C
643492	A2C53030301		SWP-D-C
643497	A2C53030219		SWP-M-C
9643447780	A2C53030219		SWP-M-C
9643447980	A2C53030301		SWP-D-C

<b>CONTINENTAL</b>			
3304876	A2C53304876		HLWP

<b>DAF</b>			
0665345	246-082-003-004C	246-082-008-012C	SWP-M-C
0665345	246-082-008-012C		SWP-M-C

<b>FIAT</b>			
46797755	246-083-001-004C		SWP-D-C
71719636	246-083-001-004C		SWP-D-C
9641553980	A2C53030301		SWP-D-C

<b>FORD</b>			
1652613	X10-729-002-004		SWP-M-C
6140949	X10-729-002-008		SWP-M-C
6153469	246-082-003-011	246-082-008-014C	SWP-M-C
6153469	246-082-008-014C		SWP-M-C
6833495	X10-729-002-005		SWP-M-C
7003177	X10-729-002-005		SWP-M-C
7003178	X10-729-002-004		SWP-M-C
7222079	246-083-002-014G		SWP-D-C
73PG17K624AA	246-075-021-003	246-075-023-004C	SWP-M-G
73PG17K624AA	246-075-023-003	246-075-023-004C	SWP-M-G
73PG17K624AA	246-075-023-004C		SWP-M-G
83BB17K624BA	X10-729-002-008		SWP-M-C
86VB17K624AA	246-075-042-001C		SWP-M-G
86VB17K624AA	246-082-003-011	246-082-008-014C	SWP-M-C



OE No.	Article No.	Article No. (new)	Product Name
86VB17K624AA	246-082-008-014C		SWP-M-C
87AB17K624AC	X10-729-002-004		SWP-M-C
92AB17K624AA	X10-729-002-005		SWP-M-C
93BB17K624AA	X10-729-002-005		SWP-M-C
93BB17K624BA	X10-729-002-004		SWP-M-C
95VW17K624AA	246-083-002-014G		SWP-D-C

**HELLA**

8TW 004 223-031	246-075-044-002A		SWP-M-G
8TW 004 223-031	246-082-001-001C		SWP-M-C
8TW 004 223-031	246-082-008-014C		SWP-M-C
8TW 004 223-061	246-082-008-021G		SWP-M-C
8TW 005 206-011	246-083-002-006G		SWP-D-C
8TW 005 206-017	246-083-002-006G		SWP-D-C
8TW 005 206-031	246-083-001-004C		SWP-D-C
8TW 005 206-031	246-083-002-006G		SWP-D-C
8TW 005 206-051	246-083-002-014G		SWP-D-C
8TW 005 496-011	246-082-005-002C		SWP-M-C
8TW 006 847-007	X10-729-002-004		SWP-M-C
8TW 006 847-021	246-083-002-022G		SWP-D-C
8TW 006 848-007	X10-729-002-005		SWP-M-C
8TW 006 848-021	246-082-008-025G		SWP-M-C
8TW 006 848-041	246-082-008-025G		SWP-M-C
8TW 006 848-057	X10-729-002-006		SWP-M-C
8TW 006 848-077	X10-729-002-007		SWP-M-C
8TW 006 848-101	246-075-044-001C		SWP-M-G
8TW 006 849-007	X10-729-002-008		SWP-M-C
8TW 006 849-011	246-086-001-002C		HLWP

**HONDA**

76806-SMG-E01	246-082-008-025G		SWP-M-C
---------------	------------------	--	---------

**IVECO**

9 665 345	246-082-003-004C	246-082-008-012C	SWP-M-C
9 665 345	246-082-008-012C		SWP-M-C

**LADA**

2108 5208009 20	246-082-008-014C		SWP-M-C
-----------------	------------------	--	---------



OE No.	Article No.	Article No. (new)	Product Name
<b>LANCIA</b>			
46797755	246-083-001-004C		SWP-D-C
71719636	246-083-001-004C		SWP-D-C

<b>MAN</b>			
81.26481-0033	89-602-050		G
81.26484-0002	246-063-013-001D		V
81.26485-6008	246-075-010-001C		SWP-M-G
81.26485-6008	246-075-024-004	246-075-010-001C	SWP-M-G
81.26485-6016	246-082-003-002	246-082-008-012C	SWP-M-C
81.26485-6016	246-082-008-012C		SWP-M-C
81.26485-6027	246-083-001-006C		SWP-D-C

<b>MAZDA</b>			
1E0076672	X10-729-002-004		SWP-M-C
1E00-76-672	X10-729-002-004		SWP-M-C

<b>MERCEDES-BENZ</b>			
000 860 12 26	246-082-003-009C	246-082-008-012C	SWP-M-C
000 860 12 26	246-082-008-012C		SWP-M-C
000 860 13 26	246-082-003-003	246-082-008-014C	SWP-M-C
000 860 13 26	246-082-008-014C		SWP-M-C
000 860 15 26	246-075-050-007C		SWP-M-G
000 860 20 26	246-082-003-016	246-082-008-014C	SWP-M-C
000 860 20 26	246-082-008-014C		SWP-M-C
000 860 32 26	246-082-008-005	246-082-008-012C	SWP-M-C
000 860 32 26	246-082-008-012C		SWP-M-C
000 860 33 26	246-082-008-009	246-082-008-014C	SWP-M-C
000 860 33 26	246-082-008-014C		SWP-M-C
000 860 60 47	246-068-003-001G		N
000 869 01 58	88-205-001		C
000 869 10 22	246-063-004-001G		V
000 869 21 20	246-061-009-002D		R
000 869 22 21	246-075-015-001C		SWP-M-G
000 869 24 21	246-075-010-001C		SWP-M-G
000 869 24 47	246-069-026-001G		N
000 869 29 21	246-075-021-004	246-075-021-007C	SWP-M-G
000 869 29 21	246-075-021-007C		SWP-M-G
000 869 30 21	246-075-017-002C		SWP-M-G
000 869 30 21	246-075-021-007C		SWP-M-G
000 869 31 21	246-075-024-002C		SWP-M-G
107 869 00 24	88-326-004		C



OE No.	Article No.	Article No. (new)	Product Name
108 869 01 21	246-075-017-001	246-075-017-002C	SWP-M-G
108 869 01 21	246-075-017-002C		SWP-M-G
115 869 02 21	246-075-017-002C		SWP-M-G
124 869 00 21	246-082-005-001	246-082-005-002C	SWP-M-C
124 869 00 21	246-082-005-002C		SWP-M-C
124 869 01 21	246-082-005-001	246-082-005-002C	SWP-M-C
124 869 01 21	246-082-005-002C		SWP-M-C
124 869 03 21	246-082-005-001	246-082-005-002C	SWP-M-C
124 869 03 21	246-082-005-002C		SWP-M-C
124 869 04 21	246-082-005-001	246-082-005-002C	SWP-M-C
124 869 04 21	246-082-005-002C		SWP-M-C
124 869 05 21	246-082-005-001	246-082-005-002C	SWP-M-C
124 869 05 21	246-082-005-002C		SWP-M-C
124 869 06 21	246-082-005-001	246-082-005-002C	SWP-M-C
124 869 06 21	246-082-005-002C		SWP-M-C
126 860 07 47	246-080-003-001	246-080-003-006D	N-H
126 860 07 47	246-080-003-006D		N-H
140 869 02 21	246-082-008-003	246-082-008-013P	SWP-M-C
140 869 02 21	246-082-008-013P		SWP-M-C
202 869 00 21	246-082-008-011C	246-082-008-013P	SWP-M-C
202 869 00 21	246-082-008-013P		SWP-M-C
204 866 02 21	246-083-002-022G		SWP-D-C
210 869 08 21	246-082-008-015N	246-082-008-025G	SWP-M-C
210 869 08 21	246-082-008-025G		SWP-M-C
221 869 01 21	246-082-008-025G		SWP-M-C
322 869 00 47	246-069-029-004G		N
608 869 00 14	246-063-004-001G		V
A000 860 12 26	246-082-003-009C	246-082-008-012C	SWP-M-C
A000 860 12 26	246-082-008-012C		SWP-M-C
A000 860 13 26	246-082-003-003	246-082-008-014C	SWP-M-C
A000 860 13 26	246-082-008-014C		SWP-M-C
A000 860 15 26	246-075-050-007C		SWP-M-G
A000 860 20 26	246-082-003-016	246-082-008-014C	SWP-M-C
A000 860 20 26	246-082-008-014C		SWP-M-C
A000 860 32 26	246-082-008-005	246-082-008-012C	SWP-M-C
A000 860 32 26	246-082-008-012C		SWP-M-C
A000 860 33 26	246-082-008-009	246-082-008-014C	SWP-M-C
A000 860 33 26	246-082-008-014C		SWP-M-C
A000 860 60 47	246-068-003-001G		N
A000 869 01 58	88-205-001		C
A000 869 10 22	246-063-004-001G		V
A000 869 21 20	246-061-009-002D		R
A000 869 22 21	246-075-015-001C		SWP-M-G
A000 869 24 21	246-075-010-001C		SWP-M-G
A000 869 24 47	246-069-026-001G		N
A000 869 29 21	246-075-021-004	246-075-021-007C	SWP-M-G



OE No.	Article No.	Article No. (new)	Product Name
A000 869 29 21	246-075-021-007C		SWP-M-G
A000 869 30 21	246-075-017-002C		SWP-M-G
A000 869 30 21	246-075-021-007C		SWP-M-G
A000 869 31 21	246-075-024-002C		SWP-M-G
A107 869 00 24	88-326-004		C
A108 869 01 21	246-075-017-001	246-075-017-002C	SWP-M-G
A108 869 01 21	246-075-017-002C		SWP-M-G
A115 869 02 21	246-075-017-002C		SWP-M-G
A124 869 00 21	246-082-005-001	246-082-005-002C	SWP-M-C
A124 869 00 21	246-082-005-002C		SWP-M-C
A124 869 01 21	246-082-005-001	246-082-005-002C	SWP-M-C
A124 869 01 21	246-082-005-002C		SWP-M-C
A124 869 03 21	246-082-005-001	246-082-005-002C	SWP-M-C
A124 869 03 21	246-082-005-002C		SWP-M-C
A124 869 04 21	246-082-005-001	246-082-005-002C	SWP-M-C
A124 869 04 21	246-082-005-002C		SWP-M-C
A124 869 05 21	246-082-005-001	246-082-005-002C	SWP-M-C
A124 869 05 21	246-082-005-002C		SWP-M-C
A124 869 06 21	246-082-005-001	246-082-005-002C	SWP-M-C
A124 869 06 21	246-082-005-002C		SWP-M-C
A126 860 07 47	246-080-003-001	246-080-003-006D	N-H
A126 860 07 47	246-080-003-006D		N-H
A140 869 02 21	246-082-008-003	246-082-008-013P	SWP-M-C
A140 869 02 21	246-082-008-013P		SWP-M-C
A202 869 00 21	246-082-008-011C	246-082-008-013P	SWP-M-C
A202 869 00 21	246-082-008-013P		SWP-M-C
A204 866 02 21	246-083-002-022G		SWP-D-C
A210 869 08 21	246-082-008-015N	246-082-008-025G	SWP-M-C
A210 869 08 21	246-082-008-025G		SWP-M-C
A221 869 01 21	246-082-008-025G		SWP-M-C
A322 869 00 47	246-069-029-004G		N
A608 869 00 14	246-063-004-001G		V

## MITSUBISHI

MR911031	246-086-001-002C		HLWP
----------	------------------	--	------

## OPEL

13250356	A2C53240114		SWP-M-C
1 450 058	A2C53240114		SWP-M-C
14 50 156	246-082-008-008	246-082-008-014C	SWP-M-C
14 50 156	246-082-008-014C		SWP-M-C
14 50 174	246-082-008-008	246-082-008-014C	SWP-M-C
14 50 174	246-082-008-014C		SWP-M-C



OE No.	Article No.	Article No. (new)	Product Name
14 50 175	246-083-001-001	246-083-001-004C	SWP-D-C
14 50 175	246-083-001-004C		SWP-D-C
14 50 184	246-082-008-018	246-082-008-021G	SWP-M-C
14 50 184	246-082-008-021G		SWP-M-C
14 50 185	246-083-002-008	246-083-002-014G	SWP-D-C
14 50 185	246-083-002-012G	246-083-002-014G	SWP-D-C
14 50 185	246-083-002-014G		SWP-D-C
90045820	246-082-008-008	246-082-008-014C	SWP-M-C
90045820	246-082-008-014C		SWP-M-C
90226604	246-083-001-001	246-083-001-004C	SWP-D-C
90226604	246-083-001-004C		SWP-D-C
90585761	246-082-008-018	246-082-008-021G	SWP-M-C
90585761	246-082-008-021G		SWP-M-C
90585762	246-083-002-008	246-083-002-014G	SWP-D-C
90585762	246-083-002-012G	246-083-002-014G	SWP-D-C
90585762	246-083-002-014G		SWP-D-C

## PEUGEOT

0000643458	X10-729-002-007		SWP-M-C
0000643492	A2C53030301		SWP-D-C
0000643497	A2C53030219		SWP-M-C
643458	X10-729-002-007		SWP-M-C
643492	A2C53030301		SWP-D-C
643497	A2C53030219		SWP-M-C
9643447780	A2C53030219		SWP-M-C
9643447980	A2C53030301		SWP-D-C

## PORSCHE

431 955 651	246-082-008-014C		SWP-M-C
431 955 651	246-082-008-025G		SWP-M-C
823 955 651	246-075-042-001C		SWP-M-G
928 628 074 01	246-075-015-001C		SWP-M-G
928 628 074 01	246-075-023-020	246-075-015-001C	SWP-M-G
928 628 172 01	246-075-042-001C		SWP-M-G
970 624 502 00	246-086-001-007C		HLWP
996 624 502 00	246-086-001-002C		HLWP
996 628 172 00	246-082-008-015N	246-082-008-025G	SWP-M-C
996 628 172 00	246-082-008-025G		SWP-M-C
997 624 502 00	246-086-001-007C		HLWP

## RENAULT

7700802336	X10-729-002-006		SWP-M-C
------------	-----------------	--	---------



OE No.	Article No.	Article No. (new)	Product Name
<b>SAAB</b>			
13250356	A2C53240114		SWP-M-C
85 93 477	246-082-003-005C	246-082-008-014C	SWP-M-C
85 93 477	246-082-008-014C		SWP-M-C
95 06 379	246-082-001-001C		SWP-M-C

**SCANIA**

1395994	246-075-044-003A		SWP-M-G
295970	246-082-003-001	246-082-008-012C	SWP-M-C
295970	246-082-008-012C		SWP-M-C
300786	246-063-013-001D		V
300792	246-069-050-005D		N
353546	246-082-001-002C		SWP-M-C
367110	246-082-001-001C		SWP-M-C

**SEAT**

191 955 985 A	246-069-056-001Z		N
191 955 986 A	246-080-010-002Z		N-H
1H5 955 651	246-082-008-001Z	246-082-008-021G	SWP-M-C
1H5 955 651	246-082-008-021G		SWP-M-C
1H6 955 651	246-083-002-001Z	246-083-002-014G	SWP-D-C
1H6 955 651	246-083-002-007	246-083-002-014G	SWP-D-C
1H6 955 651	246-083-002-014G		SWP-D-C
1J0 955 681	246-086-001-002C		HLWP
1J0 955 681	246-086-001-006	246-086-001-002C	HLWP
1J0 973 722 A	X11-246-003-014		A
1J5 955 651	246-082-008-019	246-082-008-025G	SWP-M-C
1J5 955 651	246-082-008-022	246-082-008-025G	SWP-M-C
1J5 955 651	246-082-008-025G		SWP-M-C
1J6 955 651	246-083-002-010	246-083-002-022G	SWP-D-C
1J6 955 651	246-083-002-015	246-083-002-022G	SWP-D-C
1J6 955 651	246-083-002-022G		SWP-D-C
1K5 955 651	246-082-008-025G		SWP-M-C
1K6 955 651	246-083-002-022G		SWP-D-C
1T0 955 651 A	246-083-002-019	246-083-002-022G	SWP-D-C
1T0 955 651 A	246-083-002-022G		SWP-D-C
3B0 955 681 A	246-086-001-017	246-086-001-007C	HLWP
3B7 955 681	246-086-001-007C		HLWP
3B7 955 681	246-086-001-016	246-086-001-007C	HLWP
431 955 651	246-082-003-007	246-082-008-014C	SWP-M-C
431 955 651	246-082-008-014C		SWP-M-C





OE No.	Article No.	Article No. (new)	Product Name
<b>SIEMENS</b>			
3240114	A2C53240114		SWP-M-C

<b>SKODA</b>			
1J0 955 681	246-086-001-002C		HLWP
1J0 973 722 A	X11-246-003-014		A
1J5 955 651	246-082-008-019	246-082-008-025G	SWP-M-C
1J5 955 651	246-082-008-022	246-082-008-025G	SWP-M-C
1J5 955 651	246-082-008-025G		SWP-M-C
1J6 955 651	246-083-002-010	246-083-002-022G	SWP-D-C
1J6 955 651	246-083-002-015	246-083-002-022G	SWP-D-C
1J6 955 651	246-083-002-022G		SWP-D-C
1K5 955 651	246-082-008-025G		SWP-M-C
1K6 955 651	246-083-002-022G		SWP-D-C
1T0 955 651	246-082-008-025G		SWP-M-C
1T0 955 651	246-082-008-026	246-082-008-025G	SWP-M-C
1T0 955 651 A	246-083-002-019	246-083-002-022G	SWP-D-C
1T0 955 651 A	246-083-002-022G		SWP-D-C
3B0 955 681 A	246-086-001-007C		HLWP
3B0 955 681 A	246-086-001-017	246-086-001-007C	HLWP
3B7 955 681	246-086-001-007C		HLWP
3B7 955 681	246-086-001-016	246-086-001-007C	HLWP

<b>SMART (MCC)</b>			
0000038V001000000	246-083-002-005C	246-083-002-022G	SWP-D-C
0000038V001000000	246-083-002-022G		SWP-D-C
0001753V001000000	246-082-008-015N	246-082-008-025G	SWP-M-C
0001753V001000000	246-082-008-025G		SWP-M-C
221 869 01 21	246-082-008-025G		SWP-M-C
A221 869 01 21	246-082-008-025G		SWP-M-C

<b>SWAG</b>			
20 92 6495	A2C53240479Z		SWP-M-C

<b>VAUXHALL</b>			
14 50 174	246-082-008-014C		SWP-M-C
14 50 175	246-083-001-004C		SWP-D-C
14 50 184	246-082-008-021G		SWP-M-C
14 50 185	246-083-002-014G		SWP-D-C
90492357	246-083-001-004C		SWP-D-C



OE No.	Article No.	Article No. (new)	Product Name
90585761	246-082-008-021G		SWP-M-C
90585762	246-083-002-014G		SWP-D-C

**VDO**

246-069-056-001A	246-069-056-001Z		N
246-069-059-001A	246-069-059-001Z		N
246-080-010-002D	246-080-010-002Z		N-H
246-080-013-001A	246-080-013-001Z		N-H
246-080-013-003A	246-080-013-003Z		N-H
246-082-008-012V	246-082-008-012C		SWP-M-C
246-082-008-016Z	246-075-044-001C		SWP-M-G
246-083-001-001	246-083-001-004C		SWP-D-C
3020175	246-082-008-025G		SWP-M-C
3030219	A2C53030219		SWP-M-C
3030301	A2C53030301		SWP-D-C
3043125	246-083-002-022G		SWP-D-C
3091387	246-083-002-022G		SWP-D-C
3240479	A2C53240479Z		SWP-M-C
A2C53240479	A2C53240479Z		SWP-M-C

**VOLVO**

1254197	246-075-015-016C	246-075-021-006C	SWP-M-G
1254197	246-075-021-006C		SWP-M-G
1258016	246-075-044-001C		SWP-M-G
1259832	246-075-044-002A		SWP-M-G
1307159	246-068-013-004D		N
1307159	246-068-050-003D	246-068-013-004D	N
1342553	246-063-004-001G		V
1585878	246-075-040-020C		SWP-M-G
1606929	246-075-051-007C		SWP-M-G
3205207	246-075-042-001C		SWP-M-G
3276564	246-075-023-003	246-075-023-004C	SWP-M-G
3276564	246-075-023-004C		SWP-M-G
4831689	246-069-050-005D		N
9178094	246-075-044-001C		SWP-M-G
9178094	246-082-008-016Z	246-075-044-001C	SWP-M-G

**VW**

191 955 681	246-086-001-002C		HLWP
191 955 681	246-086-001-006	246-086-001-002C	HLWP
191 955 985 A	246-069-056-001Z		N
191 955 986 A	246-080-010-002Z		N-H



OE No.	Article No.	Article No. (new)	Product Name
1H5 955 651	246-082-008-001Z	246-082-008-021G	SWP-M-C
1H5 955 651	246-082-008-021G		SWP-M-C
1H6 955 651	246-083-002-001Z	246-083-002-014G	SWP-D-C
1H6 955 651	246-083-002-014G		SWP-D-C
1J0 973 722 A	X11-246-003-014		A
1J5 955 651	246-082-008-019	246-082-008-025G	SWP-M-C
1J5 955 651	246-082-008-022	246-082-008-025G	SWP-M-C
1J5 955 651	246-082-008-025G		SWP-M-C
1J6 955 651	246-083-002-010	246-083-002-022G	SWP-D-C
1J6 955 651	246-083-002-015	246-083-002-022G	SWP-D-C
1J6 955 651	246-083-002-022G		SWP-D-C
1K5 955 651	246-082-008-025G		SWP-M-C
1K6 955 651	246-083-002-022G		SWP-D-C
1T0 955 651	246-082-008-025G		SWP-M-C
1T0 955 651	246-082-008-026	246-082-008-025G	SWP-M-C
1T0 955 651 A	246-083-002-019	246-083-002-022G	SWP-D-C
1T0 955 651 A	246-083-002-022G		SWP-D-C
333 955 651	246-083-001-002	246-083-002-006G	SWP-D-C
333 955 651	246-083-002-002C	246-083-002-006G	SWP-D-C
333 955 651	246-083-002-006G		SWP-D-C
3B0 955 681	246-086-001-002C		HLWP
3B0 955 681	246-086-001-005	246-086-001-002C	HLWP
3B0 955 681 A	246-086-001-007C		HLWP
3B0 955 681 A	246-086-001-017	246-086-001-007C	HLWP
3B7 955 681	246-086-001-007C		HLWP
3B7 955 681	246-086-001-016	246-086-001-007C	HLWP
431 955 651	246-082-003-007	246-082-008-014C	SWP-M-C
431 955 651	246-082-008-014C		SWP-M-C
5K0 955 651	246-083-002-022G		SWP-D-C
690 955 651	246-082-003-002	246-082-008-012C	SWP-M-C
690 955 651	246-082-008-012C		SWP-M-C
823 955 651	246-075-021-001	246-075-021-006C	SWP-M-G
823 955 651	246-075-021-006C		SWP-M-G
8K0 955 681	A2C53304876		HLWP

## Illustration Pump holders

Die Halter finden auch bei Scheiben-Reinigungspumpen mit anderen als den abgebildeten Steckern Verwendung.

The holders are used also for screen washer pumps with plugs different from those shown.

I supporti possono essere utilizzati anche per le pompe tergicristalli con connettori diversi da quelle raffigurati.

Los soportes también pueden utilizarse en bombas de lavado para lunas con otras hembrillas que las representadas en las imágenes.

Les supports peuvent être également utilisés pour des pompes de nettoyage de glaces munies d'autres connecteurs que ceux représentés.

Данное крепление применяется и с насосами стеклоомывателей, оснащёнными отличающимися от показанных на рисунках штекерами.

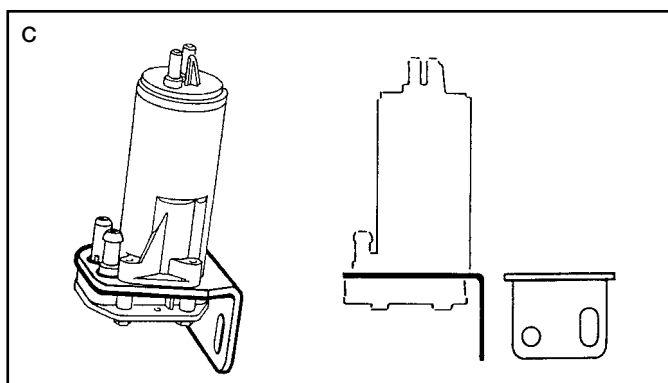
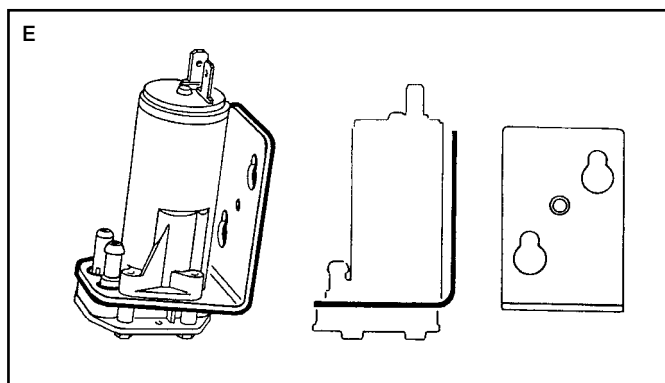
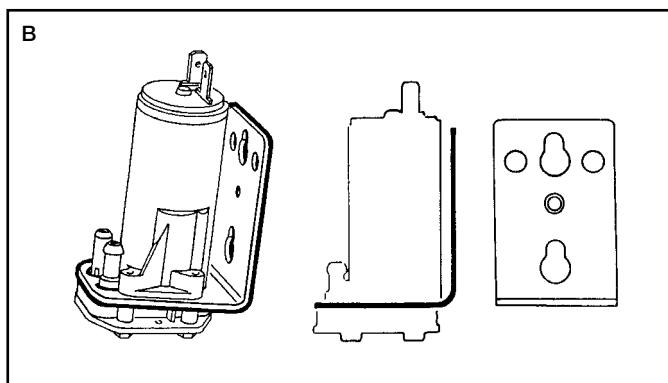
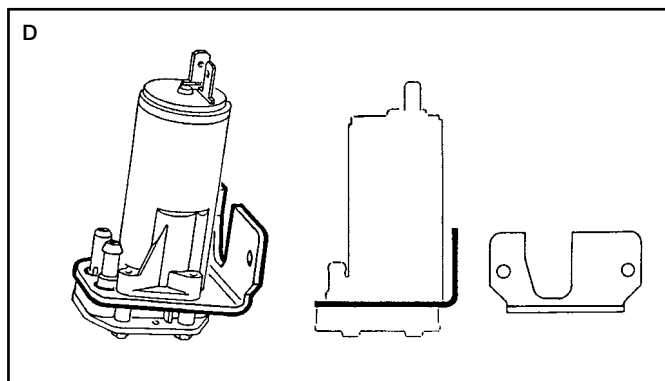
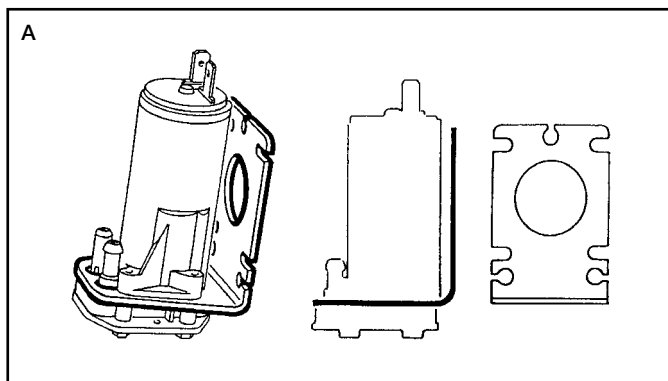

## Illustration Pump plugs

Bitte achten Sie beim Anschluss der Pumpen auf die korrekte Polung (+/-).

Pay attention to the correct polarity (+/-) when connecting the pumps.

Quando si collegano le pompe assicurarsi che la polarizzazione (+/-) sia corretta.

Rogamos que observe la polaridad correcta (+/-) al conectar las bombas.

Veiller à la polarité correcte (+/-) lors de la connexion des pompes.

Пожалуйста, при подсоединении насоса следите за правильным чередованием полюсов (+/-).

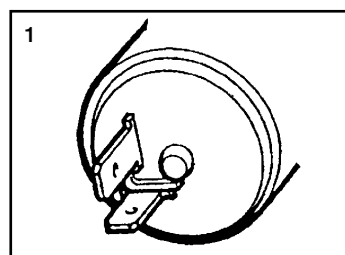

1  
ALFA ROMEO, AUDI, BMW,  
FIAT, FORD, LADA, LANCIA,  
MAN, MERCEDES-BENZ,  
OPEL, PORSCHE, SAAB, SEAT,  
VAUXHALL, VOLKSWAGEN,  
VOLVO

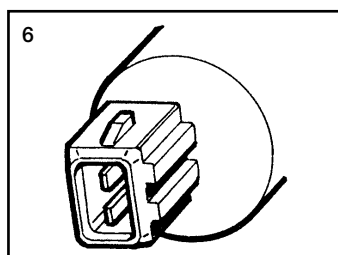

6  
FORD, OPEL, SEAT,  
VAUXHALL, VOLKSWAGEN

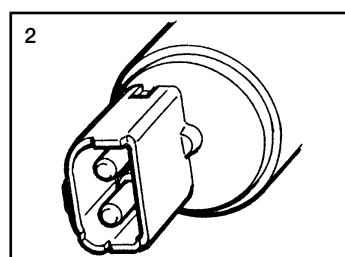

2  
SAAB, SCANIA, VOLVO

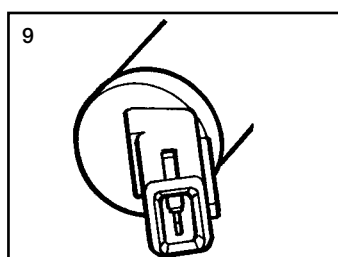

9  
FORD, MAZDA

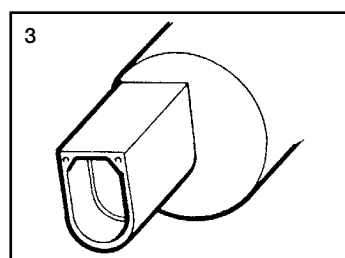

3  
AUDI, BMW, MERCEDES-BENZ,  
MITSUBISHI, PORSCHE, SEAT,  
SKODA, SMART (MCC),  
VOLKSWAGEN

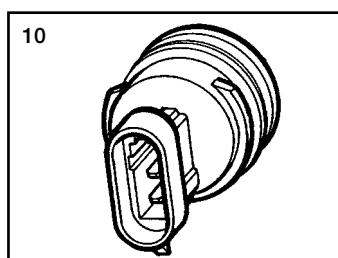

10  
RENAULT

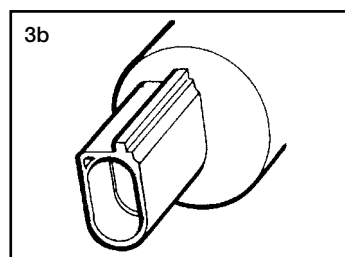

3b  
AUDI, BMW, MERCEDES-BENZ,  
SEAT, SKODA, VOLKSWAGEN

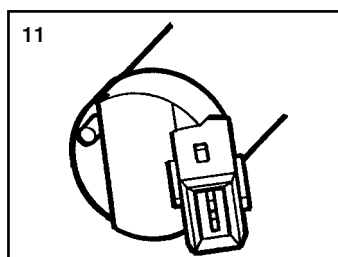

11  
CITROËN, PEUGEOT

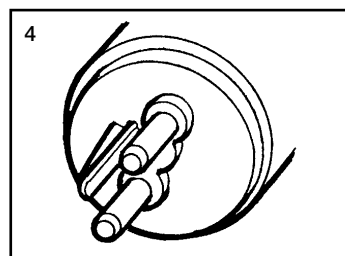

4  
MERCEDES-BENZ

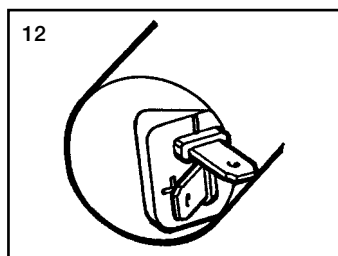

12  
FORD

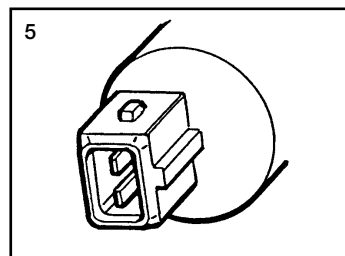

5  
VOLVO

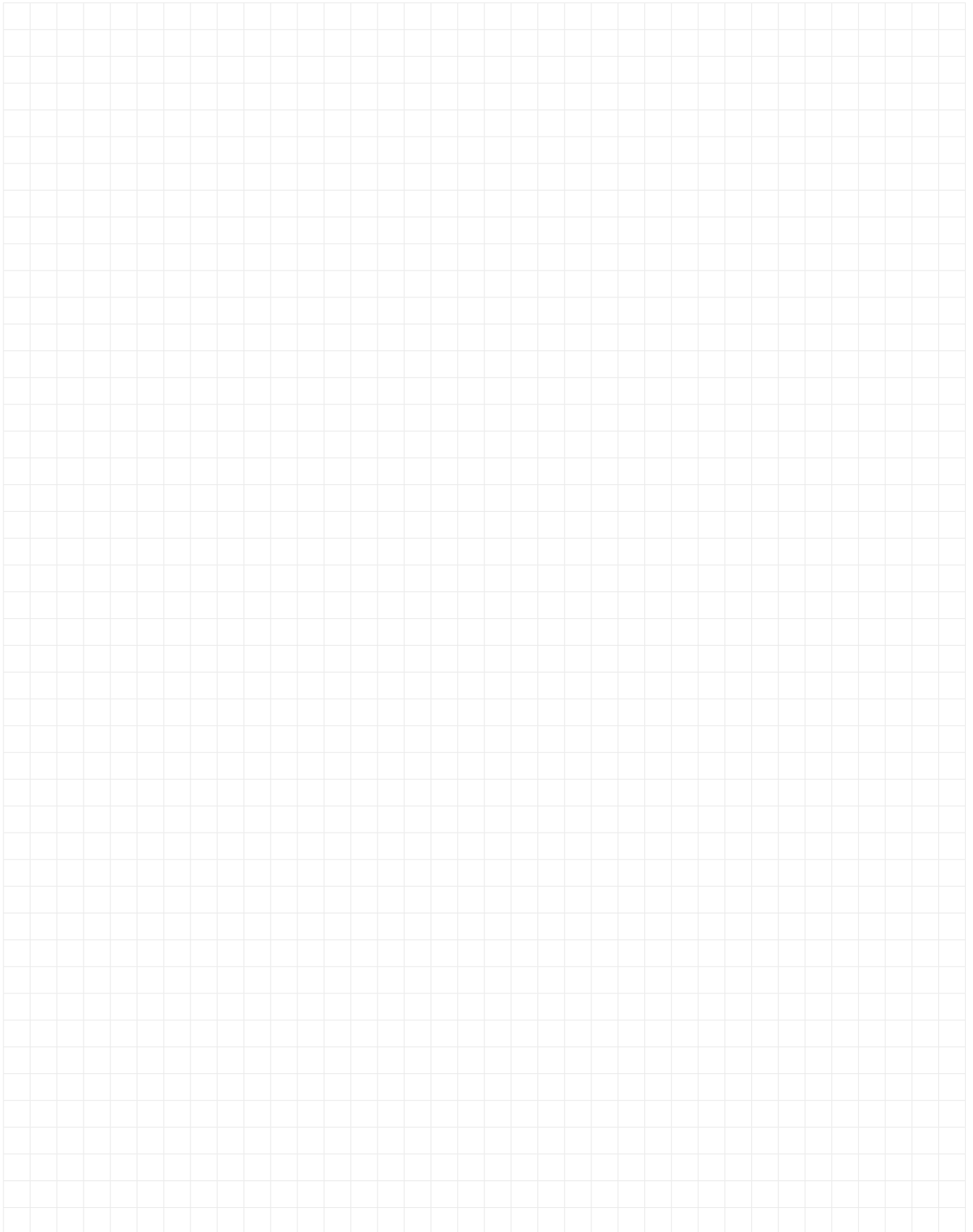

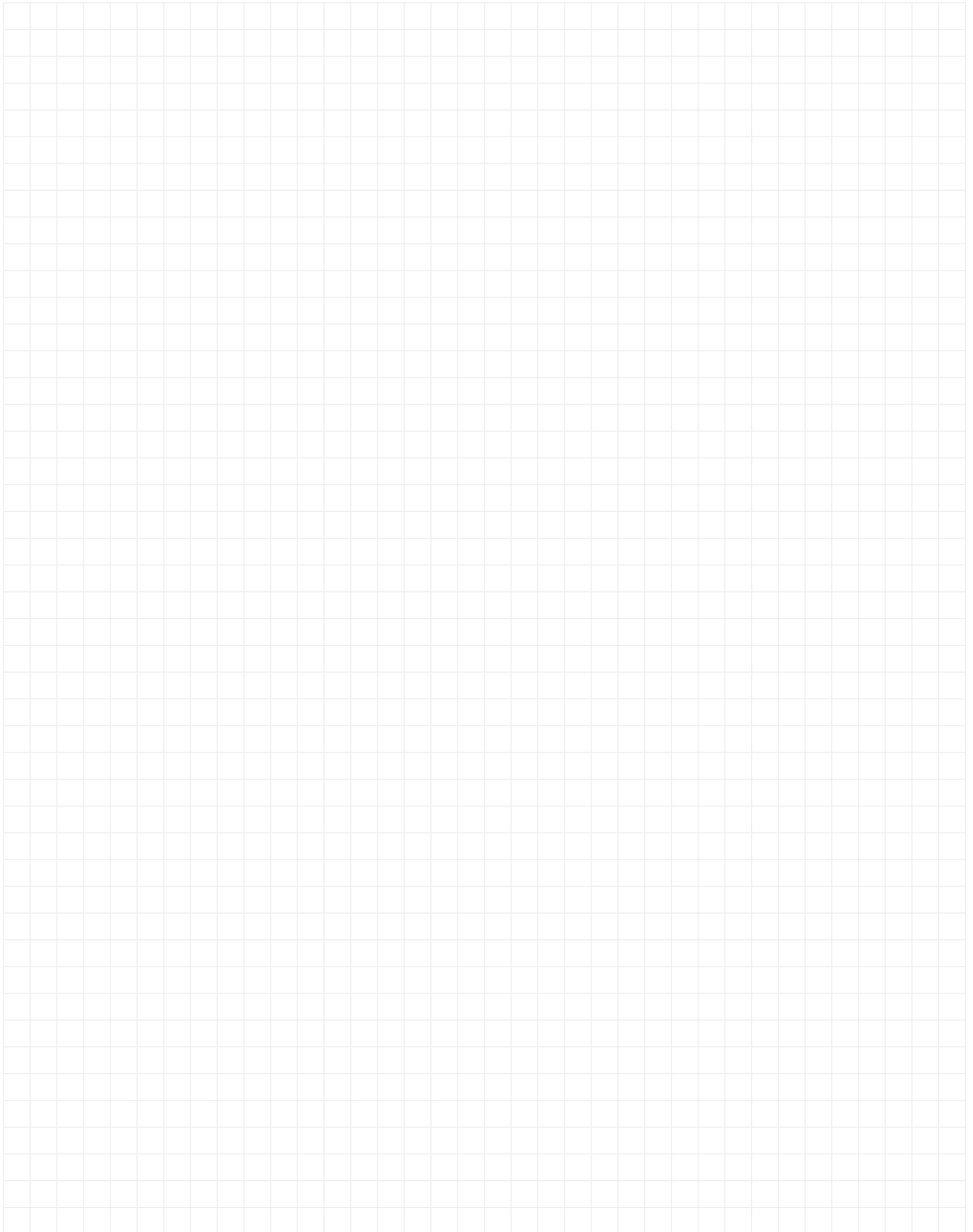

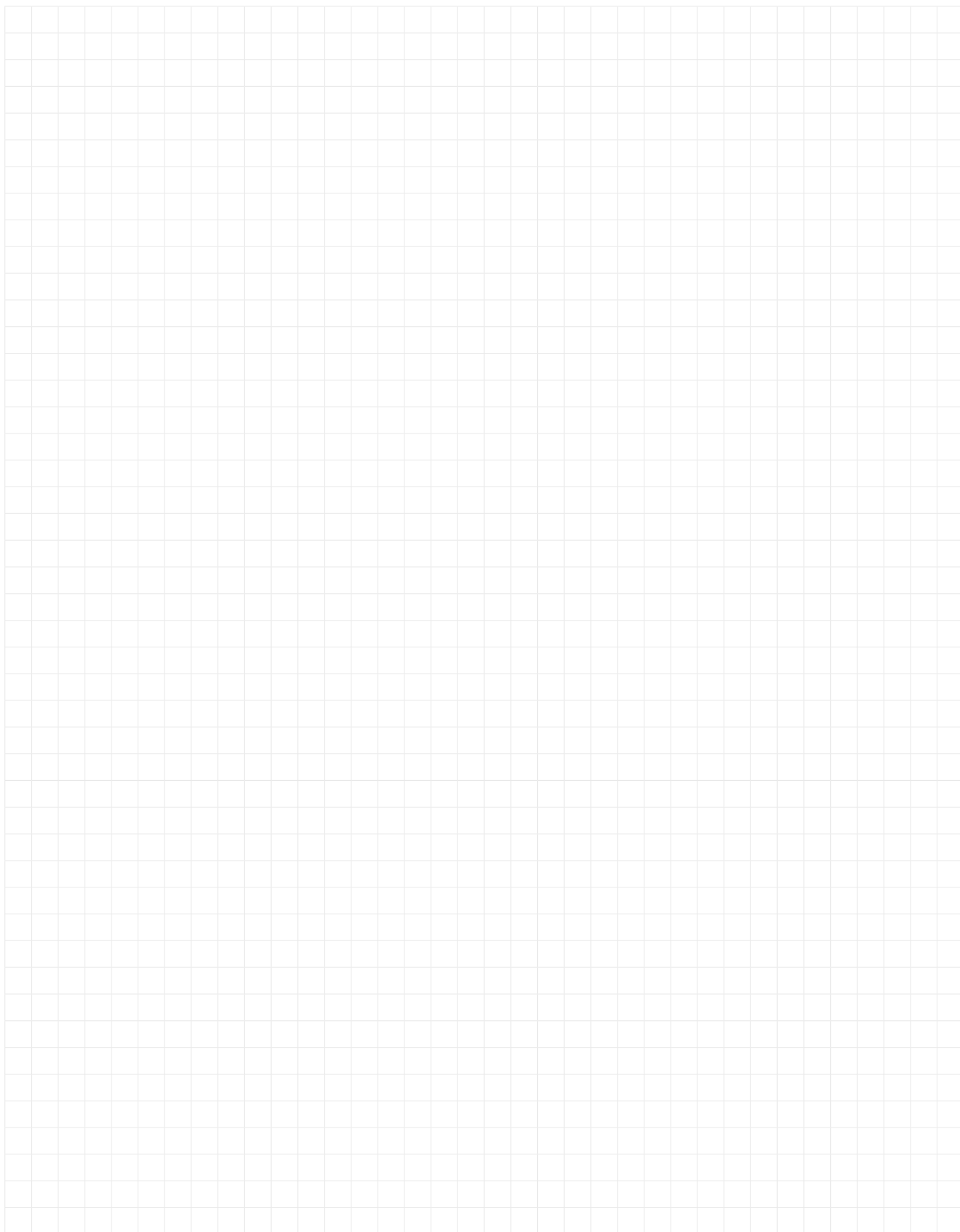



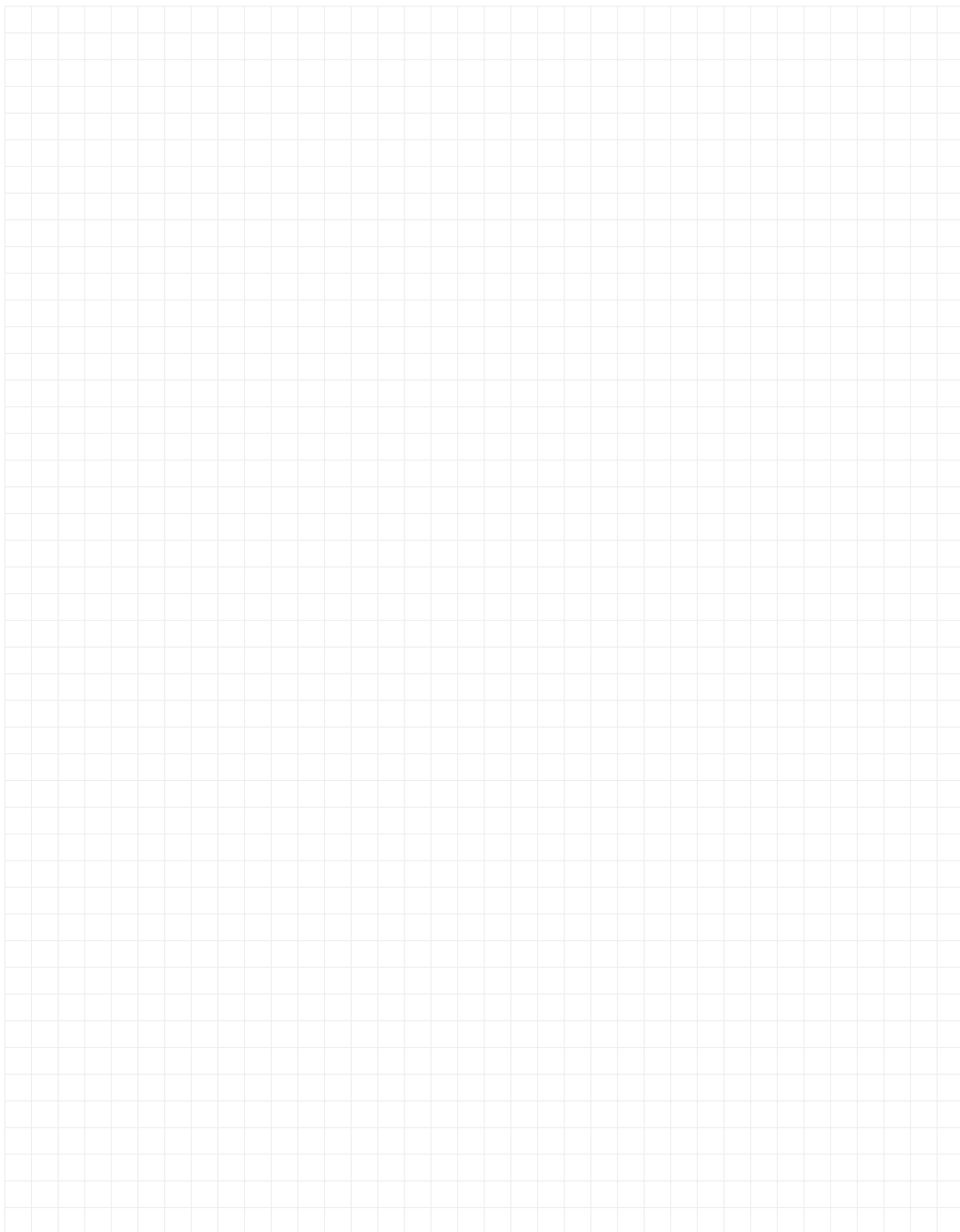



Abbreviazione	Descrizione
<b>I</b>	
<b>SWP-M-C</b>	Pompa tergitristalli, monopompa centrifuga
<b>SWP-M-G</b>	Pompa tergitristalli, monopompa ad ingranaggi
<b>SWP-D-C</b>	Pompa tergitristalli, pompa centrifuga tandem
<b>HLWP</b>	Pompa tergifari
<b>N</b>	Ugello
<b>N-H</b>	Ugello, riscaldabile
<b>FLS</b>	Interruttore di livello
<b>C</b>	Raccordo
<b>V</b>	Valvola
<b>G</b>	Guarnizione
<b>NN</b>	Ago ugello
<b>A</b>	Adattatore
<b>R</b>	Serbatoio
<b>T1:</b>	Tensione d'esercizio [V]:
<b>T2:</b>	Codice ID del connettore:
<b>T3:</b>	Capienza [litri]
<b>T4:</b>	Funzionamento:
<b>T5</b>	elettrico
<b>T6</b>	Forma costruttiva
<b>T7</b>	Raccordo a T
<b>T8</b>	Forma a I
<b>T9:</b>	Tipo di valvola:
<b>T10</b>	Valvola antiritorno
<b>T11:</b>	Articoli complementari:
<b>T12</b>	con filtro
<b>T13</b>	per la pulizia del parabrezza
<b>T14</b>	per la pulizia del lunotto
<b>T15:</b>	Modello ugello spruzzatore:
<b>T16</b>	Ugello semplice
<b>T17</b>	Ugello doppio
<b>T18</b>	Ugello quadruplo
<b>T19</b>	riscaldato
<b>T20:</b>	Tipo di pompa:
<b>T21</b>	Monopompa
<b>T22</b>	Pompa tandem
<b>T23:</b>	Codice ID del supporto:
<b>T24</b>	Variante dotazione
<b>T25</b>	per numero OE
<b>T26</b>	Adattatore in dotazione
<b>T27:</b>	Numero porte:
<b>T28:</b>	Lato montaggio:
<b>T29</b>	posteriore
<b>T30</b>	Restrizione del costruttore
<b>T31:</b>	Dotazione veicolo:
<b>T32</b>	con climatizzatore
<b>T33</b>	con servosterzo
<b>T34</b>	con tergilunotto
<b>T35</b>	con impianto tergifari
<b>T36</b>	senza climatizzatore
<b>T37</b>	senza tergitristallo posteriore
<b>T38</b>	I modelli dei veicoli sono indicati a scopo unicamente informativo. Da non utilizzare come guida applicativa dettagliata.

Сокращение	Описание
<b>RUS</b>	
<b>SWP-M-C</b>	Насос омывателя стекла, центробежный монопасос
<b>SWP-M-G</b>	Насос омывателя стекла, шестеренчатый монопасос
<b>SWP-D-C</b>	Насос омывателя стекла, центробежный двойной насос
<b>HLWP</b>	Насос омывателя фар
<b>N</b>	Форсунка
<b>N-H</b>	Форсунка, обогреваемая
<b>FLS</b>	Реле уровня
<b>C</b>	Соединительный элемент
<b>V</b>	Клапан
<b>G</b>	Уплотнение
<b>NN</b>	Игла для форсунки
<b>A</b>	Адаптер
<b>R</b>	Бачок
<b>T1:</b>	Рабочее напряжение [В]:
<b>T2:</b>	Идент. номер штекера:
<b>T3:</b>	Емкость [литр]
<b>T4:</b>	Режим работы:
<b>T5</b>	электрический
<b>T6</b>	Конструкция
<b>T7</b>	Тройник
<b>T8</b>	I-образная форма
<b>T9:</b>	Вид клапана:
<b>T10</b>	Обратный клапан
<b>T11:</b>	Дополнительные изделия:
<b>T12</b>	С фильтром
<b>T13</b>	Для чистки лобового стекла
<b>T14</b>	Для чистки заднего стекла
<b>T15:</b>	Исполнение форсунки омывателя:
<b>T16</b>	Одинарная форсунка
<b>T17</b>	Двойная форсунка
<b>T18</b>	Счетверенная форсунка
<b>T19</b>	обогреваемая
<b>T20:</b>	Вид насоса:
<b>T21</b>	Монопасос
<b>T22</b>	Двойной насос
<b>T23:</b>	Идент. номер исполнения крепления:
<b>T24</b>	Вариант оснащения
<b>T25</b>	Для номера OE
<b>T26</b>	Прилагаемый адаптер
<b>T27:</b>	Число дверей:
<b>T28:</b>	Сторона установки:
<b>T29</b>	сзади
<b>T30</b>	Ограничение изготовителя
<b>T31:</b>	Оснащение автомобиля:
<b>T32</b>	с системой кондиционирования воздуха
<b>T33</b>	С сервоуправлением
<b>T34</b>	С очистителем заднего стекла
<b>T35</b>	С омывателем фар
<b>T36</b>	Без кондиционера
<b>T37</b>	без стеклоочистителя для заднего стекла
<b>T38</b>	Модели автомобилей предназначены только для общей информации, а не в качестве подробной инструкции для применения запасных частей.



Abréviation	Description	F
SWP-M-C	Pompe de nettoyage des glaces, pompe centrifuge simple	
SWP-M-G	Pompe de nettoyage des glaces, pompe à engrenages simple	
SWP-D-C	Pompe de nettoyage des glaces, pompe centrifuge tandem	
HLWP	Pompe de nettoyage des phares	
N	Buse	
N-H	Buse, chauffable	
FLS	Détecteur de niveau	
C	Pièce de jonction	
V	Valve	
G	Joint	
NN	Pointeau	
A	Adaptateur	
R	Réservoir	
T1:	Tension de service [V] :	
T2:	N° du modèle de connecteur	
T3:	Contenance [litre]	
T4:	Mode opératoire	
T5	électrique	
T6	Forme de construction	
T7	Pièce en T	
T8	Forme en I	
T9:	Type de valve :	
T10	Clapet antiretour	
T11:	Article complémentaire	
T12	avec filtre	
T13	pour le nettoyage du pare-brise	
T14	pour le nettoyage de la lunette arrière	
T15:	Modèle de buse de lavage :	
T16	buse simple	
T17	buse double	
T18	buse quadruple	
T19	chauffée	
T20:	Type de pompe :	
T21	pompe simple	
T22	pompe tandem	
T23:	N° du modèle de support :	
T24	Variante d'équipement	
T25	pour numéro OE	
T26	Adaptateur fourni	
T27:	Nombre de portes :	
T28:	Côté de montage	
T29	à l'arrière	
T30	Restriction du constructeur	
T31:	Équipement du véhicule	
T32	avec climatiseur	
T33	avec direction assistée	
T34	avec essuie-glace arrière	
T35	avec nettoyeur de phares	
T36	sans climatisation	
T37	sans essuie-glace arrière	
T38	Les modèles de véhicules sont présentés à titre d'information générale uniquement. Ce document ne constitue pas un guide pratique et ne doit pas être utilisé comme tel.	

Abreviatura	Descripción	E
SWP-M-C	Bomba de lavado para lunas, mono - bomba centrifuga	
SWP-M-G	Bomba de lavado para lunas, mono - bomba de engranajes	
SWP-D-C	Bomba de lavado para lunas, dual - bomba centrifuga	
HLWP	Bomba de lavado para faros	
N	Tobera	
N-H	Tobera, calentable	
FLS	Conmutador de nivel	
C	Pieza de conexión	
V	Válvula	
G	Junta	
NN	Aguja de tobera	
A	Adaptador	
R	Depósito	
T1:	Tensión de servicio [V]:	
T2:	N° de hembra:	
T3:	Capacidad [litros]:	
T4:	Modo de servicio:	
T5	eléctrico	
T6	Forma constructiva:	
T7	Pieza en T	
T8	Forma en I	
T9:	Tipo de válvula:	
T10	Válvula de retención	
T11:	Artículo accesorio:	
T12	con filtro	
T13	para la limpieza del parabrisas	
T14	para la limpieza de la luneta trasera	
T15:	Modelo de tobera de lavado:	
T16	Tobera simple	
T17	Tobera doble	
T18	Tobera cuádruple	
T19	calentable	
T20:	Tipo de bomba:	
T21	Monobomba	
T22	Bomba dual	
T23:	N° del soporte de bomba:	
T24	Variante de equipamiento	
T25	para número OE	
T26	Adaptador adjunto	
T27:	Número de puertas:	
T28:	Lado de montaje:	
T29	atrás	
T30	Limitación del fabricante	
T31:	Equipamiento del vehículo:	
T32	con aire acondicionado	
T33	con servodirección	
T34	con limpiaventana trasero	
T35	con instalación de lavado para faros	
T36	sin aire acondicionado	
T37	sin limpiaparabrisas trasero	
T38	Los modelos de vehículos se dan como información general. No se deben utilizar como guía detallada de aplicaciones.	



Abbreviation	Description	GB
<b>SWP-M-C</b>	Screen Washer Pump, Mono – Centrifugal Pump	
<b>SWP-M-G</b>	Screen Washer Pump, Mono – Gear-type Pump	
<b>SWP-D-C</b>	Screen Washer Pump, Dual – Centrifugal Pump	
<b>HLWP</b>	Headlight Washer Pump	
<b>N</b>	Nozzle	
<b>N-H</b>	Nozzle, heatable	
<b>FLS</b>	Fluid-level Switch	
<b>C</b>	Connector	
<b>V</b>	Valve	
<b>G</b>	Gasket	
<b>NN</b>	Nozzle Needle	
<b>A</b>	Adapter	
<b>R</b>	Reservoir	
<b>T1:</b>	Operating Voltage:	
<b>T2:</b>	Plug Number:	
<b>T3:</b>	Capacity [Litre]:	
<b>T4:</b>	Operating Model:	
<b>T5</b>	Electric	
<b>T6</b>	Shape:	
<b>T7</b>	T-Piece	
<b>T8</b>	I Form	
<b>T9:</b>	Valve Type:	
<b>T10</b>	Non-return Valve	
<b>T11:</b>	Equipment:	
<b>T12</b>	With filter	
<b>T13</b>	For windscreen cleaning	
<b>T14</b>	For rear windscreen cleaning	
<b>T15:</b>	Design:	
<b>T16</b>	One-hole Nozzle	
<b>T17</b>	Two-hole Nozzle	
<b>T18</b>	Four-hole Nozzle	
<b>T19</b>	Heated	
<b>T20:</b>	Pump Type:	
<b>T21</b>	Mono Pump	
<b>T22</b>	Dual Pump	
<b>T23:</b>	Number of pump holder:	
<b>T24</b>	Equipment variant	
<b>T25</b>	for OE number	
<b>T26</b>	Included adapter	
<b>T27:</b>	Number of doors:	
<b>T28:</b>	Installation side:	
<b>T29</b>	Rear	
<b>T30</b>	Manufacturer restriction	
<b>T31:</b>	Vehicle Equipment:	
<b>T32</b>	with air conditioning	
<b>T33</b>	with power steering	
<b>T34</b>	with rear-window wiper	
<b>T35</b>	with headlamp cleaning system	
<b>T36</b>	without air conditioning	
<b>T37</b>	without rear windscreen wiper	
<b>T38</b>	Vehicle models for general information only. Not to be used as a detailed applications guide.	

Abkürzung	Beschreibung	D
<b>SWP-M-C</b>	Scheiben-Reinigungspumpe, Mono – Zentrifugalpumpe	
<b>SWP-M-G</b>	Scheiben-Reinigungspumpe, Mono – Zahnradpumpe	
<b>SWP-D-C</b>	Scheiben-Reinigungspumpe, Dual – Zentrifugalpumpe	
<b>HLWP</b>	Scheinwerfer-Reinigungspumpe	
<b>N</b>	Düse	
<b>N-H</b>	Düse, heizbar	
<b>FLS</b>	Niveauschalter	
<b>C</b>	Verbindungsstück	
<b>V</b>	Ventil	
<b>G</b>	Dichtung	
<b>NN</b>	Düsennadel	
<b>A</b>	Adapter	
<b>R</b>	Behälter	
<b>T1:</b>	Betriebsspannung [V]:	
<b>T2:</b>	Steckerausführung-ID:	
<b>T3:</b>	Inhalt [Liter]	
<b>T4:</b>	Betriebsart:	
<b>T5</b>	elektrisch	
<b>T6</b>	Bauform	
<b>T7</b>	T-Stück	
<b>T8</b>	I-Form	
<b>T9:</b>	Ventilart:	
<b>T10</b>	Rückschlagventil	
<b>T11:</b>	Ergänzungsartikel:	
<b>T12</b>	mit Filter	
<b>T13</b>	für Frontscheibenreinigung	
<b>T14</b>	für Heckscheibenreinigung	
<b>T15:</b>	Waschdüsenausführung:	
<b>T16</b>	Einfachdüse	
<b>T17</b>	Zweifachdüse	
<b>T18</b>	Vierfachdüse	
<b>T19</b>	beheizt	
<b>T20:</b>	Pumpenart:	
<b>T21</b>	Monopumpe	
<b>T22</b>	Dualpumpe	
<b>T23:</b>	Haltausführungs-ID:	
<b>T24</b>	Ausstattungsvariante	
<b>T25</b>	für OE-Nummer	
<b>T26</b>	beigefügter Adapter	
<b>T27:</b>	Türenanzahl:	
<b>T28:</b>	Einbauseite:	
<b>T29</b>	hinten	
<b>T30</b>	Herstellereinschränkung	
<b>T31:</b>	Fahrzeugausstattung:	
<b>T32</b>	mit Klimaanlage	
<b>T33</b>	mit Servolenkung	
<b>T34</b>	mit Heckscheibenwischer	
<b>T35</b>	mit Scheinwerferreinigungsanlage	
<b>T36</b>	ohne Klimaanlage	
<b>T37</b>	ohne Heckscheibenwischer	
<b>T38</b>	Fahrzeugmodelle dienen nur der allgemeinen Information und nicht als ausführliche Anleitung zur Verwendung der Produkte.	

## Catalogues

- Actuators for Central Locking Systems
- Engine Actuators
- HVAC Blower and Fan Systems
- Sensors for Instrumentation
- Fuel Systems
- Sensors for Engine Management (incl. Oxygen Sensors)

## **TecDoc CATALOG (DVD)** **TecDoc WEB CATALOG**

Electronic Automotive Parts Catalogue  
Information | Order  
TecDoc Informations System GmbH  
Arnikaweg 3  
51109 Cologne  
Germany  
Tel.: +49 (221) 66 00-224  
Fax: +49 (221) 66 00-100  
E-mail: [tecdoc@tecdoc.net](mailto:tecdoc@tecdoc.net)  
Internet: [www.tecdoc.net](http://www.tecdoc.net)



Continental is a certified  
TecDoc partner.

## **Internet**

[www.vdo.com](http://www.vdo.com)

### **Continental Trading GmbH**

Sodener Strasse 9  
65824 Schwalbach  
Deutschland

Tel: +49 6196 87-0

Fax: +49 6196 86571

[www.vdo.de](http://www.vdo.de)

E-Mail: [replacementparts@vdo.com](mailto:replacementparts@vdo.com)

VDO – A Trademark of the Continental Corporation

The information provided in this brochure contains only general descriptions or performance characteristics, which do not always apply as described in case of actual use or which may change as a result of further development of the products. This information is merely a technical description of the product. This information is not meant or intended to be a special guarantee for a particular quality or a particular durability. An obligation to provide the respective characteristics shall only exist if expressly agreed in the terms of contract. We reserve the right to make changes in availability as well as technical changes without prior notice.

A2C59516755 | Continental Trading GmbH © 2013  
Printed in Germany

**Please note:**

**Application** – The products described in this catalogue are designed for use in land vehicles, engines and equipment.

**Disclaimer** – The data in this replacement parts catalogue has been compiled and processed for the purpose of presenting our replacement parts range and is correct to the best of our knowledge. Subject to technical alterations, errors and omissions. Availability is not guaranteed. We cannot be held liable with regard to any information contained in the Continental Trading replacement parts catalogue except in case of intent, gross negligence or where mandatory liability is borne in accordance with German product liability law.

The logo consists of the letters 'VDO' in a bold, blue, sans-serif font. The 'V' and 'D' are connected at the top, and the 'O' is a simple circle.